

Universal Digital Preamp Equalizer

ENGLISH

PREMIER

Owner's Manual

DEQ-P9

Pioneer

Dear Customer	3	Audio Adjustment	13
Key Finder	4	Audio Menu	13
Head Unit (DEX-P9)	4	● Switching to the Audio Menu	
Remote Controller (DEX-P9)	4	Audio Adjustment <Main>	15
Opening and Closing		Main Menu	15
the Remote Controller Cover	5	● Switching to the Main Menu	
● When the Cover is Closed		Fader/Balance Adjustment	15
● When the Cover is Open		Bass/Treble Adjustment	16
Before Using This Product	7	Adjusting the Listening Position	17
About This Product	7	● Using the Position Selector	
About This Manual	7	● Fine Tuning the Position	
Important	8	● Effective distance Adjustment	
About the Digital Network	8	Using the Position Fine Tuning function	
MODE Switch Setting	9	Source Level Adjustment	21
Resetting the Microprocessor	10	Audio Adjustment <Equalizer>	22
Precaution	11	Equalizer menu	22
After-sales Service for Pioneer Products	12	● Switching to the Equalizer Menu	
		Relation Between Frequency Characteristics	
		and Sound Quality	23
		Adjusting the 31 Band Graphic Equalizer	25
		The Flat function	26

Audio Adjustment <Network>	27
What is the Multi-Amp System?	27
Network Menu	28
● Switching to the Network Menu	
Time Alignment Adjustment	29
● Switching to the Time Alignment Adjustment Mode	
● Measuring the Distance to be Corrected	
● Inputting the Distance to be Corrected	
Filter Adjustment	33
● Switching to the Filter Adjustment Mode	
● Using the Mute function	
● Adjusting the Filter	
 Audio Adjustment	
<Memory Functions>	38
Memory Functions of	
Adjusted Audio Menu	38
Switching to Memory Mode	39
● Equalizer Menu	
● Network Menu	
Storing the Adjustment Data in Memory	40
Recalling Data Stored in Memory	41
● Recalling Memory Using Forward/Reverse Order — Functions of Equalizer Menu —	
● Specifying the Memory Number Directly	
Memory Protect function	43
Memory Clearing Operations	44

Display for the Person who Set Up the Audio Adjustments	45
Inputting the Name	45
Inputting Characters	45
 Memory Data Memo	48
 Connecting the Units	51
Routing the Optical Cable	52
Setting Example	52
Connection Diagram	53
Connecting the RCA Input Amplifier	54
Connecting the Power Terminal	55
Connecting the IP-BUS and Optical Cable	56
● Connecting the Cables	
 Installation	57
Installing the Unit	57
 Troubleshooting	58
Checklist	58
 Specifications	59



Dear Customer:

Selecting fine audio equipment such as the unit you’ve just purchased is only the start of your musical enjoyment. Now it’s time to consider how you can maximize the fun and excitement your equipment offers. This manufacturer and the Electronic Industries Association’s Consumer Electronics Group want you to get the most out of your equipment by playing it at a safe level. One that lets the sound come through loud and clear without annoying blaring or distortion—and, most importantly, without affecting your sensitive hearing.

Sound can be deceiving. Over time your hearing “comfort level” adapts to higher volumes of sound. So what sounds “normal” can actually be loud and harmful to your hearing. Guard against this by setting your equipment at a safe level BEFORE your hearing adapts.

To establish a safe level:

- Start your volume control at a low setting.
- Slowly increase the sound until you can hear it comfortably and clearly, and without distortion.

Once you have established a comfortable sound level:

- Set the dial and leave it there.

Taking a minute to do this now will help to prevent hearing damage or loss in the future. After all, we want you listening for a lifetime.

We Want You Listening For A Lifetime

Used wisely, your new sound equipment will provide a lifetime of fun and enjoyment. Since hearing damage from loud noise is often undetectable until it is too late, this manufacturer and the Electronic Industries Association’s Consumer Electronics Group recommend you avoid prolonged exposure to excessive noise. This list of sound levels is included for your protection.

Decibel

Level	Example
30	Quiet library, soft whispers
40	Living room, refrigerator, bedroom away from traffic
50	Light traffic, normal conversation, quiet office
60	Air conditioner at 20 feet, sewing machine
70	Vacuum cleaner, hair dryer, noisy restaurant
80	Average city traffic, garbage disposals, alarm clock at two feet.

THE FOLLOWING NOISES CAN BE DANGEROUS UNDER CONSTANT EXPOSURE

90	Subway, motorcycle, truck traffic, lawn mower
100	Garbage truck, chain saw, pneumatic drill
120	Rock band concert in front of speakers, thunderclap
140	Gunshot blast, jet plane
180	Rocket launching pad

Information courtesy of the Deafness Research Foundation.



Head Unit (DEX-P9)

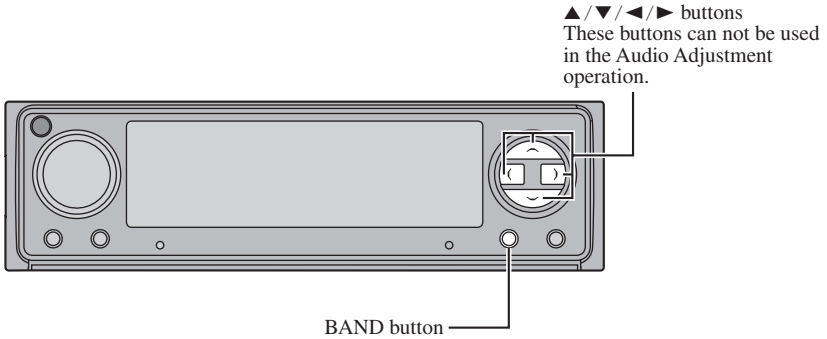

Remote Controller (DEX-P9)

This unit can be operated with the combined Head Unit DEX-P9 (sold separately). Opening the cover enables the SHIFT, RETURN and FUNCTION buttons 1-6 inside this unit. For more details, refer to the page 5.

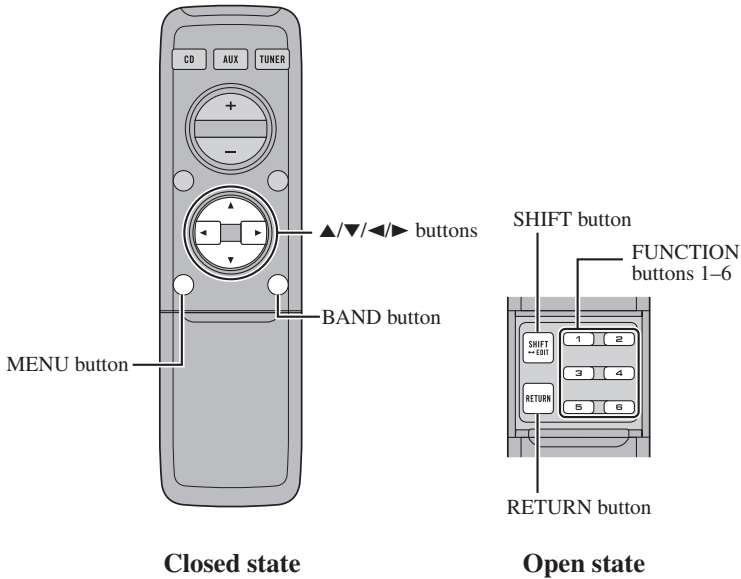

Opening and Closing the Remote Controller Cover

When the remote controller is opening the cover enables the SHIFT, RETURN and FUNCTION buttons 1–6 inside the unit.

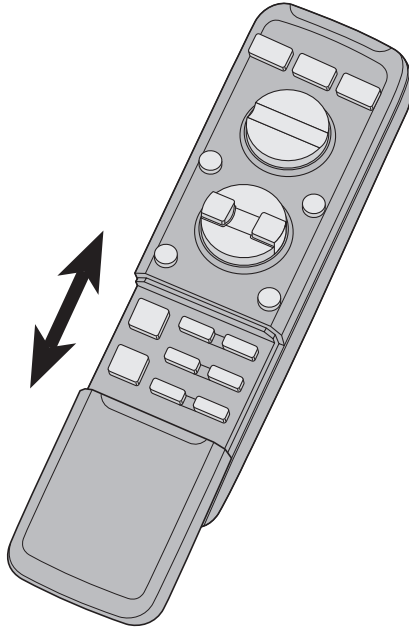

Menu displays with cover open and closed in this system, the available functions and the menu display vary depending on the condition of the remote controller in use.

Remote Controller	Menu display
Cover closed	Closed state
Cover open	Open State

When the Cover is Closed

Closing the cover of the remote controller makes the menu display to the closed state.

Menu display in closed state

Example: Main Menu Screen

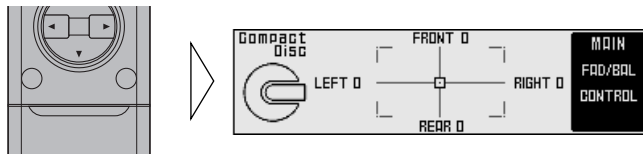

Note:

- Menu display in closed state: Current mode and functions which are ON are displayed.

When the Cover is Open

Opening the cover of the remote controller makes the menu display to the open state.

Menu display in open state

Example: Main Menu Setting Screen

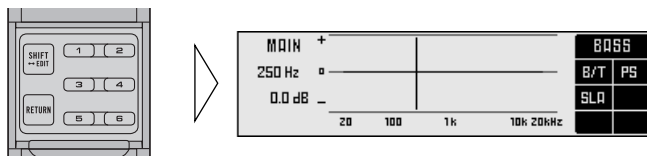

Note:

- Positions of menu items on the display correspond to the positions of FUNCTION buttons 1–6.
- Menu display in open state: Using FUNCTION buttons 1–6, operable functions are displayed.

When the cover is closed in the middle of operation

- Closing the cover during operation releases the previous operation and returns the menu display to the closed mode.

About This Product

This product is universal digital preamp equalizer which can be operated with the combined head unit DEX-P9 (sold separately). You can operate a number of Audio Adjustment functions with separately sold head unit.

About This Manual

This product features a number of sophisticated functions ensuring superior reception and operation. All are designed for the easiest possible use, but many are not self-explanatory. This operation manual is intended to help you benefit fully from their potential and to maximize your listening enjoyment.

We recommend that you familiarize yourself with the functions and their operation by reading through the manual before you begin using this product. It is especially important that you read and observe the “Precaution” on page 11 and in other sections.

This manual mainly explains the remote controller operation. In some functions, you can perform the same operations with the head unit, however, the remote controller offers a number of buttons such as SHIFT, MENU, RETURN and FUNCTION buttons 1–6 which are not provided on the head unit. And all of audio adjustment operations can only be conducted with the remote controller.

Important

The serial number of this device is located on the bottom of this product. For your own security and convenience, be sure to record this number on the enclosed warranty card.

About the Digital Network

A vehicle, unlike the home audio, imposes several constraints upon the quality of reproduced sound, and have the following effects:

- Reflected sounds have strong effects on direct sounds because of the confined space and complex shape within a vehicle. This disturbs frequency characteristics and significantly reduces sound quality.
- The orientation of the sound image becomes unnatural, because speakers may not be installed symmetrically to left and right of the listener, or because speakers are installed in both the front and rear.

This system is equipped with a wide variety of functions that use DSP to create the ideal sound quality and sound image in a vehicle and overcome these constraints on reverberation.

MODE Switch Setting

This product equipped two setting modes. The one is LR/IND mode and the other is LR/COM mode. LR/IND mode can be adjusted the equalizer and network adjustment independently between Left and Right channel. LR/COM mode can be adjusted these adjustment simultaneously between Left and Right channel. Since usable functions are different between LR/IND and LR/COM, be sure to set the mode correctly.

- **Set MODE switch of this product to appropriate position with a pen tip or other pointed instrument.**

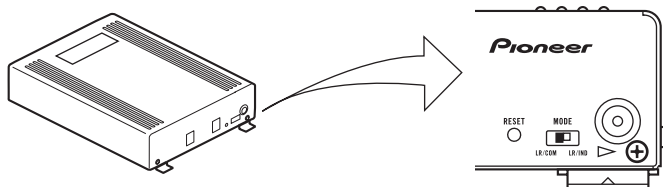

Resetting the Microprocessor

The microprocessor must be reset under the following conditions:

When using this product for the first time after installation.

When the machine fails to operate properly.

When strange (incorrect) messages appear on the display.

When setting the position of the MODE switch of this product.

- **To reset the microprocessor, press the RESET button on this unit with a pen tip or other pointed instrument.**

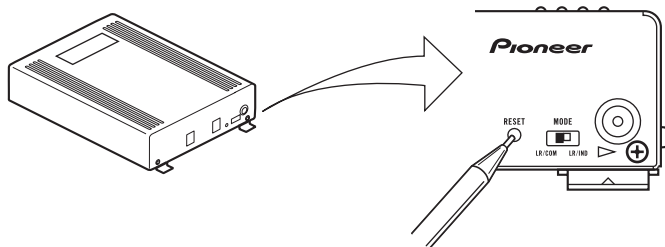

Precaution

CAUTION: USE OF CONTROL OR ADJUSTMENT OR PERFORMANCE OF PROCEDURES OTHER THAN THOSE SPECIFIED HEREIN MAY RESULT IN HAZARDOUS RADIATION EXPOSURE.

CAUTION: THE USE OF OPTICAL INSTRUMENTS WITH THIS PRODUCT WILL INCREASE EYE HAZARD.

- Keep this manual handy as a reference for operating procedures and precautions.
- Always keep the volume low enough for outside sounds to be audible.
- Protect the product from moisture.
- If the battery is disconnected, the preset memory will be erased and must be reprogrammed.

After-sales Service for Pioneer Products

Please contact the dealer or distributor from where you purchased the product for its after-sales service (including warranty conditions) or any other information. In case the necessary information is not available, please contact the companies listed below:

Please do not ship your product to the companies at the addresses listed below for repair without advance contact.

■ U.S.A.

Pioneer Electronics Service, Inc.
CUSTOMER SERVICE
DEPARTMENT
P.O. Box 1760
Long Beach, CA 90801
800-421-1404

■ CANADA

Pioneer Electronics of Canada, Inc.
CUSTOMER SATISFACTION DEPARTMENT
300 Allstate Parkway
Markham, Ontario L3R OP2
(905) 479-4411
1-877-283-5901

For warranty information please see the Limited Warranty sheet included with your product.

Audio Menu

This system has the following three Audio Menus:

Main <Main> (page 15)

This carries out Fader/Balance Adjustments as well as Bass/Treble Adjustment, the basis for sound quality adjustments. It also sets up and adjusts the Position Selector, which corrects the orientation of the sound image for the listener's position in the vehicle.

Equalizer <Equalizer> (page 22)

This corrects complex frequency disturbance in a vehicle.

The Equalizer function for the component can make fine adjustments of sound quality for each frequency.

Network <Network> (page 27)

This adjusts the reproduced frequency band (cross-over frequency) and the level of each sound range (band) when a multi-amp system is set up. It also corrects unnatural orientation of the sound image caused by the locations of the speakers (using the Time Alignment function), by setting up a delay (time difference) between speakers set up for different sound ranges.

Note:

- The ▲/▼/◀/▶ buttons on the head unit (DEX-P9) can not be used for Audio Adjustment operations.

Switching to the Audio Menu

When the system is ON, you can adjust the sound quality.

1. Each press of MENU button selects the desired Audio Menu in the following order:

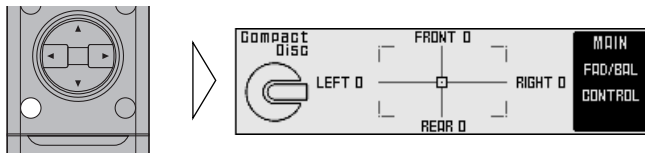

Main (Main Menu) → Equalizer (Equalizer Menu) → Network (Network Menu)

2. Operate the mode.

3. Press the BAND button and cancel the Audio Menu.

Cancel the Audio Menu to return to the operations screen of the source currently in use.



Main Menu <MAIN>

With this menu, you can make the following four adjustments.

- Fader/Balance Adjustment <FAD/BAL CONTROL> (Closed state)
- Bass/Treble Adjustment <B/T> (Open state)
- Listening Position Adjustment <PS> (Open state)
- Source Level Adjustment <SLA> (Open state)

Switching to the Main Menu

- Press the MENU button and select the Main Menu (refer to page 14).

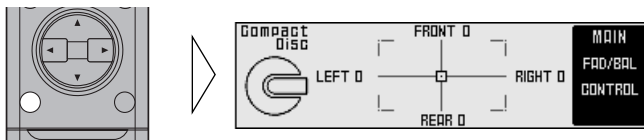

After the title screen, the display switches to the operation screen of the Main Menu. Opening and closing the cover of the remote controller (refer to page 5) switches between the open and closed states of the menu display and setting screen.

- To cancel the Main Menu, press the BAND button.

Fader/Balance Adjustment <FAD/BAL CONTROL> (Closed state)

This function allows you to select a fader/balance setting that provides ideal listening conditions in all occupied seats. This function can be operated with the remote controller cover closed.

1. Close the cover of the remote controller (refer to page 5).
2. Adjust front/rear speaker balance with the ▲/▼ buttons.

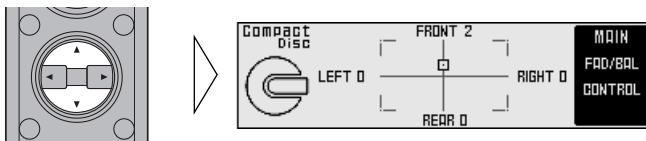

Note:

- In the front-speaker-oriented system, if the fader is set to rear, whole sound level is attenuated.

3. Adjust left/right speaker balance with the ◀▶ buttons.

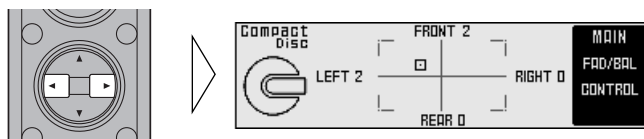

Bass/Treble Adjustment <B/T> (Open state)

It is possible to select one from a choice of four frequencies to become the reference when adjusting the bass/treble tone. The frequencies and level adjustment ranges from which selections may be made are as follows:

Bass : 63 Hz, 100 Hz, 160 Hz, 250 Hz

Treble: 4 kHz, 6.3 kHz, 10 kHz, 16 kHz

Level adjustment range: -12 dB — +12 dB (1 dB/1 step)

1. Open the cover of the remote controller (refer to page 5).

This switches to Main Menu Setting Screen.



2. Press the FUNCTION button 1.

The display switches to Bass/Treble Adjustment Screen.

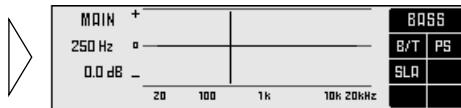
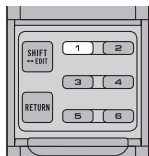

3. Press the FUNCTION button 1 again to choose bass (BASS) or treble (TREB).

Pressing the button switches bass/treble.

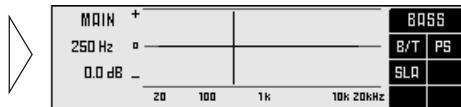

4. Press the ◀/▶ buttons and select a frequency point.

Tune to the desired frequency point.

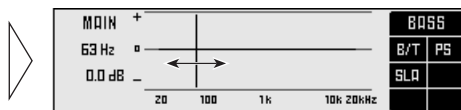

5. Press the ▲/▼ buttons and adjust the level.

Holding down these buttons continues their operations (with one stop at the central position).

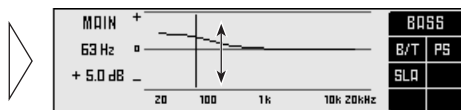

Note:

- Raising the Bass/Treble level too high may result in distortion.
Perform Bass/Treble Adjustment to adjust overall sound quality.

Adjusting the Listening Position <PS> (Open state)

One way to assure a more natural sound is to clearly position the stereo sound image (putting you in the center of the sound field).

The Position Selector function adjusts distance and volume level of sound from each speaker to match seat positions and the number of people in the car, and lets you recall settings at the touch of a button. The result is a natural sound regardless of the seat you are sitting in.

Button	Position
▲	FRONT (Front Seat Left & Right)
◀	FRONT-L (Front Seat Left)
▶	FRONT-R (Front Seat Right)

Using the Position Selector <PSI>

1. Open the cover of the remote controller in the Main Menu (refer to page 5).

This switches to Main Menu Setting Screen.

2. Press the **FUNCTION** button 2.

The display switches to Position Selector Screen.

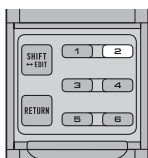

3. Press the **FUNCTION** button 2 again to turn the Position Selector function ON.

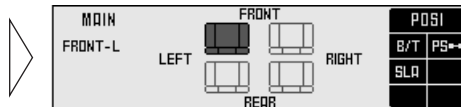

4. Press one of buttons ◀/▶/▲ and select the desired position.

Set up the position to match the position of the listener in the car.

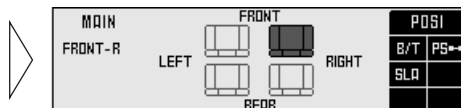

Experimenting with other positions

- The position is normally designed to match the listener's position in the car. However, other positions may prove to be more effective, depending on the model of the car and the location of the speakers. Compare the sound and choose the position in which the sounds are most natural.

Fine Tuning the Position

After choosing the position using the Position Selector function, it is possible to fine tune the distance and the difference in sound levels. Conduct the fine tuning to match the location of the left and right speakers and the shape of the car and correct the position of the sound image so that the sounds are most natural.

Distance (DIS): 0 — 134 in. (0.67 in./1 step)

The longer the distance, the longer the sounds coming from the speaker take to reach the ears of the listener, giving the listener the feeling that the speaker is moving further away. The sound image thus moves in the direction in which the value for the distance is closer to 0.

Adjustment range in the difference in sound levels (LEV): 0 — -30 dB (1dB/1step)

The smaller the level, the lower the sound volume output from the speaker, giving the listener the feeling that the speaker is moving further away. The sound image thus moves in the direction in which the value for the difference in sound levels is closer to 0.

Relationship between the distance and the delay time

It is necessary to adjust the delay time, irrespective of the distance between the listening position and each speaker unit, for better sound quality.

With this system, when you adjust the distance, the corresponding delay time is conducted automatically. It means that you can adjust the time alignment without calculating.

Note:

- Fine tuning can be conducted separately for each position.
- The values set after fine tuning are stored into memory as the values for the position. When the position is next called up, the fine tuning values are recalled.

1. Use the Position Selector function and select the position (refer to page 17).

Example: When selecting FRONT-L

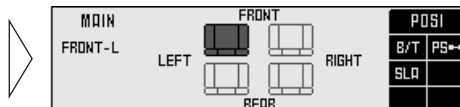

2. Press the FUNCTION button 2 for two seconds and switch to Position Fine Tuning Screen.

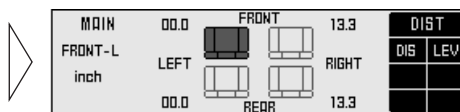

3. Press FUNCTION buttons 1 or 2 and select the distance (DIS) adjustment or difference in sound levels (LEV) adjustment.

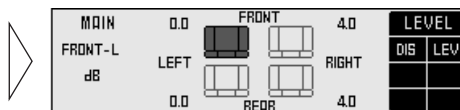

Continued overleaf.

4. Press the ◀▶ buttons to correct the position of the sound image.

Holding down these buttons continues their operations (during distance tuning, holding down the button moves the distance 1.34 in./1 step).

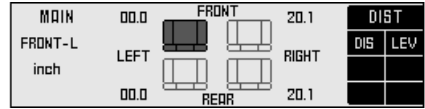

5. After tuning has been completed, press the RETURN button to cancel the Position Fine Tuning Screen.

The values are stored in memory and the display returns to Position Selector Screen.

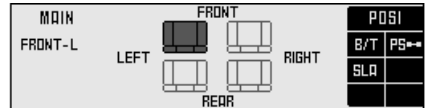
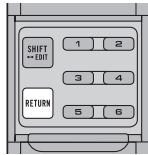

Points concerning fine tuning

- While listening to vocals, adjust the distance to position the vocal sound image naturally to the front.

Effective distance Adjustment Using the Position Fine Tuning function

— Relation to Time Alignment Adjustment function —

When the system comprises a multi-amp system, the distance between the listening position and each speaker can be tuned using either of two methods.

Time Alignment Adjustment function of the Network Menu (page 29)

The distance between the listening position and each speaker of each band (high, mid, low and subwoofer) can be adjusted for the left and right speakers.

Distance tuning of the Position Fine Tuning function

The distance between the listening position and the left and right speakers can be tuned, regardless of the band. The same tuning is conducted for high, mid and low range bands. With a multi-amp system, combine the two methods to ensure the position of the sound images are set up more effectively.

- 1. Adjust the distance from each speaker using the Time Alignment Adjustment function of the Network Menu (refer to page 29).**
- 2. Adjust the overall distance from the left and right speakers using the Position Fine Tuning Function.**

Use the set values for the Time Alignment Adjustment function to fine tune the overall balance of the sound image positions.

- 3. Use the Position Fine Tuning Function to adjust the overall level balance between the left and right speakers.**

Adjust the difference in sound levels between the left and right speakers so that the sound image is in the front.

Adjusting distance using the Position Fine Tuning function

- When the display has switched to Time Alignment Adjustment Screen after adjusting the distance between the listening position and each speaker using the Position Fine Tuning function, the values set using the Position Fine Tuning function will be added to the values created using the Time Alignment Adjustment function and the sum of the values displayed.
- To store the displayed values in memory as new values for the Time Alignment Adjustment function (standard values for the Position Fine Tuning function), adjust any one value again, using the ▲/▼ buttons. The displayed values will be stored in memory and the distance between the listening position and each speaker set using the Position Fine Tuning function will be reset and returned to 0.

When the distance has been using the Time Alignment Adjustment function

- The distance adjustment of the Position Fine Tuning function uses the distance adjustment of the Time Alignment Adjustment function as its basis. If the distance is reset using the Time Alignment Adjustment function, this standard value is changed. When this happens, any distance adjustment previously set using the Position Fine Tuning function is reset to 0.

Source Level Adjustment <SLA> (Open state)

The SLA (Source Level Adjustment) function prevents radical leaps in volume level when switching between sources. Settings are based on the FM volume level, which remains unchanged.

1. Compare the FM volume with the volume of the other source (refer to DEX-P9 (sold separately) Owner's Manual).
2. Press the MENU button to switch to the Main Menu.
3. Open the cover of the remote controller switches to Main Menu Setting Screen.

4. Press Function button 3 on MAIN Menu Setting Screen.

The display switches to SLA Adjustment Screen.

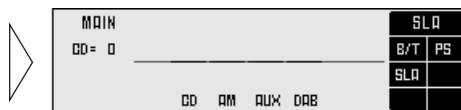

5. Increase or decrease the level with the ▲/▼ buttons.

The display shows “+4” — “-4”.

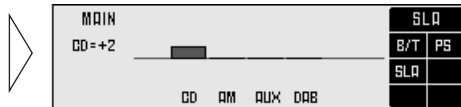

Note:

- Since the FM volume is the control, SLA is not possible in the FM modes.
- The AM volume level, which is different from the FM base setting volume level, can also be adjusted similar to sources other than tuner.
- The head unit's CD player, Multi-CD player and DVD player are set to the same volume adjustment setting automatically.
- AUX, External 1 and External 2 are set to the same volume adjustment setting automatically.

Equalizer Menu <GEO>

With this menu, you can make the following four adjustments.

- Recalling the Equalizer Curve (Closed state) (Refer to page 41.)
- Adjusting the 31 Band Graphic Equalizer <FINE> (Open state)
- Flat function <FLT> (Open state)
- Memory functions of Adjusted Equalizer Curves (Open state) (Refer to page 39.)

Switching to the Equalizer Menu

- Press the MENU button and select the Equalizer Menu (refer to page 14).

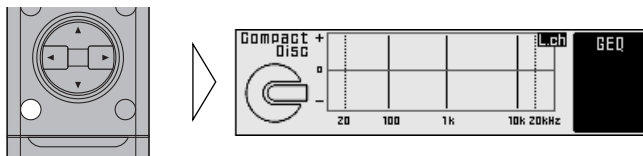

After the title screen, the display switches to the operation screen of the Equalizer Menu. Opening and closing the cover of the remote controller (refer to page 5) switches between the open and closed states of the menu display and setting screen.

- To cancel the Equalizer Menu, press the BAND button.

Relation Between Frequency Characteristics and Sound Quality

Sound quality generally has the following characteristics, depending on the frequency. Refer to these characteristics when making adjustments.

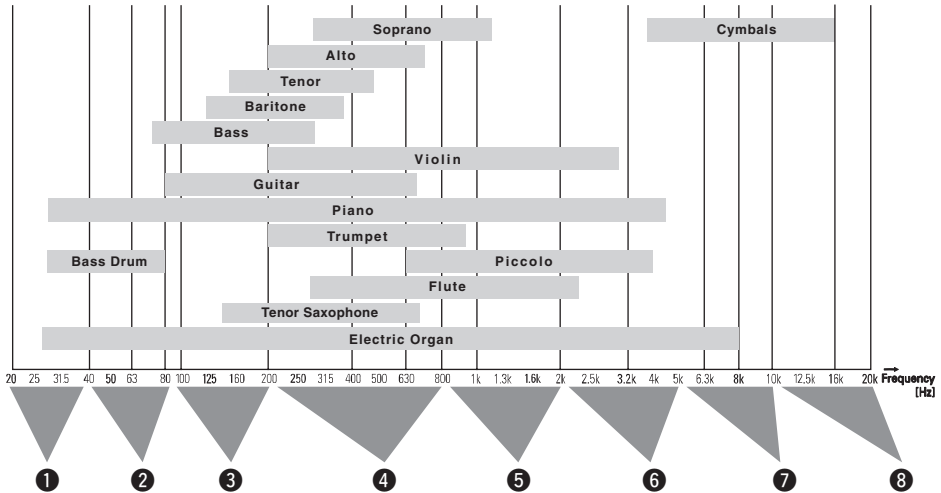

- ① This sound range feels almost like pressure on the ears of the listener, particularly if the sound is too strong.
- ② In this range, the listener feels the heavy bass. This is also the range in which the impact of the sound is felt in the body. Excessive sound in this range will impair the clarity of the overall sound.
- ③ The sound range required for bass. A lack of sound in this range results in a weak bass impact, while excessive sound will muffle the overall sound. A clear reproduction lends depth to the overall sound.
- ④ This is the sound range in which the sound signals are most dense and where the sound outline is created. A lack of sound in this range results in a lack of warmth. Excessive sound dims clarity.
- ⑤ The sound range required for the core of the sound. A lack of sound in this range weakens the core. An important range for keeping the overall sound quality in balance.
- ⑥ In this range, the sharp, expansive sounds of the brass and electric guitar are felt. However, excessive sound in this range is tiring on the ears.
- ⑦ This sound range adds color and gaiety to the overall sound. A lack in sound in this range will result in a muffled overall sound, while excessive sound will enhance the metallic aspects.
- ⑧ This range is required for the glamorous sound of the cymbals. However, this range does not contain the basic frequencies of almost all the instruments. Therefore, if the sound in this range is lacking somewhat, the overall sound quality will not deteriorate markedly.

The points when adjusting the equalizer curve

- Take the recreated frequency bands of the speakers into consideration when adjusting. For example, when a speaker with a band between 80 Hz and 4 kHz is connected, adjusting the level in 50 Hz or 10 kHz will have no effect.
- Balancing the bass and treble is recommended. The bass tends to be lacking when no subwoofer is connected. Adjust the treble to a lower volume to match the weaker bass and create a well-balanced sound.
- Noises coming from the road make the bass seem weak while driving. If the level is below 100 Hz, adjust to a slightly greater level to maintain superb sound balance while driving.
- When the sound is inadequate or excessive, it is recommended to set the levels after checking the frequencies of the sounds in question by changing the peripheral frequencies to the maximum or minimum.

Adjusting the 31 Band Graphic Equalizer <FINE> (Open state)

Adjustable frequency : 20 Hz — 20 kHz (Every 1/3 octaves, total 31 bands)
 Level adjustment range: -12 dB — +12 dB (0.5 dB/1 step)

1. **Open the cover of the remote controller in the Equalizer Menu (refer to page 5).**

This switches to Equalizer Menu Setting Screen.



2. **Press the FUNCTION button 2 and select left or right channel. (Only for LR/IND mode.)**

Each press the FUNCTION button 2 switches left and right channel.



Note:

- If you selected LR/COM mode (refer to page 9), you can't switch between left and right channel. In this case, <FRT> is displayed and the equalizer setting of left and right channel go to the same.

3. **Press the <◀/▶> buttons and select the desired band (frequency) to be adjusted.**

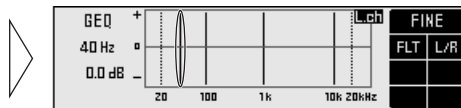

4. **Press the ▲/▼ buttons and adjust the level.**

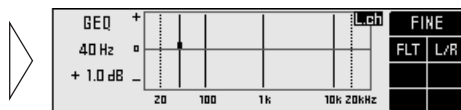

5. **Adjust the other bands.**

Repeat steps 3 and 4 to adjust to the desired sound.

6. **Switch between right and left to set up the equalizer curve.**

Repeat steps 2–5 to set up equalizer curves for the left and right speakers separately.

When completing the adjustment

- It is recommended that adjustment settings be stored in memory soon after the adjustments are completed. Refer to page 38 for Memory operations.

The Flat function <FLT> (Open state)

The adjusted equalizer curve can be temporarily returned to its prior status before making the adjustment (all levels are 0 dB), using the Flat function.

This is convenient for checking the effects of the adjusted equalizer curve.

1. Open the cover of the remote controller in the Equalizer Menu (refer to page 5).

This switches to Equalizer Menu Setting Screen.

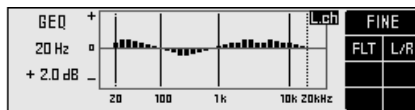

2. Press the FUNCTION button 1 switches the Flat function ON/OFF.

“FLT” is displayed when the Flat function is ON.

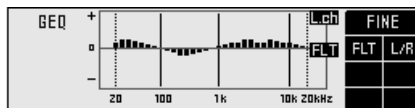

Note:

- When the Flat function is ON, the Equalizer Adjustment or Memory operations of the Equalizer curve can not be conducted.

What is the Multi-Amp System?

The multi-speaker system reproduces each frequency band (high, mid, low and ultrabass-ranges) through its own exclusive speaker unit. The multi-amp system provides an exclusive power amplifier for each speaker unit.

There is only limited space in a vehicle for installing speakers, and it is difficult to install large-diameter speakers in a door or on the dashboard and get high sound quality. To overcome this problem, tweeters (high-range) are sometimes installed in the dashboard in order to move the sound image upwards, or the subwoofers are installed in the rear tray in order to improve bass and ultrabass reproduction. Thus, using a multi-speaker system can correct imbalances in the sound image and significantly improve the total sound quality.

The multi-amp system offers the following features, allowing direct operation of the exclusive speaker unit for each frequency range by an exclusive power amplifier.

- It is possible to reduce the modulation distortion rate since high-range signals are not effected by strong signals in the low range.
- As it is possible to select amplifiers and speakers to suit the characteristics of each frequency range, the load on each unit is reduced, ensuring optimum performance.

Under the multi-amp system, it is necessary to divide the audio signals into each frequency range (band) and strictly control the set up conditions, using the network.

Under this system, the audio unit incorporates a network. The following adjustments can be conducted within the vehicle.

- Time Alignment Adjustment function : adjusts for the difference in the distance between the listener and each speaker unit.
- Filter function : sets up a low pass filter and high pass filter to decide the reproduced frequency band, the level and the phase of each speaker unit.

As the audio signals are processed in the form of digital signals when the network is working, the sound characteristics that best fit the vehicle interior may be created without any deterioration in sound quality.

Network Menu <N.W.>

With this menu, you can make the following three adjustments.

- Time Alignment Adjustment <T.A.> (Open state)
- Filter Adjustment <FTR> (Open state)
- Memory functions of Adjusted Network (Open state) (Refer to page 38.)

Switching to the Network Menu

- Press the MENU button and select the Network Menu (refer to page 14).

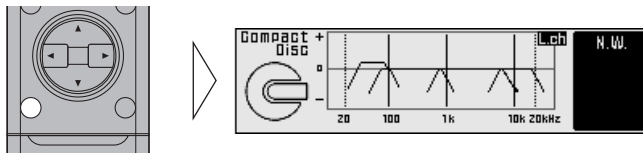

After the title screen, the display switches to the operation screen of the Network Menu. Opening and closing the cover of the remote controller (refer to page 5) switches between the open and closed states of the menu display and setting screen.

- To cancel the Network Menu, press the BAND button.

If adjustments are difficult

- Adjusting the Network requires technical skills and knowledge of the amplifiers and speakers installed in the system. Consult your dealer from which the products were purchased if adjustments are difficult.
- When adjustments have already been made at your dealer, the optimum setup for vehicle's particular interior has already been installed in the memory. In this case, recall the corresponding memory for use (refer to page 41).

When completing the adjustment

- It is recommended that adjustment settings be stored in memory soon after the adjustments are completed. Refer to page 38 for Memory operations.
- After completing the network adjustments, adjust the overall balance of the sound image by using the Position Fine Tuning function of the Main Menu as necessary (refer to page 18).

Time Alignment Adjustment <T.A.> (Open state)

In the vehicle, the different speaker units are at widely differing distances from the listener. The sounds from the speakers therefore reach the listener at different times. When a multi-amp system is set up, this causes different delays for each frequency band (high, mid, low and ultrabass-ranges), marring the position of the sound image and the overall balance and disturbing the frequency characteristics.

The Time Alignment Adjustment function is able to synchronize the arrival times of the different sounds by delaying the output of signals from the closest speaker units.

Switching to the Time Alignment Adjustment Mode

1. **Open the cover of the remote controller in the Network Menu (refer to page 5).**

This switches to Network Menu Setting Screen.

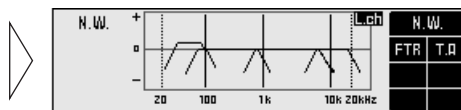

2. **Press the FUNCTION button 2.**

The display switches to Time Alignment Adjustment Screen, allowing time alignment adjustment.

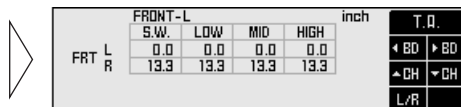
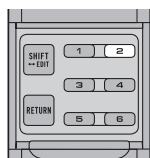

Measuring the Distance to be Corrected (Delay Time)

It is necessary to calculate the delay time to correct the time differences between speaker units. In order to adjust the Time Alignment Adjustment function more easily, this System allows the delay time to be set up by simply inputting the difference in the distance between speaker units (the distance to be corrected). (The delay time will be automatically calculated by this system.)

Although the distance from each speaker unit varies depending on the position of the listener, the first set up is made for the driver's seat. If the set up has been made for the driver's seat, the optimum delay time for the listener's position can be set up by simply switching the Position Selector function (refer to page 17) to the listening position. (This System automatically calculates and sets up the optimum delay time for each position.)

Example: making corrections for the driver's seat in a left-hand drive vehicle

- Measure the distance between the head of the listener, when sitting in the driver's seat, and each speaker unit.

Note:

- The unit of distance must be inches.

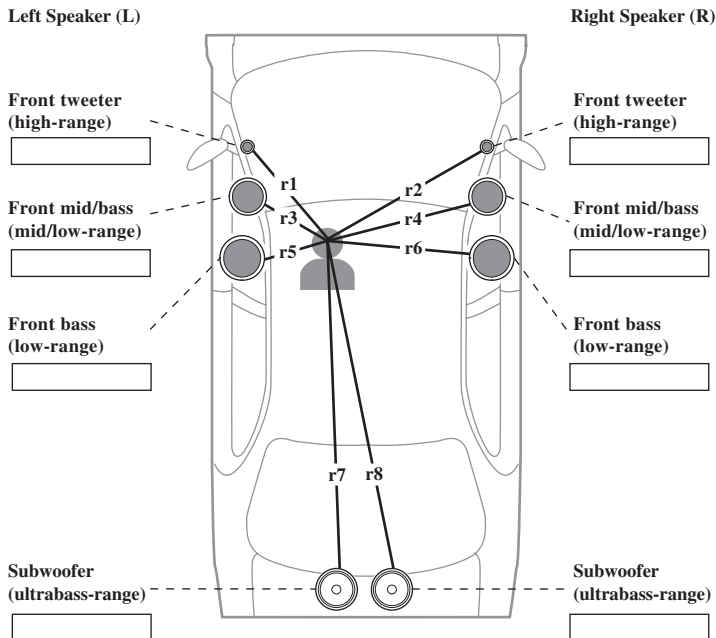

Note:

- It is recommended that the boxes be filled in as the measurements are made, as this information may prove useful at a later date.
- Measure the distances to be corrected in the same manner for other systems than those used in the above example.

Inputting the Distance to be Corrected (Delay Time)

Scope of adjustment: 0 — 134 in. (0.67 in./1 step)

1. **Open the cover of the remote controller in the Network Menu (refer to page 5).**

This switches to Network Menu Setting Screen.

2. **Press the FUNCTION button 2.**

The display switches to Time Alignment Adjustment Screen, allowing time alignment adjustment.

3. **Press the FUNCTION button 5 and select the driver's seat (position).**

Press the buttons to switch between "FRONT-R" and "FRONT-L". Select the position when measuring the distance to be corrected as shown on the page 30.



(FRONT-L)					inch	T. Q.	
		S.W.	LOW	MID	HIGH		
FRT	L	0.0	0.0	0.0	0.0	← BD	▶ BD
	R	13.3	13.3	13.3	13.3	▲ CH	▼ CH
						L/R	

Note:

- The correct distance can not be input unless these operations are conducted.

4. **Press FUNCTION buttons 3 or 4 and select the speaker channel to input.**

Press the buttons to switch between left (LEFT) and right (RIGHT).



FRONT-L					inch	T. Q.	
		S.W.	LOW	MID	HIGH		
FRT	L	0.0	0.0	0.0	0.0	← BD	▶ BD
	R	13.3	13.3	13.3	13.3	▲ CH	▼ CH
						L/R	

5. **Press FUNCTION buttons 1 or 2 and select the band to input.**

Each press of the FUNCTION buttons 1 or 2 select the desired band in the following order:



FRONT-L					inch	T. Q.	
		S.W.	LOW	MID	HIGH		
FRT	L	0.0	0.0	0.0	0.0	← BD	▶ BD
	R	13.3	13.3	13.3	13.3	▲ CH	▼ CH
						L/R	

S.W. (ultrabass-range) ↔ LOW (low-range) ↔ MID (mid-range) ↔ HIGH (high-range)

6. Press the ▲/▼ buttons to input the distance to be corrected (delay time).

Input the distance to be corrected, as measured on page 30.

Holding down these buttons continues their operations (during distance tuning, holding down the button moves the distance 1.34 in./1 step).



FRONT-L				inch	T.D.
S.W.	LOW	MID	HIGH		← BD ▶ BD
0.0	0.0	0.0	0.0		▲ DH ▼ DH
13.3	20.1	13.3	13.3		L/R

7. Carry out time alignment adjustments for the other speaker units.

Repeat steps 4 – 6 to input the distance to be corrected for each speaker unit.

Note:

- Some systems may indicate values for speaker units which are not connected. Verify the composition of the system in order to correctly adjust the bands for the connected speaker units.

Filter Adjustment <FTR> (Open state)

The following adjustments can be made during filter adjustments. Make the appropriate adjustments for the reproduced frequency band and characteristics of the connected speaker unit.

Filter frequency adjustment: Every 1/3 octave

Level adjustment: 0.5 dB/1 step

The cut-off frequencies of the high pass filter (H.P.F.) and the low pass filter (L.P.F.) of each band (subwoofer, low, mid, high) and the reproduction level of each band are set up.

Range	Cut-off frequency of H.P.F.	Cut-off frequency of L.P.F.	Level adjustment range
Subwoofer-range	20 Hz — 100 Hz	25 Hz — 250 Hz	-24 — +10 dB
Low-range	25 Hz — 250 Hz	250 Hz — 10 kHz	-24 — 0 dB
Mid-range	200 Hz — 10 kHz	2 kHz — 20 kHz	-24 — 0 dB
High-range	1.6 kHz — 20 kHz	8 kHz — 20 kHz	-24 — 0 dB

Slope adjustment: PASS, -6 dB/oct. — -36 dB/oct. (Every -6 dB/oct., total of 6 steps)

The slope (inclination of attenuation of filter characteristics) of H.P.F. and L.P.F. is set up.

Note:

- When the slope is set as PASS, the audio signals bypass the filter circuit, cutting out the effect of the filter circuit.
- In order to protect the speaker unit, H.P.F. has no PASS set up for high ranges.
- In order to protect the speaker unit, H.P.F. has no PASS set up for mid-range, however you can set to PASS by changing the settings (refer to page 36, step 8).

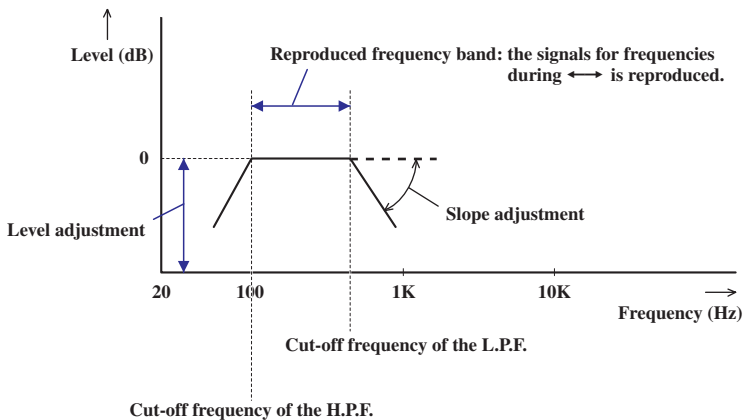

About the H.P.F. and L.P.F.

High pass filter eliminates lower sound ranges (low-range) from the set up frequencies and allows high ranges through.

Low pass filter eliminates upper sound ranges (high-range) from the set up frequencies and allows low ranges through.

About the slope

This value indicates how many dB the signals attenuate when the frequency increases (or decreases) 1 octave (unit: dB/oct.). Increasing the degree of the slope increases the degree of signal attenuation.

Note:

- Setting the slope of H.P.F. and L.P.F. of the low-range as PASS creates a full range setup.

Switching to the Filter Adjustment Mode

1. Open the cover of the remote controller in the Network Menu (refer to page 5).

This switches to Network Menu Setting Screen.

2. Press FUNCTION button 1 on Network Menu Setting Screen.

The display switches to Filter Adjustment Screen, allowing filter adjustments.

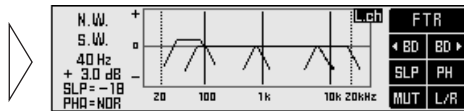

Using the Mute function (MUT)

It is possible to turn the Mute function ON/OFF for each band. Turning ON the Mute function stops the sound output for that band. Adjust the filter while turning the Mute function ON/OFF as necessary.

1. Select the band for which the Mute function is to be turned ON.

To select a band, consult “Adjusting the Filter” on the following page.

2. Press FUNCTION button 5 switches the Mute function ON/OFF.

When muting is turned ON the filter curve displaying disappears from the display.

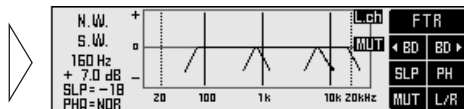

Before making filter adjustments

- When the position is set up for the driver's seat after adjusting the distance between the listening position and each speaker of the Time Alignment Adjustment function (refer to page 29), it is recommended that filter adjustments be made.
- Store the different filter characteristics into memory, by the listening position set up with the Position Selector function (refer to page 17) or by the source being listened, and switch when necessary. Refer to page 38 for memory operations.

Adjusting the Filter

First, determine the approximate band to be used, taking into consideration the reproduced frequency band and the characteristics of the connected speaker.

1. Open the cover of the remote controller in the Network Menu (refer to page 5).

This switches to Network Menu Setting Screen.

2. Press the FUNCTION button 1.

The display switches to Filter Adjustment Screen, allowing filter adjustments.

3. Press FUNCTION button 6 and select left (Left) or right (Right) channel (only for LR/IND mode).

Each press the FUNCTION button 6 switches left and right channel.

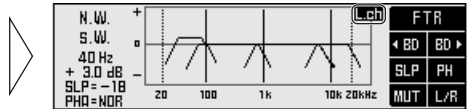

4. Press FUNCTION buttons 1 or 2 and select the filter to be adjusted.

Press the button to switch the band to be adjusted and high pass filter/low pass filter.

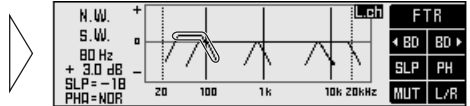

5. Press the </> buttons to set up the cut-off frequency of the selected filter (crossover frequency).

Holding down these buttons continues their operations.

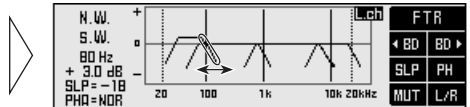

6. Set up the cut-off frequencies of each filter for all the bands.

Repeat steps 4 and 5 to adjust each filter so that the band used and crossover frequency are appropriately located.

Important points in adjusting cut-off frequencies

- If the subwoofer is installed in the rear tray, setting a high cut-off frequency of L.P.F. of the subwoofer separates the bass and gives the listener the feeling that the bass is coming from behind. The L.P.F. of the subwoofer is recommended to be set at 100 Hz or below.
- Speakers used for mid and high-ranges are generally constructed to handle a limited level of input compared to low range speakers. If the cut-off frequency of H.P.F. is set lower than necessary, strong bass signals can reach the speaker and may damage it.

Important points in adjusting the level

- The low band, because of its sound frequency characteristics, incorporates the basic frequencies of many musical instruments. It is recommended that the level adjustment of the low band be made first, and then the level adjustment of the mid, high, and subwoofer be made in that order.

7. Press the ▲/▼ buttons and adjust the level of each band.

Holding down these buttons continues their operations.

Switch to each band and adjust the level in order to create a better overall balance.

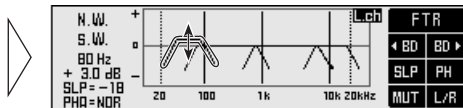

8. Press FUNCTION button 3 and adjust the slope of each filter.

Press the button to change the adjustment values.

The slope can be set up for either the high pass filter or the low pass filter.

When setting up, have in mind the adjustments to be made to the next band.

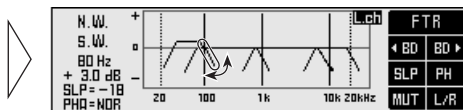

When you selected MID H.P.F.

- Press the FUNCTION button 3 for two seconds and you can set to PASS of MID H.P.F. (Press the button again returns to MID H.P.F. slope setting.)

9. Press FUNCTION button 4 and adjust the phase of each band.

Press the button to change between normal (NOR) and reverse (REV).

Set up the one which makes the better link to the next band.

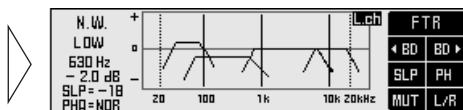

10. Switch between left and right channel to adjust the filter.

Repeat steps 3–9 to adjust the filters of left and right.

Important points in adjusting the slope

- A decrease in the absolute value of the slope (more gentle inclination) makes the frequency characteristics more susceptible to interference from the next band.
- Increasing the absolute value of the slope (sharper inclination) lessens the connections between bands, giving the listener the impression of hearing separate, unrelated sounds.
- Make adjustments while monitoring the link between bands by outputting all the bands as well as by outputting two neighboring bands only, using the Mute function (refer to page 34).

Important points in adjusting the phase

- When the values of the slope at the crossover point are set at -12 dB/oct. or -36 dB/oct. for both filters, the phase reverses 180° in the cut-off frequency of the filter. In this case, setting to reverse improves the connection between sounds.

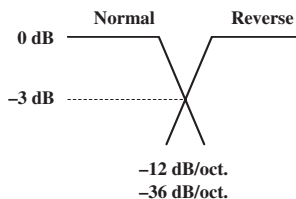

For better frequency characteristics

- Adjusting the filter together with the equalizer function (page 22) creates a natural sound environment in the car.

Adjusting the subwoofer effectively

- Although the slope of the high pass filter is normally set as PASS, H.P.F. may sometimes reproduce clear and high quality bass range. In this case, adjust the cut-off frequency to 20 — 40 Hz and adjust the slope to -18 — -36 dB/oct.
- If the subwoofer is installed in the rear tray, setting up the slope of the low pass filter gently (-6 , -12 dB/oct.) gives the listener the feeling that the sound dwindles to the rear, with a resultant distortion of the forward sound image position. It is recommended to set the slope at -18 dB/oct. or more and set the cut-off frequency to 100 Hz or below.

Adjusting the low-range effectively

- When the subwoofer is connected and low-ranges are reproduced by small speaker units such as 4 or less than 5-1/4 in. in diameter, setting the low-range H.P.F. as PASS may increase the distortion when strong bass signals enter. Should this occur, set up H.P.F. to avoid interference with the subwoofer.

Adjusting the high-range effectively

- Depending on the speaker units installed, bass signals for the tweeter (about 2 kHz or below) may cause distortion as the high pass filter is being adjusted. If this happens, set a sharp slope of -18 — -36 dB/oct. In this case, choose such settings that the mid-range and tweeter do not become separated.
- The low pass filter is generally set to PASS. However, if the ultratrange band falls harshly on the ear, it is possible to set up a more gentle slope of about -6 dB/oct.

Memory Functions of Adjusted Audio Menu (MEMO)

This system allows the contents of the adjusted equalizer and network to be stored in memory as follows. The numbers in () represent the numbers of the memory registers to be used.

Note:

- The Equalizer Menu's equalizer curve, and the Network Menu's Time alignment and Filter adjustment are simultaneously stored in memory.

Memory (5)

This memory stores the equalizer curve and network setup that have been adjusted to the desired position.

The memory operations (storing, recalling, etc.) are carried out using each menu screen. In this manual, the memory operations that are common to all the menus are illustrated mainly using the screens for a 31 band graphic equalizer. Conduct the same operations on other menus.

Note:

- Pressing the RESET button of this unit will reset the Memory. Before pressing the RESET button, it is preferable to contact your dealer.

Switching to Memory Mode

Memory operations are conducted in the memory mode of each Audio Menu.

Equalizer Menu

1. Open the cover of the remote controller in the Equalizer Menu (refer to page 5).
2. Press the **SHIFT** button.

The display switches to Equalizer Memory Operation Screen for conducting memory operations. Press the button again to return to the previous screen.

Note:

- This operation cannot be conducted when the Flat function of the Equalizer Menu is ON.

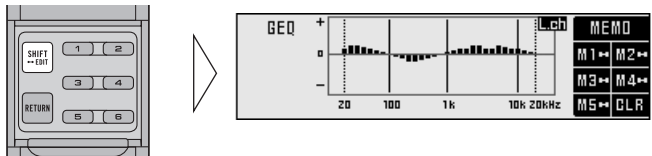

Network Menu

1. Open the cover of the remote controller in the Network Menu (refer to page 5).
2. Press the **SHIFT** button.

The display switches to Network Memory Operation Screen for conducting memory operations. Press the button again to return to the previous screen.

Note:

- This operation cannot be conducted when the screen shows Filter Adjustment Screen or Time Alignment Adjustment Screen.

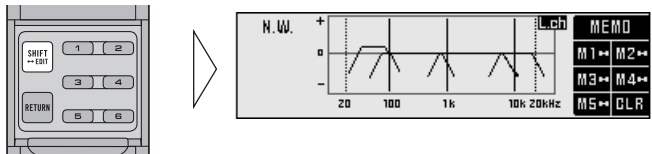

Storing the Adjustment Data in Memory

1. Adjust each Audio Menu.

Equalizer Menu (page 22)

Network Menu (page 27)

2. Switch to the memory mode of each menu (refer to page 39).

The display switches to Memory Operation Screen of each menu.

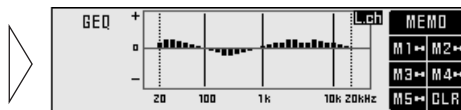

3. To store in memory, press the FUNCTION button corresponding to the desired memory number for two seconds.

Note:

- When the adjustment data have been stored, the previous data are eliminated and replaced by the new.

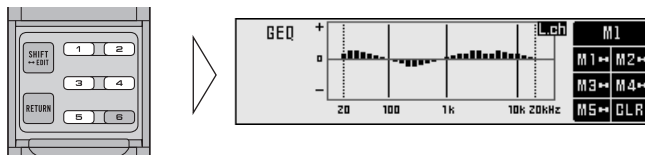

4. Press the SHIFT button to cancel memory mode.

The display returns to the previous screen.

To avoid accidentally erasing stored data

- In order to avoid erasing stored data with new data, it is possible to set up a Protect function (refer to page 43).
- Protect function is simultaneously turned on for M1, M2, M3 and M4 and it is not possible to store new data in these memories. In this case, to store the new data, select M5 or cancel the protect function.

To cancel the protect function, the memory to be canceled must be recalled. Therefore, the current adjustment data is cleared. When the Protect function has been canceled, make the adjustment again.

Recalling Data Stored in Memory

There are two ways to recall data stored in memory.

In Forward/Reverse Order — Functions of Equalizer Menu —

This function can be operated when the cover of the remote controller is closed. Stored data can be recalled by moving forwards or backwards through the memory numbers (the numbers of the corresponding FUNCTION buttons).

Note:

- It is not possible to recall the memory in this manner when operating the network menu.

Specifying the Memory Number Directly

This function can be operated when the cover of the remote controller is open and the menu displays open state. Stored data can be retrieved directly.

Recalling Memory Using Forward/Reverse Order — Functions of Equalizer Menu —

1. Close the cover of the remote controller.

The menu display switches to closed state.



2. Press the ▲/▼ buttons to recall the memory.

Press these buttons to move forwards or backwards through the memory numbers.

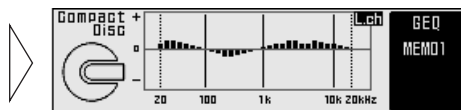
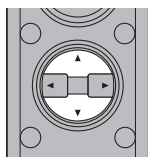

Specifying the Memory Number Directly

1. Switch to the memory mode of each menu (refer to page 39).

The display switches to Memory Operations Screen of each menu.

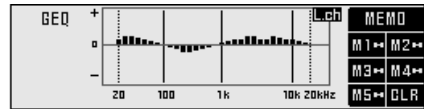

2. Press the FUNCTION button to recall the memory.

Press the FUNCTION button which corresponds to the desired memory number.

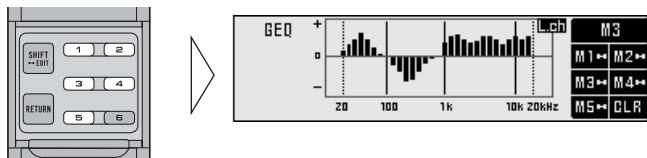

Memory recall operations on the Equalizer Menu

- When the Flat function is turned ON, it is not possible to recall memory.

After completing adjustments

- Recalling the memory clears the adjustment data. Store the adjustment data into memory when necessary (refer to page 40).

Memory Protect function

In order to avoid accidentally erasing data which have been stored in memory, or to avoid replacing stored data, it is possible to set up a Protect function for the following memory numbers.

When the Protect function is ON, adjustment data storage operations are not accepted.

Note:

- When the Protect function is ON, memory M1 to M4 is protected simultaneously.
- You cannot operate the Protect function on M5 memory.

1. Recall the memory (refer to page 42).

Specify the memory number directly to recall the memory.

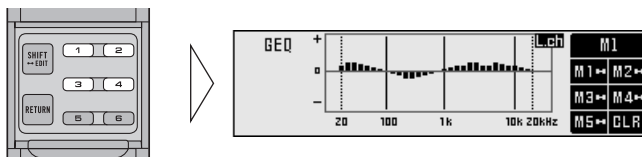

2. Press the RETURN button for two seconds to turn ON the Protect function.

Press the button again for two seconds to cancel the Protect function.

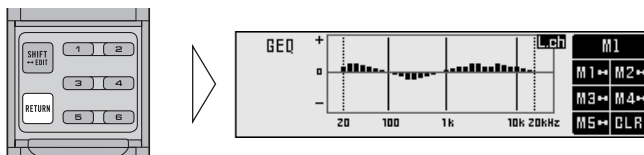

When turning the Protect function ON/OFF

- Turning the Protect function ON/OFF does not bring up anything on the display.
- When the Protect function is turned ON and the user attempts to store new data in that memory, the “” appears to signify that data storage is not possible.

Memory Clearing Operations

It is possible to clear the memory of the equalizer and network. Clearing operations are conducted as follows.

1. Recall the memory to be cleared by clearing operation (refer to page 42).

Specify the memory number directly to recall the memory.

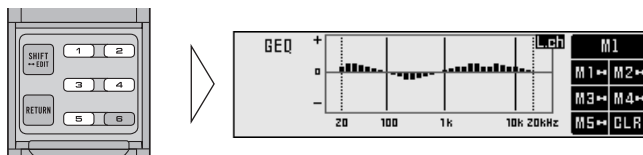

2. Press the FUNCTION button 6 for two seconds to clear the memory.

Note:

- When the Protect function is turned ON, it is not possible to clear the memory.

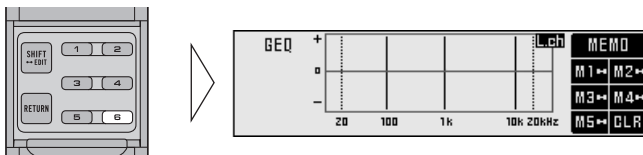

Inputting the Name

Inputting the name of the person who set up the memory (Equalizer and Network) of the Audio menu, or messages, stores them in the DEX-P9's head unit's memory. The DEX-P9 head unit is sold separately.

Switching to each Audio menu brings up the title screen of each menu first. On this title screen of the Audio menu, the stored contents are displayed.

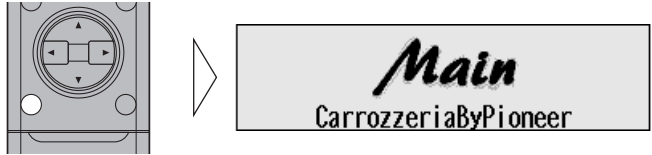

Note:

- A maximum of 20 characters can be stored.
- The same contents are displayed on the title screen of all the Audio menus.

Inputting Characters (Switching to the Edit Mode)

Characters are input in Edit Mode (EDIT).

1. Press the MENU button to switch to the Audio Menu.

It is possible to switch to edit mode from all the Audio Menus (Main/Equalizer/Network). Switch to one of these menus.

(Example: Main Menu)

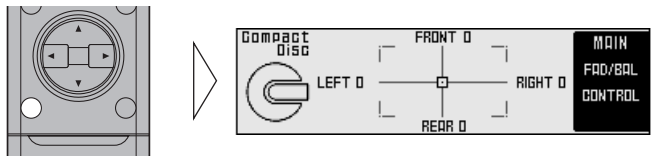

2. Open the cover of the remote controller.

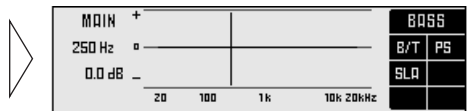

3. Press the SHIFT button for two seconds to switch to Edit Mode.

The display switches to Character Input Screen to allow input of characters.



4. Switch the desired character type with FUNCTION button 1.

Each press of FUNCTION button 1 changes the Character type in the following order:

Upper case alphabet (Capital Letter),
Numbers and Symbols → Lower case alphabet (Small Letter)

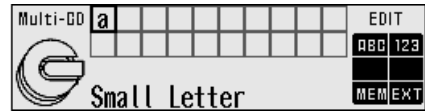

Note:

- You can select to input Numbers and Symbols by pressing FUNCTION button 2.

5. Select letters, numbers and symbols with the ▲/▼ buttons.

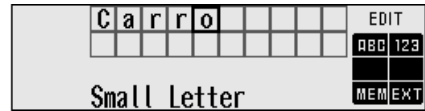

6. Move the box left and right with the ◀/▶ buttons.

To insert a space, skip the box with the ▶ button.

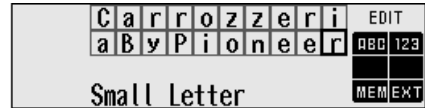

Continued overleaf.

Display for the Person who Set Up the Audio Adjustments

- When you have completed title input, memorize by pressing the **FUNCTION** button 5.
- Press the **FUNCTION** button 6 or **RETURN** button and return to the previous mode.

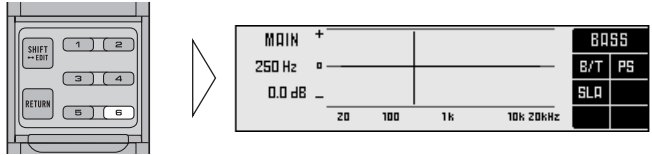

- The contents stored in memory are indicated on the display.

Switching the Audio Menu displays on the title screen the contents stored in memory.

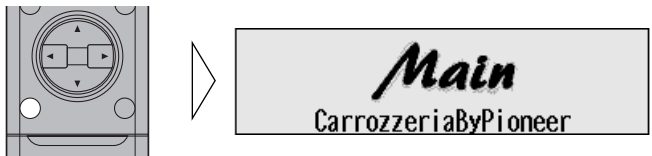

When removing the car battery

- The separately sold head unit "DEX-P9" stores the name of the person who set up the audio in memory. Removing the car battery clears the memory.

Equalizer

Frequency	M1	M2	M3	M4	M5
20 Hz					
25 Hz					
31.5 Hz					
40 Hz					
50 Hz					
63 Hz					
80 Hz					
100 Hz					
125 Hz					
160 Hz					
200 Hz					
250 Hz					
315 Hz					
400 Hz					
500 Hz					
630 Hz					
800 Hz					
1 kHz					
1.25 kHz					
1.6 kHz					
2 kHz					
2.5 kHz					
3.15 kHz					
4 kHz					
5 kHz					
6.3 kHz					
8 kHz					
10 kHz					
12.5 kHz					
16 kHz					
20 kHz					

Network: Filter characteristics

		M1						M2					
		L.P.F.		H.P.F.		Level	Phase	L.P.F.		H.P.F.		Level	Phase
		Frequency	Slope	Frequency	Slope			Frequency	Slope	Frequency	Slope		
LEFT	HIGH												
	MID												
	LOW												
	S.W.												
RIGHT	HIGH												
	MID												
	LOW												
	S.W.												

		M3						M4					
		L.P.F.		H.P.F.		Level	Phase	L.P.F.		H.P.F.		Level	Phase
		Frequency	Slope	Frequency	Slope			Frequency	Slope	Frequency	Slope		
LEFT	HIGH												
	MID												
	LOW												
	S.W.												
RIGHT	HIGH												
	MID												
	LOW												
	S.W.												

		M5					
		L.P.F.		H.P.F.		Level	Phase
		Frequency	Slope	Frequency	Slope		
LEFT	HIGH						
	MID						
	LOW						
	S.W.						
RIGHT	HIGH						
	MID						
	LOW						
	S.W.						

Network: Time Alignment

M1	Position:			
	S.W.	LOW	MID	HIGH
Left (LEFT)				
Right (RIGHT)				

M2	Position:			
	S.W.	LOW	MID	HIGH
Left (LEFT)				
Right (RIGHT)				

M3	Position:			
	S.W.	LOW	MID	HIGH
Left (LEFT)				
Right (RIGHT)				

M4	Position:			
	S.W.	LOW	MID	HIGH
Left (LEFT)				
Right (RIGHT)				

M5	Position:			
	S.W.	LOW	MID	HIGH
Left (LEFT)				
Right (RIGHT)				

Connecting the Units

Note:

- This unit is for vehicles with a 12-volt battery and negative grounding. Before installing it in a recreational vehicle, truck, or bus, check the battery voltage.
 - To avoid shorts in the electrical system, be sure to disconnect the \ominus battery cable before beginning installation.
 - Refer to the owner's manual for details on connecting the power amp and other units, then make connections correctly.
 - Secure the wiring with cable clamps or adhesive tape. To protect the wiring, wrap adhesive tape around them where they lie against metal parts.
 - Route and secure all wiring so it cannot touch any moving parts, such as the gear shift, handbrake, and seat rails. Do not route wiring in places that get hot, such as near the heater outlet. If the insulation of the wiring melts or gets torn, there is a danger of the wiring short-circuiting to the vehicle body.
 - Don't pass the yellow lead through a hole into the engine compartment to connect to the battery. This will damage the lead insulation and cause a very dangerous short.
 - Do not shorten any leads. If you do, the protection circuit may fail to work when it should.
 - Never feed power to other equipment by cutting the insulation of the power supply lead of the unit and tapping into the lead. The current capacity of the lead will be exceeded, causing overheating.
 - When replacing a fuse, be sure to use only fuses of the rating prescribed on the fuse holder.
 - The black lead is ground. Please ground this lead separately from the ground of high-current products such as power amps.
If you ground the products together and the ground becomes detached, there is a risk of damage to the products or fire.
- When this product's source is switched ON, a control signal is output through the blue/white lead. Connect to an external power amp's system remote control (max. 300 mA 12 V DC).
 - When an external power amp is being used with this system, be sure not to connect the blue/white lead to the amp's power terminal.
 - To prevent incorrect connection, the input side of the IP-BUS connector and Optical connector is blue, and the output side is black. Connect the connectors of the same colors correctly.

• Cords for this product and those for other products may be different colors even if they have the same function. When connecting this product to another product, refer to the supplied Installation manuals of both products and connect cords that have the same function.

Routing the Optical Cable

Note:

- Try not to bend the optical cable sharply. If it is necessary to bend it sharply, make sure that the bending radius is at least 25 mm (1 inch), otherwise the cable will not transfer signals properly and so this unit will not work properly.
- Route the optical cable so that nothing heavy rests on it, and so that it cannot be stepped on or caught in anything – for instance, a door.
- Make a loop of diameter at least 200 mm (7-7/8 inches) with the remaining optical cable so that the cable does not get strained.
- When plugging the optical cable into the unit, use the supplied cable clamp to prevent the cables from being bent sharply.
- Route the optical cable so that it does not get caught in moving parts such as the gear shift, hand brake, or seat sliding mechanism. Keep the cable away from hot spots, such as near the heater outlet.

Using the Corrugated Tube

To prevent the optical cable from being strained, use the corrugated tube after cutting it to the correct length.

- **Insert the optical cable into the corrugated tube.**

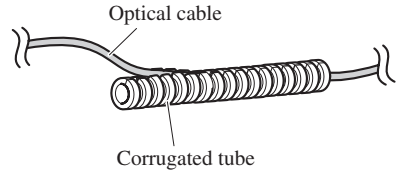

Setting Example

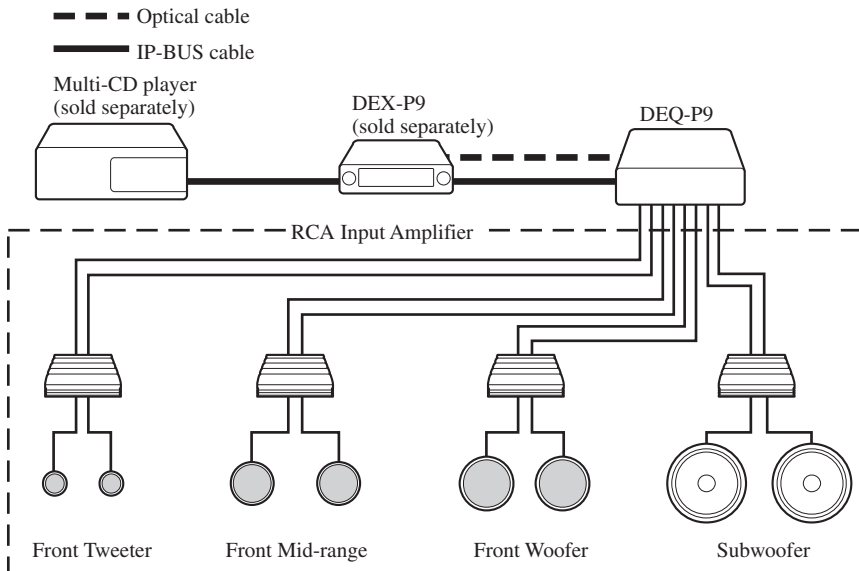

Connection Diagram

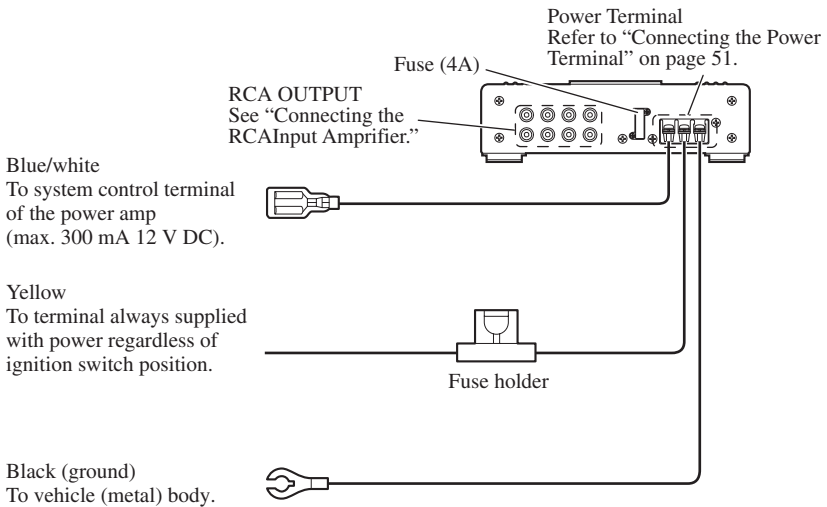
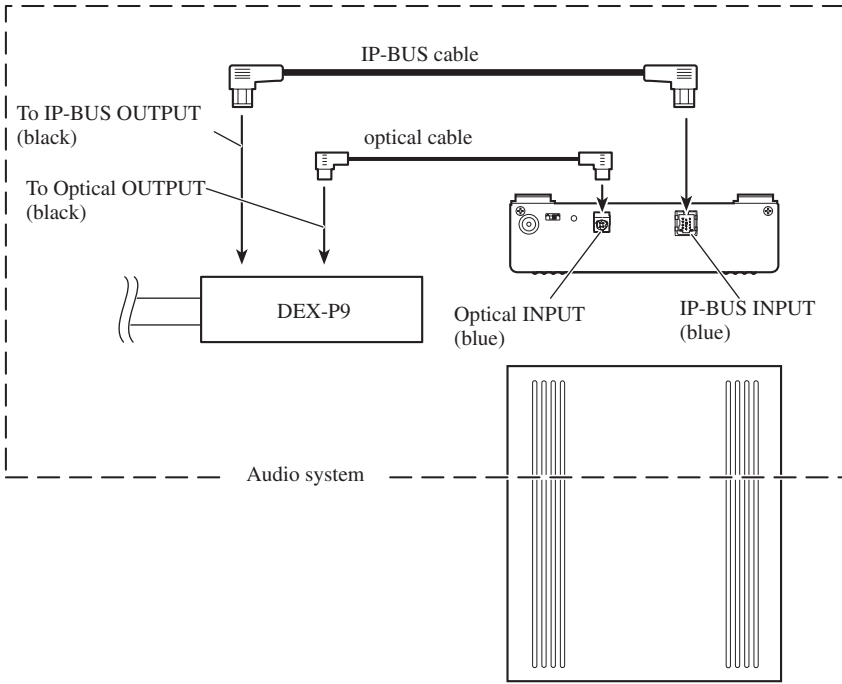

Connecting the RCA Input Amplifier

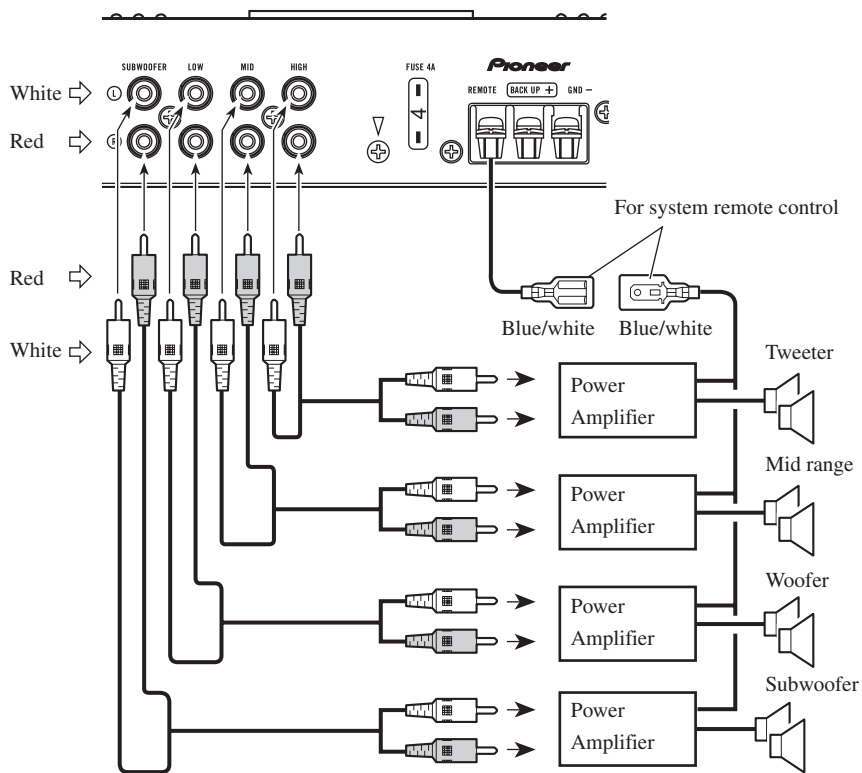

Connecting the Power Terminal

1. Put the short-circuit protection cover around the blue/white, yellow and black lead.

Be sure to use this cover to prevent short-circuit.

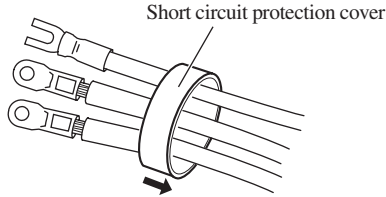

2. Connecting the leads.

Securely fasten the leads with terminal screws.

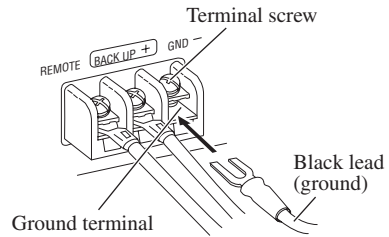
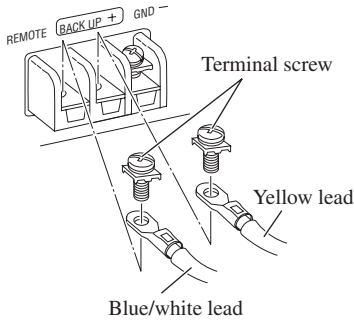

3. Cover the entire terminal with the short-circuit protection cover.

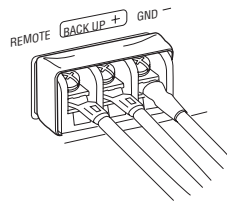
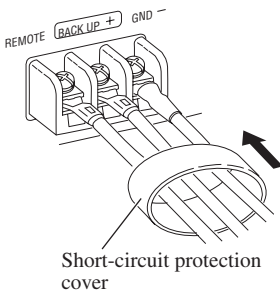

Connecting the IP-BUS and Optical Cable

Connecting the Cables

1. Attach the cable clamp.

When plugging the optical cable and IP-BUS cable into the unit, use the supplied cable clamp to prevent the cables from being bent sharply.



Attach the cable clamp into the hole.

2. Route the optical cable and IP-BUS cable through the cable clamp.

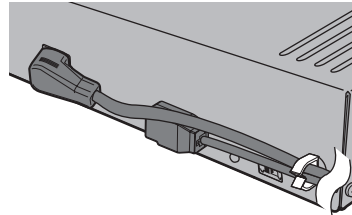

Note:

- Before finally installing the unit, connect the wiring temporarily, making sure it is all connected up properly, and the unit and the system work properly.
- Use only the parts included with the unit to ensure proper installation. The use of unauthorized parts can cause malfunction.
- Consult with your nearest dealer if installation requires the drilling of holes or other modifications of the vehicle.
- Install the unit where it does not get in the driver's way and cannot injure the passenger if there is a sudden stop, like an emergency stop.

Installing the Unit

1. Install the brackets to the bottom of the unit.

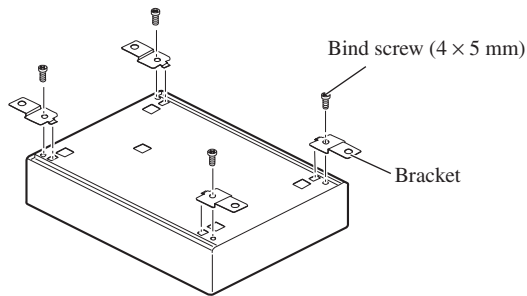

2. Install the unit to the vehicle.

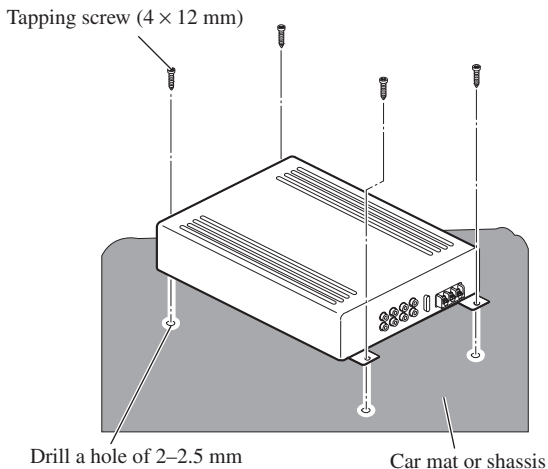

When an error occurs, locate the cause according to the list below. In most cases, the problem is incorrect connections or settings.

1. **Double check the connections and settings using the Checklist.**
2. **If connections and settings are correct, press the RESET button.**
Refer to “Resetting the Microprocessor” on page 10.
3. **If the malfunction continues even after pressing the RESET button, contact your dealer or nearest authorized Pioneer Service Station.**

Checklist

Symptom	Cause	Remedy	Page
No Operation	The battery is not connected.	Connect the battery.	—
	An yellow lead is not properly connected.	Connect all yellow leads to the battery terminal, supplied with constant power, regardless of the ignition switch position after running them through the vehicle’s fuse unit.	53
			55
	A black lead (ground) is not properly connected.	Firmly connect all the black leads to the vehicle (metal) body.	53
			55
	A blue/white lead is not properly connected.	Connect the blue/white lead of the RCA input power amplifier to the blue/white lead of this unit.	53
			54
The fuse is blown.	Remove the cause and replace with another fuse of the same rating.	53	
Incorrect connection.	Make sure all the connectors are properly connected.	53~56	
Unnatural sound	The mode setting switches are incorrectly set.	Set the mode setting switches correctly, then press the RESET button.	9

Specifications

GENERAL

Power Source	DC 14.4 V (10.8 — 15.1 V allowable)
Grounding system	Negative type
Fuse	4 A
Dimensions	191 (W) × 49 (H) × 220 (D) mm
Weight	1.8 kg

DSP/PREAMP

Tone controls (parametric)

Bass frequency	63 Hz, 100 Hz, 160 Hz, 250 Hz
Treble frequency	4 kHz, 6.3 kHz, 10 kHz, 16 kHz
Gain	±12 dB (1 dB)

31-band graphic equalizer (L/R independent)

Frequency	20 Hz — 20 kHz, 1/3 oct.
Gain	±12 dB (0.5 dB)

Crossover network (L/R independent)

SUBWOOFER

.....	HPF frequency: 20 Hz — 100 Hz, 1/3 oct.
.....	LPF frequency: 25 Hz — 250 Hz, 1/3 oct.
.....	Gain: +10 dB — -24 dB (0.5 dB)

LOW	HPF frequency: 25 Hz — 250 Hz, 1/3 oct.
.....	LPF frequency: 250 Hz — 10 kHz, 1/3 oct.
.....	Gain: 0 dB — -24 dB (0.5 dB)

MID	HPF frequency: 200 Hz — 10 kHz, 1/3 oct.
.....	LPF frequency: 2 kHz — 20 kHz, 1/3 oct.
.....	Gain: 0 dB — -24 dB (0.5 dB)

HIGH

.....	HPF frequency: 1.6 kHz — 20 kHz, 1/3 oct.
.....	LPF frequency: 8 kHz — 20 kHz, 1/3 oct.
.....	Gain: 0 dB — -24 dB (0.5 dB)

Slope	PASS, -6, -12, -18, -24, -30, -36 dB/oct.
.....	(PASS: no pass HPF-High channel)

Phase	NORMAL/REVERSE
-------------	----------------

Time alignment	0 — 134 in. (0.67 in.)
----------------------	------------------------

Position adjustment

.....	DISTANCE: 0 — 134 in. (0.67 in.)
.....	Level: 0 — -30 dB

Sampling frequency	44.1 kHz
--------------------------	----------

Digital input	Optical input
---------------------	---------------

Analog Output	RCA (4 way)
---------------------	-------------

RCA OUTPUT

Frequency response	10 Hz — 20 kHz (+0, -1 dB)
Max. output level/impedance	4 V/1 k Ω
Distortion	0.005% (1 kHz, 20 kHz LPF)
Signal-to-noise ratio	109 dB (IHF-A network)
Separation	90 dB (1 kHz, 20 kHz LPF)

Note:

- Specifications and the design are subject to possible modification without notice due to improvements.



PIONEER CORPORATION

4-1, MEGURO 1-CHOME, MEGURO-KU, TOKYO 153-8654, JAPAN

PIONEER ELECTRONICS (USA) INC.

P.O. Box 1760, Long Beach, California 90801, U.S.A.
TEL: (800) 421-1404

PIONEER EUROPE NV

Haven 1087, Keetberglaan 1, B-9120 Melsele, Belgium
TEL: (0) 3/570.05.11

PIONEER ELECTRONICS AUSTRALIA PTY. LTD.

178-184 Boundary Road, Braeside, Victoria 3195, Australia
TEL: (03) 9586-6300

PIONEER ELECTRONICS OF CANADA, INC.

300 Allstate Parkway, Markham, Ontario L3R OP2, Canada
TEL: (905) 479-4411

PIONEER ELECTRONICS DE MEXICO, S.A. de C.V.

San Lorenzo 1009 3er. Piso Desp. 302
Col. Del Valle Mexico, D.F. C.P. 03100
TEL: 5-688-52-90

Published by Pioneer Corporation.
Copyright © 2001 by Pioneer Corporation.
All rights reserved.

Publication de Pioneer Corporation.
Copyright © 2001 Pioneer Corporation.
Tous droits de reproduction et de traduction réservés.

Free Manuals Download Website

<http://myh66.com>

<http://usermanuals.us>

<http://www.somanuals.com>

<http://www.4manuals.cc>

<http://www.manual-lib.com>

<http://www.404manual.com>

<http://www.luxmanual.com>

<http://aubethermostatmanual.com>

Golf course search by state

<http://golfingnear.com>

Email search by domain

<http://emailbydomain.com>

Auto manuals search

<http://auto.somanuals.com>

TV manuals search

<http://tv.somanuals.com>