

Operation Manual

AV Receiver/DVD Player with 6.5 inch Wide Display

AVH-P5700DVD

Thank you for buying this Pioneer product.

Please read through these operating instructions so you will know how to operate your model properly. *After you have finished reading the instructions, keep this manual in a safe place for future reference.*



Be sure to read this

- Playable discs **8**
- DVD video disc region numbers **8**
- When an operation is prohibited **12**

01 Precautions

IMPORTANT SAFEGUARDS **6**

To ensure safe driving **6**

To avoid battery exhaustion **7**

02 Before You Start

About this unit **8**

About this manual **9**

In case of trouble **9**

Features **9**

About WMA **11**

To protect the LCD screen **11**

For viewing LCD comfortably **11**

What the marks on DVDs indicate **12**

Resetting the microprocessor **12**

03 What's What

Head unit **13**

Optional remote control **14**

04 Basic Operations

Turning the unit on and selecting a source **15**

Loading a disc **16**

Adjusting the volume **16**

Turning the unit off **16**

Using the rear display **16**

Displaying the navigation image **16**

Displaying the AVG-VDP1 (Pioneer Vehicle Dynamics Processor) **17**

Touch panel key basic operation **18**

Opening and closing the LCD panel **19**

Changing the wide screen mode **20**

Adjusting the picture adjustment **20**

Protecting your unit from theft **21**

05 Tuner

Listening to the radio **23**

Storing and recalling broadcast frequencies **24**

Introduction of advanced tuner operation **24**

Tuning in strong signals **24**

Storing the strongest broadcast frequencies **25**

06 RDS

Introduction of RDS operation **26**

Switching the RDS display **26**

Selecting alternative frequencies **27**

Receiving traffic announcements **28**

Using PTY functions **28**

Using radio text **29**

PTY list **30**

07 Playing DVD video discs

Watching a DVD video **31**

Operating the DVD menu **32**

Skipping back or forward to another title **32**

Stopping playback **32**

Pausing DVD video playback **32**

Frame-by-frame playback **33**

Slow motion playback **33**

Searching for a desired scene, starting playback from a specified time **33**

Changing audio language during playback (Multi-audio) **34**

Changing the subtitle language during playback (Multi-subtitle) **35**

Changing the viewing angle during playback (Multi-angle) **35**

- Return to the specified scene **35**
- Automatic playback of DVDs **35**
- Introduction of advanced DVD video operation **36**
- Repeating play **36**
- Selecting audio output **37**
- Resume playback (Bookmark) **37**

08 Playing Video CDs

- Watching a Video CD **38**
- Stopping playback **39**
- Pausing Video CD playback **39**
- Frame-by-frame playback **39**
- Slow motion playback **39**
- Searching for a desired scene, starting playback from a specified time **39**
- PBC playback **40**
- Introduction of advanced Video CD operation **41**
- Repeating play **41**
- Selecting audio output **41**

09 Playing CDs

- Listening to a CD **42**
- Stopping playback **42**
- Pausing CD playback **43**
- Searching for a desired track **43**
- Using CD TEXT functions **43**
- Introduction of advanced CD operation **44**
- Repeating play **44**
- Playing tracks in a random order **44**
- Scanning tracks of a CD **44**
- Entering disc titles **45**
- Selecting tracks from the track title list **45**

10 Playing MP3/WMA

- Listening to MP3/WMA **46**
- Stopping playback **47**
- Pausing MP3/WMA playback **47**

- Displaying the list of information on MP3/WMA file **47**
- Introduction of advanced built-in DVD player (MP3/WMA) operation **49**
- Repeating play **49**
- Playing tracks in a random order **49**
- Scanning folders and tracks **50**

11 Multi-CD Player

- Listening to a CD **51**
- Pausing CD playback **51**
- Using CD TEXT functions **52**
- 50-disc multi-CD player **52**
- Introduction of advanced multi-CD player operation **53**
- Repeating play **53**
- Playing tracks in a random order **53**
- Scanning CDs and tracks **53**
- Using ITS playlists **54**
- Using disc title functions **55**
- Selecting tracks from the track title list **56**
- Using compression and bass emphasis **56**

12 DAB tuner

- Listening to the DAB **57**
- Switching the DAB display **58**
- Storing and recalling broadcast frequencies **58**
- Using dynamic label **58**
- Introduction of advanced DAB tuner operation **59**
- Setting the announcement support interruption **59**
- Selecting services from the available service list **60**
- Searching for service by available PTY information **60**
- Switching primary or secondary service component **60**

Switching the service follow 60

13 TV tuner

Watching the television 61
Storing and recalling broadcast stations 61
Introduction of advanced TV tuner operation 62
Storing the strongest broadcast stations sequentially 62
Selecting the country group 63

14 DVD Player

Playing a disc 64
Selecting a disc 64
Pausing disc playback 64
Introduction of advanced DVD player operation 65
Repeating play 65
Playing tracks in a random order 65
Scanning tracks of a CD 65
Using ITS playlists 66
Using disc title functions 66

15 Playing songs on iPod

Listening to songs on your iPod 67
Browsing for a song 67
Pausing a song 68
Displaying text information on iPod 68
Repeating play 68
Playing songs in a random order (shuffle) 68

16 Audio Adjustments

Introduction of audio adjustments 69
Using balance adjustment 69
Using the equalizer 70
Adjusting bass and treble 71
Adjusting loudness 71
Using subwoofer output 72

Using nonfading output 72
Using the high pass filter 72
Adjusting source levels 73
Compensating for equalizer curves (EQ-EX) 73

17 Digital Signal Processor

Introduction of DSP adjustments 74
Using the sound field control 74
Using the position selector 75
Using balance adjustment 76
Adjusting source levels 76
Using the dynamic range control 76
Using the down-mix function 77
Using the direct control 77
Using the Dolby Pro Logic II 77
Setting the speaker setting 78
Selecting a cross-over frequency 79
Adjusting the speaker output levels 79
Adjusting the speaker output levels using a test tone 80
Using the time alignment 81
Using the equalizer 81
Using the auto-equalizer 83
Auto TA and EQ (auto-time alignment and auto-equalizing) 83

18 Setting up the DVD player

Introduction of DVD setup adjustments 86
Setting the subtitle language 86
Setting the audio language 87
Setting the menu language 87
Setting assist subtitles on or off 87
Setting angle icon display 87
Setting the aspect ratio 88
Setting the parental lock 88

19 Initial Settings

Adjusting initial settings 90

Setting the FM tuning step	90
Switching Auto PI Seek	90
Switching the warning tone	90
Switching the auxiliary setting	91
Setting the illumination switch	91
Selecting the illumination color	91
Setting the rear output and subwoofer controller	91
Correcting distorted sound	92
Switching the sound muting/attenuation	92
Mixing navigation voice/AVG-VDP1 beep and audio sound	93
Resetting the audio functions	93
Setting the TV signal	93

Other Functions

Introduction of setup adjustments	95
Setting the AV input	95
Setting for rear view camera	95
Monitoring rear view	96
Setting the automatic open function	96
Setting the clock	97
Selecting video on rear display	97
Using the AUX source	98
Selecting the background display	98

Additional Information

Troubleshooting	100
Error messages	102
Understanding auto TA and EQ error messages	102
Understanding messages	103
DVD player and care	104
DVD discs	104
CD-R/CD-RW discs	104
MP3 and WMA files	105
About folders and MP3/WMA files	106
Using the display correctly	107
Language code chart for DVD	109

Terms	110
Specifications	113

Index 115

IMPORTANT SAFEGUARDS

Please read all of these instructions regarding your display and retain them for future reference.

- 1 **Read this manual fully and carefully before operating your display.**
- 2 **Keep this manual handy as a reference for operating procedures and safety information.**
- 3 **Pay close attention to all warnings in this manual and follow the instructions carefully.**
- 4 **Do not allow other persons to use this system until they have read and understood the operating instructions.**
- 5 **Do not install the display where it may (i) obstruct the driver's vision, (ii) impair the performance of any of the vehicle's operating systems or safety features, including air bags, hazard lamp buttons or (iii) impair the driver's ability to safely operate the vehicle.**
- 6 **Do not operate this display if doing so in any way will divert your attention from the safe operation of your vehicle. Always observe safe driving rules and follow all existing traffic regulations. If you experience difficulty in operating the system or reading the display, park your vehicle in a safe location and make necessary adjustments.**
- 7 **Please remember to wear your seat belt at all times while operating your vehicle. If you are ever in an accident, your injuries can be considerably more severe if your seat belt is not properly buckled.**
- 8 **Never use headphones while driving.**
- 9 **To promote safety, certain functions are disabled unless the parking brake is on, and the vehicle is not in motion.**
- 10 **Never set the volume of your display so high that you cannot hear outside traffic and emergency vehicles.**

WARNING

- **Do not attempt to install or service your display by yourself. Installation or servicing of the display by persons without training and experience in electronic equipment and automotive accessories may be dangerous and could expose you to the risk of electric shock or other hazards.** 

To ensure safe driving

WARNING

- **LIGHT GREEN LEAD AT POWER CONNECTOR IS DESIGNED TO DETECT PARKED STATUS AND MUST BE CONNECTED TO THE POWER SUPPLY SIDE OF THE PARKING BRAKE SWITCH. IMPROPER CONNECTION OR USE OF THIS LEAD MAY VIOLATE APPLICABLE LAW AND MAY RESULT IN SERIOUS INJURY OR DAMAGE.**
- To avoid the risk of damage and injury and the potential violation of applicable laws, this unit is not for use with a video screen that is visible to the driver.
- To avoid the risk of accident and the potential violation of applicable laws, the front DVD or TV (sold separately) feature should never be used while the vehicle is being driven. Also, rear displays should not be in a location where it is a visible distraction to the driver.
- In some countries or states the viewing of images on a display inside a vehicle even by persons other than the driver may be illegal. Where such regulations apply, they must be obeyed and this unit's DVD features should not be used.

Precautions

When you attempt to watch a DVD, Video CD or TV while driving, the warning **VIDEO VIEWING IS NOT AVAILABLE WHILE DRIVING** will appear on the front display.

To watch a DVD, Video CD or TV on the front display, park your vehicle in a safe place and apply the parking brake. 

To avoid battery exhaustion

Be sure to run the vehicle engine while using this unit. Using this unit without running the engine can result in battery drainage.



WARNING

Do not use with vehicles that do not feature an ACC position. 

About this unit

The tuner frequencies on this unit are allocated for use in Western Europe, Asia, the Middle East, Africa and Oceania. Use in other areas may result in poor reception. The RDS (radio data system) function operates only in areas with FM stations broadcasting RDS signals.

CAUTION

- Do not allow this unit to come into contact with liquids. Electrical shock could result. Also, this unit damage, smoke, and overheat could result from contact with liquids.
- This product contains a laser diode of higher class than 1. To ensure continued safety, do not remove any covers or attempt to gain access to the inside of the product. Refer all servicing to qualified personnel. A **CLASS 1 LASER PRODUCT** label is affixed to the bottom of this unit.



- The Pioneer CarStereo-Pass is for use only in Germany.
- Keep this manual handy as a reference for operating procedures and precautions.
- Always keep the volume low enough so that you can hear sounds from outside the vehicle.
- Protect this unit from moisture.
- If the battery is disconnected or discharged, the preset memory will be erased and must be reprogrammed.

Playable discs

DVD, Video CD and CD discs that display the logos shown below can be played back on this player.

DVD video



Video CD



CD



Notes

- **DVD** is a trademark of DVD Format/Logo Licensing Corporation.
- This player can only play back discs bearing the marks shown above.

DVD video disc region numbers

DVD video discs that have incompatible region numbers cannot be played on this player. The region number of the player can be found on the bottom of this unit.

Before You Start

The illustration below shows the regions and corresponding region numbers.



When combined with a Pioneer navigation unit

When you use this unit with the Pioneer DVD navigation unit, make sure that you use the map disc CNDV-30 or later. This manual explains the operations with the combined use of them.

If you do not use the map disc CNDV-30 but use an older version with the navigation unit, this unit may have some failures or inconveniences as follows:

- **ENTERTAINMENT (ENT)** button and **WIDE** button cannot function as **NAVI MENU** button and **POS** button.
- **NAVI** (navigation unit), such as DVD video from the combined Pioneer navigation unit with DVD video playback, cannot be selected as a source.
- In **NAVI MIX**, the settings other than **ALL** cannot be selected.
- Voice-recognition control system of the combined Pioneer navigation unit may not function properly with this unit. The voice operation for navigation can be used, but the voice operation related to AV equipment cannot be used.
- Route guidance of the combined Pioneer navigation unit may not function properly when some other source images are displayed. Guidance by voice can be obtained, but on guidance by display (e.g. switching

to an enlarged map of an intersection) cannot be obtained.

- **NAVI** (navigation unit wallpaper) cannot be selected as a background display.

About this manual

This unit features a number of sophisticated functions ensuring superior reception and operation. All the functions have been designed for the easiest possible use, but many are not self-explanatory. This operation manual will help you benefit fully from this unit's potential and to maximize your listening enjoyment. We recommend that you familiarize yourself with the functions and their operation by reading through the manual before you begin using this unit. It is especially important that you read and observe **WARNING**s and **CAUTION**s in this manual.

In case of trouble

Should this product fail to operate properly, contact your dealer or nearest authorized Pioneer Service Station.

Features

Touch panel key operation

It is possible to operate this unit by using touch panel key.

DVD video playback

It is possible to play back DVD video, DVD-R (video mode) and DVD-RW (video mode). Remember that use of this system for commercial or public viewing purposes may constitute an infringement on the author's rights protected by the Copyright Law.

Before You Start

Video CDs featuring PBC compatibility

It is possible to play back Video CDs featuring PBC (playback control).

CD playback

Music CD/CD-R/CD-RW playback is possible.

MP3 file playback

You can play back MP3 files recorded on CD-ROM/CD-R/CD-RW (ISO9660 Level 1/Level 2 standard recordings).

- Supply of this product only conveys a license for private, non-commercial use and does not convey a license nor imply any right to use this product in any commercial (i.e. revenue-generating) real time broadcasting (terrestrial, satellite, cable and/or any other media), broadcasting/streaming via internet, intranets and/or other networks or in other electronic content distribution systems, such as pay-audio or audio-on-demand applications. An independent license for such use is required. For details, please visit <http://www.mp3licensing.com>.

WMA file playback

You can play back WMA files recorded on CD-ROM/CD-R/CD-RW (ISO9660 Level 1/Level 2 standard recordings).

NTSC/PAL compatibility

This unit is NTSC/PAL/SECAM system compatible. When connecting other components to this unit, be sure components are compatible with the same video system otherwise images will not be correctly reproduced.

Dolby Digital/DTS compatibility

When using this unit with a Pioneer multi-channel processor, you can enjoy the atmosphere and excitement provided by DVD movie and music software featuring 5.1 channel recordings.

- Manufactured under license from Dolby Laboratories. "Dolby", "Pro Logic", and the double-D symbol are trademarks of Dolby Laboratories.



- "DTS" is a registered trademark of Digital Theater Systems, Inc.



iPod compatibility

When you use this unit with a Pioneer iPod adapter (CD-IB100), you can control an iPod, iPod mini, iPod Photo.

- iPod® is a trademark of Apple Computer, Inc., registered in the U.S. and other countries.
- iPod adapter supports only an iPod featuring the Dock connector port.
- This unit does not support software versions prior to iPod update 2004-10-20. For supported versions, consult your nearest Pioneer dealer.
- Operations may vary depending on the software version of iPod.

Multi-aspect

Switching between wide screen, letterbox and panscan display is possible.

Multi-audio

You can switch between multiple audio systems recorded on a DVD as desired.

Multi-subtitle

You can switch between multiple subtitle languages recorded on a DVD as desired.

Before You Start

Multi-angle

You can switch between multiple viewing angles of a scene recorded on a DVD as desired.

Note

This product incorporates copyright protection technology that is protected by method claims of certain U.S. patents and other intellectual property rights owned by Macrovision Corporation and other rights owners. Use of this copyright protection technology must be authorized by Macrovision Corporation, and is intended for home and other limited viewing uses only unless otherwise authorized by Macrovision Corporation. Reverse engineering or disassembly is prohibited. 

About WMA



The Windows Media™ logo printed on the box indicates that this unit can play back WMA data.

WMA is short for Windows Media Audio and refers to an audio compression technology that is developed by Microsoft Corporation. WMA data can be encoded by using Windows Media Player version 7 or later. Microsoft, Windows Media, and the Windows logo are trademarks, or registered trademarks of Microsoft Corporation in the United States and/or other countries.

Notes

- With some applications used to encode WMA files, this unit may not operate correctly.
- Depending on the version of Windows Media Player used to encode WMA files, album names and other text information may not be correctly displayed. 

To protect the LCD screen







- Do not allow direct sunlight to fall on the display when this unit is not being used. Extended exposure to direct sunlight can result in LCD screen malfunction due to the resulting high temperatures.
- When using a portable phone, keep the antenna of the portable phone away from the display to prevent disruption of the video by the appearance of spots, colored stripes, etc. 

For viewing LCD comfortably

Due to its construction, the view angle of the LCD screen is limited. The viewing angle (vertical and horizontal) can be increased, however, by using **BRIGHT** to adjust the black density of the video. When using for the first time, adjust the black density in accordance with the viewing angle (vertical and horizontal) to adjust for clear viewing. **DIMMER** can also be used to adjust the brightness of the LCD screen itself to suit your personal preference. 

What the marks on DVDs indicate



The marks below may be found on DVD disc labels and packages. They indicate the type of images and audio recorded on the disc, and the functions you can use.

Mark	Meaning
	Indicates the number of audio systems.
	Indicates the number of subtitle languages.
	Indicates the number of viewing angles.
	Indicates the picture size (aspect ratio: screen width-to-height ratio) type.
 	Indicates the number of the region where playback is possible.

When an operation is prohibited

When you are watching a DVD and attempt to perform an operation, it may not be performed because of the programming on the disc.

When this happens, the icon  appears on the screen.

- The icon  may not appear with certain discs. 

Resetting the microprocessor

Pressing **RESET** lets you reset the microprocessor to its initial settings.

The microprocessor must be reset under the following conditions:

- Prior to using this unit for the first time after installation
- If the unit fails to operate properly
- When strange or incorrect messages appear on the display

1 Turn the ignition switch OFF.

2 Press **RESET** with a pen tip or other pointed instrument.

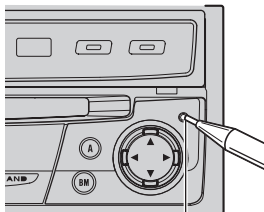

RESET button

Notes

- When using with a Pioneer navigation unit, if you press **RESET**, be sure ACC OFF is selected. If ACC ON is selected, correct operation may not be possible even if you press **RESET**.
- After completing connections or when you want to erase all memorized settings or return the unit to its initial (factory) settings, switch your engine ON or set the ignition switch to ACC ON before pressing **RESET**. 

What's What

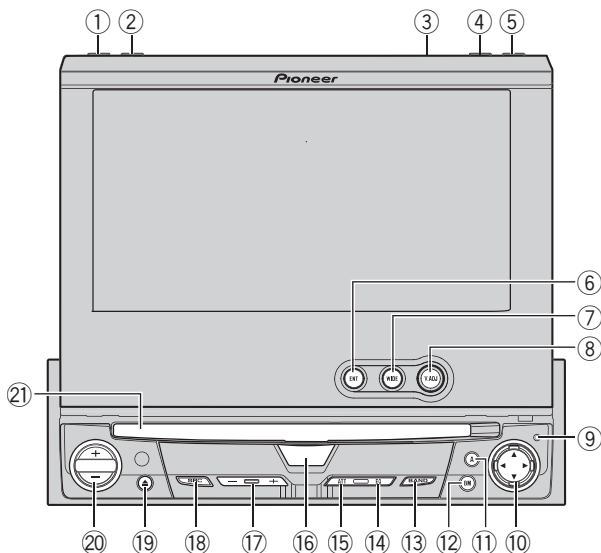

Head unit

① INFO button

Press to turn the information bar on/off.

② TA/NEWS button

Press to turn traffic announcements function on or off.

Press and hold to turn NEWS function on or off.

③ Ambient light sensor

Senses ambient light. This system automatically adjusts the brightness of the display to compensate for ambient light.

④ FLIP DOWN button

Press to turn the LCD panel horizontal temporarily from upright position.

⑤ OPEN/CLOSE button

Press to open or close the LCD panel.

⑥ ENTERTAINMENT (ENT) button

Press to switch between the background displays.

⑦ WIDE button

Press to select a desired mode for enlarging a 4:3 picture to a 16:9 one.

⑧ V.ADJ button

Press and hold to display the picture adjustment menu.

⑨ RESET button

Press to return to the factory settings (initial settings).

⑩ ▲/▼/◀/▶ buttons

Press to do manual seek tuning, fast forward, reverse and track search controls.

⑪ A.MENU button

Press to display MENU.

12 BOOKMARK (BM) button

Press to bookmark a scene that you want to resume playback.

13 BAND/ESC button

Press to select among three FM bands and MW/LW bands and to cancel the control mode of functions.

14 EQ button

Press to select various equalizer curves.

15 ATT button

Press to quickly lower the volume level, by about 90%. Press once more to return to the original volume level.

16 Release button

Press downward to detach the front panel.

17 ANGLE (+/-) button

Press to change the LCD panel angle.

18 SOURCE button

This unit is turned on by selecting a source. Press to cycle through all the available sources.

19 EJECT button

Press to eject a disc from this unit.

20 VOLUME

Press to increase or decrease the volume.

21 Disc loading slot

Insert a disc to play. 

Optional remote control

You can also control this unit with a separately sold remote control.

For details concerning operations, see the remote control manual. 

Basic Operations

Turning the unit on and selecting a source



① Source icon

Shows which source has been selected.

You can select a source you want to listen to. To switch to the DVD player, load a disc in the unit to switch to **DVD**.

● When using the touch panel keys, touch the source icon and then touch the desired source name.

The source names are displayed and selectable ones are highlighted.

- **DVD** – Built-in DVD player
 - **S-DVD** – DVD player/multi-DVD player
 - **M-CD** – Multi-CD player
 - **TUNER** – Tuner
 - **TV** – Television
 - **iPod** – iPod
 - **AV** – AV input
 - **EXT-1** – External unit 1
 - **EXT-2** – External unit 2
 - **AUX** – AUX
 - **DAB** – Digital audio broadcasting
 - **NAVI** – Navigation unit
 - **OFF** – Turn the unit off
- When the source icon is not displayed, you can display it by touching the screen.
 - To return to the playback display, touch **ESC**.

● When using the buttons, press **SOURCE** to select a source.

Press **SOURCE** repeatedly to switch between the following sources:

DAB (digital audio broadcasting)—**TUNER** (tuner)—**TV** (television)—**AV** (AV)—**DVD** (built-in DVD player)—**S-DVD** (DVD player/multi-DVD player)—**M-CD** (multi-CD player)—**iPod** (iPod)—**EXT-1** (external unit 1)—**EXT-2** (external unit 2)—**AUX** (AUX)—**NAVI** (navigation unit)



Notes

- In the following cases, the sound source will not change:
 - When there is no unit corresponding to the selected source connected to this unit.
 - When there is no disc in the unit.
 - When there is no disc in the DVD player.
 - When there is no magazine in the multi-CD player.
 - When there is no magazine in the multi-DVD player.
 - When the AUX (auxiliary input) is set to off (refer to page 91).
 - When the AV (AV input) is not set to **VIDEO** (refer to page 95).
- External unit refers to a Pioneer product (such as one available in the future) that, although incompatible as a source, enables control of basic functions by this unit. Two external units can be controlled by this unit. When two external units are connected, the allocation of them to external unit 1 or external unit 2 is automatically set by this unit.
- When this unit's blue/white lead is connected to the vehicle's auto-antenna relay control terminal, the vehicle's antenna extends when this unit's source is turned on. To retract the antenna, turn the source off. When using with a Pioneer navigation unit, the car's antenna extends regardless of turning this unit on or off.

Loading a disc

● Insert a disc into the disc loading slot.

Playback will automatically start.

- When the automatic playback function is on, this unit will cancel the DVD menu and automatically start playback from the first chapter of the first title. Refer to *Automatic playback of DVDs* on page 35.
- To eject a disc, press **EJECT**.



Notes

- The DVD player plays one, standard, 12-cm or 8-cm (single) disc at a time. Do not use an adapter when playing 8-cm discs.
- Do not insert anything other than a disc into the disc loading slot. Discs which can be played back are listed on *Playable discs* on page 8.
- If you cannot insert a disc completely or if after you insert a disc the disc does not play, check that the label side of the disc is up. Press **EJECT** to eject the disc, and check the disc for damage before inserting it again.
- If an error message such as **ERROR-02** is displayed, refer to *Error messages* on page 102.
- If bookmark function is on, DVD playback resumes from the selected point. For more details, refer to *Resume playback (Bookmark)* on page 37. 

Adjusting the volume

● Use **VOLUME** to adjust the sound level.

Each press of **VOLUME** up/+ or down/- increases or decreases the source volume. 

Turning the unit off

● When using the touch panel keys, touch the source icon and then touch **OFF**.

- When the source icon is not displayed, you can display it by touching the screen.

● When using the buttons, press **SOURCE** and hold until the unit turns off.

Using the rear display

You can watch a DVD/Video CD/TV/AV on the rear display.

1 Press **A.MENU** button and touch **SETUP** to display the setup function names.

2 Touch **R.DISP** on the setup menu to display video of the selected source on rear display.

Touch **R.DISP** until **SOURCE** appears in the display.

- **SOURCE** – Display the video of the selected source on rear display
- **NAVI** – Display the navigation image or AVG-VDP1 on rear display



Note

When a Pioneer navigation unit or a Pioneer Vehicle Dynamics Processor (AVG-VDP1) is connected to this unit, the navigation or the AVG-VDP1 can be displayed on the rear display. (Refer to page 97.) 

Displaying the navigation image

You can display navigation map and navigation menu on this display.

Basic Operations

- You can operate these functions only when a Pioneer navigation unit is connected to this unit.

Displaying navigation map

- **Press WIDE to display navigation map.**
 - When the map is scrolled, pressing this button returns to the display of the map of your surroundings.

Displaying navigation menu

- **Press ENTERTAINMENT (ENT) to display navigation menu when the navigation map is displayed.**

Switching to the navigation image

- **Press V.ADJ to switch the display to navigation image.**
 - To return to the video of sources, press **V.ADJ** again. 

Displaying the AVG-VDP1 (Pioneer Vehicle Dynamics Processor)

This unit can be used as the display unit for the AVG-VDP1 (sold separately) product.

Displaying AVG-VDP1

- **Press V.ADJ to switch the display to the AVG-VDP1.**
 - To return to the video of sources, press **V.ADJ** again.



Note

You can also use **WIDE** and **ENTERTAINMENT (ENT)** buttons when you display the AVG-VDP1. For details concerning operation, refer to the AVG-VDP1 operation manual. 

Touch panel key basic operation

Activating the touch panel keys



① Touch panel keys

Touch to do various operations.

1 Touch the screen to activate the touch panel keys corresponding to each source.

The touch panel keys appear on the display.

- To go to the next group of touch panel keys, touch →.

2 Touch ESC to hide the touch panel keys.



Note

If you do not use the touch panel keys within 30 seconds, they will be hidden automatically.

Operating the menu

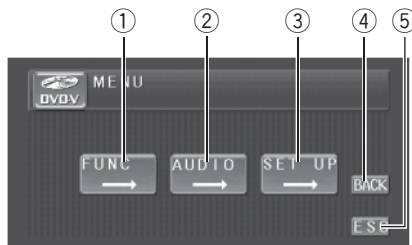

① FUNCTION key

Touch to select functions for each source.

② AUDIO key

Touch to select various sound quality controls.

③ SETUP key

Touch to select various setup functions.

④ BACK key

Touch to return to the previous display.

⑤ ESC key

Touch to cancel the control mode of functions.

1 Press A.MENU button to display MENU. MENU appears on the display.

2 Touch the desired key to display the function names you want to operate.

- To go to the next group of function names, touch **NEXT**.
- To return to the previous group of function names, touch **PREV**.

3 Touch ESC to return to the display of each source.

Basic Operations

Note

If you do not operate the function within about 30 seconds, the display is automatically returned to the playback display. 

Opening and closing the LCD panel

The LCD panel will be opened or closed automatically with the turning of the ignition switch on or off. You can turn off the automatic close/open function. (Refer to page 96.)

- Do not close the LCD panel with hands by force. That cause malfunction.
- The automatic close/open function will operate the display as follows.
 - When the ignition switch is turned OFF while the LCD panel is opened, the LCD panel will close after six seconds.
 - When the ignition switch is turned ON again (or turned to ACC), the LCD panel will be opened automatically.
 - Removing or attaching the front panel will automatically close or open the LCD panel. (Refer to page 21.)
- When the ignition switch is turned OFF after the LCD panel has been closed, turning the ignition switch ON again (or turning it to ACC) will not open the LCD panel. In this case, press **OPEN/CLOSE** to open the LCD panel.
- When closing the LCD panel, check to make sure that it has closed completely. If the LCD panel has stopped halfway, leaving it like this could result in damage.

● Press OPEN/CLOSE to open the LCD panel.

- To close the LCD panel, press **OPEN/CLOSE** again.

Adjusting the LCD panel angle

Important

- If you can hear the LCD panel knocking against your vehicle's console or dashboard, press **ANGLE (-)** to move the LCD panel a little forward.
- When adjusting the LCD panel angle, be sure to press **ANGLE (+/-)**. Forcibly adjusting the LCD panel by hand may damage it.

● Press ANGLE (+/-) to adjust the LCD panel to an easily viewable angle.

The LCD panel angle continues changing as long as you press **ANGLE (+/-)** and hold.

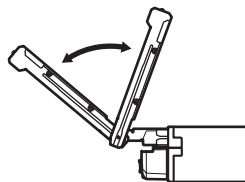

- The adjusted LCD panel angle will be memorized and automatically returned to the next time the LCD panel is opened.

Turning the LCD panel horizontal

When the LCD panel is upright and it hinders the operation of the air conditioner, the panel can be turned horizontal temporarily.

● Press FLIP DOWN to turn the LCD panel horizontal.

- To return to original position, press **FLIP DOWN** again.
- The LCD panel returns to the original position automatically with beeping sound 10 seconds after operation. 

Changing the wide screen mode

You can select a desired mode for enlarging a 4:3 picture to a 16:9 one.

● Press **WIDE** to select the desired setting.

Press **WIDE** repeatedly to switch between the following settings:

FULL (full)—**JUST** (just)—**CINEMA** (cinema)
—**ZOOM** (zoom)—**NORMAL** (normal)

▪ When a Pioneer navigation unit is connected to this unit, press **WIDE** and hold to select the desired setting. Press and hold **WIDE** repeatedly to switch between the settings.

FULL (full)

A 4:3 picture is enlarged in the horizontal direction only, giving you a 4:3 TV picture (normal picture) without any omissions.

JUST (just)

The picture is enlarged slightly at the center and the amount of enlargement increases horizontally to the ends, enabling you to enjoy a 4:3 picture without sensing any disparity even on a wide screen.

CINEMA (cinema)

The picture is enlarged by the same proportion as **FULL** or **ZOOM** in the horizontal direction and by an intermediate proportion between **FULL** and **ZOOM** in the vertical direction; ideal for a cinema-sized picture (wide screen picture) where captions lie outside.

ZOOM (zoom)

A 4:3 picture is enlarged in the same proportion both vertically and horizontally; ideal for a cinema-sized picture (wide screen picture).

NORMAL (normal)

A 4:3 picture is displayed as it is, giving you no sense of disparity since its proportions are the same as that of the normal picture.



Notes

- Different settings can be memorized for each video source.
- When video is viewed in a wide screen mode that does not match its original aspect ratio, it may appear different.
- Remember that using the wide mode feature of this system for commercial or public viewing purposes may constitute an infringement on the author's rights protected by the Copyright Law.
- Video will appear grainy when viewed in **CINEMA** or **ZOOM** mode.
- The navigation map and the rear view camera picture is always **FULL**.

Adjusting the picture adjustment

You can adjust **BRIGHT** (brightness), **CONTRAST** (contrast), **COLOR** (color) and **HUE** (hue) for each source and rear view camera.

- The adjustments of **BRIGHT** and **CONTRAST** are stored separately for light ambient (daytime) and dark ambient (nighttime). A sun ☀ or moon 🌙 is displayed to the left of **BRIGHT** and **CONTRAST**, respectively, as the ambient light sensor determines brightness or darkness.
- You cannot adjust **HUE** for PAL video.
- You cannot adjust **COLOR** or **HUE** for the audio source.

Basic Operations

1 Press V.ADJ and hold to display PICTURE ADJUST.

Press **V.ADJ** until **PICTURE ADJUST** appears in the display.

2 Touch any of the following touch panel keys to select the function to be adjusted.

The adjustment function names are displayed and adjustable ones are highlighted.

- **BRIGHT** – Adjust the black intensity
- **CONTRAST** – Adjust the contrast
- **COLOR** – Adjust the color saturation
- **HUE** – Adjust the tone of color (red is emphasized or green is emphasized)
- **DIMMER** – Adjust the brightness of display
- **BACK-CAMERA** – Switch to the picture adjustment display for the rear view camera
 - You can adjust the picture adjustment for rear view camera only when **B-CAM** is turned on. (Refer to *Setting for rear view camera* on page 95.)
 - With some rear view cameras, picture adjustment may not be possible.

3 Touch ◀ or ▶ to adjust the selected item.

Each time you touch ◀ or ▶ it increases or decreases the level of selected item. **+24** – **-24** is displayed as the level is increased or decreased.

4 Touch ESC to hide the touch panel keys.

Adjusting the dimmer

The adjustment of **DIMMER** is stored separately for each ambient light; daytime, evening and nighttime. The brightness of LCD screen will be adjusted to optimum level automatically in accordance with the ambient light based on the setting values.

1 Press V.ADJ and hold to display PICTURE ADJUST.

Press **V.ADJ** until **PICTURE ADJUST** appears in the display.

2 Touch DIMMER.

The ambient light level used as the standard for adjusting **DIMMER** appears above the level bar.

- Red sun ☀ – Adjust the brightness for bright ambient light (daytime)
- White sun ☼ – Adjust the brightness for intermediate brightness (evening)
- Blue moon 🌙 – Adjust the brightness for dark ambient light (nighttime)

3 Touch ◀ or ▶ to adjust the brightness.

Each time you touch ◀ or ▶ moves the key towards the left or the right.

The level indicates the brightness of the screen being adjusted. The farther the key moves to the right, the brighter the screen.

4 Touch ESC to hide the touch panel keys.



Note

The icons indicating the current ambient brightness used for adjusting **BRIGHT** and **CONTRAST** may differ from **DIMMER** slightly. □

Protecting your unit from theft

The front panel can be detached from the head unit to discourage theft.

- If the front panel is not detached from the head unit within five seconds of turning off the ignition, a warning tone will sound.
- You can turn off the warning tone. See *Switching the warning tone* on page 90.

Important

- Never use force or grip the display and the buttons too tightly when removing or attaching.
- Avoid subjecting the front panel to excessive shocks.
- Keep the front panel out of direct sunlight and high temperatures.
- If removed, replace the front panel on the unit before starting up your vehicle.

Removing the front panel

- **Push the release button downward and release the front panel.**

Take care not to grip it too tightly or to drop the front panel and protect it from contact with water or other fluids to prevent permanent damage.

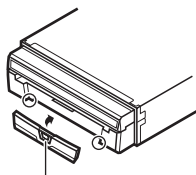

Release button

Attaching the front panel

- **Replace the front panel by holding it upright to the unit and clipping it securely into the mounting hook. ▢**

Tuner

Listening to the radio

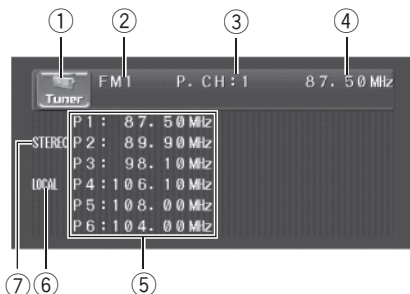

These are the basic steps necessary to operate the radio. More advanced tuner operation is explained starting on the next page.

This unit's AF (alternative frequencies search) function can be turned on and off. AF should be off for normal tuning operation (refer to page 27).

- ① **Source icon**
Shows which source has been selected.
- ② **Band indicator**
Shows which band the radio is tuned to, MW, LW or FM.
- ③ **Preset number indicator**
Shows which preset has been selected.
- ④ **Frequency indicator**
Shows to which frequency the tuner is tuned.
- ⑤ **Preset list display**
Shows the preset list.
- ⑥ **LOCAL indicator**
Shows when local seek tuning is on.

⑦ STEREO indicator

Shows that the frequency selected is being broadcast in stereo.

1 Touch the source icon and then touch TUNER to select the tuner.

2 Touch the screen to display the touch panel keys.

3 Touch BAND to select a band.

Touch **BAND** repeatedly until the desired band is displayed, **FM1**, **FM2**, **FM3** for FM or **MW/LW**.

4 To select a preset channel, touch a preset channel on the list.

The preset channel you selected is tuned in.

- When the list of channels is not displayed, touch **LIST**.

5 To perform manual tuning, briefly touch ◀ or ▶.

The frequencies move up or down step by step.

- You can also perform manual tuning by pressing ◀ or ▶ button.

6 To perform seek tuning, keep touching ◀ or ▶ for about one second and release.

The tuner will scan the frequencies until a broadcast strong enough for good reception is found.

- You can cancel seek tuning by briefly touching either ◀ or ▶.
- If you keep touching ◀ or ▶ you can skip stations. Seek tuning starts as soon as you release the key.
- You can also perform seek tuning by pressing and holding ◀ or ▶ button.



Note

If you do not use the touch panel keys within 30 seconds, they will be hidden automatically. ▣

Storing and recalling broadcast frequencies

If you touch any of the preset tuning keys **P1—P6** you can easily store up to six broadcast frequencies for later recall with the touch of a key.

- **When you find a frequency that you want to store in memory keep touching one of preset tuning keys P1—P6 until the preset number stops flashing.**

The number you have touched will flash in the preset number indicator and then remain lit. The selected radio station frequency has been stored in memory.

The next time you touch the same preset tuning key the radio station frequency is recalled from memory.

- When the touch panel keys are not displayed, you can display them by touching the screen.
- When **P1—P6** are not displayed, you can display them by touching **LIST**.



Notes

- Up to 18 FM stations, six for each of the three FM bands, and six MW/LW stations can be stored in memory.
- You can also use **▲** and **▼** buttons to recall radio station frequencies assigned to preset tuning keys **P1—P6**. 

Introduction of advanced tuner operation

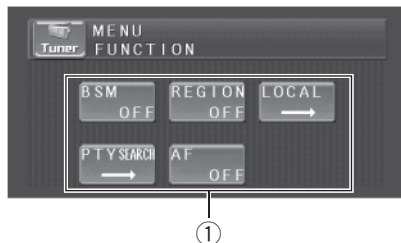

① Function display

Shows the function names.

- 1 Press A.MENU button to display MENU.** **MENU** appears on the display.

- 2 Touch FUNCTION to display the function names.**

The function names are displayed and operable ones are highlighted.

- To return to the previous display, touch **BACK**.
- To return to the frequency display, touch **ESC**.



Note

If you do not operate the function within about 30 seconds, the display is automatically returned to the frequency display. 

Tuning in strong signals

Local seek tuning lets you tune in only those radio stations with sufficiently strong signals for good reception.

- 1 Touch LOCAL on the function menu.**

- 2 Touch ▲ to turn local seek tuning on.**
 - To turn local seek tuning off, touch **▼**.

3 Touch ◀ or ▶ to set the sensitivity.

There are four levels of sensitivity for FM and two levels for MW/LW:

FM: **1—2—3—4**

MW/LW: **1—2**

The **4** setting allows reception of only the strongest stations, while lower settings let you receive progressively weaker stations. 

Storing the strongest broadcast frequencies

BSM (best stations memory) lets you automatically store the six strongest broadcast frequencies under preset tuning keys **P1—P6** and once stored there you can tune in to those frequencies with the touch of a key.

● Touch **BSM** on the function menu to turn **BSM** on.

BSM begins to flash. While **BSM** is flashing the six strongest broadcast frequencies will be stored under preset tuning keys **P1—P6** in order of their signal strength. When finished, **BSM** stops flashing.

- To cancel the storage process, touch **BSM** again.



Note

Storing broadcast frequencies with BSM may replace broadcast frequencies you have saved using **P1—P6**. 

Introduction of RDS operation

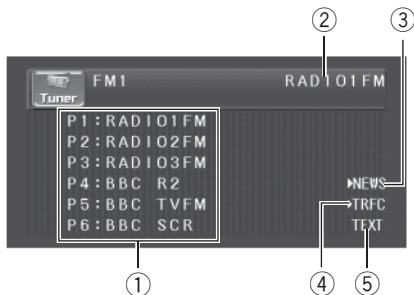

RDS (radio data system) is a system for providing information along with FM broadcasts. This inaudible information provides such features as program service name, program type, traffic announcement standby and automatic tuning, intended to aid radio listeners in finding and is tuning in to a desired station.

① Preset station list

Shows the preset number and the name of broadcast program (program service name).

- If the signal is too weak for this unit to pick up the program service name information, broadcast frequency will be displayed.

② Program service name

Shows the name of broadcast program.

③ NEWS indicator

Shows when the set news program is received.

④ TRFC indicator

Shows when a TP station is tuned in.

⑤ TEXT indicator

Shows when the radio text is received.

1 Press A.MENU button to display MENU. MENU appears on the display.

2 Touch FUNCTION to display the function names.

The function names are displayed and operable ones are highlighted.

- To return to the previous display, touch **BACK**.
- To return to the frequency display, touch **ESC**.



Notes

- If you do not operate the function within about 30 seconds, the display is automatically returned to the frequency display.
- RDS service may not be provided by all stations.
- RDS functions such as AF and TA are only active when your radio is tuned to an RDS station.

Switching the RDS display

When you tune in an RDS station its program service name is displayed on the information bar. If you want to know the frequency you can.

● Touch DISP.

Touch **DISP** repeatedly to switch between the following settings:

PTY (PTY information)—frequency

PTY (program type ID code) information is listed on page 30.

- If a PTY code of zero is received from a station or the signal is too weak for this unit to pick up the PTY code, you cannot switch to PTY information display. In this case, if you have selected the PTY information display, the display will be changed to blank.

Selecting alternative frequencies

If you are listening to a broadcast and the reception becomes weak or there are other problems, the unit will automatically search for a different station in the same network which is broadcasting a stronger signal.

- AF is on as a default.
- **Touch AF on the function menu to turn AF on.**
 - To turn AF off, touch **AF** again.



Notes

- Only RDS stations are tuned in during seek tuning or BSM when AF is on.
- When you recall a preset station, the tuner may update the preset station with a new frequency from the station's AF list. (This is only available when using presets on the **FM1** or **FM2** bands.) No preset number appears on the display if the RDS data for the station received differs from that for the originally stored station.
- Sound may be temporarily interrupted by another program during an AF frequency search.
- AF can be turned on or off independently for each FM band.

Using PI Seek

If the unit fails to find a suitable alternative frequency, or if you are listening to a broadcast and the reception becomes weak, the unit will automatically search for a different station with the same programming. During the search, **PI SEEK** is displayed and the output is muted. The muting is discontinued after completion of the PI Seek, whether or not a different station is found.

Using Auto PI Seek for preset stations

When preset stations cannot be recalled, as when travelling long distances, the unit can be set to perform PI Seek during preset recall.

- The default setting for Auto PI Seek is off. See *Switching Auto PI Seek* on page 90.

Limiting stations to regional programming

When AF is used to automatically retune frequencies, the regional function limits the selection to stations broadcasting regional programs.

- **Touch REGION on the function menu to turn regional function on.**
 - To turn the regional function off, touch **REGION** again.



Notes

- Regional programming and regional networks are organized differently depending on the country (i.e., they may change according to the hour, state or broadcast area).
- The preset number may disappear on the display if the tuner tunes in a regional station which differs from the originally set station.
- The regional function can be turned on or off independently for each FM band. 

Receiving traffic announcements

TA (traffic announcement standby) lets you receive traffic announcements automatically, no matter what source you are listening to. TA can be activated for both a TP station (a station that broadcasts traffic information) or an enhanced other network's TP station (a station carrying information which cross-references TP stations).

1 Tune in a TP or enhanced other network's TP station.

When you are tuned into a TP or enhanced other network's TP station the **TRFC** indicator will light.

2 Press TA/NEWS button to turn traffic announcement standby on.

► **TRFC** appears in the display. The tuner will stand by for traffic announcements.

- If you turned TA function on while tuned in to neither a TP nor an enhanced other network's TP station, only **T** in the **TRFC** indicator lights.
- To turn traffic announcements standby off, press **TA/NEWS** again.

3 Use VOLUME to adjust the TA volume when a traffic announcement begins.

The newly set volume is stored in memory and recalled for subsequent traffic announcements.

4 Press TA/NEWS while a traffic announcement is being received to cancel the announcement.

The tuner returns to the original source but remains in the standby mode until **TA/NEWS** is pressed again.

- You can also cancel the announcement by pressing **SOURCE**, **BAND/ESC**, **▲**, **▼**, **◀** or **▶** while a traffic announcement is being received.



Notes

- The system switches back to the original source following traffic announcement reception.
- Only TP and enhanced other network's TP stations are tuned in during seek tuning or BSM when TA is on. 

Using PTY functions

You can tune in a station by using PTY (program type) information.

Searching for an RDS station by PTY information

You can search for general types of broadcasting programs, such as those listed on page 30.

1 Touch PTY on the function menu.

2 Touch ◀ or ▶ to select a program type.

There are four program types:

News&Inf—Popular—Classics—Others

3 Touch ▲ to begin the search.

When you touch **▲** the program type name in the display begins to flash. The unit searches for a station broadcasting that program type.

- To cancel the search, touch **▼**.



Notes

- The program of some stations may differ from that indicated by the transmitted PTY.
- If no station is broadcasting the type of program you searched for, **NOT FOUND** is displayed for about two seconds and then the tuner returns to the original station.

Using news program interruption

When a news program is broadcast from a PTY code news station the unit can switch from any station to the news broadcast station. When the news program ends, reception of the previous program resumes.

● Press TA/NEWS button and hold to turn on news program interruption.

Press **TA/NEWS** until **►NEWS** or **N** appears in the display.

- To turn off news program interruption, press **TA/NEWS** and hold again.
- A news program can be canceled by pressing **TA/NEWS**.
- You can also cancel the news program by pressing **SOURCE**, **BAND/ESC**, **▲**, **▼**, **◀** or **▶** while a news program is being received.

Receiving PTY alarm broadcasts

PTY alarm is a special PTY code for announcements regarding emergencies such as natural disasters. When the tuner receives the radio alarm code, **ALARM** appears on the display and the volume adjusts to the TA volume. When the station stops broadcasting the emergency announcement, the system returns to the previous source.

- An emergency announcement can be canceled by pressing **TA/NEWS**.
- You can also cancel an emergency announcement by pressing **SOURCE** or **BAND/ESC** button. 

Using radio text

This tuner can display radio text data transmitted by RDS stations, such as station information, the name of the currently broadcast song and the name of the artist.

- The tuner automatically memorizes the three latest radio text broadcasts received, replacing text from the least recent reception with new text when it is received.

Displaying radio text



You can display the currently received radio text and the three most recent radio texts.

1 Touch TEXT to display radio text.

Radio text for the currently broadcasting station is displayed.

- You can cancel radio text display by touching **ESC** or pressing **BAND/ESC**.
- When no radio text is received, **NO TEXT** is displayed.

2 Touch or to recall the three most recent radio texts.

Touching  or  switches between the three radio text data displays.

- If there is no radio text data in memory the display will not change.

Storing and recalling radio text

You can store data from up to six radio text transmissions at **1–6** keys.

1 Display the radio text you want to store in memory.

Refer to *Displaying radio text* on this page.

2 Touch any of 1–6 and hold to store the selected radio text.

The memory number will display and the selected radio text will be stored in memory.

The next time you touch the same number in the radio text display the stored text is recalled from memory. 

PTY list

General	Specific	Type of program
News&Inf	News	News
	Affairs	Current affairs
	Info	General information and advice
	Sport	Sports
	Weather	Weather reports/meteorological information
	Finance	Stock market reports, commerce, trading, etc.
Popular	Pop Mus	Popular music
	Rock Mus	Contemporary modern music
	Easy Mus	Easy listening music
	Oth Mus	Non-categorized music
	Jazz	Jazz
	Country	Country music
	Nat Mus	National music
	Oldies	Oldies music, golden oldies
	Folk Mus	Folk music
Classics	L. Class	Light classical music
	Classic	Serious classical music
Others	Educate	Educational programs
	Drama	All radio plays and serials
	Culture	National or regional culture
	Science	Nature, science and technology
	Varied	Light entertainment
	Children	Children's
	Social	Social affairs
	Religion	Religious affairs or services
	Phone In	Phone In
	Touring	Travel programs, not for announcements about traffic problems
	Leisure	Hobbies and recreational activities
Document	Documentaries	



Playing DVD video discs

Watching a DVD video

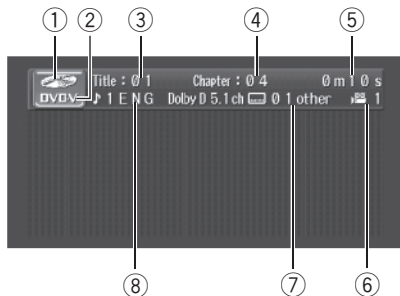

These are the basic steps necessary to play a DVD video with your DVD player. More advanced DVD video operation is explained starting on page 36.

- ① **Source icon**
Shows which source has been selected.
- ② **DVD-V indicator**
Shows when a DVD video is playing.
- ③ **Title number indicator**
Shows the title currently playing.
- ④ **Chapter number indicator**
Shows the chapter currently playing.
- ⑤ **Play time indicator**
Shows the elapsed playing time of the current chapter.
- ⑥ **Viewing angle indicator**
Shows which viewing angle has been selected.
- ⑦ **Subtitle language indicator**
Shows which subtitle language has been selected.

⑧ **Audio language indicator**

Shows which audio language has been selected.

1 **Touch the source icon and then touch DVD to select the DVD player.**

- When the source icon is not displayed, you can display it by touching the screen.
- If no disc is loaded in the unit, you cannot select **DVD** (DVD player). Insert a disc in the unit. (Refer to page 16.)
- With some discs, a menu may be displayed. (Refer to *Operating the DVD menu* on the next page.)

2 **Touch the screen to display the touch panel keys.**

3 **To skip back or forward to another chapter, touch I◀◀ or ▶▶I.**

Touching ▶▶I skips to the start of the next chapter. Touching I◀◀ once skips to the start of the current chapter. Touching it again will skip to the previous chapter. Chapter numbers are displayed for eight seconds.

- You can also skip back or forward to another chapter by pressing ◀ or ▶ button.

4 **To perform fast forward or reverse, keep touching I◀◀ or ▶▶I.**

If you keep touching I◀◀ or ▶▶I for five seconds, the icon I◀◀ or ▶▶I changes into reversal indication. When this happens, fast reverse/fast forward continues even if you release I◀◀ or ▶▶I. To resume playback at a desired point, touch ▶/II.

- You can also perform fast reverse/fast forward by pressing and holding ◀ or ▶ button.
- Fast forward/fast reverse may not be possible at certain locations on some discs. If this happens, normal playback automatically resumes.

**Note**

If you do not use the touch panel keys within 30 seconds, they will be hidden automatically.

Operating the DVD menu

Some DVDs allow you to select from the disc contents using a menu.

- You can display the menu by touching **MENU** or **TOP.M** while a disc is playing. Touching either of these keys again lets you start playback from the location selected from the menu. For details, refer to the instructions provided with the disc.

1 Touch **◀▶** to display touch panel keys to operate the DVD menu.

- When the touch panel keys are not displayed, you can display them by touching the screen.

2 Touch **▲, ▼, ◀** or **▶** to select the desired menu item.

3 Touch **ENTER**.

Playback starts from the selected menu item.

- You cannot operate the DVD menu from **▲/▼/◀/▶** buttons on the head unit.
- The way to display the menu differs depending on the disc.

Operating the DVD menu with 10 key

Some DVDs allow you to select from the disc contents using **10key**.

1 Touch **→** until **10key** appears in the display.

2 Touch **10key**.



3 Touch **0-9** corresponding to a menu number and then touch **ENTER** to start playback.

- To select 3, touch **3**.
- To select 10, touch **1** and **0** in that order.
- To select 23, touch **2** and **3** in that order.

Skipping back or forward to another title

● To skip back or forward to another title, touch **▲** or **▼**.

Touching **▲** skips to the start of the next title. Touching **▼** skips to the start of the previous title.

Title numbers are displayed for eight seconds.

- You can also skip back or forward to another title by pressing **▲** or **▼** button.

Stopping playback

● Touch **■**.

- When you stop DVD playback by touching **■**, that location on the disc is memorized, enabling playback from that point when you play the disc again.
- To play back the disc again, touch **▶/II**.

Pausing DVD video playback

Pause lets you temporarily stop disc playback.



● Touch **▶/II** during playback.

The icon **II** is displayed and playback is paused, letting you view a still image.

- To resume playback at the same point that you turned pause on, touch **▶/II** again.

Playing DVD video discs

Note

Depending on the disc and the playback location on the disc, the icon  may be displayed, indicating that still playback is not possible. 

Frame-by-frame playback



This lets you move ahead one frame at a time during playback.

● Touch **II▶** during playback.

Each time you touch **II▶**, you move ahead one frame.

- To return to normal playback, touch **▶/II**.

Notes

- Depending on the disc and the playback location on the disc, the icon  may be displayed, indicating that frame-by-frame playback is not possible.
- With some discs, images may be unclear during frame-by-frame playback. 

Slow motion playback

This lets you slow down playback speed.

1 Keep touching **II▶** until **■■■■▶** is displayed during playback.

The icon **■■■■▶** is displayed, forward slow motion playback begins.



- To return to normal playback, touch **▶/II**.

2 Touch **◀II** or **II▶** to adjust playback speed during slow motion playback.

Each time you touch **◀II** or **II▶** it changes the speed in four steps in the following order:

1/16—1/8—1/4—1/2

Notes

- There is no sound during slow motion playback.
- Depending on the disc and the playback location on the disc, the icon  may be displayed, indicating that slow motion playback is not possible.
- With some discs, images may be unclear during slow motion playback.
- Reverse slow motion playback is not possible. 

Searching for a desired scene, starting playback from a specified time

You can use the search function to search for a desired scene by specifying a title or chapter, and the time search function to specify the time on a disc at which play starts.

- Chapter search and time search are not possible when disc playback has been stopped.

1 Touch **→ until SEARCH appears in the display.**

2 Touch SEARCH.

3 Touch TITLE (title), CHAP. (chapter) or TIME (time).

4 Touch 0—9 to input the desired number.

For titles and chapters

- To select 3, touch **3**.
- To select 10, touch **1** and **0** in that order.
- To select 23, touch **2** and **3** in that order.

For time (time search)

- To select 21 minutes 43 seconds, touch **2**, **1**, **4** and **3** in that order.

Playing DVD video discs

- To select 1 hour 11 minutes, convert the time into 71 minutes 00 seconds and touch **7**, **1**, **0** and **0** in that order.
- To cancel the inputted numbers, touch **C**.

5 While the inputted number is displayed, touch ENTER.

This starts playback from the selected scene.



Notes

- With discs featuring a menu, you can also touch **MENU** or **TOP.M** and then make selections from the displayed menu.
- With some discs, the icon  may be displayed, indicating that titles, chapters and time cannot be specified.

Specifying title

You can use the direct search function to search for a desired scene by specifying a title.

1 Touch → until 10key appears in the display.

2 Touch 10key.

3 Touch 0-9 corresponding to a desired title number when the disc is stopped.

Title number is displayed for eight seconds and playback starts from the selected title.

- To select 3, touch **3**.
- To select 10, touch **1** and **0** in that order.
- To select 23, touch **2** and **3** in that order. 

Changing audio language during playback (Multi-audio)

DVDs can provide audio playback with different languages and different systems (Dolby Digital, DTS etc.). With DVDs featuring multi-

audio recordings, you can switch between languages/audio systems during playback.



1 Touch → until AUDIO appears in the display.

2 Touch AUDIO during playback.

Each time you touch **AUDIO** it switches between audio systems.



Notes

- The number in the  mark on a DVD's package indicates the number of recorded languages/audio systems.
- With some DVDs, switching between languages/audio systems may only be possible using a menu display.
- You can also switch between languages/audio systems using **DVD SETUP**. For details, refer to *Setting the audio language* on page 87.
- Only digital output of DTS audio is possible. If this unit's optical digital outputs are not connected, DTS audio will not be output, so select an audio setting other than DTS.
- Display indications such as **Dolby D** and **5.1ch** indicate the audio system recorded on the DVD. Depending on the setting, playback may not be with the same audio system as that indicated.
- Touching **AUDIO** during fast forward/fast reverse, pause or slow motion playback returns you to normal playback. 

Playing DVD video discs

Changing the subtitle language during playback (Multi-subtitle)

With DVDs featuring multi-subtitle recordings, you can switch between subtitle languages during playback.



1 Touch → until SUB.T appears in the display.

2 Touch SUB.T during playback.

Each time you touch **SUB.T** it switches between subtitle languages.



Notes

- The number in the  mark on a DVD's package indicates the number of recorded subtitle languages.
- With some DVDs, switching between subtitle languages may only be possible using a menu display.
- You can also switch between subtitle languages using **DVD SETUP**. For details, refer to *Setting the subtitle language* on page 86.
- Touching **SUB.T** during fast forward/fast reverse, pause or slow motion playback returns you to normal playback. .

Changing the viewing angle during playback (Multi-angle)

With DVDs featuring multi-angle (scenes shot from multiple angles) recordings, you can switch among viewing angles during playback.

- During playback of a scene shot from multiple angles, the angle icon  is displayed. Turn angle icon display on or off using **DVD SETUP**. For details, refer to *Setting angle icon display* on page 87.



1 Touch → until ANGLE appears in the display.

2 Touch ANGLE during playback of a scene shot from multiple angles.

Each time you touch **ANGLE** it switches between angles.



Notes

- The  mark on a DVD's package indicates it features multi-angle scenes. The number in the  mark indicates the number of angles from which scenes were shot.
- Touching **ANGLE** during fast forward/fast reverse, pause or slow motion playback returns you to normal playback. .

Return to the specified scene

You can return to the specified scene where the DVD you are currently playing has been preprogrammed in production to return.

1 Touch → until RETURN appears in the display.

2 Touch RETURN to return to the specified scene.



Note

If a DVD disc has not been preprogrammed to return to a specified scene, this function is not possible. .

Automatic playback of DVDs

When a DVD disc with DVD menu is inserted, this unit will cancel the DVD menu automatically and start playback from the first chapter of the first title.

- Some DVDs may not operate properly. If this function is not fully operated, turn this function off and start playback.

1 Touch → until **A.PLAY** appears in the display.

2 Touch **A.PLAY** to turn automatic playback on.

- To turn automatic playback off, touch **A.PLAY** again.
- When the automatic playback is on, you cannot operate repeating play of DVD disc (refer to *Repeating play* on this page). □

Introduction of advanced DVD video operation

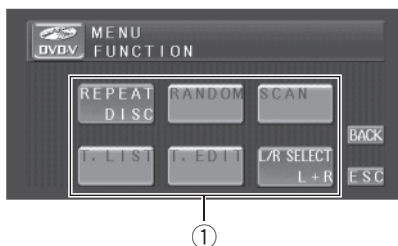

① Function display

Shows the function names.

1 Press **A.MENU** button to display **MENU**. **MENU** appears on the display.

2 Touch **FUNCTION** to display the function names.

The function names are displayed and operable ones are highlighted.

- To return to the previous display, touch **BACK**.
- To return to the playback display, touch **ESC**.



Note

If you do not operate the function within about 30 seconds, the display is automatically returned to the playback display. □

Repeating play

There are two repeat play ranges for the DVD playback: **TITLE** (title repeat) and **CHPTR** (chapter repeat).

● Touch **REPEAT** on the function menu to select the repeat range.

- **TITLE** – Repeat just the current title
- **CHPTR** – Repeat just the current chapter

Playing DVD video discs

- **DISC** – Play through the current disc

Note

If you perform chapter search or fast forward/reverse, the repeat play range changes to **DISC**. 

Selecting audio output

You can switch between stereo and monaural audio output.

- This function is not possible when disc playback has been stopped.

1 Press A.MENU button to display MENU.

2 Touch FUNCTION to display the function names.

3 Touch L/R SELECT to select the audio output.

- **L+R** – left and right
- **LEFT** – left
- **RIGHT** – right

Note

Depending on the disc and the playback location on the disc, the function name may not be selectable, indicating that operating this function is not possible. 

Resume playback (Bookmark)

The Bookmark function lets you resume playback from a selected scene the next time the disc is loaded.

- **During playback, press BOOKMARK (BM) button at the point you want to resume playback next time.**

The selected scene will be bookmarked so that playback resumes from that point next time. You can bookmark up to five discs. After that, the oldest bookmark is replaced by the new one.

- To clear the bookmark on a disc, press and hold **BOOKMARK (BM)** button during playback.
- You can also bookmark a disc by pressing and holding **EJECT** at the point you want to bookmark. Next time you load the disc, playback will resume from the bookmarked point. Note that you can only bookmark one disc using this method. To clear the bookmark on a disc, press **EJECT**. 

Watching a Video CD

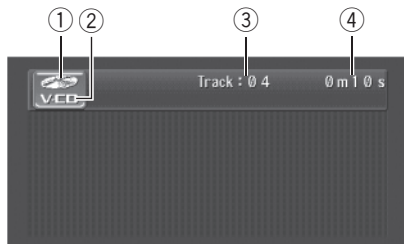

These are the basic steps necessary to play a Video CD with your DVD player. More advanced Video CD operation is explained starting on page 41.

① **Source icon**
Shows which source has been selected.

② **Video CD indicator**
Shows when a Video CD is playing.

③ **Track number indicator**
Shows the track currently playing.

④ **Play time indicator**
Shows the elapsed playing time of the current track.

1 Touch the source icon and then touch DVD to select the DVD player.

- When the source icon is not displayed, you can display it by touching the screen.
- If no disc is loaded in the unit, you cannot select **DVD** (DVD player). Insert a disc in the unit. (Refer to page 16.)
- With a Video CD featuring the PBC (playback control) function, a menu is displayed.

2 Touch the screen to display the touch panel keys.

3 Touch 10key and then touch 0-9 to select the desired menu item.

Playback starts from the selected menu item.

- When the menu is two or more pages long, touch **I◀◀** or **▶▶I** to switch between displays.
- You can display the menu by pressing **RETURN** during PBC playback. For details, refer to the instructions provided with the disc.

4 To skip back or forward to another track, touch I◀◀ or ▶▶I.

Touching **▶▶I** skips to the start of the next track. Touching **I◀◀** once skips to the start of the current track. Touching it again will skip to the previous track.

Track numbers are displayed for eight seconds.

- You can also skip back or forward to another track by pressing **◀** or **▶** button.
- During PBC playback, a menu may be displayed if you perform these operations.

5 To perform fast forward or reverse, keep touching I◀◀ or ▶▶I.

If you keep touching **I◀◀** or **▶▶I** for five seconds, the icon **I◀◀** or **▶▶I** changes into reversal indication. When this happens, fast reverse/fast forward continues even if you release **I◀◀** or **▶▶I**. To resume playback at a desired point, touch **▶/II**.

- You can also perform fast reverse/fast forward by pressing and holding **◀** or **▶** button.
- Fast forward/fast reverse may not be possible at certain locations on some discs. If this happens, normal playback automatically resumes.



Note

If you do not use the touch panel keys within 30 seconds, they will be hidden automatically. 

Playing Video CDs

Stopping playback

- **Touch ■.**
 - When you stop Video CD playback (during PBC playback only) by touching ■, that location on the disc is memorized, enabling playback from that point when you play the disc again.
 - To play back the disc again, touch ►/II. □

Pausing Video CD playback

Pause lets you temporarily stop disc playback.

- **Touch ►/II during playback.**
The icon II is displayed and playback is paused, letting you view a still image.
 - To resume playback at the same point that you turned pause on, touch ►/II again.

Note

Depending on the disc and the playback location on the disc, the icon Ⓞ may be displayed, indicating that still playback is not possible. □

Frame-by-frame playback

This lets you move ahead one frame at a time during playback.

- **Touch II► during playback.**
Each time you touch II►, you move ahead one frame.
 - To return to normal playback, touch ►/II.

Notes

- Depending on the disc and the playback location on the disc, the icon Ⓞ may be displayed, indicating that frame-by-frame playback is not possible.
- With some discs, images may be unclear during frame-by-frame playback. □

Slow motion playback

This lets you slow down playback speed.

1 Keep touching II► until ◀II► is displayed during playback.

The icon ◀II► is displayed, forward slow motion playback begins.

- To return to normal playback, touch ►/II.

2 Touch ◀II or II► to adjust playback speed during slow motion playback.

Each time you touch ◀II or II► it changes the speed in four steps in the following order: 1/16—1/8—1/4—1/2

Notes

- There is no sound during slow motion playback.
- Depending on the disc and the playback location on the disc, the icon Ⓞ may be displayed, indicating that slow motion playback is not possible.
- With some discs, images may be unclear during slow motion playback.
- Reverse slow motion playback is not possible. □

Searching for a desired scene, starting playback from a specified time

You can use the search function to search for a desired scene by specifying a track, and the time search function to specify the time on a disc at which play starts.

- During playback of Video CDs featuring PBC (playback control), this function cannot be operated.
- Time search is not possible when disc playback has been stopped.

1 Touch → until SEARCH appears in the display.

2 Touch SEARCH.

3 Touch TRACK (track) or TIME (time).

4 Touch 0—9 to input the desired number.

For tracks

- To select 3, touch **3**.
- To select 10, touch **1** and **0** in that order.
- To select 23, touch **2** and **3** in that order.

For time (time search)

- To select 21 minutes 43 seconds, touch **2**, **1**, **4** and **3** in that order.
- To select 1 hour 11 minutes, convert the time into 71 minutes 00 seconds and touch **7**, **1**, **0** and **0** in that order.
- To cancel the inputted numbers, touch **C**.

5 While the inputted number is displayed, touch ENTER.

This starts playback from the selected scene. 

PBC playback

During playback of Video CDs featuring PBC (Playback Control), **PBC ON** is displayed. You can operate PBC menu with **10key**.

1 Touch → until 10key appears in the display and then touch 10key.

2 Touch 0-9 corresponding to a menu number and then touch ENTER to start playback.

- To select 3, touch **3**.
- To select 10, touch **1** and **0** in that order.
- To select 23, touch **2** and **3** in that order.
- When the menu is two or more pages long, touch **◀◀** or **▶▶** to switch between displays.

- You can display the menu by touching **RETURN** during PBC playback. For details, refer to the instructions provided with the disc.



Notes

- PBC playback of Video-CD cannot be cancelled.
- During playback of Video CDs featuring PBC (Playback Control), **PBC ON**, search and time search functions cannot be used nor can you select the range for repeat play. 

Playing Video CDs

Introduction of advanced Video CD operation

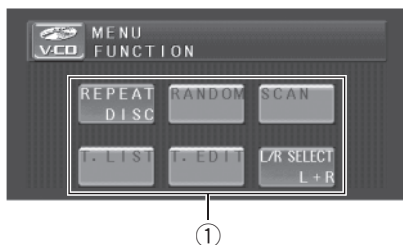

① Function display

Shows the function names.

1 Press A.MENU button to display MENU.

MENU appears on the display.

2 Touch FUNCTION to display the function names.

The function names are displayed and operable ones are highlighted.

- To return to the previous display, touch **BACK**.
- To return to the playback display, touch **ESC**.



Note

If you do not operate the function within about 30 seconds, the display is automatically returned to the playback display. 

Repeating play

There are two repeat play ranges for the Video CD playback: **TRACK** (track repeat) and **DISC** (disc repeat).

- During playback of Video CDs featuring PBC (playback control), this function cannot be operated.

- Touch **REPEAT** on the function menu to select the repeat range.

- **TRACK** – Repeat just the current track
- **DISC** – Repeat the current disc



Note

If you perform track search or fast forward/reverse, the repeat play range changes to **DISC**. 

Selecting audio output

You can switch between stereo and monaural audio output.

- This function is not possible when disc playback has been stopped.

- Touch **L/R SELECT** on the function menu to select the audio output.

- **L+R** – left and right
- **LEFT** – left
- **RIGHT** – right



Note

Depending on the disc and the playback location on the disc, the function name may not be selectable, indicating that operating this function is not possible. 

Listening to a CD

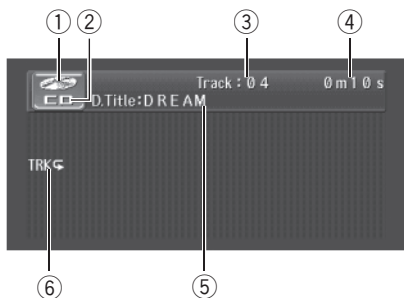

These are the basic steps necessary to play a CD with your DVD player. More advanced CD operation is explained starting on page 44.

① Source icon

Shows which source has been selected.

② CD indicator

Shows when a CD is playing.

③ Track number indicator

Shows the track currently playing.

④ Play time indicator

Shows the elapsed playing time of the current track.

⑤ Disc title indicator

Shows the title of the currently playing disc.

⑥ Repeat indicator

Shows when repeat range is selected to current track.

1 Touch the source icon and then touch DVD to select the DVD player.

- When the source icon is not displayed, you can display it by touching the screen.

- If no disc is loaded in the unit, you cannot select **DVD** (DVD player). Insert a disc in the unit. (Refer to page 16.)

2 Touch the screen to display the touch panel keys.

3 To skip back or forward to another track, touch \leftarrow or \rightarrow .

Touching \rightarrow skips to the start of the next track. Touching \leftarrow once skips to the start of the current track. Touching it again will skip to the previous track.

- You can also skip back or forward to another track by pressing \leftarrow or \rightarrow button.

4 To perform fast forward or reverse, keep touching \leftarrow or \rightarrow .

- You can also perform fast reverse/fast forward by pressing and holding \leftarrow or \rightarrow button.



Notes

- When playing discs with MP3/WMA files and audio data (CD-DA) such as CD-EXTRA and MIXED-MODE CDs, both types can be played only by switching mode between MP3/WMA and CD-DA by touching **MEDIA** or pressing **BAND/ESC**. This function can be operated only when the disc is playing.
- If you do not use the touch panel keys within 30 seconds, they will be hidden automatically.

Stopping playback

● Touch

- When you stop CD playback by touching , that location on the disc is memorized, enabling playback from that point when you play the disc again.

- To play back the disc again, touch \rightarrow /

Playing CDs

Pausing CD playback

Pause lets you temporarily stop disc playback.

- **Touch ►/|| during playback.**

PAUSE appears in the display. Play of the current track pauses.

- To resume playback at the same point that you turned pause on, touch ►/|| again.

Searching for a desired track

You can use the search function to specify a track to search for a desired track.

- 1 **Touch SEARCH.**

- 2 **Touch 0—9 to input the desired number.**

- To select 3, touch **3**.
- To select 10, touch **1** and **0** in that order.
- To select 23, touch **2** and **3** in that order.
- To cancel the inputted numbers, touch **C**.

- 3 **While the inputted number is displayed, touch ENTER.**

This starts playback from the selected track.

Using CD TEXT functions

Some discs have certain information encoded on the disc during manufacture. These discs may contain such information as the CD title, track title, artist's name and playback time and are called CD TEXT discs. Only these specially encoded CD TEXT discs support the functions listed below.

Displaying titles on CD TEXT discs

- **Touch DISP.**

Touch **DISP** repeatedly to switch between the following settings:

D.Title (disc title)—**D.Artist** (disc artist name)

—**T.Title** (track title)—**T.Artist** (track artist name)

- If specific information has not been recorded on a CD TEXT disc, **NO XXXX** will be displayed (e.g., **NO T.ARTIST NAME**).

Scrolling titles in the display

This unit can display the first 19 letters only of **D.Title**, **D.Artist**, **T.Title** and **T.Artist**. When the recorded information is longer than 19 letters, you can scroll the text to the left so that the rest of the title can be seen.

- **Keep touching DISP until the title begins to scroll to the left.**

The rest of the title will appear in the display.

Introduction of advanced CD operation

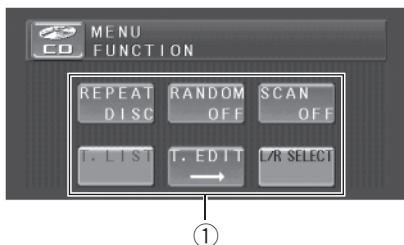

① Function display

Shows the function names.

1 Press A.MENU button to display MENU. MENU appears on the display.

2 Touch FUNCTION to display the function names.

The function names are displayed and operable ones are highlighted.

- To return to the previous display, touch **BACK**.
- To return to the playback display, touch **ESC**.

Note

If you do not operate the function within about 30 seconds, the display is automatically returned to the playback display. 

Repeating play

Repeat play lets you hear the same track over again.

● **Touch REPEAT on the function menu to select the repeat range.**

- **TRACK** – Repeat just the current track
- **DISC** – Repeat the current disc

Notes

- If you perform track search or fast forward/reverse, repeat play is automatically cancelled.
- When playing discs with MP3/WMA files and audio data (CD-DA), repeat play performs within the currently playing data type even if **DISC** is selected. 

Playing tracks in a random order

Random play lets you play back tracks on the CD in a random order.

● **Touch RANDOM on the function menu to turn random play on.**

Tracks will play in a random order.

- To turn random play off, touch **RANDOM** again. 

Scanning tracks of a CD

Scan play lets you hear the first 10 seconds of each track on the CD.

1 Touch SCAN on the function menu to turn scan play on.

The first 10 seconds of each track is played.

2 When you find the desired track touch SCAN again.

Note

After scanning of a CD is finished, normal playback of the tracks will begin again. 

Playing CDs

Entering disc titles

You can input CD titles and display the title. The next time you insert a CD for which you have entered a title, the title of that CD will be displayed.

Use the disc title input feature to store up to 48 CD titles in the unit. Each title can be up to 10 characters long.

- When playing a CD TEXT disc, you cannot switch to **T. EDIT**. The disc title will have already been recorded on a CD TEXT disc.
- If no title has been entered for the currently playing disc, **NO DISC TITLE** is displayed.

1 Play the CD that you want to enter a title for.

2 Touch T. EDIT on the function menu.

3 Touch ABC to select the desired character type.

Touch **ABC** repeatedly to switch between the following character types:

Alphabet (upper case), numbers and symbols —Alphabet (lower case)—European letters, such as those with accents (e.g., **á, à, ä, ç**)

- You can select to input numbers and symbols by touching **123**.

4 Touch ▲ or ▼ to select a letter of the alphabet.

Each time you touch **▲** it will display a letter of the alphabet in **A B C ... X Y Z**, numbers and symbols in **1 2 3 ... | } ~** order. Each time you touch **▼** it will display a letter in the reverse order, such as **Z Y X ... C B A**.

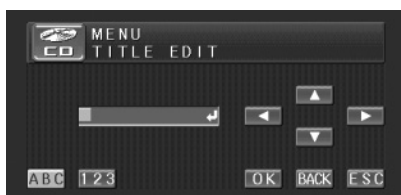

5 Touch ► to move the cursor to the next character position.

When the desired letter is displayed, touch **►** to move the cursor to the next position and then select the next letter. Touch **◀** to move backwards in the display.

6 Touch OK to store the entered title in memory.

7 Touch ESC to return to the playback display.



Notes

- Titles remain in memory, even after the disc has been removed from the unit, and are recalled when the disc is reinserted.
- After data for 48 discs has been stored in memory, data for a new disc will overwrite the oldest one. □

Selecting tracks from the track title list

Track title list lets you see the list of track titles on a CD TEXT disc and select one of them to play back.

1 Touch T.LIST on the function menu.

2 Touch ⤴ or ⤵ to switch between the lists of titles.

3 Touch your favorite track title.

That selection will begin to play. □

Listening to MP3/WMA

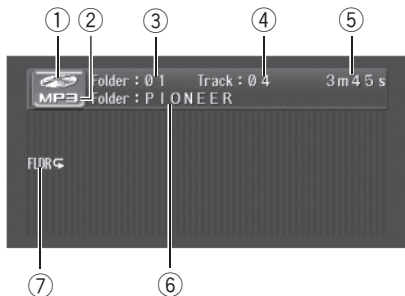

These are the basic steps necessary to play an MP3/WMA with your built-in DVD player. More advanced MP3/WMA operation is explained starting on page 49.

① Source icon

Shows which source has been selected.

② Media indicator

MP3 or **WMA** appears depending on the file format you are playing.

When playing discs with MP3/WMA files and audio data (CD-DA) such as CD-EXTRA and MIXED-MODE CDs, **MIX** is displayed.

③ Folder number indicator

Shows the number of folder currently playing.

④ Track number indicator

Shows the track (file) currently playing.

⑤ Play time indicator

Shows the elapsed playing time of the current track (file).

⑥ Folder name indicator

Shows the name of folder currently playing.

⑦ Repeat indicator

Shows the selected repeat range.

1 Touch the source icon and then touch DVD to select the DVD player.

- When the source icon is not displayed, you can display it by touching the screen.
- If no disc is loaded in the unit, you cannot select **DVD** (DVD player). Insert a disc in the unit. (Refer to page 16.)

2 Touch the screen to display the touch panel keys.

3 To select a track, touch a track title on the list.

The track you selected will begin to play.

- When the list of titles is not displayed, touch **LIST**.

4 To skip back or forward to another track, touch **◀◀** or **▶▶**.

Touching **▶▶** skips to the start of the next track. Touching **◀◀** once skips to the start of the current track. Touching it again will skip to the previous track.

- You can also skip back or forward to another track by pressing **◀** or **▶** button.

5 To perform fast forward or reverse, keep touching **◀◀** or **▶▶**.

- You can also perform fast reverse/fast forward by pressing and holding **◀** or **▶** button.
- There is no sound on fast forward or reverse.
- This is fast forward and reverse operation only for the file being played. This operation is canceled when the previous or next file is reached.

6 To select a folder, touch **⏮** to show the folder one level higher and touch a folder name on the list.

- To return to folder **001** (ROOT), press and hold **BAND/ESC**. However, if folder **001** (ROOT) contains no files, playback commences with folder **002**.

Playing MP3/WMA

- You can also select a folder by pressing ▲ or ▼ button.
- You cannot select a folder that does not have an MP3/WMA file recorded in it.

Notes

- When playing discs with MP3/WMA files and audio data (CD-DA) such as CD-EXTRA and MIXED-MODE CDs, both types can be played only by switching mode between MP3/WMA and CD-DA by touching **MEDIA** or pressing **BAND/ESC**. This function can be operated only when the disc is playing.
- If you have switched between playback of MP3/WMA files and audio data (CD-DA), playback starts at the first track on the disc.
- This DVD player can play back an MP3/WMA file recorded on CD-ROM. (Refer to page 105 for files that can be played back.)
- There is sometimes a delay between starting up CD playback and the sound being issued. When being read in, **FORMAT READ** is displayed.
- Playback is carried out in order of file number. Folders are skipped if they contain no files. (If folder **001** (ROOT) contains no files, playback commences with folder **002**.)
- This unit does not play back WMA files recorded as VBR (variable bit rate).
- When playing back files recorded as VBR (variable bit rate) files, the play time will not be correctly displayed if fast forward or reverse operations are used.
- If the inserted disc contains no files that can be played back, **NON-PLAYABLE DISC** is displayed.
- When playing an MP3/WMA disc containing more than 192 tracks, **READY** appears for the track titles of 193rd or later. The track title of those tracks is displayed on the information bar when it plays back.
- If the inserted disc contains WMA files that are protected by digital rights management

(DRM), **TRK SKIPPED** is displayed while the protected file is skipped.

- If all the files on the inserted disc are secured by DRM, **PROTECT** is displayed.
- When a disc contains both WMA files which are protected by DRM and audio data (CD-DA), both types cannot be switched. In this case, only audio data will be played back.
- There is no sound on fast forward or reverse.
- If you do not use the touch panel keys within 30 seconds, they will be hidden automatically. 

Stopping playback

- **Touch ■.**
 - When you stop MP3/WMA playback by touching ■, that location on the disc is memorized, enabling playback from that point when you play the disc again.
 - To play back the disc again, touch ►/||. 

Pausing MP3/WMA playback

Pause lets you temporarily stop disc playback.

- **Touch ►/|| during playback.** **PAUSE** appears in the display. Play of the current track pauses.
 - To resume playback at the same point that you turned pause on, touch ►/|| again. 

Displaying the list of information on MP3/WMA file

Information recorded on a MP3/WMA disc can be displayed.

● Touch  to display the list of information on the MP3/WMA file you are currently playing.

- **ALBUM** (album title)
- **TRACK** (track title)
- **FOLDER** (folder name)
- **FILE** (file name)
- **ARTIST** (artist name)
- **GENRE** (genre)
- **YEAR** (year)
- When playing back WMA files, lists of album title, genre and year appear in blank.
- If specific information has not been recorded on an MP3/WMA file, the list appears in blank.
- Depending on the version of ID3 tag or Windows Media Player, the information may not be displayed correctly.

Displaying text information on MP3/WMA disc

Text information recorded on a MP3/WMA disc can be displayed on the information bar.

● **Touch DISP.**

Touch **DISP** repeatedly to switch between the following settings:

Folder (folder name)—**File** (file name)
 —**T.Title** (track title)—**Artist** (artist name)
 —**Album** (album title)—**Comment** (comment)
 —**Bit Rate** (bit rate)

- When playing back WMA files, album title and comment are not displayed.
- When a list of folders/files is displayed by the touch of **LIST**, **Current** (currently playing folder) is displayed instead of **Folder**.
- When playing back MP3 files recorded as VBR (variable bit rate) files, the bit rate value is not displayed even after switching to bit rate. (**VBR** will be displayed.)
- If specific information has not been recorded on an MP3/WMA disc, **NO XXXX** will be displayed (e.g., **NO ARTIST NAME**).

Scrolling text information in the display

This unit can display the first 19 letters only of **Folder**, **File**, **T.Title**, **Artist**, **Album** and **Comment** on the information bar. When the recorded information is longer than 19 letters, you can scroll the text to the left so that the rest of the text information can be seen.

● **Keep touching DISP until the text information begins to scroll to the left.**

The rest of the text information will appear in the display. 

Playing MP3/WMA

Introduction of advanced built-in DVD player (MP3/WMA) operation

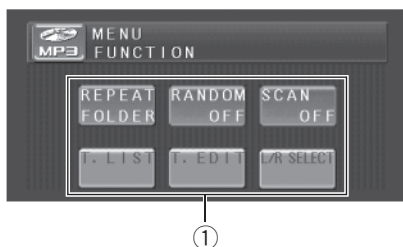

① Function display

Shows the function names.

1 Press A.MENU button to display MENU.
MENU appears on the display.

2 Touch FUNCTION to display the function names.

The function names are displayed and operable ones are highlighted.

- To return to the previous display, touch **BACK**.
- To return to the playback display, touch **ESC**.

Note

If you do not operate the function within about 30 seconds, the display is automatically returned to the playback display. 

Repeating play

For MP3/WMA playback, there are three repeat play ranges: **FOLDER** (folder repeat), **TRACK** (one-track repeat) and **DISC** (repeat all tracks).

● Touch **REPEAT** on the function menu to select the repeat range.

- **FOLDER** – Repeat the current folder
- **TRACK** – Repeat just the current track
- **DISC** – Repeat all tracks

Notes

- If you select another folder during repeat play, the repeat play range changes to **DISC**.
- If you perform track search or fast forward/reverse during **TRACK**, the repeat play range changes to **FOLDER**.
- When **FOLDER** is selected, it is not possible to play back a subfolder of that folder.
- When playing discs with MP3/WMA files and audio data (CD-DA), repeat play performs within the currently playing data type even if **DISC** is selected. 

Playing tracks in a random order

Random play lets you play back tracks in a random order within the repeat range, **FOLDER** and **DISC**.

1 Select the repeat range.

Refer to *Repeating play* on this page.

2 Touch RANDOM on the function menu to turn random play on.

Tracks will play in a random order within the previously selected **FOLDER** or **DISC** ranges.

- To turn random play off, touch **RANDOM** again. 

Scanning folders and tracks

While you are using **FOLDER**, the beginning of each track in the selected folder plays for about 10 seconds. When you are using **DISC**, the beginning of the first track of each folder is played for about 10 seconds.

1 Select the repeat range.

Refer to *Repeating play* on the previous page.

2 Touch **SCAN** on the function menu to turn scan play on.

The first 10 seconds of each track of the current folder (or the first track of each folder) is played.

3 When you find the desired track (or folder) touch **SCAN** again.



Note

After track or folder scanning is finished, normal playback of the tracks will begin again. ▣

Multi-CD Player

Listening to a CD

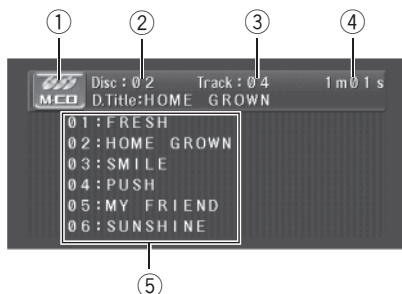

You can use this unit to control a multi-CD player, which is sold separately.

These are the basic steps necessary to play a CD with your multi-CD player. More advanced CD operation is explained starting on page 53.

① Source icon

Shows which source has been selected.

② Disc number indicator

Shows the disc currently playing.

③ Track number indicator

Shows the track currently playing.

④ Play time indicator

Shows the elapsed playing time of the current track.

⑤ Disc list display

Shows the disc title list.

1 Touch the source icon and then touch M-CD to select the multi-CD player.

- When the source icon is not displayed, you can display it by touching the screen.

2 Touch the screen to display the touch panel keys.

3 Touch a disc title on the list to play back.

Operable disc titles are highlighted. If you want to select a disc located at 7 to 12, touch or to display **07—12**.

- When the disc titles of 01-06 or 07-12 are not displayed, you can display them by touching **LIST**.

- You can also sequentially select a disc by pressing / button.

4 To skip back or forward to another track, touch or .

Touching skips to the start of the next track. Touching once skips to the start of the current track. Touching again will skip to the previous track.

- You can also skip back or forward to another track by pressing or button.

5 To perform fast forward or reverse, keep touching or .

- You can also perform fast reverse/fast forward by pressing and holding or button.



Notes

- When the multi-CD player performs the preparatory operations, **READY** is displayed.
- If an error message such as **ERROR-02** is displayed, refer to the multi-CD player owner's manual.
- If there are no discs in the multi-CD player magazine, **NO DISC** is displayed.
- If you do not use the touch panel keys within 30 seconds, they will be hidden automatically.

Pausing CD playback

Pause lets you temporarily stop disc playback.

- **Touch ►/|| during playback.**

PAUSE appears in the display. Play of the current track pauses.

- To resume playback at the same point that you turned pause on, touch ►/|| again. 

Using CD TEXT functions

You can use these functions only with a CD TEXT compatible multi-CD player.

Some discs have certain information encoded on the disc during manufacture. These discs may contain such information as the CD title, track title, artist's name and playback time and are called CD TEXT discs. Only these specially encoded CD TEXT discs support the functions listed below.

Displaying titles on CD TEXT discs

Text information recorded on a CD TEXT disc can be displayed on the information bar.

- **Touch DISP.**

Touch **DISP** repeatedly to switch between the following settings:

D.Title (disc title)—**D.Artist** (disc artist name)
—**T.Title** (track title)—**T.Artist** (track artist name)

- If specific information has not been recorded on a CD TEXT disc, **NO XXXX** will be displayed (e.g., **NO T.ARTIST NAME**).

Scrolling titles in the display

This unit can display the first 19 letters only of **D.Title**, **D.Artist**, **T.Title** and **T.Artist** on the information bar. When the recorded information is longer than 19 letters, you can scroll the text to the left so that the rest of the title can be seen.

- **Keep touching DISP until the title begins to scroll to the left.**

The rest of the title will appear in the display. 

50-disc multi-CD player

Only those functions described in this manual are supported for 50-disc multi-CD players.

This unit is not designed to operate disc title list functions with a 50-disc multi-CD player. 

Multi-CD Player

Introduction of advanced multi-CD player operation

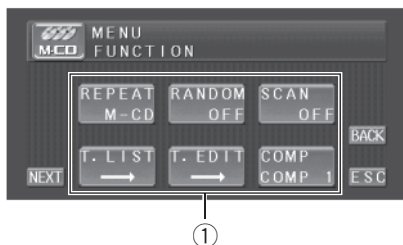

① Function display

Shows the function names.

1 Press A.MENU button to display MENU.
MENU appears on the display.

2 Touch FUNCTION to display the function names.

The function names are displayed and operable ones are highlighted.

- To go to the next group of function names, touch **NEXT**.
- To return to the previous group of function names, touch **PREV**.
- To return to the previous display, touch **BACK**.
- To return to the playback display, touch **ESC**.



Note

If you do not operate the function within about 30 seconds, the display is automatically returned to the playback display.

Repeating play

There are three repeat play ranges for the multi-CD player: **M-CD** (multi-CD player repeat), **TRACK** (one-track repeat) and **DISC** (disc repeat).

● Touch **REPEAT** on the function menu to select the repeat range.

- **M-CD** – Repeat all discs in the multi-CD player
- **TRACK** – Repeat just the current track
- **DISC** – Repeat the current disc



Notes

- If you select other discs during repeat play, the repeat play range changes to **M-CD**.
- If you perform track search or fast forward/reverse during **TRACK**, the repeat play range changes to **DISC**.

Playing tracks in a random order

Random play lets you play back tracks in a random order within the repeat range, **M-CD** and **DISC**.

1 Select the repeat range.

Refer to *Repeating play* on this page.

2 Touch RANDOM on the function menu to turn random play on.

Tracks will play in a random order within the previously selected **M-CD** or **DISC** ranges.

- To turn random play off, touch **RANDOM** again.

Scanning CDs and tracks

While you are using **DISC**, the beginning of each track on the selected disc plays for about 10 seconds. When you are using **M-CD**, the beginning of the first track of each disc is played for about 10 seconds.

1 Select the repeat range.

Refer to *Repeating play* on this page.

2 Touch **SCAN** on the function menu to turn scan play on.

The first 10 seconds of each track of the current disc (or the first track of each disc) is played.

3 When you find the desired track (or disc) touch **SCAN** again.



Note

After track or disc scanning is finished, normal playback of the tracks will begin again. ▣

Using ITS playlists

ITS (instant track selection) lets you make a playlist of favorite tracks from those in the multi-CD player magazine. After you have added your favorite tracks to the playlist you can turn on ITS play and play just those selections.

Creating a playlist with ITS programming

You can use ITS to enter and play back up to 99 tracks per disc, up to 100 discs (with the disc titles). (With multi-CD players sold before the CDX-P1250 and CDX-P650, up to 24 tracks can be stored in the playlist.)

1 Play a CD that you want to program.

Touch **▲** or **▼** to select the CD.

2 Touch **NEXT** on the function menu.

3 Touch **ITS MEMO**.

4 Touch **◀** or **▶** to select the desired track.

5 Touch **MEMORY▲** to store the currently playing track in the playlist.

MEMORY is displayed and the currently playing selection is added to your playlist. The display then shows track number again.



Note

After data for 100 discs has been stored in memory, data for a new disc will overwrite the oldest one.

Playback from your ITS playlist

ITS play lets you listen to the tracks that you have entered into your ITS playlist. When you turn on ITS play, tracks from your ITS playlist in the multi-CD player will begin to play.

1 Select the repeat range.

Refer to *Repeating play* on the previous page.

2 Touch **NEXT** on the function menu.

3 Touch **ITS PLAY** to turn ITS play on.

Playback begins of those tracks from your playlist within the previously selected **M-CD** or **DISC** ranges.

- If no tracks in the current range are programmed for ITS play then **ITS EMPTY** is displayed.
- To turn ITS play off, touch **ITS PLAY** again.

Erasing a track from your ITS playlist

When you want to delete a track from your ITS playlist, you can if ITS play is on. If ITS play is already on, skip to step 2.

1 Play the CD with the track you want to delete from your ITS playlist, and turn ITS play on.

Refer to *Playback from your ITS playlist* on this page.

Multi-CD Player

2 Touch NEXT on the function menu.

3 Touch ITS MEMO.

4 Touch ◀ or ▶ to select the desired track.

5 Touch CLEAR▼ to erase the track from your ITS playlist.

The currently playing selection is erased from your ITS playlist and playback of the next track from your ITS playlist begins.

- If there are no tracks from your playlist in the current range, **ITS EMPTY** is displayed and normal play resumes.

Erasing a CD from your ITS playlist

When you want to delete all tracks of a CD from your ITS playlist, you can if ITS play is off.

1 Play the CD that you want to delete.

Touch ▲ or ▼ to select the CD.

2 Touch NEXT on the function menu.

3 Touch ITS MEMO.

4 Touch CLEAR▼ to erase all tracks on the currently playing CD from your ITS playlist.

ITS CLEAR is displayed and all tracks on the currently playing CD are erased from your playlist. ◻

Using disc title functions

You can input CD titles and the titles are displayed on the information bar. Then you can easily search for and play a desired disc.

Entering disc titles

Use the disc title input feature to store up to 100 CD titles (with ITS playlist) into the multi-

CD player. Each title can be up to 10 characters long.

- When playing a CD TEXT disc on a CD TEXT compatible multi-CD player, you cannot switch to **T. EDIT**. The disc title will have already been recorded on a CD TEXT disc.

1 Play the CD that you want to enter a title for.

Touch ▲ or ▼ to select the CD.

2 Touch T. EDIT on the function menu.

3 Touch ABC to select the desired character type.

Touch **ABC** repeatedly to switch between the following character types:

Alphabet (upper case), numbers and symbols —Alphabet (lower case)—European letters, such as those with accents (e.g., á, à, ä, ç)

- You can select to input numbers and symbols by touching **123**.

4 Touch ▲ or ▼ to select a letter of the alphabet.

Each time you touch ▲ it will display a letter of the alphabet in **A B C ... X Y Z**, numbers and symbols in **1 2 3 ... | }** order. Each time you touch ▼ it will display a letter in the reverse order, such as **Z Y X ... C B A**.

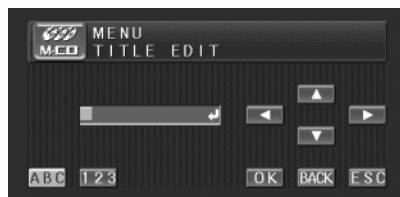

5 Touch ▶ to move the cursor to the next character position.

When the desired letter is displayed, touch ▶ to move the cursor to the next position and then select the next letter. Touch ◀ to move backwards in the display.

6 Touch OK to store the entered title in memory.

7 Touch ESC to return to the playback display.





Notes

- Titles remain in memory, even after the disc has been removed from the magazine, and are recalled when the disc is reinserted.
- After data for 100 discs has been stored in memory, data for a new disc will overwrite the oldest one.

Selecting tracks from the track title list

Track title list lets you see the list of track titles on a CD TEXT disc and select one of them to play back.

1 Touch T.LIST on the function menu.

2 Touch  or  to switch between the lists of titles.

3 Touch your favorite track title.

That selection will begin to play.

Using compression and bass emphasis

You can use these functions only with a multi-CD player that supports them.

Using COMP (compression) and DBE (dynamic bass emphasis) functions lets you adjust the sound playback quality of the multi-CD player. Each of the functions has a two-step adjustment. The COMP function balances the output of louder and softer sounds at higher volumes. DBE boosts bass levels to give playback a fuller sound. Listen to each of the

effects as you select them and use the one that best enhances the playback of the track or CD that you are listening to.

● **Touch COMP on the function menu to select your favorite setting.**

Touch **COMP** repeatedly to switch between the following settings:

**COMP OFF—COMP 1—COMP 2—
COMP OFF—DBE 1—DBE 2**

- If the multi-CD player does not support COMP/DBE, **NOCOMP** is displayed when you attempt to select it.

DAB tuner

Listening to the DAB

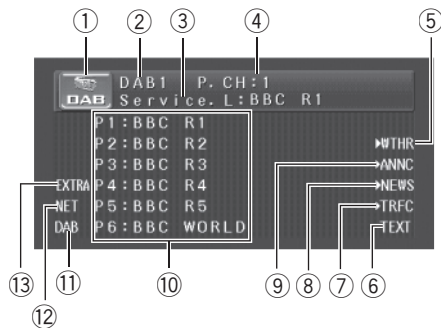

You can use this unit to control a DAB tuner (GEX-P700DAB), which is sold separately.

For details concerning operation, refer to the DAB tuner's operation manual. This section provides information on DAB operations with this unit which differs from that described in the DAB tuner's operation manual.

- This unit does not have a language filter function.
- With this unit, you can operate three additional functions: available service list, available PTY search, and storing and recalling dynamic label.

① Source icon

Shows which source has been selected.

② Band indicator

Shows which band the DAB tuner is tuned to.

③ Service label indicator

Shows to which service the DAB tuner is tuned.

④ Preset number indicator

Shows which preset has been selected.

⑤ WEATHER indicator

Shows when area weather flash is received.

⑥ TEXT indicator

Shows that the currently received service has a dynamic label.

⑦ TRAFFIC indicator

Shows when traffic announcement is received.

⑧ NEWS indicator

Shows when news announcement is received.

⑨ ANNOUNCE indicator

Shows when announcement is received.

⑩ Preset list display

Shows the preset list.

⑪ EXTRA indicator

Shows that the currently received service has a secondary service component.

⑫ NET indicator

Shows when service follow function is on.

⑬ DAB indicator

Shows when DAB reception is possible.

1 Touch the source icon and then touch DAB to select the DAB.

- When the source icon is not displayed, you can display it by touching the screen.

2 Touch the screen to display the touch panel keys.

3 Touch BAND to select a band.

Touch **BAND** repeatedly until the desired band is displayed, **DAB1**, **DAB2** or **DAB3**.

4 To select a preset service, touch a preset service name on the list.

The preset service you selected is tuned in.

- When the list of services is not displayed, touch **LIST**.

5 To select a service, briefly touch ◀ or ▶.

- You can also select a service by pressing ◀ or ▶ button.

6 To select an ensemble, keep touching ◀ or ▶ for about one second and release.

- You can cancel ensemble search by touching either ◀ or ▶ shortly.
- You can also perform ensemble search by pressing and holding ◀ or ▶ button.



Note

If you do not use the touch panel keys within 30 seconds, they will be hidden automatically. 

Switching the DAB display

Labels can be displayed on the information bar.

● Touch DISP.

Touch **DISP** repeatedly to switch between the following settings:

Service L (service label)—**Component** (service component label)—**DLS** (dynamic label)—**Ensemble** (ensemble label)—**PTY** (PTY label)



Note

With a service component that has no service component label, dynamic label or PTY label, switching to **Component**, **DLS** and **PTY** is not possible. 

Storing and recalling broadcast frequencies

● When you find a service that you want to store in memory, keep touching one of preset tuning keys P1—P6 until the preset number stops flashing.

The number you have touched will flash in the preset number indicator and then remain lit. The selected service has been stored in memory.

The next time you touch the same preset tuning key the service is recalled from memory.

- When the touch panel keys are not displayed, you can display them by touching the screen.
- When **P1—P6** are not displayed, you can display them by touching **LIST**.



Notes

- Up to 18 services, six for each of the three bands, can be stored in memory.
- You can also use ▲ and ▼ buttons to recall services assigned to preset tuning keys **P1—P6**. 

Using dynamic label

Displaying dynamic label

1 Touch TEXT to display dynamic label.

- You can cancel dynamic label display by touching **ESC** or pressing **BAND/ESC**.
- When no dynamic label is currently being received, **NO TEXT** is displayed.

2 Touch PREV or NEXT to recall the most recent dynamic labels.

Touching **PREV** or **NEXT** switches between the current and the three dynamic label data displays.

- If there is no dynamic label data in memory the display will not change.

DAB tuner

Storing and recalling dynamic label

You can store data from up to six dynamic label transmissions at buttons **1–6**.

1 Display the dynamic label you want to store in memory.

Refer to *Displaying dynamic label* on the previous page.

2 Press any buttons 1–6 and hold to store the selected dynamic label.

The memory number will display and the selected dynamic label will be stored in memory. The next time you press the same button in the dynamic label display the stored text is recalled from memory. 

Introduction of advanced DAB tuner operation

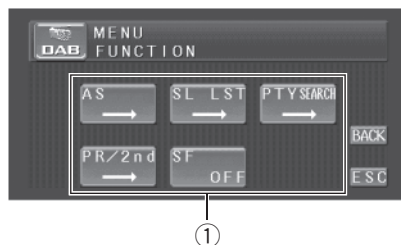

① Function display

Shows the function names.

1 Press A.MENU button to display MENU. MENU appears on the display.

2 Touch FUNCTION to display the function names.

The function names are displayed and operable ones are highlighted.

- To return to the previous display, touch **BACK**.
- To return to the normal display, touch **ESC**.



Note

If you do not operate the function within about 30 seconds, the display is automatically returned to the frequency display. 

Setting the announcement support interruption

1 Touch AS on the function menu.

2 Touch ▲ or ▼ to select the desired announcement support.

Touch ▲ to select **ANNOUNCE** (announcement). Touch ▼ to select **WEATHER** (area weather flash).

3 Touch ◀ to turn the selected announcement support interruption on.

- To turn the selected announcement support interruption off, touch ▶.

Receiving the road traffic flash and transport flash

1 Press TA/NEWS to turn road traffic flash and transport flash on.

▶TRFC or T appears in the display.

- To turn the road traffic flash and transport flash off, press TA/NEWS again.

2 Press TA/NEWS while the road traffic flash and transport flash are being received to cancel the announcement interruption.

Receiving news flash

● Press TA/NEWS and hold to turn news flash on.

Press TA/NEWS until ▶NEWS or N appears in the display.

- To turn news flash off, press TA/NEWS and hold again. [■]

Selecting services from the available service list

Available service list lets you see the list of available services and select one of them to receive, if the currently received ensemble has multiple services.

1 Touch SL LST on the function menu.

2 Touch NEXT or PREV to switch between the lists of available services.

3 Touch your favorite available service.

That selection will begin to receive. [■]

Searching for service by available PTY information

Available PTY search lets you see the list of available PTYs that is in the current ensemble and select one of them to receive.

- If there is no available PTY in the current ensemble, you cannot switch to the available PTY search mode.
- Available PTY search is different from PTY search. With this unit, you can operate only the available PTY search.

1 Touch PTY SEARCH on the function menu.

2 Touch your favorite available PTY to begin the PTY search.

DAB receives the desired PTY service.



Notes

- The PTY method displayed is narrow. The wide method cannot be selected when using DAB as source.
- If no service broadcasting the selected programming type is found, **NOT FOUND** is displayed for about two seconds and then the DAB returns to the previous service. [■]

Switching primary or secondary service component

1 Touch PR/2nd on the function menu.

2 Touch ◀ or ▶ to select the desired service component. [■]

Switching the service follow

● Touch SF on the function menu to turn the service follow on.

- To turn the service follow off, touch SF again. [■]

TV tuner

Watching the television

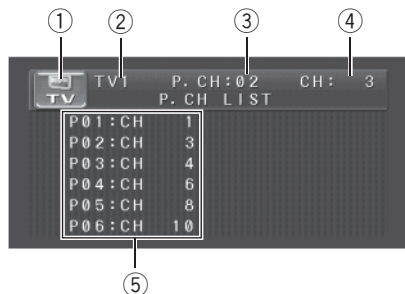

You can use this unit to control a TV tuner (e.g. GEX-P5700TV(P)), which is sold separately.

For details concerning operation, refer to the TV tuner's operation manuals. This section provides information on TV operations with this unit which differs from that described in the TV tuner's operation manual.

① Source icon

Shows which source has been selected.

② Band indicator

Shows which band the TV tuner is tuned to.

③ Preset number indicator

Shows which preset has been selected.

④ Channel indicator

Shows which channel the TV tuner is tuned.

⑤ Preset list display

Shows the preset list.

1 Touch the source icon and then touch TV to select the TV.

- When the source icon is not displayed, you can display it by touching the screen.

2 Touch the screen to display the touch panel keys.

3 Touch BAND to select a band.

Touch **BAND** repeatedly until the desired band is displayed, **TV1** or **TV2**.

4 To select a preset channel, touch a preset channel on the list.

The preset channel you selected is tuned in.

- When the list of channels is not displayed, touch **LIST**.

5 To perform manual tuning, briefly touch ◀ or ▶.

The channels move up or down step by step.

- You can also perform manual tuning by pressing ◀ or ▶ button.

6 To perform seek tuning, keep touching ◀ or ▶ for about one second and release.

The tuner will scan the channels until a broadcast strong enough for good reception is found.

- You can cancel seek tuning by briefly touching either ◀ or ▶.

- If you keep touching ◀ or ▶ you can skip broadcasting channels. Seek tuning starts as soon as you release the keys.

- You can also perform seek tuning by pressing and holding ◀ or ▶ button.



Note

If you do not use the touch panel keys within 30 seconds, they will be hidden automatically. □

Storing and recalling broadcast stations

If you touch any of the preset tuning keys

P1—P12 you can easily store up to 12 broadcast stations for later recall with the touch of a key.

- When you find a station that you want to store in memory, keep touching one of preset tuning keys **P1—P12** until the preset number stops flashing.

The number you have touched will flash in the preset number indicator and then remain lit. The selected station has been stored in memory.

The next time you touch the same preset tuning key the station is recalled from memory.

- To switch between **P1—P6** and **P7—P12**, touch **↕** or **↔**.
- When the touch panel keys are not displayed, you can display them by touching the screen.
- When **P1—P6** and **P7—P12** are not displayed, you can display them by touching **LIST**.



Notes

- Up to 24 stations, 12 for each of two TV bands, can be stored in memory.
- You can also use **▲** and **▼** to recall stations assigned to preset tuning keys **P1—P12**. **▣**

Introduction of advanced TV tuner operation

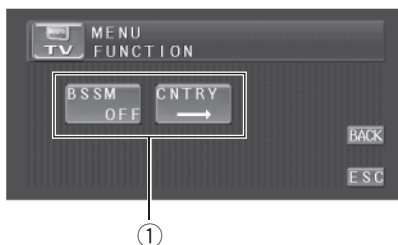

① Function display

Shows the function names.

- 1 Press **A.MENU** button to display **MENU**. **MENU** appears on the display.

- 2 Touch **FUNCTION** to display the function names.

The function names are displayed and operable ones are highlighted.

- To return to the previous display, touch **BACK**.
- To return to the TV picture, touch **ESC**.



Note

If you do not operate the function within about 30 seconds, the display is automatically returned to the TV picture. **▣**

Storing the strongest broadcast stations sequentially

- Touch **BSSM** on the function menu to turn **BSSM** on.

BSSM begins to flash. While **BSSM** is flashing the 12 strongest broadcast stations will be stored in order from the lowest channel up. When finished, **BSSM** disappears.

TV tuner

- To cancel the storage process, touch **BSSM** again.



Note

Storing broadcast stations with BSSM may replace broadcast stations you have saved using **P1—P12**. 

Selecting the country group

1 Touch **COUNTRY (CNTRY)** on the function menu.

2 Touch **◀** or **▶** to select the country group.

Touch **◀** or **▶** until the desired country group appears in the display.

COUNTRY 1 (CCIR channel)—**COUNTRY 2** (Italy channel)—**COUNTRY 3** (U.K. channel)
—**COUNTRY 4** (OIRT channel) 

Playing a disc

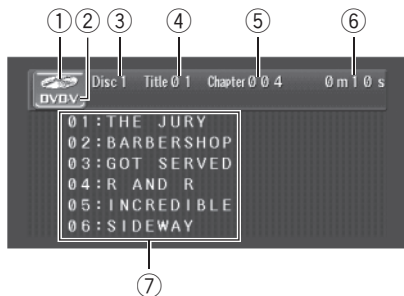

You can use this unit to control a DVD player or multi-DVD player, which is sold separately.

For details concerning operation, refer to the DVD player's or multi-DVD player's operation manual. This section provides information on DVD operations with this unit which differs from that described in the DVD player's or multi-DVD player's operation manual.

- ① **Source icon**
Shows which source has been selected.
- ② **Disc type indicator**
Shows the type of the currently playing disc.
- ③ **Disc number indicator**
Shows the disc currently playing when using a multi-DVD player.
- ④ **Title number indicator**
Shows the title currently playing during DVD video playback.
- ⑤ **Chapter/track number indicator**
Shows the chapter/track currently playing.
- ⑥ **Play time indicator**
Shows the elapsed playing time of the current chapter/track.
- ⑦ **Disc list display**
Shows the disc title list.

1 Touch the source icon and then touch S-DVD to select the DVD player.

- When the source icon is not displayed, you can display it by touching the screen.

2 Touch the screen to display the touch panel keys.

3 To skip back or forward to another chapter/track, briefly touch ◀ or ▶.

- You can also skip back or forward to another chapter by pressing ◀ or ▶ button.

4 To perform fast forward or reverse, keep touching ◀ or ▶.

- You can also perform fast reverse/fast forward by pressing and holding ◀ or ▶ button.



Note

If you do not use the touch panel keys within 30 seconds, they will be hidden automatically. □

Selecting a disc

- You can operate this function only when a multi-DVD player is connected to this unit.

● Touch a disc title on the list to play back.

Operable disc titles are highlighted.

- When the list of titles is not displayed, touch LIST.
- You can also select a disc by pressing ▲ or ▼ button. □

Pausing disc playback

● Touch ▶/|| during playback.

The icon || is displayed and playback is paused, letting you view a still image.

- To resume playback at the same point that you turned pause on, touch ▶/|| again. □

Introduction of advanced DVD player operation

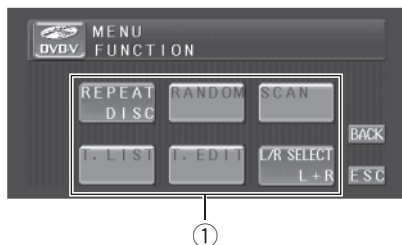

① Function display

Shows the function names.

1 Press A.MENU button to display MENU.
MENU appears on the display.

2 Touch FUNCTION to display the function names.

The function names are displayed and operable ones are highlighted.

- To return to the previous display, touch **BACK**.
- To return to the playback display, touch **ESC**.



Note

If you do not operate the function within about 30 seconds, the display is automatically returned to the playback display.

Repeating play

- During playback of Video CDs featuring PBC (playback control), this function cannot be operated.

• Touch REPEAT on the function menu to select the repeat range.

During DVD video playback

- **TITLE** – Repeat just the current title
- **CHPTR** – Repeat just the current chapter
- **DISC** – Repeat the current disc

During Video CD or CD playback

- **TRACK** – Repeat just the current track
- **DISC** – Repeat the current disc



Notes

- If you select other discs during repeat play, the repeat play range changes to **DISC**.
- If you perform track search or fast forward/reverse during **TRACK**, the repeat play range changes to **DISC**.

Playing tracks in a random order

- You can operate this function only during CD playback.

• Touch RANDOM on the function menu to turn random play on.

Tracks will play in a random order.

- To turn random play off, touch **RANDOM** again.

Scanning tracks of a CD

- You can operate this function only during CD playback.

1 Touch SCAN on the function menu to turn scan play on.

The first 10 seconds of each track is played.

2 When you find the desired track touch SCAN again.



Note

After scanning of a CD is finished, normal playback of the tracks will begin again.

Using ITS playlists

- You can operate these functions only when a multi-DVD player is connected to this unit.
- This function differs slightly from ITS playback with a multi-CD player. With multi-DVD player, ITS playback applies only to the CD playing. For details, refer to *Using ITS playlists* on page 54. 

Using disc title functions

You can input CD titles and display the titles. Then you can easily search for and play a desired disc.

Entering disc titles

Disc title input lets you input CD titles up to 10 letters long into the multi-DVD player. For details concerning operation, refer to *Using disc title functions* on page 55.

- You can operate this function only when a multi-DVD player is connected to this unit. 

Playing songs on iPod

Listening to songs on your iPod

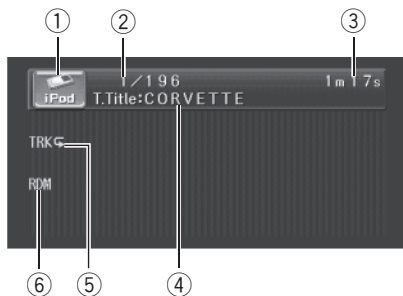

- ① **Source icon**
Shows which source has been selected.
- ② **Song number indicator**
Shows the number of song played in the selected list.
- ③ **Play time indicator**
Shows the elapsed playing time of the current song.
- ④ **Song title indicator**
Shows the title of the currently playing song.
- ⑤ **Repeat indicator**
Shows when repeat range is selected to current track.
- ⑥ **RDM indicator**
Shows when random play is set to **TRACK** or **ALBUM**.

1 Touch the source icon and then touch iPod to select the iPod.

- You can also select the iPod as a source by pressing **SOURCE** repeatedly.
- When the iPod is not connected to this unit, you cannot select the iPod as a source.

2 Touch the screen to display the touch panel keys.

3 To skip back or forward to another song, touch ◀◀ or ▶▶.

Touching ▶▶ skips to the start of the next song. Touching ◀◀ once skips to the start of the current song. Touching it again will skip to the previous song.

- You can also skip back or forward to another song by pressing ◀ or ▶.

4 To perform fast forward or reverse, keep touching ◀◀ or ▶▶.

- You can also perform fast reverse/fast forward by pressing and holding ◀ or ▶.



Note

If the playback is stopped for any reason, touch **TOP** and refine your search for a song. (□)

Browsing for a song

The operation of this unit to control iPod is designed to be as close to the operation of the iPod as possible for easy operation and song search.

1 Touch TOP to display the top menu.





2 Touch one of the categories in which you want to search for a song.

- **PLAYLISTS** (playlists)
- **GENRES** (genres)
- **ARTISTS** (artists)
- **ALBUMS** (albums)
- **SONGS** (songs)

3 Touch a list title that you want to play.



Repeat this operation until you find the desired song.

Playing songs on iPod

- You can start a playback of all the songs in the selected list (**GENRES**, **ARTISTS** or **ALBUMS**). To do this, keep touching the list title.
- To go to the next group of list titles, touch .
- To return to the previous group of list titles, touch .
- To return to the previous menu, touch .
- To go to the top menu of the list search, touch **TOP**. .

Pausing a song

Pause lets you temporarily stop playback of a song.

- **Touch  during playback.**
PAUSE appears in the display.
- To resume playback at the same point that you turned pause on, touch  again. .

Displaying text information on iPod

Text information recorded on the iPod can be displayed on the information bar.

- **Touch DISP.**
Touch **DISP** repeatedly to switch between the following settings:
T. Title (song title)—**Artist** (artist name)
—**Album** (album title)
- If the characters recorded on the iPod are not compatible with this unit, those characters will not be displayed.

Note

You can scroll the title to the left by keeping touching **DISP**. .

Repeating play

For playback of the songs on the iPod, there are two repeat play ranges: **TRACK** (repeat one song) and **ALL** (repeat all songs in the list).

- While **REPEAT** is set to **TRACK**, you cannot select the other songs.

1 Press A.MENU button and then touch FUNCTION to display the function names.

2 Touch REPEAT to select the repeat range.

Touch **REPEAT** repeatedly until the desired repeat range appears in the display.

- **TRACK** – Repeat just the current song
- **ALL** – Repeat all songs in the selected list .

Playing songs in a random order (shuffle)

For playback of the songs on the iPod, there are two random play methods: **TRACK** (play back songs in a random order) and **ALBUM** (play back albums in a random order).

1 Press A.MENU button and then touch FUNCTION to display the function names.

2 Touch RANDOM to select the random play method.

Touch **RANDOM** repeatedly until the desired random play method appears in the display.

- **TRACK** – Play back songs in a random order within the selected list
- **ALBUM** – Select an album randomly, and then play back all the songs in it in order
- **OFF** – Cancel the random play .

Audio Adjustments

Introduction of audio adjustments

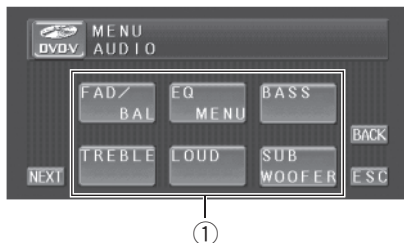

① Audio display

Shows the audio function names.



Important

If the multi-channel processor (DEQ-P6600) is connected to this unit, the audio function will be changed to the multi-channel processor's audio menu. For details, refer to *Introduction of DSP adjustments* on page 74.

1 Press A.MENU button to display MENU. MENU appears on the display.

2 Touch AUDIO to display the audio function names.

The audio function names are displayed and operable ones are highlighted.

- To go to the next group of function names, touch **NEXT**.
- To return to the previous group of function names, touch **PREV**.
- If EQ-EX function has been selected and only when EQ-EX is turned on and **CUSTOM** is selected as the equalizer curve, you can switch to **BASS** and **TREBLE**.
- Only when the subwoofer controller setting is **FULL, NON FADING** will be displayed instead of **SUB WOOFER**. (Refer to *Setting the rear output and subwoofer controller* on page 91.)

- When selecting the FM tuner as the source, you cannot switch to **SLA**.
- To return to the previous display, touch **BACK**.
- To return to the display of each source, touch **ESC**.



Note

If you do not operate the audio function within about 30 seconds, the display is automatically returned to the source display. 

Using balance adjustment

You can select a fader/balance setting that provides an ideal listening environment in all occupied seats.

1 Touch FAD/BAL on the audio function menu.

- When the rear output setting is **SUB. W**, **BAL** will be displayed instead of **FAD/BAL**. Refer to *Setting the rear output and subwoofer controller* on page 91.

2 Touch ▲ or ▼ to adjust front/rear speaker balance.

Each time you touch ▲ or ▼ it moves the front/rear speaker balance towards the front or the rear.

FRONT:15 – REAR:15 is displayed as the front/rear speaker balance moves from front to rear.

- **FR:00** is the proper setting when only two speakers are used.
- When the rear output setting is **SUB. W**, you cannot adjust front/rear speaker balance. Refer to *Setting the rear output and subwoofer controller* on page 91.

3 Touch ◀ or ▶ to adjust left/right speaker balance.

Each time you touch ◀ or ▶ it moves the left/right speaker balance towards the left or the right.

LEFT:09 – RIGHT:09 is displayed as the left/right speaker balance moves from left to right. □

Using the equalizer

The equalizer lets you adjust the equalization to match car interior acoustic characteristics as desired.

Recalling equalizer curves

There are six stored equalizer curves which you can easily recall at any time. Here is a list of the equalizer curves:

Display	Equalizer curve
POWERFUL	Powerful
NATURAL	Natural
VOCAL	Vocal
CUSTOM	Custom
FLAT	Flat
SUPER BASS	Super bass

- **CUSTOM** is an adjusted equalizer curve that you create.
- A separate **CUSTOM** curve can be created for each source. If you make adjustments, the equalizer curve settings will be memorized in **CUSTOM**.
- When **FLAT** is selected no supplement or correction is made to the sound. This is useful to check the effect of the equalizer curves by switching alternatively between **FLAT** and a set equalizer curve.

● Press EQ to select the equalizer.

Press **EQ** repeatedly to switch between the following equalizers:

POWERFUL—NATURAL—VOCAL—CUSTOM—FLAT—SUPER BASS

Adjusting equalizer curves

You can adjust the currently selected equalizer curve setting as desired. Adjusted equalizer curve settings are memorized in **CUSTOM**.

- You can adjust the center frequency and the Q factor (curve characteristics) of each currently selected curve band (**LOW/MID/HIGH**).

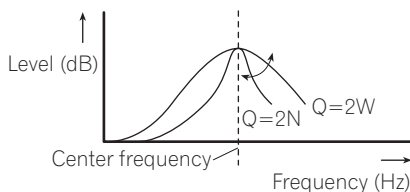

1 Touch EQ MENU on the audio function menu.

2 Touch ▲ or ▼ to select the desired item.

Each time you touch ▲ or ▼ selects the item in the following order:

BAND (bands)—**LEVEL** (equalizer level)
—**FREQUENCY** (center frequency)
—**Q. FACTOR** (Q factor)

3 Touch ◀ or ▶ to select the equalizer band to adjust.

Each time you touch ◀ or ▶ selects equalizer bands in the following order:

LOW (low)—**MID** (mid)—**HIGH** (high)

4 Touch ▼ and then touch ◀ or ▶ to adjust the level of the equalizer band.

Each time you touch ◀ or ▶ increases or decreases the level of the equalization band.

Audio Adjustments

+6 – –6 is displayed as the level is increased or decreased.

5 Touch ▼ and then touch ◀ or ▶ to select the desired frequency.

Touch ◀ or ▶ until the desired frequency appears in the display.

Low: **40Hz—80Hz—100Hz—160Hz**

Mid: **200Hz—500Hz—1kHz—2kHz**

High: **3.15kHz—8kHz—10kHz—12.5kHz**

6 Touch ▼ and then touch ◀ or ▶ to select the desired Q factor.

Touch ◀ or ▶ until the desired Q factor appears in the display.

2W—1W—1N—2N



Note

If you make adjustments, **CUSTOM** curve is updated. 

Adjusting bass and treble

You can adjust bass and treble settings.

- If EQ-EX function has been selected and only when EQ-EX is turned on and **CUSTOM** is selected as the equalizer curve, you can adjust bass and treble settings. (Refer to *Compensating for equalizer curves (EQ-EX)* on page 73.)

Adjusting bass

You can adjust the cut-off frequency and the bass level.

1 Touch BASS on the audio function menu.

2 Touch ▲ or ▼ to adjust the bass level.

Each time you touch ▲ or ▼ increases or decreases the bass level. **+6 – –6** is displayed as the level is increased or decreased.

3 Touch ◀ or ▶ to select the desired frequency.

Touch ◀ or ▶ until the desired frequency appears in the display.

40Hz—63Hz—100Hz—160Hz

Adjusting treble

You can adjust the cut-off frequency and the treble level.

1 Touch TREBLE on the audio function menu.

2 Touch ▲ or ▼ to adjust the treble level.

Each time you touch ▲ or ▼ increases or decreases the treble level. **+6 – –6** is displayed as the level is increased or decreased.

3 Touch ◀ or ▶ to select the desired frequency.

Touch ◀ or ▶ until the desired frequency appears in the display.

2.5kHz—4kHz—6.3kHz—10kHz 

Adjusting loudness

Loudness compensates for deficiencies in the low- and high-sound ranges at low volume.

1 Touch LOUDNESS (LOUD) on the audio function menu.

2 Touch ▲ to turn loudness on.

- To turn loudness off, touch ▼.

3 Touch ◀ or ▶ to select a desired level.

Each time you touch ◀ or ▶ selects level in the following order:

LOW (low)—**MID** (mid)—**HIGH** (high)

Using subwoofer output

This unit is equipped with a subwoofer output which can be turned on or off.

- When the subwoofer output is on, you can adjust the cut-off frequency and the output level of the subwoofer.

1 Touch SUB WOOFER on the audio function menu.

- When the subwoofer controller setting is **FULL**, you cannot select **SUB WOOFER**.

2 Touch ◀ to turn subwoofer output on.

- To turn subwoofer output off, touch ▶.

3 Touch ▼ and then touch ◀ or ▶ to select the phase of subwoofer output.

Touch ▶ to select normal phase and **NORMAL** appears in the display. Touch ◀ to select reverse phase and **REVERSE** appears in the display.

4 Touch ▼ and then touch ◀ or ▶ to adjust the output level of the subwoofer.

Each time you touch ◀ or ▶ increases or decreases the level of the subwoofer. **+6**—**-6** is displayed as the level is increased or decreased.

5 Touch ▼ and then touch ◀ or ▶ to select cut-off frequency.

Each time you touch ◀ or ▶ selects cut-off frequencies in the following order:

50Hz—**80Hz**—**125Hz**

Only frequencies lower than those in the selected range are outputted from the subwoofer.

Using nonfading output

When the nonfading output setting is on, the audio signal does not pass through this unit's low pass filter (for the subwoofer), but is outputted through the RCA output.

1 Touch NON FADING on the audio function menu.

- When the subwoofer controller setting is only **FULL**, you can select **NON FADING**. (Refer to page 91.)

2 Touch ▲ to turn non fading output on.

- To turn non fading output off, touch ▼.

3 Touch ◀ or ▶ to adjust the output level of the non fading.

Each time you touch ◀ or ▶ increases or decreases the level of the non fading. **+6**—**-6** is displayed as the level is increased or decreased.

Using the high pass filter

When you do not want low sounds from the subwoofer output frequency range to play from the front or rear speakers, turn on the HPF (high pass filter). Only frequencies higher than those in the selected range are outputted from the front or rear speakers.

1 Touch NEXT on the audio function menu.

2 Touch HPF.

3 Touch ▲ to turn high pass filter on.

- To turn high pass filter off, touch ▼.

Audio Adjustments

4 Touch ◀ or ▶ to select cut-off frequency.

Each time you touch ◀ or ▶ selects cut-off frequencies in the following order:

50Hz—80Hz—125Hz 

Adjusting source levels

SLA (source level adjustment) lets you adjust the volume level of each source to prevent radical changes in volume when switching between sources.

- Settings are based on the FM tuner volume level, which remains unchanged.

1 Compare the FM tuner volume level with the level of the source you wish to adjust.

2 Touch NEXT on the audio function menu.

3 Touch SLA.

4 Press ▲ or ▼ to adjust the source volume.

Each time you press ▲ or ▼ it increases or decreases the source volume.

+4 — -4 is displayed as the source volume is increased or decreased.



Notes

- The MW/LW tuner volume level can also be adjusted with source level adjustments.
- Video CD, CD and MP3/WMA are set to the same source level adjustment volume automatically.
- DVD and the optional DVD player are set to the same source level adjustment volume automatically.

- External unit 1 and external unit 2 are set to the same source level adjustment volume automatically.
- AUX (auxiliary input) and AV (AV input) are set to the same source level adjustment volume automatically. 

Compensating for equalizer curves (EQ-EX)

The EQ-EX function smooths the effects of each equalizer curve. Furthermore, you can adjust bass and treble for each source when **CUSTOM** curve is selected.

1 Touch NEXT on the audio function menu.

2 Touch EQ-EX.

3 Touch ▲ to turn EQ-EX on.

- To turn EQ-EX off, touch ▼. 

Introduction of DSP adjustments

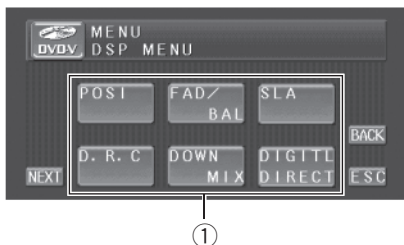

You can use this unit to control multi-channel processor (e.g. DEQ-P6600), which is sold separately.

- Some functions may differ depending on the multi-channel processor connected to this unit.

By carrying out the following settings/adjustments in the order shown, you can create a finely-tuned sound field effortlessly.

- 1 Setting the speaker setting
- 2 Using the position selector
- 3 Auto TA and EQ (auto-time alignment and auto-equalizing)
- 4 Adjusting the time alignment
- 5 Adjusting the speaker output levels using a test tone
- 6 Selecting a cross-over frequency
- 7 Adjusting the speaker output levels
- 8 Adjusting 3-band parametric equalizer

① DSP display

Shows the DSP function names.

1 Press A.MENU button to display MENU.
MENU appears on the display.

2 Touch DSP to display the DSP function names.

The DSP function names are displayed and operable ones are highlighted.

- To go to the next group of function names, touch **NEXT**.
- To return to the previous group of function names, touch **PREV**.
- When playing discs recorded with more than 96 kHz sampling frequency, you cannot use audio functions. Also, equalizer curve setting, **POSITION**, **AUTO EQ** and **AUTOTA** will be cancelled.
- When playing discs recorded with more than 96 kHz sampling frequency, audio is outputted from front speaker only.
- When selecting the FM tuner as the source, you cannot switch to **SLA**.
- When playing other than the DVD disc, you cannot switch to **D.R.C**.
- When neither **FRONT-L** nor **FRONT-R** is selected in **POSITION**, you cannot switch to **TIME ALIGN**.
- When both the center speaker and the rear speaker are set to OFF in the speaker setting, you cannot switch to **DOLBY PL II**.
- To return to the previous display, touch **BACK**.
- To return to the display of each source, touch **ESC**.

Note

If you do not operate the DSP function within about 30 seconds, the display is automatically returned to the source display. 

Using the sound field control

The SFC function creates the sensation of a live performance.

Digital Signal Processor

- The acoustics of different performance environments are not the same and depend on the extent and contour of space through which sound waves move and on how sounds bounce off the stage, walls, floors and ceilings. At a live performance you hear music in three stages: direct sound, early reflections, and late reflections, or reverberations. Those factors are programmed into the SFC circuitry to recreate the acoustics of various performance settings.

1 Press EQ button and hold to switch to SFC function.

Press **EQ** and hold until **SFC** appears in the display.

- To switch to equalizer function, press **EQ** and hold again.

2 Press EQ to select the desired SFC mode.

Press **EQ** repeatedly to switch between the following mode:

MUSICAL (musical)—**DRAMA** (drama)
—**ACTION** (action)—**JAZZ** (jazz)—**HALL** (hall)
—**CLUB** (club)—**OFF** (off)

Note

If the source is a 2-channel LPCM audio or a 2-channel Dolby Digital audio and you select SFC effects that are most applicable for 5.1-channel audio (i.e., **MUSICAL**, **DRAMA** or **ACTION**), we recommend turning Dolby Pro Logic II on. On the other hand, when selecting SFC effects that are intended for use with 2-channel audio (i.e., **JAZZ**, **HALL** or **CLUB**), we recommend turning Dolby Pro Logic II off. 

Using the position selector

One way to assure a more natural sound is to accurately position the stereo image, putting

you right in the center of the sound field. The position selector function lets you automatically adjust the speaker output levels and inserts a delay time to match the number and position of occupied seats. When used in conjunction with the SFC, the feature will make the sound image more natural and offer a panoramic sound that envelops you.

1 Touch POSITION on the DSP function menu.

2 Touch ◀/▶/▲/▼ to select a listening position.

Touch one of these, ◀/▶/▲/▼, to select a listening position as listed in the table.

Key	Display	Position
◀	FRONT-L	Front seat left
▶	FRONT-R	Front seat right
▲	FRONT	Front seats
▼	ALL	All seats

- To cancel the selected listening position, touch the same key again.

Note

When you make adjustments for listening position, the speakers are automatically set for appropriate output levels. You can tailor them if you want as discussed under the heading of *Adjusting the speaker output levels using a test tone or Adjusting the speaker output levels.* 

Using balance adjustment

You can select a fader/balance setting that provides an ideal listening environment in all occupied seats.

1 Touch FAD/BAL on the DSP function menu.

2 Touch ▲ or ▼ to adjust front/rear speaker balance.

Each time you touch ▲ or ▼ it moves the front/rear speaker balance towards the front or the rear.

FRONT:25 – REAR:25 is displayed as the front/rear speaker balance moves from front to rear.

- **FR:00** is the proper setting when only two speakers are used.

3 Touch ◀ or ▶ to adjust left/right speaker balance.

Each time you touch ◀ or ▶ it moves the left/right speaker balance towards the left or the right.

LEFT:25 – RIGHT:25 is displayed as the left/right speaker balance moves from left to right. 

Adjusting source levels

SLA (source level adjustment) lets you adjust the volume level of each source to prevent radical changes in volume when switching between sources.

- Settings are based on the FM tuner volume level, which remains unchanged.

1 Compare the FM tuner volume level with the level of the source you wish to adjust.

2 Touch SLA on the DSP function menu.

3 Press ▲ or ▼ to adjust the source volume.

Each time you press ▲ or ▼ it increases or decreases the source volume.

+4 – -4 is displayed as the source volume is increased or decreased.



Notes

- The MW/LW tuner volume level can also be adjusted with source level adjustments.
- Video CD, CD and MP3/WMA are set to the same source level adjustment volume automatically.
- DVD and the optional DVD player are set to the same source level adjustment volume automatically.
- External unit 1 and external unit 2 are set to the same source level adjustment volume automatically.
- AUX (auxiliary input) and AV (AV input) are set to the same source level adjustment volume automatically. 

Using the dynamic range control

The dynamic range refers to the difference between the largest and softest sounds. The dynamic range control compresses this difference so that you can clearly hear sounds even at low volume levels.

- The dynamic range control is effective only on Dolby Digital sounds.
- When playing other than the DVD disc, you cannot switch to **D.R.C.**

1 Touch D.R.C on the DSP function menu.

- When playing other than the DVD disc, you cannot switch this mode.

Digital Signal Processor

2 Touch ▲ to turn the dynamic range control on.

- To turn dynamic range control off, touch ▼. 

Using the down-mix function

Only when the multi-channel processor (e.g., DEQ-P6600) is connected to this unit, you can operate this function.

The down-mix function allows you to play back multi-channel audio in 2 channels.

1 Touch DOWN MIX on the DSP function menu.

2 Touch ◀ or ▶ to select the desired level.

Touch ◀ to select **Lo/Ro**. Touch ▶ to select **Lt/Rt**.

- **Lo/Ro** – Stereo mix the original audio that do not contain channel modes such as surround components.
- **Lt/Rt** – Down mix so that the surround components can be restored (decoded). 

Using the direct control

You can override audio settings to check for effectiveness of your audio settings.

- All audio functions are locked out when the direct control is on except **VOLUME**.

1 Touch DIGITL DIRECT on the DSP function menu.

2 Touch ▲ to turn the direct control on.

- To turn direct control off, touch ▼. 

Using the Dolby Pro Logic II

Only when the multi-channel processor (e.g., DEQ-P6600) is connected to this unit, you can operate this function.

Dolby Pro Logic II creates five full-bandwidth output channels from two-channel sources to achieve high-purity matrix surround.

- Dolby Pro Logic II supports up to 48kHz sampling rate stereo source and has no effect on other types of source.

1 Touch NEXT on the DSP function menu.

2 Touch DOLBY PL II.

3 Touch any of the following touch panel keys to select the desired mode.

- **MOVIE** – The Movie mode suitable for movie playback
- **MUSIC** – The Music mode suitable for music playback
- **MATRIX** – The Matrix mode for when FM radio reception is weak
- **OFF** – Turn Dolby Pro Logic II off
- **ADJUST** – Adjust the Music mode
 - You can operate **ADJUST** only when **MUSIC** has been selected.

Adjusting the Music mode

You can adjust the Music mode with the following three controls.

- Panorama (**PANORAMA**) extends the front stereo image to include the surround speakers for an exciting “wraparound” effect.
- Dimension (**DIMENSION**) allows you to gradually adjust the sound field either towards the front or the rear.

- Center Width Control (**CENTER WDT**) allows center-channel sounds to be positioned between the center speaker and the left/right speakers. It improves the left-center-right stage presentation for both the driver and the front passenger.

1 Touch **NEXT** on the **DSP** function menu.

2 Touch **DOLBY PL II**.

3 Touch **MUSIC** and then touch **ADJUST**.

- You can operate **ADJUST** only when **MUSIC** has been selected.

4 Touch **▲** or **▼** to select **PANORAMA** (panorama).

Each time you touch **▲** or **▼** selects the item in the following order:

PANORAMA (panorama)—**DIMENSION** (dimension)—**CENTER WDT** (center width)

5 Touch **◀** to turn the panorama control on.

- To turn the panorama control off, touch **▶**.

6 Touch **▼** and then touch **◀** or **▶** to adjust front/surround speaker balance.

Each time you touch **◀** or **▶** it moves the sound towards the front or the surrounds.

+3 – **-3** is displayed as the front/surround speaker balance moves from front to surrounds.

7 Touch **▼** and then touch **◀** or **▶** to adjust the center image.

Each time you touch **◀** or **▶** it gradually spreads the center channel sound into the front left and right speakers over a range **0–7**. **3** is the default and it's recommended for most recordings. **0** places all center sound in the center speaker. **7** places all center sound equally in the left/right speakers. 

Setting the speaker setting

You need to make with/without (or yes/no) and size (bass reproducing capacity) selection/adjustments depending on the installed speakers. The size needs to be set to **LARGE** (large) if the speaker is capable of reproducing sounds of about 100 Hz or below. Otherwise select **SMALL** (small).

- Low frequency range is not output if the subwoofer is set to **OFF** and the front and rear speakers set to **SMALL** or **OFF**.
- It is imperative that non-installed speakers be set to **OFF**.
- Set the front or rear speaker to **LARGE** if the speaker is capable of reproducing bass content, or if no subwoofer is installed.

1 Touch **NEXT** on the **DSP** function menu.

2 Touch **SP SET**.

3 Touch **▲** or **▼** to select the speaker to be adjusted.

Each time you touch **▲** or **▼** selects the speaker in the following order:

FRONT (front speakers)—**CENTER** (center speaker)—**REAR** (rear speakers)—**SUB WOOFER** (subwoofer)—**PHASE** (subwoofer setting)

- You can switch to **PHASE** only when the subwoofer has been set to **ON**.

4 Touch **◀** or **▶** to select the correct size for the selected speaker.

Each time you touch **◀** or **▶** selects the size in the following order:

OFF (off)—**SMALL** (small)—**LARGE** (large)

- You cannot select **OFF**, when **FRONT** (front speakers) have been selected.
- You can select **ON** or **OFF**, when **SUB WOOFER** (subwoofer) has been selected.
- You can switch **REVERSE** (reverse phase) or **NORMAL** (normal phase), when **PHASE** (subwoofer setting) has been selected.

Digital Signal Processor

Correcting the subwoofer's phase

If trying to boost the bass output of the subwoofer doesn't do much or rather makes you feel that the bass gets more murky, this may indicate that the subwoofer's output and bass content you hear over other speakers cancel each other out. To remove this problem, try changing the phase setting for the subwoofer.

1 Touch **NEXT** on the **DSP** function menu.

2 Touch **SP SET**.

3 Touch **▲** or **▼** to select **SUB WOOFER** (subwoofer).

Each time you touch **▲** or **▼** selects the speaker in the following order:

FRONT (front speakers)—**CENTER** (center speaker)—**REAR** (rear speakers)
—**SUB WOOFER** (subwoofer)—**PHASE** (subwoofer setting)

4 Touch **◀** to turn subwoofer output on.

- To turn subwoofer output off, touch **▶**.

5 Touch **▼** and then touch **◀** or **▶** to select the phase of subwoofer output.

Touch **▶** to select normal phase and

NORMAL appears in the display. Touch **◀** to select reverse phase and **REVERSE** appears in the display.



Note

When playing a 2-channel mono source with Pro Logic turned on, there may be occasions when the following will occur:

- No audio is outputted if the center speaker setting is **SMALL** or **LARGE** and no center speaker is installed.
- Audio is heard only over the center speaker if installed and the center speaker setting is **SMALL** or **LARGE** 

Selecting a cross-over frequency

You can select a frequency, under which sounds are reproduced through the subwoofer. If the installed speakers include one whose size has been set to **SMALL**, you can select a frequency, under which sounds are reproduced through a **LARGE** speaker or subwoofer.

1 Touch **NEXT** on the **DSP** function menu.

2 Touch **CROSS OVER**.

3 Touch **▲** or **▼** to select the speaker to be adjusted.

Each time you touch **▲** or **▼** selects the speaker in the following order:

FRONT (front speakers)—**CENTER** (center speaker)—**REAR** (rear speakers)
—**SUB WOOFER** (subwoofer)

4 Touch **◀** or **▶** to select cross-over frequency.

Each time you touch **◀** or **▶** selects cut-off frequencies in the following order:

63—80—100—125—160—200 (Hz)



Note

Selecting a cross-over frequency is to set a cross-over frequency of the subwoofer's L.P.F. (low-pass filter) and that of the **SMALL** speaker H.P.F. (high-pass filter). The cross-over frequency setting has no effect if the subwoofer is set to **OFF** and other speakers are set to **LARGE** or **OFF**. 

Adjusting the speaker output levels

You can readjust the speaker output levels using a test tone while listening to music.

1 Touch NEXT on the DSP function menu.

2 Touch SP LEVEL.

3 Touch ▲ or ▼ to select the speaker to be adjusted.

Each time you touch ▲ or ▼ selects the speaker in the following order:

FRONT-L (front speaker left)—**CENTER** (center speaker)—**FRONT-R** (front speaker right)—**REAR-R** (rear speaker right)—**REAR-L** (rear speaker left)—**SUB WOOFER** (subwoofer)

- You cannot select speakers whose size is set at **OFF**.

4 Touch ◀ or ▶ to adjust the speaker output level.

Each time you touch ◀ or ▶ increases or decreases the speaker output level. **+10 – –10** is displayed as the level is increased or decreased.



Note

To adjust the speaker output levels in this mode is the same as making the speaker output levels at **TEST TONE**. Both provide the same results. □

Adjusting the speaker output levels using a test tone

A convenient test tone allows you to easily get the overall balance right among the speakers.

1 Touch NEXT on the DSP function menu.

2 Touch TEST TONE.

3 Touch START to start the test tone output.

The test tone is outputted. It rotates from speaker to speaker in the following sequence at intervals of about two seconds. The current

settings for the speaker over which you hear the test tone are shown in the display.

FRONT-L (front speaker left)—**CENTER** (center speaker)—**FRONT-R** (front speaker right)—**REAR-R** (rear speaker right)—**REAR-L** (rear speaker left)—**SUB WOOFER** (subwoofer)

Check each speaker output level. If no adjustments are needed, perform step 5 to stop the test tone.

- The settings do not appear for speakers whose size is set **OFF**.

4 Touch ◀ or ▶ to adjust the speaker output level.

Each time you touch ◀ or ▶ increases or decreases the speaker output level. **+10 – –10** is displayed as the level is increased or decreased.

- The test tone rotates to the next speaker after about two seconds from the last operation.

5 Touch STOP to stop the test tone output.



Notes

- If needed, select speakers and adjust their 'absolute' output levels. (Refer to *Adjusting the speaker output levels* on the previous page.)
- To adjust the speaker output levels in this mode is the same as making the speaker output levels at **SP LEVEL**. Both provide the same results. □

Digital Signal Processor

Using the time alignment

Only when the multi-channel processor (e.g., DEQ-P6600) is connected to this unit, you can operate this function.

The time alignment lets you adjust the distance between each speaker and the listening position.

1 Touch NEXT on the DSP function menu.

2 Touch TIME ALIGN.

3 Touch any of the following touch panel keys to select the time alignment.

- **INIT** – Initial time alignment (factory setting)
- **AUTOTA** – Time alignment created by auto TA and EQ. (Refer to *Auto TA and EQ (auto-time alignment and auto-equalizing)* on page 83.)
- **CUSTOM** – Adjusted time alignment that you can create for yourself
- **OFF** – Turn the time alignment off
- **ADJUST** – Adjust the time alignment as desired
 - You cannot select **AUTOTA** if auto TA and EQ has not been carried out.
 - You cannot select **ADJUST** when neither **FRONT-L** nor **FRONT-R** is selected in **POSITION**.

Adjusting the time alignment

You can adjust the distance between each speaker and the selected position.

- An adjusted time alignment is memorized in **CUSTOM**.

1 Touch NEXT on the DSP function menu.

2 Touch TIME ALIGN and then touch ADJUST.

- You cannot select **ADJUST** when neither **FRONT-L** nor **FRONT-R** is selected in **POSITION**.

3 Touch ▲ or ▼ to select the speaker to be adjusted.

Each time you touch ▲ or ▼ selects the speaker in the following order:

FRONT-L (front speaker left)—**CENTER** (center speaker)—**FRONT-R** (front speaker right)—**REAR-R** (rear speaker right)—**REAR-L** (rear speaker left)—**SUB WOOFER** (subwoofer)

- You cannot select speakers whose size is set at **OFF**.

4 Touch ◀ or ▶ to adjust the distance between the selected speaker and the listening position.

Each time you touch ◀ or ▶ increases or decreases the distance. **0.0 – 500.0 [cm]** is displayed as the distance is increased or decreased.

5 Touch ESC to return to the playback display. 

Using the equalizer

The equalizer lets you adjust the equalization to match car interior acoustic characteristics as desired.

Recalling equalizer curves

There are seven stored equalizer curves which you can easily recall at any time. Here is a list of the equalizer curves:

Display	Equalizer curve
POWERFUL	Powerful
NATURAL	Natural
VOCAL	Vocal
FLAT	Flat
CUSTOM1	Custom 1
CUSTOM2	Custom 2
SUPER BASS	Super bass

- **CUSTOM1** and **CUSTOM2** are adjusted equalizer curves.
- When **FLAT** is selected no supplement or correction is made to the sound. This is useful to check the effect of the equalizer curves by switching alternatively between **FLAT** and a set equalizer curve.

1 Press EQ and hold to switch to equalizer function.

Press **EQ** and hold until an equalizer curve name appears in the display.

- To switch to SFC function, press **EQ** and hold again.

2 Press EQ to select the equalizer.

Press **EQ** repeatedly to switch between the following equalizers:

POWERFUL—NATURAL—VOCAL—FLAT—CUSTOM1—CUSTOM2—SUPER BASS

Adjusting 3-band parametric equalizer

For **CUSTOM1** and **CUSTOM2** equalizer curves, you can adjust the front, rear and center equalizer curves separately by selecting a center frequency, an equalizer level and a Q factor for each band.

- A separate **CUSTOM1** curve can be created for each source.
- A **CUSTOM2** curve can be created common to all sources.
- The center speaker largely determines the sound image and getting the balance right isn't easy. We recommend reproducing a 2-ch. audio (a CD for example) and getting the balance right among the speakers except for the center, and then reproducing a 5.1-ch. audio (Dolby Digital or DTS) and adjusting the center speaker output to the balance you have already got among the other speakers.

1 Touch NEXT twice on the DSP function menu.

2 Touch PARA EQ.

3 Touch ▲ or ▼ to select the desired item.

Each time you touch ▲ or ▼ selects the item in the following order:

SP-SEL (speakers)—**BAND** (bands)
—**FREQUENCY** (center frequency)—**LEVEL** (equalizer level)—**Q. FACTOR** (Q factor)

4 Touch ◀ or ▶ to select the speaker to be adjusted.

Touch ◀ or ▶ until the desired speaker appears in the display.

REAR (rear speakers)—**CENTER** (center speaker)—**FRONT** (front speakers)

- You cannot select speakers whose size is set at **OFF**.

5 Touch ▼ and then touch ◀ or ▶ to select the equalizer band to be adjusted.

Each time you touch ◀ or ▶ selects equalizer bands in the following order:

LOW (low)—**MID** (mid)—**HIGH** (high)

6 Touch ▼ and then touch ◀ or ▶ to select the center frequency of selected band.

Touch ◀ or ▶ until the desired frequency appears in the display.

40Hz—50Hz—63Hz—80Hz—100Hz—125Hz—160Hz—200Hz—250Hz—315Hz—400Hz—500Hz—630Hz—800Hz—1kHz—1.25kHz—1.6kHz—2kHz—2.5kHz—3.15kHz—4kHz—5kHz—6.3kHz—8kHz—10kHz—12.5kHz

7 Touch ▼ and then touch ◀ or ▶ to adjust the equalizer level.

Each time you touch ◀ or ▶ increases or decreases the equalizer level. **+06—-06** is displayed as the level is increased or decreased.

Digital Signal Processor

8 Touch ▼ and then touch ◀ or ▶ to select the desired Q factor.

Each time you touch ◀ or ▶ switches between the following Q factor:

NARROW (narrow)—**WIDE** (wide)

- You can adjust parameters for each band of the other speakers in the same way.



Note

You can select a center frequency for each band. You can change the center frequency in 1/3-octave steps, but you cannot select frequencies that have intervals shorter than 1 octave among the center frequencies of the three bands. □

Using the auto-equalizer

The auto-equalizer is the equalizer curve created by auto TA and EQ (refer to *Auto TA and EQ (auto-time alignment and auto-equalizing)* on this page).

You can turn the auto-equalizer on or off.

1 Touch NEXT twice on the DSP function menu.

2 Touch AUTO EQ.

- You cannot use this function if auto TA and EQ has not been carried out.

3 Touch ▲ to turn the auto-equalizer on.

- To turn auto-equalizer off, touch ▼. □

Auto TA and EQ (auto-time alignment and auto-equalizing)

Only when the multi-channel processor (e.g., DEQ-P6600) is connected to this unit, you can operate this function.

The auto-time alignment is automatically adjusted for the distance between each speaker and the listening position.

The auto-equalizer automatically measures the car interior acoustic characteristics, and then creates the auto-equalizer curve based on that information.



WARNING

To prevent accidents, never carry out auto TA and EQ while driving. When this function measures the car interior acoustic characteristics to create an auto-equalizer curve, a loud measurement tone (noise) may be outputted from the speakers.



CAUTION

- Carrying out auto TA and EQ under the following conditions may damage the speakers. Be sure to check the conditions thoroughly before carrying out auto TA and EQ.
 - When speakers are incorrectly connected. (e.g., When a rear speaker is connected to a subwoofer output.)
 - When a speaker is connected to a power amp delivering output higher than the speaker's maximum input power capability.
- If the microphone is placed in an unsuitable position the measurement tone may become loud and measurement may take a long time, resulting in a drain on battery power. Be sure to place the microphone in the specified location.

Before operating the auto TA and EQ function

- Carry out auto TA and EQ in as quiet a place as possible, with the car engine and air conditioning switched off. Also cut power to car phones or portable telephones in the car, or remove them from the car before carrying out auto TA and EQ. Sounds other than the measurement tone (surrounding sounds, engine sound, telephones ringing etc.) may prevent correct measurement of the car interior acoustic characteristics.
- Be sure to carry out auto TA and EQ using the supplied microphone. Using another microphone may prevent measurement, or result in incorrect measurement of the car interior acoustic characteristics.
- When front speaker is not connected, auto TA and EQ cannot be carried out.
- When this unit is connected to a power amp with input level control, auto TA and EQ may not be possible if you lower power amp input level. Set the power amp's input level to the standard position.
- When this unit is connected to a power amp with an LPF, turn off the LPF on the power amp before carrying out auto TA and EQ. In addition, the cut-off frequency for built-in LPF of an active subwoofer should be set to the highest frequency.
- The time alignment value calculated by auto TA and EQ may differ from the actual distance in the following circumstances. However, the distance has been calculated by computer to be the optimum delay to give accurate results for the circumstances, so please continue to use this value.
 - When the reflected sound within a vehicle is strong and delays occur.
 - When delays occur for low sounds due to the influence of the LPF on active subwoofers or external amps.

- Auto TA and EQ changes the audio settings as below:
 - The fader/balance settings return to the center position. (Refer to page 76.)
 - The equalizer curve switches to **FLAT**. (Refer to page 81.)
 - It will be adjusted automatically to high pass filter setting for front, center and rear speaker.
- If you carry out auto TA and EQ when a previous setting of this already exists, the setting will be replaced.

Carrying out auto TA and EQ

1 Stop the car in a place that is as quiet as possible, close all doors, windows and the sun roof, and then turn the engine off.

If the engine is left running, engine noise may prevent correct auto TA and EQ.

2 Fix the supplied microphone in the center of the headrest of the driver's seat, facing forward, using the belt (sold separately).

The auto TA and EQ may differ depending on where you place the microphone. If desired, place the microphone on the front passenger seat to carry out auto TA and EQ.

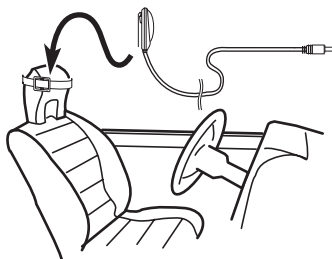

3 Turn the ignition switch to ON or ACC.

If the car's air conditioner or heater is turned on, turn it off. Noise from the fan in the air conditioner or heater may prevent correct auto TA and EQ.

Digital Signal Processor

- Press **SOURCE** to turn the source on if this unit is turned off.

4 Select the position for the seat on which the microphone is placed.

Refer to *Using the position selector* on page 75.

- If no position is selected before you start auto TA and EQ, **FRONT-L** is selected automatically.

5 Press SOURCE and hold until the unit turns off.

6 Press and hold EQ to enter the auto TA and EQ measurement mode.

7 Plug the microphone into the microphone input jack on the multi-channel processor.

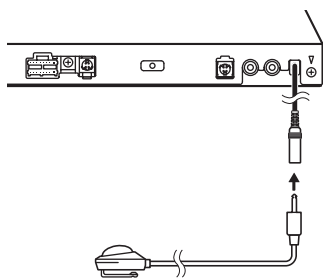

For details concerning operation, refer to the multi-channel processor's operation manual.

8 Touch START to start the auto TA and EQ.

9 Get out of the car and close the door within 10 seconds when the 10-second count-down starts.

The measurement tone (noise) is outputted from the speakers, and auto TA and EQ begins.

- When all speakers are connected, auto TA and EQ is completed in about nine minutes.

- To stop auto TA and EQ, touch **STOP**.
- To cancel auto TA and EQ part way through, touch **BACK** or **ESC**.

10 When auto TA and EQ is completed, Complete is displayed.

When correct measurement of car interior acoustic characteristics is not possible, an error message is displayed. (Refer to *Understanding auto TA and EQ error messages* on page 102.)

11 Touch ESC to cancel the auto TA and EQ mode.

12 Store the microphone carefully in the glove compartment.

Store the microphone carefully in the glove compartment or any other safe place. If the microphone is subjected to direct sunlight for an extended period, high temperatures may cause distortion, color change or malfunction. []

Setting up the DVD player

Introduction of DVD setup adjustments

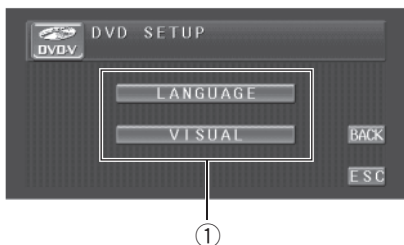

You can use this menu to change audio, subtitle, parental lock and other DVD settings.

① DVD setup menu display

Shows the DVD setup menu names.

1 Touch ■.

SETUP will be displayed instead of **MENU**.

2 Touch **SETUP** when the disc is stopped.

The DVD setup menu is displayed.

3 Touch any of **LANGUAGE** or **VISUAL** to display the DVD setup function names.

The DVD setup function names in selected menu are displayed.

- To return to the previous display, touch **BACK**.
- To return to the playback display, touch **ESC**.



Note

If you do not operate the DVD setup function within about 30 seconds, the display is automatically returned to the playback display. ▣

Setting the subtitle language

You can set a desired subtitle language. If the selected subtitle language is recorded on the DVD, subtitles are displayed in that language.

1 Touch **SETUP** and **LANGUAGE** and then touch **SUB. T LANG.**

A subtitle language menu is displayed and the currently set language is highlighted.

- To switch to the second language select menu, touch **NEXT**.
- To return to the first language select menu, touch **PREV**.

2 Touch the desired language.

A subtitle language is set.

- If you have selected **OTHERS**, refer to *When you select OTHERS* on this page.



Notes

- If the selected language is not recorded on the disc, the language specified on the disc is displayed.
- You can also switch the subtitle language by touching **SUB.T** during playback. (Refer to *Changing the subtitle language during playback (Multi-subtitle)* on page 35.)
- Even if you use **SUB.T** to switch the subtitle language, this does not affect the settings here.

When you select **OTHERS**

When you select **OTHERS**, a language code input display is shown. Refer to *Language code chart for DVD* on page 109 to input the four-digit code of the desired language.

1 Touch **0—9** to input the language code.

- To cancel the inputted numbers, touch **C**.

2 While the inputted number is displayed, touch **ENTER**. ▣

Setting up the DVD player

Setting the audio language

You can set the preferred audio language.

1 Touch **SETUP** and **LANGUAGE** and then touch **AUDIO LANG**.

An audio language menu is displayed and the currently set language is highlighted.

- To switch to the second language select menu, touch **NEXT**.
- To return to the first language select menu, touch **PREV**.

2 Touch the desired language.

The audio language is set.

- If you have selected **OTHERS**, refer to *When you select OTHERS* on the previous page.



Notes

- If the selected language is not recorded on the disc, the language specified on the disc is outputted.
- You can also switch the audio language by touching **AUDIO** during playback. (Refer to *Changing audio language during playback (Multi-audio)* on page 34.)
- Even if you use **AUDIO** to switch the audio language, this does not affect the settings here. 

Setting the menu language

You can set the preferred language for displays of menus recorded on a disc.

1 Touch **SETUP** and **LANGUAGE** and then touch **MENU LANG**.

A menu language menu is displayed and the currently set language is highlighted.

- To switch to the second language select menu, touch **NEXT**.
- To return to the first language select menu, touch **PREV**.

2 Touch the desired language.

The menu language is set.

- If you have selected **OTHERS**, refer to *When you select OTHERS* on the previous page.



Note

If the selected language is not recorded on the disc, the language specified on the disc is displayed. 

Setting assist subtitles on or off

Assist subtitles offer explanations for the aurally impaired. However, they are only displayed if they are recorded on the DVD.

You can turn assist subtitles on or off as desired.

1 Touch **SETUP** and **LANGUAGE** and then touch **NEXT**.

2 Touch **A SUB TITL** to turn assist subtitles on.

- To turn assist subtitles off, touch **A SUB TITL** again. 

Setting angle icon display

You can set it up so that the angle icon appears on scenes where the angle can be switched.

1 Touch **SETUP** and **VISUAL** to display the **DVD visual set up menu**.

2 Touch **M. ANGLE** to turn angle icon display on.

- To turn angle icon display off, touch **M. ANGLE** again. 

Setting up the DVD player

Setting the aspect ratio

There are two kinds of display. A wide screen display has a width-to-height ratio (TV aspect) of 16:9, while a regular display has a TV aspect of 4:3. Be sure to select the correct TV aspect for the display connected to **VIDEO OUTPUT**.

- When using a regular display, select either **LETTER BOX** or **PANSCAN**. Selecting **16:9** may result in an unnatural picture.
- If you select the TV aspect, the unit's display changes to the same setting.

1 Touch SETUP and VISUAL and then touch TV ASPECT.

2 Touch any of the following touch panel keys to select the TV aspect.

- **16:9** – Wide screen picture (16:9) is displayed as it is (initial setting)
- **LETTER BOX** – The picture is the shape of a letterbox with black bands at the top and bottom of the screen
- **PANSCAN** – The picture is cut short at the right and left of the screen



Notes

- When playing discs that do not specify **PANSCAN**, playback is with **LETTER BOX** even if you select **PANSCAN** setting. Confirm whether the disc package bears the **16:9 LB** mark. (See page 12.)
- Some discs do not enable changing of the TV aspect. For details, refer to the disc's instructions. 

Setting the parental lock

Some DVD video discs let you use parental lock to restrict the viewing of violent and adult-oriented scenes by children. You can set the parental lock level in steps as desired.

- When you set a parental lock level and then play a disc featuring parental lock, code number input indications may be displayed. In this case, playback will begin when the correct code number is input.

Setting the code number and level

When you first use this function, register your code number. If you do not register a code number, parental lock will not operate.

1 Touch SETUP and VISUAL and then touch PARENTAL.

2 Touch 0—9 to input a four digit code number.

3 While the inputted number is displayed, touch ENTER.

The code number is set, and you can now set the level.

4 Touch any of 1—8 to select the desired level.

The parental lock level is set.

- **LEVEL 8** – Playback of the entire disc is possible (initial setting)
- **LEVEL 7–LEVEL 2** – Playback of discs for children and non-adult-oriented discs is possible
- **LEVEL 1** – Playback of discs for children only is possible



Notes

- We recommend to keep a record of your code number in case you forget it.
- The parental lock level is recorded on the disc. You can confirm it by looking at the disc package, included literature or on the disc itself. With discs that do not feature a recorded parental lock level, you cannot use parental lock.

Setting up the DVD player

- With some discs, parental lock operates to skip certain scenes only, after which normal playback resumes. For details, refer to the disc's instructions.

Changing the level

You can change the set parental lock level.

1 Touch SETUP and VISUAL and then touch PARENTAL.

2 Touch 0—9 to input the registered code number.

3 Touch ENTER.

This enters the code number, and you can now change the level.

- If you input an incorrect code number, the icon  is displayed. Touch **C** and input the correct code number.
- If you forget your code number, refer to *If you forget your code number* on this page.

4 Touch any of 1—8 to select the desired level.

The new parental lock level is set.

If you forget your code number

Refer to *Changing the level* on this page, and touch **C** 10 times. The registered code number is canceled, letting you register a new one. .

Adjusting initial settings

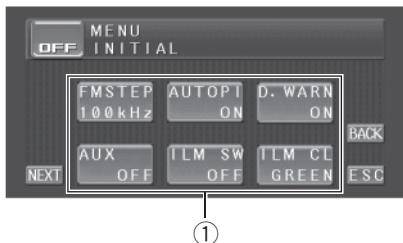

Initial settings lets you perform initial setup of different settings for this unit.

① Function display

Shows the function names.

1 Touch the source icon and then touch OFF to turn this unit off.

- When the source icon is not displayed, you can display it by touching the screen.

2 Press A.MENU button and touch INIT to display the initial function names.

The function names are displayed and operable ones are highlighted.

- To go to the next group of function names, touch **NEXT**.
- To return to the previous group of function names, touch **PREV**.
- When the multi-channel processor (e.g., DEQ-P6600) is connected to this unit, you can operate **D. ATT** and **RESET** instead of **REARSP**.
- To return to the previous display, touch **BACK**.
- To return to the display of each source, touch **ESC**.

Setting the FM tuning step

Normally the FM tuning step employed by seek tuning is 50 kHz. When AF or TA is on, the tuning step automatically changes to 100

kHz. It may be preferable to set the tuning step to 50 kHz when AF is on.

● Touch FMSTEP on the initial menu to select the FM tuning step.

Touching **FMSTEP** will switch the FM tuning step between 50 kHz and 100 kHz while AF or TA is on. The selected FM tuning step will appear in the display.



Note

The tuning step remains at 50 kHz during manual tuning.

Switching Auto PI Seek

The unit can automatically search for a different station with the same programming, even during preset recall.

● Touch AUTOPI on the initial menu to turn Auto PI Seek on.

- To turn Auto PI Seek off, touch **AUTOPI** again.

Switching the warning tone

If the front panel is not detached from the head unit within five seconds of turning off the ignition, a warning tone will sound. You can turn off the warning tone.

● Touch D. WARN on the initial menu to turn warning tone on.

- To turn warning tone off, touch **D. WARN** again.

Initial Settings

Switching the auxiliary setting

It is possible to use auxiliary equipment with this unit. Activate the auxiliary setting when using auxiliary equipment connected to this unit.

- **Touch AUX on the initial menu to turn auxiliary setting on.**

- To turn auxiliary setting off, touch **AUX** again. 

Setting the illumination switch

You can choose whether to have the illumination of this unit switch on/off when the ignition key is turned to the ACC position or the power-off position.

- When the navigation unit or AVG-VDP1 is connected to this unit, you cannot operate this function.
- **Touch ILM SW on the initial menu to turn the illumination switch on.**

Set the illumination switch ON to have the illumination of this unit remain on when the ignition key is turned to the ACC position. Set to OFF to have the illumination off when the ignition key is turned to the ACC position.

- To turn the illumination switch off, touch **ILM SW** again.



Note

Never set the illumination switch on if the vehicle does not have the ACC position. It may cause battery leakage. 

Selecting the illumination color

This unit is equipped with two illumination colors, green and red. You can select the desired illumination color.

- **Touch ILM CL on the initial menu to select the desired illumination color.**

Touching **ILM CL** will switch the illumination color between **GREEN** (green) and **RED** (red). 

Setting the rear output and subwoofer controller

This unit's rear output (rear speaker leads output) can be used for full-range speaker (**FULL**) or subwoofer (**SUB. W**) connection. If you switch the rear output setting to the **SUB. W**, you can connect a rear speaker lead directly to a subwoofer without using an auxiliary amp. Initially, the unit is set for rear full-range speaker connection (**FULL**). When rear output is connected to full range speakers (when **FULL** is selected), you can connect the RCA subwoofer output to a subwoofer. In this case, you can select whether to use the subwoofer controller's (low pass filter, phase) built-in **SUB.W** or the auxiliary **FULL**.

- When the multi-channel processor (e.g., DEQ-P6600) is connected to this unit, you cannot operate this function.

1 Touch NEXT on the initial menu.

2 Touch REARSP.

3 Touch ▲ or ▼ to switch the rear output setting.

Touch **▲** to select full-range speaker and **FULL** appears in the display. Touch **▼** to select subwoofer and **SUB. W** appears in the display.

- When no subwoofer is connected to the rear output, select **FULL**.
- When a subwoofer is connected to the rear output, set for subwoofer **SUB. W**.
- When the rear output setting is **SUB. W**, you cannot change the subwoofer controller.

4 Touch ◀ or ▶ to switch the subwoofer output or non fading output.

Touch ◀ to select subwoofer output and **SUB.W** appears in the display. Touch ▶ to select non fading output and **FULL** appears in the display.



Notes

- Even if you change this setting, there is no output unless you turn the nonfading output (refer to *Using nonfading output* on page 72) or subwoofer output (refer to *Using subwoofer output* on page 72) in the audio menu on.
- If you change the subwoofer controller, subwoofer output and nonfading output in the audio menu return to the factory settings.

Correcting distorted sound

You can minimize distortion that may be caused by the equalizer curve settings. Setting an equalizer level high can cause distortion. If high sound is crippled or distorted, try switching to **LOW**. Normally, leave the setting at **HIGH** to ensure quality sound.

- Only when the multi-channel processor (e.g., DEQ-P6600) is connected to this unit, you can operate this function.

1 Touch NEXT on the initial menu.

2 Touch D. ATT to switch the digital attenuator setting.

Touching **D. ATT** switches the digital attenuator settings in the following order:

HIGH—LOW

Switching the sound muting/attenuation

Sound from this system is muted, attenuated or mixed automatically in the following cases:

- When a call is made or received using a cellular telephone connected to this unit.
- When the voice guidance is output from a Pioneer navigation unit connected to this unit.

1 Touch NEXT on the initial menu.

2 Touch TEL/GUIDE to select any of the muting, attenuation, mixing or off.

Touch **TEL/GUIDE** until the desired setting appears in the display.

- **MUTE** – Muting
- **ATT 20** – Attenuation (**ATT 20** has a stronger effect than **ATT 10**)
- **ATT 10** – Attenuation
- **OFF** – Turn the sound muting/attenuation off



Notes

- The sound is turned off or attenuated, **MUTE** or **ATT** are displayed and no audio adjustment is possible.
- Operation returns to normal when the phone connection or the voice guidance is ended.

Initial Settings

Mixing navigation voice/AVG-VDP1 beep and audio sound

Mixing navigation voice/beep and audio sound

When there is a navigation guidance, you can mix the guidance voice/beep sound from a Pioneer navigation unit with the audio sound from this system. You can select either mixing both the guidance voice and the beep sound or the guidance voice only.

- You can operate this function only when a Pioneer navigation unit is connected to this unit.
- When the multi-channel processor (e.g., DEQ-P6600) is connected to this unit, you cannot use this function.
- We recommend that you select **GUIDE** to ensure quality sound.

1 Touch NEXT on the initial menu.

2 Touch NAVI MIX to switch the mixing of navigation voice/beep.

Touching **NAVI MIX** will switch the mixing of navigation between **ALL** (mixing both guidance voice and beep) and **GUIDE** (mixing guidance voice only).

Mixing AVG-VDP1 beep and audio sound

When connecting the AVG-VDP1 to this unit, a beep sound is occasionally outputted from the AVG-VDP1. To ensure the quality audio sound from this unit, set this function to **GUIDE** to properly mix the beep sound and the audio sound.

- You can operate this function only when a Pioneer Vehicle Dynamics Processor (AVG-VDP1) is connected to this unit.

- When the multi-channel processor (e.g., DEQ-P6600) is connected to this unit, you cannot use this function.
- We recommend that you select **GUIDE** to ensure quality sound.

1 Touch NEXT on the initial menu.

2 Touch NAVI MIX to switch the mixing of AVG-VDP1 beep.

Touching **NAVI MIX** switches the mixing settings between **ALL** (mixing all the time) and **GUIDE** (mixing when a beep sound is outputted). 

Resetting the audio functions

You can reset all audio functions except volume.

- Only when the multi-channel processor (e.g., DEQ-P6600) is connected to this unit, you can operate this function.

1 Touch NEXT on the initial menu.

2 Touch RESET.

3 Touch RESET.

4 Touch RESET again to reset audio functions.

- To cancel resetting the audio functions, touch **CANCEL**. 

Setting the TV signal

When this unit is connected to a TV tuner, you need to adjust the TV signal suitable to your country TV signal setting.

- This function is initially set to **AUTO** so that this unit automatically adjusts the TV signal setting.

1 Touch NEXT on the initial menu.

2 Touch TV SIG to select an appropriate TV signal.

Touching **TV SIG** switches TV signal settings in the following order:

AUTO—PAL—SECAM



Note

About your country TV signal, consult with your nearest Pioneer dealer. 

Other Functions

Introduction of setup adjustments

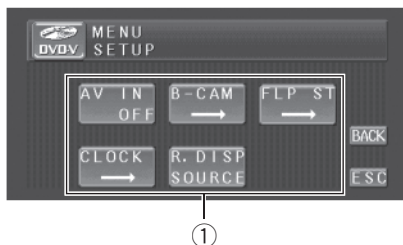

① Setup menu display

Shows the setup function names.

● Press A.MENU button and touch SETUP to display the setup function names.

The setup function names are displayed and operable ones are highlighted.

- To return to the previous display, touch **BACK**.
- To return to the display of each source, touch **ESC**.

Note

If you do not operate the setup function within about 30 seconds, the display is automatically returned to the source display. 

Setting the AV input

You can switch the setting according to the connected component.

- Select **VIDEO** to watch video of a connected component as **AV** source.
- Select **M-DVD** to watch video of a connected DVD player as **S-DVD** source.
- Select **EXT-V** to watch video of a connected video unit as **EXT** source.

● Touch AV IN on the setup menu to select the AV input setting.

Touch **AV IN** until the desired setting appears in the display.

- **OFF** – No video component is connected
- **VIDEO** – External video component (such as portable video player)
- **M-DVD** – Multi-DVD player connected with RCA cable
- **EXT-V** – External video unit (such as Pioneer products available in the future)
 - When a multi-DVD player is connected with an AV-BUS cable, do not select **M-DVD** otherwise no picture will be displayed even if you select **S-DVD**. 

Setting for rear view camera

CAUTION

Pioneer recommends the use of a camera which outputs mirror reversed images, otherwise screen image may appear reversed.

This unit features a function that automatically switches to the rear view camera video (**REAR VIEW CAMERA IN** jack) when a rear view camera is installed on your vehicle. When the gear shift is in **REVERSE (R)** position, the video automatically switches to a rear view camera video. (For more details, consult your dealer.)

- Confirm the setting immediately whether the display changes to a rear view camera video when the gear shift is moved to **REVERSE (R)** from another position.
- When the display changes to a rear view camera video during normal drivings, switch to another setting.
- To return to the source display, press **V.ADJ**.

1 Touch B-CAM on the setup menu.

2 Touch ◀ to turn rear view camera setting on.

- To turn rear view camera setting off, touch ▶.

3 Touch ▼ and then touch ◀ or ▶ to select an appropriate setting for polarity.

Each time you touch ◀ or ▶ it switches between the following polarity:

- **BATTERY** – When the polarity of the connected lead is positive while the gear shift is in **REVERSE (R)** position
- **GND** – When the polarity of the connected lead is negative while the gear shift is in **REVERSE (R)** position 

Monitoring rear view

You can display the image from the rear view camera at all time (e.g. to monitor an attached trailer). The rear view image is displayed in the small window over the navigation map image. To display the rear view image, both the navigation unit and the rear view camera must be connected to this unit.

1 Touch B-CAM on the setup menu.

2 Touch ▼ until P in P is selected.

- When **B. CAMERA** is set to off, you cannot select **P in P**.

3 Touch ◀ to turn the picture in picture setting on.

- To turn the picture in picture setting off, touch ▶.

4 Touch ▼ to select PinP SIZE.

5 Touch ◀ or ▶ to select a favorite size for the rear view picture.

Each time you touch ◀ or ▶ it switches between the following picture sizes:

1/16—1/9—1/4

6 Touch ▼ to select PinP POS.

7 Touch ◀ or ▶ to select a favorite position for the rear view picture.

Each time you touch ◀ or ▶ it switches between the following picture position:

UPPER L (upper left)—**UPPER R** (upper right)
—**LOWER R** (lower right)—**LOWER L** (lower left)

Turning the rear view picture ON/OFF instantly

If the rear view picture is blocking your view of the navigation image or AVG-VDP1, you can turn it on or off instantly.

- Touch **ENTERTAINMENT (ENT)** and hold to turn the rear view picture on/off. 

Setting the automatic open function

To prevent the display from hitting the shift lever of an automatic vehicle when it is in **P** (park) position, or when you do not wish the display to open/close automatically, you can set the automatic open function in the manual mode.

Furthermore, to adjust the LCD panel slide position, you can turn the set back on or off.

1 Touch FLP ST on the setup menu.

2 Touch ▲ to turn the set back on and the LCD panel slides to the back.

- Touch ▼ to turn the set back off and the LCD panel slides to the front.

Other Functions

3 Touch ◀ or ▶ to select the display to open/close automatically or manually.

Touch ◀ to select **MANUAL**, and you have to press **OPEN/CLOSE** to open/close the display. Touch ▶ to select **AUTO**, and the display automatically opens/closes when power to this unit is turned on. 

Setting the clock

Use these instructions to set the clock.

1 Touch **CLOCK ADJUST** on the setup menu.

2 Touch **OFF** to turn the clock display on.

ON will appear in the display instead of **OFF**. Clock display is now on.

- To turn the clock display off, touch **ON**.

3 Touch ◀ or ▶ to select the segment of the clock display you wish to set.

Each time you touch ◀ or ▶ it will select one segment of the clock display:

Hour—Minute

As you select segments of the clock display the segment selected will be highlighted.

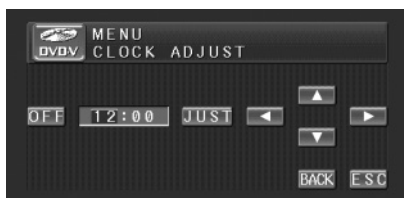

4 Touch ▲ or ▼ to set the clock.

Each time you touch ▲ it increases the selected hour or minute. Each time you touch ▼ it decreases the selected hour or minute.



Notes

- You can match the clock to a time signal by touching **JUST**.
 - If the minute is **00—29**, the minutes are rounded down. (e.g., **10:18** becomes **10:00**.)
 - If the minute is **30—59**, the minutes are rounded up. (e.g., **10:36** becomes **11:00**.)
- Even when the sources are off, the clock display appears on the display. 

Selecting video on rear display

You can set the rear display to automatically switch to the navigation image or AVG-VDP1 with the front display. Alternatively, you can set it to remain showing the selected video source and not change with the front display.

- The navigation image or the AVG-VDP1 can be displayed when a Pioneer navigation unit or a Vehicle Dynamics Processor is connected to this unit.
- When selecting **SOURCE** and the selected source is an audio source, nothing is displayed on rear display.

● Touch **R.DISP** on the setup menu to display video of the selected source on rear display.

Touch **R.DISP** until the desired video setting appears in the display.

- **SOURCE** – Display the video of the selected source on rear display
- **NAVI** – Display the navigation image or AVG-VDP1 on rear display 

Using the AUX source

An IP-BUS-RCA Interconnector such as the CD-RB20/CD-RB10 (sold separately) lets you connect this unit to auxiliary equipment featuring RCA output. For more details, refer to the IP-BUS-RCA Interconnector owner's manual.

Selecting AUX as the source

- **Touch the source icon and then touch AUX to select AUX as the source.**
 - When the source icon is not displayed, you can display it by touching the screen.
 - If the auxiliary setting is not turned on, **AUX** cannot be selected. For more details, see *Switching the auxiliary setting* on page 91.

Setting the AUX title

The title displayed for the **AUX** source can be changed.

- 1 After you have selected AUX as the source, press A.MENU button and touch FUNCTION and then touch NAME EDIT.**
- 2 Touch ABC to select the desired character type.**
Touch **ABC** repeatedly to switch between the following character types:
Alphabet (upper case), numbers and symbols—Alphabet (lower case)—European letters, such as those with accents (e.g., **â, à, ä, ç**)
 - You can select to input numbers and symbols by touching **123**.
- 3 Touch ▲ or ▼ to select a letter of the alphabet.**
Each time you touch **▲** it will display a letter of the alphabet in **A B C ... X Y Z**, numbers and symbols in **1 2 3 ... |}** order. Each time you

touch **▼** it will display a letter in the reverse order, such as **Z Y X ... C B A**.

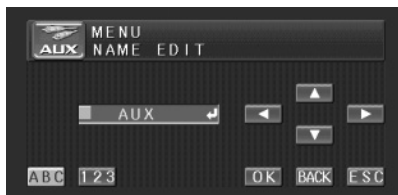

- 4 Touch ► to move the cursor to the next character position.**

When the desired letter is displayed, touch **►** to move the cursor to the next position and then select the next letter. Touch **◀** to move backwards in the display.

- 5 Touch OK to store the entered title in memory.**

- 6 Touch ESC to return to the playback display.** 

Selecting the background display

You can switch background displays while listening to each source.

- **Press ENTERTAINMENT (ENT).**
Each time you press **ENTERTAINMENT (ENT)** the display changes in the following order:
Audio source
Background still picture—**BGV** (background visual)—**AV** (AV input)—**NAVI** (navigation unit wallpaper or AVG-VDP1 wallpaper)
Video source
Video of currently selected source—background still picture—**BGV** (background visual)—**AV** (AV input)—**NAVI** (navigation unit wallpaper or AVG-VDP1 wallpaper)

**Note**

In the following cases, the background display will not change:

- When a list is displayed.
- When the AV (AV input) is not set to **VIDEO** (refer to page 95).
- When a Pioneer navigation unit or a Vehicle Dynamics Processor is not connected to this unit. 

Additional Information

Troubleshooting

Common

Symptom	Cause	Action (See)
Power doesn't turn on. The unit doesn't operate.	Leads and connectors are incorrectly connected.	Confirm once more that all connections are correct.
	The fuse is blown.	Rectify the reason for the fuse blowing, then replace the fuse. Be very sure to install the correct fuse with the same rating.
	Noise and other factors are causing the built-in microprocessor to operate incorrectly.	Press RESET . (Page 12)
Playback is not possible.	The disc is dirty.	Clean disc. (Page 104)
	The loaded disc is a type this unit cannot play.	Check what type the disc is.
	Non compatible video system disc is loaded.	Change to a disc compatible to your video system.
No sounds are heard. The volume level will not rise.	Cables are not connected correctly.	Connect the cables correctly.
	The unit is performing still, slow motion or frame-by-frame playback.	There is no sound during still, slow motion or frame-by-frame playback.
There is no picture.	The parking brake cord is not connected.	Connect a parking brake cord, and apply the parking brake.
	The parking brake is not applied.	Connect a parking brake cord, and apply the parking brake.
The icon  is displayed, and operation is not possible.	The operation is prohibited for the disc.	This operation is not possible.
	The operation is not compatible with the disc's organization.	This operation is not possible.
The picture stops (pauses) and the unit cannot be operated.	Reading of data has become impossible during playback.	After pressing ■ once, start playback once more.
There is no sound. Volume level is low.	The volume level is low.	Adjust the volume level.
	The attenuator is on.	Turn the attenuator off.
There is audio and video skipping.	The unit is not firmly secured.	Secure the unit firmly.
The picture is stretched, the aspect is incorrect.	The aspect setting is incorrect for the display.	Select the appropriate setting for your display. (Page 88)
When the ignition switch is turned ON (or turned to ACC), the motor sounds.	The unit is confirming whether a disc is loaded or not.	This is a normal operation.
Nothing is displayed. The touch panel keys cannot be used.	The rear view camera is not connected. B-CAM is at incorrect setting.	Connect a rear view camera. Press VADJ to return to the source display and then select the correct setting for B-CAM . (Page 95)

Additional Information

Symptom	Cause	Action (See)
The rear view picture (or a black image when the rear view camera is not connected) over the navigation image cannot be turned off.	P in P setting is ON.	Press ENTERTAINMENT (ENT) button and hold to turn the rear view picture OFF.

Problems during DVD playback

Symptom	Cause	Action (See)
Playback is not possible.	The loaded disc has a different region number from this unit.	Replace the disc with one featuring the same region number as this unit. (Page 8, Page 111)
A parental lock message is displayed and playback is not possible.	Parental lock is on.	Turn parental lock off or change the level. (Page 88)
Parental lock cannot be canceled.	The code number is incorrect.	Input the correct code number. (Page 88)
	You have forgotten your code number.	Press CLEAR 10 times to cancel the code number. (Page 89)
Dialog language (and subtitle language) cannot be switched.	The DVD playing does not feature multiple language recordings.	You cannot switch among multiple languages if they are not recorded on the disc.
	You can only switch between items indicated in the disc menu.	Switch using the disc menu.
No subtitles are displayed.	The DVD playing does not feature subtitles.	Subtitles are not displayed if they are not recorded on the disc.
	You can only switch between items indicated in the disc menu.	Switch using the disc menu.
Playback is not with the audio language and subtitle language settings selected in DVD SETUP .	The DVD playing does not feature dialog or subtitles in the language selected in DVD SETUP .	Switching to a selected language is not possible if the language selected in DVD SETUP is not recorded on the disc.
Switching the viewing angle is not possible.	The DVD playing does not feature scenes shot from multiple angles.	You cannot switch between multiple angles if the DVD does not feature scenes recorded from multiple angles.
	You are trying to switch to multiple angle viewing of a scene that is not recorded from multiple angles.	Switch between multiple angles when watching scenes recorded from multiple angles.
The picture is extremely unclear/distorted and dark during playback.	The disc features a signal to prohibit copying. (Some discs may have this.)	Since this unit is compatible with the copy guard analog copy protect system, when playing a disc that has a signal prohibiting copying, the picture may suffer from horizontal stripes or other imperfections when viewed on some displays. This does not mean this unit is malfunctioning.

Additional Information

Problems during Video CD playback

Symptom	Cause	Action (See)
The PBC (playback control) menu display cannot be called up.	The Video CD playing does not feature PBC.	This operation is not possible with Video CDs not featuring PBC.
Repeat play and track/time search are not possible.	The Video CD playing features PBC.	This operation is not possible with Video CDs featuring PBC.



Error messages

When you contact your dealer or your nearest Pioneer Service Center, be sure to record the error message.

Message	Cause	Action (See)
ERROR-02	Dirty disc	Clean disc.
	Scratched disc	Replace disc.
ERROR-05	Electrical or mechanical	Press RESET .
DIFFERENT REGION DISC (REGION ERR)	The disc does not have the same region number as this unit	Replace the DVD video with one bearing the correct region number.
NON PLAYABLE DISC (NON-PLAY)	This type of disc cannot be played by this unit	Replace the disc with one this unit can play.
	The disc is loaded upside down	Check that the disc is loaded correctly.
THERMAL PROTECTION IN MOTION (TEMP)	The temperature of this unit is outside the normal operating range	Wait until the unit's temperature returns to within normal operating limits.
PROTECT	All the files on the inserted disc are secured by digital rights management (DRM)	Replace disc.
TRK SKIPPED	The inserted disc contains WMA files that are protected by digital rights management (DRM)	Replace disc.



Understanding auto TA and EQ error messages

When correct measurement of car interior acoustic characteristics is not possible using the auto TA and EQ, an error message may appear on the display. If an error message appears, refer to the table below to see what the problem is and the suggested method of correcting the problem. After checking, try again.

Additional Information

Message	Cause	Action
Error check MIC	Microphone is not connected.	Plug the supplied microphone securely into the jack.
Error check front SP, Error check FL SP, Error check FR SP, Error check center SP, Error check RL SP, Error check RR SP, Error check subwoofer	The microphone cannot pick up the measuring tone of a speaker.	<ul style="list-style-type: none"> • Confirm that the speakers are connected correctly. • Correct the input level setting of the power amp connected to the speakers. • Set the microphone correctly.
Error check noise	The surrounding noise level is too high.	<ul style="list-style-type: none"> • Stop your car in a place that is as quiet as possible, and switch off the engine, air conditioner or heater. • Set the microphone correctly.



Understanding messages

Messages	Translation
VIDEO VIEWING IS NOT AVAILABLE WHILE DRIVING	Video viewing is not available when driving.
YOU CANNOT USE THIS FUNCTION WHILE DRIVING	You cannot use this function while driving.
Please source unit off Hold EQ button 2 sec, Set Auto EQ&TA	Please source unit off. Hold EQ button 2 seconds. Set Auto EQ&TA.
Can't adjust Time Alignment. Set Position FL or FR	Can't adjust Time Alignment. Set Position FL or FR.
Press track list to play and title will appear	Press track list to play and title will appear.



Additional Information

DVD player and care

- Use only normal, round discs. If you insert irregular, non-round, shaped discs they may jam in the DVD player or not play properly.

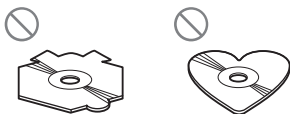

- Check all discs for cracks, scratches or warping before playing. Discs that have cracks, scratches or are warped may not play properly. Do not use such discs.
- Avoid touching the recorded (non-printed) surface when handling the disc.
- Store discs in their cases when not in use.
- Keep discs out of direct sunlight and do not expose the discs to high temperatures.
- Do not attach labels, write on or apply chemicals to the surface of the discs.
- To clean a disc, wipe the disc with a soft cloth outward from the center.



- If the heater is used in cold weather, condensation may form on components inside the DVD player. Condensation may cause the DVD player to not operate properly. If you think that condensation is a problem turn off the DVD player for an hour or so to allow it to dry out and wipe any damp discs with a soft cloth to remove the moisture.
- Road shocks may interrupt disc playback. ▣

DVD discs

- With some DVD video discs, it may not be possible to use certain functions.
- It may not be possible to play back some DVD video discs.
- When DVD-R/DVD-RW discs are used, playback is possible only for discs which have been finalized.
- When DVD-R/DVD-RW discs are used, playback is possible only for discs which have been recorded with the Video format (video mode). It is not possible to play back DVD-RW discs which have been recorded with the Video Recording format (VR mode).
- It may not be possible to play back DVD-R/DVD-RW discs which have been recorded with the Video format (video mode), because of disc characteristics, scratches or dirt on the disc, or dirt, condensation, etc. on the lens of this unit.
- It is not possible to play back DVD-ROM/DVD-RAM discs.
- Playback of discs recorded on a personal computer may not be possible, depending on the application settings and the environment. Please record with the correct format. (For details, contact the manufacturer of the application.) ▣

CD-R/CD-RW discs

- When CD-R/CD-RW discs are used, playback is possible only for discs which have been finalized.
- It may not be possible to play back CD-R/CD-RW discs recorded on a music CD recorder or a personal computer because of disc characteristics, scratches or dirt on the disc, or dirt, condensation, etc., on the lens of this unit.

Additional Information

- Playback of discs recorded on a personal computer may not be possible, depending on the application settings and the environment. Please record with the correct format. (For details, contact the manufacturer of the application.)
- Playback of CD-R/CD-RW discs may become impossible in case of direct exposure to sunlight, high temperatures, or the storage conditions in the vehicle.
- Titles and other text information recorded on a CD-R/CD-RW disc may not be displayed by this unit (in the case of audio data (CD-DA)).
- This unit conforms to the track skip function of the CD-R/CD-RW disc. The tracks containing the track skip information are skipped automatically (in case of audio data (CD-DA)).
- If you insert a CD-RW disc into this unit, time to playback will be longer than when you insert a conventional CD or CD-R disc.
- Read the precautions with CD-R/CD-RW discs before using them. 
- This unit allows playback of MP3/WMA files on CD-ROM, CD-R and CD-RW discs. Disc recordings compatible with level 1 and level 2 of ISO9660 and with the Romeo and Joliet file system can be played back.
- It is possible to play back multi-session compatible recorded discs.
- MP3/WMA files are not compatible with packet write data transfer.
- The maximum number of characters which can be displayed for a file name, including the extension (.mp3 or .wma), is 64, from the first character.
- The maximum number of characters which can be displayed for a folder name is 64.
- In case of files recorded according to the Romeo file system, only the first 64 characters can be displayed.
- When playing discs with MP3/WMA files and audio data (CD-DA) such as CD-EXTRA and MIXED-MODE CDs, both types can be played only by switching mode between MP3/WMA and CD-DA.
- The folder selection sequence for playback and other operations becomes the writing sequence used by the writing software. For this reason, the expected sequence at the time of playback may not coincide with the actual playback sequence. However, there also is some writing software which permits setting of the playback order.
- Some audio CDs contain tracks that merge into one another without a pause. When these discs are converted to MP3/WMA files and burned to a CD-R/CD-RW/CD-ROM, the files will be played back on this player with a short pause between each one, regardless of the length of the pause between tracks on the original audio CD.

MP3 and WMA files

- MP3 is short for MPEG Audio Layer 3 and refers to an audio compression technology standard.
- WMA is short for Windows Media™ Audio and refers to an audio compression technology that is developed by Microsoft Corporation. WMA data can be encoded by using Windows Media Player version 7 or later.
- With some applications used to encode WMA files, this unit may not operate correctly.
- Depending on the version of Windows Media Player used to encode WMA files, album names and other text information may not be correctly displayed.



Important

- When naming an MP3 or a WMA file, add the corresponding filename extension (.mp3 or .wma).

Additional Information

- This unit plays back files with the filename extension (.mp3 or .wma) as an MP3 or a WMA file. To prevent noise and malfunctions, do not use these extensions for files other than MP3 or WMA files.

MP3 additional information

- Files are compatible with the ID3 Tag Ver. 1.0, 1.1, 2.2, 2.3 and 2.4 formats for display of album (disc title), track (track title), artist (track artist) and comments. Ver. 2.x of ID3 Tag is given priority when both Ver. 1.x and Ver. 2.x exist.
- The emphasis function is valid only when MP3 files of 32, 44.1 and 48 kHz frequencies are played back. (16, 22.05, 24, 32, 44.1, 48 kHz sampling frequencies can be played back.)
- There is no m3u playlist compatibility.
- There is no compatibility with the MP3i (MP3 interactive) or mp3 PRO formats.
- The sound quality of MP3 files generally becomes better with an increased bit rate. This unit can play recordings with bit rates from 8 kbps to 320 kbps, but in order to be able to enjoy sound of a certain quality, we recommend using only discs recorded with a bit rate of at least 128 kbps.

WMA additional information

- This unit plays back WMA files encoded by Windows Media Player version 7 and 8.
- You can only play back WMA files in the frequencies 32, 44.1 and 48 kHz.
- The sound quality of WMA files generally becomes better with an increased bit rate. This unit can play recordings with bit rates from 48 kbps to 192 kbps, but in order to be able to enjoy sound of a certain quality, we recommend using discs recorded with a higher bit rate.
- This unit does not play back WMA files recorded as VBR (variable bit rate). ▣

About folders and MP3/WMA files

- An outline of a CD-ROM with MP3/WMA files on it is shown below. Subfolders are shown as folders in the folder currently selected.

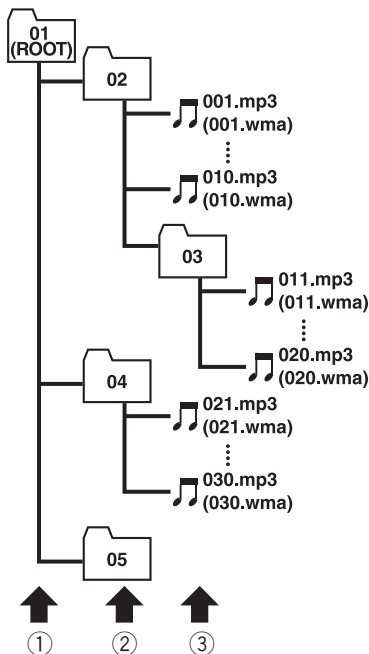

① First level

② Second level

③ Third level



Notes

- This unit assigns folder numbers. The user can not assign folder numbers.
- It is not possible to check folders that do not include MP3/WMA files. (These folders will be skipped without displaying the folder number.)

Additional Information

- MP3/WMA files in up to 8 tiers of folders can be played back. However, there is a delay in the start of playback on discs with numerous tiers. For this reason we recommend creating discs with no more than 2 tiers.
- It is possible to play back up to 253 items from folders on one disc. □

Using the display correctly

CAUTION

- If liquid or foreign matter should get inside this unit, turn off the power immediately and consult your dealer or the nearest authorized PIONEER Service Station. Do not use the unit in this condition because doing so may result in a fire, electric shock, or other failure.
- If you notice smoke, a strange noise or smell, or any other abnormal signs from the display, turn off the power immediately and consult your dealer or the nearest authorized PIONEER Service Station. Using this unit in this condition may result in permanent damage to the system.
- Do not disassemble or modify this unit, as there are high-voltage components inside which may cause an electric shock. Be sure to consult your dealer or the nearest authorized PIONEER Service Station for internal inspection, adjustments or repairs.

Handling the display

- When the display is subjected to direct sunlight for a long period of time, it will become very hot resulting in possible damage to the LCD screen. When not using this unit, close the display and avoid exposing it to direct sunlight.
- The display should be used within the temperature ranges shown below.
Storage temperature range: -20 to +80 °C

At temperatures higher or lower than the operating temperature range the display may not operate normally.

- The LCD screen of this unit is exposed in order to increase its visibility within the vehicle. Please do not press strongly on it as this may damage it.
- Do not place anything on the display when it is opened. Also, do not attempt to carry out angle adjustment, or open/close the display by hand. Applying strong force to the display may damage it.
- Do not push the LCD screen with much force as this may scratch it.
- Be careful not to place anything between the display and the main body when the display is opening or closing. If an object gets between the display and main body, the display may stop working.
- Be careful of fingers, long hair, and loose articles of clothing which could possibly get caught between the display and the main body and cause serious injury.

Additional Information

Liquid crystal display (LCD) screen

- If the display is near the vent of an air conditioner when it is opened, make sure that air from the air conditioner is not blowing on it. Heat from the heater may damage the LCD screen, and cool air from the cooler may cause moisture to form inside the display resulting in possible damage. Also, if the display is cooled down by the cooler, the screen may become dark, or the life span of the small fluorescent tube used inside the display may be shortened.
- Small black dots or white dots (bright dots) may appear on the LCD screen. These are due to the characteristics of the LCD screen and do not indicate a problem with the display.
- At low temperatures, the LCD screen may be dark for a while after the power is turned on.
- The LCD screen will be difficult to see if it is exposed to direct sunlight.
- When using a portable phone, keep the antenna of the portable phone away from the display to prevent disruption of the video by the appearance of spots, colored stripes, etc.

- at low temperatures reduces the service life of the fluorescent tube.)
- When the fluorescent tube reaches the end of its useful life, the screen will be dark and the image will no longer be projected. If this happens, consult your dealer or the nearest authorized PIONEER Service Station. 

Keeping the display in good condition

- When wiping the screen, take care not to scratch the surface. Do not use harsh or abrasive chemical cleaners.

Small fluorescent tube

- A small fluorescent tube is used inside the display to illuminate the LCD screen.
 - The fluorescent tube should last for approximately 10,000 hours, depending on operating conditions. (Using the display

Additional Information

Language code chart for DVD

Language (code), input code	Language (code), input code	Language (code), input code
Japanese (ja), 1001	Guarani (gn), 0714	Pashto, Pushto (ps), 1619
English (en), 0514	Gujarati (gu), 0721	Quechua (qu), 1721
French (fr), 0618	Hausa (ha), 0801	Rhaeto-Romance (rm), 1813
Spanish (es), 0519	Hindi (hi), 0809	Kirundi (rn), 1814
German (de), 0405	Croatian (hr), 0818	Romanian (ro), 1815
Italian (it), 0920	Hungarian (hu), 0821	Kinyarwanda (rw), 1823
Chinese (zh), 2608	Armenian (hy), 0825	Sanskrit (sa), 1901
Dutch (nl), 1412	Interlingua (ia), 0901	Sindhi (sd), 1904
Portuguese (pt), 1620	Interlingue (ie), 0905	Sangho (sg), 1907
Swedish (sv), 1922	Inupiak (ik), 0911	Serbo-Croatian (sh), 1908
Russian (ru), 1821	Indonesian (in), 0914	Sinhalese (si), 1909
Korean (ko), 1115	Icelandic (is), 0919	Slovak (sk), 1911
Greek (el), 0512	Hebrew (iw), 0923	Slovenian (sl), 1912
Afar (aa), 0101	Yiddish (ji), 1009	Samoan (sm), 1913
Abkhazian (ab), 0102	Javanese (jw), 1023	Shona (sn), 1914
Afrikaans (af), 0106	Georgian (ka), 1101	Somali (so), 1915
Amharic (am), 0113	Kazakh (kk), 1111	Sinbanese (sq), 1917
Arabic (ar), 0118	Greenlandic (kl), 1112	Serbian (sr), 1918
Assamese (as), 0119	Cambodian (km), 1113	Siswati (ss), 1919
Aymara (ay), 0125	Kannada (kn), 1114	Sesotho (st), 1920
Azerbaijani (az), 0126	Kashmiri (ks), 1119	Sundanese (su), 1921
Bashkir (ba), 0201	Kurdish (ku), 1121	Swahili (sw), 1923
Byelorussian (be), 0205	Kirghiz (ky), 1125	Tamil (ta), 2001
Bulgarian (bg), 0207	Latin (la), 1201	Telugu (te), 2005
Bihari (bh), 0208	Lingala (ln), 1214	Tajik (tg), 2007
Bislama (bi), 0209	Laothian (lo), 1215	Thai (th), 2008
Bengali (bn), 0214	Lithuanian (lt), 1220	Tigrinya (ti), 2009
Tibetan (bo), 0215	Latvian (lv), 1222	Turkmen (tk), 2011
Breton (br), 0218	Malagasy (mg), 1307	Tagalog (tl), 2012
Catalan (ca), 0301	Maori (mi), 1309	Setswana (tn), 2014
Corsican (co), 0315	Macedonian (mk), 1311	Tonga (to), 2015
Czech (cs), 0319	Malayalam (ml), 1312	Turkish (tr), 2018
Welsh (cy), 0325	Mongolian (mn), 1314	Tsonga (ts), 2019
Danish (da), 0401	Moldavian (mo), 1315	Tatar (tt), 2020
Bhutani (dz), 0426	Marathi (mr), 1318	Twi (tw), 2023
Esperanto (eo), 0515	Malay (ms), 1319	Ukrainian (uk), 2111
Estonian (et), 0520	Maltese (mt), 1320	Urdu (ur), 2118
Basque (eu), 0521	Burmese (my), 1325	Uzbek (uz), 2126
Persian (fa), 0601	Nauru (na), 1401	Vietnamese (vi), 2209
Finnish (fi), 0609	Nepali (ne), 1405	Volapük (vo), 2215
Fiji (fj), 0610	Norwegian (no), 1415	Wolof (wo), 2315
Faroese (fo), 0615	Occitan (oc), 1503	Xhosa (xh), 2408
Frisian (fy), 0625	Oromo (om), 1513	Yoruba (yo), 2515
Irish (ga), 0701	Oriya (or), 1518	Zulu (zu), 2621
Scots-Gaelic (gd), 0704	Panjabi (pa), 1601	
Galician (gl), 0712	Polish (pl), 1612	



Additional Information

Terms

Aspect ratio

This is the width-to-height ratio of a TV screen. A regular display has an aspect ratio of 4:3. Wide screen displays have an aspect ratio of 16:9, providing a bigger picture for exceptional presence and atmosphere.

Bit rate

This expresses data volume per second, or bps units (bits per second). The higher the rate, the more information is available to reproduce the sound. Using the same encoding method (such as MP3), the higher the rate, the better the sound.

Chapter

DVD titles are in turn divided into chapters which are numbered in the same way as the chapters of a book. With DVD video discs featuring chapters, you can quickly find a desired scene with chapter search.

Dolby Digital

Dolby Digital provides multi-channel audio from up to 5.1 independent channels. This is the same as the Dolby Digital surround sound system used in theaters.



DTS

This stands for Digital Theater Systems. DTS is a surround system delivering multi-channel audio from up to 6 independent channels.



ID3 tag

This is a method of embedding track-related information in an MP3 file. This embedded in-

formation can include the track title, the artist's name, the album title, the music genre, the year of production, comments and other data. The contents can be freely edited using software with ID3 Tag editing functions. Although the tags are restricted as to the number of characters, the information can be viewed when the track is played back.

ISO9660 format

This is the international standard for the format logic of CD-ROM folders and files. For the ISO9660 format, there are regulations for the following two levels.

Level 1:

The file name is in 8.3 format (the name consists of up to 8 characters, half-byte English capital letters and half-byte numerals and the “_” sign, with a file-extension of three characters).

Level 2:

The file name can have up to 31 characters (including the separation mark “.” and a file extension). Each folder contains less than 8 hierarchies.

Extended formats

Joliet:

File names can have up to 64 characters.

Romeo:

File names can have up to 128 characters.

Linear PCM (LPCM)/Pulse code modulation

This stands for linear pulse code modulation, which is the signal recording system used for music CDs and DVDs. Generally, DVDs are recorded with higher sampling frequency and bit rate than CDs. Therefore, DVDs can provide higher sound quality.

m3u

Playlists created using the “WINAMP” software have a playlist file extension (.m3u).

Additional Information

MP3

MP3 is short for MPEG Audio Layer 3. It is an audio compression standard set by a working group (MPEG) of the ISO (International Standards Organization). MP3 is able to compress audio data to about 1/10th the level of a conventional disc.

MPEG

This stands for Moving Pictures Experts Group, and is an international video image compression standard. Some DVDs feature digital audio compressed and recorded using this system.

Multi-angle

With regular TV programs, although multiple cameras are used to simultaneously shoot scenes, only images from one camera at a time are transmitted to your TV. Some DVDs feature scenes shot from multiple angles, letting you choose your viewing angle as desired.

Multi-audio (Multilingual dialog)

Some DVDs feature dialog recorded in multiple languages. Dialog in up to 8 languages can be recorded on a single disc, letting you choose as desired.

Multi-session

Multi-session is a recording method that allows additional data to be recorded later. When recording data on a CD-ROM, CD-R or CD-RW, etc., all data from beginning to end is treated as a single unit or session. Multi-session is a method of recording more than 2 sessions on one disc.

Multi-subtitle

Subtitles in up to 32 languages can be recorded on a single DVD, letting you choose as desired.

Optical digital output/input

By transmitting and receiving audio signals in a digital signal format, the chance of sonic quality deteriorating in the course of transmission is minimized. An optical digital output/input is designed to transmit and receive digital signals optically.

Packet write

This is a general term for a method of writing on CD-R, etc., at the time required for a file, just as is done with files on floppy or hard discs.

Parental lock

Some DVD video discs with violent or adult-oriented scenes feature parental lock which prevents children from viewing such scenes. With this kind of disc, if you set the unit's parental lock level, playback of scenes inappropriate for children will be disabled, or these scenes will be skipped.

Playback control (PBC)

This is a playback control signal recorded on Video CDs (Version 2.0). Using menu displays provided by Video CDs with PBC lets you enjoy playback of simple interactive software and software with search functions. You can also enjoy viewing high- and standard-resolution still images.

Region number

DVD players and DVD discs feature region numbers indicating the area in which they were purchased. Playback of a DVD is not possible unless it features the same region number as the DVD player. This unit's region number is displayed on the bottom of the unit.

Additional Information

Title

DVD video discs have high data capacity, enabling recording of multiple movies on a single disc. If, for example, one disc contains three separate movies, they are divided into title 1, title 2 and title 3. This lets you enjoy the convenience of title search and other functions.

VBR

VBR is short for variable bit rate. Generally speaking CBR (constant bit rate) is more widely used. But by flexibly adjusting the bit rate according to the needs of audio compression, it is possible to achieve compression-priority sound quality.

WMA

WMA is short for Windows Media™ Audio and refers to an audio compression technology that is developed by Microsoft Corporation. WMA data can be encoded by using Windows Media Player version 7 or later. Microsoft, Windows Media, and the Windows logo are trademarks, or registered trademarks of Microsoft Corporation in the United States and/or other countries. ■

Additional Information

Specifications

General

Rated power source	14.4 V DC (allowable voltage range: 12.0 – 14.4 V DC)
Grounding system	Negative type
Max. current consumption	10.0 A
Dimensions (W × H × D):	
DIN	
Chassis	178 × 50 × 160 mm
Nose	188 × 58 × 30 mm
D	
Chassis	178 × 50 × 165 mm
Nose	170 × 46 × 25 mm
Weight	2.3 kg

Display

Screen size/aspect ratio	6.5 inch wide/16:9 (effective display area: 144 × 77 mm)
Pixels	336,960 (1,440 × 234)
Type	TFT active matrix, transmis- sive type
Color system	NTSC/PAL/SECAM compati- ble
Storage temperature range	–20 – +80 °C
Angle adjustment	50 – 110° (initial settings: 110°)

Audio

Maximum power output	50 W × 4 50 W × 2/4 Ω + 70 W × 1/2 Ω (for subwoofer)
Continuous power output	27 W × 4 (DIN 45324, +B=14.4 V)
Load impedance	4 Ω (4 – 8 Ω [2 Ω for 1 ch] al- lowable)
Preout max output level/output impedance	2.2 V/1kΩ
Equalizer (3-Band Parametric Equalizer):	
Low	
Frequency	40/80/100/160 Hz
Q Factor	0.35/0.59/0.95/1.15 (+6 dB when boosted)
Gain	±12dB
Mid	
Frequency	200/500/1k/2k Hz

High	
Frequency	3.15k/8k/10k/12.5k Hz
Q Factor	0.35/0.59/0.95/1.15 (+6 dB when boosted)
Gain	±12dB
Loudness contour:	
Low	+3.5 dB (100 Hz), +3 dB (10 kHz)
Mid	+10 dB (100 Hz), +6.5 dB (10 kHz)
High	+11 dB (100 Hz), +11 dB (10 kHz) (volume: –30 dB)
Tone controls:	
Bass	
Frequency	40/63/100/160 Hz
Gain	±12dB
Treble	
Frequency	2.5k/4k/6.3k/10k Hz
Gain	±12dB
HPF:	
Frequency	50/80/125 Hz
Slope	–12 dB/oct
Subwoofer:	
Frequency	50/80/125 Hz
Slope	–18 dB/oct
Gain	±12dB
Phase	Normal/Reverse

DVD Player

System	DVD video, Video CD, Com- pact disc audio system
Usable discs	DVD video, Video CD, Com- pact disc
Region number	2
Signal format:	
Sampling frequency	44.1/48/96 kHz
Number of quantization bits	16/20/24; linear
Frequency response	5 – 44,000 Hz (with DVD, at sampling frequency 96 kHz)
Signal-to-noise ratio	97 dB (1 kHz) (IEC-A net- work) (CD: 96 dB (1 kHz) (IEC-A network))
Dynamic range	95 dB (1 kHz) (CD: 94 dB (1 kHz))
Distortion	0.008 % (1 kHz)

Additional Information

Output level:

Video	1.0 V _{p-p} /75 Ω (±0.2 V)
Audio	1.0 V (1 kHz, 0 dB)
Number of channels	2 (stereo)
MP3 decoding format	MPEG-1 & 2 Audio Layer 3
WMA decoding format	Ver. 7 & 8

FM tuner

Frequency range	87.5 – 108.0 MHz
Usable sensitivity	8 dBf (0.7 μV/75 Ω, mono, S/N: 30 dB)
50 dB quieting sensitivity	10 dBf (0.9 μV/75 Ω, mono)
Signal-to-noise ratio	75 dB (IEC-A network)
Distortion	0.3 % (at 65 dBf, 1 kHz, stereo)
	0.1 % (at 65 dBf, 1 kHz, mono)
Frequency response	30 – 15,000 Hz (±3 dB)
Stereo separation	45 dB (at 65 dBf, 1 kHz)
Selectivity	80 dB (±200 kHz)

MW tuner

Frequency range	531 – 1,602 kHz (9 kHz)
Usable sensitivity	18 μV (S/N: 20 dB)
Signal-to-noise ratio	65 dB (IEC-A network)

LW tuner

Frequency range	153 – 281 kHz
Usable sensitivity	30 μV (S/N: 20 dB)
Signal-to-noise ratio	65 dB (IEC-A network)



Note

Specifications and the design are subject to possible modifications without notice due to improvements. ■

- A**
 - Angle icon 35, 87
 - Aspect ratio 88, 110
 - Audio language 34, 87
- B**
 - Bookmark 37
 - Brightness 20
- C**
 - Chapter 110
 - Code number 88
 - Color 20
 - Contrast 20
- D**
 - Direct search 34
 - Dolby Digital 10, 110
 - DTS 10, 110
- H**
 - Hue 20
- L**
 - Language code chart 109
 - Linear PCM (LPCM) 110
- M**
 - Menu language 87
 - MPEG 111
 - Multi-angle 35, 111
 - Multi-audio 34, 111
 - Multi-subtitle 35, 111
- O**
 - Optical digital output/input 111
- P**
 - Parental lock 88, 111
 - PBC (playback control) 38
 - Playback control (PBC) 111
- R**
 - Region number 8, 111
- S**
 - Subtitle language 35, 86
- T**
 - Title 112
 - TV aspect 88
- V**
 - Video CD 8
- W**
 - Wide screen mode 20



PIONEER CORPORATION

4-1, MEGURO 1-CHOME, MEGURO-KU, TOKYO 153-8654, JAPAN

PIONEER ELECTRONICS (USA) INC.

P.O. Box 1540, Long Beach, California 90801-1540, U.S.A.
TEL: (800) 421-1404

PIONEER EUROPE NV

Haven 1087, Keetberglaan 1, B-9120 Melsele, Belgium
TEL: (0) 3/570.05.11

PIONEER ELECTRONICS ASIACENTRE PTE. LTD.

253 Alexandra Road, #04-01, Singapore 159936
TEL: 65-6472-7555

PIONEER ELECTRONICS AUSTRALIA PTY. LTD.

178-184 Boundary Road, Braeside, Victoria 3195, Australia
TEL: (03) 9586-6300

PIONEER ELECTRONICS OF CANADA, INC.

300 Allstate Parkway, Markham, Ontario L3R OP2, Canada
TEL: 1-877-283-5901

PIONEER ELECTRONICS DE MEXICO, S.A. de C.V.

Bldv.Manuel Avila Camacho 138 10 piso
Col.Lomas de Chapultepec, Mexico, D.F. 11000
TEL: 55-9178-4270

先鋒股份有限公司

總公司：台北市中山北路二段44號13樓
電話：(02) 2521-3588

先鋒電子（香港）有限公司

香港九龍尖沙咀海港城世界商業中心
9樓901-6室
電話：(0852) 2848-6488

Published by Pioneer Corporation.
Copyright © 2004 by Pioneer Corporation.
All rights reserved.

Printed in Japan

<CRB2047-A> EW

<KNNZF> <05B00000>

Free Manuals Download Website

<http://myh66.com>

<http://usermanuals.us>

<http://www.somanuals.com>

<http://www.4manuals.cc>

<http://www.manual-lib.com>

<http://www.404manual.com>

<http://www.luxmanual.com>

<http://aubethermostatmanual.com>

Golf course search by state

<http://golfingnear.com>

Email search by domain

<http://emailbydomain.com>

Auto manuals search

<http://auto.somanuals.com>

TV manuals search

<http://tv.somanuals.com>