

Operation Manual

AV Receiver/6-Disc Changer with 7 inch Wide Display

AVH-P6800DVD

SUPER  **TUNER III D**

English

Thank you for buying this Pioneer product.

Please read through these operating instructions so you will know how to operate your model properly. *After you have finished reading the instructions, keep this manual in a safe place for future reference.*



Be sure to read this

- Playable discs **8**
- DVD video disc region numbers **9**
- When an operation is prohibited **13**

01 Precautions

- IMPORTANT SAFEGUARDS 6**
- To ensure safe driving **6**
 - To avoid battery exhaustion **7**

02 Before You Start

- Information to User **8**
- For Canadian model **8**
- About this unit **8**
- About this manual **9**
- After-sales service for Pioneer products **9**
- Product registration **10**
- Features **10**
- About WMA **11**
- About the SAT RADIO READY mark **12**
- To protect the LCD screen **12**
- For viewing LCD comfortably **12**
- What the marks on DVDs indicate **12**
- Resetting the microprocessor **13**
- About the demo mode **13**
- Use and care of the remote control **14**

03 Customising your system

- Connecting with separately sold Pioneer products **15**
- Using multi-channel processor **15**
- Using iPod **15**
- Using a Pioneer navigation unit **15**
- Using the AVG-VDP1 (Pioneer Vehicle Dynamics Processor) **16**
- Using the rear display **16**
- Using Bluetooth wireless technology **16**

04 What's What

- Head unit **17**
- Remote control **18**

05 Basic Operations

- Turning the unit on and selecting a source **21**
- Loading/Ejecting discs **22**
- Adjusting the flap angle **23**
- Adjusting the volume **23**
- Turning the unit off **23**
- Touch panel key basic operation **24**

06 Tuner

- Listening to the radio **26**
- Storing and recalling broadcast frequencies **27**
- Introduction of advanced tuner operation **27**
- Storing the strongest broadcast frequencies **27**
- Tuning in strong signals **28**

07 Playing DVD video discs

- Watching a DVD video **29**
- Operating the DVD menu **30**
- Skipping back or forward to another title **30**
- Stopping playback **30**
- Pausing DVD video playback **30**
- Resume playback (Bookmark) **31**
- Frame-by-frame playback **31**
- Slow motion playback **31**
- Searching for a desired scene, starting playback from a specified time **32**
- Changing audio language during playback (Multi-audio) **32**
- Changing the subtitle language during playback (Multi-subtitle) **33**
- Changing the viewing angle during playback (Multi-angle) **33**

- Return to the specified scene **34**
- Automatic playback of DVDs **34**
- Introduction of advanced DVD video operation **34**
- Repeating play **34**
- Selecting audio output **35**

08 Playing Video CDs

- Watching a Video CD **36**
- Stopping playback **37**
- Pausing Video CD playback **37**
- Frame-by-frame playback **37**
- Slow motion playback **37**
- Searching for a desired scene, starting playback from a specified time **38**
- PBC playback **38**
- Introduction of advanced Video CD operation **39**
- Repeating play **39**
- Selecting audio output **39**

09 Playing CDs

- Listening to a CD **40**
- Stopping playback **41**
- Pausing CD playback **41**
- Using CD TEXT functions **41**
- Introduction of advanced CD operation **42**
- Repeating play **42**
- Playing tracks in random order **42**
- Scanning tracks of a CD **42**

10 Playing MP3/WMA

- Listening to MP3/WMA **43**
- Stopping playback **44**
- Pausing MP3/WMA playback **44**
- Displaying information on MP3/WMA file **45**
- Introduction of advanced built-in DVD player (MP3/WMA) operation **46**
- Repeating play **46**

- Playing tracks in random order **46**
- Scanning folders and tracks **47**

11 Multi-CD Player

- Listening to a CD **48**
- Pausing CD playback **49**
- Using CD TEXT functions **49**
- 50-disc multi-CD player **49**
- Introduction of advanced multi-CD player operation **50**
- Repeating play **50**
- Playing tracks in random order **50**
- Scanning CDs and tracks **51**
- Using ITS playlists **51**
- Using compression and bass emphasis **52**

12 XM tuner (GEX-P920XM)

- Listening to XM Satellite Radio **53**
- Switching the XM channel select mode **54**
- Switching between the detail information display and preset list display **54**
- Storing and recalling broadcast stations **54**
- Selecting a channel **54**
- Using the MyMix function **55**
- Displaying the Radio ID **56**

13 XM tuner (GEX-P910XM)

- Listening to XM Satellite Radio **57**
- Switching the XM display **58**
- Storing and recalling broadcast stations **58**
- Switching the XM channel select mode **58**
- Selecting a channel directly **58**
- Displaying the Radio ID **58**

14 SIRIUS Satellite Radio tuner

- Listening to SIRIUS Satellite Radio **59**
- Selecting the SIRIUS channel select mode **60**
- Selecting a channel **60**
- Switching the display **60**

Switching between the detail information display and preset list display **61**

Storing and recalling broadcast stations **61**

Using the MyMix function **61**

Using the Game Alert function **63**

Displaying the Radio ID **64**

15 TV tuner

Watching the television **65**

Storing and recalling broadcast stations **66**

Introduction of advanced TV tuner operation **66**

Storing the strongest broadcast stations sequentially **67**

16 Playing songs on iPod

Listening to songs on your iPod **68**

Browsing for a song **68**

Pausing a song **69**

Displaying text information on iPod **69**

Displaying information on song **69**

Repeating play **69**

Playing songs in a random order (shuffle) **70**

17 Bluetooth Audio

Listening to songs on BT Audio (Bluetooth audio player) **71**

Connecting a Bluetooth audio player **72**

Playing songs on Bluetooth audio player **72**

Disconnecting a Bluetooth audio player **73**

Displaying BD (Bluetooth Device) address **73**

18 Bluetooth Telephone

Hands-free phoning with cellular phones featuring Bluetooth wireless technology **74**

Setting up for hands-free phoning **75**

Basic operation of hands-free phoning **75**

Introduction of advanced hands-free phoning operation **76**

Connecting a cellular phone **76**

Disconnecting a cellular phone **77**

Registering connected cellular phone **77**

Deleting a registered phone **78**

Connecting to a registered cellular phone **78**

Using the Phone Book **78**

Using the Call History **80**

Using preset numbers **81**

Making a call by entering phone number **82**

Clearing memory **82**

Setting the automatic answering **82**

Setting the automatic rejecting **82**

Switching the ring tone **82**

Echo canceling and noise reduction **83**

Displaying BD (Bluetooth Device) address **83**

19 Audio Adjustments

Introduction of audio adjustments **84**

Using balance adjustment **84**

Using the equalizer **85**

Adjusting loudness **86**

Using subwoofer output **86**

Using nonfading output **86**

Using the high pass filter **87**

Adjusting source levels **87**

Staging for car environment **87**

20 Digital Signal Processor

Introduction of DSP adjustments **89**

Using the position selector **89**

Using balance adjustment **90**

Adjusting source levels **90**

Using the dynamic range control **91**

Using the down-mix function **91**

Using the direct control **91**

- Using the Dolby Pro Logic II **91**
- Setting the speaker setting **92**
- Adjusting the speaker output levels **93**
- Selecting a cross-over frequency **94**
- Adjusting the speaker output levels using a test tone **94**
- Using the time alignment **95**
- Using the equalizer **96**
- Using the auto-equalizer **98**
- Auto TA and EQ (auto-time alignment and auto-equalizing) **98**

21 Setup

- Introduction of setup adjustments **101**
- Setting the AV input **101**
- Setting for rear view camera (back up camera) **101**
- Setting the clock **102**
- Selecting video on rear display **102**

22 DVD Setup

- Introduction of DVD setup adjustments **103**
- Setting the subtitle language **103**
- Setting the audio language **104**
- Setting the menu language **104**
- Switching the assist subtitle on or off **104**
- Setting the angle icon display **104**
- Setting the aspect ratio **105**
- Setting the parental lock **105**

23 Initial Setup

- Adjusting initial settings **107**
- Switching the auxiliary setting **107**
- Setting the rear output and subwoofer controller **107**
- Switching the sound muting/attenuation **108**
- Mixing navigation voice/AVG-VDP1 beep and audio sound **108**
- Correcting distorted sound **109**

- Changing languages for CAUTION **109**
- Resetting the audio functions **109**
- Entering PIN code for Bluetooth wireless connection **109**
- Extending the vehicle's antenna **110**

24 Other Functions

- Adjusting the screen **111**
- Selecting the background display **112**
- Adjusting the response positions of the touch panels (Touch Panel Calibration) **113**
- Displaying the navigation image **113**
- Displaying the AVG-VDP1 (Pioneer Vehicle Dynamics Processor) **114**
- Using the AUX source **114**
- Setting remote control code type **115**
- Using the preprogrammed function **115**

Additional Information

- Troubleshooting **117**
- Error messages **119**
- Understanding auto TA and EQ error messages **119**
- DVD player and care **121**
- DVD discs **121**
- CD-R/CD-RW discs **121**
- Dual Discs **122**
- MP3 and WMA files **122**
- About folders and MP3/WMA files **124**
- Using the display correctly **124**
- Language code chart for DVD **126**
- Terms **127**
- Specifications **130**

Index 132

IMPORTANT SAFEGUARDS

Please read all of these instructions regarding your display and retain them for future reference.

- 1 **Read this manual fully and carefully before operating your display.**
- 2 **Keep this manual handy as a reference for operating procedures and safety information.**
- 3 **Pay close attention to all warnings in this manual and follow the instructions carefully.**
- 4 **Do not allow other persons to use this system until they have read and understood the operating instructions.**
- 5 **Do not install the display where it may (i) obstruct the driver's vision, (ii) impair the performance of any of the vehicle's operating systems or safety features, including air bags, hazard lamp buttons or (iii) impair the driver's ability to safely operate the vehicle.**
- 6 **Do not operate this display if doing so in any way will divert your attention from the safe operation of your vehicle. Always observe safe driving rules and follow all existing traffic regulations. If you experience difficulty in operating the system or reading the display, park your vehicle in a safe location and make necessary adjustments.**
- 7 **Please remember to wear your seat belt at all times while operating your vehicle. If you are ever in an accident, your injuries can be considerably more severe if your seat belt is not properly buckled.**
- 8 **Never use headphones while driving.**
- 9 **To promote safety, certain functions are disabled unless the parking brake is on, and the vehicle is not in motion.**
- 10 **Never set the volume of your display so high that you cannot hear outside traffic and emergency vehicles.**



WARNING

- **Do not attempt to install or service your display by yourself. Installation or servicing of the display by persons without training and experience in electronic equipment and automotive accessories may be dangerous and could expose you to the risk of electric shock or other hazards.** 

To ensure safe driving



WARNING

- **LIGHT GREEN LEAD AT POWER CONNECTOR IS DESIGNED TO DETECT PARKED STATUS AND MUST BE CONNECTED TO THE POWER SUPPLY SIDE OF THE PARKING BRAKE SWITCH. IMPROPER CONNECTION OR USE OF THIS LEAD MAY VIOLATE APPLICABLE LAW AND MAY RESULT IN SERIOUS INJURY OR DAMAGE.**
- To avoid the risk of damage and injury and the potential violation of applicable laws, this unit is not for use with a video screen that is visible to the driver.
- To avoid the risk of accident and the potential violation of applicable laws, the front DVD or TV (sold separately) feature should never be used while the vehicle is being driven. Also, rear displays should not be in a location where it is a visible distraction to the driver.
- In some countries or states the viewing of images on a display inside a vehicle even by persons other than the driver may be illegal. Where such regulations apply, they must be obeyed and this unit's DVD features should not be used.

Precautions

When you attempt to watch a DVD, Video CD or TV while driving, the warning **VIDEO VIEWING IS NOT AVAILABLE WHILE DRIVING** will appear on the front display.

To watch a DVD, Video CD or TV on the front display, park your vehicle in a safe place and apply the parking brake.

Parking brake interlock

Certain functions (DVD/TV viewing and certain touch panel keys) offered by this unit could be dangerous and/or unlawful if used while driving. To prevent such functions from being used while the vehicle is in motion, there is an interlock system that senses when the parking brake is set. If you attempt to use the functions described above while driving, they will become disabled until you stop the vehicle in a safe place, and (1) apply the parking brake, (2) release the parking brake, and then (3) apply the parking brake again. Please keep the brake pedal pushed down before releasing the parking brake. 

To avoid battery exhaustion

Be sure to run the vehicle engine while using this unit. Using this unit without running the engine can result in battery drainage.



WARNING

Do not use with vehicles that do not feature an ACC position. 

Information to User

Alteration or modifications carried out without appropriate authorization may invalidate the user's right to operate the equipment.



For Canadian model

This Class B digital apparatus complies with Canadian ICES-003.



About this unit

The tuner frequencies on this unit are allocated for use in North America. Use in other areas may result in poor reception.

WARNING:

Handling the cord on this product or cords associated with accessories sold with the product may expose you to chemicals listed on proposition 65 known to the State of California and other governmental entities to cause cancer and birth defects or other reproductive harm. ***Wash hands after handling.***

This product contains mercury. Disposal of this material may be regulated due to environmental considerations. For disposal or recycling information, please contact your local authorities or the Electronics Industries Alliance: www.eiae.org.

CAUTION:
USE OF CONTROL OR ADJUSTMENT OR PERFORMANCE OF PROCEDURES OTHER THAN THOSE SPECIFIED HEREIN MAY RESULT IN HAZARDOUS RADIATION EXPOSURE.

CAUTION:
THE USE OF OPTICAL INSTRUMENTS WITH THIS PRODUCT WILL INCREASE EYE HAZARD.

CAUTION

- Do not allow this unit to come into contact with liquids. Electrical shock could result. Also, this unit damage, smoke, and overheat could result from contact with liquids.
- Keep this manual handy as a reference for operating procedures and precautions.
- Always keep the volume low enough so that you can hear sounds from outside the vehicle.
- Protect this unit from moisture.
- If the battery is disconnected or discharged, the preset memory will be erased and must be reprogrammed.

Important (Serial number)

The serial number is located on the bottom of this unit. For your own security and convenience, be sure to record this number on the enclosed warranty card.

Playable discs

DVD, Video CD and CD discs that display the logos shown below can be played back on this player.

Before You Start

DVD video



Video CD



CD



Notes

- **DVD** is a trademark of DVD Format/Logo Licensing Corporation.
- This player can only play back discs bearing the marks shown above.

DVD video disc region numbers

DVD video discs that have incompatible region numbers cannot be played on this player. The region number of the player can be found on the bottom of this unit.

The illustration below shows the regions and corresponding region numbers.



About this manual

This unit features a number of sophisticated functions ensuring superior reception and operation. All the functions have been designed for the easiest possible use, but many are not self-explanatory. This operation manual will help you benefit fully from this unit's potential and to maximize your listening enjoyment. We recommend that you familiarize yourself with the functions and their operation by reading through the manual before you begin using this unit. It is especially important that you read and observe **WARNINGs** and **CAUTIONs** in this manual. 

After-sales service for Pioneer products

Please contact the dealer or distributor from where you purchased this unit for after-sales service (including warranty conditions) or any other information. In case the necessary information is not available, please contact the companies listed below:

Please do not ship your unit to the companies at the addresses listed below for repair without advance contact.

Before You Start

U.S.A.

Pioneer Electronics (USA) Inc.
CUSTOMER SUPPORT DIVISION
P.O. Box 1760
Long Beach, CA 90801-1760
800-421-1404

CANADA

Pioneer Electronics of Canada, Inc.
CUSTOMER SATISFACTION DEPARTMENT
300 Allstate Parkway
Markham, Ontario L3R 0P2
1-877-283-5901

For warranty information please see the Limited Warranty sheet included with this unit. 

Product registration

Visit us at the following site:

<http://www.pioneerelectronics.com>

- 1 Register your product. We will keep the details of your purchase on file to help you refer to this information in the event of an insurance claim such as loss or theft.
- 2 Receive updates on the latest products and technologies.
- 3 Download owner's manuals, order product catalogues, research new products, and much more. 

Features

Touch panel key operation

It is possible to operate this unit by using touch panel key.

DVD video playback

It is possible to play back DVD video and DVD-R/RW (video mode).

Remember that use of this system for commercial or public viewing purposes may constitute an infringement on the author's rights protected by the Copyright Law.

Video CDs featuring PBC compatibility

It is possible to play back Video CDs featuring PBC (playback control).

CD playback

Music CD/CD-R/RW playback is possible.

MP3 file playback

You can play back MP3 files recorded on CD-ROM/CD-R/CD-RW (ISO9660 Level 1/Level 2 standard recordings).

- Supply of this product only conveys a license for private, non-commercial use and does not convey a license nor imply any right to use this product in any commercial (i.e. revenue-generating) real time broadcasting (terrestrial, satellite, cable and/or any other media), broadcasting/streaming via internet, intranets and/or other networks or in other electronic content distribution systems, such as pay-audio or audio-on-demand applications. An independent license for such use is required. For details, please visit <http://www.mp3licensing.com>.

WMA file playback

You can play back WMA files recorded on CD-ROM/CD-R/CD-RW (ISO9660 Level 1/Level 2 standard recordings).

NTSC compatibility

This unit is NTSC system compatible. When connecting other components to this unit, be sure components are compatible with the same video system otherwise images will not be correctly reproduced.

Before You Start

Multi-aspect

Switching between wide screen, letterbox and panscan display is possible.

Multi-audio

You can switch between multiple audio systems recorded on a DVD as desired.

Multi-subtitle

You can switch between multiple subtitle languages recorded on a DVD as desired.

Multi-angle

You can switch between multiple viewing angles of a scene recorded on a DVD as desired.

Hands-free phoning

Using Bluetooth adapter (e.g. CD-BTB100), this unit realizes effortless hands-free phoning with Bluetooth wireless technology.

Bluetooth audio player compatibility

Using Bluetooth adapter (e.g. CD-BTB100), you can control Bluetooth audio player featuring Bluetooth wireless technology.

iPod® compatibility

When you use this unit with a Pioneer iPod adapter (CD-IB100II) (sold separately), you can control an iPod with Dock Connector.

- iPod is a trademark of Apple Computer, Inc., registered in the U.S. and other countries.

Note

This product incorporates copyright protection technology that is protected by method claims of certain U.S. patents and other intellectual property rights owned by Macrovision Corporation and other rights owners. Use of this copyright protection technology must be authorized by Macrovision Corporation, and is intended for home and other limited viewing uses only unless otherwise authorized by Macrovision Corporation.

Reverse engineering or disassembly is prohibited. 

About WMA



The Windows Media™ logo printed on the box indicates that this unit can play back WMA data.

WMA is short for Windows Media Audio and refers to an audio compression technology that is developed by Microsoft Corporation. WMA data can be encoded by using Windows Media Player version 7 or later. Windows Media and the Windows logo are trademarks or registered trademarks of Microsoft Corporation in the United States and/or other countries.

Notes

- This unit may not operate correctly depending on the application used to encode WMA files.
- Depending on the version of Windows Media Player used to encode WMA files, album names and other text information may not be correctly displayed. 

About the SAT RADIO READY mark



The SAT RADIO READY mark printed above the CD loading slot indicates that the Satellite Radio Tuner for Pioneer (i.e., XM tuner and Sirius satellite tuner which are sold separately) can be controlled by this unit. Please inquire to your dealer or nearest authorized Pioneer service station regarding the satellite radio tuner that can be connected to this unit. For satellite radio tuner operation, please refer to the satellite radio tuner owner's manual.



Notes

- The system will use direct satellite-to-receiver broadcasting technology to provide listeners in their cars and at home with crystal-clear sound seamlessly from coast to coast. Satellite radio will create and package over 100 channels of digital-quality music, news, sports, talk and children's programming.
- "SAT Radio", the SAT Radio logo and all related marks are trademarks of Sirius Satellite Radio inc., and XM Satellite Radio Inc. ■

To protect the LCD screen

- Do not allow direct sunlight to fall on the display when this unit is not being used. Extended exposure to direct sunlight can result in LCD screen malfunction due to the resulting high temperatures.
- When using a cellular phone, keep the antenna of the cellular phone away from the display to prevent disruption of the video by the appearance of spots, colored stripes, etc.

- Never touch the screen with anything besides your finger when operating the touch panel function. The screen can scratch easily. ■

For viewing LCD comfortably

Due to its construction, the viewing angle of the LCD screen is limited. You can adjust it by changing either screen size or picture adjustment.

Changing the wide screen size

By changing the screen size from 4:3 to 16:9, you can adjust the screen so that the screen can fit to the video image you are playing. For details concerning operation, refer to *Changing the wide screen mode* on page 111.





Changing the picture adjustment

You can make the best adjustment to the picture display by changing **BRIGHT**, **CONTRAST**, **COLOR** and **HUE**. You can also dim or enlight the overall picture image using **DIMMER**. For details concerning operation, refer to *Changing the picture adjustment* on page 111. ■

What the marks on DVDs indicate



The marks below may be found on DVD disc labels and packages. They indicate the type of images and audio recorded on the disc, and the functions you can use.

Before You Start

Mark	Meaning
	Indicates the number of audio systems.
	Indicates the number of subtitle languages.
	Indicates the number of viewing angles.
	Indicates the picture size (aspect ratio: screen width-to-height ratio) type.
	Indicates the number of the region where playback is possible.

When an operation is prohibited

When you are watching a DVD and attempt to perform an operation, it may not be performed because of the programming on the disc. When this happens, the icon  appears on the screen.

- The icon  may not appear with certain discs. 

Resetting the microprocessor

Pressing **RESET** lets you reset the microprocessor to its initial settings. The microprocessor must be reset under the following conditions:

- Prior to using this unit for the first time after installation
- If the unit fails to operate properly
- When strange or incorrect messages appear on the display

1 Turn the ignition switch OFF.

2 Press RESET with a pen tip or other pointed instrument.

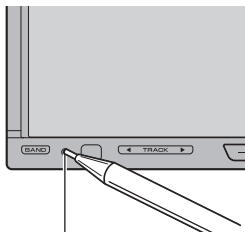

RESET button



Notes

- When using with navigation unit or AVG-VDP1, if you press **RESET**, be sure ACC OFF is selected. If ACC ON is selected, correct operation may not be possible even if you press **RESET**.
- After completing connections or when you want to erase all memorized settings or return the unit to its initial (factory) settings, switch your engine ON or set the ignition switch to ACC ON before pressing **RESET**. 

About the demo mode



Important

The red lead (ACC) of this unit should be connected to a terminal coupled with ignition switch on/off operations. If this is not done, the vehicle battery may be drained.

Before You Start

The feature demo automatically starts when you select the source **OFF**. The demo continues while the ignition switch is set to ACC or ON. To cancel the feature demo, press and hold **ENTERTAINMENT (ENT)**. To restart the feature demo, press and hold **ENTERTAINMENT (ENT)** again. Remember that if the feature demo continues operating when the car engine is turned off, it may drain battery power. 

Use and care of the remote control

Installing the battery

Slide the tray out on the back of the remote control and insert the battery with the plus (+) and minus (-) poles pointing in the proper direction.

- When using for the first time, pull out the film protruding from the tray.

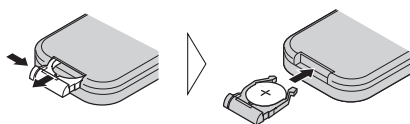

WARNING

Keep the battery out of the reach of children. Should the battery be swallowed, immediately consult a doctor.

CAUTION

- Use only one **CR2025 (3 V)** lithium battery.
- Remove the battery if the remote control is not used for a month or longer.
- Do not recharge, disassemble, heat or dispose of the battery in fire.
- Do not handle the battery with metallic tools.

- Do not store the battery with metallic materials.
- In the event of battery leakage, wipe the remote control completely clean and install a new battery.
- When disposing of used batteries, please comply with governmental regulations or environmental public institutions' rules that apply in your country/area.

Using the remote control

Point the remote control in the direction of the front panel to operate.

- The remote control may not function properly in direct sunlight.

Important

- Do not store the remote control in high temperatures or direct sunlight.
- Do not let the remote control fall onto the floor, where it may become jammed under the brake or accelerator pedal. 

Customising your system

Connecting with separately sold Pioneer products

Connecting with other Pioneer products, you can create the best audio-visual environment for enjoying music and movie in car. This section describes available options that can be controlled by this unit. 

Using multi-channel processor

When using this unit with a Pioneer multi-channel processor, you can enjoy the atmosphere and excitement provided by DVD movie and music software featuring 5.1 channel recordings.

For details concerning operation, refer to *Introduction of DSP adjustments* on page 89.

- Manufactured under license from Dolby Laboratories. "Dolby", "Pro Logic", and the double-D symbol are trademarks of Dolby Laboratories.



- "DTS" and "DTS Digital Surround" are registered trademarks of Digital Theater Systems, Inc.



Using iPod

When you use this unit with a Pioneer iPod adapter (CD-IB100II) (sold separately), you can control an iPod with Dock Connector. 

For details concerning operation, refer to *Playing songs on iPod* on page 68.

- iPod is a trademark of Apple Computer, Inc., registered in the U.S. and other countries.
- iPod adapter supports only an iPod with Dock Connector. 

Using a Pioneer navigation unit

When you use this unit with the Pioneer DVD navigation unit, make sure that you use the map disc CNDV-30 or later. This manual explains the operations with the combined use of them.

If you do not use the map disc CNDV-30 but use an older version with the navigation unit, this unit may have some failures or inconveniences as follows:

- **ENTERTAINMENT (ENT)** button and **WIDE** button cannot function as **V.D.P. MENU** button and **POS** button.
- **NAVI** (navigation unit), such as DVD video from the combined Pioneer navigation unit with DVD video playback, cannot be selected as a source.
- In **NAVI MIX**, the settings other than **ALL** cannot be selected.
- Voice-recognition control system of the combined Pioneer navigation unit may not function properly with this unit. The voice operation for navigation can be used, but the voice operation related to AV equipment cannot be used.
- Route guidance of the combined Pioneer navigation unit may not function properly when some other source images are displayed. Guidance by voice can be obtained, but on guidance by display (e.g. switching to an enlarged map of an intersection) cannot be obtained. 

Customising your system

Using the AVG-VDP1 (Pioneer Vehicle Dynamics Processor)

This unit can be used as the display unit for the AVG-VDP1 (sold separately) product. 

Using the rear display

Combining this unit with a rear display (sold separately), you can display the selected source on the rear display so passengers in rear seats can comfortably view the same image with the front or they can watch the different image (i.e. image from AVG-VDP1) independently.

For details concerning operation, refer to *Selecting video on rear display* on page 102.

- When a Pioneer Vehicle Dynamics Processor (AVG-VDP1) is connected to this unit, the AVG-VDP1 can be displayed on the rear display. (Refer to page 102.)

Important

NEVER install the rear display in a location that enables the driver to watch the DVD or TV while driving. 

Using Bluetooth wireless technology

Playing a Bluetooth audio player using with Bluetooth adapter (e.g. CD-BTB100)

If you connect Bluetooth adapter (e.g. CD-BTB100) to this unit, you can control Bluetooth audio player via Bluetooth wireless technology.

For details concerning operation, refer to *Bluetooth Audio* on page 71.

- Even though your audio player does not contain a Bluetooth wireless technology module, you can still control it using a Bluetooth adapter sold on the market.

Hands-free phoning using with Bluetooth adapter (e.g. CD-BTB100)

If you use Bluetooth adapter (e.g. CD-BTB100), you can connect a cellular phone featuring Bluetooth wireless technology to this unit for hands-free, wireless calls, even while driving. For details concerning hands-free phoning operation, refer to *Hands-free phoning with cellular phones featuring Bluetooth wireless technology* on page 74. 

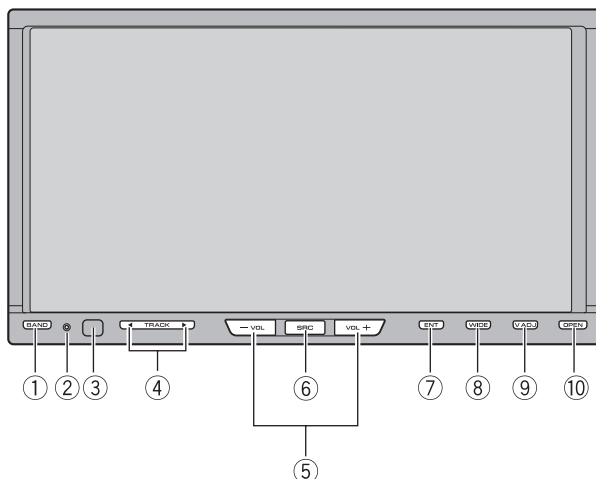

Head unit

① BAND button

Press to select among three FM bands and one AM band and to cancel the control mode of functions.

② RESET button

Press to return to the factory settings (initial settings).

③ Signal receptor

Receives signals from a remote control.

④ ◀/▶ buttons

Press to do manual seek tuning, fast forward, reverse and track search controls.

⑤ VOLUME

Press to increase or decrease the volume.

⑥ SOURCE button

This unit is turned on by selecting a source. Press to cycle through all the available sources.

⑦ ENTERTAINMENT (ENT) button

Press to display the entertainment menu.

⑧ WIDE button

Press to select a desired mode for enlarging a 4:3 picture to a 16:9 one.

⑨ V.ADJ button

Press and hold to display the picture adjustment menu.

⑩ OPEN button

Press to slide down or up the LCD panel.

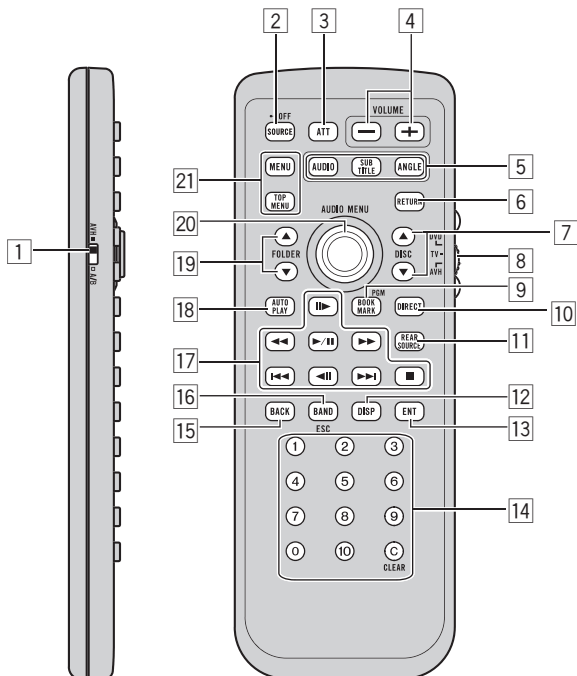

Remote control

	Button names	AVH mode	DVD mode with remote control code AVH
1	Remote control selection switch	Switch to change the setting of the remote control. For details, refer to <i>Setting remote control code type</i> on page 115.	
2	SOURCE button	Press to cycle through all the available sources. Press and hold to turn the source off.	
3	ATT button	Press to quickly lower the volume level, by about 90%. Press once more to return to the original volume level.	
4	VOLUME buttons	Press to increase or decrease the volume.	
5	AUDIO button	Press to change the audio language during DVD playback.	
	SUB TITLE button	Press to change the subtitle language during DVD playback.	
	ANGLE button	Press to change the viewing angle during DVD playback.	
6	RETURN button	Press to display the PBC (playback control) menu during PBC playback.	

What's What

	Button names	AVH mode	DVD mode with remote control code AVH
7	▲/▼ button (DISC)	Press to select the next/previous disc.	
8	Remote control operation mode switch	Switch the operation mode between AVH , DVD and TV modes. Normally, set to AVH . For details, refer to <i>Using the remote control operation mode switch</i> on the next page.	
9	BOOKMARK button/ PGM button	Press to operate the preprogrammed functions for each source. (Refer to <i>Using the preprogrammed function</i> on page 115.)	Press to turn the bookmark function on or off. For details, refer to <i>Resume playback (Bookmark)</i> on page 31.
10	DIRECT button	Press to do direct XM/SIRIUS channel select.	Not used.
11	REAR.S button	Not used.	
12	DISPLAY button	Press to select different displays.	Not used.
13	ENTERTAINMENT (ENT) button	Press to display the entertainment menu.	Not used.
14	0–10 buttons, CLEAR button	Press 0–10 to input numbers. Buttons 1–6 can operate the preset tuning for the tuner or disc changing for DVD player or multi-CD player. Press CLEAR to clear the input numbers.	Press to select a menu on the DVD top menu.
15	BACK button	Press to return to the previous display.	Not used.
16	BAND button	Press to select among three FM bands and one AM band and to cancel the control mode of functions. Press to switch mode between MP3/WMA and audio data (CD-DA) when playing discs with MP3/WMA and audio data (CD-DA) such as CD-EXTRA and MIXED-MODE CDs.	Press to switch mode between MP3/WMA and audio data (CD-DA) when playing discs with MP3/WMA and audio data (CD-DA) such as CD-EXTRA and MIXED-MODE CDs.
17	PLAY/PAUSE (▶/⏸) button	Press to switch sequentially between playback and pause.	
	REVERSE (◀◀) button	Press to perform fast reverse.	
	FORWARD (▶▶) button	Press to perform fast forward.	
	PREVIOUS (◀◀) button	Press to return to the previous track (chapter).	
	NEXT (▶▶) button	Press to go to the next track (chapter).	
	STEP (⏪/◀) button	Press to move ahead one frame at a time during DVD/VideoCD playback. Press and hold for one second to activate slow playback.	
	STOP (■) button	Press to stop playback.	

	Button names	AVH mode	DVD mode with remote control code AVH
18	AUTO PLAY button	Press to turn the DVD auto-playback function on or off.	
19	▲/▼ button (FOLDER)	Press to select the next/previous folder.	
20	Joystick	Move to do fast forward, reverse and track search controls. Click to recall MENU .	Move to select a menu on the DVD menu.
21	MENU button	Press to display the DVD menu during DVD playback.	
	TOP MENU (TOP.M) button	Press to return to the top menu during DVD playback.	

Using the remote control operation mode switch

There are three remote control operation modes on the remote control.

AVH mode operation

When operating this unit by remote control, the mode is normally switched to **AVH**.

- The joystick on the remote control can perform the same operations as the one on the head unit. Furthermore, the joystick can perform the same operations as the touch panel keys **▲**, **▼**, **◀** and **▶**.
- **1–6** can perform the same operations as the preset tuning keys **P1—P6** and the disc selection keys **01–06**.
 - If you want to select a disc located at 7 to 12 by using buttons **1–6**, press and hold the corresponding numbers, such as **1** for disc 7, until the disc number appears in the display.

DVD mode operation

If you switch the mode to **DVD**, the joystick and **0–10** operations are changed for DVD player.

● When you want to operate the following functions, switch the mode to DVD:

- When operating the DVD menu by using the joystick. (Refer to *Operating the DVD menu* on page 30.)
- When operating the PBC menu by using **0–10**. (Refer to *Watching a Video CD* on page 36.)
- When specifying title by using **0–10**. (Refer to *Specifying title* on page 32.)

TV mode operation

TV operations available with a Pioneer TV tuner (e.g. GEX-P5700TV) can be controlled with **AVH** mode. **TV** mode is not used with this unit.

- For details concerning operation, refer to the TV tuner's operation manuals. 

Basic Operations

Turning the unit on and selecting a source

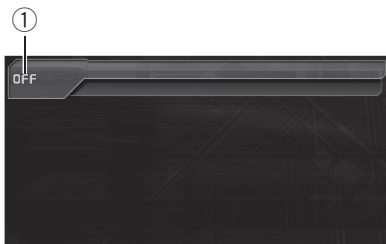

① Source icon

Shows which source has been selected.

You can select a source you want to listen to. To switch to the DVD player, load a disc in the unit to switch to **DVD-V**.

● When using the touch panel keys, touch the source icon and then touch the desired source name.

The source names are displayed and selectable ones are highlighted.

- **DISC 1** – Built-in DVD player disc 1
- **DISC 2** – Built-in DVD player disc 2
- **DISC 3** – Built-in DVD player disc 3
- **DISC 4** – Built-in DVD player disc 4
- **DISC 5** – Built-in DVD player disc 5
- **DISC 6** – Built-in DVD player disc 6
- **TUNER** – Tuner
- **TV** – Television
- **iPod** – iPod
- **AUX1** – AUX 1
- **AUX2** – AUX 2
- **AV** – AV input
- **NAVI** – Navigation unit
- **TEL** – BT telephone
- **BT Audio** – Bluetooth audio player
- **EXT1** – External unit 1
- **EXT2** – External unit 2
- **M-CD** – Multi-CD player
- **XM** – XM tuner

- **SIRIUS** – SIRIUS tuner
- **OFF** – Turn the unit off
- **ESC** – Close source select menu
 - When the source icon is not displayed, you can display it by touching the screen.
 - To return to the playback display, touch **ESC**.

● When using the buttons, press **SOURCE** to select a source.

Press **SOURCE** repeatedly to switch between the following sources:

XM (XM tuner)—**SIRIUS** (SIRIUS tuner)—**TUNER** (tuner)—**TV** (television)—**AV** (AV)—**DVD-V** (built-in DVD player)—**M-CD** (multi-CD player)—**iPod** (iPod)—**EXT1** (external unit 1)—**EXT2** (external unit 2)—**AUX1** (AUX 1)—**AUX2** (AUX 2)—**NAVI** (navigation unit)—**TEL** (bluetooth telephone)—**BT Audio** (bluetooth audio player)

Notes

- In the following cases, the sound source will not change:
 - When there is no unit corresponding to the selected source connected to this unit.
 - When there is no disc in the unit.
 - When there is no magazine in the multi-CD player.
 - When the AUX (auxiliary input) is set to off (refer to page 107).
 - When the AV (AV input) is not set to **VIDEO** (refer to page 101).
- External unit refers to a Pioneer product (such as one available in the future) that, although incompatible as a source, enables control of basic functions by this unit. Two external units can be controlled by this unit. When two external units are connected, the allocation of them to external unit 1 or external unit 2 is automatically set by this unit.

- When this unit's blue/white lead is connected to the vehicle's auto-antenna relay control terminal, the vehicle's antenna extends when this unit's source is turned on. To retract the antenna, turn the source off. 

Loading/Ejecting discs

CAUTION

Keep hands and fingers clear of the unit when opening, closing, or adjusting the LCD panel. Be especially cautious of children's hands and fingers.

Loading a disc

Up to six discs can be stored into this unit. Each disc is stored in each disc holder allowing you to specify a holder for loading a disc.

1 Press OPEN on the unit to display loading/ejecting menu.

The LCD panel opens halfway, and the loading/ejecting menu is displayed on the screen.

- If the disc in the holder has already been played, the disc type is displayed on the holder icon (e.g. CD, DVD etc.).
- NO DISC** is displayed for an empty holder.

2 Touch LOAD next to the holder you want to insert a disc in.

The selected holder flashes. When **READY** is displayed, this unit becomes on standby to load a disc into the holder.

- If the holder has already loaded a disc, you need to eject the disc first. For details concerning about ejecting a disc, refer to *Ejecting a disc* on the next page.

3 Insert a disc into the disc loading slot.

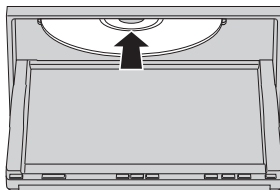

The disc is loaded into the selected holder. Repeat these steps until you have done loading discs into this unit.

- To cancel loading the disc into the selected holder, touch **CANCEL**.

4 To replace the LCD panel to the original position, press OPEN on the unit.

- When the automatic playback function is on, this unit will cancel the DVD menu and automatically start playback from the first chapter of the first title. Refer to *Automatic playback of DVDs* on page 34.



Notes

- The DVD player plays one, standard 12-cm disc at a time. Playing back an 8-cm disc is not possible with this unit. Playable disc and adapter are listed in the table below.

12-cm disc	8-cm disc	8-cm disc adapter
√	—	—

- Do not insert anything other than a disc into the disc loading slot. Discs which can be played back are listed on *Playable discs* on page 8.
- If you cannot insert a disc completely or if after you insert a disc the disc does not play, check that the label side of the disc is up. Press **OPEN** and touch  to eject the disc, and check the disc for damage before inserting it again.
- If an error message such as **ERROR-02** is displayed, refer to *Error messages* on page 119.

Basic Operations

- If bookmark function is on, DVD playback resumes from the selected point. For more details, refer to *Resume playback (Bookmark)* on page 31.
- This unit does not automatically change discs even if it reaches to the end of the currently playing disc. To change discs, press ▲ or ▼ button (DISC) on the remote control.

Ejecting a disc

You can specify a holder that you eject a disc from.

1 Press OPEN on the unit to display loading/ejecting menu.

The LCD panel opens halfway, and the loading/ejecting menu is displayed on the screen.

- If the disc in the holder has already been played, the disc type is displayed on the holder icon (e.g. CD, DVD etc.).
- **NO DISC** is displayed for an empty holder.

2 Touch ▲ next to the holder you want to eject the disc from.

The disc is ejected.

- You can eject all loaded discs at once. To do this, touch **ALL▲**.

To cancel the all ejecting, touch **CANCEL**.

3 To replace the LCD panel to the original position, press OPEN on the unit.

Adjusting the flap angle

You can adjust the flap angle as needed.



Important

When adjusting the flap angle, be sure to follow the procedures explained below. Forcibly adjusting the flap angle by hand may damage it.

1 Press and hold OPEN button on the unit to display the flap angle adjust menu.

2 Touch + or - to adjust the flap angle.

Each time you touch +, the flap comes out toward you. Touching - moves the flap the other way around.

- You can select from five positions for the flap angle.
- The adjusted flap angle will be memorized. The next time you eject or load discs, the flap returns to the position where you set the angle. 

Adjusting the volume

● Use VOLUME to adjust the sound level.

Press **VOLUME** to increase or decrease the source volume. 

Turning the unit off

● When using the touch panel keys, touch the source icon and then touch OFF.

- When the source icon is not displayed, you can display it by touching the screen.
- When using the buttons, press **SOURCE** and hold until the unit turns off.
- To completely turn the display off, touch and hold **DISP. OFF**. Refer to *Using the common touch panel keys* on the next page. 

Touch panel key basic operation

Activating the touch panel keys

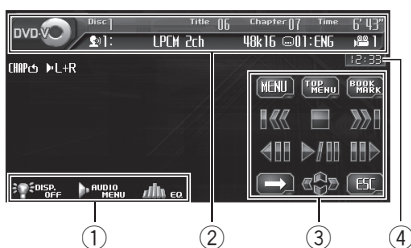

- ① **Common touch panel keys**
For details, refer to *Using the common touch panel keys* on this page.
- ② **Information bar**
- ③ **Touch panel keys**
Touch to do various operations.
- ④ **Clock display**
To turn the clock on or off, or to adjust the time, refer to *Setting the clock* on page 102.

1 Touch the screen to activate the touch panel keys corresponding to each source.

The touch panel keys appear on the display.

- To go to the next group of touch panel keys, touch →.

2 Touch ESC to hide the touch panel keys.



Note

If you do not use the touch panel keys within 30 seconds, they will be hidden automatically.

Using the common touch panel keys

EQ, **AUDIO MENU** and **DISP. OFF** keys are commonly displayed in the source menu.

EQ key

Touch **EQ** to display the equalizer curve setting menu. Adjust the equalizer curve and make the best sound characteristic for the sound type.

For details concerning operation, refer to *Using the equalizer* on page 85.

AUDIO MENU key

Touch **AUDIO MENU** to display the menu for various settings.

For details concerning operation, refer to *Operating the menu* on the next page.

DISP. OFF key

Touch and hold **DISP. OFF** to turn the display off. Touch the screen to turn the display on.

Using DISP. OFF to retract the vehicle's antenna

At the standard setting, the vehicle's auto antenna is automatically retracted when you select the source **OFF**. However, when a navigation unit or AVG-VDP1 is connected to this unit, your vehicle's antenna may be kept up-position even if the source **OFF** is selected. In that case, use **DISP. OFF** key and have the antenna retracted manually.

- Only when a Pioneer navigation unit or AVG-VDP1 is connected to this unit, you can operate this function.
- **Touch the source OFF, and then, touch and hold DISP. OFF.**
The display is turned off and your vehicle's antenna is retracted.
 - When a Pioneer navigation unit (or AVG-VDP1) and the multi-channel processor (e.g. DEQ-P8000) are connected to this unit, the antenna should be retracted at the time when the source **OFF** is selected.
 - While the antenna is retracted, a guidance voice/beep from the navigation unit is not properly mixed with the audio sound outputted from this unit.

Operating the menu

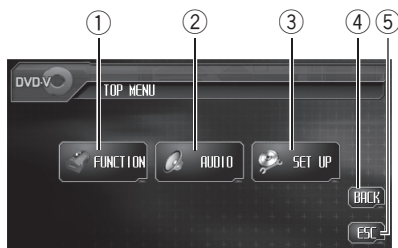

- ① **FUNCTION key**
Touch to select functions for each source.
- ② **AUDIO key**
Touch to select various sound quality controls.
- ③ **SETUP key**
Touch to select various setup functions.
- ④ **BACK key**
Touch to return to the previous display.
- ⑤ **ESC key**
Touch to cancel the control mode of functions.

1 Touch AUDIO MENU to display MENU.
MENU appears on the display.

2 Touch the desired key to display the function names you want to operate.

- To go to the next group of function names, touch **NEXT**.
- To return to the previous group of function names, touch **PREV**.

3 Touch ESC to return to the display of each source.

Note

If you do not operate the function within about 30 seconds, the display is automatically returned to the playback display. 

Listening to the radio

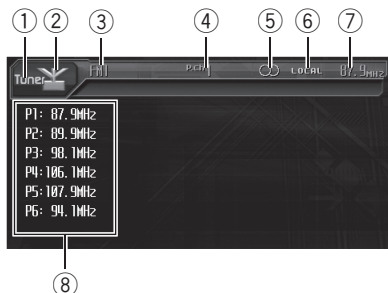

These are the basic steps necessary to operate the radio. More advanced tuner operation is explained starting on the next page.

- ① **Source name**
Shows the selected source name.
- ② **Source icon**
Shows which source has been selected.
- ③ **Band indicator**
Shows which band the radio is tuned to, AM or FM.
- ④ **Preset number indicator**
Shows which preset has been selected.
- ⑤ **STEREO indicator**
Shows when the selected frequency is being broadcast in stereo.
- ⑥ **LOCAL indicator**
Shows when local seek tuning is on.
- ⑦ **Frequency indicator**
Shows the frequency to which the tuner is tuned.
- ⑧ **Preset list display**
Shows the preset list.

1 Touch the source icon and then touch **TUNER** to select the tuner.

2 Touch the screen to display the touch panel keys.

3 Touch **BAND** to select a band.

Touch **BAND** repeatedly until the desired band is displayed, **FM1**, **FM2**, **FM3** for FM or **AM**.

4 To select a preset channel, touch a **pre-set channel on the list** or touch **▲** or **▼** (**P.CH**).

The preset channel you selected is tuned in.

- Touching **LIST** switches between the preset channel list display and the **▲/▼** (**P.CH**) display. Either way, the channels that can be selected are the same.

5 To perform manual tuning, briefly touch **◀** or **▶**.

The frequencies move up or down step by step.

- You can also perform manual tuning by moving the joystick on the remote control left or right.

6 To perform seek tuning, keep touching **◀** or **▶** for about one second and release.

The tuner will scan the frequencies until a broadcast strong enough for good reception is found.

- You can cancel seek tuning by briefly touching either **◀** or **▶**.
- If you keep touching **◀** or **▶** you can skip stations. Seek tuning starts as soon as you release the key.
- You can also perform seek tuning by holding the joystick on the remote control left or right.



Note

If you do not use the touch panel keys within 30 seconds, they will be hidden automatically. 

Storing and recalling broadcast frequencies

If you touch any of the preset tuning keys **P1—P6** you can easily store up to six broadcast frequencies for later recall with the touch of a key.

- **When you find a frequency that you want to store in memory keep touching one of preset tuning keys P1—P6 until the preset number stops flashing.**

The number you have touched will flash in the preset number indicator and then remain lit. The selected radio station frequency has been stored in memory.

The next time you touch the same preset tuning key the radio station frequency is recalled from memory.

- When the touch panel keys are not displayed, you can display them by touching the screen.
- When **P1—P6** are not displayed, you can display them by touching **LIST**.

Notes

- Up to 18 FM stations, six for each of the three FM bands, and six AM stations can be stored in memory.
- You can also recall radio station frequencies assigned to preset tuning keys **P1—P6** by moving the joystick on the remote control up or down. 

Introduction of advanced tuner operation

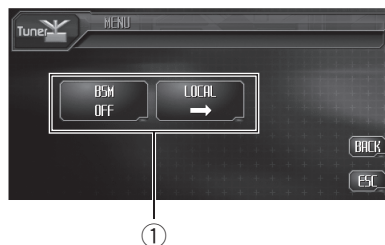

- ① **Function display**
Shows the function names.

1 Touch AUDIO MENU to display MENU.
MENU appears on the display.

2 Touch FUNCTION to display the function names.

The function names are displayed and operable ones are highlighted.

- To return to the previous display, touch **BACK**.
- To return to the frequency display, touch **ESC**.

Note

If you do not operate the function within about 30 seconds, the display is automatically returned to the frequency display. 

Storing the strongest broadcast frequencies

BSM (best stations memory) lets you automatically store the six strongest broadcast frequencies under preset tuning keys **P1—P6** and once stored there you can tune in to those frequencies with the touch of a key.

● **Touch BSM on the function menu to turn BSM on.**

BSM appears. While **BSM** is flashing the six strongest broadcast frequencies will be stored under preset tuning keys **P1—P6** in order of their signal strength. When finished, **BSM** disappears.

- To cancel the storage process, touch **BSM** again.



Note

Storing broadcast frequencies with BSM may replace broadcast frequencies you have saved using **P1—P6**.

Tuning in strong signals

Local seek tuning lets you tune in only those radio stations with sufficiently strong signals for good reception.

1 Touch LOCAL on the function menu.

2 Touch ◀ on the LOCAL setting to turn local seek tuning on.

- To turn local seek tuning off, touch ▶.

3 Touch ◀ or ▶ on the LEVEL setting to set the sensitivity.

There are four levels of sensitivity for FM and two levels for AM:

FM: **1—2—3—4**

AM: **1—2**

The **4** setting allows reception of only the strongest stations, while lower settings let you receive progressively weaker stations.

Playing DVD video discs

Watching a DVD video

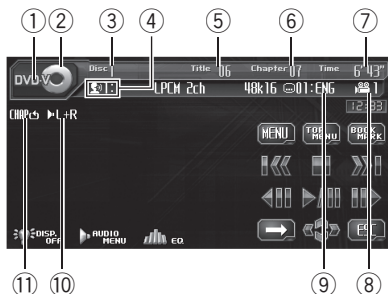

These are the basic steps necessary to play a DVD video with your DVD player. More advanced DVD video operation is explained starting on page 34.

- Switch the remote control operation mode to **DVD** to perform DVD operations. (Refer to page 20.)

- ① **DVD Video indicator**
Shows when a DVD video is playing.
- ② **Source icon**
Shows which source has been selected.
- ③ **Disc number indicator**
Shows the disc number currently playing.
- ④ **Audio language indicator**
Shows which audio language has been selected.
- ⑤ **Title number indicator**
Shows the title currently playing.
- ⑥ **Chapter number indicator**
Shows the chapter currently playing.
- ⑦ **Play time indicator**
Shows the elapsed playing time of the current chapter.

- ⑧ **Viewing angle indicator**
Shows which viewing angle has been selected.
- ⑨ **Subtitle language indicator**
Shows which subtitle language has been selected.
- ⑩ **Audio output indicator**
Shows the output channel selected currently.
- ⑪ **Repeat indicator**
Shows the selected repeat range.

1 Touch the source icon and then touch a desired DVD holder number (e.g. DISC 1) to select the DVD player.

Selectable DVD holders are highlighted. If a disc is not inserted, you cannot select that DVD holder.

- When the source icon is not displayed, you can display it by touching the screen.
- With some discs, a menu may be displayed. (Refer to *Operating the DVD menu* on the next page.)
- This unit does not automatically change discs even if it reaches to the end of the currently playing disc. To change discs, press **▲** or **▼** button (DISC) on the remote control.

2 Touch the screen to display the touch panel keys.

3 Touch **→** to switch the menu.

Touching **→** repeatedly changes the menus.

4 To skip back or forward to another chapter, touch **◀◀** or **▶▶**.

Touching **▶▶** skips to the start of the next chapter. Touching **◀◀** once skips to the start of the current chapter. Touching it again will skip to the previous chapter.

Playing DVD video discs

- You can also skip back or forward to another chapter by pressing **I◀◀** or **▶▶I** button on the remote control.

5 To perform fast forward or reverse, keep touching **I◀◀** or **▶▶I**.

If you keep touching **I◀◀** or **▶▶I** for five seconds, fast reverse/fast forward continues even if you release **I◀◀** or **▶▶I**. To resume playback at a desired point, touch **▶/II**.

- You can also perform fast reverse/fast forward by pressing and holding **◀◀** or **▶▶** button on the remote control.
- Fast forward/fast reverse may not be possible at certain locations on some discs. If this happens, normal playback automatically resumes.



Note

If you do not use the touch panel keys within 30 seconds, they will be hidden automatically. 

Operating the DVD menu

Some DVDs allow you to select from the disc contents using a menu.

- You can display the menu by touching **MENU** or **TOP MENU** while a disc is playing. Touching either of these keys again lets you start playback from the location selected from the menu. For details, refer to the instructions provided with the disc.

1 Touch **◀◀▶▶** to display touch panel keys to operate the DVD menu.

2 Touch **▲, ▼, ◀** or **▶** to select the desired menu item.

3 Touch **ENTER**.

Playback starts from the selected menu item.

- The way to display the menu differs depending on the disc.

Operating the DVD menu with 10 key

Some DVDs allow you to select from the disc contents using **10KEY**.

1 Touch **10KEY**.

2 Touch **0–9** corresponding to a menu number and then touch **ENTER** to start playback.

- To select 3, touch **3**.
- To select 10, touch **1** and **0** in that order.
- To select 23, touch **2** and **3** in that order. 

Skipping back or forward to another title

● Touch **▲** or **▼** title key to skip back or forward to another title.

Touching **▲** skips to the start of the next title. Touching **▼** skips to the start of the previous title.

Title numbers are displayed for eight seconds.

- You can also skip back or forward to another title by moving the joystick up or down. 

Stopping playback

● Touch **■**.

▪ When you stop DVD playback by touching **■**, that location on the disc is memorized, enabling playback from that point when you play the disc again.

- To play back the disc again, touch **▶/II**. 

Pausing DVD video playback

Pause lets you temporarily stop disc playback.



Playing DVD video discs

● Touch ►/II during playback.

PAUSE is displayed on the information bar and playback is paused, letting you view a still image.

- To resume playback at the same point that you turned pause on, touch ►/II again.

Note

Depending on the disc and the playback location on the disc, the icon  may be displayed, indicating that still playback is not possible. 

Resume playback (Bookmark)

The Bookmark function lets you resume playback from a selected scene the next time the disc is loaded.

● During playback, touch **BOOKMARK** at the point you want to resume playback next time.

The selected scene will be bookmarked so that playback resumes from that point next time. You can bookmark up to six discs. After that, the oldest bookmark is replaced by the new one.

- To clear the bookmark on a disc, keep touching **BOOKMARK** during playback.
- You can also bookmark a disc using **BOOKMARK** button on the remote control.

Note

One bookmark point can be stored for each disc holder independently. 

Frame-by-frame playback



This lets you move ahead one frame at a time during playback.

● Touch II► during playback.

Each time you touch II►, you move ahead one frame.

- To return to normal playback, touch ►/II.

Notes

- Depending on the disc and the playback location on the disc, the icon  may be displayed, indicating that frame-by-frame playback is not possible.
- With some discs, images may be unclear during frame-by-frame playback. 

Slow motion playback

This lets you slow down playback speed.

1 Keep touching II► during playback.



A beep sounds and forward slow motion playback begins.

- To return to normal playback, touch ►/II.

2 Touch ◀II or II► to adjust playback speed during slow motion playback.

Each time you touch ◀II or II► it changes the speed in four steps in the following order: 1/16—1/8—1/4—1/2

Notes

- There is no sound during slow motion playback.
- Depending on the disc and the playback location on the disc, the icon  may be displayed, indicating that slow motion playback is not possible.
- With some discs, images may be unclear during slow motion playback.
- Reverse slow motion playback is not possible. 

Searching for a desired scene, starting playback from a specified time

You can use the search function to search for a desired scene by specifying a title or chapter, and the time search function to specify the time on a disc at which play starts.

- Chapter search and time search are not possible when disc playback has been stopped.

1 Touch SEARCH.

2 Touch TITLE (title), CHAP. (chapter) or TIME (time).

3 Touch 0—9 to input the desired number.

For titles and chapters

- To select 3, touch **3**.
- To select 10, touch **1** and **0** in that order.
- To select 23, touch **2** and **3** in that order.

For time (time search)

- To select 21 minutes 43 seconds, touch **2**, **1**, **4** and **3** in that order.
- To select 1 hour 11 minutes, convert the time into 71 minutes 00 seconds and touch **7**, **1**, **0** and **0** in that order.
- To cancel the inputted numbers, touch **C**.

4 While the inputted number is displayed, touch ENTER.

This starts playback from the selected scene.

Notes

- With discs featuring a menu, you can also touch **MENU** or **TOP MENU** and then make selections from the displayed menu.
- With some discs, the icon  may be displayed, indicating that titles, chapters and time cannot be specified.

Specifying title

You can use the direct search function to search for a desired scene by specifying a title.

1 Touch 10KEY.

- This feature is available only when the playback is stopped. If you are playing back a disc, touch  to stop the playback and then touch **10KEY**.

2 Touch 0–9 corresponding to a desired title number.

- To select 3, touch **3**.
- To select 10, touch **1** and **0** in that order.
- To select 23, touch **2** and **3** in that order.

3 While the inputted number is displayed, touch .

Title number is displayed for eight seconds and playback starts from the selected title.

Note

To perform this function with the remote control, switch the remote control operation mode to **DVD**. (Refer to *Using the remote control operation mode switch* on page 20.) 

Changing audio language during playback (Multi-audio)

DVDs can provide audio playback with different languages and different systems (Dolby Digital, DTS etc.). With DVDs featuring multi-audio recordings, you can switch between languages/audio systems during playback.



• Touch AUDIO during playback.

Each time you touch **AUDIO** it switches between audio systems.

Playing DVD video discs



Notes

- You can also switch between languages/audio systems using **AUDIO** on the remote control.
- The number in the  mark on a DVD's package indicates the number of recorded languages/audio systems.
- With some DVDs, switching between languages/audio systems may only be possible using a menu display.
- You can also switch between languages/audio systems using **DVD SETUP**. For details, refer to *Setting the audio language* on page 104.
- Only digital output of DTS audio is possible. If this unit's optical digital outputs are not connected, DTS audio will not be output, so select an audio setting other than DTS.
- Display indications such as **Dolby D** and **5.1ch** indicate the audio system recorded on the DVD. Depending on the setting, playback may not be with the same audio system as that indicated.
- Touching **AUDIO** during fast forward/fast reverse, pause or slow motion playback returns you to normal playback. .

Changing the subtitle language during playback (Multi-subtitle)

With DVDs featuring multi-subtitle recordings, you can switch between subtitle languages during playback.



- **Touch SUB TITLE during playback.**

Each time you touch **SUB TITLE** it switches between subtitle languages.



Notes

- You can also switch between subtitle languages using **SUB TITLE** on the remote control.

- The number in the  mark on a DVD's package indicates the number of recorded subtitle languages.
- With some DVDs, switching between subtitle languages may only be possible using a menu display.
- You can also switch between subtitle languages using **DVD SETUP**. For details, refer to *Setting the subtitle language* on page 103.
- Touching **SUB TITLE** during fast forward/fast reverse, pause or slow motion playback returns you to normal playback. .

Changing the viewing angle during playback (Multi-angle)

With DVDs featuring multi-angle (scenes shot from multiple angles) recordings, you can switch among viewing angles during playback.



- During playback of a scene shot from multiple angles, the angle icon  is displayed. Turn angle icon display on or off using **DVD SETUP**. For details, refer to *Setting the angle icon display* on page 104.

- **Touch ANGLE during playback of a scene shot from multiple angles.**

Each time you touch **ANGLE** it switches between angles.



Notes

- You can also change the angle using **ANGLE** on the remote control.
- The  mark on a DVD's package indicates it features multi-angle scenes. The number in the  mark indicates the number of angles from which scenes were shot.
- Touching **ANGLE** during fast forward/fast reverse, pause or slow motion playback returns you to normal playback. .

Return to the specified scene

You can return to the specified scene where the DVD you are currently playing has been preprogrammed to return.

- Touch **RETURN** to return to the specified scene.

Note

If a specified scene has not been preprogrammed in DVD disc, this function is not possible. 

Automatic playback of DVDs

When a DVD disc with DVD menu is inserted, this unit will cancel the DVD menu automatically and start playback from the first chapter of the first title.

- Some DVDs may not operate properly. If this function is not fully operated, turn this function off and start playback.

- Touch **AUTO PLAY** to turn automatic playback on.

- To turn automatic playback off, touch **AUTO PLAY** again.
- You can also turn automatic playback on or off by pressing **AUTO PLAY** button on the remote control.
- When the automatic playback is on, you cannot operate repeating play of DVD disc (refer to *Repeating play* on this page). 

Introduction of advanced DVD video operation

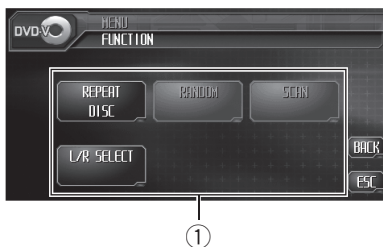

- ① **Function display**

Shows the function names.

- 1 Touch **AUDIO MENU** to display **MENU**. **MENU** appears on the display.

- 2 Touch **FUNCTION** to display the function names.

The function names are displayed and operable ones are highlighted.

- To return to the previous display, touch **BACK**.
- To return to the playback display, touch **ESC**.

Note

If you do not operate the function within about 30 seconds, the display is automatically returned to the playback display. 

Repeating play

There are three repeat play ranges for the DVD playback: **DISC** (disc repeat), **CHAPTER** (chapter repeat), and **TITLE** (title repeat).

- Touch **REPEAT** on the function menu to select the repeat range.

- **DISC** – Play through the current disc
- **CHAPTER** – Repeat just the current chapter

Playing DVD video discs

- **TITLE** – Repeat just the current title



Notes

- If you perform chapter search or fast forward/reverse, the repeat play range changes to **DISC**.
- Depending on the disc and the playback location on the disc, the function may not be selectable, indicating that operating this function is not possible. 

Selecting audio output

You can switch the audio output.

- This function is not possible when disc playback has been stopped.
- **Touch L/R SELECT on the function menu to select the audio output.**
 - **L+R** – left and right
 - **LEFT** – left
 - **RIGHT** – right



Note

Depending on the disc and the playback location on the disc, the function may not be selectable, indicating that operating this function is not possible. 

Watching a Video CD



These are the basic steps necessary to play a Video CD with your DVD player. More advanced Video CD operation is explained starting on page 39.

- Switch the remote control operation mode to **DVD** to perform video CD operations. (Refer to page 20.)

- ① **Video CD indicator**
Shows when a Video CD is playing.
- ② **Source icon**
Shows which source has been selected.
- ③ **Disc number indicator**
Shows the disc number currently playing.
- ④ **Track number indicator**
Shows the track number currently playing.
- ⑤ **Play time indicator**
Shows the elapsed playing time of the current track.
- ⑥ **Audio output indicator**
Shows the output channel selected currently.
- ⑦ **Repeat indicator**
Shows the selected repeat range.

1 Touch the source icon and then touch a desired DVD holder number (e.g. DISC 1) to select the DVD player.

- When the source icon is not displayed, you can display it by touching the screen.
- With a Video CD featuring the PBC (playback control) function, a menu is displayed.
- This unit does not automatically change discs even if it reaches to the end of the currently playing disc. To change discs, press **▲** or **▼** button (DISC) on the remote control.

2 Touch the screen to display the touch panel keys.

3 Touch 10KEY and then touch 0–9 to select the desired menu item.

- Depending on the discs, the menu may be two or more pages long. In such case, touch **◀◀** or **▶▶** to display the next or previous menu. Once you confirm a desired menu number, touch **10KEY** to make the selection.

4 While the inputted number is displayed, touch **↵.**

Playback starts from the selected menu item.

- You can display the menu by pressing **RETURN** during PBC playback. For details, refer to the instructions provided with the disc.

5 To skip back or forward to another track, touch **◀◀ or **▶▶**.**

Touching **▶▶** skips to the start of the next track. Touching **◀◀** once skips to the start of the current track. Touching it again will skip to the previous track.

Track numbers are displayed for eight seconds.

- You can also skip back or forward to another track by pressing **◀◀** or **▶▶** button on the remote control.
- During PBC playback, a menu may be displayed if you perform these operations.

Playing Video CDs

6 To perform fast forward or reverse, keep touching **I◀◀** or **▶▶I**.

If you keep touching **I◀◀** or **▶▶I** for five seconds, fast reverse/fast forward continues even if you release **I◀◀** or **▶▶I**. To resume playback at a desired point, touch **▶/II**.

- You can also perform fast reverse/fast forward by pressing and holding **◀◀** or **▶▶** button on the remote control.
- Fast forward/fast reverse may not be possible at certain locations on some discs. If this happens, normal playback automatically resumes.



Note

If you do not use the touch panel keys within 30 seconds, they will be hidden automatically. 

Stopping playback

● Touch **■**.

- When you stop Video CD playback (during PBC playback only) by touching **■**, that location on the disc is memorized, enabling playback from that point when you play the disc again.
- To play back the disc again, touch **▶/II**. 

Pausing Video CD playback

Pause lets you temporarily stop disc playback.



● Touch **▶/II** during playback.

PAUSE is displayed on the information bar and playback is paused, letting you view a still image.

- To resume playback at the same point that you turned pause on, touch **▶/II** again.



Note

Depending on the disc and the playback location on the disc, the icon  may be displayed, indicating that still playback is not possible. 

Frame-by-frame playback

This lets you move ahead one frame at a time during playback.



● Touch **II▶** during playback.

Each time you touch **II▶**, you move ahead one frame.

- To return to normal playback, touch **▶/II**.



Notes

- Depending on the disc and the playback location on the disc, the icon  may be displayed, indicating that frame-by-frame playback is not possible.
- With some discs, images may be unclear during frame-by-frame playback. 

Slow motion playback

This lets you slow down playback speed.

1 Keep touching **II▶** during playback.

A beep sounds and forward slow motion playback begins.



- To return to normal playback, touch **▶/II**.

2 Touch **◀II** or **II▶** to adjust playback speed during slow motion playback.

Each time you touch **◀II** or **II▶** it changes the speed in four steps in the following order:

1/16—1/8—1/4—1/2

**Notes**

- There is no sound during slow motion playback.
- Depending on the disc and the playback location on the disc, the icon  may be displayed, indicating that slow motion playback is not possible.
- With some discs, images may be unclear during slow motion playback.
- Reverse slow motion playback is not possible. 

Searching for a desired scene, starting playback from a specified time

You can use the search function to search for a desired scene by specifying a track, and the time search function to specify the time on a disc at which play starts.

- During playback of Video CDs featuring PBC (playback control), this function cannot be operated.
- Time search is not possible when disc playback has been stopped.

1 Touch SEARCH.

2 Touch TRACK (track) or TIME (time).

3 Touch 0—9 to input the desired number.

For tracks

- To select 3, touch **3**.
- To select 10, touch **1** and **0** in that order.
- To select 23, touch **2** and **3** in that order.

For time (time search)

- To select 21 minutes 43 seconds, touch **2**, **1**, **4** and **3** in that order.
- To select 1 hour 11 minutes, convert the time into 71 minutes 00 seconds and touch **7**, **1**, **0** and **0** in that order.

- To cancel the inputted numbers, touch **C**.

4 While the inputted number is displayed, touch ENTER.

This starts playback from the selected scene. 

PBC playback

During playback of Video CDs featuring PBC (Playback Control), **PBC ON** is displayed. You can operate PBC menu with **10KEY**.

1 When PBC menu is displayed, touch 10KEY.

- You can display the menu by touching **RETURN** during PBC playback. For details, refer to the instructions provided with the disc.
- Depending on the discs, the menu may be two or more pages long. In such case, touch **I◀◀** or **▶▶I** to display the next or previous menu. Once you confirm a desired menu number, touch **10KEY** to make the selection.

2 Touch 0–9 corresponding to a menu number and then touch to start playback.

- To select 3, touch **3**.
- To select 10, touch **1** and **0** in that order.
- To select 23, touch **2** and **3** in that order.

**Notes**

- PBC playback of Video-CD cannot be cancelled.
- During playback of Video CDs featuring PBC (Playback Control), **PBC ON**, search and time search functions cannot be used nor can you select the range for repeat play. 

Playing Video CDs

Introduction of advanced Video CD operation



① Function display

Shows the function names.

1 Touch AUDIO MENU to display MENU. MENU appears on the display.

2 Touch FUNCTION to display the function names.

The function names are displayed and operable ones are highlighted.

- To return to the previous display, touch **BACK**.
- To return to the playback display, touch **ESC**.

Note

If you do not operate the function within about 30 seconds, the display is automatically returned to the playback display. 

Repeating play

There are two repeat play ranges for the Video CD playback: **TRACK** (track repeat) and **DISC** (disc repeat).

- During playback of Video CDs featuring PBC (playback control), this function cannot be operated.

● Touch REPEAT on the function menu to select the repeat range.

- **TRACK** – Repeat just the current track
- **DISC** – Repeat the current disc

Note

If you perform track search or fast forward/reverse, the repeat play range changes to **DISC**. 

Selecting audio output

You can switch the audio output.

- This function is not possible when disc playback has been stopped.

● Touch L/R SELECT on the function menu to select the audio output.

- **L+R** – left and right
- **LEFT** – left
- **RIGHT** – right

Notes

- You can also switch the audio output using **AUDIO** on the remote control.
- Depending on the disc and the playback location on the disc, the function may not be selectable, indicating that operating this function is not possible. 

Listening to a CD



These are the basic steps necessary to play a CD with your DVD player. More advanced CD operation is explained starting on page 42.

- ① **CD/CD-TEXT indicator**
Shows when a CD is playing.
- ② **Source icon**
Shows which source has been selected.
- ③ **Disc number indicator**
Shows the disc number currently playing.
- ④ **Disc title indicator**
Shows the title of the currently playing disc.
- ⑤ **Track number indicator**
Shows the track number currently playing.
- ⑥ **Play time indicator**
Shows the elapsed playing time of the current track.
- ⑦ **Repeat indicator**
Shows when repeat range is selected to current track.

- 1 Touch the source icon and then touch a desired DVD holder number (e.g. DISC 1) to select the DVD player.**

Selectable DVD holders are highlighted. If a disc is not inserted, you cannot select that DVD holder.

- When the source icon is not displayed, you can display it by touching the screen.
- This unit does not automatically change discs even if it reaches to the end of the currently playing disc. To change discs, press ▲ or ▼ button (DISC) on the remote control.

- 2 Touch the screen to display the touch panel keys.**

- 3 Touch LIST to display track titles and touch a desired title that you want to play back.**

The selected track will begin to play.

- 4 To skip back or forward to another track, touch ◀◀ or ▶▶.**

Touching ▶▶ skips to the start of the next track. Touching ◀◀ once skips to the start of the current track. Touching it again will skip to the previous track.

- If tracks are many, you can change to the previous or next page of the track list by touching ⤴ or ⤵.
- You can also skip back or forward to another track by pressing ◀ or ▶ button on the unit or moving the joystick on the remote control left or right.

- 5 To perform fast forward or reverse, keep touching ◀◀ or ▶▶.**

- You can also perform fast reverse/fast forward by pressing and holding ◀ or ▶ button on the unit or holding the joystick on the remote control left or right.

Playing CDs



Notes

- When playing discs with MP3/WMA files and audio data (CD-DA) such as CD-EXTRA and MIXED-MODE CDs, both types can be played only by switching mode between MP3/WMA and CD-DA by touching **MEDIA** or pressing **BAND**. This function can be operated only when the disc is playing.
- If you do not use the touch panel keys within 30 seconds, they will be hidden automatically.

Stopping playback

- **Touch .**
 - When you stop CD playback by touching , that location on the disc is memorized, enabling playback from that point when you play the disc again.
 - To play back the disc again, touch **▶/||**.

Pausing CD playback

Pause lets you temporarily stop disc playback.

- **Touch **▶/||** during playback.**
PAUSE appears in the display. Play of the current track pauses.
 - To resume playback at the same point that you turned pause on, touch **▶/||** again.

Using CD TEXT functions

Some discs have certain information encoded on the disc during manufacture. These discs may contain such information as the CD title, track title, artist's name and playback time and are called CD TEXT discs. Only these spe-

cially encoded CD TEXT discs support the functions listed below.

Displaying text information on CD TEXT discs

- **Touch **DISP**.**
Touch **DISP** repeatedly to switch between the following settings:
Disc Title (disc title)—**Disc Artist** (disc artist name)—**Track Title** (track title)—**Track Artist** (track artist name)
 - If specific information has not been recorded on a CD TEXT disc, **NO XXXX** will be displayed (e.g., **NO T.ARTIST NAME**).

Scrolling text information in the display

This unit can display the first 20 letters only of **Disc Title**, **Disc Artist**, **Track Title** and **Track Artist**. When the recorded information is longer than 20 letters, you can scroll the text to the left so that the rest of the title can be seen.

- **Keep touching **DISP** until the title begins to scroll to the left.**
The rest of the title will appear in the display.

Introduction of advanced CD operation



① Function display

Shows the function names.

1 Touch AUDIO MENU to display MENU. MENU appears on the display.

- You can also display **MENU** by clicking the joystick on the remote control.

2 Touch FUNCTION to display the function names.

The function names are displayed and operable ones are highlighted.

- To return to the previous display, touch **BACK**.
- To return to the playback display, touch **ESC**.

Note

If you do not operate the function within about 30 seconds, the display is automatically returned to the playback display. 

Repeating play

Repeat play lets you hear the same track over again.

● Touch REPEAT on the function menu to select the repeat range.

- **TRACK** – Repeat just the current track

- **DISC** – Repeat the current disc

Notes

- If you perform track search or fast forward/reverse, the repeat play range changes to **DISC**.
- When playing discs with MP3/WMA files and audio data (CD-DA), repeat play performs within the currently playing data type even if **DISC** is selected. 

Playing tracks in random order

Random play lets you play back tracks on the CD in a random order.

● Touch RANDOM on the function menu to turn random play on.

Tracks will play in a random order.

- To turn random play off, touch **RANDOM** again. 

Scanning tracks of a CD

Scan play lets you hear the first 10 seconds of each track on the CD.

1 Touch SCAN on the function menu to turn scan play on.

The first 10 seconds of each track is played.

2 When you find the desired track touch SCAN again.

Note

After scanning of a CD is finished, normal playback of the tracks will begin again. 

Playing MP3/WMA

Listening to MP3/WMA



These are the basic steps necessary to play an MP3/WMA with your built-in DVD player. More advanced MP3/WMA operation is explained starting on page 46.

- ① **Media indicator**
MP3, **WMA** or **MIX** appears depending on the file format you are playing.
 When playing discs with MP3/WMA files and audio data (CD-DA) such as CD-EXTRA and MIXED-MODE CDs, **MIX** is displayed.
- ② **Source icon**
 Shows which source has been selected.
- ③ **Disc number indicator**
 Shows the disc number currently playing.
- ④ **Folder name indicator**
 Shows the name of the currently playing folder.
- ⑤ **Folder number indicator**
 Shows the folder number currently playing.
- ⑥ **Track number indicator**
 Shows the track (file) number currently playing.

- ⑦ **Play time indicator**
 Shows the elapsed playing time of the current track (file).
- ⑧ **Repeat indicator**
 Shows the selected repeat range.

1 Touch the source icon and then touch a desired DVD holder number (e.g. DISC 1) to select the DVD player.

Selectable DVD holders are highlighted. If a disc is not inserted, you cannot select that DVD holder.

- When the source icon is not displayed, you can display it by touching the screen.

2 Touch the screen to display the touch panel keys.

3 Touch LIST to display track titles and touch a desired title that you want to play back.

The selected track will begin to play.

4 To skip back or forward to another track, touch I◀◀ or ▶▶I.

Touching ▶▶I skips to the start of the next track. Touching I◀◀ once skips to the start of the current track. Touching it again will skip to the previous track.



- You can also skip back or forward to another track by pressing ◀ or ▶ button on the unit or moving the joystick on the remote control left or right.

5 To perform fast forward or reverse, keep touching I◀◀ or ▶▶I.

- You can also perform fast reverse/fast forward by pressing ◀ or ▶ button on the unit or holding the joystick on the remote control left or right.
- There is no sound on fast forward or reverse.

Playing MP3/WMA

6 To select a folder, touch  to show the folder one level higher and touch a folder name on the list.

- You can also select the next or previous folder by pressing  or  button (FOLDER) on the remote control.
- To return to folder **001** (ROOT), press and hold **BAND**. However, if folder **001** (ROOT) contains no files, playback commences with folder **002**.
- You cannot select a folder that does not have an MP3/WMA file recorded in it.







Notes

- When playing discs with MP3/WMA files and audio data (CD-DA) such as CD-EXTRA and MIXED-MODE CDs, both types can be played only by switching mode between MP3/WMA and CD-DA by touching **MEDIA** or pressing **BAND**. This function can be operated only when the disc is playing.
- If you have switched between playback of MP3/WMA files and audio data (CD-DA), playback starts at the first track on the disc.
- This DVD player can play back an MP3/WMA file recorded on CD-ROM. (Refer to page 122 for files that can be played back.)
- There is sometimes a delay between starting up disc playback and the sound being issued. When being read, **FORMAT READ** is displayed.
- Playback is carried out in order of file number. Folders are skipped if they contain no files. (If folder **001** (ROOT) contains no files, playback commences with folder **002**.)
- This unit does not play back WMA files recorded as VBR (variable bit rate).
- When playing back files recorded as VBR (variable bit rate) files, the play time will not be correctly displayed if fast forward or reverse operations are used.
- If the inserted disc contains no files that can be played back, **NON-PLAYABLE DISC** is displayed.

- When playing an MP3/WMA disc containing more than 192 tracks, **READY** appears on the information bar for the track titles of 193rd and later.
- If the inserted disc contains WMA files that are protected by digital rights management (DRM), **TRACK SKIPPED** is displayed while the protected file is skipped.
- If all the files on the inserted disc are secured by DRM, **PROTECT** is displayed.
- Once **PROTECT** is displayed for playing discs secured by DRM, switching from audio data (CD-DA) to WMA files may become a trigger to lock the list touch panel keys. In such case, touch **LIST** to turn the list display off and then touch **LIST** again to turn it on. The list touch panel keys should be reactivated.
- When a disc contains both WMA files which are protected by DRM and audio data (CD-DA), both types cannot be switched. In this case, only audio data will be played back.
- There is no sound on fast forward or reverse.
- If you do not use the touch panel keys within 30 seconds, they will be hidden automatically. 

Stopping playback

- **Touch .**
 - When you stop MP3/WMA playback by touching , that location on the disc is memorized, enabling playback from that point when you play the disc again.
 - To play back the disc again, touch  .

Pausing MP3/WMA playback

Pause lets you temporarily stop disc playback.

Playing MP3/WMA

● Touch ►/|| during playback.

PAUSE appears in the display. Play of the current track pauses.

- To resume playback at the same point that you turned pause on, touch ►/|| again. 

Displaying information on MP3/WMA file

Information recorded on an MP3/WMA disc can be displayed.

1 Touch FILE INFO to display information on the MP3/WMA file you are currently playing.

- **ALBUM** (album title)
- **TRACK** (track title)
- **FOLDER** (folder name)
- **FILE** (file name)
- **ARTIST** (artist name)
- **GENRE** (genre)
- **YEAR** (year)
- When playing back WMA files, lists of album title, genre and year appear in blank.
- If specific information has not been recorded on an MP3/WMA file, the list appears in blank.
- Depending on the version of ID3 tag or Windows Media Player, the information may not be displayed correctly.

2 To return to the normal display, touch ESC.

Displaying text information on MP3/WMA disc

Text information recorded on an MP3/WMA disc can be displayed on the information bar.

● Touch DISP.

Touch **DISP** repeatedly to switch between the following settings:

Folder Name (folder name)—**File Name** (file name)—**Track Title** (track title)—**Artist Name** (artist name)—**Album Title** (album title)—**Comment** (comment)—**BitRate** (bit rate)

- When playing back WMA files, album title and comment are not displayed.
- When a list of folders/files is displayed by the touch of **LIST**, **Current** (currently playing folder) is displayed instead of **Folder Name**.
- When playing back MP3 files recorded as VBR (variable bit rate) files, the bit rate value is not displayed even after switching to bit rate. (**VBR** will be displayed.)
- If specific information has not been recorded on an MP3/WMA disc, **NO XXXX** will be displayed (e.g., **NO ARTIST NAME**).

Scrolling text information in the display

This unit can display the first 20 letters only of **Folder Name**, **File Name**, **Track Title**, **Artist Name**, **Album Title** and **Comment** on the information bar. When the recorded information is longer than 20 letters, you can scroll the text to the left so that the rest of the text information can be seen.

● Keep touching DISP until the text information begins to scroll to the left.

The rest of the text information will appear in the display. 

Introduction of advanced built-in DVD player (MP3/WMA) operation

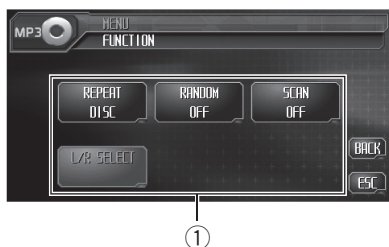

① Function display

Shows the function names.

1 Touch AUDIO MENU to display MENU. MENU appears on the display.

- You can also display **MENU** by clicking the joystick on the remote control.

2 Touch FUNCTION to display the function names.

The function names are displayed and operable ones are highlighted.

- To return to the previous display, touch **BACK**.
- To return to the playback display, touch **ESC**.



Note

If you do not operate the function within about 30 seconds, the display is automatically returned to the playback display.

Repeating play

For MP3/WMA playback, there are three repeat play ranges: **FOLDER** (folder repeat), **TRACK** (one-track repeat) and **DISC** (repeat all tracks).

● Touch REPEAT on the function menu to select the repeat range.

- **DISC** – Repeat all tracks
- **TRACK** – Repeat just the current track
- **FOLDER** – Repeat the current folder



Notes

- If you select another folder during repeat play, the repeat play range changes to **DISC**.
- If you perform track search or fast forward/reverse during **TRACK**, the repeat play range changes to **FOLDER**.
- When **FOLDER** is selected, it is not possible to play back a subfolder of that folder.
- When playing discs with MP3/WMA files and audio data (CD-DA), repeat play performs within the currently playing data type even if **DISC** is selected.

Playing tracks in random order

Random play lets you play back tracks in a random order within the repeat range, **FOLDER** and **DISC**.

1 Select the repeat range.

Refer to *Repeating play* on this page.

2 Touch RANDOM on the function menu to turn random play on.

Tracks will play in a random order within the previously selected **FOLDER** or **DISC** ranges.

- To turn random play off, touch **RANDOM** again.

Scanning folders and tracks

While you are using **FOLDER**, the beginning of each track in the selected folder plays for about 10 seconds. When you are using **DISC**, the beginning of the first track of each folder is played for about 10 seconds.

1 Select the repeat range.

Refer to *Repeating play* on the previous page.

2 Touch **SCAN** on the function menu to turn scan play on.

The first 10 seconds of each track of the current folder (or the first track of each folder) is played.

3 When you find the desired track (or folder) touch **SCAN** again.



Note

After track or folder scanning is finished, normal playback of the tracks will begin again. 

Listening to a CD

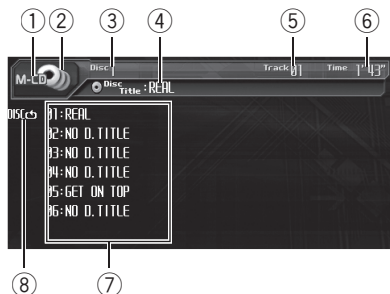

You can use this unit to control a multi-CD player, which is sold separately.

These are the basic steps necessary to play a CD with your multi-CD player. More advanced CD operation is explained starting on page 50.

- ① **Source name**
Shows the selected source name.
- ② **Source icon**
Shows which source has been selected.
- ③ **Disc number indicator**
Shows the disc number currently playing.
- ④ **Disc title indicator**
Shows the title of the currently playing disc.
- ⑤ **Track number indicator**
Shows the track number currently playing.
- ⑥ **Play time indicator**
Shows the elapsed playing time of the current track.
- ⑦ **Disc list display**
Shows the disc title list.
- ⑧ **Repeat indicator**
Shows the selected repeat range.

1 Touch the source icon and then touch M-CD to select the multi-CD player.

- When the source icon is not displayed, you can display it by touching the screen.

2 Touch the screen to display the touch panel keys.

3 Touch LIST to display disc titles and touch a desired disc that you want to play back.

Operable disc titles are highlighted. If you want to select a disc located at 7 to 12, touch or to display 07–12.

- If the connected multi-CD player is not compatible with the disc title list function, **LIST** is not displayed.

4 To skip back or forward to another track, touch or .

Touching skips to the start of the next track. Touching once skips to the start of the current track. Touching it again will skip to the previous track.

- You can also skip back or forward to another track by pressing or button on the unit or moving the joystick on the remote control left or right.

5 To perform fast forward or reverse, keep touching or .

- You can also perform fast reverse/fast forward by pressing and holding or button on the unit or holding the joystick on the remote control left or right.



Notes

- When the multi-CD player performs the preparatory operations, **READY** is displayed.
- If an error message such as **ERROR-02** is displayed, refer to the multi-CD player owner's manual.
- If there are no discs in the multi-CD player magazine, **NO DISC** is displayed.

Multi-CD Player

- If you do not use the touch panel keys within 30 seconds, they will be hidden automatically. 

Pausing CD playback

Pause lets you temporarily stop disc playback.

- **Touch ►/|| during playback.**
PAUSE appears in the display. Play of the current track pauses.
 - To resume playback at the same point that you turned pause on, touch ►/|| again. 

Using CD TEXT functions

You can use these functions only with a CD TEXT compatible multi-CD player.

Some discs have certain information encoded on the disc during manufacture. These discs may contain such information as the CD title, track title, artist's name and playback time and are called CD TEXT discs. Only these specially encoded CD TEXT discs support the functions listed below.

Displaying text information on CD TEXT discs

Text information recorded on a CD TEXT disc can be displayed on the information bar.

- **Touch DISP.**
Touch **DISP** repeatedly to switch between the following settings:
Disc Title (disc title)—**Disc Artist** (disc artist name)—**Track Title** (track title)—**Track Artist** (track artist name)
 - If specific information has not been recorded on a CD TEXT disc, **NO XXXX** will be displayed (e.g., **NO T.ARTIST NAME**).



Scrolling text information in the display

This unit can display the first 20 letters only of **Disc Title**, **Disc Artist**, **Track Title** and **Track Artist** on the information bar. When the recorded information is longer than 20 letters, you can scroll the text to the left so that the rest of the title can be seen.

- **Keep touching DISP until the title begins to scroll to the left.**
The rest of the title will appear in the display.

Selecting tracks from the track title list

Track title list lets you see the list of track titles on a CD TEXT disc and select one of them to play back.

- 1 **Touch AUDIO MENU and FUNCTION and then touch TRACK LIST.**
- 2 **Touch  or  to switch between the lists of titles.**
- 3 **Touch your favorite track title.**
That selection will begin to play. 

50-disc multi-CD player

Only those functions described in this manual are supported by 50-disc multi-CD players. 

Introduction of advanced multi-CD player operation



① Function display

Shows the function names.

1 Touch AUDIO MENU to display MENU.

MENU appears on the display.

- You can also display **MENU** by clicking the joystick on the remote control.

2 Touch FUNCTION to display the function names.

The function names are displayed and operable ones are highlighted.

- To go to the next group of function names, touch **NEXT**.
- To return to the previous group of function names, touch **PREV**.
- To return to the previous display, touch **BACK**.
- To return to the playback display, touch **ESC**.



Note

If you do not operate the function within about 30 seconds, the display is automatically returned to the playback display.

Repeating play

There are three repeat play ranges for the multi-CD player: **M-CD** (multi-CD player re-

peat), **TRACK** (one-track repeat) and **DISC** (disc repeat).

● Touch REPEAT on the function menu to select the repeat range.

- **M-CD** – Repeat all discs in the multi-CD player
- **TRACK** – Repeat just the current track
- **DISC** – Repeat the current disc



Notes

- If you select other discs during repeat play, the repeat play range changes to **M-CD**.
- If you perform track search or fast forward/reverse during **TRACK**, the repeat play range changes to **DISC**.

Playing tracks in random order

Random play lets you play back tracks in random order within the repeat range, **M-CD** and **DISC**.

1 Select the repeat range.

Refer to *Repeating play* on this page.

2 Touch RANDOM on the function menu to turn random play on.

Tracks will play in a random order within the previously selected **M-CD** or **DISC** ranges.

- To turn random play off, touch **RANDOM** again.

Multi-CD Player

Scanning CDs and tracks

While you are using **DISC**, the beginning of each track on the selected disc plays for about 10 seconds. When you are using **M-CD**, the beginning of the first track of each disc is played for about 10 seconds.

1 Select the repeat range.

Refer to *Repeating play* on the previous page.

2 Touch **SCAN** on the function menu to turn scan play on.

The first 10 seconds of each track of the current disc (or the first track of each disc) is played.

3 When you find the desired track (or disc) touch **SCAN** again.



Note

After track or disc scanning is finished, normal playback of the tracks will begin again. 

Using ITS playlists

ITS (instant track selection) lets you make a playlist of favorite tracks from those in the multi-CD player magazine. After you have added your favorite tracks to the playlist you can turn on ITS play and play just those selections.

Creating a playlist with ITS programming

You can use ITS to enter and play back up to 99 tracks per disc from up to 100 discs. (With multi-CD players sold before the CDX-P1250 and CDX-P650, up to 24 tracks can be stored in the playlist.)

1 Play a CD that you want to program.

Touch **▲** or **▼** to select the CD.

2 Touch **ITS MEMORY** on the function menu.

3 Touch **◀** or **▶** to select the desired track.

4 Touch **MEMORY** to store the currently playing track in the playlist.

MEMORY is displayed and the currently playing selection is added to your playlist. The display then shows track number again.



Note

After data for 100 discs has been stored in memory, data for a new disc will overwrite the oldest one.

Playback from your ITS playlist

ITS play lets you listen to the tracks that you have entered into your ITS playlist. When you turn on ITS play, tracks from your ITS playlist in the multi-CD player will begin to play.

1 Select the repeat range.

Refer to *Repeating play* on the previous page.

2 Touch **ITS PLAY** on the function menu to turn ITS play on.

Playback begins of those tracks from your playlist within the previously selected **M-CD** or **DISC** ranges.

- If no tracks in the current range are programmed for ITS play, then **ITS EMPTY** is displayed.
- To turn ITS play off, touch **ITS PLAY** again.

Erasing a track from your ITS playlist

You can delete a track from your ITS playlist if ITS play is on.

If ITS play is already on, skip to step 2.

1 Play the CD with the track you want to delete from your ITS playlist, and turn ITS play on.

Refer to *Playback from your ITS playlist* on the previous page.

2 Touch ITS MEMORY on the function menu.

3 Touch ◀ or ▶ to select the desired track.

4 Touch CLEAR to erase the track from your ITS playlist.

The currently playing selection is erased from your ITS playlist and playback of the next track from your ITS playlist begins.

- If there are no tracks from your playlist in the current range, **ITS EMPTY** is displayed and normal play resumes.

Erasing a CD from your ITS playlist

You can delete all tracks of a CD from your ITS playlist if ITS play is off.

1 Play the CD that you want to delete.

Touch ▲ or ▼ to select the CD.

2 Touch ITS MEMORY on the function menu.

3 Touch CLEAR to erase all tracks on the currently playing CD from your ITS playlist.

ITS CLEAR is displayed and all tracks on the currently playing CD are erased from your playlist.

Using compression and bass emphasis

You can use these functions only with a multi-CD player that supports them.

Using COMP (compression) and DBE (dynamic bass emphasis) functions lets you adjust the sound playback quality of the multi-CD player. Each of the functions has a two-step adjustment. The COMP function balances the output of louder and softer sounds at higher volumes. DBE boosts bass levels to give playback a fuller sound. Listen to each of the effects as you select them and use the one that best enhances the playback of the track or CD that you are listening to.

● Touch COMPRESSION on the function menu to select your favorite setting.

Touch **COMPRESSION** repeatedly to switch between the following settings:

**COMP OFF—COMP 1—COMP 2—
COMP OFF—DBE 1—DBE 2**

- If the multi-CD player does not support COMP/DBE, **COMPRESSION** cannot be selected.

XM tuner (GEX-P920XM)

Listening to XM Satellite Radio

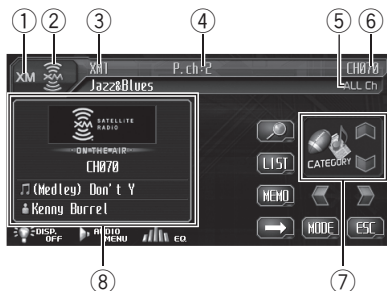

You can use this unit to control an XM satellite digital tuner (GEX-P920XM), which is sold separately.

For details concerning operation, refer to the XM tuner's operation manuals. This section provides information on XM operations with this unit which differs from that described in the XM tuner's operation manual.

- This unit does not have the text scroll function.
- ① **Source name**
Shows the selected source name.
 - ② **Source icon**
Shows what the source has been selected.
 - ③ **XM band indicator**
Shows the XM band which has been selected.
 - ④ **XM preset number indicator**
Shows what XM preset has been selected.
 - ⑤ **XM channel select setting indicator**
Shows what channel select setting has been selected. **ALL CH** is displayed when **ALL CH** is selected for the channel select mode, and **CATEGORY** is displayed when

CATEGORY is selected for the channel select mode.

- Refer to *Switching the XM channel select mode* on the next page.
- ⑥ **XM channel number indicator**
Shows to which XM channel number the tuner is tuned.
 - ⑦ **Category select keys/preset select keys**
Shows the category select keys when the channel select setting is **CATEGORY** or the preset select keys when the channel select setting is **ALL CH**.
 - ⑧ **Detail information or preset list display**
Shows the detail information of the broadcast channel currently being received or the preset list.

1 Touch the source icon and then touch XM to select the XM.

2 Touch the screen to display the touch panel keys.

3 Touch BAND to select a XM band.

Touch **BAND** repeatedly until the desired XM band is displayed, **XM1**, **XM2** or **XM3**.

4 Touch ◀ or ▶ to select a desired channel.

The channels move up or down step by step. Channels that cannot currently be selected are skipped, and the next channel is selected.

- If you touch and hold ◀ or ▶, you can increase or decrease the channel number continuously.
- You can also select a channel by pressing ◀ or ▶ button.
- You can also perform tuning from a desired channel category. (Refer to *Selecting a channel in the channel category* on the next page.)

 Notes

- If you do not use the touch panel keys for 30 seconds, they will be hidden automatically.
- You can go to the next group of touch panel keys by touching →. 

Switching the XM channel select mode

You have two methods for selecting a channel: **ALL CH** mode and **CATEGORY** mode.

When selecting **ALL CH** mode, channels in any category can be selected. Select **CATEGORY** mode to narrow your search down to only channels in a particular category.

- **Touch MODE to select the desired channel select mode.**

Touch **MODE** repeatedly to switch between the two modes.

ALL CH (all channel select mode)—
CATEGORY (channel category select setting)

Switching between the detail information display and preset list display

You can switch the left side of the basic screen according to your preference.

- **Touch LIST.**

Touch **LIST** repeatedly to switch between the followings:
Detail information display—Preset list display
—OFF 

Storing and recalling broadcast stations

If you touch any of the preset tuning keys **P1—P6** you can easily store up to six broadcast stations for later recall with the touch of a key.

1 Select the channel that you want to store in memory.

2 Touch LIST to display the preset list.

- When the touch panel keys are not displayed, you can display them by touching the screen.

3 Touch and hold a preset tuning key P1—P6 until the XM preset number stops flashing.

The number you have touched will flash in the XM preset number indicator and then remain lit. The selected station has been stored in memory.

The next time you touch the same preset tuning key **P1—P6** the station is recalled from memory.

 Notes

- Up to 18 stations, six for each of three XM bands can be stored in memory.
- You can also use ▲ and ▼ to recall stations assigned to preset tuning keys **P1—P6** when the **ALL CH** mode is selected. 

Selecting a channel

Selecting a channel in the channel category

1 Touch MODE to select the channel category select mode.

CATEGORY appears on the information bar.

XM tuner (GEX-P920XM)

2 Touch ▲ or ▼ to select the desired channel category.

3 Touch ◀ or ▶ to select the desired channel in the selected channel category.

Selecting a channel from the XM channel list display

The list content can be switched so you can search for the track you want to listen to not only by the channel name but also by the artist name or song title.

- The channel list shows all the channels during the **ALL CH** mode, and the channels included in the selected category during the **CATEGORY** mode. To switch the channel mode, touch **MODE**.

1 Touch 🔍.

XM channel list appears in the display.

Each touch of 🔍 changes the following settings as follows:

Ch Name List (channel name)—

Song Title List (song title)—**Artist Name List** (artist name)

2 Touch the desired channel that you want to listen to.

- When the **CATEGORY** mode is selected, touch ▲ or ▼ to switch to another category.

Selecting a channel directly

You can select an XM channel directly by entering the desired channel number.

1 Touch DIRECT.

CHANNEL INPUT appears in the display.

2 Touch 0—9 to input the desired channel number.

- To cancel the input numbers, touch **C**.

3 While the input number is displayed, touch ENTER.

The entered XM channel is selected.

4 To return to the normal display, touch ESC. [■]

Using the MyMix function

The MyMix function allows you to make the MyMix song playlist. When the song in the MyMix playlist is being broadcast on a station other than the one you are listening to, you will be alerted, and you can tune to the station to listen to that song.

- A track itself is NOT downloaded BUT only the song title and the artist name are memorized.

Making the MyMix playlist

You can add a song that is being broadcast to the MyMix playlist. When it is added, the song title and its artist name is memorized to this unit. The MyMix function will start on the song that matches the song title and its artist name in the MyMix playlist.

1 When a desired song is broadcast, touch and hold MEMO.

The song title and artist name of the song you are listening to are memorized, and a confirmation message appears.

- The song title and artist name of up to **10** tracks can be memorized. When you try to save more than **10** tracks, **FULL** is displayed and that song being broadcast cannot be saved.
- You cannot memorize the song title or the artist name when “-----” is displayed on the title information.
- You cannot memorize the song title or the artist name of the channel 000.

- It is possible that the memorized title is not displayed correctly.

2 Touch OK to confirm.

- To delete the song from the MyMix playlist, refer to *Deleting the song from the MyMix playlist* on this page.

When the song in the MyMix playlist is broadcast

As soon as the song in the MyMix playlist starts broadcast on a different station, a message is displayed. Touch **YES** to switch to that station, and you can listen to that song.

- If you would rather not to tune to that station, touch **NO**.
- If an alert for the song in the MyMix playlist is set up to off, no alert will be provided even when the song is broadcast. Refer to *Setting up a song alert* on page 62.
- If there is slight difference between the memorized title and the title of the song being broadcast, no alert will be provided even though they are the same song.

Setting up a song alert

You can set up an alert on or off by each song in the MyMix playlist. First, display the MyMix playlist and then change each alert setting. Set up an alert to on so you can receive the alert when the song is broadcast, or set it up to off to stop the alert for that song.

1 Touch MEMO EDIT.

The MyMix playlist is displayed.

2 Touch the song title that you want to set up the alert to off.

The check mark is removed, and the alert for that song is off.

Deleting the song from the MyMix playlist

You can delete each song in the MyMix playlist.

1 Touch MEMO EDIT.

The MyMix playlist is displayed.

2 Touch and hold the song title you want to delete.

That song will be deleted from the MyMix playlist.

- To delete all the songs in the MyMix playlist, touch **DELETE ALL**.

3 A message will appear asking you to confirm to delete it. Touch YES.

Displaying the Radio ID

Channel number select setting

If you select **CH : 000**, the ID code is displayed.

- Touch ◀ or ▶ to select **CH : 000**.

Channel category select setting

You can also display the Radio ID to select **RADIO ID** from channel category in the **CATEGORY** mode.

● Touch ▲ or ▼ to select RADIO ID from channel category.

- If you select another channel, display of the ID code is canceled.
- Display of the ID code repeats displaying **RADIO ID** and the ID code one after the other.

XM tuner (GEX-P910XM)

Listening to XM Satellite Radio

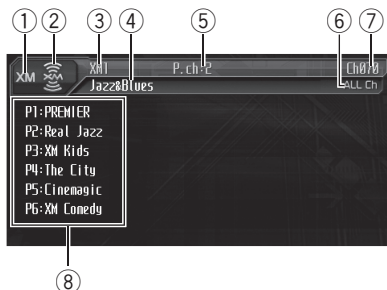

You can use this unit to control a XM satellite digital tuner (GEX-P910XM), which is sold separately.

For details concerning operation, refer to the XM tuner's operation manuals. This section provides information on XM operations with this unit which differs from that described in the XM tuner's operation manual.

- This unit does not have the text scroll function.
- With this unit, you can operate one additional function: XM channel direct selection.

- 1 Source name**
Shows the selected source name.
- 2 Source icon**
Shows what the source has been selected.
- 3 XM band indicator**
Shows the XM band which has been selected.
- 4 XM channel category**
Shows the category of broadcast channel.
- 5 XM preset number indicator**
Shows what XM preset has been selected.

- 6 XM channel select setting indicator**

Shows what channel select setting has been selected. **ALL CH** is displayed when **ALL CH** is selected for the channel select mode, and **CATEGORY** is displayed when **CATEGORY** is selected for the channel select mode.

- Refer to *Switching the XM channel select mode* on page 54.

- 7 XM channel number indicator**

Shows to which XM channel number the tuner is tuned.

- 8 Preset list display**

Shows the preset list.

- 1 Touch the source icon and then touch XM to select the XM.**

- 2 Touch the screen to display the touch panel keys.**

- 3 Touch BAND to select a XM band.**

Touch **BAND** repeatedly until the desired XM band is displayed, **XM1**, **XM2** or **XM3**.

- 4 Touch ◀ or ▶ to select a desired channel.**

The channels move up or down step by step. Channels that cannot currently be selected are skipped, and the next channel is selected.

- If you touch and hold ◀ or ▶, you can increase or decrease the channel number continuously.
- You can also select a channel by pressing ◀ or ▶ button.
- You can also perform tuning from a desired channel category. (Refer to *Selecting a channel in the channel category* on the next page.)



Notes

- If you do not use the touch panel keys for 30 seconds, they will be hidden automatically.
- You can go to the next group of touch panel keys by touching →. □

Switching the XM display

- **Touch DISP to switch the XM display.**

Each time you touch **DISP** changes the XM display in the following order:
Channel name—Artist name/feature—Song/
program title—Additional information—Chan-
nel number 

Storing and recalling broadcast stations

If you touch any of the preset tuning keys **P1—P6** you can easily store up to six broadcast stations for later recall with the touch of a key.



- **When you find a station that you want to store in memory touch and hold a preset tuning key P1—P6 until the XM preset number stops flashing.**

The number you have touched will flash in the XM preset number indicator and then remain lit. The selected station has been stored in memory.

The next time you touch the same preset tuning key **P1—P6** the station is recalled from memory.

- When the touch panel keys are not displayed, you can display them by touching the screen.
- When **P1—P6** are not displayed, you can display them by touching .

Notes

- Up to 18 stations, six for each of three XM bands can be stored in memory.
- You can also use  and  to recall stations assigned to preset tuning keys **P1—P6**. 

Switching the XM channel select mode

You have two methods for selecting a channel: by number and by category. When selecting by number, channels in any category can be selected. Select by category to narrow your search down to only channels in a particular category.

- **Touch MODE to select the desired channel select mode.**

Touch **MODE** repeatedly to switch between the following channel select modes:

CH NUMBER (channel number select setting)
—**CATEGORY** (channel category select setting)

Selecting a channel in the channel category

- 1 **Touch MODE to select the channel category select mode.**

CATEGORY appears on the information bar.

- 2 **Touch  or  to select the desired channel category.**

- 3 **Touch  or  to select the desired channel in the selected channel category.** 

Selecting a channel directly

Refer to *Selecting a channel directly* on page 55. 

Displaying the Radio ID

Refer to *Displaying the Radio ID* on page 56. 

SIRIUS Satellite Radio tuner

Listening to SIRIUS Satellite Radio

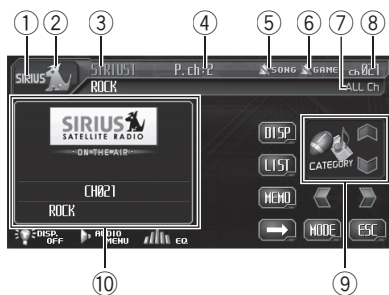

This unit can control a SIRIUS Satellite Radio tuner (sold separately).

- ① **Source name**
Shows the selected source name.
 - ② **Source icon**
Shows what the source has been selected.
 - ③ **SIRIUS band indicator**
Shows the SIRIUS band which has been selected.
 - ④ **SIRIUS preset number indicator**
Shows what SIRIUS preset has been selected.
 - ⑤ **My mix song alert off indicator**
Shows when the MyMix function is off. Refer to *Turning the MyMix function on or off* on page 62.
 - ⑥ **Game Alert off indicator**
Shows when the Game Alert is off. Refer to *Switching the Game Alert on or off* on page 63.
 - ⑦ **SIRIUS channel select setting indicator**
Shows what channel select setting has been selected. **ALL CH** is displayed when **ALL CH** is selected for the channel select mode, and **CATEGORY** is displayed when **CATEGORY** is selected for the channel select mode.
 - Refer to *Switching the XM channel select mode* on page 54.
 - ⑧ **SIRIUS channel number indicator**
Shows to which SIRIUS channel number the tuner is tuned.
 - ⑨ **Category select keys/preset select keys**
Shows the category select keys when the channel select setting is **CATEGORY** or the preset select keys when the channel select setting is **ALL CH**.
 - ⑩ **Detail information or preset list display**
Shows the detail information of the broadcast channel currently being received or the preset list.
- 1 Touch the source icon and then touch SIRIUS to select SIRIUS.**
 - 2 Touch the screen to display the touch panel keys.**
 - 3 Touch BAND to select a band.**
Touch **BAND** repeatedly until the desired SIRIUS band is displayed, **SIRIUS1**, **SIRIUS2** or **SIRIUS3**.
 - 4 Touch ◀ or ▶ to select a desired channel.**
The channels move up or down step by step. Channels that cannot currently be selected are skipped, and the next channel is selected.
 - If you touch and hold ◀ or ▶, you can increase or decrease the channel number continuously.

SIRIUS Satellite Radio tuner

- You can also select a channel by pressing ◀ or ▶ button.
- You can also perform tuning from a desired channel category. (Refer to *Selecting the channel in the channel category* on this page.)



Notes

- If you do not use the touch panel keys for 30 seconds, they will be hidden automatically.
- It may take a few seconds before you can hear anything while this unit acquires and processes the satellite signal.
- When you change the channel, the channel name is displayed, followed by the category name.

Selecting the SIRIUS channel select mode

You have two methods for selecting a channel: **ALL CH** mode and **CATEGORY** mode.

When selecting **ALL CH** mode, channels in any category can be selected. Select **CATEGORY** mode to narrow your search down to only channels in a particular category.

- **Touch MODE to select the desired channel select mode.**

Touch **MODE** repeatedly to switch between the two modes.

ALL CH (all channel select mode)—

CATEGORY (channel category select mode)

Selecting a channel

Selecting the channel in the channel category

Channels are organized into various program categories, e.g. Rock, Classic, Jazz. You can

specify channels by selecting the desired category.

- 1 Touch MODE to select the channel category select mode.**

The category select keys appear.

- 2 Touch ▲ or ▼ to select the desired channel category.**

- 3 Touch ◀ or ▶ to select the desired channel in the selected channel category.**

Selecting a SIRIUS channel directly

You can select a SIRIUS channel directly by entering the desired channel number.

- 1 Touch DIRECT.**

CHANNEL INPUT appears in the display.

- 2 Touch 0—9 to input the desired channel number.**

- To cancel the input numbers, touch **C**.

- 3 While the input number is displayed, touch ENTER.**

The entered SIRIUS channel is selected.

- To return to the normal display, touch **ESC**.

Switching the display

Various information, including channel number, name and category, song/program title, artist/feature and composer, can be displayed for the selected channel.

- **Touch DISP to switch information on the selected channel.**

Touch **DISP** repeatedly switch between the followings:

SIRIUS Satellite Radio tuner

Channel number—Channel name—Channel Category—Artist name/feature—Song/program title—Composer 

Switching between the detail information display and preset list display

Only when SIR-PNR2/SIR-PNR2C is connected to this unit, you can operate this function.

You can switch the left side of the basic screen according to your preference.

● Touch LIST.

Touch **LIST** repeatedly to switch between the followings:

Detail information display—Preset list display—OFF 

Storing and recalling broadcast stations

If you touch any of the preset tuning keys **P1—P6** you can easily store up to six broadcast stations for later recall with the touch of a key.

- Channels are stored and recalled on a broadcast station basis. This means that if the broadcast station you stored has been assigned to a different channel by SIRIUS, you can still recall the same broadcast station (though a different channel number may appear in the display).

1 Select the channel that you want to store in memory.

2 Touch LIST to display the preset list.

- When the touch panel keys are not displayed, you can display them by touching the screen.

3 Touch and hold a preset tuning key P1—P6 until the SIRIUS preset number stops flashing.

The number you have touched will flash in the SIRIUS preset number indicator and then remain lit. The selected station has been stored in memory.

The next time you touch the same preset tuning key **P1—P6** the station is recalled from memory.



Note

Up to 18 stations, six for each of three SIRIUS bands can be stored in memory. 

Using the MyMix function

Only when SIR-PNR2/SIR-PNR2C is connected to this unit, you can operate this function.

The MyMix function allows you to make the MyMix song playlist. When the song in the MyMix playlist is being broadcast on a station other than the one you are listening to, you will be alerted, and you can tune to the station to listen to that song.

- A track itself is NOT downloaded BUT only the song title and the artist name are memorized.

Making the MyMix playlist

You can add a song that is being broadcast to the MyMix playlist. When it is added, the song title and its artist name is memorized to this unit. The MyMix function will start on the song that matches the song title and its artist name in the MyMix playlist.

SIRIUS Satellite Radio tuner

● When a desired song is broadcast, touch and hold **MEMO**.

The song title and artist name of the song you are listening to are memorized, and a confirmation message appears.

- The song title and artist name of up to **10** tracks can be memorized. Trying to save more than **10** tracks will overwrite old ones.
- You cannot memorize the song title or the artist name of the channel 000.
- It is possible that the memorized title is not displayed correctly.

When the song in the MyMix playlist is broadcast

As soon as the memorized song starts broadcast on a different station, a song alert is displayed. Touch **JUMP** to switch to that station, and you can listen to that track.

- If you would rather not to tune to that station, touch **STAY**.
- If an alert for the song in the MyMix playlist is set up to off, no alert will be provided even when the song is broadcast. Refer to *Setting up a song alert* on this page.
- If there is slight difference between the memorized title and the title of the song being broadcast, no alert will be provided even though they are the same song.

Turning the MyMix function on or off

You can turn the MyMix function off and stop this unit to alert you for all the songs in the MyMix playlist. To restart, turn this function on.

- The MyMix function is on at the default setting.

1 Touch **MEMO EDIT**.

The display is switched to the memo edit mode.

2 Touch **ALERT OFF** to turn the MyMix function off.

The MyMix function is now off.

- To turn the MyMix function on, touch **ALERT ON**.

3 To return to the normal display, touch **ESC**.

Setting up a song alert

You can set up an alert on or off by each song in the MyMix playlist. First, display the MyMix playlist and then change each alert setting. Set up an alert to on so you can receive the alert when the song is broadcast, or set it up to off to stop the alert for that song.

1 Touch **MEMO EDIT**.

The display is switched to the memo edit mode.

2 Touch **◀** or **▶** to select the song title that you want to turn the alert off.

3 Touch ON/OFF to turn the alert off. **ON** is changed to **OFF** and the alert for the song is turned off.

Deleting the song from the MyMix playlist

You can delete each song in the MyMix playlist.

1 Touch **MEMO EDIT**.

The song title in the MyMix playlist is displayed.

SIRIUS Satellite Radio tuner

2 Touch ◀ or ▶ to select the song title that you want to delete.

3 Touch DELETE.

4 A message will appear asking you to confirm to delete it. Touch OK.

The selected song is deleted. 

Using the Game Alert function

Only when SIR-PNR2/SIR-PNR2C is connected to this unit, you can operate this function.

This unit can alert you when games involving your favorite teams are about to start. To use this function you need in advance to set up a game alert for the teams.

Selecting teams for Game Alert

1 Touch TEAM SET.

2 Touch ◀ or ▶ on League to select a desired league.

League names are switched in the display.

3 Touch ◀ or ▶ on Team to select a desired team.

Teams in the selected category are switched in the display.

4 Touch ON/OFF to store the selected team in memory.

ON is displayed with the selected team, and the Game Alert function will start on that team.

- To turn the Game Alert off of the selected team, touch **ON/OFF** again.
- If you want to clear all the team selections, touch **CLEAR ALL**.
- When you have already made 12 team selections, **FULL** is displayed and additional team se-

lection is not possible. In this case, first turn one of the team selections off and then try again.

5 Repeat these steps for selecting other teams.

Up to 12 teams can be selected.

6 To return to the normal display, touch ESC.

Switching the Game Alert on or off

Once you made team selections, you need to turn the Game Alert function on.

- The Game Alert function is on at the default setting.

1 Touch TEAM SET.

2 Touch ALERT ON to turn the Game Alert on.

The Game Alert function is now on.

- To turn the Game Alert function off, touch **ALERT OFF**.

3 To return to the normal display, touch ESC.

When the game of the selected team starts

When a game of the selected team is about to start (or is currently playing) on a different station, a game alert is displayed. Touch **JUMP** to switch to that station, and you can listen to that game.

- If you would rather not to tune to that station, touch **STAY**.

SIRIUS Satellite Radio tuner

Displaying game information

If games of your selected teams are currently playing, you can display information of the games and tune to the broadcast channel.

1 Touch **GAME INFO**.

The game information of your selected team is displayed.

2 Touch **◀** or **▶** to select a game.

The game is displayed, followed by more detailed game information.

- Game score will be updated automatically.

3 Touch **Tune To** to switch to that station to listen to the game.

- To return to the normal display, touch **ESC**.



Notes

- If you have not made any team selections, **NOT SET** is displayed.
- When games involving your favorite teams are not currently playing, **NO GAME** is displayed.



Displaying the Radio ID

If you select **CH000**, the ID code is displayed.

- Touch **◀** or **▶** to select **CH : 000**.



Note

To select **CH000**, set the channel select setting to **ALL CH**. About the channel select setting, refer to *Selecting the SIRIUS channel select mode* on page 60 

TV tuner

Watching the television



You can use this unit to control a TV tuner (e.g. GEX-P5700TV), which is sold separately.

For details concerning operation, refer to the TV tuner's operation manual. This section provides information on TV operations with this unit which differs from that described in the TV tuner's operation manual.

Important

Depending on the TV tuner connected to this unit, some functions may not be operable. For details, refer to the TV tuner's operation manual.

① Source name

Shows the selected source name.

② Source icon

Shows which source has been selected.

③ Band indicator

Shows which band the TV tuner is tuned to.

④ Preset number indicator

Shows which preset has been selected.

⑤ Channel indicator

Shows which channel the TV tuner is tuned.

⑥ Preset list display

Shows the preset list.

1 Touch the source icon and then touch TV to select the TV.

- When the source icon is not displayed, you can display it by touching the screen.

2 Touch the screen to display the touch panel keys.

3 Touch BAND to select a band.

Touch **BAND** repeatedly until the desired band is displayed, **TV1** or **TV2**.

4 To select a preset channel, touch LIST to display preset channels and touch a desired preset channel.

The preset channel you selected is tuned in.

5 To perform manual tuning, briefly touch ◀ or ▶.

The channels move up or down step by step.

- You can also perform manual tuning by pressing ◀ or ▶ button or moving the joystick on the remote control left or right.

6 To perform seek tuning, keep touching ◀ or ▶ for about one second and release.

The tuner will scan the channels until a broadcast strong enough for good reception is found.

- You can cancel seek tuning by briefly touching either ◀ or ▶.
- If you keep touching ◀ or ▶ you can skip broadcasting channels. Seek tuning starts as soon as you release the keys.
- You can also perform seek tuning by pressing and holding ◀ or ▶ button or holding the joystick on the remote control left or right.

Note

If you do not use the touch panel keys within 30 seconds, they will be hidden automatically. 

Storing and recalling broadcast stations

If you touch any of the preset tuning keys **P01—P12** you can easily store up to 12 broadcast stations for later recall with the touch of a key.

- **When you find a station that you want to store in memory, keep touching one of preset tuning keys P01—P12 until the preset number stops flashing.**

The number you have touched will flash in the preset number indicator and then remain lit. The selected station has been stored in memory.

The next time you touch the same preset tuning key the station is recalled from memory.

- To switch between **P01—P06** and **P07—P12**, touch **↕** or **↕**.
- When the touch panel keys are not displayed, you can display them by touching the screen.
- When **P01—P06** and **P07—P12** are not displayed, you can display them by touching **LIST**.



Notes

- Up to 24 stations, 12 for each of two TV bands, can be stored in memory.
- You can also use **▲** and **▼** to recall stations assigned to preset tuning keys **P01—P12**. 

Introduction of advanced TV tuner operation

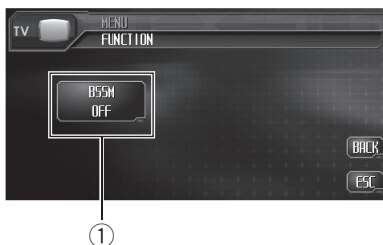

① Function display

Shows the function names.

1 Touch **AUDIO MENU** to display **MENU**. **MENU** appears on the display.

- You can also display **MENU** by clicking the joystick on the remote control.

2 Touch **FUNCTION** to display the function names.

The function names are displayed and operable ones are highlighted.

- To return to the previous display, touch **BACK**.
- To return to the TV picture, touch **ESC**.



Note

If you do not operate the function within about 30 seconds, the display is automatically returned to the TV picture. 

Storing the strongest broadcast stations sequentially

- Touch **BSSM** on the function menu to turn **BSSM** on.

BSSM begins to flash. While **BSSM** is flashing the 12 strongest broadcast stations will be stored in order from the lowest channel up. When finished, **BSSM** disappears.

- To cancel the storage process, touch **BSSM** again.



Note

Storing broadcast stations with **BSSM** may replace broadcast stations you have saved using **P01—P12**. □

Listening to songs on your iPod

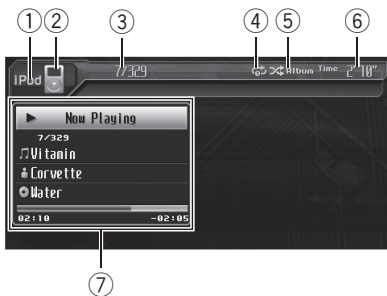

- ① **Source name**
Shows the selected source name.
- ② **Source icon**
Shows which source has been selected.
- ③ **Song number indicator**
Shows the number of song played in the selected list.
- ④ **Repeat indicator**
Shows when repeat range is selected to current track.
- ⑤ **Shuffle indicator**
Shows when random play is set to **Song** or **Album**.
- ⑥ **Play time indicator**
Shows the elapsed playing time of the current song.
- ⑦ **Song information**
Shows detailed information of currently playing song.

1 Touch the source icon and then touch iPod to select the iPod.

- When the iPod is not connected to this unit, you cannot select the iPod as a source.

2 Touch the screen to display the touch panel keys.

3 To skip back or forward to another song, touch ◀◀ or ▶▶.

Touching ▶▶ skips to the start of the next song. Touching ◀◀ once skips to the start of the current song. Touching it again will skip to the previous song.

- You can also skip back or forward to another song by pressing ◀ or ▶ button on the unit or moving the joystick on the remote control left or right.

4 To perform fast forward or reverse, keep touching ◀◀ or ▶▶.

- You can also perform fast reverse/fast forward by pressing and holding ◀ or ▶ button on the unit or holding the joystick on the remote control left or right.



Note

If the iPod contains no songs that can be played back, **NO SONGS** is displayed. 

Browsing for a song

The operation of this unit to control an iPod is designed to be as close to the operation of the iPod as possible for easy operation and song search.

1 Touch TOP to display the top menu.

2 Touch one of the categories in which you want to search for a song.



- **PLAYLISTS** (playlists)

Playing songs on iPod

- **ARTISTS** (artists)
- **ALBUMS** (albums)
- **SONGS** (songs)
- **GENRES** (genres)

3 Touch a list title that you want to play.

Repeat this operation until you find the desired song.

- You can start a playback of all the songs in the selected list (**GENRES**, **ARTISTS** or **ALBUMS**). To do this, touch **ALL**.
- To go to the next group of list titles, touch .
- To return to the previous group of list titles, touch .
- To return to the previous menu, touch .
- To go to the top menu of the list search, touch **TOP**.



Note

If the playback stops for any reason, touch **TOP** and refine your search for a song. .

Pausing a song

Pause lets you temporarily stop playback of a song.

- Touch **▶/||** during playback. **PAUSE** appears in the display.
- To resume playback at the same point that you turned pause on, touch **▶/||** again. .

Displaying text information on iPod

Text information recorded on the iPod can be displayed on the information bar.

- **Touch DISP.**

Touch **DISP** repeatedly to switch between the following settings:

Song Title (song title)—**Artist Name** (artist name)—**Album Title** (album title)

- If the characters recorded on the iPod are not compatible with a head unit, those characters will not be displayed.



Note

You can scroll the title to the left by keeping touching **DISP**. .



Displaying information on song

Song title, artist name, album title of the currently playing song can be displayed (if they have been entered in iPod) together with the index and the remaining playback time in the form of the status bar.

- **Touch FILE INFO to display information on the song you are currently playing.** Song information is displayed.
 - Status bar shows the remaining playback time. The bar is filled up from the left to the right as the playback time is consumed. .

Repeating play

You can repeat one song over and over.

- While this unit is set to repeat one song, you cannot select the other songs.
- **Touch  to repeat one song.**  appears on the information bar and the currently playing song repeats.



- When you do not set to repeat one song, this unit repeats all songs in the currently selected list (e.g. **ARTISTS, ALBUMS**). 

Playing songs in a random order (shuffle)

For playback of the songs on the iPod, there are two random play methods: **Song** (play back songs in a random order) and **Album** (play back albums in a random order).

- **Touch  to select the random play method.**

Touch  repeatedly until the desired random play method appears in the display.

- **Song** – Play back songs in a random order within the selected list
- **Album** – Select an album randomly, and then play back all the songs in it in order
- To cancel the random play, touch  repeatedly to turn the shuffle icon off. 

Bluetooth Audio

Listening to songs on BT Audio (Bluetooth audio player)



If you connect Bluetooth adapter (e.g. CD-BTB100) to this unit, you can control Bluetooth audio player via Bluetooth wireless technology. For details concerning operation, refer to the Bluetooth adapter's operation manual. This section provides brief information on Bluetooth audio player operations with this unit which slightly differs or is cut short from that described in the Bluetooth adapter's operation manual.

- Even though your audio player does not contain a Bluetooth module, you can still control it from this unit via Bluetooth wireless technology. To control your audio player by using this unit, connect a product featuring Bluetooth wireless technology (available on the market) to your audio player and connect Bluetooth adapter (e.g. CD-BTB100) to this unit.

Important

- Depending on the Bluetooth audio player connected to this unit, the available operations with this unit are limited to the following two levels:
 - Lower level: Only playing back songs on your audio player is possible.
 - Higher level: Playing back, pausing, selecting songs, etc., are possible (all the operations illustrated in this manual).

- Since there are a number of Bluetooth audio players available on the market, operations with your Bluetooth audio player using this unit vary in great range. Please refer to the instruction manual that came with your Bluetooth audio player as well as this manual while operating your player on this unit.
- Information about songs (e.g. the elapsed playing time, song title, song index, etc.) cannot be displayed on this unit.
- While you are listening to songs on your Bluetooth audio player, please refrain from operating on your cellular phone as much as possible. If you try operating on your cellular phone, the signal from your cellular phone may cause a noise on the song playback.
- When you are talking on the cellular phone connected to this unit via Bluetooth wireless technology, the song playback from your Bluetooth audio player connected to this unit is muted.
- Even if while you are listening to song on your Bluetooth audio player you switch to another source, the playback of song continues to elapse.

① Source name

Shows the selected source name.

② Source icon

Shows which source has been selected.

③ Device name

Shows the device name of the connected Bluetooth audio player (or Bluetooth adapter).

④ Connection indicator

Shows the Bluetooth wireless connection status.

- **Touch the source icon and then touch BT Audio to select the Bluetooth audio source.** 



Connecting a Bluetooth audio player

① Function display

Shows the function names.

1 Touch **AUDIO MENU** to display **MENU**. **MENU** appears on the display.

- You can also display **MENU** by clicking the joystick on the remote control.

2 Touch **FUNCTION** to display the function names.

The function names are displayed and operable ones are highlighted.

- To return to the previous display, touch **BACK**.
- To return to the playback display, touch **ESC**.

3 Touch **CONNECT OPEN** to turn the connection open on.

ON is displayed. This unit is now on standby for connection from Bluetooth audio player. If your Bluetooth audio player is set ready for Bluetooth wireless connection, the connection to this unit will be automatically established.

Note

Before you can use audio players you may need to enter the PIN code into this unit. If your player requires a PIN code to establish a connection, look for the code on the player or in its accompanying documentation. Enter the PIN code refer-

ring to *Entering PIN code for Bluetooth wireless connection* on page 109. 

Playing songs on Bluetooth audio player

1 Touch **▶**.

Playback starts.

2 To skip back or forward to another track, touch **◀◀** or **▶▶**.

Touching **▶▶** skips to the start of the next track. Touching **◀◀** once skips to the start of the current track. Touching it again will skip to the previous track.

- You can also skip back or forward to another track by pressing **◀** or **▶** button on the unit or moving the joystick on the remote control left or right.

3 To perform fast forward or reverse, keep touching **◀◀** or **▶▶**.

- You can also perform fast reverse/fast forward by pressing and holding **◀** or **▶** button on the unit or holding the joystick on the remote control left or right.

4 To pause the playback, touch **II**.

Playback is paused. 

Disconnecting a Bluetooth audio player

1 Touch AUDIO MENU to display MENU.

MENU appears on the display.

- You can also display **MENU** by clicking the joystick on the remote control.

2 Touch FUNCTION to display the function names.

The function names are displayed and operable ones are highlighted.

- To return to the previous display, touch **BACK**.
- To return to the playback display, touch **ESC**.

3 Touch DISCONNECT and then touch ON.

After the disconnection is completed,

No Connection is displayed. 

Displaying BD (Bluetooth Device) address

1 Touch AUDIO MENU to display MENU.

MENU appears on the display.

- You can also display **MENU** by clicking the joystick on the remote control.

2 Touch FUNCTION to display the function names.

The function names are displayed and operable ones are highlighted.

- To return to the previous display, touch **BACK**.
- To return to the playback display, touch **ESC**.

3 Touch DEVICE INFO to display the BD address.

Various information regarding the bluetooth wireless technology are displayed.

- **DEVICE NAME** (device name of this unit)
- **BD ADDRESS** (address of Bluetooth device)
- **SYSTEM VERSION** (system version)
- **BT MODULE VERSION** (version of Bluetooth module) 

Hands-free phoning with cellular phones featuring Bluetooth wireless technology

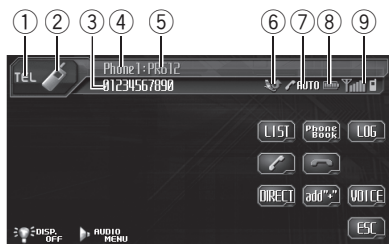

If you use Bluetooth adapter (e.g. CD-BTB100), you can connect a cellular phone featuring Bluetooth wireless technology to this unit for hands-free, wireless calls, even while driving. For details concerning operation, refer to the Bluetooth adapter's operation manual. This section provides brief information on the hands-free phoning operations with this unit which slightly differs or is cut short from that described in the Bluetooth adapter's operation manual.

Important

Since this unit is on standby to connect with your cellular phones via Bluetooth wireless technology, using this unit without running the engine can result in battery drainage.

① Source name

Shows the selected source name.

② Source icon

Shows which source has been selected.

③ Phone number

Shows the phone number you selected.

④ User number indicator

Shows the registration number of the cellular phone.

⑤ Device name

Shows the device name of the cellular phone.

⑥ Incoming call notice indication

Shows when an incoming call has been received and not checked yet.

- Incoming call notice is not displayed for calls made when your cellular phone is disconnected from this unit.

⑦ Automatic answering/Automatic reject indicator

Shows when the automatic answering function is on (for more details, refer to *Setting the automatic answering* on page 82).

Shows when the automatic rejecting function is on (for more details, refer to *Setting the automatic rejecting* on page 82).

⑧ Battery strength indicator

Shows the battery strength of cellular phone.

- Battery strength indicator may differ from the actual battery strength.
- If the battery strength is not available, nothing is displayed in the battery strength indicator area.

⑨ Signal level indicator

Shows the signal strength of cellular phone.

- Signal level indicator may differ from the actual signal level.
- Depending on the cellular phones featuring Bluetooth wireless technology, radio field intensity is not available. In this case, the signal level indicator does not appear.

● **Touch the source icon and then touch TEL to select the telephone.**

Bluetooth Telephone



Note

Equalizer curve for the phone source is fixed. When selecting the phone source, you cannot operate *Using the equalizer* on page 85. 

Setting up for hands-free phoning

Before you can use the hands-free phoning function you will need to set up the unit for use with your cellular phone. This entails establishing a Bluetooth wireless connection between this unit and your phone, registering your phone with this unit, and adjusting the volume level.

1 Connection

For detailed instructions on connecting your phone to this unit via Bluetooth wireless technology, refer to *Connecting a cellular phone* on the next page.

- Your phone should now be temporarily connected; however, to make best use of the technology, we recommend you register the phone to this unit.

2 Registration

Refer to *Registering connected cellular phone* on page 77 for instructions on how to register your temporarily connected phone.

3 Volume adjustment

Adjust the earpiece volume on your cellular phone for comfort. When adjusted, the volume level is memorized in this unit as the default setting.

- Caller's voice volume and ring volume may vary depending on the type of cellular phones.
- If the difference between the ring volume and caller's voice volume is big, overall volume level may become unstable.

- Before disconnecting cellular phone from this unit, make sure to adjust the volume to proper level. If the volume has been muted (zero level) on your cellular phone, the volume level of your cellular phone remains muted even after the cellular phone is disconnected from this unit. 

Basic operation of hands-free phoning



Important

Advanced operations that require your attention such as dialing numbers on the monitor, using phone book, etc., are prohibited while you are driving. When you need to use these advanced operations, stop your vehicle in a safe place and operate.

Making a phone call

Voice recognition

1 Touch VOICE to turn the voice recognition function on.

Voice dial icon appears on the information bar. Voice recognition function is now ready.

- To cancel the voice recognition function, touch **VOICE** again.

2 Pronounce the name of your contact.

Taking a phone call

Answering an incoming call

1 When a call comes in, touch .

Touching  switches between callers on hold.

2 To end the call, touch .

The estimated call time appears in the display (this may differ slightly from the actual call time).

Rejecting an incoming call

● When a call comes in, touch .



The call is rejected.

Answering a call waiting

1 Touch to answer a call waiting.

2 Touch to end the call.

The estimated call time appears in the display (this may differ slightly from the actual call time).

- Touching  ends the call you are talking on. Or with some cellular phones, touching  may end all calls including the calls on hold.

Rejecting a call waiting

● Touch to reject a call waiting. .

Introduction of advanced hands-free phoning operation



① Function display

Shows the function status.

1 Touch AUDIO MENU to display MENU. MENU appears on the display.

- You can also display MENU by clicking the joystick on the remote control.

2 Touch FUNCTION to display the function names.

The function names are displayed and operable ones are highlighted.

- To go to the next group of function names, touch **NEXT**.
- To return to the previous group of function names, touch **PREV**.
- To return to the previous display, touch **BACK**.
- To return to the playback display, touch **ESC**. .

Connecting a cellular phone

Searching for available cellular phones

1 Touch PHONE CONNECT on the function menu.

Bluetooth Telephone

2 Touch to search for available cellular phones.

While searching, **Search** flashes. When available cellular phones featuring Bluetooth wireless technology are found, device names or **Name Not Found** (if names cannot be obtained) are displayed.

- If this unit fails to find any available cellular phones, **Not Found** is displayed.

3 Touch the device name you want to connect.

While connecting, **Connect** flashes. To complete the connection, please check the device name (**Pioneer BT unit**) and enter the link code on your cellular phone. If the connection is established, **Connected** is displayed.

- The link code is set to **0000** as default. You can change this code in the initial setting. Refer to *Entering PIN code for Bluetooth wireless connection* on page 109.

Using a cellular phone to initiate a connection

1 Touch PHONE CONNECT on the function menu.

2 Touch CONNECT OPEN.

The unit is now on standby for connection from cellular phone.

3 Use cellular phone to connect to this unit.

- To cancel this function, touch **CONNECT OPEN** again.
- The link code is set to **0000** as default. You can change this code in the initial setting. Refer to *Entering PIN code for Bluetooth wireless connection* on page 109. 

Disconnecting a cellular phone

1 Touch PHONE CONNECT on the function menu.

2 Touch DISCONNECT to disconnect the currently connected cellular phone from this unit.

After the disconnection is completed, **No Connection** is displayed. 

Registering connected cellular phone

1 Touch PHONE REGISTER on the function menu.

Registration assignments appear on the display. From the top to the third assignment are for User phone 1, 2 and 3. The rest two assignments are for Guest phone 1 and 2.

2 Touch and hold one of the registration assignments to register the currently connected phone.

If the registration is succeeded, the device name of the connected phone is displayed in the selected assignment.

- If the assignment is empty, **No Data** is displayed. If the assignment is already taken, the device name appears. To replace an assignment with a new phone, first delete the current assignment. For more detailed instructions, see *Deleting a registered phone* on the next page.
- If the registration failed, device name of the connected phone is not displayed in the selected assignment. In this case, return to step 1 and try again. 

Deleting a registered phone

1 Touch **PHONE REGISTER** on the function menu.

2 Touch **DELETE** next to the device name you want to delete.

A confirmation display appears. Touch **YES** to delete the phone.

- To cancel, touch **NO**. 

Connecting to a registered cellular phone

Connecting to a registered phone manually

1 Touch **PHONE CONNECT** on the function menu.

2 Touch **DIRECT CONNECT**.

3 Touch the device name you want to connect.

While connecting, **Connect** is flashing. If the connection is established, **Connected** is displayed.

Connecting to a registered phone automatically

● Touch **AUTO CONNECT** on the function menu to turn the Automatic Connection function on.

If your cellular phone is set ready for Bluetooth wireless connection, the connection to this unit will be automatically established.

- To turn automatic connection off, touch **AUTO CONNECT** again. 

Using the Phone Book

Transferring entries to the Phone Book

The Phone Book can hold a total of 500 entries; 300 from User 1, 150 from User 2, and 50 from User 3.

1 Touch **PHONE BOOK TRANSFER** on the function menu.

2 Touch **START** to turn the Phone Book Transfer function on.

The Phone Book Transfer is now on standby.

3 Use cellular phone to perform phone book transfer.

Perform phone book transfer using the cellular phone. For detailed instruction on this, refer to the instruction manual that came with your cellular phone.

- The display indicates how many entries have been transferred and the total number to be transferred.
- To cancel the transferring process, touch **STOP**.

4 When you are done transferring Phone Book entries, touch **ESC**.



Note

When the phone book transfer is complete, the connection to your cellular phone is off. To use the Phone Book, connect to your cellular phone once again, referring to *Connecting to a registered cellular phone* on this page.

Bluetooth Telephone

Changing the Phone Book display order

- **Touch PHONE BOOK NAME VIEW on the function menu to turn Phone Book Name View function on.**

Display order for the Phone Book is changed.

- To change to the other display order, touch **PHONE BOOK NAME VIEW** again.

Calling a number in the Phone Book





Important

You are required to park your vehicle and set the parking brake in order to perform this operation.

- 1 On the normal display, touch PHONE BOOK to display the Phone Book.**
- 2 Touch ▲ or ▼ to select the first letter of the name you are looking for.**
Touching ▲ or ▼ changes alphabetical letters.

- 3 Touch ENTER to show entries starting with the letter you chose.**

The display shows the first six Phone Book entries starting with that letter (e.g. "Ben", "Brian" and "Burt" when "B" is selected).

- Touch  or  to display other phone book entries.
- To refine the search with a different letter, touch **CLEAR**.

- 4 Touch a Phone Book entry you want to call.**

The display is switched to the Phone Book edit display.

- 5 Touch phone number of the Phone Book entry you want to call.**

If several phone numbers are entered to an entry, touch one you want to call.

The display returns to the normal display and the Phone Book entry you selected is displayed on the information bar.

- If you do not want to call the selected phone number but remove it from the information bar, touch **PHONE BOOK** and then touch **ESC**.

- 6 Touch  to make a call.**

- For an international call, touch **add "+"** to add + to the phone number.

- 7 To end the call, touch .**

The estimated call time appears in the display (this may differ slightly from the actual call time).

Editing the name of a Phone Book entry



Important

You are required to park your vehicle and set the parking brake in order to perform this operation.

- 1 On the normal display, touch PHONE BOOK to display the Phone Book.**
- 2 Select a Phone Book entry you want to edit.**
See step two to three on *Calling a number in the Phone Book* on this page for how to do this.
- 3 Touch EDIT next to the Phone Book entry name.**
The display is changed to the Phone Book edit display.
- 4 Touch 123 or ABC to select the desired character type.**
Select **ABC** to input alphabet.
Select **123** to input numbers and symbols.

Bluetooth Telephone

- Each time you touch **ABC**, the alphabet type changes among upper case, lower case and symbol.

5 Touch ▲ or ▼ to select an alphabet letter or number/symbol.

6 Touch ► to move the cursor to the next character position and edit the name.

When the letter you want is displayed, touch ► to move the cursor to the next position and then select the next letter. Touch ◀ to move backwards in the display.

7 Touch OK to store the new name.

Editing phone numbers



Important

You are required to park your vehicle and set the parking brake in order to perform this operation.

1 On the normal display, touch PHONE BOOK to display the Phone Book.

2 Select a Phone Book entry you want to edit.

See step two to three on *Calling a number in the Phone Book* on the previous page for how to do this.

3 Touch EDIT next to the phone number you want to edit.

The display is changed to the Phone Book dial edit display.

4 Touch 0—9 to input numbers.

- Touch **CLEAR** to delete the number. Touch and hold **CLEAR** to delete all the input numbers.

5 Touch ◀ or ► to move the cursor and edit the number.

Repeat these steps until you have finished changing.

6 Touch OK to store the new number.

Clearing a Phone Book entry



Important

You are required to park your vehicle and set the parking brake in order to perform this operation.

1 On the normal display, touch PHONE BOOK to display the Phone Book.

2 Select a Phone Book entry you want to delete.

See step two to three on *Calling a number in the Phone Book* on the previous page for how to do this.

3 Touch DELETE to delete the Phone Book entry.

A confirmation display appears. Touch **YES** to delete the entry.

- To cancel, touch **NO**. 

Using the Call History



Important

You are required to park your vehicle and set the parking brake in order to perform this operation.

The 12 most recent calls made (dialed), received and missed, are stored in the Call History. You can browse the Call History and call numbers from it.

Bluetooth Telephone

1 On the normal display, touch **LOG** to display the Call History.

Touching **LOG** repeatedly switches between the following call histories: MISSED CALL LIST — DIALED CALL LIST — RECEIVED CALL LIST

- Touching **DISP** here switches between the phone number and the caller's name (if it is in the Phone Book).

2 Touch a phone number or name (if entered) you want to call.

The display returns to the normal display and the phone number you selected is displayed on the information bar.

3 Touch to make a call.

Using preset numbers

Important

You are required to park your vehicle and set the parking brake in order to perform this operation.

Assigning preset numbers

Numbers that you dial frequently can be assigned to presets for quick recall.

You can assign up to 6 frequently called phone numbers to number presets.

1 Select a desired phone number from the Phone Book or the Call History. Or directly enter a desired phone number.

To select a desired phone number from the Phone Book or the Call History, see the instructions explained in previous pages. To directly enter a desired phone number, see *Making a call by entering phone number* on the next page.

The display should now be the normal display and the selected phone number is displayed on the information bar.

2 On the normal display, touch **LIST** to display preset assignments.

Preset assignments appear in the display (if not displayed yet).

3 Keep touching one of preset assignments to store the phone number.

The phone number you selected is stored in presets.

- **No Data** is displayed for empty assignment. Even if the assignment is taken, you can replace it to the new one by keeping touching the assignment.

Recalling preset numbers

1 On the normal display, touch **LIST** to display preset assignments.

Preset assignments appear in the display (if not displayed yet).

2 Touch one of preset assignments.

The selected phone number should now be displayed on the information bar.

3 Touch to make a call.

4 To end the call, touch .

The estimated call time appears in the display (this may differ slightly from the actual call time). 

Making a call by entering phone number



Important

You are required to park your vehicle and set the parking brake in order to perform this operation.

1 On the normal display, touch DIRECT to display the direct dial display.

2 Touch 0—9 to input numbers.

- Touch **CLEAR** to delete the number. Touch and hold **CLEAR** to delete all the input numbers.
- Up to 24 digits can be entered.
- If you want to store the entered phone number to preset assignment, touch **SET** here. The display returns to the normal display and the phone number you entered is selected.

3 When you completed entering the number, touch  to make a call.

4 To end the call, touch .

The estimated call time appears in the display (this may differ slightly from the actual call time). 

Clearing memory

1 Touch CLEAR MEMORY on the function menu.

2 Touch CLEAR next to the item you want to delete from the memory.

Select from the following:

- **PHONE BOOK** (phone book)
- **DIALED CALLS** (dialed call history)
- **RECEIVED CALLS** (received call history)
- **MISSED CALLS** (missed call history)
- **PRESET DIALS** (preset phone numbers)

After selecting a desired item, a confirmation display appears. Touch **YES** to delete the memory.

- To cancel, touch **NO**.
- Touch **All CLEAR** to clear the memory of all items. 

Setting the automatic answering

● **Touch AUTO ANSWER on the function menu to turn the automatic answer on.**

ON appears in the display.

- To turn the automatic answer off, touch **AUTO ANSWER** again. 

Setting the automatic rejecting

● **Touch REFUSE ALL CALLS on the function menu to turn the automatic call rejection on.**

ON appears in the display.

- To turn the automatic call rejection off, touch **REFUSE ALL CALLS** again. 

Switching the ring tone

● **Touch RING TONE on the function menu to turn the ring tone on.**

ON appears in the display.

- To turn the ring tone off, touch **RING TONE** again. 

Echo canceling and noise reduction

- Touch **ECHO CANCEL** on the function menu to turn Echo Cancel function on.

ON appears in the display.

- To turn echo canceling off, touch **ECHO CANCEL** again. 

Displaying BD (Bluetooth Device) address

- Touch **Device info** on the function menu to display the **BD address**.

Various information regarding the bluetooth wireless technology are displayed.

- **DEVICE NAME** (device name of this unit)
- **BD ADDRESS** (address of Bluetooth device)
- **SYSTEM VERSION** (version of this unit's microprocessor)
- **BT MODULE VERSION** (version of Bluetooth module) 

Introduction of audio adjustments

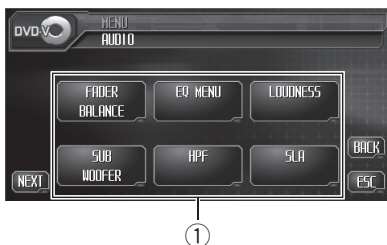

① Audio display

Shows the audio function names.



Important

If the multi-channel processor (DEQ-P8000) is connected to this unit, the audio function will be changed to the multi-channel processor's audio menu. For details, refer to *Introduction of DSP adjustments* on page 89.

1 Touch AUDIO MENU to display MENU. MENU appears on the display.

- You can also display **MENU** by clicking the joystick on the remote control.

2 Touch AUDIO to display the audio function names.

The audio function names are displayed and operable ones are highlighted.

- To go to the next group of function names, touch **NEXT**.
- To return to the previous group of function names, touch **PREV**.
- Only when the **PREOUT** setting in the initial menu is **FULL, NON FADING** will be displayed instead of **SUB WOOFER**. (Refer to *Setting the rear output and subwoofer controller* on page 107.)
- When selecting the FM tuner as the source, you cannot switch to **SLA**.
- To return to the previous display, touch **BACK**.

- To return to the display of each source, touch **ESC**.



Note

If you do not operate the audio function within about 30 seconds, the display is automatically returned to the source display. 

Using balance adjustment

You can change the fader/balance setting so that it can provide you an ideal listening environment in all occupied seats.

1 Touch FADER BALANCE on the audio function menu.

- When the rear output setting is **SUB. W**, **BALANCE** will be displayed instead of **FADER BALANCE**. Refer to *Setting the rear output and subwoofer controller* on page 107.

2 Touch ▲ or ▼ to adjust front/rear speaker balance.

Each time you touch **▲** or **▼** it moves the front/rear speaker balance towards the front or the rear.

FRONT:15 to **REAR:15** is displayed as the front/rear speaker balance moves from front to rear.

- **FR:00** is the proper setting when only two speakers are used.
- When the rear output setting is **SUB. W**, you cannot adjust front/rear speaker balance. Refer to *Setting the rear output and subwoofer controller* on page 107.

3 Touch ◀ or ▶ to adjust left/right speaker balance.

Each time you touch **◀** or **▶** it moves the left/right speaker balance towards the left or the right.

LEFT:09 to **RIGHT:09** is displayed as the left/right speaker balance moves from left to right. 

Audio Adjustments

Using the equalizer

The equalizer lets you adjust the equalization to match car interior acoustic characteristics as desired.

Recalling equalizer curves

There are six stored equalizer curves which you can easily recall at any time. Here is a list of the equalizer curves:

Display	Equalizer curve
Powerful	Powerful
Natural	Natural
Vocal	Vocal
Custom	Custom
Flat	Flat
Super Bass	Super bass

- **Custom** is an adjusted equalizer curve that you create.
 - A separate **Custom** curve can be created for each source. If you make adjustments, the equalizer curve settings will be memorized in **Custom**.
 - When **Flat** is selected no supplement or correction is made to the sound. This is useful to check the effect of the equalizer curves by switching alternatively between **Flat** and a set equalizer curve.
- **On any source, touch EQ (displayed at the left bottom corner) to select the equalizer.**
Touch **EQ** repeatedly to switch between the following equalizers:
Powerful—Natural—Vocal—Custom—Flat—Super Bass

Adjusting equalizer curves

You can adjust the currently selected equalizer curve setting as desired. Adjusted equalizer curve settings are memorized in **Custom**.

- You can adjust the center frequency and the Q factor (curve characteristics) of each currently selected curve band (**LOW/MID/HIGH**).

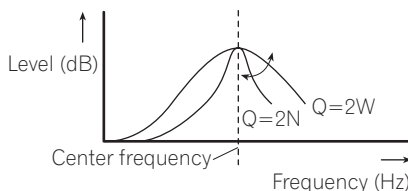

1 Touch EQ MENU on the audio function menu.

2 Touch ◀ or ▶ on the BAND setting to select the equalizer band to adjust.

Each time you touch ◀ or ▶ selects equalizer bands in the following order:

LOW (low)—**MID** (mid)—**HIGH** (high)

3 Touch ◀ or ▶ on the LEVEL setting to adjust the level of the equalizer band.

Each time you touch ◀ or ▶ increases or decreases the level of the equalization band.

+6 to -6 is displayed as the level is increased or decreased.

4 Touch ◀ or ▶ on the FREQUENCY setting to select the desired frequency.

Touch ◀ or ▶ until the desired frequency appears in the display.

Low: **40Hz—80Hz—100Hz—160Hz**

Mid: **200Hz—500Hz—1kHz—2kHz**

High: **3.15kHz—8kHz—10kHz—12.5kHz**

5 Touch ◀ or ▶ on the Q.FACTOR setting to select the desired Q factor.

Touch ◀ or ▶ until the desired Q factor appears in the display.

2N—1N—1W—2W

**Note**

If you make adjustments, **Custom** curve is updated.

Adjusting loudness

Loudness compensates for deficiencies in the low- and high-sound ranges at low volume.

1 Touch LOUDNESS on the audio function menu.

2 Touch ◀ on the LOUDNESS setting to turn loudness on.

- To turn loudness off, touch ▶.

3 Touch ◀ or ▶ on the MODE setting to select a desired level.

Each time you touch ◀ or ▶ selects level in the following order:

LOW (low)—**MID** (mid)—**HIGH** (high)

Using subwoofer output

This unit is equipped with a subwoofer output which can be turned on or off.

- When the subwoofer output is on, you can adjust the cut-off frequency and the output level of the subwoofer.

1 Touch SUB WOOFER on the audio function menu.

- When the **PREOUT** setting in the initial menu is **FULL**, you cannot select **SUB WOOFER**.

2 Touch ◀ on the SUBWOOFER setting to turn subwoofer output on.

- To turn subwoofer output off, touch ▶.

3 Touch ◀ or ▶ on the PHASE setting to select the phase of subwoofer output.

Touch ▶ to select normal phase and **NORMAL** appears in the display. Touch ◀ to

select reverse phase and **REVERSE** appears in the display.

4 Touch ◀ or ▶ on the LEVEL setting to adjust the output level of the subwoofer.

Each time you touch ◀ or ▶ increases or decreases the level of the subwoofer. **+6** to **-6** is displayed as the level is increased or decreased.

5 Touch ◀ or ▶ on the FREQUENCY setting to select cut-off frequency.

Each time you touch ◀ or ▶ selects cut-off frequencies in the following order:

50Hz—80Hz—125Hz

Only frequencies lower than those in the selected range are outputted from the subwoofer.

Using nonfading output

When the nonfading output setting is on, the audio signal does not pass through this unit's low pass filter (for the subwoofer), but is outputted through the RCA output.

1 Touch NON FADING on the audio function menu.

- When the **PREOUT** setting in the initial menu is only **FULL**, you can select **NON FADING**. (Refer to page 107.)

2 Touch ◀ on the NON FADING setting to turn non fading output on.

- To turn non fading output off, touch ▶.

3 Touch ◀ or ▶ on the LEVEL setting to adjust the output level of the non fading.

Each time you touch ◀ or ▶ increases or decreases the level of the non fading. **+6** to **-6** is displayed as the level is increased or decreased.

Audio Adjustments

Using the high pass filter

When you do not want low sounds from the subwoofer output frequency range to play from the front or rear speakers, turn on the HPF (high pass filter). Only frequencies higher than those in the selected range are outputted from the front or rear speakers.

1 Touch HPF on the audio function menu.

2 Touch ◀ to turn high pass filter on.

High pass filter is turned on and the cut-off frequency setting becomes available.

- To turn high pass filter off, touch ▶.

3 Touch ◀ or ▶ to select cut-off frequency.

Each time you touch ◀ or ▶ selects cut-off frequencies in the following order:

50Hz—80Hz—125Hz 

Adjusting source levels

SLA (source level adjustment) lets you adjust the volume level of each source to prevent radical changes in volume when switching between sources.

- Settings are based on the FM tuner volume level, which remains unchanged.

1 Compare the FM tuner volume level with the level of the source you wish to adjust.

2 Touch SLA on the audio function menu.

3 Touch ▲ or ▼ to adjust the source volume.

Each time you touch ▲ or ▼ it increases or decreases the source volume.

+4 to **-4** is displayed as the source volume is increased or decreased.

Notes

- The AM tuner volume level can also be adjusted with source level adjustments.
- Video CD, CD and MP3/WMA are set to the same source level adjustment volume automatically.
- AUX (auxiliary input) and AV (AV input) are set to the same source level adjustment volume automatically.
- External unit 1 and external unit 2 are set to the same source level adjustment volume automatically.
- SLA function does not adjust the volume for the BT telephone source. 

Staging for car environment

You can create in car a sound environment that can be best matched with the type of your listening music (or movie).

1 Touch STAGING on the audio function menu.

2 Touch a desired staging field.

- **OFF** (off)
- **MUSIC STUDIO** (music studio)
- **DYNAMIC THEATER** (dynamic theater)
- **ACTOR'S STAGE** (actor's stage)
- **RELAX LIVING** (relaxing living room)

Selecting the listening position

One way to assure a more natural sound is to accurately position the stereo image, putting you right in the center of the sound field. Selecting the listening position lets you automatically adjust the speaker output levels and inserts a delay time to match the number and position of occupied seats. When used with the staging function, the sound image will be more natural and you can feel as if a panoramic sound envelops you.

1 Touch POSITION on the staging menu.

2 Touch one of the listening positions where you want to focus the sound image.

- **LEFT** (left)
- **CENTER** (center)
- **RIGHT** (right)

Note

When you make adjustments to the listening position, the speaker outputs are automatically set for appropriate levels. You can tailor the levels more precisely referring to *Adjusting the speaker output levels using a test tone* or *Adjusting the speaker output levels*. 

Digital Signal Processor

Introduction of DSP adjustments

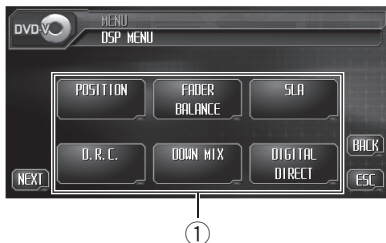

You can use this unit to control multi-channel processor (e.g. DEQ-P8000), which is sold separately.

- Some functions may differ depending on the multi-channel processor connected to this unit.

By carrying out the following settings/adjustments in the order shown, you can create a finely-tuned sound field effortlessly.

- 1 Setting the speaker setting
- 2 Using the position selector
- 3 Auto TA and EQ (auto-time alignment and auto-equalizing)
- 4 Adjusting the time alignment
- 5 Adjusting the speaker output levels using a test tone
- 6 Selecting a cross-over frequency
- 7 Adjusting the speaker output levels
- 8 Adjusting 3-band parametric equalizer

① DSP display

Shows the DSP function names.

1 Touch AUDIO MENU to display MENU. MENU appears on the display.

2 Touch DSP to display the DSP function names.

The DSP function names are displayed and operable ones are highlighted.

- To go to the next group of function names, touch **NEXT**.
- To return to the previous group of function names, touch **PREV**.
- When playing discs recorded with more than 96 kHz sampling frequency, you cannot use audio functions. Also, equalizer curve setting, **POSITION**, **AUTO EQ** and **AUTO TA** will be cancelled.
- When playing discs recorded with more than 96 kHz sampling frequency, audio is outputted from front speakers only.
- When selecting the FM tuner as the source, you cannot switch to **SLA**.
- When playing other than the DVD disc, you cannot switch to **D.R.C.**
- When neither **FRONT-L** nor **FRONT-R** is selected in **POSITION**, you cannot switch to **TIME ALIGNMENT**.
- When both the center speaker and the rear speaker are set to OFF in the speaker setting, you cannot switch to **DOLBY PRO LOGIC II**.
- To return to the previous display, touch **BACK**.
- To return to the display of each source, touch **ESC**.

Note

If you do not operate the DSP function within about 30 seconds, the display is automatically returned to the source display. 

Using the position selector

One way to assure a more natural sound is to accurately position the stereo image, putting you right in the center of the sound field. The position selector function lets you automatically adjust the speaker output levels and inserts a delay time to match the number and position of occupied seats.

1 Touch POSITION on the DSP function menu.

2 Touch ◀/▶/▲/▼ to select a listening position.

Touch one of these, ◀/▶/▲/▼, to select a listening position as listed in the table.

Key	Display	Position
◀	FRONT-L	Front seat left
▶	FRONT-R	Front seat right
▲	FRONT	Front seats
▼	ALL	All seats

▪ To cancel the selected listening position, touch the same key again.

Note

When you make adjustments to the listening position, the speaker outputs are automatically set for appropriate levels. You can tailor the levels more precisely referring to *Adjusting the speaker output levels using a test tone* or *Adjusting the speaker output levels*. 

Using balance adjustment

You can change the fader/balance setting so that it can provide you an ideal listening environment in all occupied seats.

1 Touch FADER/BALANCE on the DSP function menu.

2 Touch ▲ or ▼ to adjust front/rear speaker balance.

Each time you touch ▲ or ▼ it moves the front/rear speaker balance towards the front or the rear.

FRONT:25 to REAR:25 is displayed as the front/rear speaker balance moves from front to rear.

▪ **FR:00** is the proper setting when only two speakers are used.

3 Touch ◀ or ▶ to adjust left/right speaker balance.

Each time you touch ◀ or ▶ it moves the left/right speaker balance towards the left or the right.

LEFT:25 to RIGHT:25 is displayed as the left/right speaker balance moves from left to right. 

Adjusting source levels

SLA (source level adjustment) lets you adjust the volume level of each source to prevent radical changes in volume when switching between sources.

• Settings are based on the FM tuner volume level, which remains unchanged.

1 Compare the FM tuner volume level with the level of the source you wish to adjust.

2 Touch SLA on the DSP function menu.

3 Touch ▲ or ▼ to adjust the source volume.

Each time you touch ▲ or ▼ it increases or decreases the source volume.

+4 to -4 is displayed as the source volume is increased or decreased.

Notes

• The AM tuner volume level can also be adjusted with source level adjustments.

Digital Signal Processor

- Video CD, CD and MP3/WMA are set to the same source level adjustment volume automatically.
- External unit 1 and external unit 2 are set to the same source level adjustment volume automatically.
- AUX (auxiliary input) and AV (AV input) are set to the same source level adjustment volume automatically.

Using the dynamic range control

The dynamic range refers to the difference between the largest and softest sounds. The dynamic range control compresses this difference so that you can clearly hear sounds even at low volume levels.

- The dynamic range control is effective only on Dolby Digital sounds.
- When playing other than the DVD disc, you cannot switch to **D.R.C.**

1 Touch **D.R.C** on the **DSP** function menu.

- When playing other than the DVD disc, you cannot switch this mode.

2 Touch **ON** to turn the dynamic range control on.

- To turn dynamic range control off, touch **OFF**.

Using the down-mix function

Only when the multi-channel processor (e.g., DEQ-P8000) is connected to this unit, you can operate this function.

The down-mix function allows you to play back multi-channel audio in 2 channels.

1 Touch **DOWN MIX** on the **DSP** function menu.

2 Touch **◀** or **▶** to select the desired level.

Touch **◀** to select **Lo/Ro**. Touch **▶** to select **Lt/Rt**.

- **Lo/Ro** – Stereo mix the original audio that do not contain channel modes such as surround components.
- **Lt/Rt** – Down mix so that the surround components can be restored (decoded).

Using the direct control

You can override audio settings to check for effectiveness of your audio settings.

- All audio functions are locked out when the direct control is on except **VOLUME**.

1 Touch **DIGITAL DIRECT** on the **DSP** function menu.

2 Touch **ON** to turn the direct control on.

- To turn direct control off, touch **OFF**.

Using the Dolby Pro Logic II

Only when the multi-channel processor (e.g., DEQ-P8000) is connected to this unit, you can operate this function.

Dolby Pro Logic II creates five full-bandwidth output channels from two-channel sources to achieve high-purity matrix surround.

- Dolby Pro Logic II supports up to 48kHz sampling rate stereo source and has no effect on other types of source.

1 Touch **DOLBY PRO LOGIC II** on the **DSP** function menu.

2 Touch any of the following touch panel keys to select the desired mode.

- **MOVIE** – The Movie mode suitable for movie playback
- **MUSIC** – The Music mode suitable for music playback
- **MATRIX** – The Matrix mode for when FM radio reception is weak
- **OFF** – Turn Dolby Pro Logic II off
- **ADJUST** – Adjust the Music mode
 - You can operate **ADJUST** only when **MUSIC** has been selected.

Adjusting the Music mode

You can adjust the Music mode with the following three controls.

- Panorama (**PANORAMA**) extends the front stereo image to include the surround speakers for an exciting “wraparound” effect.
- Dimension (**DIMENSION**) allows you to gradually adjust the sound field either towards the front or the rear.
- Center Width Control (**CENTER WIDTH**) allows center-channel sounds to be positioned between the center speaker and the left/right speakers. It improves the left-center-right stage presentation for both the driver and the front passenger.

1 Touch DOLBY PRO LOGIC II on the DSP function menu.

2 Touch MUSIC and then touch ADJUST.

- You can operate **ADJUST** only when **MUSIC** has been selected.

3 Touch ▲ or ▼ to select PANORAMA (panorama).

Each time you touch ▲ or ▼ selects the item in the following order:

PANORAMA (panorama)—**DIMENSION** (dimension)—**CENTER WIDTH** (center width)

4 Touch ◀ to turn the panorama control on.

- To turn the panorama control off, touch ▶.

5 Touch ▼ to select DIMENSION and then touch ◀ or ▶ to adjust front/surround speaker balance.

Each time you touch ◀ or ▶ it moves the sound towards the front or the surrounds. **+3** to **-3** is displayed as the front/surround speaker balance moves from front to surrounds.

6 Touch ▼ to select CENTER WIDTH and then touch ◀ or ▶ to adjust the center image.

Each time you touch ◀ or ▶ it gradually spreads the center channel sound into the front left and right speakers over a range **0** to **7**.

3 is the default and it's recommended for most recordings. **0** places all center sound in the center speaker. **7** places all center sound equally in the left/right speakers. ▣

Setting the speaker setting

You need to make with/without (or yes/no) and size (bass reproducing capacity) selection/adjustments depending on the installed speakers. The size needs to be set to **LARGE** (large) if the speaker is capable of reproducing sounds of about 100 Hz or below. Otherwise select **SMALL** (small).

- When **DIGITAL DIRECT** is on, you cannot select **SPEAKER SETTING**. First turn the **DIGITAL DIRECT** off, referring to *Using the direct control* on the previous page.
- Low frequency range is not output if the subwoofer is set to **OFF** and the front and rear speakers set to **SMALL** or **OFF**.
- It is imperative that non-installed speakers be set to **OFF**.

Digital Signal Processor

- Set the front or rear speaker to **LARGE** if the speaker is capable of reproducing bass content, or if no subwoofer is installed.

1 Touch **SPEAKER SETTING** on the **DSP function menu**.

2 Touch ◀ or ▶ to select the speaker to be adjusted.

Each time you touch ▲ or ▼ selects the speaker in the following order:

FRONT (front speakers)—**CENTER** (center speaker)—**REAR** (rear speakers)—**SUB WOOFER** (subwoofer)—**PHASE** (subwoofer setting)

- You can switch to **PHASE** only when the subwoofer has been set to **ON**.

3 Touch ◀ or ▶ to select the correct size for the selected speaker.

Each time you touch ◀ or ▶ selects the size in the following order:

Speaker	Setting
FRONT	SMALL—LARGE
CENTER	OFF—SMALL—LARGE
REAR	OFF—SMALL—LARGE
SUB WOOFER	ON—OFF
PHASE	REVERSE—NORMAL

Correcting the subwoofer's phase

If trying to boost the bass output of the subwoofer doesn't do much or rather makes you feel that the bass gets more murky, this may indicate that the subwoofer's output and bass content you hear over other speakers cancel each other out. To remove this problem, try changing the phase setting for the subwoofer.

1 Touch **SPEAKER SETTING** on the **DSP function menu**.

2 Touch ◀ or ▶ to select **SUB WOOFER**.

Each time you touch ◀ or ▶ selects the speaker in the following order:

FRONT (front speakers)—**CENTER** (center speaker)—**REAR** (rear speakers)—**SUB WOOFER** (subwoofer)—**PHASE** (subwoofer setting)

3 Touch ◀ to turn subwoofer output on.

- To turn subwoofer output off, touch ▶.

4 Touch ▶ to select **PHASE** and then touch ◀ or ▶ to select the phase of subwoofer output.

Touch ▶ to select **NORMAL** (normal phase).
Touch ◀ to select **REVERSE** (reverse phase).



Note

When playing a 2-channel mono source with Pro Logic turned on, there may be occasions when the following will occur:

- No audio is outputted if the center speaker setting is **SMALL** or **LARGE** and no center speaker is installed.
- Audio is heard only over the center speaker if installed and the center speaker setting is **SMALL** or **LARGE**. ▣

Adjusting the speaker output levels

You can readjust the speaker output levels using a test tone while listening to music.

1 Touch **SPEAKER LEVEL** on the **DSP function menu**.

2 Touch ◀ or ▶ to select the speaker to be adjusted.

Each time you touch ◀ or ▶ selects the speaker in the following order:

FRONT-L (front speaker left)—**CENTER** (center speaker)—**FRONT-R** (front speaker right)—**REAR-R** (rear speaker right)—**REAR-L** (rear speaker left)—**SUB WOOFER** (subwoofer)

- You cannot select speakers whose size is set to **OFF** at the **SPEAKER SETTING** menu.

3 Touch ◀ or ▶ to adjust the speaker output level.

Each time you touch ◀ or ▶ increases or decreases the speaker output level. **+10** to **-10** is displayed as the level is increased or decreased.



Note

To adjust the speaker output levels in this mode is the same as making the speaker output levels at **TEST TONE**. Both provide the same results. 

Selecting a cross-over frequency

You can select a frequency, under which sounds are reproduced through the subwoofer. If the installed speakers include one whose size has been set to **SMALL**, you can select a frequency, under which sounds are reproduced through a **LARGE** speaker or subwoofer.

1 Touch **CROSS OVER** on the **DSP** function menu.

2 Touch ◀ or ▶ to select the speaker to be adjusted.

Each time you touch ◀ or ▶ selects the speaker in the following order:

FRONT (front speakers)—**CENTER** (center speaker)—**REAR** (rear speakers)—**SUB WOOFER** (subwoofer)

3 Touch ◀ or ▶ to select cross-over frequency.

Each time you touch ◀ or ▶ selects cut-off frequencies in the following order:

63—80—100—125—160—200 (Hz)



Note

Selecting a cross-over frequency is to set a cross-over frequency of the subwoofer's L.P.F. (low-pass filter) and that of the **SMALL** speaker H.P.F. (high-pass filter). The cross-over frequency setting has no effect if the subwoofer is set to **OFF** and other speakers are set to **LARGE** or **OFF**. 

Adjusting the speaker output levels using a test tone

This function allows you to easily get the overall balance right among the speakers.

1 Touch **TEST TONE** on the **DSP** function menu.

2 Touch **START** to start the test tone output.

The test tone is outputted. It rotates from speaker to speaker in the following sequence at intervals of about two seconds. The current settings for the speaker over which you hear the test tone are shown in the display.

FRONT-L (front speaker left)—**CENTER** (center speaker)—**FRONT-R** (front speaker right)—**REAR-R** (rear speaker right)—**REAR-L** (rear speaker left)—**SUB WOOFER** (subwoofer)

Check each speaker output level. If no adjustments are needed, perform step 5 to stop the test tone.

- The settings do not appear for speakers whose size is set **OFF**.

Digital Signal Processor

3 Touch ◀ or ▶ to adjust the speaker output level.

Each time you touch ◀ or ▶ increases or decreases the speaker output level. **+10** to **-10** is displayed as the level is increased or decreased.

- The test tone rotates to the next speaker after about two seconds from the last operation.

4 Touch STOP to stop the test tone output.



Notes

- If needed, select speakers and adjust their 'absolute' output levels. (Refer to *Adjusting the speaker output levels* on page 93.)
- To adjust the speaker output levels in this mode is the same as making the speaker output levels at **SPEAKER LEVEL**. Both provide the same results.

Using the time alignment

Only when the multi-channel processor (e.g., DEQ-P8000) is connected to this unit, you can operate this function.

The time alignment lets you adjust the distance between each speaker and the listening position.

1 Touch TIME ALIGNMENT on the DSP function menu.

2 Touch any of the following touch panel keys to select the time alignment.

- **INITIAL** – Initial time alignment (factory setting)
- **AUTO TA** – Time alignment created by auto TA and EQ. (Refer to *Auto TA and EQ (auto-time alignment and auto-equalizing)* on page 98.)

- **CUSTOM** – Adjusted time alignment that you can create for yourself
- **OFF** – Turn the time alignment off
- **ADJUST** – Adjust the time alignment as desired
 - You cannot select **AUTO TA** if auto TA and EQ has not been carried out.
 - You cannot select **ADJUST** when neither **FRONT-L** nor **FRONT-R** is selected in **POSITION**.

Adjusting the time alignment

You can adjust the distance between each speaker and the selected position.

- An adjusted time alignment is memorized in **CUSTOM**.

1 Touch TIME ALIGNMENT on the DSP function menu and then touch ADJUST.

- You cannot select **ADJUST** when neither **FRONT-L** nor **FRONT-R** is selected in **POSITION**.

2 Touch ◀ or ▶ to select the speaker to be adjusted.

Each time you touch ◀ or ▶ selects the speaker in the following order:

FRONT-L (front speaker left)—**CENTER** (center speaker)—**FRONT-R** (front speaker right)—**REAR-R** (rear speaker right)—**REAR-L** (rear speaker left)—**SUB WOOFER** (subwoofer)

- You cannot select speakers whose size is set at **OFF**.

3 Touch ◀ or ▶ to adjust the distance between the selected speaker and the listening position.

Each time you touch ◀ or ▶ increases or decreases the distance. **0.0** – **200.0 [inches]** is displayed as the distance is increased or decreased.

4 Touch ESC to return to the playback display.

Using the equalizer

The equalizer lets you adjust the equalization to match car interior acoustic characteristics as desired.

Recalling equalizer curves

There are seven stored equalizer curves which you can easily recall at any time. Here is a list of the equalizer curves:

Display	Equalizer curve
Powerful	Powerful
Natural	Natural
Vocal	Vocal
Flat	Flat
Custom1	Custom 1
Custom2	Custom 2
Super Bass	Super bass

- **Custom1** and **Custom2** are adjusted equalizer curves.
- When **Flat** is selected no supplement or correction is made to the sound. This is useful to check the effect of the equalizer curves by switching alternatively between **Flat** and a set equalizer curve.

- **On the normal display, touch EQ to select the equalizer.**

Touch **EQ** repeatedly to switch between the following equalizers:

Powerful—Natural—Vocal—Flat—Custom1—Custom2—Super Bass

- If **SFC** instead of **EQ** appears on the normal display, touch **SFC** and hold to switch to equalizer function. About SFC, refer to *Using the sound field control* on this page.

Using the sound field control

The SFC function creates the sensation of a live performance.

- One of the greatest advantages to hear music in live is the original acoustic sound that is echoed or reflected against the stage surroundings. The SFC circuitry enables to reproduce the live performing sound in car environment by programming the direct sound, early reflections, and late reflections effects and characterizing the sound from CD, DVD or other medium so it becomes closer to the live acoustic sound.

1 On the normal display, touch EQ and hold to switch to SFC function.

Touch **EQ** and hold until **Sound Field Control** appears in the display.

- To switch to equalizer function, touch **EQ** and hold again.

2 Touch SFC to select the desired SFC mode.

Touch **SFC** repeatedly to switch between the following modes:

MUSICAL (musical)—**DRAMA** (drama)—**ACTION** (action)—**JAZZ** (jazz)—**HALL** (hall)—**CLUB** (club)—**OFF** (off)



Note

If the source is a 2-channel LPCM audio or a 2-channel Dolby Digital audio and you select SFC effects that are most applicable for 5.1-channel audio (i.e., **MUSICAL**, **DRAMA** or **ACTION**), we recommend turning Dolby Pro Logic II on. On the other hand, when selecting SFC effects that are intended for use with 2-channel audio (i.e., **JAZZ**, **HALL** or **CLUB**), we recommend turning Dolby Pro Logic II off.

Digital Signal Processor

Adjusting 3-band parametric equalizer

For **Custom1** and **Custom2** equalizer curves, you can adjust the front, rear and center equalizer curves separately by selecting a center frequency, an equalizer level and a Q factor for each band.

- A separate **Custom1** curve can be created for each source.
- A **Custom2** curve can be created common to all sources.
- The center speaker largely determines the sound image and getting the balance right isn't easy. We recommend reproducing a 2-ch. audio (a CD for example) and getting the balance right among the speakers except for the center, and then reproducing a 5.1-ch. audio (Dolby Digital or DTS) and adjusting the center speaker output to the balance you have already got among the other speakers.

- **Touch PARAMETRIC EQ on the DSP function menu.**



Note

You can select a center frequency for each band. You can change the center frequency in 1/3-octave steps, but you cannot select frequencies that have intervals shorter than 1 octave among the center frequencies of the three bands.

Speaker select

1 Touch ◀ or ▶ to select SP-SEL.

Each time you touch ◀ or ▶ selects the item in the following order:

SP-SEL (speakers)—**BAND** (bands)—**FREQUENCY** (center frequency)—**LEVEL** (equalizer level)—**Q. FACTOR** (Q factor)

2 Touch ◀ or ▶ to select the speaker to be adjusted.

Touch ◀ or ▶ until the desired speaker appears in the display.

REAR (rear speakers)—**CENTER** (center speaker)—**FRONT** (front speakers)

- You cannot select speakers whose size is set at **OFF**.

Band

1 Touch ◀ or ▶ to select BAND.

Each time you touch ◀ or ▶ selects the item in the following order:

SP-SEL (speakers)—**BAND** (bands)—**FREQUENCY** (center frequency)—**LEVEL** (equalizer level)—**Q. FACTOR** (Q factor)

2 Touch ◀ or ▶ to select the equalizer band to be adjusted.

Each time you touch ◀ or ▶ selects equalizer bands in the following order:

LOW (low)—**MID** (mid)—**HIGH** (high)

Frequency

1 Touch ◀ or ▶ to select FREQUENCY.

Each time you touch ◀ or ▶ selects the item in the following order:

SP-SEL (speakers)—**BAND** (bands)—**FREQUENCY** (center frequency)—**LEVEL** (equalizer level)—**Q. FACTOR** (Q factor)

2 Touch ◀ or ▶ to select the center frequency of selected band.

Touch ◀ or ▶ until the desired frequency appears in the display.

40Hz—50Hz—63Hz—80Hz—100Hz—125Hz—160Hz—200Hz—250Hz—315Hz—400Hz—500Hz—630Hz—800Hz—1kHz—1.25kHz—1.6kHz—2kHz—2.5kHz—3.15kHz—4kHz—5kHz—6.3kHz—8kHz—10kHz—12.5kHz

Level**1 Touch ◀ or ▶ to select LEVEL.**

Each time you touch ◀ or ▶ selects the item in the following order:

SP-SEL (speakers)—**BAND** (bands)—**FREQUENCY** (center frequency)—**LEVEL** (equalizer level)—**Q. FACTOR** (Q factor)

2 Touch ◀ or ▶ to adjust the equalizer level.

Each time you touch ◀ or ▶ increases or decreases the equalizer level. **+06** to **-06** is displayed as the level is increased or decreased.

Q factor**1 Touch ◀ or ▶ to select Q. FACTOR.**

Each time you touch ◀ or ▶ selects the item in the following order:

SP-SEL (speakers)—**BAND** (bands)—**FREQUENCY** (center frequency)—**LEVEL** (equalizer level)—**Q. FACTOR** (Q factor)

2 Touch ◀ or ▶ to select the desired Q factor.

Each time you touch ◀ or ▶ switches between the following Q factor:

NARROW (narrow)—**WIDE** (wide)

- You can adjust parameters for each band of the other speakers in the same way. 

Using the auto-equalizer

The auto-equalizer is the equalizer curve created by auto TA and EQ (refer to *Auto TA and EQ (auto-time alignment and auto-equalizing)* on this page).

You can turn the auto-equalizer on or off.

1 Touch AUTO EQ on the DSP function menu.

- You cannot use this function if auto TA and EQ has not been carried out.

2 Touch ON to turn the auto-equalizer on.

- To turn auto-equalizer off, touch **OFF**. 

Auto TA and EQ (auto-time alignment and auto-equalizing)

Only when the multi-channel processor (e.g., DEQ-P8000) is connected to this unit, you can operate this function.

The auto-time alignment is automatically adjusted for the distance between each speaker and the listening position.

The auto-equalizer automatically measures the car interior acoustic characteristics, and then creates the auto-equalizer curve based on that information.

 WARNING

To prevent accidents, never carry out auto TA and EQ while driving. When this function measures the car interior acoustic characteristics to create an auto-equalizer curve, a loud measurement tone (noise) may be outputted from the speakers.

 CAUTION

- Carrying out auto TA and EQ under the following conditions may damage the speakers. Be sure to check the conditions thoroughly before carrying out auto TA and EQ.
 - When speakers are incorrectly connected. (e.g., When a rear speaker is connected to a subwoofer output.)
 - When a speaker is connected to a power amp delivering output higher than the speaker's maximum input power capability.
- If the microphone is placed in an unsuitable position the measurement tone may become loud and measurement may take a long time, resulting in a drain on battery power. Be sure to place the microphone in the specified location.

Digital Signal Processor

Before operating the auto TA and EQ function

- Carry out auto TA and EQ in as quiet a place as possible, with the car engine and air conditioning switched off. Also cut power to car phones or portable telephones in the car, or remove them from the car before carrying out auto TA and EQ. Sounds other than the measurement tone (surrounding sounds, engine sound, telephones ringing etc.) may prevent correct measurement of the car interior acoustic characteristics.
- Be sure to carry out auto TA and EQ using the supplied microphone. Using another microphone may prevent measurement, or result in incorrect measurement of the car interior acoustic characteristics.
- When front speaker is not connected, auto TA and EQ cannot be carried out.
- When this unit is connected to a power amp with input level control, auto TA and EQ may not be possible if you lower power amp input level. Set the power amp's input level to the standard position.
- When this unit is connected to a power amp with an LPF, turn off the LPF on the power amp before carrying out auto TA and EQ. In addition, the cut-off frequency for built-in LPF of an active subwoofer should be set to the highest frequency.
- The time alignment value calculated by auto TA and EQ may differ from the actual distance in the following circumstances. However, the distance has been calculated by computer to be the optimum delay to give accurate results for the circumstances, so please continue to use this value.
 - When the reflected sound within a vehicle is strong and delays occur.
 - When delays occur for low sounds due to the influence of the LPF on active subwoofers or external amps.

- Auto TA and EQ changes the audio settings as below:
 - The fader/balance settings return to the center position. (Refer to page 90.)
 - The equalizer curve switches to **Flat**. (Refer to page 96.)
 - It will be adjusted automatically to high pass filter setting for front, center and rear speaker.
- If you carry out auto TA and EQ when a previous setting of this already exists, the setting will be replaced.

Carrying out auto TA and EQ

1 Stop the car in a place that is as quiet as possible, close all doors, windows and the sun roof, and then turn the engine off.

If the engine is left running, engine noise may prevent correct auto TA and EQ.

2 Fix the supplied microphone in the center of the headrest of the driver's seat, facing forward, using the belt (sold separately).

The auto TA and EQ may differ depending on where you place the microphone. If desired, place the microphone on the front passenger seat to carry out auto TA and EQ.

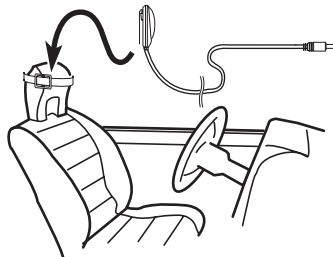

3 Turn the ignition switch to ON or ACC.

If the car's air conditioner or heater is turned on, turn it off. Noise from the fan in the air conditioner or heater may prevent correct auto TA and EQ.

- Press **SOURCE** to turn the source on if this unit is turned off.

4 Select the position for the seat on which the microphone is placed.

Refer to *Using the position selector* on page 89.

- If no position is selected before you start auto TA and EQ, **FRONT-L** is selected automatically.

5 Press **SOURCE** and hold until the unit turns off.

6 Touch and hold **EQ** to enter the auto TA and EQ measurement mode.

7 Plug the microphone into the microphone input jack on the multi-channel processor.

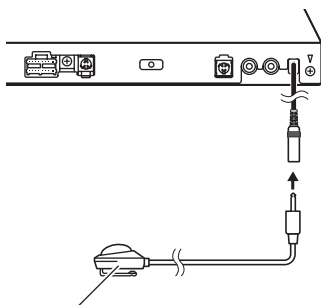

AUTO TA&EQ microphone

For details concerning operation, refer to the multi-channel processor's operation manual.

8 Touch **START** to start the auto TA and EQ.

9 Get out of the car and close the door within 10 seconds when the 10-second count-down starts.

The measurement tone (noise) is outputted from the speakers, and auto TA and EQ begins.

- When all speakers are connected, auto TA and EQ is completed in about nine minutes.
- To stop auto TA and EQ, touch **STOP**.

- To cancel auto TA and EQ part way through, touch **BACK** or **ESC**.

10 When auto TA and EQ is completed, **Complete** is displayed.

When correct measurement of car interior acoustic characteristics is not possible, an error message is displayed. (Refer to *Understanding auto TA and EQ error messages* on page 119.)

11 Touch **ESC** to cancel the auto TA and EQ mode.

12 Store the microphone carefully in the glove compartment.

Store the microphone carefully in the glove compartment or any other safe place. If the microphone is subjected to direct sunlight for an extended period, high temperatures may cause distortion, color change or malfunction. ■

Setup

Introduction of setup adjustments

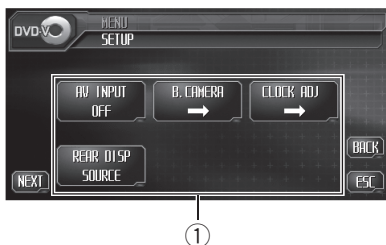

- ① **Setup menu display**
Shows the setup function names.

1 Touch AUDIO MENU to display MENU.

MENU appears on the display.

- You can also display **MENU** by clicking the joystick on the remote control.

2 Touch SETUP to display the setup function names.

The setup function names are displayed and operable ones are highlighted.

- To return to the previous display, touch **BACK**.
- To return to the display of each source, touch **ESC**.

Note

If you do not operate the setup function within about 30 seconds, the display is automatically returned to the source display. 

Setting the AV input

You can connect an AV component to this unit and display videos either on **AV** source or **EXT** source.

Switch the AV input setting depending on the connected AV components.

- Select **VIDEO** to watch video of a connected component as **AV** source.
- Select **EXT-V** to watch video of a connected video unit as **EXT** source.

● Touch AV input on the setup menu to select the AV input setting.

Touch **AV input** until the desired setting is selected.

- **OFF** – No video component is connected
- **VIDEO** – External video component (such as portable video player)
- **EXT-V** – External video unit (such as Pioneer products available in the future)
 - **EXT-V** can be selected only when external video unit is connected to this unit. 

Setting for rear view camera (back up camera)

CAUTION

Pioneer recommends the use of a camera which outputs mirror reversed images, otherwise screen image may appear reversed.

This unit features a function that automatically switches to the rear view camera video (**BACK UP CAMERA IN** jack) when a rear view camera is installed on your vehicle. When the gear shift is in **REVERSE (R)** position, the video automatically switches to a rear view camera video. (For more details, consult your dealer.)

- After you set up the rear view camera setting, move the gear shift in **REVERSE (R)** and confirm if a rear view camera video can be shown on the display.
- If the display should be switched to a rear view camera video by error while you are driving forward, change the rear view camera setting.
- To end watching a rear view camera video and return to the source display, press **V.ADJ.**

- 1 Touch **B.CAMERA** on the setup menu.
- 2 Touch **◀** on the **BACK UP CAMERA setting to turn rear view camera setting on.**
 - To turn rear view camera setting off, touch **▶**.
- 3 Touch **◀** or **▶** on the **POLARITY setting to select an appropriate setting for polarity.**

Each time you touch **◀** or **▶** it switches between the following polarity:

- **BATTERY** – When the polarity of the connected lead is positive while the gear shift is in **REVERSE (R)** position
- **GND** – When the polarity of the connected lead is negative while the gear shift is in **REVERSE (R)** position

Setting the clock

Use these instructions to set the clock.

- 1 Touch **CLOCK ADJ** on the setup menu.
- 2 Touch **OFF** to turn the clock display on. **ON** will appear in the display instead of **OFF**. Clock display is now on.
 - To turn the clock display off, touch **ON**.
- 3 Touch **◀** or **▶** to select the segment of the clock display you wish to set.

Each time you touch **◀** or **▶** it will select one segment of the clock display:

Hour—Minute

As you select segments of the clock display the segment selected will be highlighted.



- 4 Touch **▲** or **▼** to set the clock.

Each time you touch **▲** it increases the selected hour or minute. Each time you touch **▼** it decreases the selected hour or minute.

Notes

- You can match the clock to a time signal by touching **JUST**.
 - If the minute is **00** to **29**, the minutes are rounded down. (e.g., **10:18** becomes **10:00**.)
 - If the minute is **30** to **59**, the minutes are rounded up. (e.g., **10:36** becomes **11:00**.)
- Even when the sources are off, the clock display appears on the display.

Selecting video on rear display

You can set the rear display to automatically switch to the navigation image or AVG-VDP1 with the front display. Alternatively, you can set it to remain showing the selected video source and not change with the front display.

- The navigation image or the AVG-VDP1 can be displayed when a Pioneer navigation unit or a Vehicle Dynamics Processor is connected to this unit.
- When selecting **SOURCE** and the selected source is an audio source, nothing is displayed on the rear display.
- Touch **REAR DISP** on the setup menu to display video of the selected source on the rear display.

Touch **REAR DISP** until the desired video setting appears in the display.

- **SOURCE** – Display the video of the selected source on the rear display
- **NAVI** – Display the navigation image or AVG-VDP1 on rear display

DVD Setup

Introduction of DVD setup adjustments

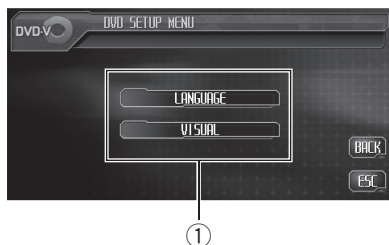

You can use this menu to change audio, subtitle, parental lock and other DVD settings.

① DVD setup menu display

Shows the DVD setup menu names.

1 While playing a DVD disc, touch ■.

Playback of the disc is stopped. **SETUP** will be displayed instead of **MENU** on the DVD menu.

2 Touch **SETUP**.

The DVD setup menu is displayed.

3 Touch **LANGUAGE** to display the DVD language menu. Touch **VISUAL** to display the DVD visual menu.

The DVD function names categorized under the selected menu are displayed.

- To go to the next group of function names, touch **NEXT**.
- To return to the previous group of function names, touch **PREV**.
- To return to the previous display, touch **BACK**.
- To return to the playback display, touch **ESC**.

Note

If you do not operate the DVD setup function within about 30 seconds, the display is automatically returned to the playback display. 

Setting the subtitle language

You can set a desired subtitle language. If the selected subtitle language is recorded on the DVD, subtitles are displayed in that language.

1 Touch **SUB TITLE LANGUAGE** on the DVD language menu.

Subtitle language menu is displayed and the currently selected language is highlighted.

- To switch to the second language select menu, touch **NEXT**.
- To return to the first language select menu, touch **PREV**.

2 Touch the desired language.

A subtitle language is set.

- If you have selected **OTHERS**, refer to *When you select OTHERS* on this page.

Notes

- If the selected language is not recorded on the disc, the language specified on the disc is displayed.
- You can also switch the subtitle language by touching **SUB TITLE** during playback. (Refer to *Changing the subtitle language during playback (Multi-subtitle)* on page 33.)
- Even if you use **SUB TITLE** during playback to switch the subtitle language, this does not affect the settings here.

When you select **OTHERS**

When you select **OTHERS**, a language code input display is shown. Refer to *Language code chart for DVD* on page 126 to input the four-digit code of the desired language.

1 Touch **0—9** to input the language code.

- To cancel the inputted numbers, touch **C**.

2 While the inputted number is displayed, touch **ENTER**.

Setting the audio language

You can set the preferred audio language.

1 Touch AUDIO LANGUAGE on the DVD language menu.

Audio language menu is displayed and the currently selected language is highlighted.

- To switch to the second language select menu, touch **NEXT**.
- To return to the first language select menu, touch **PREV**.

2 Touch the desired language.

The audio language is set.

- If you have selected **OTHERS**, refer to *When you select OTHERS* on the previous page.



Notes

- If the selected language is not recorded on the disc, the language specified on the disc is outputted.
- You can also switch the audio language by touching **AUDIO** during playback. (Refer to *Changing audio language during playback (Multi-audio)* on page 32.)
- Even if you use **AUDIO** during playback to switch the audio language, this does not affect the settings here. 

Setting the menu language

You can set the preferred language for displays of menus recorded on a disc.

1 Touch MENU LANGUAGE on the DVD language menu.

A menu language menu is displayed and the currently set language is highlighted.

- To switch to the second language select menu, touch **NEXT**.
- To return to the first language select menu, touch **PREV**.

2 Touch the desired language.

The menu language is set.

- If you have selected **OTHERS**, refer to *When you select OTHERS* on the previous page.



Note

If the selected language is not recorded on the disc, the language specified on the disc is displayed. 

Switching the assist subtitle on or off

If assist subtitles are recorded on a DVD disc, you can display them by turning the assist subtitle function on.

1 Touch NEXT on the DVD language menu.

2 Touch ASSIST SUB TITLE to turn assist subtitles on.

ON appears in the display.

- To turn the assist subtitle off, touch **ASSIST SUB TITLE** again. 

Setting the angle icon display

With this function on, the angle icon appears when the scene can be played back by different angle.

● Touch MULTI ANGLE on the DVD visual menu to turn the angle icon display on.

ON appears in the display.

- To turn the angle icon display off, touch **MULTI ANGLE** again. 

DVD Setup

Setting the aspect ratio

There are two kinds of display. A wide screen display has a width-to-height ratio (TV aspect) of 16:9, while a regular display has a TV aspect of 4:3. Be sure to select the correct TV aspect for the display connected to **VIDEO OUTPUT**.



- When using a regular display, select either **LETTER BOX** or **PANSCAN**. Selecting **16:9** may result in an unnatural picture.
- If you select the TV aspect, the unit's display changes to the same setting.

1 Touch TV ASPECT on the DVD visual menu.

2 Touch any of the following touch panel keys to select the TV aspect.

- **16:9** – Wide screen picture (16:9) is displayed as it is (initial setting)
- **LETTER BOX** – The picture is the shape of a letterbox with black bands at the top and bottom of the screen
- **PANSCAN** – The picture is cut short at the right and left of the screen

Notes

- When playing discs that do not specify **PANSCAN**, playback is with **LETTER BOX** even if you select **PANSCAN** setting. Confirm whether the disc package bears the  mark. (See page 12.)
- Some discs do not enable changing of the TV aspect. For details, refer to the disc's instructions. 

Setting the parental lock

Some DVD video discs let you use parental lock to restrict children from viewing violent and adult-oriented scenes. You can set the parental lock to your desired level.

- When you set a parental lock level and then play a disc featuring parental lock, code number input indications may be displayed. In this case, playback will begin when the correct code number is input.

Setting the code number and level

You need to have registered a code number for playing back discs with parental lock.

1 Touch PARENTAL on the DVD visual menu.

2 Touch 0—9 to input a four digit code number.

- To cancel the inputted numbers, touch **C**.

3 While the inputted number is displayed, touch ENTER.

The code number is set, and you can now set the level.

4 Touch any of 1—8 to select the desired level.

The parental lock level is set.

- **LEVEL 8** – Playback of the entire disc is possible (initial setting)
- **LEVEL 7 to LEVEL 2** – Playback of discs for children and non-adult-oriented discs is possible
- **LEVEL 1** – Playback of discs for children only is possible

Notes

- We recommend to keep a record of your code number in case you forget it.
- The parental lock level is recorded on the disc. Look for the level indication written at the disc package, included literature or on the disc itself. Parental lock of this unit is not possible if a parental lock level is not recorded in the disc.

- With some discs, the parental lock may be active only on the scenes with certain levels. The playback of those scenes will be skipped. For details, refer to the instruction manual that came with the discs.

Changing the level

You can change the set parental lock level.

1 Touch PARENTAL on the DVD visual menu.

2 Touch 0—9 to input the registered code number.

3 Touch ENTER.

This enters the code number, and you can now change the level.

- If you input an incorrect code number, the icon  is displayed. Touch **C** and input the correct code number.
- If you forget your code number, refer to *If you forget your code number* on this page.

4 Touch any of 1—8 to select the desired level.

The new parental lock level is set.

If you forget your code number

Refer to *Setting the code number and level* on the previous page, and touch **C** 10 times. The registered code number is all cleared, letting you register a new one. 

Initial Setup

Adjusting initial settings

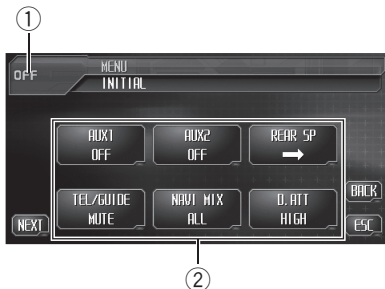

Using the initial settings, you can customize various system settings to achieve optimal performance from this unit.

① Source icon

Shows which source has been selected.

② Function display

Shows the function names.

1 Touch the source icon and then touch OFF to turn this unit off.

- When the source icon is not displayed, you can display it by touching the screen.

2 Touch AUDIO MENU and then touch INITIAL to display the function names.

The function names are displayed and operable ones are highlighted.

- To go to the next group of function names, touch **NEXT**.
- To return to the previous group of function names, touch **PREV**.
- To return to the previous display, touch **BACK**.
- To return to the display of each source, touch **ESC**.

Switching the auxiliary setting

Auxiliary equipments connected to this unit can be activated individually. Set each AUX source to ON when using. About connecting or using auxiliary equipments, refer to *Using the AUX source* on page 114.

● Touch AUX1/AUX2 on the initial menu to turn each auxiliary setting on.

- To turn auxiliary setting off, touch **AUX1/AUX2** again.

Setting the rear output and subwoofer controller

This unit's rear output (rear speaker leads output) can be used for full-range speaker (**FULL**) or subwoofer (**SUB. W**) connection. If you switch the rear output setting to **SUB. W**, you can connect a rear speaker lead directly to a subwoofer without using an auxiliary amp. Initially, the unit is set for rear full-range speaker connection (**FULL**). When rear output is connected to full range speakers (when **FULL** is selected), you can connect the RCA subwoofer output to a subwoofer. In this case, you can select whether to use the subwoofer controller's (low pass filter, phase) built-in **SUB.W** or the auxiliary **FULL**.

- When the multi-channel processor (e.g., DEQ-P8000) is connected to this unit, you cannot operate this function.

1 Touch REAR SP on the initial menu.

2 Touch ◀ or ▶ on the REAR SPEAKER to switch the rear output setting.

Touch ◀ to select full-range speaker and **FULL** appears in the display. Touch ▶ to select subwoofer and **SUB. W** appears in the display.

- When no subwoofer is connected to the rear output, select **FULL**.

Initial Setup

- When a subwoofer is connected to the rear output, set for subwoofer **SUB. W.**
- When the rear output setting is **SUB. W.**, you cannot change the subwoofer controller.

3 Touch ◀ or ▶ on the PREOUT setting to switch the subwoofer output or non fading output.

Touch ◀ to select subwoofer output and **SUB.W** appears in the display. Touch ▶ to select non fading output and **FULL** appears in the display.

Notes

- Even if you change this setting, there is no output unless you turn the nonfading output (refer to *Using nonfading output* on page 86) or subwoofer output (refer to *Using subwoofer output* on page 86) in the audio menu on.
- If you change the subwoofer controller, subwoofer output and nonfading output in the audio menu return to the factory settings. 

Switching the sound muting/attenuation

Sound from this system is muted, attenuated or mixed automatically in the following cases:

- When a call is made or received using a cellular telephone connected to this unit.
- When the voice guidance is output from a Pioneer navigation unit connected to this unit.

● Touch TEL/GUIDE on the initial menu to select any of the muting, attenuation or off.

Touch **TEL/GUIDE** until the desired setting appears in the display.

- **MUTE** – Muting
- **ATT-20dB** – Attenuation (**ATT-20dB** has a stronger effect than **ATT-10dB**)

- **ATT-10dB** – Attenuation
- **OFF** – Turn the sound muting/attenuation off

Notes

- The sound is muted or attenuated. **MUTE** or **ATT** are displayed and no audio adjustment is possible.
- Operation returns to normal when the phone connection or the voice guidance is ended. 

Mixing navigation voice/AVG-VDP1 beep and audio sound

Mixing navigation voice/beep and audio sound

When there is a navigation guidance, you can mix the guidance voice/beep sound from a Pioneer navigation unit with the audio sound from this system. You can select either mixing both the guidance voice and the beep sound or the guidance voice only.

- You can operate this function only when a Pioneer navigation unit is connected to this unit.
- When the multi-channel processor (e.g., DEQ-P8000) is connected to this unit, you cannot use this function.
- We recommend that you select **GUIDE** to ensure quality sound.

● Touch NAVI MIX on the initial menu to switch the mixing of navigation voice/beep.

Touching **NAVI MIX** will switch the mixing of navigation between **ALL** (mixing both guidance voice and beep) and **GUIDE** (mixing guidance voice only).

Initial Setup

Mixing AVG-VDP1 beep and audio sound

When connecting the AVG-VDP1 to this unit, a beep sound is occasionally outputted from the AVG-VDP1. To ensure the quality audio sound from this unit, set this function to **GUIDE** to properly mix the beep sound and the audio sound.

- You can operate this function only when a Pioneer Vehicle Dynamics Processor (AVG-VDP1) is connected to this unit.
- When the multi-channel processor (e.g., DEQ-P8000) is connected to this unit, you cannot use this function.
- We recommend that you select **GUIDE** to ensure quality sound.

- **Touch NAVI MIX on the initial menu to switch the mixing of AVG-VDP1 beep.**

Touching **NAVI MIX** switches the mixing settings between **ALL** (mixing all the time) and **GUIDE** (mixing when a beep sound is outputted).

Correcting distorted sound

You can minimize distortion that may be caused by the equalizer curve settings. Setting an equalizer level high can cause distortion. If high sound is crippled or distorted, try switching to **LOW**. Normally, leave the setting at **HIGH** to ensure quality sound.

- Only when the multi-channel processor (e.g., DEQ-P8000) is connected to this unit, you can operate this function.

- **Touch D. ATT on the initial menu to switch the digital attenuator setting.**

Touching **D. ATT** switches the digital attenuator settings in the following order:

HIGH—LOW

Changing languages for CAUTION

Some operations on this unit are prohibited while driving or needs to be paid a careful attention when operating. In such case, a caution appears on the display. You can change the language of the cautions at this setting.

- **Touch CAUTION on the initial menu to select your desired language.**

Each time you touch **CAUTION**, the language for CAUTION is switched.

Resetting the audio functions

You can reset all audio functions except volume.

- Only when the multi-channel processor (e.g., DEQ-P8000) is connected to this unit, you can operate this function.

- 1 Touch RESET on the initial menu.**

Proceed with reset? appears and asks you to confirm it.

- 2 Touch RESET again to reset audio functions.**

Reset completed is displayed and the audio settings are reset.

- To cancel resetting the audio functions, touch **CANCEL**.

Entering PIN code for Bluetooth wireless connection

With some Bluetooth audio players, you may be required to enter to this unit in advance PIN code of your Bluetooth audio player, in order to set this unit ready for a connection from your Bluetooth audio player.

Initial Setup

- Only when Bluetooth adapter (e.g. CD-BTB100) is connected to this unit, you can operate this function.

1 Touch PIN code input on the initial menu.

PIN code input display appears.

2 Touch 0—9 to input the PIN code of your Bluetooth audio player.

- Touch **C** to delete the number.

3 After inputting PIN code (up to 16 digits), touch ENTER.

The PIN code you entered is stored in this unit.

Extending the vehicle's antenna

At the standard setting, the antenna of your vehicle is automatically retracted when you select the source **OFF** or when the ignition switch is at ACC. At this setting, the source remains **OFF** even when you receive an incoming call through Bluetooth adapter (e.g. CD-BTB100). If you want to take the incoming calls you receive on the **OFF** source, turn **AUTO ANT MODE** off. The **OFF** source will be switched to **Telephone** and the antenna of your vehicle will be extended when this unit receives an incoming call.

- Only when Bluetooth adapter (e.g. CD-BTB100) is connected to this unit, you can operate this function.

● Touch **AUTO ANT MODE** on the initial menu to turn the auto antenna mode off.

The vehicle's antenna will be extended and the source will be switched to **Telephone** every time you receive an incoming call.

- To turn the auto antenna mode on, touch **AUTO ANT MODE** again.

Other Functions

Adjusting the screen

Changing the wide screen mode

You can select a desired mode for enlarging a 4:3 picture to a 16:9 one.

● Press **WIDE** to select the desired setting.

Press **WIDE** repeatedly to switch between the following settings:

FULL (full)—**JUST** (just)—**CINEMA** (cinema)—**ZOOM** (zoom)—**NORMAL** (normal)

- When AVG-VDP1 is connected to this unit, press **WIDE** and hold to select a desired screen mode. Pressing and holding **WIDE** repeatedly switches between the settings.

FULL (full)

A 4:3 picture is enlarged in the horizontal direction only, giving you a 4:3 TV picture (normal picture) without any omissions.

JUST (just)

The picture is enlarged slightly at the center and the amount of enlargement increases horizontally to the ends, enabling you to enjoy a 4:3 picture without sensing any disparity even on a wide screen.

CINEMA (cinema)

The picture is enlarged by the same proportion as **FULL** or **ZOOM** in the horizontal direction and by an intermediate proportion between **FULL** and **ZOOM** in the vertical direction; ideal for a cinema-sized picture (wide screen picture) where captions lie outside.

ZOOM (zoom)

A 4:3 picture is enlarged in the same proportion both vertically and horizontally; ideal for a cinema-sized picture (wide screen picture).

NORMAL (normal)

A 4:3 picture is displayed as it is, giving you no sense of disparity since its proportions are the same as that of the normal picture.



Notes

- Different settings can be memorized for each video source.
- When video is viewed in a wide screen mode that does not match its original aspect ratio, it may appear different.
- Remember that using the wide mode feature of this system for commercial or public viewing purposes may constitute an infringement on the author's rights protected by the Copyright Law.
- Video will appear grainy when viewed in **CINEMA** or **ZOOM** mode.

Changing the picture adjustment

Bright, contrast, color and hue

You can adjust **BRIGHT** (brightness), **CONTRAST** (contrast), **COLOR** (color) and **HUE** (hue) for each source and rear view camera.

- The adjustments of **BRIGHT** and **CONTRAST** are stored separately for light ambient (daytime) and dark ambient (night-time).
- You cannot adjust **HUE** for PAL video.
- You cannot adjust **COLOR** or **HUE** for the audio source.

1 Press **V.ADJ** and hold to display **PICTURE ADJUST**.

Press **V.ADJ** and hold until **PICTURE ADJUST** appears in the display.

2 Touch any of the following touch panel keys to select the function to be adjusted.

The adjustment function names are displayed and adjustable ones are highlighted.

- **BRIGHT** – Adjust the black intensity
- **CONTRAST** – Adjust the contrast
- **COLOR** – Adjust the color saturation
- **HUE** – Adjust the tone of color (red is emphasized or green is emphasized)
- **BACK-CAMERA/SOURCE** – Switch the picture adjustment modes
 - You can adjust the picture adjustment for rear view camera only when **B. CAMERA** is selected for **B.CAMERA**. (Refer to *Setting for rear view camera (back up camera)* on page 101.)
 - If you are viewing image from the rear view camera, you cannot touch **SOURCE** to adjust picture adjustment for the selected source.
 - With some rear view cameras, picture adjustment may not be possible.

3 Touch ◀ or ▶ to adjust the selected item.

Each time you touch ◀ or ▶ it increases or decreases the level of selected item. **+24** to **-24** is displayed as the level is increased or decreased.

4 Touch ESC to hide the touch panel keys.

Dimmer

The adjustment of **DIMMER** is stored separately for each ambient light; daytime, evening and nighttime.

1 Press V.ADJ and hold to display PICTURE ADJUST.

Press **V.ADJ** and hold until **PICTURE ADJUST** appears in the display.

2 Touch DIMMER.

3 Touch ◀ or ▶ to adjust the brightness.

Each time you touch ◀ or ▶ moves the key towards the left or the right.

The level indicates the brightness of the screen being adjusted. The farther the key moves to the right, the brighter the screen.

4 Touch ESC to hide the touch panel keys.



Note

The icons indicating the current ambient brightness used for adjusting **BRIGHT** and **CONTRAST** may differ from **DIMMER** slightly. 

Selecting the background display

You can display the thumbnails of available background pictures/movies and select one to set your background display. The selection can be made each for the audio source group (playing CD, listening to Tuner, using telephone source, etc.) and the movie source group (watching DVD, AV, etc.).

1 Press ENTERTAINMENT (ENT).

Thumbnails of background pictures/movies appear on the display.

- To go to the next group of thumbnails, touch **NEXT**.
- To return to the previous group of thumbnails, touch **PREV**.

2 Touch one of the thumbnails that you want to display in the background.

The selected picture/movie is displayed at the background.



Note

In the following cases, background images from that source cannot be selected:

- When the AV input setting is not set to **VIDEO** (refer to page 101).
- When a Pioneer navigation unit or the AVG-VDP1 is not connected to this unit. 

Adjusting the response positions of the touch panels (Touch Panel Calibration)

If you feel that the touch panel keys on the screen deviate from the actual positions that respond to your touch, adjust the response positions of the touch panel. There are two adjustment methods: 4-point adjustment, in which you touch four corners of the screen; and 16-point adjustment, in which you make fine-adjustments on the entire screen.

- Make sure to use the supplied pen for adjustment, and gently touch the screen. If you press the touch panel forcefully, the touch panel may be damaged. Do not use a sharp pointed tool such as ballpoint pen or a mechanical pen. Otherwise the screen is damaged.

1 Touch the source icon and then touch OFF to turn this unit off.

- When the source icon is not displayed, you can display it by touching the screen.

2 Press and hold BAND.

The 4-point touch panel adjustment screen appears.

3 Touch each of the arrows on the four corners of the screen with the touch panel adjustment pen.

Arrows you touch turn red.

- If the arrows are not turned red, the 4-point adjustment cannot be complete. Touch each arrow for adjustment and complete, or cancel the adjustment to return to the OFF display.
- To cancel the adjustment, press **V.ADJ.**

4 Press BAND to complete the 4-point adjustment.

The adjusted position data is saved.

- Do not turn off the engine while saving the adjusted position data.

5 Press BAND to proceed to the 16-point adjustment.

The 16-point touch panel adjustment screen appears.

- To cancel the adjustment, press **V.ADJ.**

6 Gently touch the center of the + mark displayed on the screen with the touch panel adjustment pen.

After you touch all the marks, the adjusted position data is saved.

- Do not turn off the engine while saving the adjusted position data.

7 To complete the adjustment, press V.ADJ.

- To restart the 16-point adjustment, press **BAND.**



Note

If touch panel adjustment cannot be performed properly, consult your local Pioneer dealer. 

Displaying the navigation image

You can display navigation map and navigation menu on this display.

- You can operate these functions only when a Pioneer navigation unit is connected to this unit.

Displaying navigation map

● Press WIDE to display navigation map.

- When the map is scrolled, pressing this button returns to the display of the map of your surroundings.

Displaying navigation menu

- Press **ENTERTAINMENT (ENT)** to display navigation menu when the navigation map is displayed.

Switching to the navigation image

- Press **V.ADJ** to switch the display to navigation image.
 - To return to the video of sources, press **V.ADJ** again. 

Displaying the AVG-VDP1 (Pioneer Vehicle Dynamics Processor)

This unit can be used as the display unit for the AVG-VDP1 (sold separately) product.

- You can operate this function only when a Pioneer Vehicle Dynamics Processor (AVG-VDP1) is connected to this unit.
- Press **V.ADJ** to switch the display to the **AVG-VDP1**.
 - To return to the video of sources, press **V.ADJ** again. 

Using the AUX source

This unit can control an auxiliary equipment such as VCR or portable device (sold separately). When connected, auxiliary equipment is automatically read in as AUX source and assigned to **AUX**.

About AUX connection method

You have two methods to connect auxiliary equipment to this unit.

Stereo mini pin plug cable

When connecting auxiliary equipment using a stereo mini plug cable

- Insert the stereo mini plug into the **AUX input jack on this unit**.
For more details, refer to the installation manual.

IP-BUS-RCA interconnector

When connecting auxiliary equipment using an IP-BUS-RCA Interconnector (sold separately)

- Use an **IP-BUS-RCA Interconnector such as the CD-RB20/CD-RB10 (sold separately) to connect this unit to auxiliary equipment featuring RCA output**.
For more details, refer to the IP-BUS-RCA Interconnector owner's manual.
 - You can only make this type of connection if the auxiliary equipment has RCA outputs.

Selecting AUX as the source

- **Touch the source icon and then touch AUX to select AUX as the source.**
 - When the source icon is not displayed, you can display it by touching the screen.
 - If the auxiliary setting is not turned on, **AUX** cannot be selected. For more details, see *Switching the auxiliary setting* on page 107.

Setting the AUX title

The title displayed for the **AUX** source can be changed.

- 1 **After you have selected AUX as the source, press A.MENU button and touch FUNCTION and then touch EDIT.**

Other Functions

2 Touch ABC to select the desired character type.

Touch **ABC** repeatedly to switch between the following character types:

Alphabet (upper case), numbers and symbols —alphabet (lower case)—European letters, such as those with accents (e.g., **á, à, ä, ç**)

■ You can select to input numbers and symbols by touching **123**.

3 Touch ▲ or ▼ to select a letter of the alphabet.

Each time you touch **▲** it will display alphabet, numbers or symbols in ascending order (**A B C ...**). Each time you touch **▼** it will display a letter in descending order.

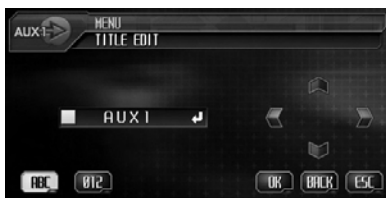

4 Touch ► to move the cursor to the next character position.

When the desired letter is displayed, touch **►** to move the cursor to the next position and then select the next letter. Touch **◀** to move backwards in the display.

5 Touch OK to store the entered title in memory.

6 Touch ESC to return to the playback display. ◻

Setting remote control code type

Changing the remote control operation switch to **DVD** mode enables you to operate the built-

in DVD player with the supplied remote control. There are three remote codes for **DVD** mode, code type **A**, code type **B** and code type **AVH**. However, when operating this unit, use the code type **AVH** only.

- With this unit, code **A** and **B** cannot be used.

1 Set the remote control selection switch on the left side of the remote control to the appropriate position with a pen tip or other pointed instrument .

- If you select **AVH** mode, there is no need to take the following procedure.
- If you select **A/B** and if in case you need to operate other Pioneer units (may be available in the future), take the following procedure and change the code type to the appropriate type.

2 Press 0 and CLEAR on the remote control simultaneously to change the code type.

Initially, the code type is set to **A**. Each time you press **0** and **CLEAR** simultaneously on the remote control the code type switches between **A** and **B**. ◻

Using the preprogrammed function

You can operate the preprogrammed functions for each source by using **PGM**.

- In order to use **PGM** button for preprogrammed function, the remote control operation mode switch should be set to **AVH**.
- Press **PGM** to turn pause on when selecting the following sources:
 - **DVD-V** – Built-in DVD player
 - **M-CD** – Multi-CD player
 - **iPod** – iPod
 - **BT Audio** – Bluetooth Audio

- To turn pause off, press **PGM** again.

- **Press PGM and hold to turn BSM on when selecting TUNER as the source.**
Press **PGM** and hold until the BSM turns on.
 - To cancel the storage process, press **PGM** again.

- **Press PGM and hold to turn BSSM on when selecting TV as the source.**
Press **PGM** and hold until the BSSM turns on.
 - To cancel the storage process, press **PGM** again.

- **Press PGM to switch the channel select modes when selecting XM or SIRIUS as the source.**
Press **PGM** repeatedly to switch between **ALL CH** and **CATEGORY**. 

Additional Information

Troubleshooting

Common

Symptom	Cause	Action (See)
Power doesn't turn on. The unit doesn't operate.	Leads and connectors are incorrectly connected.	Confirm once more that all connections are correct.
	The fuse is blown.	Rectify the reason for the fuse blowing, then replace the fuse. Be very sure to install the correct fuse with the same rating.
	Noise and other factors are causing the built-in microprocessor to operate incorrectly.	Press RESET . (Page 13)
Playback is not possible.	The disc is dirty.	Clean disc. (Page 121)
	The loaded disc is a type this unit cannot play.	Check what type the disc is.
	Non compatible video system disc is loaded.	Change to a disc compatible to your video system.
No sounds are heard. The volume level will not rise.	Cables are not connected correctly.	Connect the cables correctly.
	The unit is performing still, slow motion or frame-by-frame playback.	There is no sound during still, slow motion or frame-by-frame playback.
There is no picture.	The parking brake cord is not connected.	Connect a parking brake cord, and apply the parking brake.
	The parking brake is not applied.	Connect a parking brake cord, and apply the parking brake.
The icon  is displayed, and operation is not possible.	The operation is prohibited for the disc.	This operation is not possible.
	The operation is not compatible with the disc's organization.	This operation is not possible.
The picture stops (pauses) and the unit cannot be operated.	Reading of data has become impossible during playback.	After pressing ■ once, start playback once more.
There is no sound. Volume level is low.	The volume level is low.	Adjust the volume level.
	The attenuator is on.	Turn the attenuator off.
There is audio and video skipping.	The unit is not firmly secured.	Secure the unit firmly.
The picture is stretched, the aspect is incorrect.	The aspect setting is incorrect for the display.	Select the appropriate setting for your display. (Page 105)
When the ignition switch is turned ON (or turned to ACC), the motor sounds.	The unit is confirming whether a disc is loaded or not.	This is a normal operation.
Nothing is displayed. The touch panel keys cannot be used.	The rear view camera is not connected. B.CAMERA is at incorrect setting.	Connect a rear view camera. Press V.ADJ to return to the source display and then select the correct setting for B.CAMERA . (Page 101)

Additional Information

Problems during DVD playback

Symptom	Cause	Action (See)
Playback is not possible.	The loaded disc has a different region number from this unit.	Replace the disc with one featuring the same region number as this unit. (Page 9, Page 129)
A parental lock message is displayed and playback is not possible.	Parental lock is on.	Turn parental lock off or change the level. (Page 105)
Parental lock cannot be canceled.	The code number is incorrect.	Input the correct code number. (Page 105)
	You have forgotten your code number.	Press CLEAR 10 times to cancel the code number. (Page 106)
Dialog language (and subtitle language) cannot be switched.	The DVD playing does not feature multiple language recordings.	You cannot switch among multiple languages if they are not recorded on the disc.
	You can only switch between items indicated in the disc menu.	Switch using the disc menu.
No subtitles are displayed.	The DVD playing does not feature subtitles.	Subtitles are not displayed if they are not recorded on the disc.
	You can only switch between items indicated in the disc menu.	Switch using the disc menu.
Playback is not with the audio language and subtitle language settings selected in DVD SETUP .	The DVD playing does not feature dialog or subtitles in the language selected in DVD SETUP .	Switching to a selected language is not possible if the language selected in DVD SETUP is not recorded on the disc.
Switching the viewing angle is not possible.	The DVD playing does not feature scenes shot from multiple angles.	You cannot switch between multiple angles if the DVD does not feature scenes recorded from multiple angles.
	You are trying to switch to multiple angle viewing of a scene that is not recorded from multiple angles.	Switch between multiple angles when watching scenes recorded from multiple angles.
The picture is extremely unclear/distorted and dark during playback.	The disc features a signal to prohibit copying. (Some discs may have this.)	Since this unit is compatible with the copy guard analog copy protect system, when playing a disc that has a signal prohibiting copying, the picture may suffer from horizontal stripes or other imperfections when viewed on some displays. This does not mean this unit is malfunctioning.

Problems during Video CD playback

Symptom	Cause	Action (See)
The PBC (playback control) menu display cannot be called up.	The Video CD playing does not feature PBC.	This operation is not possible with Video CDs not featuring PBC.
Repeat play and track/time search are not possible.	The Video CD playing features PBC.	This operation is not possible with Video CDs featuring PBC.



Additional Information

Error messages

When you contact your dealer or your nearest Pioneer Service Center, be sure to record the error message.

Message	Cause	Action (See)
ERROR-02	Dirty disc	Clean disc.
	Scratched disc	Replace disc.
	The disc is loaded upside down	Check that the disc is loaded correctly.
ERROR-05	Electrical or mechanical	Press RESET .
ERROR-A0	Electrical or mechanical	Consult your dealer or your nearest authorized Pioneer Service Station.
DIFFERENT REGION DISC	The disc does not have the same region number as this unit	Replace the DVD video with one bearing the correct region number.
NON PLAYABLE DISC (NON-PLAY)	This type of disc cannot be played by this unit	Replace the disc with one this unit can play.
TEMPERATURE PROTECTION IN MOTION	The temperature of this unit is outside the normal operating range	Wait until the unit's temperature returns to within normal operating limits.
PROTECT	All the files on the inserted disc are secured by digital rights management (DRM)	Replace disc.
TRACK SKIPPED	The inserted disc contains WMA files that are protected by digital rights management (DRM)	Replace disc.



Understanding auto TA and EQ error messages

When correct measurement of car interior acoustic characteristics is not possible using the auto TA and EQ, an error message may appear on the display. If an error message appears, refer to the table below to see what the problem is and the suggested method of correcting the problem. After checking, try again.

Message	Cause	Action
Error check MIC	Microphone is not connected.	Plug the supplied microphone securely into the jack.
Error check front SP, Error check FL SP, Error check FR SP, Error check center SP, Error check RL SP, Error check RR SP, Error check subwoofer	The microphone cannot pick up the measuring tone of a speaker.	<ul style="list-style-type: none"> • Confirm that the speakers are connected correctly. • Correct the input level setting of the power amp connected to the speakers. • Set the microphone correctly.

Additional Information

Message	Cause	Action
Error check noise	The surrounding noise level is too high.	<ul style="list-style-type: none">• Stop your car in a place that is as quiet as possible, and switch off the engine, air conditioner or heater.• Set the microphone correctly.



Additional Information

DVD player and care

- Use only normal, round discs. If you insert irregular, non-round, shaped discs they may jam in the DVD player or not play properly.

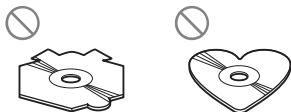

- Check all discs for cracks, scratches or warping before playing. Discs that have cracks, scratches or are warped may not play properly. Do not use such discs.
- Avoid touching the recorded (non-printed) surface when handling the disc.
- Store discs in their cases when not in use.
- Keep discs out of direct sunlight and do not expose the discs to high temperatures.
- Do not attach labels, write on or apply chemicals to the surface of the discs.
- To clean a disc, wipe the disc with a soft cloth outward from the center.



- If the heater is used in cold weather, condensation may form on components inside the DVD player. Condensation may cause the DVD player to not operate properly. If you think that condensation is a problem turn off the DVD player for an hour or so to allow it to dry out and wipe any damp discs with a soft cloth to remove the moisture.
- Road shocks may interrupt disc playback.
- The DVD player plays one, standard 12-cm disc at a time. Playing back an 8-cm disc is not possible with this unit. Playable disc and adapter are listed in the table below.

12-cm disc	8-cm disc	8-cm disc adapter
√	—	—



DVD discs

- With some DVD video discs, it may not be possible to use certain functions.
- It may not be possible to play back some DVD video discs.
- When DVD-R/DVD-RW discs are used, playback is possible only for discs which have been finalized.
- When DVD-R/DVD-RW discs are used, playback is possible only for discs which have been recorded with the Video format (video mode). It is not possible to play back DVD-RW discs which have been recorded with the Video Recording format (VR mode).
- It may not be possible to play back DVD-R/DVD-RW discs which have been recorded with the Video format (video mode), because of disc characteristics, scratches or dirt on the disc, or dirt, condensation, etc. on the lens of this unit.
- It is not possible to play back DVD-ROM/DVD-RAM discs.
- Playback of discs recorded on a personal computer may not be possible, depending on the application settings and the environment. Please record with the correct format. (For details, contact the manufacturer of the application.)

CD-R/CD-RW discs

- When CD-R/CD-RW discs are used, playback is possible only for discs which have been finalized.

Additional Information

- It may not be possible to play back CD-R/CD-RW discs recorded on a music CD recorder or a personal computer because of disc characteristics, scratches or dirt on the disc, or dirt, condensation, etc., on the lens of this unit.
- Playback of discs recorded on a personal computer may not be possible, depending on the application settings and the environment. Please record with the correct format. (For details, contact the manufacturer of the application.)
- Playback of CD-R/CD-RW discs may become impossible in case of direct exposure to sunlight, high temperatures, or the storage conditions in the vehicle.
- Titles and other text information recorded on a CD-R/CD-RW disc may not be displayed by this unit (in the case of audio data (CD-DA)).
- This unit conforms to the track skip function of the CD-R/CD-RW disc. The tracks containing the track skip information are skipped automatically (in case of audio data (CD-DA)).
- If you insert a CD-RW disc into this unit, time to playback will be longer than when you insert a conventional CD or CD-R disc.
- Read the precautions with CD-R/CD-RW discs before using them. 

Dual Discs

- Dual Discs are two-sided discs that have a recordable CD for audio on one side and a recordable DVD for video on the other.
- Playback of the DVD side is possible with this unit. However, since the CD side of Dual Discs is not physically compatible with the general CD standard, it may not be possible to play the CD side with this unit.
- Frequent loading and ejecting of a Dual Disc may result in scratches on the disc.

Serious scratches can lead to playback problems on this unit. In some cases, a Dual Disc may become stuck in the disc loading slot and will not eject. To prevent this, we recommend you refrain from using Dual Disc with this unit.

- Please refer to the information from the disc manufacturer for more detailed information about Dual Discs. 

MP3 and WMA files

- MP3 is short for MPEG Audio Layer 3 and refers to an audio compression technology standard.
- WMA is short for Windows Media™ Audio and refers to an audio compression technology that is developed by Microsoft Corporation. WMA data can be encoded by using Windows Media Player version 7 or later.
- This unit may not operate correctly depending on the application used to encode WMA files.
- Depending on the version of Windows Media Player used to encode WMA files, album names and other text information may not be correctly displayed.
- This unit allows playback of MP3/WMA files on CD-ROM, CD-R and CD-RW discs. Disc recordings compatible with level 1 and level 2 of ISO9660 and with the Romeo and Joliet file system can be played back.
- It is possible to play back multi-session compatible recorded discs.
- MP3/WMA files are not compatible with packet write data transfer.
- The maximum number of characters which can be displayed for a file name, including the extension (.mp3 or .wma), is 64, from the first character.
- The maximum number of characters which can be displayed for a folder name is 64.

Additional Information

- In case of files recorded according to the Romeo file system, only the first 64 characters can be displayed.
- When playing discs with MP3/WMA files and audio data (CD-DA) such as CD-EXTRA and MIXED-MODE CDs, both types can be played only by switching mode between MP3/WMA and CD-DA.
- The folder selection sequence for playback and other operations becomes the writing sequence used by the writing software. For this reason, the expected sequence at the time of playback may not coincide with the actual playback sequence. However, there also is some writing software which permits setting of the playback order.
- Some audio CDs contain tracks that merge into one another without a pause. When these discs are converted to MP3/WMA files and burned to a CD-R/CD-RW/CD-ROM, the files will be played back on this player with a short pause between each one, regardless of the length of the pause between tracks on the original audio CD.



Important

- When naming an MP3 or a WMA file, add the corresponding filename extension (.mp3 or .wma).
- This unit plays back files with the filename extension (.mp3 or .wma) as an MP3 or a WMA file. To prevent noise and malfunctions, do not use these extensions for files other than MP3 or WMA files.

MP3 additional information

- Files are compatible with the ID3 Tag Ver. 1.0, 1.1, 2.2 and 2.3 formats for display of album (disc title), track (track title), artist (track artist) and comments. Ver. 2.x of ID3 Tag is given priority when both Ver. 1.x and Ver. 2.x exist.
- The emphasis function is valid only when MP3 files of 32, 44.1 and 48 kHz frequencies are played back. (16, 22.05, 24, 32, 44.1, 48 kHz sampling frequencies can be played back.)
- There is no m3u playlist compatibility.
- There is no compatibility with the MP3i (MP3 interactive) or mp3 PRO formats.
- The sound quality of MP3 files generally becomes better with an increased bit rate. This unit can play recordings with bit rates from 8 kbps to 320 kbps, but in order to be able to enjoy sound of a certain quality, we recommend using only discs recorded with a bit rate of at least 128 kbps.

WMA additional information

- This unit plays back WMA files encoded by Windows Media Player version 7 and 8.
- You can only play back WMA files in the frequencies 32, 44.1 and 48 kHz.
- The sound quality of WMA files generally becomes better with an increased bit rate. This unit can play recordings with bit rates from 48 kbps to 192 kbps, but in order to be able to enjoy sound of a certain quality, we recommend using discs recorded with a higher bit rate.
- This unit does not play back WMA files recorded as VBR (variable bit rate).

Additional Information

About folders and MP3/WMA files

- An outline of a CD-ROM with MP3/WMA files on it is shown below. Subfolders are shown as folders in the folder currently selected.

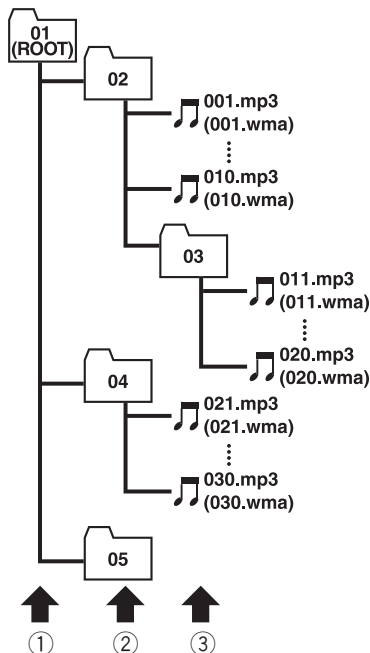

- ① First level
- ② Second level
- ③ Third level

Notes

- This unit assigns folder numbers. The user cannot assign folder numbers.
- It is not possible to check folders that do not include MP3/WMA files. (These folders will be skipped without displaying the folder number.)

- MP3/WMA files in up to 8 tiers of folders can be played back. However, there is a delay in the start of playback on discs with numerous tiers. For this reason we recommend creating discs with no more than 2 tiers.
- It is possible to play back up to 253 items from folders on one disc. 

Using the display correctly

CAUTION

- If liquid or foreign matter should get inside this unit, turn off the power immediately and consult your dealer or the nearest authorized PIONEER Service Station. Do not use the unit in this condition because doing so may result in a fire, electric shock, or other failure.
- If you notice smoke, a strange noise or smell, or any other abnormal signs from the display, turn off the power immediately and consult your dealer or the nearest authorized PIONEER Service Station. Using this unit in this condition may result in permanent damage to the system.
- Do not disassemble or modify this unit, as there are high-voltage components inside which may cause an electric shock. Be sure to consult your dealer or the nearest authorized PIONEER Service Station for internal inspection, adjustments or repairs.

Handling the display

- When the display is subjected to direct sunlight for a long period of time, it will become very hot resulting in possible damage to the LCD screen. When not using this unit, close the display and avoid exposing it to direct sunlight.
- The display should be used within the temperature ranges shown below.

Additional Information

Storage temperature range: -20°C to $+80^{\circ}\text{C}$

At temperatures higher or lower than the operating temperature range the display may not operate normally.

- The LCD screen of this unit is exposed in order to increase its visibility within the vehicle. Please do not press strongly on it as this may damage it.
- Do not place anything on the display when it is opened. Also, do not attempt to carry out angle adjustment, or open/close the display by hand. Applying strong force to the display may damage it.
- Do not push the LCD screen with much force as this may scratch it.
- Be careful not to place anything between the display and the main body when the display is opening or closing. If an object gets between the display and main body, the display may stop working.
- Be careful of fingers, long hair, and loose articles of clothing which could possibly get caught between the display and the main body and cause serious injury.

Liquid crystal display (LCD) screen

- If the display is near the vent of an air conditioner when it is opened, make sure that air from the air conditioner is not blowing on it. Heat from the heater may damage the LCD screen, and cool air from the cooler may cause moisture to form inside the display resulting in possible damage. Also, if the display is cooled down by the cooler, the screen may become dark, or the life span of the small fluorescent tube used inside the display may be shortened.
- Small black dots or white dots (bright dots) may appear on the LCD screen. These are due to the characteristics of the LCD screen and do not indicate a problem with the display.

- At low temperatures, the LCD screen may be dark for a while after the power is turned on.
- The LCD screen will be difficult to see if it is exposed to direct sunlight.
- When using a portable phone, keep the antenna of the portable phone away from the display to prevent disruption of the video by the appearance of spots, colored stripes, etc.

Keeping the display in good condition

- When wiping the screen, take care not to scratch the surface. Do not use harsh or abrasive chemical cleaners.

Small fluorescent tube

- A small fluorescent tube is used inside the display to illuminate the LCD screen.
 - The fluorescent tube should last for approximately 10 000 hours, depending on operating conditions. (Using the display at low temperatures reduces the service life of the fluorescent tube.)
 - When the fluorescent tube reaches the end of its useful life, the screen will be dark and the image will no longer be projected. If this happens, consult your dealer or the nearest authorized PIONEER Service Station. 

Additional Information

Language code chart for DVD

Language (code), input code	Language (code), input code	Language (code), input code
Japanese (ja), 1001	Guarani (gn), 0714	Pashto, Pushto (ps), 1619
English (en), 0514	Gujarati (gu), 0721	Quechua (qu), 1721
French (fr), 0618	Hausa (ha), 0801	Rhaeto-Romance (rm), 1813
Spanish (es), 0519	Hindi (hi), 0809	Kirundi (rn), 1814
German (de), 0405	Croatian (hr), 0818	Romanian (ro), 1815
Italian (it), 0920	Hungarian (hu), 0821	Kinyarwanda (rw), 1823
Chinese (zh), 2608	Armenian (hy), 0825	Sanskrit (sa), 1901
Dutch (nl), 1412	Interlingua (ia), 0901	Sindhi (sd), 1904
Portuguese (pt), 1620	Interlingue (ie), 0905	Sangho (sg), 1907
Swedish (sv), 1922	Inupiak (ik), 0911	Serbo-Croatian (sh), 1908
Russian (ru), 1821	Indonesian (in), 0914	Sinhalese (si), 1909
Korean (ko), 1115	Icelandic (is), 0919	Slovak (sk), 1911
Greek (el), 0512	Hebrew (iw), 0923	Slovenian (sl), 1912
Afar (aa), 0101	Yiddish (ji), 1009	Samoan (sm), 1913
Abkhazian (ab), 0102	Javanese (jw), 1023	Shona (sn), 1914
Afrikaans (af), 0106	Georgian (ka), 1101	Somali (so), 1915
Amharic (am), 0113	Kazakh (kk), 1111	Albanian (sq), 1917
Arabic (ar), 0118	Greenlandic (kl), 1112	Serbian (sr), 1918
Assamese (as), 0119	Cambodian (km), 1113	Siswati (ss), 1919
Aymara (ay), 0125	Kannada (kn), 1114	Sesotho (st), 1920
Azerbaijani (az), 0126	Kashmiri (ks), 1119	Sundanese (su), 1921
Bashkir (ba), 0201	Kurdish (ku), 1121	Swahili (sw), 1923
Byelorussian (be), 0205	Kirghiz (ky), 1125	Tamil (ta), 2001
Bulgarian (bg), 0207	Latin (la), 1201	Telugu (te), 2005
Bihari (bh), 0208	Lingala (ln), 1214	Tajik (tg), 2007
Bislama (bi), 0209	Laothian (lo), 1215	Thai (th), 2008
Bengali (bn), 0214	Lithuanian (lt), 1220	Tigrinya (ti), 2009
Tibetan (bo), 0215	Latvian (lv), 1222	Turkmen (tk), 2011
Breton (br), 0218	Malagasy (mg), 1307	Tagalog (tl), 2012
Catalan (ca), 0301	Maori (mi), 1309	Setswana (tn), 2014
Corsican (co), 0315	Macedonian (mk), 1311	Tonga (to), 2015
Czech (cs), 0319	Malayalam (ml), 1312	Turkish (tr), 2018
Welsh (cy), 0325	Mongolian (mn), 1314	Tsonga (ts), 2019
Danish (da), 0401	Moldavian (mo), 1315	Tatar (tt), 2020
Bhutani (dz), 0426	Marathi (mr), 1318	Twi (tw), 2023
Esperanto (eo), 0515	Malay (ms), 1319	Ukrainian (uk), 2111
Estonian (et), 0520	Maltese (mt), 1320	Urdu (ur), 2118
Basque (eu), 0521	Burmese (my), 1325	Uzbek (uz), 2126
Persian (fa), 0601	Nauru (na), 1401	Vietnamese (vi), 2209
Finnish (fi), 0609	Nepali (ne), 1405	Volapük (vo), 2215
Fiji (fj), 0610	Norwegian (no), 1415	Wolof (wo), 2315
Faroese (fo), 0615	Occitan (oc), 1503	Xhosa (xh), 2408
Frisian (fy), 0625	Oromo (om), 1513	Yoruba (yo), 2515
Irish (ga), 0701	Oriya (or), 1518	Zulu (zu), 2621
Scots-Gaelic (gd), 0704	Panjabi (pa), 1601	
Galician (gl), 0712	Polish (pl), 1612	



Additional Information

Terms

Aspect ratio

This is the width-to-height ratio of a TV screen. A regular display has an aspect ratio of 4:3. Wide screen displays have an aspect ratio of 16:9, providing a bigger picture for exceptional presence and atmosphere.

Bit rate

This expresses data volume per second, or bps (bits per second) units. The higher the rate, the more information is available to reproduce the sound. Using the same encoding method (such as MP3), the higher the rate, the better the sound.

Bluetooth

Bluetooth is a short-range wireless radio connectivity technology that is developed as a cable replacement for mobile phones, handheld PCs and other devices. Bluetooth operates in 2.4 GHz frequency range and transmits voice and data at speeds up to 1 megabit per second. Bluetooth was launched by a special interest group (SIG) that comprises of Ericsson Inc., Intel Corp., Nokia Corp., Toshiba and IBM in 1998, and it is currently developed by nearly 2 000 companies worldwide.

Chapter

DVD titles are in turn divided into chapters which are numbered in the same way as the chapters of a book. With DVD video discs featuring chapters, you can quickly find a desired scene with chapter search.

Dolby Digital

Dolby Digital provides multi-channel audio from up to 5.1 independent channels. This is the same as the Dolby Digital surround sound system used in theaters.

Dolby Pro Logic II

Dolby Pro Logic II can create five full-bandwidth output channels from two-channel sources. This new technology enables a discrete 5-channel playback with 2 front channels, 1 center channel, and 2 rear channels. A music mode is also available for 2-channel sources in addition to the movie mode.

DTS

This stands for Digital Theater Systems. DTS is a surround system delivering multi-channel audio from up to 6 independent channels.

ID3 tag

This is a method of embedding track-related information in an MP3 file. This embedded information can include the track title, the artist's name, the album title, the music genre, the year of production, comments and other data. The contents can be freely edited using software with ID3 Tag editing functions. Although the tags are restricted as to the number of characters, the information can be viewed when the track is played back.

ISO9660 format

This is the international standard for the format logic of CD-ROM folders and files. For the ISO9660 format, there are regulations for the following two levels.

Level 1:

The file name is in 8.3 format (the name consists of up to 8 characters, half-byte English capital letters and half-byte numerals and the "_" sign, with a file-extension of three characters).

Level 2:

The file name can have up to 31 characters (including the separation mark "." and a file extension). Each folder contains less than 8 hierarchies.

Extended formats

Joliet:

File names can have up to 64 characters.

Additional Information

Romeo:

File names can have up to 128 characters.

Linear PCM (LPCM)/Pulse code modulation

This stands for linear pulse code modulation, which is the signal recording system used for music CDs and DVDs. Generally, DVDs are recorded with higher sampling frequency and bit rate than CDs. Therefore, DVDs can provide higher sound quality.

m3u

Playlists created using the "WINAMP" software have a playlist file extension (.m3u).

MP3

MP3 is short for MPEG Audio Layer 3. It is an audio compression standard set by a working group (MPEG) of the ISO (International Standards Organization). MP3 is able to compress audio data to about 1/10th the level of a conventional disc.

MPEG

This stands for Moving Pictures Experts Group, and is an international video image compression standard. Some DVDs feature digital audio compressed and recorded using this system.

Multi-angle

With regular TV programs, although multiple cameras are used to simultaneously shoot scenes, only images from one camera at a time are transmitted to your TV. Some DVDs feature scenes shot from multiple angles, letting you choose your viewing angle as desired.

Multi-audio (Multilingual dialog)

Some DVDs feature dialog recorded in multiple languages. Dialog in up to 8 languages can be recorded on a single disc, letting you choose as desired.

Multi-session

Multi-session is a recording method that allows additional data to be recorded later. When recording data on a CD-ROM, CD-R or CD-RW, etc., all data from beginning to end is treated as a single unit or session. Multi-session is a method of recording more than 2 sessions on one disc.

Multi-subtitle

Subtitles in up to 32 languages can be recorded on a single DVD, letting you choose as desired.

Optical digital output/input

By transmitting and receiving audio signals in a digital signal format, the chance of sonic quality deteriorating in the course of transmission is minimized. An optical digital output/input is designed to transmit and receive digital signals optically.

Packet write

This is a general term for a method of writing on CD-R, etc., at the time required for a file, just as is done with files on floppy or hard discs.

Parental lock

Some DVD video discs with violent or adult-oriented scenes feature parental lock which prevents children from viewing such scenes. With this kind of disc, if you set the unit's parental lock level, playback of scenes inappropriate for children will be disabled, or these scenes will be skipped.

Playback control (PBC)

This is a playback control signal recorded on Video CDs (Version 2.0). Using menu displays provided by Video CDs with PBC lets you enjoy playback of simple interactive software and software with search functions. You can also enjoy viewing high- and standard-resolution still images.

Additional Information

Region number

DVD players and DVD discs feature region numbers indicating the area in which they were purchased. Playback of a DVD is not possible unless it features the same region number as the DVD player. This unit's region number is displayed on the bottom of the unit.

Title

DVD video discs have high data capacity, enabling recording of multiple movies on a single disc. If, for example, one disc contains three separate movies, they are divided into title 1, title 2 and title 3. This lets you enjoy the convenience of title search and other functions.

VBR

VBR is short for variable bit rate. Generally speaking CBR (constant bit rate) is more widely used. But by flexibly adjusting the bit rate according to the needs of audio compression, it is possible to achieve compression-priority sound quality.

WMA

WMA is short for Windows Media™ Audio and refers to an audio compression technology that is developed by Microsoft Corporation. WMA data can be encoded by using Windows Media Player version 7 or later. Windows Media and the Windows logo are trademarks or registered trademarks of Microsoft Corporation in the United States and/or other countries. ■

Additional Information

Specifications

General

Rated power source	14.4 V DC (allowable voltage range: 12.0 V to 14.4 V DC)
Grounding system	Negative type
Max. current consumption	10.0 A
Dimensions (W × H × D): DIN	
Chassis	178 × 100 × 166 mm (7 × 3-7/8 × 6-1/2 in.)
Nose	171 × 96 × 16 mm (6-3/4 × 3-3/4 × 5/8 in.)
Weight	3.0 kg (6.6 lbs)

Display

Screen size/aspect ratio	7.0 inch wide/16:9 (effective display area: 156 × 82 mm)
Pixels	336,960 (1,440 × 234)
Type	TFT active matrix, transmis- sive type
Color system	NTSC compatible
Storage temperature range	-20 °C to +80 °C
Angle adjustment	0° to 21° (initial settings: 0°)

Audio

Continuous power output is 22 W per channel minimum into 4 ohms, both channels driven 50 to 15 000 Hz with no more than 5% THD.	
Maximum power output	50 W × 4 50 W × 2/4 Ω + 70 W × 1/2 Ω (for subwoofer)
Load impedance	4 Ω to 8 Ω × 4 4 Ω to 8 Ω × 2 + 2 Ω × 1
Preout max output level/output impedance	4.0 V/100 Ω
Equalizer (3-Band Parametric Equalizer): Low	
Frequency	40/80/100/160 Hz
Q Factor	0.35/0.59/0.95/1.15 (+6 dB when boosted)
Gain	±12 dB
Mid	
Frequency	200/500/1k/2k Hz
Q Factor	0.35/0.59/0.95/1.15 (+6 dB when boosted)

Gain	±12 dB
High	
Frequency	3.15k/8k/10k/12.5k Hz
Q Factor	0.35/0.59/0.95/1.15 (+6 dB when boosted)
Gain	±12 dB
Loudness contour:	
Low	+3.5 dB (100 Hz), +3 dB (10 kHz)
Mid	+10 dB (100 Hz), +6.5 dB (10 kHz)
High	+11 dB (100 Hz), +11 dB (10 kHz) (volume: -30 dB)
HPF:	
Frequency	50/80/125 Hz
Slope	-12 dB/oct
Subwoofer:	
Frequency	50/80/125 Hz
Slope	-18 dB/oct
Gain	±12 dB
Phase	Normal/Reverse

DVD Player

System	DVD video, Video CD, Com- pact disc audio system
Usable discs	DVD video, Video CD, Com- pact disc
Region number	1
Signal format:	
Sampling frequency	44.1/48/96 kHz
Number of quantization bits	16/20/24; linear
Frequency response	5 Hz to 44 000 Hz (with DVD, at sampling frequency 96 kHz)
Signal-to-noise ratio	97 dB (1 kHz) (IHF-A net- work) (CD: 96 dB (1 kHz) (IHF-A network))
Dynamic range	95 dB (1 kHz) (CD: 94 dB (1 kHz))
Distortion	0.008 % (1 kHz)
Output level:	
Video	1.0 Vp-p/75 Ω (±0.2 V)
Number of channels	2 (stereo)
MP3 decoding format	MPEG-1 & 2 Audio Layer 3
WMA decoding format	Ver. 7 & 8

FM tuner

Frequency range	87.9 MHz to 107.9 MHz
-----------------------	-----------------------

Additional Information

Usable sensitivity	8 dBf (0.7 μ V/75 Ω , mono, S/N: 30 dB)
50 dB quieting sensitivity	10 dBf (0.9 μ V/75 Ω , mono)
Signal-to-noise ratio	75 dB (IHF-A network)
Distortion	0.3 % (at 65 dBf, 1 kHz, stereo)
	0.1 % (at 65 dBf, 1 kHz, mono)
Frequency response	30 Hz to 15 000 Hz (\pm 3 dB)
Stereo separation	45 dB (at 65 dBf, 1 kHz)

AM tuner

Frequency range	530 kHz to 1 710 kHz (10 kHz)
Usable sensitivity	18 μ V (S/N: 20 dB)
Signal-to-noise ratio	65 dB (IHF-A network)



Note

Specifications and the design are subject to possible modifications without notice due to improvements. 

A

Angle icon 33, 104
Aspect ratio 105, 127
Audio language 32, 104

B

Bookmark 31
Brightness 111

C

Chapter 127
Code number 105
Color 111
Contrast 111

D

Direct search 32
Dolby Digital 127
Dolby Pro Logic II 127
DTS 127

H

Hue 111

L

Language code chart 126
Linear PCM (LPCM) 128

M

Menu language 104
MPEG 128
Multi-angle 33, 128
Multi-audio 32, 128
Multi-subtitle 33, 128

O

Optical digital output/input 128

P

Parental lock 105, 128
PBC (playback control) 36
Playback control (PBC) 128

R

Region number 9, 129

S

Subtitle language 33, 103

T

Title 129
TV aspect 105

V

Video CD 9

W

Wide screen mode 111

*Register your product at
Enregistrez votre produit au*

<http://www.pioneerelectronics.com>

*See "Product registration" page
Voir la page "Enregistrement du produit"*

PIONEER CORPORATION

4-1, MEGURO 1-CHOME, MEGURO-KU, TOKYO 153-8654, JAPAN

PIONEER ELECTRONICS (USA) INC.

P.O. Box 1540, Long Beach, California 90801-1540, U.S.A.
TEL: (800) 421-1404

PIONEER EUROPE NV

Haven 1087, Keetberglaan 1, B-9120 Melsele, Belgium
TEL: (0) 3/570.05.11

PIONEER ELECTRONICS ASIACENTRE PTE. LTD.

253 Alexandra Road, #04-01, Singapore 159936
TEL: 65-6472-7555

PIONEER ELECTRONICS AUSTRALIA PTY. LTD.

178-184 Boundary Road, Braeside, Victoria 3195, Australia
TEL: (03) 9586-6300

PIONEER ELECTRONICS OF CANADA, INC.

300 Allstate Parkway, Markham, Ontario L3R OP2, Canada
TEL: 1-877-283-5901

PIONEER ELECTRONICS DE MEXICO, S.A. de C.V.

Bvd.Manuel Avila Camacho 138 10 piso
Col.Lomas de Chapultepec, Mexico, D.F. 11000
TEL: 55-9178-4270

先鋒股份有限公司

總公司：台北市中山北路二段44號13樓
電話：(02) 2521-3588

先鋒電子（香港）有限公司

香港九龍尖沙咀海港城世界商業中心
9樓901-6室
電話：(0852) 2848-6488

Published by Pioneer Corporation.
Copyright © 2006 by Pioneer Corporation.
All rights reserved.

Printed in Japan

<CRB2171-A> UC

<KNNZF> <06D00000>

Free Manuals Download Website

<http://myh66.com>

<http://usermanuals.us>

<http://www.somanuals.com>

<http://www.4manuals.cc>

<http://www.manual-lib.com>

<http://www.404manual.com>

<http://www.luxmanual.com>

<http://aubethermostatmanual.com>

Golf course search by state

<http://golfingnear.com>

Email search by domain

<http://emailbydomain.com>

Auto manuals search

<http://auto.somanuals.com>

TV manuals search

<http://tv.somanuals.com>