

**Pioneer**

Operating Instructions

**ELITE**

audio/video multi-channel receiver

VSX-01 TXH

## FEDERAL COMMUNICATIONS COMMISSION DECLARATION OF CONFORMITY

This device complies with part 15 of the FCC Rules. Operation is subject to the following two conditions: (1) This device may not cause harmful interference, and (2) this device must accept any interference received, including interference that may cause undesired operation.

Product Name: AUDIO/VIDEO MULTI-CHANNEL RECEIVER  
Model Number: VSX-01TXH  
Responsible Party Name: PIONEER ELECTRONICS SERVICE, INC.  
Address: 1925 E. DOMINGUEZ ST. LONG BEACH, CA 90801-1760, U.S.A.  
Phone: 1-800-421-1404

**IMPORTANT NOTICE** – THE SERIAL NUMBER FOR THIS EQUIPMENT IS LOCATED IN THE REAR. PLEASE WRITE THIS SERIAL NUMBER ON YOUR ENCLOSED WARRANTY CARD AND KEEP IN A SECURE AREA. THIS IS FOR YOUR SECURITY.

D1-4-2-6-1\_En

**NOTE:** This equipment has been tested and found to comply with the limits for a Class B digital device, pursuant to Part 15 of the FCC Rules. These limits are designed to provide reasonable protection against harmful interference in a residential installation. This equipment generates, uses, and can radiate radio frequency energy and, if not installed and used in accordance with the instructions, may cause harmful interference to radio communications. However, there is no guarantee that interference will not occur in a particular installation. If this equipment does cause harmful interference to radio or television reception, which can be determined by turning the equipment off and on, the user is encouraged to try to correct the interference by one or more of the following measures:

- Reorient or relocate the receiving antenna.
- Increase the separation between the equipment and receiver.
- Connect the equipment into an outlet on a circuit different from that to which the receiver is connected.
- Consult the dealer or an experienced radio/TV technician for help.

D8-10-1-2\_En

This Class B digital apparatus complies with Canadian ICES-003.

Cet appareil numérique de la Classe B est conforme à la norme NMB-003 du Canada.

D8-10-1-3\_EF

### Information to User

Alteration or modifications carried out without appropriate authorization may invalidate the user's right to operate the equipment.

D8-10-2\_En

**CAUTION:** This product satisfies FCC regulations when shielded cables and connectors are used to connect the unit to other equipment. To prevent electromagnetic interference with electric appliances such as radios and televisions, use shielded cables and connectors for connections.

D8-10-3a\_En

### CAUTION

The **STANDBY/ON** switch on this unit will not completely shut off all power from the AC outlet. Since the power cord serves as the main disconnect device for the unit, you will need to unplug it from the AC outlet to shut down all power. Therefore, make sure the unit has been installed so that the power cord can be easily unplugged from the AC outlet in case of an accident. To avoid fire hazard, the power cord should also be unplugged from the AC outlet when left unused for a long period of time (for example, when on vacation).

### Operating Environment

Operating environment temperature and humidity:  
+5 °C to +35 °C (+41 °F to +95 °F); less than 85 %RH  
(cooling vents not blocked)

Do not install this unit in a poorly ventilated area, or in locations exposed to high humidity or direct sunlight (or strong artificial light)

D3-4-2-1-7c\_A\_En

### WARNING

To prevent a fire hazard, do not place any naked flame sources (such as a lighted candle) on the equipment.

D3-4-2-1-7a\_A\_En

### VENTILATION CAUTION

When installing this unit, make sure to leave space around the unit for ventilation to improve heat radiation (at least 60 cm at top, 10 cm at rear, and 30 cm at each side).

### WARNING

Slots and openings in the cabinet are provided for ventilation to ensure reliable operation of the product, and to protect it from overheating. To prevent fire hazard, the openings should never be blocked or covered with items (such as newspapers, table-cloths, curtains) or by operating the equipment on thick carpet or a bed.

D3-4-2-1-7b\_A\_En

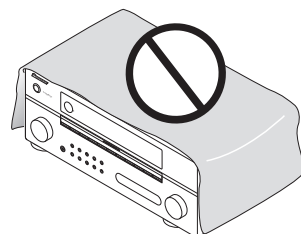

# IMPORTANT



The lightning flash with arrowhead symbol, within an equilateral triangle, is intended to alert the user to the presence of uninsulated "dangerous voltage" within the product's enclosure that may be of sufficient magnitude to constitute a risk of electric shock to persons.

## CAUTION

**RISK OF ELECTRIC SHOCK  
DO NOT OPEN**



The exclamation point within an equilateral triangle is intended to alert the user to the presence of important operating and maintenance (servicing) instructions in the literature accompanying the appliance.

D3-4-2-1-1\_En-A

# IMPORTANT SAFETY INSTRUCTIONS

- 1) Read these instructions.
- 2) Keep these instructions.
- 3) Heed all warnings.
- 4) Follow all instructions.
- 5) Do not use this apparatus near water.
- 6) Clean only with dry cloth.
- 7) Do not block any ventilation openings. Install in accordance with the manufacturer's instructions.
- 8) Do not install near any heat sources such as radiators, heat registers, stoves, or other apparatus (including amplifiers) that produce heat.
- 9) Do not defeat the safety purpose of the polarized or grounding-type plug. A polarized plug has two blades with one wider than the other. A grounding type plug has two blades and a third grounding prong. The wide blade or the third prong are provided for your safety. If the provided plug does not fit into your outlet, consult an electrician for replacement of the obsolete outlet.
- 10) Protect the power cord from being walked on or pinched particularly at plugs, convenience receptacles, and the point where they exit from the apparatus.
- 11) Only use attachments/accessories specified by the manufacturer.
- 12) Use only with the cart, stand, tripod, bracket, or table specified by the manufacturer, or sold with the apparatus. When a cart is used, use caution when moving the cart/apparatus combination to avoid injury from tip-over.
- 13) Unplug this apparatus during lightning storms or when unused for long periods of time.
- 14) Refer all servicing to qualified service personnel. Servicing is required when the apparatus has been damaged in any way, such as power-supply cord or plug is damaged, liquid has been spilled or objects have fallen into the apparatus, the apparatus has been exposed to rain or moisture, does not operate normally, or has been dropped.



P1-4-2-2\_En

## WARNING

**This equipment is not waterproof. To prevent a fire or shock hazard, do not place any container filled with liquid near this equipment (such as a vase or flower pot) or expose it to dripping, splashing, rain or moisture.**

D3-4-2-1-3\_B\_En

## WARNING

*Before plugging in for the first time, read the following section carefully.*

**The voltage of the available power supply differs according to country or region. Be sure that the power supply voltage of the area where this unit will be used meets the required voltage (e.g., 230 V or 120 V) written on the rear panel.**

D3-4-2-1-4\_A\_En

This product is for general household purposes. Any failure due to use for other than household purposes (such as long-term use for business purposes in a restaurant or use in a car or ship) and which requires repair will be charged for even during the warranty period.

K041\_En

## CAUTION

To prevent fire hazard, the Class 2 Wiring Cable should be used for connection with speaker, and should be routed away from hazards to avoid damage to the insulation of the cable.

**WARNING:** Handling the cord on this product or cords associated with accessories sold with the product will expose you to chemicals listed on proposition 65 known to the State of California and other governmental entities to cause cancer and birth defect or other reproductive harm.

***Wash hands after handling***

D36-P4\_A\_En

If the AC plug of this unit does not match the AC outlet you want to use, the plug must be removed and appropriate one fitted. Replacement and mounting of an AC plug on the power supply cord of this unit should be performed only by qualified service personnel. If connected to an AC outlet, the cut-off plug can cause severe electrical shock. Make sure it is properly disposed of after removal. The equipment should be disconnected by removing the mains plug from the wall socket when left unused for a long period of time (for example, when on vacation).

D3-4-2-2-1a\_A\_En

This product contains mercury. Disposal of this material may be regulated due to environmental considerations. For disposal or recycling information, please contact your local authorities or the Electronics Industries Alliance : [www.eiae.org](http://www.eiae.org).

K057\_En

**For U.S. and Australia Model**



Thank you for buying this Pioneer product. Please read through these operating instructions so you will know how to operate your model properly. After you have finished reading the instructions, put them away in a safe place for future reference.

# Contents

## 01 Before you start

Features	7
Checking what's in the box	8
Installing the receiver	8
Loading the batteries	8

## 02 5 minute guide

Introduction to home theater	9
Listening to Surround Sound	9
Automatically setting up for surround sound (Auto MCACC)	10
Problems when using the Auto MCACC Setup	11
Playing a source	11
Better sound using Phase Control	12

## 03 Connecting your equipment

Rear panel	13
When making cable connections	15
About the video converter	15
Connecting using HDMI	16
About HDMI	16
Connecting your TV and DVD player	17
Connecting your Blu-ray disc player	17
Connecting a satellite/cable receiver or other set-top box	18
Connecting a DVD/HDD recorder, VCR and other video sources	18
Using the component video jacks	19
Connecting digital audio sources	19
About the WMA9 Pro decoder	20
Connecting analog audio sources	20
Connecting a component to the front panel inputs	20
Installing your speaker system	21
Connecting the speakers	21
Placing the speakers	22
THX speaker system setup	23
Connecting antennas	23
Connecting external antennas	24
Plugging in the receiver	24

## 04 Controls and displays

Front panel	25
Operating range of remote control unit	26
Display	27
Remote control	28

## 05 Listening to your system

Auto playback	30
Listening in surround sound	30
Standard surround sound	30
Using the Home THX modes	31
Using the Advanced surround effects	31
Listening in stereo	32
Using Front Stage Surround Advance	32
Using Stream Direct	33
Selecting MCACC presets	33
Choosing the input signal	33
Using surround back channel processing	34
Using the Virtual Surround Back mode	34
Using the genre synchronizing function	35

## 06 Using the tuner

Listening to the radio	36
Improving FM stereo sound	36
Using Neural THX	36
Tuning directly to a station	36
Saving station presets	36
Naming station presets	37
Listening to station presets	37

## 07 The System Setup menu

Making receiver settings from the System Setup menu	38
Automatic MCACC (Expert)	38
Surround back speaker setting	41
Manual MCACC setup	41
Fine Channel Level	42
Fine Speaker Distance	42
Standing Wave	43
Acoustic Calibration EQ Adjust	43
Acoustic Calibration EQ Professional	44
Data Management	46
Manual speaker setup	48
Speaker Setting	48
Channel Level	49
Speaker Distance	50
X-Curve	50
THX Audio Setting	50

## 08 Other connections

Connecting an iPod . . . . .	52
Connecting your iPod to the receiver . . . . .	52
iPod playback. . . . .	52
Connecting a USB device . . . . .	54
Connecting your USB device to the receiver . . . . .	54
Basic playback controls . . . . .	54
Compressed audio compatibility . . . . .	55
Using XM Radio . . . . .	55
Connecting your XM Radio receiver . . . . .	55
Listening to XM Radio. . . . .	56
Using XM HD Surround . . . . .	56
Saving channel presets . . . . .	56
Using the XM Menu . . . . .	57
Using SIRIUS Radio. . . . .	57
Connecting your SiriusConnect™ Tuner. . . . .	57
Listening to SIRIUS Radio . . . . .	58
Saving channel presets . . . . .	58
Using the SIRIUS Menu . . . . .	58
Connecting the multichannel analog inputs. . . . .	59
Selecting the multichannel analog inputs . . . . .	59
Speaker B setup. . . . .	59
Switching the speaker system . . . . .	59
Bi-amping your front speakers . . . . .	60
Bi-wiring your speakers. . . . .	60
Connecting additional amplifiers . . . . .	61
MULTI-ZONE listening . . . . .	61
Making MULTI-ZONE connections . . . . .	61
Using the MULTI-ZONE controls . . . . .	62
Connecting an IR receiver. . . . .	63
Switching components on and off using the 12 volt trigger. . . . .	64
Using this receiver with a Pioneer flat panel TV . . . . .	64
Using the SR+ mode with a Pioneer flat panel TV . . . . .	65
Connecting a PC for Advanced MCACC output . . . . .	66
Advanced MCACC output using your PC . . . . .	66

## 09 HDMI Control

Making the HDMI Control connections. . . . .	67
Setting the HDMI options . . . . .	67
Setting the HDMI Control mode . . . . .	67
Before using synchronization . . . . .	68
Synchronized amp mode. . . . .	68
Synchronized amp mode operations. . . . .	68
Canceling synchronized amp mode . . . . .	68
About HDMI Control . . . . .	68

## 10 Other Settings

The Input Setup menu . . . . .	69
Input function default and possible settings . . . . .	70
The Other Setup menu . . . . .	70
Multi Channel Input Setup . . . . .	71

ZONE Audio Setup . . . . .	71
SR+ Setup for Pioneer flat panel TVs. . . . .	72
OSD Adjustment. . . . .	72

## 11 Using other functions

Setting the Audio options. . . . .	73
Setting the Video options . . . . .	74
Making an audio or a video recording. . . . .	75
Reducing the level of an analog signal. . . . .	76
Using the sleep timer . . . . .	76
Dimming the display. . . . .	76
Switching the speaker impedance . . . . .	76
Checking your system settings . . . . .	76
Resetting the system . . . . .	77
Default system settings . . . . .	77

## 12 Controlling the rest of your system

Setting the remote to control other components. . . . .	78
Selecting preset codes directly . . . . .	78
Preset code list . . . . .	78
Controls for TVs . . . . .	79
Controls for other components . . . . .	80
Operating other Pioneer components with this receiver's sensor . . . . .	81

## 13 Additional information

Troubleshooting. . . . .	82
Power. . . . .	82
No sound . . . . .	82
Other audio problems . . . . .	84
Video . . . . .	85
Settings . . . . .	85
Professional Calibration EQ graphical output . . . . .	86
Display. . . . .	86
Remote control . . . . .	87
USB interface . . . . .	87
HDMI . . . . .	88
Important information regarding the HDMI connection. . . . .	89
XM radio messages . . . . .	89
SIRIUS radio messages . . . . .	90
Surround sound formats . . . . .	91
Dolby . . . . .	91
DTS. . . . .	92
Windows Media Audio 9 Professional . . . . .	92
About THX . . . . .	93
About Neural – THX Surround . . . . .	94
About XM . . . . .	95
About SIRIUS. . . . .	95
Listening modes with different input signal formats . . . . .	96
Stream direct with different input signal formats. . . . .	101
Specifications . . . . .	102
Cleaning the unit. . . . .	102

## Chapter 1: Before you start

### Features

- **Advanced Direct Energy design**

This receiver offers a new advancement in discrete design unique to Pioneer for high-power drivability, low distortion and stable imaging. Through a circuit design that minimizes the energy loss of the amplifier for each of the channels, this receiver generates equal amplifier power to all channels, eliminating the possibility of one channel dominating a particular sound field.

- **Easy setup using Advanced MCACC**

The Auto MCACC Setup provides a quick but accurate surround sound setup, which includes the advanced features of Professional Acoustic Calibration EQ. This innovative technology measures the reverb characteristics of your listening area, allowing you to customize your system calibration with the help of a graphical output that can be displayed on-screen or using computer. With the additional benefits of numerous MCACC preset memories, standing wave control and microphone measurements from a series of reference points, your home theater experience can be truly customized for optimal surround sound.

- **THX Select2 Plus certified design**

This receiver bears the THX Select2 Plus logo, which means it has passed a rigorous series of quality and performance tests covering every aspect of the product. This includes testing of pre-amplifier and power amplifier performance and operation, and hundreds of other parameters in both the digital and analog domain, making your home theater experience as faithful as possible to what the director intended.

- **Dolby Digital and DTS decoding, including Dolby Digital EX, Dolby Pro Logic IIx, DTS 96/24, DTS-ES, Dolby Digital Plus, Dolby TrueHD, DTS-EXPRESS and DTS-HD Master Audio**

Dolby Digital and DTS decoding brings theater sound right into your home with up to six channels of surround sound, including a special LFE (Low Frequency Effects) channel for deep, realistic sound effects.

The built-in Dolby Pro Logic IIx and DTS Neo:6 decoders not only provide full surround sound decoding for Dolby Surround sources, but will also generate convincing surround sound for any stereo source.

Also, with the addition of a surround back speaker, you can take advantage of the built-in Dolby Digital EX and DTS-ES decoders for six-channel surround sound.

Furthermore, Dolby Digital Plus and Dolby TrueHD, which are designed for the next-generation high-definition media such as Blu-ray Disc and HD DVD, support up to 7.1 channels and 8 channels respectively.

DTS-EXPRESS is a low-bitrate encoding technology supporting up to 5.1 channels, with fixed data transfer rates ranging from 24 kbps to 256 kbps (this encoding is available only when signals are delivered to this receiver as primary audio).

DTS-HD Master Audio delivers audio signals to listeners without any loss of data with its high transfer rates.

- **Phase Control**

The Phase Control technology incorporated into this receiver's design provides coherent sound reproduction through the use of phase matching for an optimal sound image at your listening position.

- **Sound Retriever**

The Sound Retriever feature employs DSP technology that helps bring CD quality sound back to WMA, MP3 and MPEG-4 AAC audio files by restoring sound pressure and smoothing jagged artifacts left over after compression.

- **Front Stage Surround Advance**

With the Front Stage Surround Advance feature, you can enjoy seamless, natural surround sound effects using only the front speakers, without deteriorating the quality of the original sound.

- **Auto Level Control**

When the source is played in Auto level control stereo mode (A.L.C.), this receiver automatically equalizes the playback sound level according to the variation in recording levels between music sources recorded in the portable audio player.

- **HDMI and digital video conversion**

This receiver is compatible with the HDMI digital video format, providing you with high-definition digital video/audio via a single cable.

High-quality sound formats such as DTS-HD and Dolby TrueHD are supported while this receiver is also compatible with the DeepColor feature. You can operate this receiver in synchronization with your Pioneer component that supports the HDMI Control function by connecting your component to this receiver via HDMI. Also, the built-in digital video converter of this receiver makes both de-interlacing and up-scaling possible, and analog video signals being input are converted and output as digital video signals at the HDMI terminal.

- **iPod and USB Ready**

This receiver has the terminals for connecting an iPod unit and a USB mass storage device.

The iPod terminal is ready for handling digital audio, and this receiver's enhanced compatibility makes on-screen control of your iPod an added possibility.

The USB terminal allows you to listen to two-channel audio from a USB mass storage device connected to this receiver.

- **XM and SIRIUS Ready**

With the new XM and SIRIUS Radio terminals, you'll be up and running in no time. This receiver's enhanced compatibility makes XM HD Surround playback as well as on-screen control of XM and SIRIUS Radio an added possibility.

## Checking what's in the box

Please check that you've received the following supplied accessories:

- Setup microphone (cable: 5 m (16.4 ft.))
- Remote control unit
- AA/IEC R6P dry cell batteries x2
- AM loop antenna
- FM wire antenna
- Warranty card
- These operating instructions

## Installing the receiver

- When installing this receiver, make sure to put it on a level and stable surface.

Don't install it on the following places:

- on a color TV (the screen may distort)
- near a cassette deck (or close to a device that gives off a magnetic field). This may interfere with the sound.
- in direct sunlight
- in damp or wet areas
- in extremely hot or cold areas
- in places where there is vibration or other movement
- in places that are very dusty
- in places that have hot fumes or oils (such as a kitchen)

## Loading the batteries

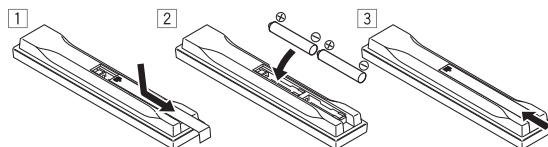

### Caution

Incorrect use of batteries may result in such hazards as leakage and bursting. Observe the following precautions:

- Never use new and old batteries together.
- Insert the plus and minus sides of the batteries properly according to the marks in the battery case.
- Batteries with the same shape may have different voltages. Do not use different batteries together.
- When disposing of used batteries, please comply with governmental regulations or environmental public instruction's rules that apply in your country or area.

- **WARNING**

Do not use or store batteries in direct sunlight or other excessively hot place, such as inside a car or near a heater. This can cause batteries to leak, overheat, explode or catch fire. It can also reduce the life or performance of batteries.



## Chapter 2: 5 minute guide

### Introduction to home theater

Home theater refers to the use of multiple audio tracks to create a surround sound effect, making you feel like you're in the middle of the action or concert. The surround sound you get from a home theater system depends not only on your speaker setup, but also on the source and the sound settings of the receiver.

This receiver will automatically decode multichannel Dolby Digital, DTS, or Dolby Surround sources according to your speaker setup. In most cases, you won't have to make changes for realistic surround sound, but other possibilities (like listening to a CD with multichannel surround sound) are explained in *Listening to your system* on page 30.

### Listening to Surround Sound

This receiver was designed with the easiest possible setup in mind, so with the following quick setup guide, you should have your system hooked up for surround sound in no time at all. In most cases, you can simply leave the receiver in the default settings.

- Be sure to complete all connections before connecting this receiver to an AC power source.

#### 1 Connect your TV and DVD player.

See *Connecting your TV and DVD player* on page 17 to do this. For surround sound, you'll want to hook up using a digital connection from the DVD player to the receiver.

#### 2 Connect your speakers and place them for optimal surround sound.

Connect your speakers as shown in *Installing your speaker system* on page 21.

Where you place the speakers will have a big effect on the sound. Place your speakers as shown below for the best surround sound effect. Also see *Placing the speakers* on page 22 for more on this.

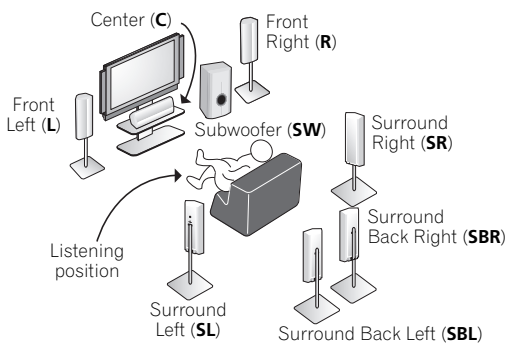

#### 3 Plug in the receiver and switch it on, followed by your DVD player, your subwoofer and the TV.

Plug the power cable into the AC outlet and switch on the receiver.<sup>1</sup> Make sure you've set the video input on your TV to this receiver. Check the manual that came with the TV if you don't know how to do this.

- Set the subwoofer volume to a comfortable level.

#### 4 Use the on-screen automatic MCACC setup to set up your system.

See *Automatically setting up for surround sound (Auto MCACC)* on page 10 for more on this.

#### 5 Play a DVD, and adjust the volume to your liking.

Make sure that **DVD** is showing in the receiver's display, indicating that the DVD input is selected. If it isn't, press **DVD** on the remote control to set the receiver to the DVD input.

In addition to the basic playback explained in *Playing a source* on page 11, there are several other sound options you can select. See *Listening to your system* on page 30 for more on this.

See also *Making receiver settings from the System Setup menu* on page 38 for more setup options.

#### Note

<sup>1</sup> After this receiver is connected to an AC outlet, a 15-second HDMI initialization process begins. You cannot carry out any operations during this process. The **HDMI** indicator in the front panel display blinks during this process, and you can turn on this receiver once it has stopped blinking. When you set the **HDMI Control** mode to **OFF**, you can skip this process. For details about the HDMI Control feature, see *HDMI Control* on page 67.

## Automatically setting up for surround sound (Auto MCACC)

The Auto MCACC Setup measures the acoustic characteristics of your listening area, taking into account ambient noise, speaker size and distance, and tests for both channel delay and channel level. After you have set up the microphone provided with your system, the receiver uses the information from a series of test tones to optimize the speaker settings and equalization for your particular room.

Make sure you do this before moving on to *Playing a source* on page 11.

### Important

- Make sure the microphone and speakers are not moved during the Auto MCACC Setup.
- Using the Auto MCACC Setup will overwrite any existing settings for the MCACC preset you select.
- Before using the Auto MCACC Setup, the headphones should be disconnected and the **iPod USB, XM or SIRIUS** Radio function should not be selected as an input source.

### Caution

- The test tones used in the Auto MCACC Setup are output at high volume.

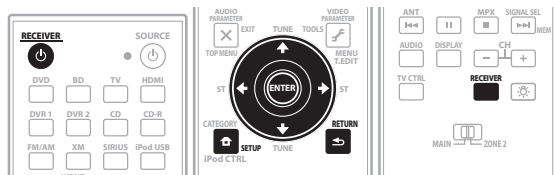

**1 Switch on the receiver and your TV.**

**2 Connect the microphone to the MCACC SETUP MIC jack on the front panel.**

Place the microphone so that it's about ear level at your normal listening position (use a tripod if possible). Make sure there are no obstacles between the speakers and the microphone.

- Push down on the **PUSH OPEN** tab to access the **MCACC SETUP MIC** jack:



The Auto MCACC display appears once the microphone is connected.<sup>1</sup>

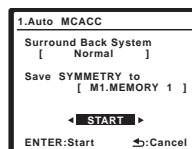

**3 Make sure 'Normal' is selected,<sup>2</sup> select an MCACC preset<sup>3</sup>, press RECEIVER and then select START<sup>4</sup>.**

**4 Follow the instructions on-screen.**

Make sure the microphone is connected, and if you're using a subwoofer, make sure it is switched on and set to a comfortable volume level.

**5 Wait for the test tones to finish, then confirm the speaker configuration in the OSD.**

A progress report is displayed on-screen while the receiver outputs test tones to determine the speakers present in your setup. Try to be as quiet as possible while it's doing this.<sup>5</sup>

If no operations are performed for 10 seconds while the speaker configuration check screen is being displayed, the Auto MCACC Setup will resume automatically. In this case, you don't need to select **'OK'** and press **ENTER** in step 6.

- With error messages (such as **Too much ambient noise!** or **Check Microphone.**) select **RETRY** after checking for ambient noise (see *Problems when using the Auto MCACC Setup* on page 11) and verifying the mic connection. If there doesn't seem to be a problem, you can simply select **GO NEXT** and continue.

### Note

**1** • You can't use the System Setup menu in either the main or sub zone when the **iPod USB, XM or SIRIUS** Radio input source is selected. When you set **ZONE 2** to **ON** (page 62), you can't use the System Setup menu.

• If you cancel the Auto MCACC Setup, or leave an error message for over three minutes, the screen saver will appear.

**2** • If you are planning on bi-amping your front speakers, or setting up a separate speaker system in another room, read through *Surround back speaker setting* on page 41 and make sure to connect your speakers as necessary before continuing to step 4.

• If you have THX-certified speakers, select **CUSTOM** and choose **YES** for the **THX Speaker** setting.

**3** The six MCACC presets are used for storing surround sound settings for different listening positions. Simply choose an unused preset for now (you can rename it later in *Data Management* on page 46).

**4** Note that correction curves are saved only when set to **SYMMETRY**. Select **CUSTOM** to save other correction curves (such as **ALL CH ADJUST** and **FRONT ALIGN**). See *Automatic MCACC (Expert)* on page 38 for more on this.

**5** Do not adjust the volume during the test tones. This may result in incorrect speaker settings.

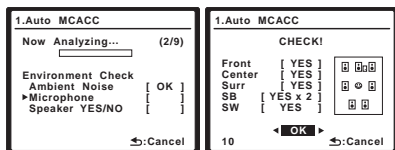

The configuration shown on-screen should reflect the actual speakers you have.<sup>1</sup>

If you see an error message (**ERR**) in the right side column (or the speaker configuration displayed isn't correct), there may be a problem with the speaker connection. If selecting **RETRY** doesn't work, turn off the power and check the speaker connections. If there doesn't seem to be a problem, you can simply use **↑/↓** to select the speaker and **←/→** to change the setting (and number for surround back) and continue.

## 6 Make sure 'OK' is selected, then press ENTER.

A progress report is displayed on-screen while the receiver outputs more test tones to determine the optimum receiver settings for Channel Level, Speaker Distance, Standing Wave and Acoustic Cal EQ.

Again, try to be as quiet as possible while this is happening. It may take 3 to 7 minutes.

## 7 The Auto MCACC Setup has finished! Press RETURN to go back to the System Setup menu.<sup>2</sup>

Be sure to disconnect the microphone from this receiver upon completion of the Auto MCACC setup.

The settings made in the Auto MCACC Setup should give you excellent surround sound from your system, but it is also possible to adjust these settings manually using the System Setup menu (starting on page 38).<sup>3</sup>

## Problems when using the Auto MCACC Setup

If the room environment is not optimal for the Auto MCACC Setup (too much background noise, echo off the walls, obstacles blocking the speakers from the microphone) the final settings may be incorrect. Check for household appliances (air conditioner, fridge, fan, etc.), that may be affecting the environment and switch them off if necessary. If there are any instructions showing in the front panel display, please follow them.

### Note

1 If you're using the front panel display, the diagram in *Listening to Surround Sound* on page 9 indicates (in bold) how each speaker is displayed.

2 You can also choose to view the settings from the MCACC Data Check screen. See *Automatic MCACC (Expert)* on page 38 for more on this.

3 Depending on the characteristics of your room, sometimes identical speakers with cone sizes of around 12 cm (5 inches) will end up with different size settings. You can correct the setting manually using the *Manual speaker setup* on page 48.

- The subwoofer distance setting may be farther than the actual distance from the listening position. This setting should be accurate (taking delay and room characteristics into account) and generally does not need to be changed.

- If Auto MCACC Setup measurement results are incorrect due to the interaction of the speakers and viewing environment, we recommend adjusting the settings manually.

4 Make sure that the TV's video input is set to this receiver (for example, if you connected this receiver to the **VIDEO 1** jacks on your TV, make sure that the **VIDEO 1** input is now selected).

5 If you need to manually switch the input signal type press **SIGNAL SEL** (page 33).

6 You may need to check the digital audio output settings on your DVD player or digital satellite receiver. It should be set to output Dolby Digital, DTS and 88.2 kHz / 96 kHz PCM (2 channel) audio, and if there is an MPEG audio option, set this to convert the MPEG audio to PCM.

- Depending on your DVD player or source discs, you may only get digital 2 channel stereo and analog sound. In this case, the receiver must be set to a multichannel listening mode (see *Listening in surround sound* on page 30 if you need to do this) if you want multichannel surround sound.

- Some older TVs may interfere with the operation of the microphone. If this seems to be happening, switch off the TV when doing the Auto MCACC Setup.

## Playing a source

Here are the basic instructions for playing a source (such as a DVD disc) with your home theater system.

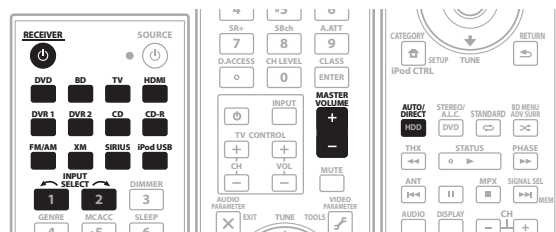

### 1 Switch on your system components and receiver.

Start by switching on the playback component (for example a DVD player), your TV<sup>4</sup> and subwoofer (if you have one), then the receiver (press **RECEIVER**).

- Make sure the setup mic is disconnected.

### 2 Select the input source you want to play.

You can use the input source buttons on the remote control, **INPUT SELECT**, or the front panel controls.<sup>5</sup>

### 3 Press AUTO/DIRECT (AUTO SURR/STREAM DIRECT) to select 'AUTO SURROUND' and start playback of the source.<sup>6</sup>

If you're playing a Dolby Digital or DTS surround sound DVD disc, you should hear surround sound. If you are playing a stereo source, you will only hear sound from the front left/right speakers in the default listening mode.

- See also *Listening to your system* on page 30 for information on different ways of listening to sources.

It is possible to check on the display whether or not multi-channel playback is being performed properly.

When using a surround back speaker, **DOD+PL IIx MOVIE** is displayed when playing Dolby Digital signals, and **DTS+Neo:6** is displayed when playing DTS 5.1-channel signals.

When not using a surround back speaker, **DOLBY DIGITAL** is displayed when playing Dolby Digital signals.

#### 4 Use the volume control to adjust the volume level.

Turn down the volume of your TV so that all sound is coming from the speakers connected to this receiver.

## Better sound using Phase Control

This receiver's Phase Control feature uses phase correction measures to make sure your sound source arrives at the listening position in phase, preventing unwanted distortion and/or coloring of the sound (see illustration below).

During multichannel playback, LFE (Low-Frequency Effects) signals as well as low-frequency signals in each channel are assigned to the subwoofer or other the subwoofer and the most appropriate speaker. At least in theory, however, this type of processing involves a group delay that varies with frequency, resulting in phase distortion where the low-frequency sound is delayed or muffled by the conflict with other channels. With the Phase Control mode switched on, this receiver can reproduce powerful bass sound without deteriorating the quality of the original sound (see illustration below).

### Phase Control OFF

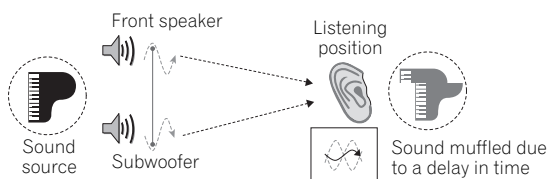

- Rhythms blurred and difficult to hear
- Bass sound with loss of depth
- Sound of musical instruments with no reality

### Phase Control ON

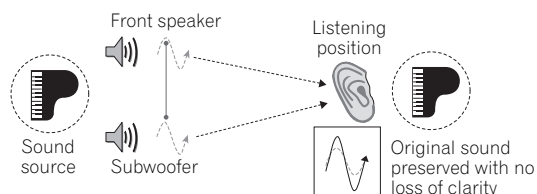

- Rhythms with crystal-like clarity
- Bass sound with no loss of depth
- Sound of musical instruments with superb reality

Phase Control technology provides coherent sound reproduction through the use of phase matching<sup>1</sup> for an optimal sound image at your listening position. The default setting is on and we recommend leaving Phase Control switched on for all sound sources.

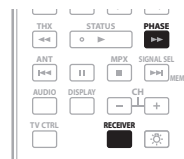

- Press **RECEIVER**, then press **PHASE (PHASE CONTROL)** to switch on phase correction.

The **PHASE CONTROL** indicator on the front panel lights.

### Note

<sup>1</sup> Phase matching is a very important factor in achieving proper sound reproduction. If two waveforms are 'in phase', they crest and trough together, resulting in increased amplitude, clarity and presence of the sound signal. If a crest of a wave meets a trough (as shown in the upper section of the diagram above), then the sound will be 'out of phase' and an unreliable sound image will be produced.

- The **PHASE CONTROL** feature is available even when the headphones are plugged in.
- If your subwoofer has a phase control switch, set it to the plus (+) sign (or 0°). However, the effect you can actually feel when **PHASE CONTROL** is set to **ON** on this receiver depends on the type of your subwoofer. Set your subwoofer to maximize the effect. It is also recommended you try changing the orientation or the place of your subwoofer.
- Set the built-in lowpass filter switch of your subwoofer to OFF. If this cannot be done on your subwoofer, set the cutoff frequency to a higher value.
- If the speaker distance is not properly set, you may not have a maximized **PHASE CONTROL** effect.
- The **PHASE CONTROL** mode cannot be set to **ON** in the following cases:
  - When the **PURE DIRECT** mode is switched on.
  - When the HDMI audio output parameter is set to **THROUGH** in *Setting the Audio options* on page 73.

Chapter 3:

# Connecting your equipment

This receiver provides you with many connection possibilities, but it doesn't have to be difficult. This page explains the kinds of components you can connect to make up your home theater system.

## Rear panel

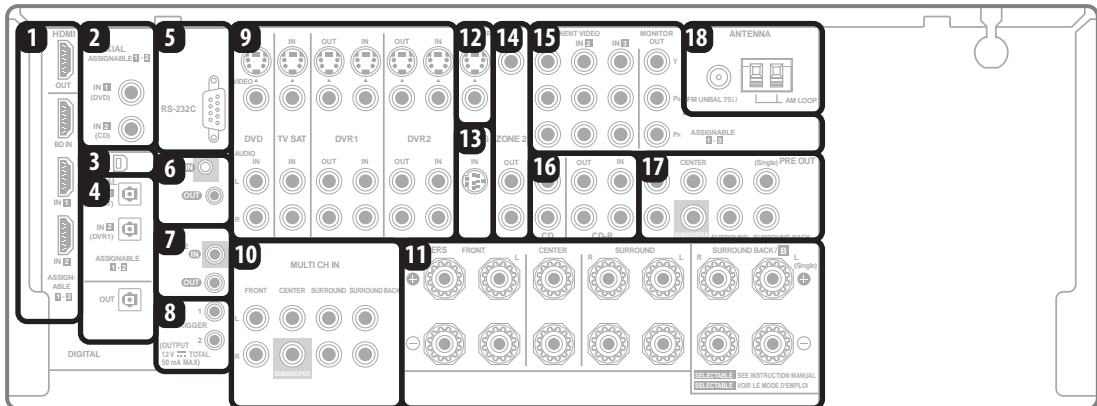

**Caution**

- Before making or changing the connections, switch off the power and disconnect the power cord from the power outlet. Plugging in should be the final step.

**1 HDMI connectors (x4)**

Three inputs and one output for high-quality audio/video connection to compatible HDMI devices.

→ See *Connecting using HDMI* on page 16.

**2 Coaxial digital audio inputs (x2)**

Use for digital audio sources, including DVD players/recorders, digital satellite receivers, CD players, etc.

→ See also *The Input Setup menu* on page 69 to assign the inputs.

**3 XM Radio input**

→ See *Using XM Radio* on page 55.

**4 Optical digital audio output/input(s) (x3)**

Use the **OUT** jack for recording to a CD or MiniDisc recorder.

→ See *Connecting digital audio sources* on page 19.

Use the **IN** jacks for digital audio sources, including DVD players/recorders, digital satellite receivers, CD players, etc.

→ See also *The Input Setup menu* on page 69 to assign the inputs.

**5 RS-232C connector**

Use for connection to a PC for graphical output when using Advanced MCACC.

→ See *Connecting a PC for Advanced MCACC output* on page 66.

**6 Control input/output**

Use to connect other Pioneer components so that you can control all your equipment from a single IR remote sensor.

→ See *Operating other Pioneer components with this receiver's sensor* on page 81.

**7 Remote input/output (MULTI-ZONE)**

Use for connection to an external remote control sensor for use in a MULTI-ZONE setup, for example.

→ See *Connecting an IR receiver* on page 63.

**8 12 V trigger jacks (total 50 mA max.) (x2)**

Use to switch components in your system on and off according to the input function of the receiver.

→ See *Switching components on and off using the 12 volt trigger* on page 64.

**9 Audio/video source inputs/(outputs) (x6)**

Use for connection to audio/visual sources, such as DVD players/recorders, VCRs, etc. Each set of inputs has jacks for composite video, S-Video and stereo analog audio.

→ See *Connecting a DVD/HDD recorder, VCR and other video sources* on page 18.

**10 Multichannel analog audio inputs**

7.1 channel inputs for connection to a DVD player with multichannel analog outputs.

→ See *Using XM Radio* on page 55.

**11 Speaker terminals**

Use for connection to the main front, center, surround and surround back speakers.

→ See *Installing your speaker system* on page 21.

**12 Composite and S-Video monitor outputs**

Use to connect monitors and TVs.

→ See *Connecting your TV and DVD player* on page 17.

**13 SIRIUS Radio input**

→ See *Using SIRIUS Radio* on page 57.

**14 ZONE 2 audio/video outputs**

Use to connect a second receiver in a separate room.

→ See *MULTI-ZONE listening* on page 61.

**15 Component video connections (x4)**

Use the inputs to connect any video source that has component video output, such as a DVD recorder. Use the output for connection to a monitor or TV.

→ See *Using the component video jacks* on page 19.

**16 Stereo analog audio source inputs/(outputs) (x3)**

Use for connection to audio sources such as CD players, tape decks, turntables, etc.

→ See *Connecting analog audio sources* on page 20.

**17 Multichannel pre-amplifier outputs**

Use to connect separate amplifiers for front, center, surround, surround back and subwoofer channels.

→ See *Connecting additional amplifiers* on page 61 (see also *Installing your speaker system* on page 21 for powered subwoofer connection).

**18 AM and FM antenna terminals**

Use to connect indoor or outdoor antennas for radio broadcasts.

→ See *Connecting antennas* on page 23.

## When making cable connections

- To avoid hum, do not lay connected cables over the top of the receiver.

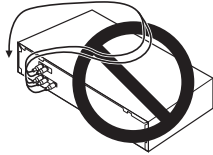

- When connecting optical cables, be careful when inserting the plug not to damage the shutter protecting the optical socket.

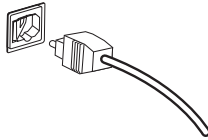

- When storing optical cable, coil loosely. The cable may be damaged if bent around sharp corners.

## About the video converter

The video converter ensures that all video sources are output through all of the **MONITOR VIDEO OUT** jacks. The only exception is HDMI: since this resolution cannot be downsampled, you must connect your monitor/TV to the receiver's HDMI video outputs when connecting this video source.<sup>1</sup>

If several video components are assigned to the same input function (see *The Input Setup menu* on page 69), the converter gives priority to HDMI, component, S-Video, then composite (in that order).

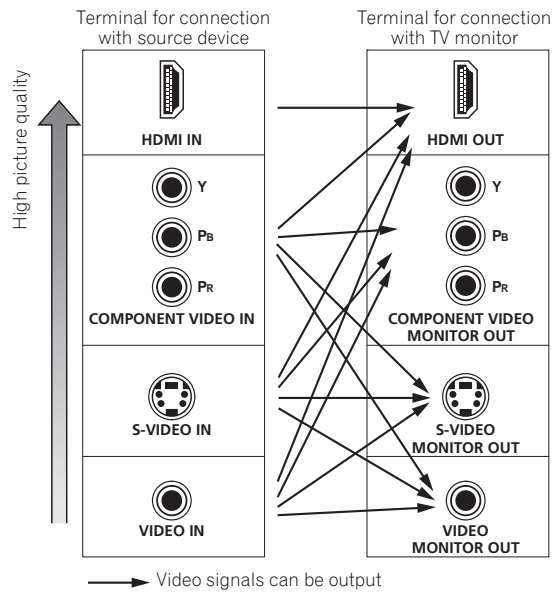

- For optimal video performance, THX recommends switching Digital Video Conversion (in *Setting the Video options* on page 74) **OFF**.

*This product incorporates copyright protection technology that is protected by method claims of certain U.S. patents and other intellectual property rights owned by Macrovision Corporation and other rights owners. Use of this copyright protection technology must be authorized by Macrovision Corporation, and is intended for home and other limited viewing uses only unless otherwise authorized by Macrovision Corporation. Reverse engineering or disassembly is prohibited.*

### Note

<sup>1</sup> If the video signal does not appear on your TV or flat panel TV, try adjusting the resolution settings on your component or display. Note that some components (such as video game units) have resolutions that may not be converted. In this case, try switching Digital Video Conversion (in *Setting the Video options* on page 74) **OFF**.

- The ZONE 2 video input can also be converted. For details, see *Setting the Video options* on page 74.

## Connecting using HDMI

If you have an HDMI or DVI (with HDCP) equipped component, you can connect it to this receiver using a commercially available HDMI cable.<sup>1</sup>

The HDMI connection transfers uncompressed digital video, as well as almost every kind of digital audio that the connected component is compatible with, including DVD-Video, DVD-Audio, SACD, Dolby Digital Plus, Dolby TrueHD, DTS-HD Master Audio (see below for limitations), Video CD/Super VCD, CD and MP3. See *About the video converter* on page 15 for more on HDMI compatibility.

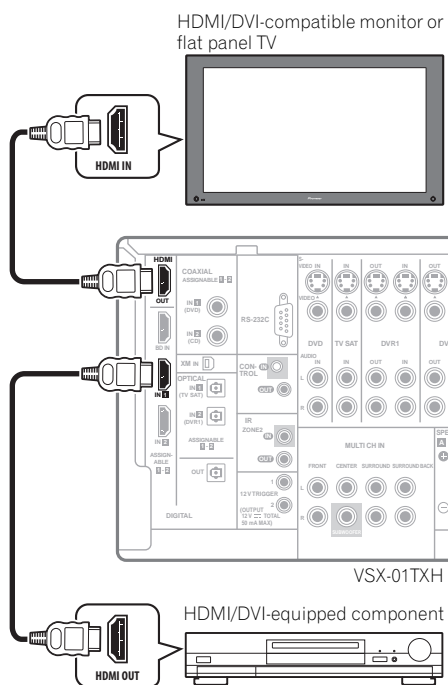

### 1 Use an HDMI cable to connect one of the HDMI IN interconnects on this receiver to an HDMI output on your HDMI component.

The **HDMI** indicator lights on the front panel when an HDMI-equipped component is connected.

### 2 Use an HDMI cable to connect the HDMI OUT interconnect on this receiver to an HDMI interconnect on an HDMI-compatible monitor.

- The arrow on the cable connector body should be facing left for correct alignment with the connector on the player.

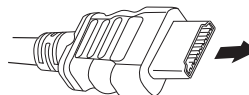

### 3 Use the INPUT SELECT button to select the HDMI input you've connected to (for example, HDMI 2).

You can also perform the same operation by using the **INPUT SELECTOR** dial on the front panel or by pressing **HDMI** on the remote control repeatedly.

- Set the HDMI parameter in *Setting the Audio options* on page 73 to **THROUGH** if you want to hear HDMI audio output from your TV or flat panel TV (no sound will be heard from this receiver).
- If the video signal does not appear on your TV or flat panel TV, try adjusting the resolution settings on your component or display. Note that some components (such as video game units) have resolutions that may not be converted. In this case, use an analog video connection.
- You can't hear HDMI audio through this receiver's digital out jacks.

## About HDMI

HDMI (High Definition Multimedia Interface) supports both video and audio on a single digital connection for use with DVD players, DTV, set-top boxes, and other AV devices. HDMI was developed to provide the technologies of High Bandwidth Digital Content Protection (HDCP) as well as Digital Visual Interface (DVI) in one specification. HDCP is used to protect digital content transmitted and received by DVI-compliant displays.

HDMI has the capability to support standard, enhanced, or high-definition video plus standard to multi-channel surround-sound audio. HDMI features include uncompressed digital video, one connector (instead of several cables and connectors), and communication between the AV source and AV devices such as DTVs.

*HDMI, the HDMI Logo and High-Definition Multimedia Interface are trademarks or registered trademarks of HDMI Licensing LLC.*

## Note

<sup>1</sup> • An HDMI connection can only be made with DVI-equipped components compatible with both DVI and High Bandwidth Digital Content Protection (HDCP). If you choose to connect to a DVI connector, you will need a separate adaptor (DVI→HDMI) to do so. A DVI connection, however, does not support audio signals. Consult your local audio dealer for more information.

- If you connect a component that is not compatible with HDCP, an **HDCP ERROR** message is displayed on the front panel display. Some components that are compatible with HDCP still cause this message to be displayed, but so long as there is no problem with displaying video this is not a malfunction.
- Depending on the component you have connected, using a DVI connection may result in unreliable signal transfers.
- This receiver supports SACD, Dolby Digital Plus, Dolby TrueHD and DTS-HD Master Audio. To take advantage of these formats, however, make sure that the component connected to this receiver also supports the corresponding format.



## Connecting your TV and DVD player

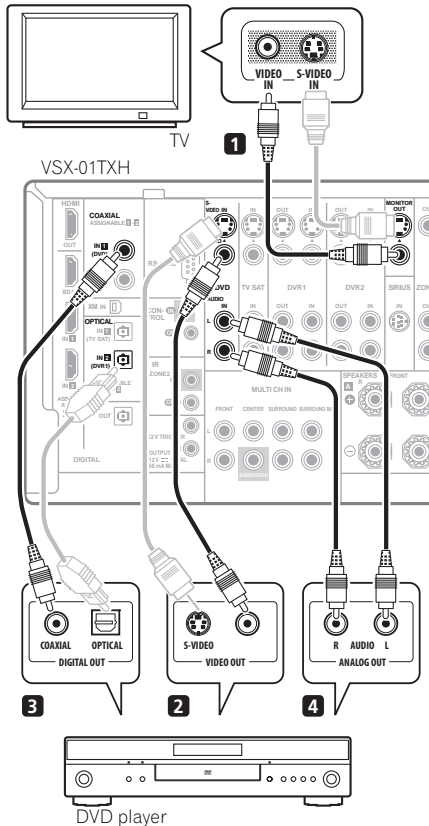

The diagram shows a basic setup of this receiver together with a TV and DVD player, with S-Video or composite video connections. Different TVs and DVD players may offer alternative connections. See also *Using the component video jacks* on page 19 if your TV and/or DVD player has component video inputs/outputs. If your DVD player offers multichannel analog audio outputs, see *Using XM Radio* on page 55.

**1 Connect the MONITOR OUT video jack to a video input on your TV.**

Use a standard RCA/phono jack video cable to connect to the composite video jack, or for higher quality video, use an S-Video cable to connect to the S-Video jack.

**2 Connect a composite or S-Video output on your DVD player to the DVD VIDEO or DVD S-VIDEO input.**

Connect using a standard video cable or an S-Video cable.

**3 Connect a coaxial-type<sup>1</sup> digital audio output on your DVD player to the COAXIAL IN 1 (DVD) input.**  
Use a coaxial cable designed for digital audio.

**4 Connect the stereo audio outputs on your DVD player to the DVD AUDIO inputs.**

Connect using a stereo RCA/phono jack cable.

- If your DVD player has multichannel analog outputs, you can connect these instead. See also *Using XM Radio* on page 55.

## Connecting your Blu-ray disc player

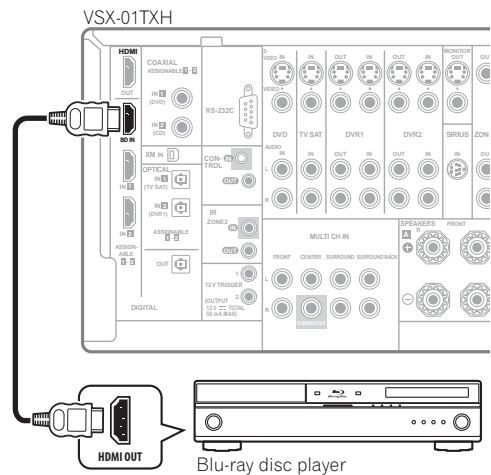

The diagram shows a basic setup of this receiver together with a Blu-ray disc player, with HDMI connections. If your Blu-ray disc player offers multi-channel analog audio outputs, see *Using XM Radio* on page 55.

**• Connect an HDMI output on your Blu-ray disc player to the BD HDMI input.**

Connect using an HDMI cable.

**Note**

<sup>1</sup> If your DVD player only has an optical digital output, you can connect it to one of the optical inputs on this receiver using an optical cable. When you set up the receiver you'll need to tell the receiver which input you connected the player to (see *The Input Setup menu* on page 69).

## Connecting a satellite/cable receiver or other set-top box

Satellite and cable receivers, and terrestrial digital TV tuners are all examples of so-called 'set-top boxes'.

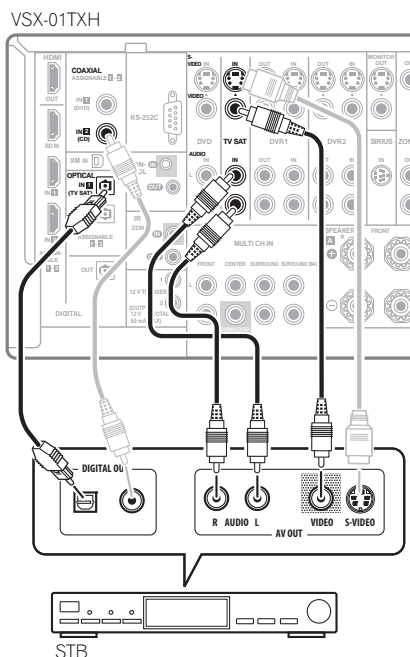

**1** Connect the audio/video outputs on the set-top box to the TV SAT AUDIO and VIDEO inputs.

Connect using a stereo RCA/phono jack cable and a video or S-Video cable.

**2** Connect an optical-type<sup>1</sup> digital audio output from your set-top box to the OPTICAL IN 1 (TV SAT) input.<sup>2</sup>

Use an optical cable for the connection.

## Connecting a DVD/HDD recorder, VCR and other video sources

This receiver has two sets of audio/video inputs and outputs suitable for connecting analog or digital video devices, including DVD/HDD recorders and VCRs.

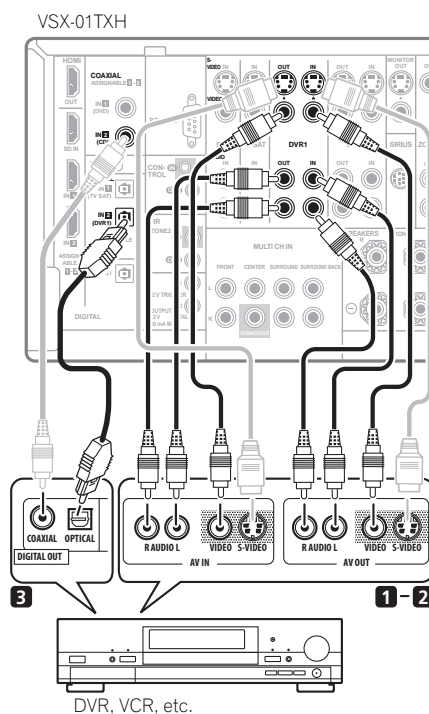

**1** Connect the audio/video outputs of the video player/recorder to the DVR1 AUDIO and VIDEO inputs.

Use a stereo RCA/phono jack audio cable for the audio connection and a video or S-Video cable for the video connection.

- For a second recorder, use the **DVR2 IN** inputs.

**2** If the device can record, connect the DVR1 AUDIO and VIDEO outputs to the recorder's audio/video inputs.

Use a stereo RCA/phono jack audio cable for the audio connection and a video or S-Video cable for the video connection.

- For a second recorder, use the **DVR2 OUT** outputs.

### Note

<sup>1</sup> If your set-top box only has a coaxial digital output, you can connect it to one of the coaxial inputs on this receiver using a coaxial digital audio cable. When you set up the receiver you'll need to tell the receiver which input you connected the set-top box to (see *The Input Setup menu* on page 69).

<sup>2</sup> If your satellite/cable receiver doesn't have a digital audio output, you can skip this step.

**3** If the device can output digital audio, connect an optical-type<sup>1</sup> digital audio output from the recorder to the **OPTICAL IN 2 (DVR1)** input.

Use an optical cable for the connection.<sup>2</sup>

## Using the component video jacks

Component video should give superior picture quality when compared to composite or S-Video. You can also take advantage of progressive scan video (if your source and TV are both compatible), which delivers a very stable, flicker-free picture. See the manuals that came with your TV and source component to check whether they are compatible with progressive-scan video.

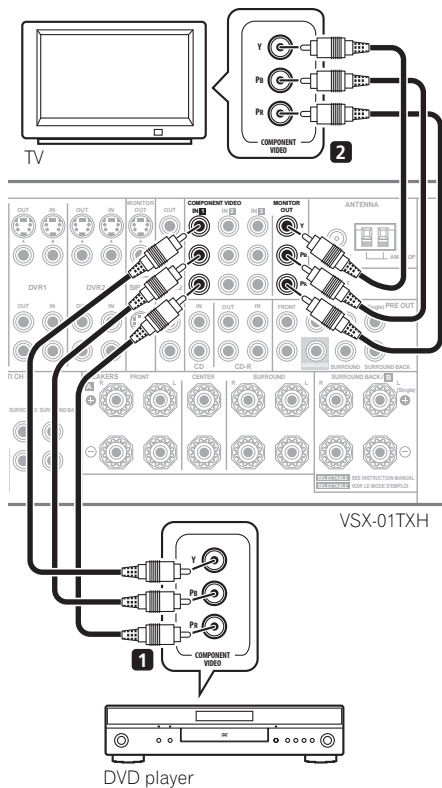

**1** Connect the component video outputs of your source to a set of **ASSIGNABLE COMPONENT VIDEO** inputs.

Connect using a three-way component video cable.

- Since they are assignable, it doesn't matter which component video inputs you use for which source. After connecting everything, you'll need to assign the component video inputs—see *The Input Setup menu* on page 69.

**2** Connect the **COMPONENT VIDEO MONITOR OUT** jacks to the component video inputs on your TV or monitor.

Use a three-way component video cable.

## Connecting digital audio sources

This receiver has both digital inputs and outputs, allowing you to connect digital audio components for playback and for making digital recordings.

Most digital components also have analog connections. See *Connecting analog audio sources* on page 20 if you want to connect these too.

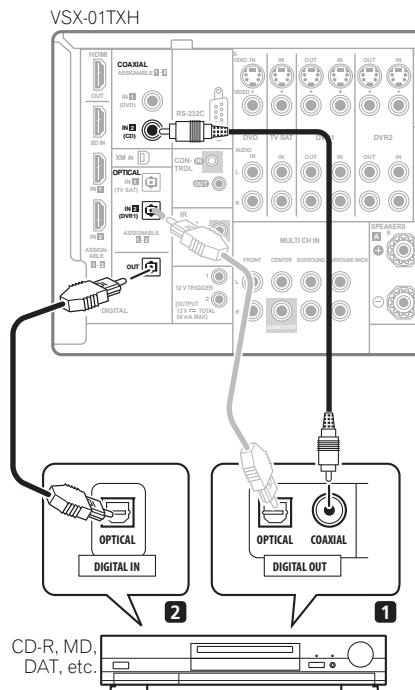

### Note

- In order to record, you must connect the analog audio cables (the digital connection is for playback only).
- If your video component doesn't have a digital audio output, you can skip this step.

<sup>2</sup> If your recorder only has a coaxial digital output, you can connect it to one of the coaxial inputs on this receiver using a coaxial digital audio cable. When you set up the receiver you'll need to tell the receiver which input you connected the recorder to (see also *The Input Setup menu* on page 69).

### 1 Connect a coaxial-type<sup>1</sup> digital audio output on your digital component to the COAXIAL IN 2 (CD) input.

Use a coaxial cable for the connection.

### 2 For recording equipment, connect the optical-type DIGITAL output to a digital input on the recorder.

Use an optical cable to connect to the OPTICAL OUT.<sup>2</sup>

## About the WMA9 Pro decoder

This receiver has an on-board Windows Media™ Audio 9 Professional<sup>3</sup> (WMA9 Pro) decoder, so it is possible to playback WMA9 Pro-encoded audio using a coaxial or optical digital connection when connected to a WMA9 Pro-compatible player. However, the connected PC, DVD player, set-top box, etc. must be able to output WMA9 Pro format audio signals through a coaxial or optical digital output.

## Connecting analog audio sources

This receiver features two stereo audio-only inputs. One of these inputs (**CD-R**) has corresponding outputs for use with audio recorders.

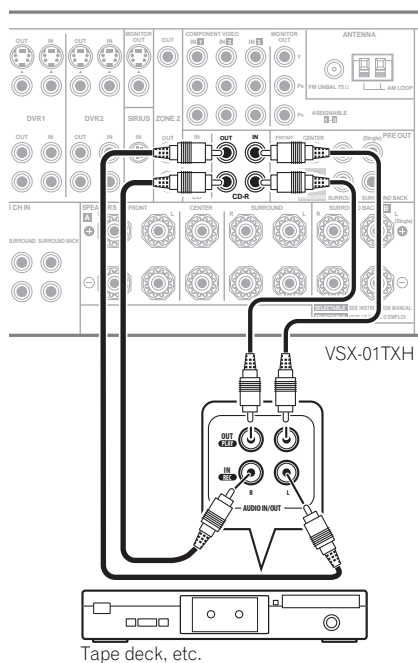

Tape deck, etc.

### • Connect the analog audio outputs of the source component to one of the AUDIO inputs.

Connect using a stereo RCA/phono jack audio cable.

- If you're connecting a tape deck, MD recorder, etc., connect the analog audio outputs (**OUT**) to the analog audio inputs on the recorder.

## Connecting a component to the front panel inputs

The front panel inputs comprise a composite video jack (**VIDEO**), stereo analog audio inputs (**AUDIO L/R**) and an optical digital audio input (**DIGITAL IN**). You can use these connections for any kind of audio/video component, but they are especially convenient for portable equipment such as camcorders, video games and portable audio/video equipment.

- Push down on the **PUSH OPEN** tab to access the front video connections.

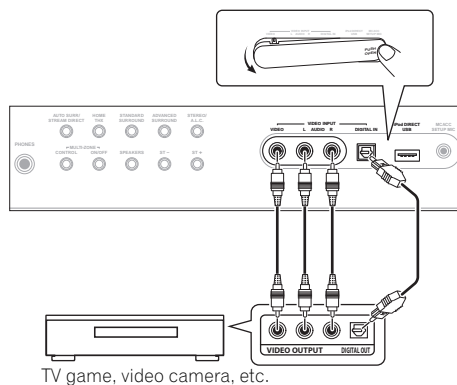

TV game, video camera, etc.

- Select these inputs by pressing **VIDEO** or using **INPUT SELECT** (remote) to select **VIDEO**.

### Note

1 • If your digital component only has an optical digital output, you can connect it to one of the optical inputs on this receiver using an optical cable. When you set up the receiver you'll need to tell the receiver which input you connected the component to (see also *The Input Setup menu* on page 69).

• The digital outputs from other components can be connected to any spare digital audio inputs on this receiver. You can assign them when setting up the receiver (see also *The Input Setup menu* on page 69).

2 In order to record some digital sources, you must make analog connections as explained in *Connecting analog audio sources* below.

3 • *Windows Media* and the *Windows logo* are trademarks or registered trademarks of Microsoft Corporation in the United States and/or other countries.

• With WMA9 Pro, sound problems may occur depending on your computer system. Note that WMA9 Pro 96 kHz sources will be downsampled to 48 kHz.

## Installing your speaker system

To take full advantage of the receiver's surround sound capabilities connect front, center, surround and surround back speakers, as well as a subwoofer.<sup>1</sup> Although this is ideal, other configurations with fewer speakers—no subwoofer or no center speaker, or even no surround speakers—will work. At the very least, front left and right speakers only are necessary. Note that your main surround speakers should always be connected as a pair, but you can connect just one surround back speaker if you like (it must be connected to the left surround back terminal). You can use speakers with a nominal impedance between 6 Ω and 16 Ω (please see *Switching the speaker impedance* on page 76 if you plan to use speakers with an impedance of less than 8 Ω).

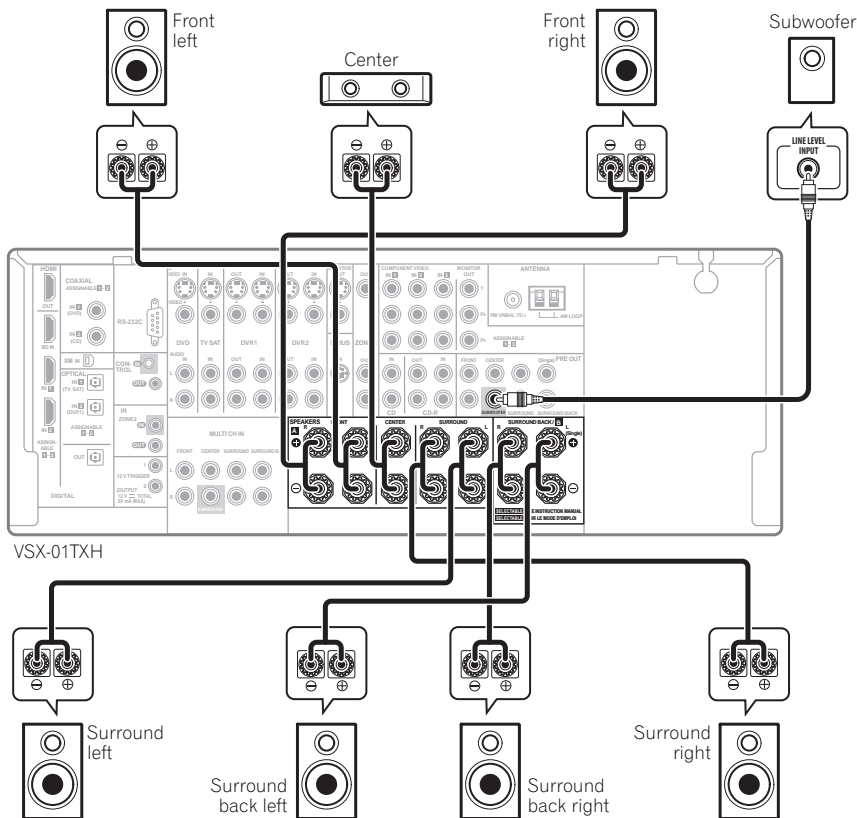

### Connecting the speakers

Each speaker connection on the receiver comprises a positive (+) and negative (-) terminal. Make sure to match these up with the terminals on the speakers themselves.

### ⚠ Caution

- These speaker terminals carry **HAZARDOUS LIVE voltage**. To prevent the risk of electric shock when connecting or disconnecting the speaker cables, disconnect the power cord before touching any uninsulated parts.
- Make sure that all the bare speaker wire is twisted together and inserted fully into the speaker terminal. If any of the bare speaker wire touches the back panel it may cause the power to cut off as a safety measure.

### 📌 Note

- When using only one surround back speaker, connect it to the **SURROUND BACK L** (Single) terminals.
- To use a 5.1-channel speaker set, use the surround speakers for the surround channel, not the surround back channel.

### Bare wire connections

Make sure that the speaker cable you're going to use is properly prepared with about 10 mm ( $\frac{3}{8}$  in.) of insulator stripped from each wire, and the exposed wire strands twisted together (*fig. A*).

To connect a terminal, unscrew the terminal a few turns until there is enough space to insert the exposed wire (*fig. B*). Once the wire is in position, tighten the terminal until the wire is firmly clamped (*fig. C*).

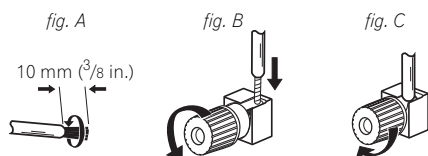

### Banana plug connections

If you want to use speaker cables terminated with banana plugs, screw the speaker terminal fully shut, then plug the banana plug into the end of the speaker terminal.

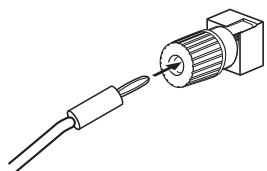

### Important

- Please refer to the manual that came with your speakers for details on how to connect the other end of the speaker cables to your speakers.
- *Other connections* on page 52 provides greater detail on alternate speaker setups, such as using speaker system B (page 59), bi-amping and bi-wiring (page 60).
- If you are using a THX certified subwoofer use the **THX INPUT** jack on the subwoofer (if your subwoofer has one) or switch the filter position to **THX** on your subwoofer.

### Placing the speakers

Where you put your speakers in the room has a big effect on the quality of the sound. The following guidelines should help you to get the best sound from your system.

- The subwoofer can be placed on the floor. Ideally, the other speakers should be at about ear-level when you're listening to them. Putting the speakers on the floor (except the subwoofer), or mounting them very high on a wall is not recommended.
- For the best stereo effect, place the front speakers 2 m to 3 m (6 ft. to 9 ft.) apart, at equal distance from the TV.

- When placing speakers near the TV, we recommend using magnetically shielded speakers to prevent possible interference, such as discoloration of the picture when the TV is switched on. If you do not have magnetically shielded speakers and notice discoloration of the TV picture, move the speakers farther away from the TV.
- If you're using a center speaker, place the front speakers at a wider angle. If not, place them at a narrower angle.
- Place the center speaker above or below the TV so that the sound of the center channel is localized at the TV screen. Also, make sure the center speaker does not cross the line formed by the leading edge of the front left and right speakers.
- It is best to angle the speakers towards the listening position. The angle depends on the size of the room. Use less of an angle for bigger rooms.
- Surround and surround back speakers should be positioned 60 cm to 90 cm (2 ft. to 3 ft.) higher than your ears and tilted slight downward. Make sure the speakers don't face each other. For DVD-Audio, the speakers should be more directly behind the listener than for home theater playback.
- Try not to place the surround speakers farther away from the listening position than the front and center speakers. Doing so can weaken the surround sound effect.
- To achieve the best possible surround sound, install your speakers as shown below. Be sure all speakers are installed securely to prevent accidents and improve sound quality.

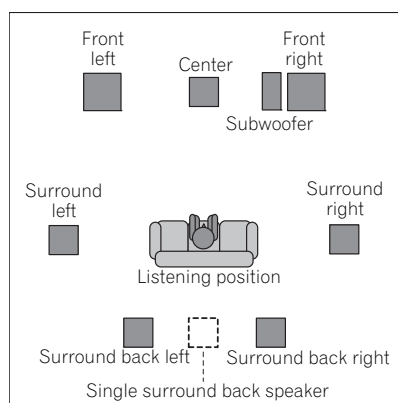

### Caution

- Make sure that all speakers are securely installed. This not only improves sound quality, but also reduces the risk of damage or injury resulting from speakers being knocked over or falling in the event of external shocks such as earthquakes.

The diagrams below show suggested surround and surround back speaker orientation. The first diagram (*fig. A*) shows orientation with one surround back speaker (or none) connected. The second (*fig. B*) shows orientation with two surround back speakers connected.

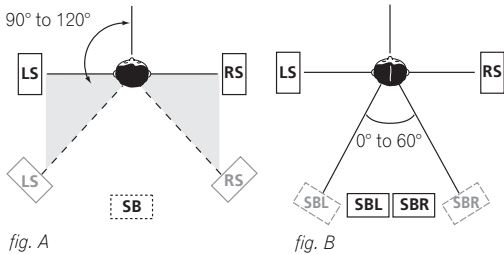

- If you have two surround back speakers THX recommends placing them together and the same distance from your listening position (see below).

### THX speaker system setup

If you have a complete THX speaker system, follow the diagram below to place your speakers. Note that the surround speakers (⊞ indicates bi-polar radiating speakers) should output at an angle parallel to the listener.

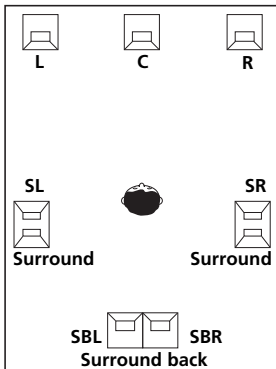

- If you have two surround back speakers THX recommends placing them together and the same distance from your listening position for the following THX modes: **THX Select2 CINEMA**, **THX MUSICMODE** and **THX GAMES MODE**.

See also *THX Audio Setting* on page 50 to make the settings that will give you the best sound experience when using the Home THX modes (page 31).

### Connecting antennas

Connect the AM loop antenna and the FM wire antenna as shown below. To improve reception and sound quality, connect external antennas (see *Connecting external antennas* on page 24).

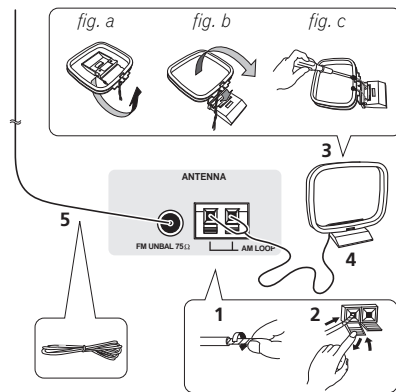

- 1 Pull off the protective shields of both AM antenna wires.**
- 2 Push open the tabs, then insert one wire fully into each terminal, then release the tabs to secure the AM antenna wires.**
- 3 Fix the AM loop antenna to the attached stand.**  
To fix the stand to the antenna, bend in the direction indicated by the arrow (*fig. a*), then clip the loop onto the stand (*fig. b*).
  - If you plan to mount the AM antenna to a wall or other surface, secure the stand with screws (*fig. c*) before clipping the loop to the stand. Make sure the reception is clear.
- 4 Place the AM antenna on a flat surface and in a direction giving the best reception.**
- 5 Connect the FM wire antenna in the same way as the AM loop antenna.**

For best results, extend the FM antenna fully and fix to a wall or door frame. Don't drape loosely or leave coiled up.

### Connecting external antennas

To improve FM reception connect an external FM antenna to the **FM UNBAL 75 Ω** terminal.

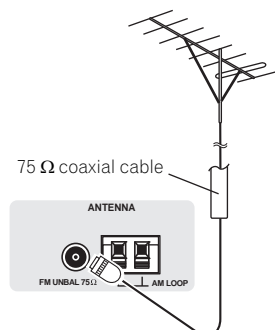

To improve AM reception, connect a 5 m to 6 m (16 ft. to 20 ft.) length of vinyl-coated wire to the **AM LOOP** terminals without disconnecting the supplied AM loop antenna.

For the best possible reception, suspend horizontally outdoors.

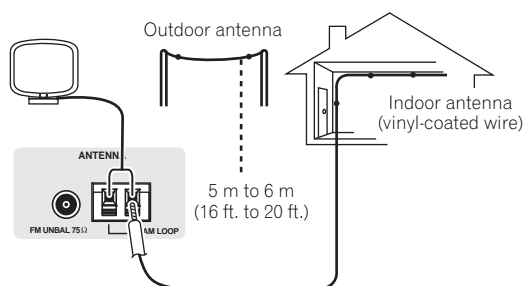

### Plugging in the receiver

Only plug in after you have connected all your components to this receiver, including the speakers.

#### Caution

- Handle the power cord by the plug part. Do not pull out the plug by tugging the cord, and never touch the power cord when your hands are wet, as this could cause a short circuit or electric shock. Do not place the unit, a piece of furniture, or other object on the power cord or pinch the cord in any other way. Never make a knot in the cord or tie it with other cables. The power cords should be routed so that they are not likely to be stepped on. A damaged power cord can cause a fire or give you an electric shock. Check the power cord once in a while. If you find it damaged, ask your nearest Pioneer authorized independent service company for a replacement.
- The receiver should be disconnected by removing the mains plug from the wall socket when not in regular use, e.g., when on vacation.
- Make sure the blue  **STANDBY/ON** light has gone out before unplugging.
- **Plug the power cord into a power outlet.**



## Chapter 4: Controls and displays

### Front panel

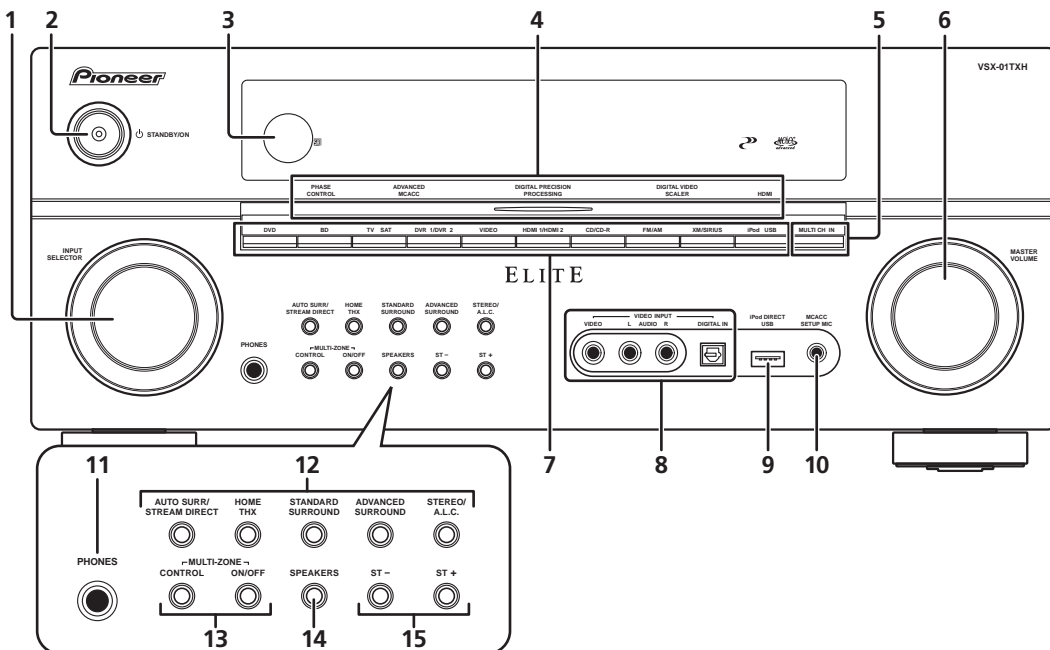

#### 1 INPUT SELECTOR dial

Use to select an input source.

#### 2 STANDBY/ON

Switches the receiver between on and standby. Power indicator lights when the receiver is on.

#### 3 Remote sensor

Receives the signals from the remote control (see *Operating range of remote control* on page 26).

**4 PHASE CONTROL indicator** – Lights when the Phase Control is switched on (page 12).

**ADVANCED MCACC indicator** – Lights when one of the MCACC presets (page 33) is selected.<sup>1</sup>

**DIGITAL PRECISION PROCESSING indicator** – Lights to indicate digital processing (for example, it disappears when Pure Direct (page 33) is on, or when listening through the multichannel analog inputs).

**DIGITAL VIDEO SCALER indicator** – Lights when Resolution is set to a setting other than **PURE** (for example, when the video input signal is upscaled) (page 73).

**HDMI indicator** – Blinks when connecting an HDMI-equipped component; lights when the component is connected (page 67).

#### 5 MULTI CH IN

Press to select the multichannel analog inputs (page 59).

#### 6 MASTER VOLUME dial

#### 7 Input source buttons

Press to select an input source.

#### 8 VIDEO INPUT

See *Connecting a component to the front panel inputs* on page 20.

#### 9 iPod DIRECT USB terminal

Use to connect your Apple iPod as an audio source (page 52), or connect a USB audio device for playback (page 54).

#### Note

<sup>1</sup> The MCACC indicator does not light when the MCACC preset memory currently being selected has not been corrected with Acoustic Calibration EQ Professional or when **EQ** is set to **OFF** in the Audio parameter menu (see *Setting the Audio options* on page 73).

**10 MCACC SETUP MIC jack**

Use to connect the supplied microphone.

**11 PHONES jack**

Use to connect headphones. When the headphones are connected, there is no sound output from the speakers.

**12 Listening mode buttons**

**AUTO SURR/STREAM DIRECT** – Switches between Auto surround mode (*Auto playback* on page 30) and Stream Direct playback. Stream Direct playback bypasses the bass/treble controls for the most accurate reproduction of a source (page 33).

**HOME THX** – Press to select a Home THX listening mode (page 31).

**STANDARD SURROUND** – Press for Standard decoding and to switch between the various **DOLBY** Pro Logic IIx and Neo:6 options (page 30).

**ADVANCED SURROUND** – Use to switch between the various surround modes (page 31).

**STEREO/A.L.C.** – Switches between stereo playback, Auto level control stereo mode and Front Stage Surround Advance modes (page 32).

**13 MULTI-ZONE controls**

If you've made MULTI-ZONE connections (see *MULTI-ZONE listening* on page 61), use these controls to control the sub zone from the main zone (see *Using the MULTI-ZONE controls* on page 62).

**14 SPEAKERS**

Use to change the speaker system (page 59).

**15 ST +/-**

Use to select preset radio stations (page 36).

**Operating range of remote control unit**

The remote control may not work properly if:

- There are obstacles between the remote control and the receiver's remote sensor.
- Direct sunlight or fluorescent light is shining onto the remote sensor.
- The receiver is located near a device that is emitting infrared rays.
- The receiver is operated simultaneously with another infrared remote control unit.

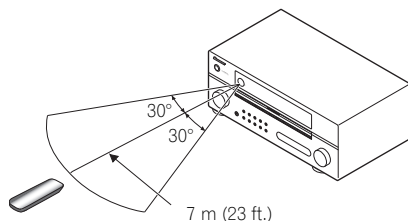

## Display

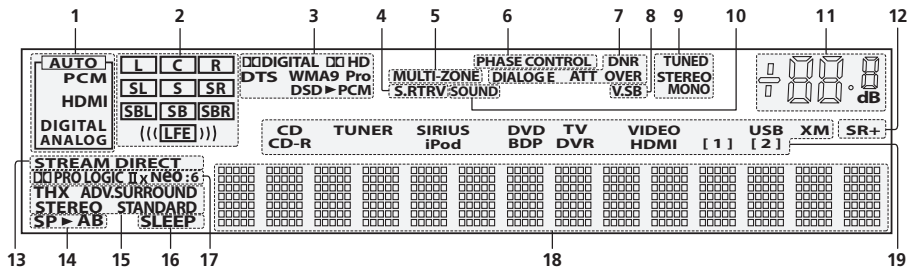

### 1 SIGNAL indicators

Light to indicate the currently selected input signal. **AUTO** lights when the receiver is set to select the input signal automatically (page 33).

### 2 Program format indicators

These change according to which channels are active in digital sources.

- L** – Left front channel
- C** – Center channel
- R** – Right front channel
- SL** – Left surround channel
- S** – Surround channel (mono)
- SR** – Right surround channel
- SBL** – Left surround back channel
- SB** – Surround back channel (mono)
- SBR** – Right surround back channel
- LFE** – Low frequency effects channel (the **((LFE))**) indicators light when an LFE signal is being input)

### 3 Digital format indicators

Light when a signal encoded in the corresponding format is detected (**DSD to PCM** lights during the DSD (Direct Stream Digital) to PCM conversion with SACDs).

### 4 S.RTRV

Lights when the Sound Retriever is switched on (page 73).

### 5 MULTI-ZONE

Lights when the MULTI-ZONE feature is active (page 61).

### 6 PHASE CONTROL

Lights when the Phase Control is switched on (page 12).

### 7 Sound processing indicators

Light according to the active Audio parameter(s) (page 73) and/or **ANALOG ATT** (page 76).

### 8 V.SB

Lights during Virtual surround back processing (page 34).

### 9 TUNER indicators

**TUNED** – Lights when a broadcast is being received.

**STEREO** – Lights when a stereo FM broadcast is being received in auto stereo mode.

**MONO** – Lights when the mono mode is set using the **MPX** button.

### 10 SOUND

Lights when any of the Midnight, Loudness or bass/treble controls feature is selected (page 73).

### 11 Master volume level

### 12 SR+

Lights when the SR+ mode is switched on (page 65).

### 13 STREAM DIRECT

Lights when Direct/Pure Direct is selected (page 33).

### 14 Speaker indicators

Indicate the current speaker system. **A** and/or **B** (page 59).

### 15 Listening mode indicators

**THX** – Lights when a Home THX mode is selected.

**ADV. SURROUND** – Lights when an Advanced Surround mode has been selected (page 31).

**STEREO** – Lights when the stereo mode is selected (page 32).

**STANDARD** – Lights when a Standard Surround mode is switched on (see *Listening in surround sound* on page 30).

### 16 SLEEP

Lights when the receiver is in sleep mode (page 76).

### 17 Matrix decoding format indicators

**PRO LOGIC IIx** – This lights to indicate **PRO** Logic II / **PRO** Logic IIx decoding (page 30).

**Neo:6** – When one of the Neo:6 modes of the receiver is on, this lights to indicate Neo:6 processing (page 30).

### 18 Character display

Displays various system information.

### 19 Input source indicators

Light to indicate the input source you have selected.

## Remote control

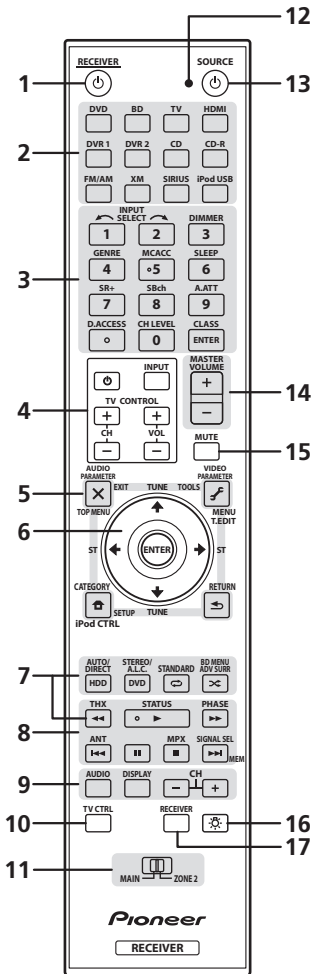

The remote has been conveniently color-coded according to component control using the following system (press the corresponding input source button to access):

- **White** – Receiver controls (see below)
- **Blue** – Other controls (page 80)

### 1 RECEIVER

This switches between standby and on for this receiver.

### 2 Input source buttons

Press to select control of other components (see *Controlling the rest of your system* on page 78).

### 3 Number buttons and other receiver/component controls

Use the number buttons to directly select a radio frequency (page 36) or the tracks on a CD, DVD, etc.

**ENTER** can be used to enter commands for TV or DTV, and also to select a disc in a multi-CD player.

Press **RECEIVER** first to access:

**INPUT SELECT** – Use to select the input source.

**DIMMER** – Dims or brightens the display (page 76).

**GENRE** – Automatically selects the most appropriate Advanced Surround mode for the genre of the source currently being played back (this feature is available only when a Pioneer DVD recorder supporting HDMI Control is connected to this receiver via HDMI) (page 35).

**MCACC** – Press to switch between MCACC presets (page 33).

**SLEEP** – Use to put the receiver in sleep mode and select the amount of time before sleep (page 76).

**SR+** – Switches the SR+ mode on/off (page 65).

**SBCh** – Use to select the surround/virtual back channel mode (page 34).

**A.ATT** – Attenuates (lowers) the level of an analog input signal to prevent distortion (page 76).

**CH LEVEL** – Press repeatedly to select a channel, then use **←/→** to adjust the level (page 49).

Press **FM/AM** first to access:

**D.ACCESS** – After pressing, you can access a radio station directly using the number buttons (page 36).

**CLASS** – Switches between the three banks (classes) of radio station presets (page 36).

### 4 TV CONTROL buttons

These buttons are dedicated to control the TV assigned to the **TV CTRL** button. Thus if you only have one TV to hook up to this system assign it to the **TV CTRL** input source button. If you have two TVs, assign the main TV to the **TV CTRL** button (see page 79 for more on this).

**TV**  – Use to turn on/off the power of the TV.

**INPUT** – Use to select the TV input signal.

**CH +/-** – Use to select channels.

**VOL +/-** – Use to adjust the volume on your TV.

### 5 Tuner/component control buttons/SETUP

These button controls can be accessed after you have selected the corresponding input source button (**DVD**, **DVR1**, **TV**, etc.). The **T.EDIT** tuner controls are explained from page 36.

Press **RECEIVER** first to access:

**AUDIO PARAMETER** – Use to access the Audio options (page 73).

**VIDEO PARAMETER** – Use to access the Video options (page 74).

**SETUP** – Use to access the System Setup menu (page 38).

**RETURN** – Press to confirm and exit the current menu screen (also use to return to the previous menu with DVDs or to select closed captioning with DTV).

## 6 ↑/↓/←/→ (TUNE/ST) /ENTER

Use the arrow buttons when setting up your surround sound system (page 38) and the Audio or Video options (page 73 or 74). Also used to control DVD menus/options and for deck 1 of a double cassette deck player. Use the **TUNE** ↑/↓ buttons to find radio frequencies and use **ST** ←/→ to find preset stations (page 36).

## 7 Receiver controls

Press **RECEIVER** first to access:

**AUTO/DIRECT** – Press to select Auto Surround (page 30) or Stream Direct (page 33) listening.

**STEREO/A.L.C.** – Switches between the stereo playback mode and the Front Stage Surround Advance mode (page 32).

**STANDARD** – Press for Standard decoding and to switch between the various **DL** Pro Logic IIx and Neo:6 options (page 30).

**ADV SURR** – Use to switch among the various surround modes (page 31).

**THX** – Press to select a Home THX listening mode (page 31).

## 8 Component control buttons

The main buttons (▶, ■, etc.) are used to control a component after you have selected it using the input source buttons.

The controls above these buttons can be accessed after you have selected the corresponding input source button (for example **DVD**, **DVR1** or **TV**). These buttons also function as described below.

Press **RECEIVER** first to access:

**STATUS** – Press to check selected receiver settings (page 76).

**PHASE** – Press to switch on/off Phase Control (page 12).

**SIGNAL SEL** – Use to select an input signal (page 33).

Press **TV** first to access:

**ANT** – Use to select the VHF/UHF antennas or Cable TV.

Press **FM/AM** first to access:

**MPX** – Switches between stereo and mono reception of FM broadcasts. If the signal is weak then switching to mono will improve the sound quality (page 36).

**9 AUDIO** – Changes the audio or channel on DVD discs.

**DISPLAY** – Switches between named station presets and radio frequencies (page 37).

**CH +/-** – Use to select channels for DVR units.

## 10 TV CTRL

Use this button to set preset code of your TV's manufacturer when controlling TV (see *Selecting preset codes directly* on page 78 for more on this).

## 11 MULTI-ZONE operation selector switch

Switch to perform operations in the main zone and zone 2 (page 61).

## 12 Remote control LED

Lights when a command is sent from the remote control.

## 13 SOURCE

Press to turn on/off other components connected to the receiver (see page 78 for more on this).

## 14 MASTER VOLUME +/-

Use to set the listening volume.

## 15 MUTE

Mutes the sound or restores the sound if it has been muted (adjusting the volume also restores the sound).

## 16 Remote control illumination button

Press to turn on/off the illumination of some of the buttons. This function is convenient when operating in dark rooms.

## 17 RECEIVER

Switches the remote to control the receiver (used to select the white commands above the number buttons (**A.ATT**, etc.)). Also use this button to set up surround sound (page 10, page 38).

## Chapter 5: Listening to your system

### Important

- The listening modes and many features described in this section may not be available depending on the current source, settings and status of the receiver. See *Listening modes with different input signal formats* on page 96 for more on this.

### Auto playback

There are many ways to listen back to sources using this receiver, but for the simplest, most direct listening option is the Auto Surround feature. The receiver automatically detects what kind of source you're playing and selects multichannel or stereo playback as necessary.<sup>1</sup>

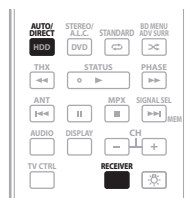

- While listening to a source, press **RECEIVER**, then press **AUTO/DIRECT (AUTO SURR/STREAM DIRECT)**<sup>2</sup> for auto playback of a source.

**AUTO SURROUND** shows briefly in the display before showing the decoding or playback format. Check the digital format indicators in the front panel display to see how the source is being processed.

- When listening to XM Radio, the XM HD Surround feature is selected automatically (see *Using XM HD Surround* on page 56 for more on this), and also when listening to the FM Radio, the Neural THX feature is selected automatically (see *Using Neural THX* on page 36 for more on this).

### Listening in surround sound

Using this receiver, you can listen to any source in surround sound. However, the options available will depend on your speaker setup and the type of source you're listening to.

If you connected surround back speakers, see also *Using surround back channel processing* on page 34.

### Standard surround sound

The following modes provide basic surround sound for stereo and multichannel sources.<sup>3</sup>

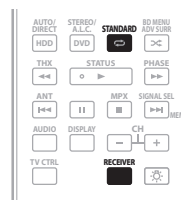

- While listening to a source, press **RECEIVER**, then press **STANDARD (STANDARD SURROUND)**. If necessary, press repeatedly to select a listening mode.
    - If the source is Dolby Digital, DTS, or Dolby Surround encoded, the proper decoding format will automatically be selected and shows in the display.<sup>4</sup>
- With two channel sources, you can select from:
- Pro Logic IIx MOVIE** – Up to 7.1 channel sound, especially suited to movie sources
  - Pro Logic IIx MUSIC** – Up to 7.1 channel sound, especially suited to music sources<sup>5</sup>
  - Pro Logic IIx GAME** – Up to 7.1 channel sound, especially suited to video games
  - PRO LOGIC** – 4.1 channel surround sound (sound from the surround speakers is mono)
  - Neo:6 CINEMA** – 6.1 channel sound, especially suited to movie sources
  - Neo:6 MUSIC** – 6.1 channel sound, especially suited to music sources<sup>6</sup>

### Note

1 • Stereo surround (matrix) formats are decoded accordingly using **Neo:6 CINEMA** or **Pro Logic IIx MOVIE** (see *Listening in surround sound* above for more on these decoding formats).

• The Auto Surround feature is canceled if you connect headphones.

2 For more options using this button, see *Using Stream Direct* on page 33.

3 In modes that give 6.1 channel sound, the same signal is heard from both surround back speakers.

4 If surround back channel processing (page 34) is switched off, or the surround back speakers are set to **NO** (this happens automatically if the *Surround back speaker setting* on page 41 is set to anything but **Normal**), **Pro Logic IIx** becomes **Pro Logic II** (5.1 channel sound).

5 When listening to 2-channel sources in Dolby Pro Logic IIx Music mode, there are three further parameters you can adjust: **C.WIDTH**, **DIMENSION**, and **PANORAMA**. See *Setting the Audio options* on page 73 to adjust them.

6 When listening to 2-channel sources in Neo:6 Cinema or Neo:6 Music mode, you can also adjust the center image effect (see *Setting the Audio options* on page 73).

- **Neural THX** – Up to 7.1 channel sound, especially suited to music sources<sup>1</sup>
- **XM HD Surround** – Up to 7.1 channel sound, especially suited to music sources<sup>2</sup>

With multichannel sources, if you have connected surround back speaker(s) and have selected **SBCh ON**, you can select (according to format):

- **Pro Logic IIx MOVIE** – See above (only available when you're using two surround back speakers)
- **Pro Logic IIx MUSIC** – See page 30
- **Dolby Digital EX** – Creates surround back channel sound for 5.1 channel sources and provides pure decoding for 6.1 channel sources (like Dolby Digital Surround EX)
- **DTS-ES** – Allows you to hear 6.1 channel playback with DTS-ES encoded sources
- **DTS Neo:6** – Allows you to hear 6.1 channel playback with DTS encoded sources

## Using the Home THX modes

THX and Home THX are technical standards created by THX Ltd. for cinema and home theater sound. Home THX is designed to make home theater audio sound more like what you hear in a cinema.

Different THX options will be available depending on the source and the setting for surround back channel processing (see *Using surround back channel processing* on page 34 for more on this).

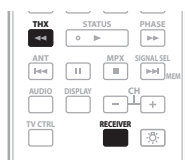

- Press **RECEIVER**, then press **THX (HOME THX)** to select a listening mode.<sup>3</sup>

With two channel sources, press **THX** repeatedly to select a matrix-decoding process for the **THX CINEMA** mode (see *Listening in surround sound* on page 30 for an explanation of each process):

- **Pro Logic IIx MOVIE+THX CINEMA**
- **PRO LOGIC+THX CINEMA**
- **Neo:6 CINEMA+THX CINEMA**
- **Pro Logic IIx MUSIC+THX MUSIC**
- **Neo:6 MUSIC+THX MUSIC**

- **Pro Logic IIx GAME+THX GAMES**
- **THX SELECT2 GAMES**

With multichannel sources, press **THX (HOME THX)** repeatedly to select from:

- **THX Surround EX** – Allows you to hear 6.1 or 7.1 channel playback with 5.1 channel sources
- **Pro Logic IIx MOVIE+THX CINEMA**
- **THX SELECT2 CINEMA** – Allows you to hear 7.1 channel playback with 5.1 channel sources
- **Pro Logic IIx MUSIC+THX MUSIC**
- **THX SELECT2 MUSIC** – This mode is suited not only for sources recorded in Dolby Digital and DTS, but also to all multi-channel music sources (DVD-Audio, etc.).
- **THX SELECT2 GAMES** – This mode is suited to playing the sound of games.

## Using the Advanced surround effects

The Advanced surround effects can be used for a variety of additional surround sound effects. Most Advanced Surround modes are designed to be used with film soundtracks, but some modes are also suited for music sources. Try different settings with various soundtracks to see which you like.

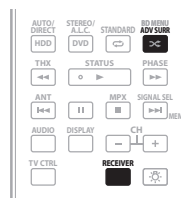

- Press **RECEIVER**, then press **ADV SURR (ADVANCED SURROUND)** repeatedly to select a listening mode.<sup>4</sup>

- **ACTION** – Designed for action movies with dynamic soundtracks
- **DRAMA** – Designed for movies with lots of dialog
- **SCI-FI** – Designed for science fiction with lots of special effects
- **MONOFILM** – Creates surround sound from mono soundtracks
- **ENT.SHOW** – Suitable for musical sources
- **EXPANDED** – Creates an extra wide stereo field<sup>5</sup>
- **TV SURROUND** – Provides surround sound for both mono and stereo TV sources

### Note

<sup>1</sup> Neural THX can be selected when the input signal is an analog, PCM signal or FM input.

<sup>2</sup> XM HD Surround can be selected only with the XM input.

<sup>3</sup> If you only have one surround back speaker connected, **THX SELECT2 GAMES** is not available.

<sup>4</sup> Depending on the source and the sound mode you have selected, you may not get sound from the surround back speakers in your setup. See *Using surround back channel processing* on page 34 for more on this.

• If you press **ADV SURR** when the headphones are connected, the **PHONES SURROUND** mode will automatically be selected.

<sup>5</sup> Use with Dolby Pro Logic for a stereo surround effect (stereo field is wider than Standard modes with Dolby Digital sources).

- **ADVANCED GAME** – Suitable for video games
- **SPORTS** – Suitable for sports programs
- **CLASSICAL** – Gives a large concert hall-type sound
- **ROCK/POP** – Creates a live concert sound for rock and/or pop music
- **UNPLUGGED** – Suitable for acoustic music sources
- **EXT.STEREO** – Gives multichannel sound to a stereo source, using all of your speakers
- **PHONES SURROUND** – When listening through headphones, you can still get the effect of overall surround.

### Tip

- When an Advanced Surround listening mode is selected, the effect level can be adjusted using the **EFFECT** parameter in *Setting the Audio options* on page 73.

## Listening in stereo

When you select **STEREO**, you will hear the source through just the front left and right speakers (and possibly your subwoofer depending on your speaker settings). Dolby Digital, DTS and WMA9 Pro multichannel sources are downmixed to stereo.

In the Auto level control stereo mode (A.L.C.), this receiver equalizes playback sound levels if each sound level varies with the music source recorded in a portable audio player.

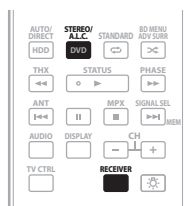

- While listening to a source, press **RECEIVER**, then press **STEREO/A.L.C.** for stereo playback.

Press repeatedly to switch between:

- **STEREO** – The audio is heard with your surround settings and you can still use the Midnight, Loudness, and bass/treble controls.
- **A.L.C.** – Listening in Auto level control stereo mode.
- **F.S.SURR FOCUS** – See *Using Front Stage Surround Advance* below for more on this.
- **F.S.SURR WIDE** – See *Using Front Stage Surround Advance* below for more on this.

## Using Front Stage Surround Advance

The Front Stage Surround Advance function allows you to create natural surround sound effects using just the front speakers and the subwoofer.

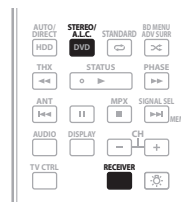

- While listening to a source, press **RECEIVER**, then press **STEREO/A.L.C.** to select Front Stage Surround Advance modes.

- **STEREO** – See *Listening in stereo* above for more on this.
- **A.L.C.** – See *Listening in stereo* above for more on this.
- **F.S.SURR FOCUS** – Use to provide a rich surround sound effect directed to the center of where the front left and right speakers sound projection area converges.
- **F.S.SURR WIDE** – Use to provide a surround sound effect to a wider area than **FOCUS** mode.<sup>1</sup>

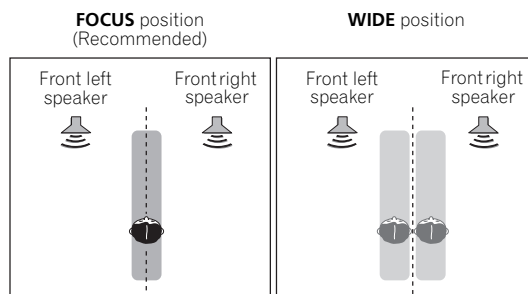

### Note

<sup>1</sup> When using **F.S.SURR WIDE**, a better effect can be obtained if Auto MCACC Setup is performed. See *Automatically setting up for surround sound (Auto MCACC)* on page 10 for more on this.



## Using Stream Direct

Use the Stream Direct modes when you want to hear the truest possible reproduction of a source. All unnecessary signal processing is bypassed, and you're left with the pure analog or digital sound source (see *Stream direct with different input signal formats* on page 101).

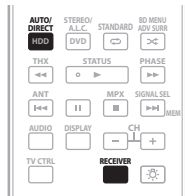

**1** While listening to a source, press **RECEIVER**, then press **AUTO/DIRECT (AUTO SURR/STREAM DIRECT)** to select the mode you want.

Check the digital format indicators in the front panel display to see how the source is being processed.

- **AUTO SURROUND** – See *Auto playback* on page 30.
- **DIRECT** – Sources are heard according to the settings made in the Surround Setup (speaker setting, channel level, speaker distance, acoustic calibration EQ, and X-curve), as well as with dual mono, the input attenuator, any sound delay and hi-bit settings. You will hear sources according to the number of channels in the signal.
- **PURE DIRECT** – Analog and PCM sources are heard without any digital processing.<sup>1</sup> No sound is output from the Second Zone in this mode.

## Selecting MCACC presets

- Default setting: **MEMORY 1**

If you have calibrated your system for different listening positions<sup>2</sup>, you can switch between settings to suit the kind of source you're listening to and where you're sitting (for example, watching movies from a sofa, or playing a video game close to the TV).

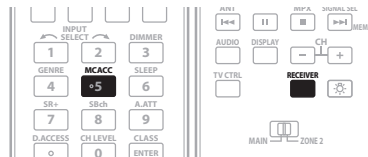

• While listening to a source, press **RECEIVER**, then press **MCACC**.

Press repeatedly to select one of the six MCACC presets<sup>3</sup> or to switch calibration off. See *Data Management* on page 46 to check and manage your current settings.

## Choosing the input signal

You need to hook up a component to both analog and digital inputs on the receiver to select between input signals.<sup>4</sup>

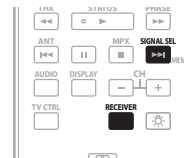

• Press **RECEIVER**, then press **SIGNAL SEL** to select the input signal corresponding to the source component.

Each press cycles through the options as follows:

- **AUTO** – This is the default setting. The receiver selects the first available signal in the following order: **HDMI; DIGITAL; ANALOG**.
- **ANALOG** – Selects an analog signal.
- **DIGITAL** – Selects an optical or coaxial digital signal.

### Note

- 1 There are cases where a brief noise is heard before playback of sources other than PCM. Please select **AUTO SURROUND** or **DIRECT** if this is a problem.
- 2 Different presets might also have separate calibration settings for the same listening position, depending on how you're using your system. These presets can be set in *Automatically setting up for surround sound (Auto MCACC)* on page 10 or *Automatic MCACC (Expert)* on page 38, either of which you should have already completed.
- 3 • These settings have no effect when headphones are connected.  
• You can also press **←/→** to select the MCACC preset.
- 4 • This receiver can only play back Dolby Digital, PCM (32 kHz to 192 kHz), DTS (including DTS 96 kHz/24 bit) and WMA9 Pro digital signal formats. The compatible signals via the HDMI terminals are: Dolby Digital, DTS, WMA 9 Pro, PCM (32 kHz, 44.1 kHz, 88.2 kHz and 96 kHz sampling frequencies), Dolby TrueHD, Dolby Digital Plus, DTS-EXPRESS, DTS-HD Master Audio, SACD and DVD Audio (including 192 kHz). With other digital signal formats, set to **ANALOG** (the **MULTI CH IN** and **FM/AM**).  
• You may get digital noise when a LD or CD player compatible with DTS is playing an analog signal. To prevent noise, make the proper digital connections (page 19) and set the signal input to **DIGITAL**.  
• Some DVD players don't output DTS signals. For more details, refer to the instruction manual supplied with your DVD player.

- **HDMI** – Selects an HDMI signal.<sup>1</sup>
- **PCM** – Only PCM signals are output.<sup>2</sup>

When set to **DIGITAL** or **AUTO**, **HD DIGITAL** lights with Dolby Digital or Dolby Digital Plus decoding, **HD HD** lights with Dolby TrueHD decoding, **DTS** lights with DTS or DTS-HD decoding, and **WMA9 Pro** lights to indicate that a WMA9 Pro signal is being decoded.

## Using surround back channel processing

- Default setting: **SBch ON**

You can have the receiver automatically use 6.1 or 7.1 decoding for 6.1 encoded sources (for example, Dolby Digital EX or DTS-ES), or you can choose to always use 6.1 or 7.1 decoding (for example, with 5.1 encoded material). With 5.1 encoded sources, a surround back channel will be generated, but the material may sound better in the 5.1 format for which it was originally encoded (in which case, you can simply switch surround back channel processing off).

The table below indicates when you will hear the surround back channel when playing various kinds of sources (●=Sound plays through surround back speaker(s)).

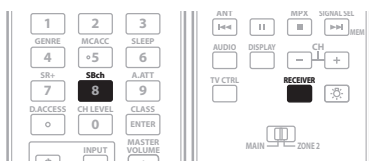

- **Press RECEIVER, then press SBch repeatedly to cycle the surround back channel options.**

Each press cycles through the options as follows:

- **SBch ON** – 6.1 or 7.1 decoding is always used (for example, a surround back channel will be generated for 5.1 encoded material)
- **SBch AUTO** – Automatically switches to 6.1 or 7.1 decoding for 6.1 encoded sources (for example, Dolby Digital EX or DTS-ES)
- **SBch OFF** – No sound is output from the surround back speakers

## Using the Virtual Surround Back mode

When you're not using surround back speakers, selecting this mode allows you to hear a virtual surround back channel through your surround speakers. You can choose to listen to sources with no surround back channel information, or if the material sounds better in the format (for example, 5.1) for which it was originally encoded, you can have the receiver only apply this effect to 6.1 encoded sources like Dolby Digital EX or DTS-ES.<sup>3</sup>

The table indicates when you will hear the virtual surround back channel (●=Virtual surround back channel is active).

- **Press SBch repeatedly to cycle the virtual surround back channel options.**

Each press cycles through the options as follows:

- **VirtualSB ON** – Virtual Surround Back is always used (for example, on 5.1 encoded material)
- **VirtualSB AUTO** – Virtual Surround Back is automatically applied to 6.1 encoded sources (for example, Dolby Digital EX or DTS-ES)
- **VirtualSB OFF** – Virtual Surround Back mode is switched off

Type of source	SBch Processing / Virtual SB mode	Standard / THX			Advanced surround
		Multichannel sources	Stereo sources		
			Pro Logic IIx	Pro Logic	
Dolby Digital EX/DTS-ES 5.1 ch sources with 6.1 ch flagged	ON	●			●
	AUTO	●			●
Dolby Digital/DTS/SACD and DVD-Audio 5.1 ch sources	ON	●			●
	AUTO	● <sup>c</sup>			●

### Note

<sup>1</sup> When the **HDMI** option in *Setting the Audio options* on page 73 is set to **THROUGH**, the sound will be heard through your TV, not from this receiver.

<sup>2</sup> • This is useful if you find there is a slight delay before **AUTO** recognizes the PCM signal on a CD, for instance.

• When **PCM** is selected, noise may be output during playback of non-PCM sources. Please select another input signal if this is a problem.

<sup>3</sup> • You can't use the Virtual Surround Back mode when the headphones are connected to this receiver or when any of the **THX**, stereo, Front Stage Surround Advance, Auto level control stereo or Stream Direct mode is selected.

• You can only use the Virtual Surround Back mode if the surround speakers are on and the **SB** setting is set to **NO** in the *Speaker Setting* on page 48.

• The Virtual Surround Back mode cannot be applied to sources that do not have surround channel information.

Type of source	SBch Processing / Virtual SB mode	Standard / THX			Advanced surround
		Multichannel sources	Stereo sources		
			Pro Logic IIx	Pro Logic	
Dolby Digital/DTS/PCM/SACD/WMA9 Pro and DVD-Audio stereo sources	ON		●	● <sup>a</sup>	●
	AUTO		● <sup>b</sup>		●
Analog 2-channel (stereo) sources	ON		●	● <sup>a</sup>	●
	AUTO		● <sup>b</sup>		●
DTS-HD Master Audio/DTS-HD/Dolby Digital Plus/Dolby TrueHD/WMA9 Pro encoded and PCM 6.1 ch/7.1 ch sources	ON	●			● <sup>d</sup>
	AUTO	●			● <sup>d</sup>
Dolby Digital Plus/Dolby TrueHD/WMA9 Pro encoded and PCM 5.1 ch sources	ON	●			● <sup>d</sup>
	AUTO	● <sup>c</sup>			● <sup>d</sup>
DTS-HD Master Audio/DTS-HD/DTS-EXPRESS encoded 5.1 ch sources	ON	● <sup>e</sup>			● <sup>d</sup>
	AUTO	● <sup>e</sup>			● <sup>d</sup>
Dolby Digital Plus/Dolby TrueHD encoded stereo sources	ON		●	● <sup>a</sup>	● <sup>d</sup>
	AUTO		● <sup>b</sup>		● <sup>d</sup>
DTS-HD Master Audio/DTS-HD/DTS-EXPRESS encoded stereo sources	ON				● <sup>d</sup>
	AUTO				● <sup>d</sup>

a. Only applicable when using the Virtual Surround Back mode.

b. Not applicable when using the Virtual Surround Back mode.

c. Sound is output from the surround back speakers only when **THX SELECT2 CINEMA**, **THX SELECT2 MUSIC** or **THX SELECT2 GAMES** is selected.

d. Advanced surround mode may not be available depending on the input signal.

e. Only applicable when two surround back speakers are connected. Also, depending on the input signal, it may happen that no sound is output from the surround back speakers.

## Using the genre synchronizing function

This feature automatically selects the most appropriate Advanced Surround mode for the source currently being played back on a Pioneer DVD recorder supporting HDMI Control connected to this receiver via HDMI.<sup>1</sup> For details on HDMI Control, see *About HDMI Control* on page 68.

### 1 Press RECEIVER, then press GENRE while the source assigned to a genre is being played back.

The most appropriate Advanced Surround mode for the source being played back is automatically selected.

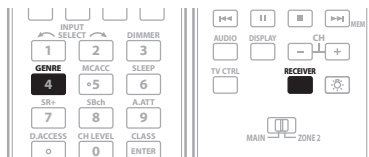

#### Note

1 • This feature is available only when the source being played back is assigned to a genre. When the source has no genre assigned to, **NO GENRE** appears showing that this feature is not available.

• Make sure that HDMI Control is set to **ON**. When **OFF** is selected, **CANNOT SELECT** appears showing that this feature is not available (see *Setting the HDMI options* on page 67).

## Chapter 6: Using the tuner

### Listening to the radio

The following steps show you how to tune in to FM and AM radio broadcasts using the automatic (search) and manual (step) tuning functions. If you already know the frequency of the station you want, see *Tuning directly to a station* below. Once you are tuned to a station you can memorize the frequency for recall later—see *Saving station presets* below for more on how to do this.

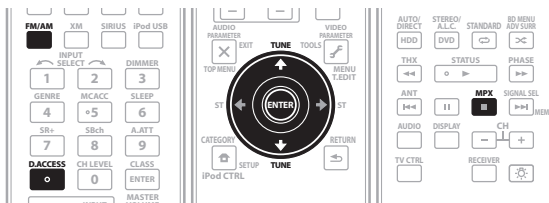

- 1 Press the **FM/AM** button to select the tuner.
- 2 Use the **FM/AM** button to change the band (FM or AM), if necessary. Each press switches the band between FM and AM.

- 3 **Tune to a station.** There are three ways to do this:

#### Automatic tuning

To search for stations in the currently selected band, press and hold **TUNE**  $\uparrow/\downarrow$  for about a second. The receiver will start searching for the next station, stopping when it has found one. Repeat to search for other stations.

#### Manual tuning

To change the frequency one step at a time, press **TUNE**  $\uparrow/\downarrow$ .

#### High speed tuning

Press and hold **TUNE**  $\uparrow/\downarrow$  for high speed tuning. Release the button at the frequency you want.

### Improving FM stereo sound

If the **TUNED** or **STEREO** indicators don't light when tuning to an FM station because the signal is weak, press the **MPX** button to switch the receiver into mono reception mode. This should improve the sound quality and allow you to enjoy the broadcast.

### Using Neural THX

This feature uses Neural Surround™, THX® technology to achieve optimal surround sound from FM radio.

- While listening to FM radio, press **AUTO/DIRECT** for Neural THX listening.

See *About Neural – THX Surround* on page 94 for more on this.

The **Neural THX** mode can be selected also with the **STANDARD** button.

### Tuning directly to a station

Sometimes, you'll already know the frequency of the station you want to listen to. In this case, you can simply enter the frequency directly using the number buttons on the remote control.

- 1 Press the **FM/AM** button to select the tuner.
- 2 Use the **FM/AM** button to change the band (FM or AM), if necessary. Each press switches the band between FM and AM.
- 3 Press **D.ACCESS** (Direct Access).
- 4 Use the number buttons to enter the frequency of the radio station.

For example, to tune to **106.00** (FM), press **1, 0, 6, 0, 0**. If you make a mistake halfway through, press **D.ACCESS** twice to cancel the frequency and start over.

### Saving station presets

If you often listen to a particular radio station, it's convenient to have the receiver store the frequency for easy recall whenever you want to listen to that station. This saves the effort of manually tuning in each time. This receiver can memorize up to 30 stations, stored in three banks, or classes (A, B and C) of 10 stations each. When saving an FM frequency, the MPX setting (see above) is also stored.

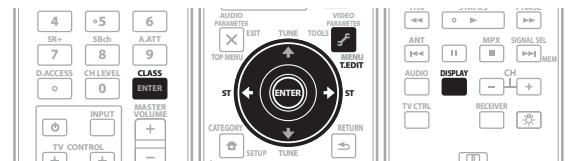

- 1 **Tune to a station you want to memorize.** See *Listening to the radio* above for more on this.
- 2 Press **T.EDIT** (Tuner Edit). The display shows **STATION MEMORY**, then a blinking memory class.
- 3 Press **CLASS** to select one of the three classes, then press **ST**  $\leftarrow/\rightarrow$  to select the station preset you want. You can also use the number buttons to select a station preset.

**4 Press ENTER.**

After pressing **ENTER**, the preset class and number stop blinking and the receiver stores the station.

**Naming station presets**

For easier identification, you can name your station presets.

**1 Choose the station preset you want to name.**

See *Listening to station presets* below for how to do this.

**2 Press T.EDIT (Tuner Edit).**

The display shows **STATION NAME**, then a blinking cursor at the first character position.

**3 Input the name you want.**

Choose from the following characters for a name up to four characters long.

**ABCDEFGHIJKLMNOPQRSTUVWXYZ**

**abcdefghijklmnopqrstuvwxyz**

**0123456789**

**!"#\$%&'()\*+,-./:;<=>?@[ \ ]^\_{ } ~ [space]**

Use **↑/↓** to select a character, **←/→** to set the position, and **ENTER** to confirm your selection.

**Tip**

- To erase a station name, simply repeat steps 1 to 3 and input four spaces instead of a name.
- Once you have named a station preset, you can press **DISPLAY** when listening to a station to switch the display between name and frequency.

**Listening to station presets**

You will need to have some presets stored to do this. See *Saving station presets* on page 36 if you haven't done this already.

**1 Press FM/AM to select the tuner.****2 Press CLASS to select the class in which the station is stored.**

Press repeatedly to cycle through classes A, B and C.

**3 Press ST ←/→ to select the station preset you want.**

- You can also use the number buttons on the remote control to recall the station preset.

## Chapter 7:

## The System Setup menu

## Making receiver settings from the System Setup menu

The following section shows you how to make detailed settings to specify how you're using the receiver (for example, if you want to set up two speaker systems in separate rooms), and also explains how to fine-tune individual speaker system settings to your liking.

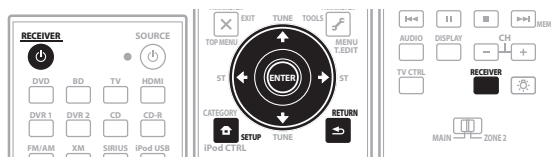

## 1 Switch on the receiver and your TV.

Use the **RECEIVER** button to switch on.<sup>1</sup>

- If headphones are connected to the receiver, disconnect them.

2 Press **RECEIVER** on the remote control, then press the **SETUP**.<sup>2</sup>

An on-screen display (OSD) appears on your TV. Use **↑/↓/←/→** and **ENTER** to navigate through the screens and select menu items. Press **RETURN** to confirm and exit the current menu.

- Press **SETUP** at any time to exit the System Setup menu.

## 3 Select the setting you want to adjust.

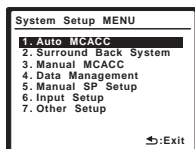

- **Auto MCACC** – See *Automatically setting up for surround sound (Auto MCACC)* on page 10 for a quick and effective automatic surround setup. See *Automatic MCACC (Expert)* below for a more detailed setup.

- **Surround Back System** – Specifies how you are using your surround back speakers (see *Surround back speaker setting* on page 41).
- **Manual MCACC** – Fine tunes your speaker settings and customize the Acoustic Calibration EQ (see *Manual MCACC setup* on page 41).
- **Data Management** – Checks your MCACC presets and manages them through copying, renaming or deleting (see *Data Management* on page 46).
- **Manual SP Setup** – Specifies the size, number, distance and overall balance of the speakers you've connected (see *Manual speaker setup* on page 48).
- **Input Setup** – Specifies what you've connected to the digital, HDMI and component video inputs (see *The Input Setup menu* on page 69).
- **Other Setup** – Makes customized settings to reflect how you are using the receiver (see *The Other Setup menu* on page 70).

## Automatic MCACC (Expert)

If your setup requires more detailed settings than those provided in *Automatically setting up for surround sound (Auto MCACC)* on page 10, you can customize your setup options below. You can calibrate your system differently for up to six different MCACC presets<sup>3</sup>, which are useful if you have different listening positions depending on the type of source (for example, watching movies from a sofa, or playing a video game close to the TV).<sup>4</sup>

**Important**

- Make sure the microphone/speakers are not moved during the Auto MCACC Setup.
- Using the Auto MCACC Setup will overwrite any existing settings for the MCACC preset you select.<sup>5</sup>
- The screen saver will automatically appear after three minutes of inactivity.

**Caution**

- The test tones used in the Auto MCACC Setup are output at high volume.

**Note**

<sup>1</sup> Make sure not to switch off the power when using the System Setup menu.

<sup>2</sup> • Note that when editing items in the **Manual MCACC** menu, you will need to first specify the MCACC preset you want to adjust by pressing **MCACC** before pressing **SETUP**.

• You can't use the System Setup menu when the **iPod USB**, **XM** or **SIRIUS** Radio input source is selected (in either the main or sub zone). When you set **ZONE 2 to ON** (page 62), you can't use the System Setup menu.

<sup>3</sup> These are stored in memory and referred to as **MEMORY1-6** (or **M1-6**) until you rename them in *Data Management* on page 46.

<sup>4</sup> You may also want to have separate calibration settings for the same listening position, depending on how you're using your system.

<sup>5</sup> Except in cases where you are only adjusting one parameter (i.e. channel level) from the **CUSTOM** setup screen (step 2).

## 1 Select 'Auto MCACC' from the System Setup menu, then press ENTER.

If the System Setup screen is not displayed, refer to *Making receiver settings from the System Setup menu* on page 38.

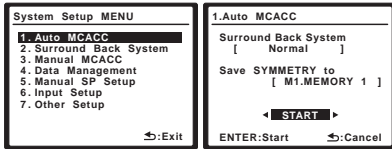

## 2 Make sure 'Normal' is selected,<sup>1</sup> select an MCACC preset<sup>2</sup>, then select START.<sup>3</sup>

For a fully customized Auto MCACC setup, select **CUSTOM** and set the following parameters using  $\leftarrow/\rightarrow$ :<sup>4</sup>

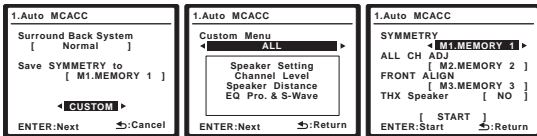

- **Custom Menu** – The default is **ALL** (recommended), but you can limit the system calibration to only one setting (to save time) if you want.<sup>5</sup> The available options are **ALL**, **Keep SP System**,<sup>6</sup> **Speaker Setting**, **Channel Level**, **Speaker Distance** and **EQ Pro. & S-Wave**.
- **EQ Type** (only available when the Custom Menu above is **EQ Pro. & S-Wave**) – This determines how the frequency balance is adjusted.

After a single calibration is performed, each of the following three correction curves can be stored separately in the MCACC memory. **SYMMETRY** (default) implements symmetric correction for each pair of left and right speakers to flatten the frequency-amplitude characteristics. **ALL CH ADJUST** is a 'flat' setting where all the speakers are set individually so no special weighting is given to any one channel. **FRONT ALIGN**<sup>7</sup> sets all speakers in accordance with the front speaker settings (no equalization is applied to the front left and right channels).

- **THX Speaker** (only available when the Custom Menu above is **ALL** or **Speaker Setting**) – Select **YES** if you are using THX speakers (set all speakers to **SMALL**, otherwise leave it set to **NO**).
- **Stand.Wave Multi-Point** (only available when the Custom Menu above is **EQ Pro. & S-Wave**) – In addition to measurements at the listening position, you can use two more reference points for which test tones will be analyzed for standing waves. This is useful if you want to get a balanced 'flat' calibration for several seating positions in your listening area.<sup>8</sup> Place the microphone at the reference point indicated on-screen and note *the last microphone placement will be at your main listening position*:

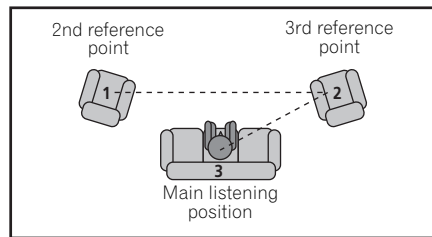

When you're finished settings the options, press **RETURN** to go back to the Auto MCACC main setup.

## 3 Connect the microphone to the MCACC SETUP MIC jack on the front panel.

Make sure there are no obstacles between the speakers and the microphone.



If you have a tripod, use it to place the microphone so that it's about ear level at your normal listening position. Otherwise, place the microphone at ear level using a table or a chair.

## 4 Follow the instructions on-screen.

- Make sure the microphone is connected.
- If you're using a subwoofer, it is automatically detected every time you switch on the system. Make sure it is on and the volume is turned up.

### Note

<sup>1</sup> If you are planning on bi-amping your front speakers, or setting up a separate speaker system in another room, read through *Surround back speaker setting* on page 41 and make sure to connect your speakers as necessary before continuing to step 3.  
<sup>2</sup> The six MCACC presets are used for storing surround sound settings for different listening positions. Simply choose an unused preset for now (you can rename it later in *Data Management* on page 46).  
<sup>3</sup> Note that correction curves are saved only when set to **SYMMETRY**. Select **CUSTOM** to save other correction curves (such as **ALL CH ADJUST** and **FRONT ALIGN**).  
<sup>4</sup> Select **DEMO**, and then press **ENTER** to activate the demo mode of Auto MCACC. In the demo mode, no settings are saved and no errors occur. When the speakers are connected to this receiver, the test tone is output repeatedly. Press **RETURN** to cancel the test tone.  
<sup>5</sup> • The **EQ Pro. & S-Wave** measurement is also taken when **ALL** is selected. See *Acoustic Calibration EQ Professional* on page 44 for more on this.  
 • Either effect of Acoustic Calibration EQ Professional and Standing Wave can be switched on and off in the respective MCACC preset. For details, see *Setting the Audio options* on page 73.  
<sup>6</sup> The **Keep SP System** option allows you to calibrate your system while leaving your current speaker setting (page 48) unchanged.  
<sup>7</sup> If you selected **ALL** as your **Custom Menu**, you can specify the MCACC preset where you want to save the **ALL CH ADJUST** and **FRONT ALIGN** settings.  
<sup>8</sup> Switch the **Multi-Point** setting **NO** if you only use one listening position.



- See *Problems when using the Auto MCACC Setup* on page 11 for notes regarding high background noise levels and other possible interference.

### 5 Wait for the Auto MCACC Setup to finish outputting test tones.

A progress report is displayed on-screen while the receiver outputs test tones to determine the speakers present in your setup. Try to be as quiet as possible while it's doing this.

- Do not adjust the volume during the test tones. This may result in incorrect speaker settings.
- With error messages (such as **Too much ambient noise!** or **Check Microphone**) select **RETRY** after checking for ambient noise (see *Problems when using the Auto MCACC Setup* on page 11) and verifying the mic connection. If there doesn't seem to be a problem, you can simply select **GO NEXT** and continue.

### 6 If necessary, confirm the speaker configuration in the OSD.<sup>1</sup>

The configuration shown on-screen should reflect the actual speakers you have.

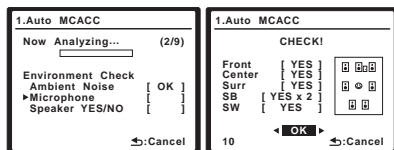

If no operations are performed for 10 seconds while the speaker configuration check screen is being displayed, the Auto MCACC Setup will resume automatically. In this case, you don't need to select **OK** and press **ENTER** in step 7.

If you see an error message (**ERR**) in the right side column (or the speaker configuration displayed isn't correct), there may be a problem with the speaker connection. If selecting **RETRY** doesn't work, turn off the power and check the speaker connections. If there doesn't seem to be a problem, you can simply use **↑/↓** to select the speaker and **←/→** to change the setting (and number for surround back) and continue.

### 7 Make sure 'OK' is selected, then press ENTER.

A progress report is displayed on-screen while the receiver outputs more test tones to determine the optimum receiver settings for channel level, speaker distance, and Acoustic Calibration EQ.

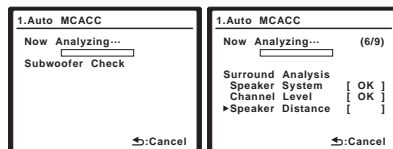

Again, try to be as quiet as possible while this is happening. It may take 3 to 7 minutes.

- If you selected a **Stand.Wave Multi-Point** setup (in step 2), you will be asked to place the mic at the 2nd and 3rd reference points before finally placing it at your main listening position.

### 8 The Auto MCACC Setup has finished! Press RETURN to go back to the System Setup menu.

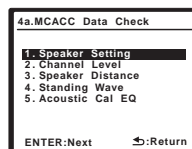

The settings made in the Auto MCACC Setup should give you excellent surround sound from your system, but it is also possible to adjust these settings manually using the System Setup menu (starting on page 38).<sup>2</sup>

You can also choose to view the settings by selecting individual parameters from the MCACC Data Check screen:

- **Speaker Setting** – The size and number of speakers you've connected (see page 48 for more on this)
- **Channel Level** – The overall balance of your speaker system (see page 49 for more on this)
- **Speaker Distance** – The distance of your speakers from the listening position (see page 50 for more on this)<sup>3</sup>
- **Standing Wave** – Filter settings to control lower 'boomy' frequencies (see page 43 for more on this)
- **Acoustic Cal EQ** – Adjustments to the frequency balance of your speaker system based on the acoustic characteristics of your room (see page 44 for more on this)

#### Note

<sup>1</sup> This screen is only shown if you selected **ALL** or **Speaker Setting** in **Custom Menu** from the Auto MCACC **CUSTOM** menu.

<sup>2</sup> Depending on the characteristics of your room, sometimes identical speakers with cone sizes of around 12 cm (5 inches) will end up with different size settings. You can correct the setting manually using the *Manual speaker setup* on page 48.

• The subwoofer distance setting may be farther than the actual distance from the listening position. This setting should be accurate (taking delay and room characteristics into account) and generally does not need to be changed.

• If Auto MCACC Setup measurement results are incorrect due to the interaction of the speakers and viewing environment, we recommend adjusting the settings manually.

<sup>3</sup> Since the distance measurements have been set according to the sound characteristics of your speakers, there are cases where (for optimal surround sound) the actual distance may differ from the speaker distance setting.



Press **ENTER** after you have finished checking each screen. When you're finished, select **RETURN** to go back to the System Setup menu.

Be sure to disconnect the microphone from this receiver upon completion of the Auto MCACC setup.

## Surround back speaker setting

- Default setting: **Normal**

There are several ways you can use the surround back speaker channels with this system. In addition to a normal home theater setup where they are used for the surround back speakers, they can be used for bi-amping the front speakers or as an independent speaker system in another room.

### 1 Select 'Surround Back System' from the System Setup menu.

See *Making receiver settings from the System Setup menu* on page 38 if you're not already at this screen.

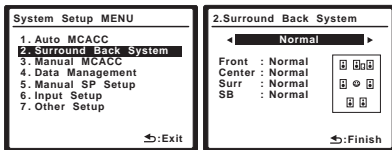

### 2 Select the surround back speaker setting.

- **Normal** – Select for normal home theater use with surround back speakers in your main (speaker system A) setup.
- **Speaker B** – Select to use the (surround back) B speaker terminals to listen to stereo playback in another room (see *Speaker B setup* on page 59).
- **Front Bi-Amp** – Select this setting if you're bi-amping your front speakers (see *Bi-amping your front speakers* on page 60).
- **ZONE 2** – Select to use the (surround back) B speaker terminals for an independent system in another zone (see *MULTI-ZONE listening* on page 61).

### 3 When you're finished, press RETURN.

You will return to the System Setup menu.

## Manual MCACC setup

You can use the settings in the Manual MCACC setup menu to make detailed adjustments when you're more familiar with the system. Before making these settings, you should have already completed *Automatically setting up for surround sound (Auto MCACC)* on page 10.

You only need to make these settings once (unless you change the placement of your current speaker system or add new speakers).

### Caution

- The test tones used in the System Setup are output at high volume.

### Important

- You will need to first specify the MCACC preset you want to adjust by pressing **MCACC** before pressing **SETUP** (step 2 in *Making receiver settings from the System Setup menu* on page 38). When Manual MCACC is selected while **MCACC** is set to **OFF**, the selection screen for the MCACC memory appears. Select a memory to adjust manually.

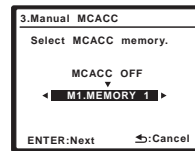

- For some of the settings below, you'll have to connect the setup microphone to the front panel and place it about ear level at your normal listening position. Press **SETUP** to display the System Setup menu before you connect the microphone to this receiver. If the microphone is connected while the System Setup menu is not being displayed, the display will change to the Auto MCACC setup menu. See *Problems when using the Auto MCACC Setup* on page 11 for notes regarding high background noise levels and other possible interference.
- If you're using a subwoofer, switch it on and turn up the volume to the middle position.

### 1 Select 'Manual MCACC' from the System Setup menu.

See *Making receiver settings from the System Setup menu* on page 38 if you're not already at this screen.

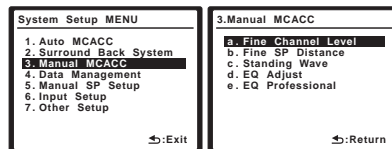

### 2 Select the setting you want to adjust.

If you're doing this for the first time, you might want to make these settings in order.

- **Fine Channel Level** – Make fine adjustments to the overall balance of your speaker system (see *Fine Channel Level* on page 42).
- **Fine SP Distance** – Make precise delay settings for your speaker system (see *Fine Speaker Distance* on page 42).

- **Standing Wave** – Control overly resonant low frequencies in your listening room (see *Standing Wave* on page 43).

The last two settings are specifically for customizing the parameters explained in *Acoustic Calibration EQ Adjust* on page 43:

- **EQ Adjust** – Manually adjust the frequency balance of your speaker system while listening to test tones (see *Acoustic Calibration EQ Adjust* on page 43).
- **EQ Professional** – Calibrate your system based on the direct sound coming from the speakers and make detailed settings according to your room's reverb characteristics (see *Acoustic Calibration EQ Professional* on page 44).

## Fine Channel Level

- Default setting: **0.0dB** (all channels)

You can achieve better surround sound by properly adjusting the overall balance of your speaker system. The following setting can help you make detailed adjustments that you may not achieve using the *Manual speaker setup* on page 48.

### 1 Select 'Fine Channel Level' from the Manual MCACC setup menu.

The volume increases to the 0.0 dB reference level.

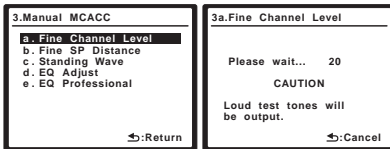

### 2 Adjust the level of the left channel.

This will be the reference speaker level, so you may want to keep the level around **0.0dB** so that you'll have plenty of room to adjust the other speaker levels.

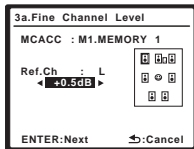

- After pressing **ENTER**, test tones will be output.

### 3 Select each channel in turn and adjust the levels (+/-10dB) as necessary.

Use **←/→** to adjust the volume of the speaker you selected to match the reference speaker. When it sounds like both tones are the same volume, press **↓** to confirm and continue to the next channel.

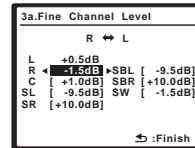

- For comparison purposes, the reference speaker will change depending on which speaker you select.
- If you want to go back and adjust a channel, simply use **↑/↓** to select it.

### 4 When you're finished, press RETURN.

You will return to the Manual MCACC setup menu.

## Fine Speaker Distance

- Default setting: **10'00"** (all speakers)

For proper sound depth and separation with your system, it is necessary to add a slight bit of delay to some speakers so that all sounds will arrive at the listening position at the same time. You can adjust the distance of each speaker in 1 inch increments. The following setting can help you make detailed adjustments that you may not achieve using the *Manual speaker setup* on page 48.

### 1 Select 'Fine SP Distance' from the Manual MCACC setup menu.

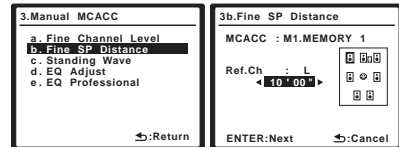

### 2 Adjust the distance of the left channel from the listening position.

### 3 Select each channel in turn and adjust the distance as necessary.

Use **←/→** to adjust the delay of the speaker you selected to match the reference speaker. The delay is measured in terms of speaker distance from **0'01"** to **45'00"**.

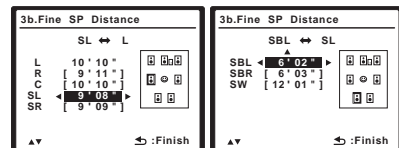

Listen to the reference speaker and use it to measure the target channel. From the listening position, face the two speakers with your arms outstretched pointing at each speaker. Try to make the two tones sound as if they are arriving simultaneously at a position slightly in front of you and between your arm span.<sup>1</sup>

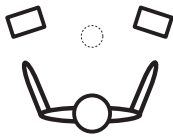

When it sounds like the delay settings are matched up, press **↓** to confirm and continue to the next channel.

- For comparison purposes, the reference speaker will change depending on which speaker you select.
- If you want to go back and adjust a channel, simply use **↑/↓** to select it.

#### 4 When you're finished, press RETURN.

You will return to the Manual MCACC setup menu.

### Standing Wave

- Default setting: **ON<sup>2</sup>/ATT 0.0dB** (all filters)

Acoustic standing waves occur when, under certain conditions, sound waves from your speaker system resonate mutually with sound waves reflected off the walls in your listening area. This can have a negative effect on the overall sound, especially at certain lower frequencies. Depending on speaker placement, your listening position, and ultimately the shape of your room, it results in an overly resonant ('boomy') sound. The Standing Wave Control uses filters to reduce the effect of overly resonant sounds in your listening area. During playback of a source, you can customize the filters used for Standing Wave Control for each of your MCACC presets.<sup>3</sup>

#### 1 Select 'Standing Wave' from the Manual MCACC setup menu.

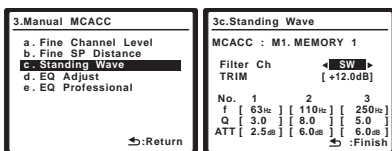

#### 2 Adjust the parameters for the Standing Wave Control.

- **Filter Ch** – Select the channel to which you will apply the filter(s): **MAIN** (all except center channel and subwoofer), **Center** or **SW** (subwoofer).
- **TRIM** (only available when Filter Ch above is **SW**) – Adjust the subwoofer channel level (to compensate for the difference in output post-filter).
- **f / Q / ATT** – These are the filter parameters where **f** represents the frequency you will be targeting and **Q** is the bandwidth (the higher the Q, the narrower the bandwidth, or range) of the attenuation (**ATT**, the amount of reduction to the targeted frequency).

#### 3 When you're finished, press RETURN.

You will return to the Manual MCACC setup menu.

### Acoustic Calibration EQ Adjust

- Default setting: **ON<sup>2</sup>/0.0dB** (all channels/bands)

Acoustic Calibration Equalization is a kind of room equalizer for your speakers (excluding the subwoofer). It works by measuring the acoustic characteristics of your room and neutralizing the ambient characteristics that can color the original source material (providing a 'flat' equalization setting). If you're not satisfied with the adjustment provided in *Automatically setting up for surround sound (Auto MCACC)* on page 10 or *Automatic MCACC (Expert)* on page 38, you can also adjust these settings manually to get a frequency balance that suits your tastes.<sup>4</sup>

#### 1 Select 'EQ Adjust' from the Manual MCACC setup menu.

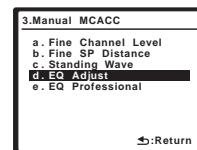

#### 2 Confirm that the MCACC preset shown in the display is the one you want to adjust, then select START.

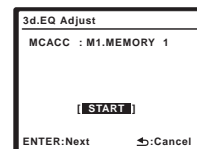

### Note

- If you can't seem to achieve this by adjusting the distance setting, you may need to change the angle of your speakers very slightly.
  - For better audibility, the subwoofer emits a continuous test tone (oscillating pulses are heard from your other speakers). Note that it may be difficult to compare this tone with the other speakers in your setup (depending on the low frequency response of the reference speaker).
- You can switch on or off the Standing Wave Control and Acoustic Cal EQ feature in the **AUDIO PARAMETER** menu. See *Setting the Audio options* on page 73 for more on this.
- Since they will be overwritten, you may want to save the standing wave settings made with the Auto MCACC Setup to another MCACC preset.
  - Standing Wave control filter settings cannot be changed during playback of sources using the HDMI connection.
  - When **Standing Wave** is selected for a MCACC preset memory where **S-WAVE** is set to **OFF** in the **AUDIO PARAMETER**, **S-WAVE ON** is automatically selected.
- When **EQ Adjust** is selected for a MCACC preset memory where **EQ** is set to **OFF** in the **AUDIO PARAMETER**, **EQ ON** is automatically selected.

### 3 Select the channel(s) you want and adjust to your liking.

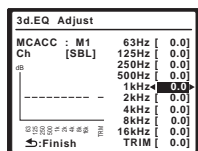

Use  $\leftarrow/\rightarrow$  to select the channel.

Use  $\uparrow/\downarrow$  to select the frequency and  $\leftarrow/\rightarrow$  to boost or cut the EQ. When you're finished, go back to the top of the screen and use  $\leftarrow/\rightarrow$  to select the next channel.

- The **OVER!** indicator shows in the display if the frequency adjustment is too drastic and might distort. If this happens, bring the level down until **OVER!** disappears from the display.

#### Tip

- Changing the frequency curve of one channel too drastically will affect the overall balance. If the speaker balance seems uneven, you can raise or lower channel levels using test tones with the **TRIM** feature. Use  $\uparrow/\downarrow$  to select **TRIM**, then use  $\leftarrow/\rightarrow$  to raise or lower the channel level for the current speaker.

### 4 When you're finished, press RETURN.

You will return to the Manual MCACC setup menu.

## Acoustic Calibration EQ Professional

This setup minimizes the unwanted effects of room reverberation by allowing you to calibrate your system based on the direct sound coming from the speakers. It can also provide you with a graphical output of the frequency response of your room.<sup>1</sup>

### How to use Acoustic Calibration EQ Professional

If you find that lower frequencies seem overly reverberant in your listening room (i.e. it sounds 'boomy'), or that different channels seem to exhibit different reverb characteristics, select **EQ Pro. & S-Wave** (or **ALL**) for the **Custom Menu** setting in *Automatic MCACC (Expert)* on page 38 to calibrate the room automatically. This should provide a balanced calibration that suits the characteristics of your listening room.

If you still aren't satisfied with the results, the manual Advanced EQ setup (below) provides a more customized calibration of your system using the direct sound of the speakers. This is done with the help of a graphical output that can be displayed on-screen, or using a computer (with software available from Pioneer — see *Connecting a PC for Advanced MCACC output* on page 66).

### How to interpret the graphical output

The graph shows decibels on the vertical axis and time (in milliseconds) on the horizontal axis. A straight line indicates a flat-response room (no reverb), whereas a sloping line indicates the presence of reverberation when outputting test tones. The sloping line will eventually flatten out when the reverberant sound stabilizes (this usually takes about 100 ms or so).

By analyzing the graph, you should be able to see how your room is responding to certain frequencies. Differences in channel level and speaker distance are taken into account automatically (compensation is provided for comparison purposes), and the frequency measurements can be examined both with and without the equalization performed by this receiver.<sup>2</sup>

### Setting Acoustic Calibration EQ Professional according to your room characteristics

Using the manual setup, you can set the time period at which the frequency response is analyzed, pinpointing the time that is best for system calibration with your particular room characteristics.

The graph below shows the difference between conventional acoustic calibration and professional calibration (the gray circle indicates the point where the microphone captures sound during frequency analysis).

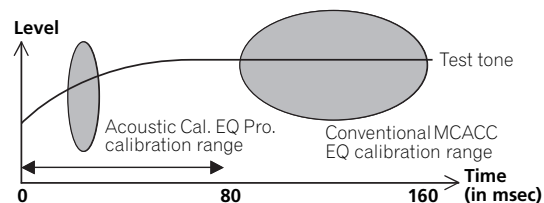

As soon as audio is output from your speaker system, it is influenced by room characteristics, such as walls, furniture, and the dimensions of the room. The sooner the frequency analysis, the less it is influenced by the room. We recommend an earlier time setting of **30~50ms** to compensate for two major factors that will influence the sound of most rooms:

#### Note

<sup>1</sup> This system allows you to customize your system calibration with the help of a graphical output that can be displayed on-screen, or using a computer (with software available from Pioneer—see *Connecting a PC for Advanced MCACC output* on page 66 for more on this).

<sup>2</sup> Note that due to an effect known as 'group delay', lower frequencies will take longer to be generated than higher frequencies (this is most obvious when comparing the frequencies at 0 ms). This initial slope is not a problem (i.e. excessive reverb) with your listening room.

- **Reverberance of high vs. low frequencies** – Depending on your room, you may find that lower frequencies seem overly reverberant compared to higher frequencies (i.e. your room sounds 'boomy'). This may result in a skewed frequency analysis if the measurement is done too late.

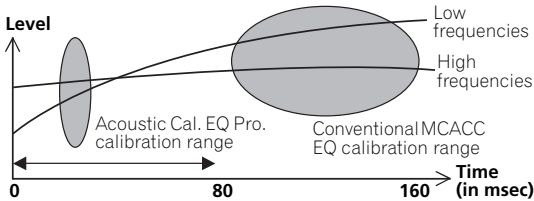

- **Reverb characteristics for different channels** – Reverb characteristics can be somewhat different for each channel. Since this difference increases as the sound is influenced by the various room characteristics, it is often better to capture a frequency analysis early on for smoother mixing of channel frequencies/sounds.

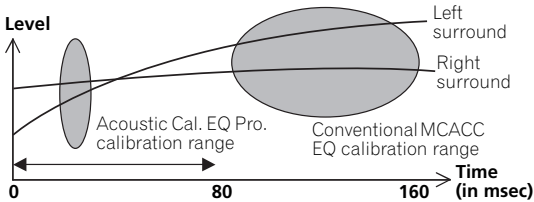

If your room isn't affected by the factors above, it is often not necessary to make a 30-50ms setting. Later time settings may provide a more detailed sound experience with your speaker system. It is best to try and see what works best for your particular room.

Note that changing the room (for example, moving furniture or paintings) will affect the calibration results. In such cases, you should recalibrate your system.

### Using Acoustic Calibration EQ Professional

- 1 Select 'EQ Professional', then press ENTER.

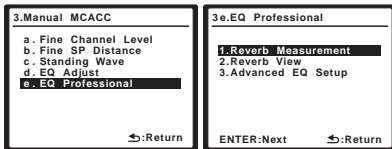

- 2 Select an option and press ENTER.

- **Reverb Measurement** – Use this to measure the reverb characteristics of your room (for graphical output using a PC, see *Connecting a PC for Advanced MCACC output* on page 66 to connect an RS-232C cable before selecting this option).
- **Reverb View** – You can check the reverb measurements made for specified frequency ranges in each channel.<sup>1</sup>
- **Advanced EQ Setup** – Use this to select the time period that will be used for frequency adjustment and calibration, based on the reverb measurement of your listening area. Note that customizing system calibration using this setup will alter the settings you made in *Automatically setting up for surround sound (Auto MCACC)* on page 10 or *Automatic MCACC (Expert)* on page 38 and is not necessary if you're satisfied with these settings.

- 3 If you selected 'Reverb Measurement', select EQ ON or OFF, then START.

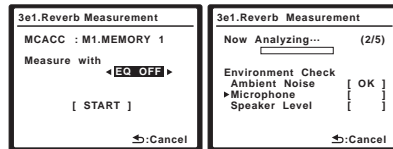

The following options determine how the reverb characteristics of your listening area are displayed in **Reverb View** and **Output PC (Data Management)**:

- **EQ OFF** – You will see the reverb characteristics of your listening area *without* the equalization performed by this receiver (before calibration).
- **EQ ON** – You will see the reverb characteristics of your listening area *with* the equalization performed by this receiver (after calibration).<sup>2</sup> Note that the EQ response may not appear entirely flat due to adjustments necessary for your listening area.

When the reverb measurement is finished, you can select **Reverb View** to see the results on-screen. See *Professional Calibration EQ graphical output* on page 86 for troubleshooting information.

### Note

<sup>1</sup> If the Reverb View procedure is performed after the *Automatically setting up for surround sound (Auto MCACC)* on page 10 or Reverb Measurement operation, depending on the standing wave control setting, differences may appear on the reverb graph. With the Auto MCACC function, the reverberations are measured with the standing waves controlled, so the reverb characteristics graph shows the characteristics with the effect of the standing waves eliminated. By contrast, the Reverb Measurement function measures the reverberations without controlling the standing waves, so the graph indicates the reverb characteristics including the effect of the standing waves (as such), we recommend using the Reverb Measurement function.

<sup>2</sup> The calibration corresponding to the currently selected MCACC preset will be used when **EQ ON** is selected. To use another MCACC preset, exit the System Setup menu and press **MCACC** to select it before pressing **SETUP**.

4 If you selected 'Reverb View', you can check the reverb characteristics for each channel. Press RETURN when you're done.

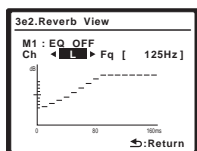

This appears according to the setting you chose in **Reverb Measurement** (step 3 on page 45). Use ←/→ to select the channel and the frequency you want to check. Use ↑/↓ to go back and forth between the two. Note that the markers on the vertical axis indicate decibels in 2 dB steps.

5 If 'Advanced EQ Setup' is selected, enter the desired time setting for calibration. Press ↓ to proceed to the next screen, and then select START.

Based on the reverb measurement above, you can choose the time period that will be used for the final frequency adjustment and calibration. Even though you can make this setting without reverb measurement, it is best to use the measurement results as a reference for your time setting. For an optimal system calibration based on the direct sound coming from the speakers, we recommend using the **30~50ms** setting.

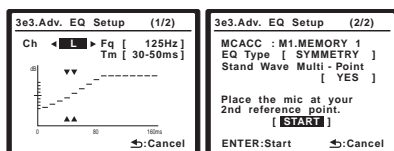

Use ←/→ to select the channel, frequency, and time setting. Use ↑/↓ to switch between them.

You can switch between your connected speakers (excluding the subwoofer), and display the measurements for the following frequencies: **63Hz, 125Hz, 250Hz, 500Hz, 1kHz, 2kHz, 4kHz, 8kHz and 16kHz.**

Select the setting from the following time periods (in milliseconds): **0~20ms, 10~30ms, 20~40ms, 30~50ms, 40~60ms, 50~70ms and 60~80ms.** This setting will be applied to all channels during calibration.

When you're finished, select **START**. It will take about 2 to 4 minutes for the calibration to finish.

After the Acoustic Calibration Equalization is set, you are given the option to check the settings on-screen.

## Data Management

This system allows you to store up to six MCACC presets, allowing you to calibrate your system for different listening positions (or frequency adjustments for the same listening position).<sup>1</sup> This is useful for alternate settings to match the kind of source you're listening to and where you're sitting (for example, watching movies from a sofa, or playing a video game close to the TV).

From this menu you can check your current settings, copy from one preset to another, name presets for easier identification and clear any ones you don't need.

### 1 Select 'Data Management' from the System Setup menu.

See *Making receiver settings from the System Setup menu* on page 38 if you're not already at this screen.

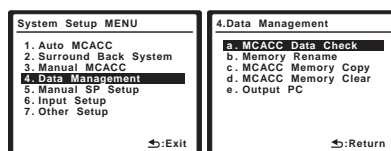

### 2 Select the setting you want to adjust.

- **MCACC Data Check** – Checks the settings for any of your MCACC presets using the on-screen display (see *Checking MCACC preset data* on page 47).
- **Memory Rename** – Names your MCACC presets for easy identification (see *Renaming MCACC presets* on page 47).
- **MCACC Memory Copy** – Copies settings from one MCACC preset to another (see *Copying MCACC preset data* on page 47).
- **MCACC Memory Clear** – Clears any MCACC presets that you don't want (see *Clearing MCACC presets* on page 47).
- **Output PC** – See *Connecting a PC for Advanced MCACC output* on page 66 for more on this.

#### Note

<sup>1</sup> This can be done in *Automatically setting up for surround sound (Auto MCACC)* on page 10 or *Automatic MCACC (Expert)* on page 38, either of which you should have already completed.



## Checking MCACC preset data

After you have completed *Automatically setting up for surround sound (Auto MCACC)* on page 10 or *Automatic MCACC (Expert)* on page 38, you can check your calibrated settings using the on-screen display.

- 1 Select 'MCACC Data Check' from the Data Management setup menu.

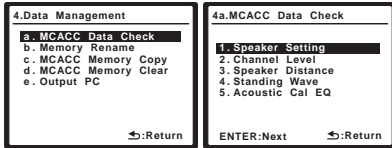

- 2 Select the setting you want to check.
  - It is useful to do this while a source is playing so you can compare the different settings.
- 3 Select the MCACC preset that you want to check. Use **↑/↓** if necessary to switch speakers/settings.

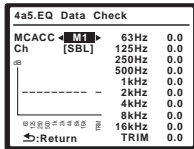

- 4 Press RETURN to go back to the Data Check menu, repeating steps 2 and 3 to check other settings.
- 5 When you're finished, press RETURN. You will return to the Data Management setup menu.

## Renaming MCACC presets

If you have several different MCACC presets that you're using, you may want to rename them for easier identification.

- 1 Select 'Memory Rename' from the Data Management setup menu.

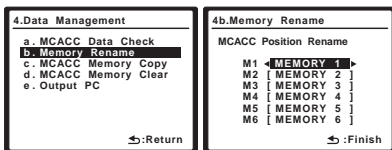

- 2 Select the MCACC preset you want to rename, then select an appropriate preset name. Use **↑/↓** to select the preset, then **←/→** to select a preset name.
- 3 Repeat for as many MCACC presets as necessary, then press RETURN when you're finished. You will return to the Data Management setup menu.

## Copying MCACC preset data

If you want to manually adjust the Acoustic Calibration EQ (see *Manual MCACC setup* on page 41), we recommend copying your current settings<sup>1</sup> to an unused MCACC preset. Instead of just a flat EQ curve, this will give you a reference point from which to start.

- 1 Select 'MCACC Memory Copy' from the Data Management setup menu.

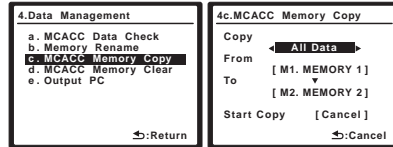

- 2 Select the setting you want to copy.
  - **All Data** – Copies all the settings of the selected MCACC preset memory.
  - **LEVEL & DISTANCE** – Copies only the channel level and speaker distance settings of the selected MCACC preset memory.

- 3 Select the MCACC preset you'll be copying the settings 'From', then specify where you want to copy them ('To').

Make sure you don't overwrite an MCACC preset you're currently using (this can't be undone).

- 4 Select 'Copy' to confirm and copy the settings. **Completed!** shows in the OSD to confirm the MCACC preset has been copied, then you automatically return to the Data Management setup menu.

## Clearing MCACC presets

If you are no longer using one of the MCACC presets stored in memory, you can choose to clear the calibration settings of that preset.

- 1 Select 'MCACC Memory Clear' from the Data Management setup menu.

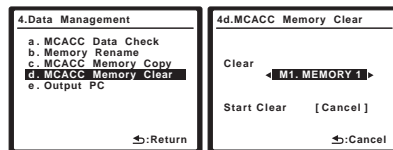

- 2 Select the MCACC preset you want to clear. Make sure you don't clear an MCACC preset you're currently using (this can't be undone).
- 3 Select 'Clear' to confirm and clear the preset. **Completed!** shows in the OSD to confirm the MCACC preset has been cleared, then you automatically return to the Data Management setup menu.

### Note

<sup>1</sup> The settings made in *Automatically setting up for surround sound (Auto MCACC)* on page 10 or *Automatic MCACC (Expert)* on page 38.

## Manual speaker setup

This receiver allows you to make detailed settings to optimize the surround sound performance. You only need to make these settings once (unless you change the placement of your current speaker system or add new speakers).

These settings are designed to customize your system, but if you're satisfied with the settings made in *Automatically setting up for surround sound (Auto MCACC)* on page 10, it isn't necessary to make all of these settings.



### Caution

- The test tones used in the System Setup are output at high volume.

### 1 Select 'Manual SP Setup', then press ENTER.

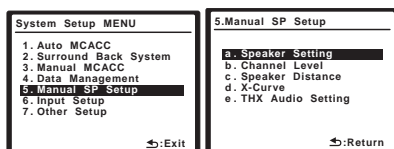

### 2 Select the setting you want to adjust.

If you are doing this for the first time, you may want to adjust these settings in order:

- Speaker Setting** – Specifies the size and number of speakers you've connected (see below).
- Channel Level** – Adjusts the overall balance of your speaker system (page 49).
- Speaker Distance** – Specifies the distance of your speakers from the listening position (page 50).
- X-Curve** – Adjusts the tonal balance of your speaker system for movie soundtracks (page 50).
- THX Audio Setting** – Specifies whether you are using a THX speaker setup (page 50).

### 3 Make the adjustments necessary for each setting, pressing RETURN to confirm after each screen.

## Speaker Setting

Use this setting to specify your speaker configuration (size, number of speakers and crossover frequency). It is a good idea to make sure that the settings made in *Automatically setting up for surround sound (Auto MCACC)* on page 10 are correct.<sup>1</sup> Note that this setting applies to all MCACC presets, and cannot be set independently.

### 1 Select 'Speaker Setting' from the Manual SP Setup menu.

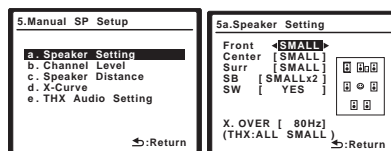

### 2 Choose the set of speakers that you want to set, then select a speaker size.

Use ←/→ to select the size (and number) of each of the following speakers.<sup>2</sup>

- Front** – Select **LARGE** if your front speakers reproduce bass frequencies effectively, or if you didn't connect a subwoofer. Select **SMALL** to send the bass frequencies to the subwoofer.
- Center** – Select **LARGE** if your center speaker reproduces bass frequencies effectively, or select **SMALL** to send bass frequencies to the other speakers or subwoofer. If you didn't connect a center speaker, choose **NO** (the center channel is sent to the front speakers).
- Surr** – Select **LARGE** if your surround speakers reproduce bass frequencies effectively. Select **SMALL** to send bass frequencies to the other speakers or subwoofer. If you didn't connect surround speakers choose **NO** (the sound of the surround channels is sent to the front speakers or a subwoofer).
- SB** – Select the number of surround back speakers you have (one, two or none).<sup>3</sup> Select **LARGE** if your surround back speakers reproduce bass frequencies effectively. Select **SMALL** to send bass frequencies to the other speakers or subwoofer. If you didn't connect surround back speakers choose **NO**.

### Note

- If you're using a THX speaker setup, set all speakers to **SMALL**.
- If you select **SMALL** for the front speakers the subwoofer will automatically be fixed to **YES**. Also, the center and surround speakers can't be set to **LARGE** if the front speakers are set to **SMALL**. In this case, all bass frequencies are sent to the subwoofer.
- If the surround speakers are set to **NO**, the surround back speakers will automatically be set to **NO**.
  - If you select one surround back speaker only, make sure that speaker is hooked up to the left surround back terminal.



- **SW** – LFE signals and bass frequencies of channels set to **SMALL** are output from the subwoofer when **YES** is selected. Choose the **PLUS** setting if you want the subwoofer to output bass sound continuously or you want deeper bass (the bass frequencies that would normally come out the front and center speakers are also routed to the subwoofer).<sup>1</sup> If you did not connect a subwoofer choose **NO** (the bass frequencies are output from other speakers).

### 3 Select 'X. OVER' and set the crossover frequency.<sup>2</sup>

Frequencies below this point will be sent to the subwoofer (or **LARGE** speakers).

### 4 When you're finished, press RETURN.

You will return to the Manual SP Setup menu.

## Channel Level

Using the channel level settings, you can adjust the overall balance of your speaker system, an important factor when setting up a home theater system.



### Important

- When Channel Level is selected while **MCACC** is set to **OFF**, the selection screen for the MCACC memory appears. Select a memory to adjust manually.

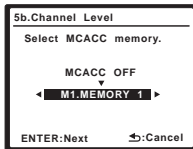

### 1 Select 'Channel Level' from the Manual SP Setup menu.

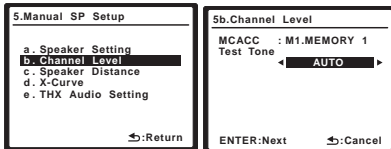

### 2 Select a setup option.

- **MANUAL** – Move the test tone manually from speaker to speaker and adjust individual channel levels.
- **AUTO** – Adjust channel levels as the test tone moves from speaker to speaker automatically.

### 3 Confirm your selected setup option.

The test tones will start after you press **ENTER**.

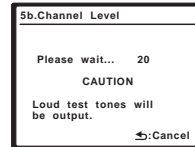

### 4 Adjust the level of each channel using ←/→.

If you selected **MANUAL**, use ↑/↓ to switch speakers. The **AUTO** setup will output test tones in the order shown on-screen:

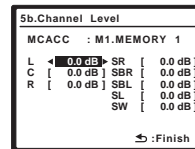

Adjust the level of each speaker as the test tone is emitted.<sup>3</sup>

### 5 When you're finished, press RETURN.

You will return to the Manual SP Setup menu.



### Tip

- You can change the channel levels at any time by press **RECEIVER**, then press **CH LEVEL**, and then using ←/→ on the remote control.

## Note

<sup>1</sup> If you have a subwoofer and like lots of bass, it may seem logical to select **LARGE** for your front speakers and **PLUS** for the subwoofer. This may not, however, yield the best bass results. Depending on the speaker placement of your room you may actually experience a decrease in the amount of bass due low frequency cancellations. In this case, try changing the position or direction of speakers. If you can't get good results, listen to the bass response with it set to **PLUS** and **YES** or the front speakers set to **LARGE** and **SMALL** alternatively and let your ears judge which sounds best. If you're having problems, the easiest option is to route all the bass sounds to the subwoofer by selecting **SMALL** for the front speakers.

<sup>2</sup> • This setting decides the cutoff between bass sounds playing back from the speakers selected as **LARGE**, or the subwoofer, and bass sounds playing back from those selected as **SMALL**. It also decides where the cutoff will be for bass sounds in the LFE channel.

- If you're using a THX speaker setup, confirm that the crossover frequency is set to **80Hz**.

<sup>3</sup> • If you are using a Sound Pressure Level (SPL) meter, take the readings from your main listening position and adjust the level of each speaker to 75 dB SPL (C-weighting/slow reading).

- The subwoofer test tone is output at low volumes. You may need to adjust the level after testing with an actual soundtrack.

## Speaker Distance

For good sound depth and separation from your system, you need to specify the distance of your speakers from the listening position. The receiver can then add the proper delay needed for effective surround sound.



### Important

- When Speaker Distance is selected while **MCACC** is set to **OFF**, the selection screen for the MCACC memory appears. Select a memory to adjust manually.

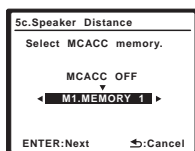

- Select 'Speaker Distance' from the Manual SP Setup menu.

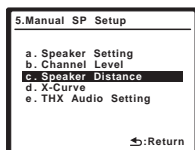

- Adjust the distance of each speaker using  $\leftarrow/\rightarrow$ . You can adjust the distance of each speaker in 1 inch increments.

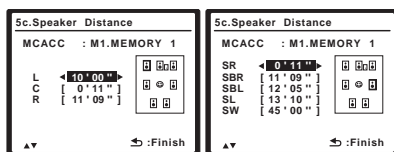

- When you're finished, press RETURN. You will return to the Manual SP Setup menu.



### Tip

- For best surround sound, make sure the surround back speakers are the same distance from the listening position.

## X-Curve

Most soundtracks mixed for cinema sound too bright when played back in large rooms. The X-Curve setting acts as a kind of re-equalization for home theater listening, and restores proper tonal balance of movie soundtracks.<sup>1</sup>

- Select 'X-Curve' from the Manual SP Setup menu.

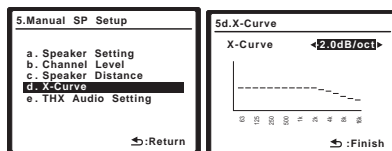

- Choose the X-Curve setting you want.

Use  $\leftarrow/\rightarrow$  to adjust the setting. The X-Curve is expressed as a downwards slope in decibels per octave, starting at 2 kHz. The sound becomes less bright as the slope increases (to a maximum of **-3.0dB/oct**). Use the following guidelines to set the X-Curve according to your room size:

Room size (ft <sup>2</sup> )	≤400	≤550	≤650	≤800	≤2200	≤12000
X-Curve (dB/oct)	-0.5	-1	-1.5	-2	-2.5	-3

- If you select **OFF**, the frequency curve will be flat and the X-Curve has no effect.

- Select 'Return', then press ENTER to finish.

## THX Audio Setting

When the THX Loudness Plus function is used, sound can be played with the full surround effect even when the volume is low.

For the most effective results when using the THX SELECT2 Cinema, THX SELECT2 Music and THX SELECT2 Games listening modes (see *Using the Home THX modes* on page 31) with the Advanced Speaker Array (ASA) system (see *About THX* on page 93), it is required that you make the setting. See *Placing the speakers* on page 22 for more on THX speaker placement.<sup>2</sup>

- Select 'THX Audio Setting' from the Manual SP Setup menu.

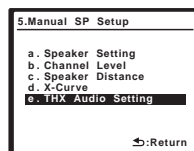

- Select either ON or OFF for THX Loudness Plus setting.

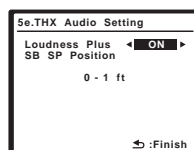

### Note

- Since the principal is the same, X-Curve isn't applied when you're using any of the Home THX modes (see *Using the Home THX modes* on page 31).
- If you don't have surround back speakers, or have only one surround back speaker or select Speaker B, Front Bi-Amp or ZONE 2 for Surround Back System, you won't be able to select this setting (**Cannot select** shows in the display).

### 3 Specify the distance of your surround back speakers from each other.

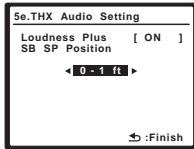

- **0 – 1 ft** – Surround speakers within 1 foot apart (best for THX surround sound).
- **> 1 – 4 ft** – Surround speakers between 1 and 4 feet apart.
- **4 ft <** – Surround speakers more than 4 feet apart.

### 4 When you're finished, press RETURN.

You will return to the Manual SP Setup menu.

## Chapter 8: Other connections

### Caution

- Before making or changing the connections, switch off the power and disconnect the power cord from the power outlet. Plugging in components should be the last connection you make with your system.
- Do not allow any contact between speaker wires from different terminals.

### Connecting an iPod

This receiver has a dedicated iPod terminal that will allow you to control playback of audio content from your iPod using the controls of this receiver.<sup>1</sup>

- Push down on the **PUSH OPEN** tab to access the **iPod DIRECT USB** terminal.

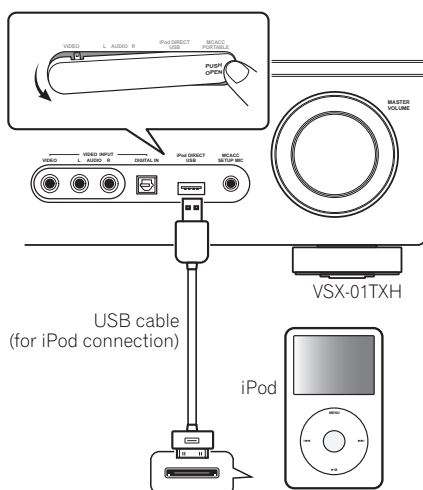

### Connecting your iPod to the receiver

**1 Set this receiver to the standby mode, and then use the USB cable (for iPod connection)<sup>2</sup> to connect your iPod to the iPod DIRECT USB terminal on the front panel of this receiver.**

For the cable connection, refer to also the operating instructions for iPod.

**2 Switch the receiver on and press the iPod USB input source button on the remote control to switch the receiver to the iPod USB.**

The front panel display shows **Loading** while the receiver verifies the connection and retrieves data from the iPod.

**3 Press TOP MENU to display iPod Top menu.**

When the display shows **Top Menu** you're ready to play music from the iPod.<sup>3</sup>

- If after pressing **iPod USB** the display shows **No Device**, try switching off the receiver and reconnecting the iPod to the receiver.

### iPod playback

To navigate songs on your iPod, you can take advantage of the OSD of your TV connected to this receiver.<sup>4</sup> You can also control all operations for music in the front panel display of this receiver.

### Finding what you want to play

When your iPod is connected to this receiver, you can browse songs stored on your iPod by playlist, artist, album name, song name, genre or composer, similar to using your iPod directly.

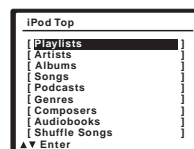

### Note

1 • This system is compatible with the audio of iPod nano, iPod fifth generation, iPod classic, iPod touch (not supported iPod shuffle and iPhone). However, that some of the functions may be restricted for some models. Note, however, compatibility may vary depending on the software version of your iPod. Please be sure to use the latest available software version.

- iPod is licensed for reproduction of non-copyrighted materials or materials the user is legally permitted to reproduce.
  - Features such as the equalizer cannot be controlled using this receiver, and we recommend switching the equalizer off before connecting.
  - Pioneer cannot under any circumstances accept responsibility for any direct or indirect loss arising from any inconvenience or loss of recorded material resulting from the iPod failure.
- 2 The USB cable (for iPod connection) is not included with this receiver.
- 3 The controls of your iPod will be inoperable when connected to this receiver.
- 4 You can't use the **iPod USB**, **XM** and **SIRIUS** radio functions simultaneously with using the MULTI-ZONE feature (page 61).
- 4 • Note that non-roman characters in the title are displayed as #.
- This feature is not available for photos or video clips on your iPod.

## Other connections

### 1 Use **↑/↓** to select a category, then press **ENTER** to browse that category.

- To return to the previous level any time, press **RETURN**.

### 2 Use **↑/↓** to browse the selected category (e.g., albums).

- Use **←/→** to move to previous/next levels.

### 3 Continue browsing until you arrive at what you want to play, then press **▶** to start playback.<sup>1</sup>

Navigation through categories on your iPod looks like this:

Playlists → Songs  
 Artists → Albums → Songs  
 Albums → Songs  
 Songs  
 Podcasts  
 Genres → Artists → Albums → Songs  
 Composers → Albums → Songs  
 Audiobooks  
 Shuffle Songs



#### Tip

- You can play all of the songs in a particular category by selecting the **All** item at the top of each category list. For example, you can play all the songs by a particular artist.

### Basic playback controls

The following table shows the basic playback controls for your iPod. Press **iPod USB** to switch the remote control to the iPod USB operation mode.

Button	What it does
<b>▶</b>	Press to start playback. If you start playback when something other than a song is selected, all the songs that fall into that category will play.
<b>  </b>	Pauses playback, or restarts playback when paused.
<b>◀◀/▶▶</b>	Press and hold during playback to start scanning.
<b>◀◀/▶▶</b>	Press to skip to previous/next track.
<b>↺</b>	Press repeatedly to switch between <b>Repeat One</b> , <b>Repeat All</b> and <b>Repeat Off</b> .
<b>↻</b>	Press repeatedly to switch between <b>Shuffle Songs</b> , <b>Shuffle Albums</b> and <b>Shuffle Off</b> .
<b>DISPLAY</b>	Press repeatedly to change the song playback information displayed in the front panel display.
<b>←/→</b>	When browsing, press to move to previous/next levels. During playback, press to skip to previous/next track.

#### Note

<sup>1</sup> If you're in the song category, you can also press **ENTER** to start playback.

<sup>2</sup> You cannot use this function, when an iPod of fifth generation or iPod nano of first generation is connected.

<sup>3</sup> When this function is set, iPod images cannot be played on this receiver.

Button	What it does
<b>↑/↓</b>	During Audiobook playback, press to switch the playback speed: Faster ↔ Normal ↔ Slower
<b>TOP MENU</b>	Press to return to the <b>iPod Top</b> menu screen.
<b>RETURN</b>	Press to return to the previous level.



#### Important

If an error message lights in the display, try following the points below:

Symptom	What it means
<b>Error I1</b>	There is a problem with the signal path from the iPod to the receiver. Switch off the receiver and reconnect the iPod to the receiver. If this doesn't seem to work, try resetting your iPod.
<b>Error I2</b>	The software version being used with the iPod needs to be updated. Update the software being used with the iPod (please use the latest iPod software versions later than the iPod updater 2004-10-20).
<b>Error I3</b>	The iPod that is not supported is connected. Check whether the iPod was supported by this receiver (page 52). When the iPod software version is too old. Update the iPod software to the latest version.
<b>Error I4</b>	When there is no response from the iPod. Update the iPod software to the latest version. If this doesn't seem to work, try resetting your iPod.
<b>No Music Track</b>	There are no playable songs currently stored in the iPod. Input some music files compatible with iPod playback.
<b>No Track</b>	When there are no tracks in the category selected on the iPod. Select a different category.

### Switching the iPod controls<sup>2</sup>

You can switch over the iPod controls between the iPod and the receiver.

#### 1 Press **iPod CTRL** to switch the iPod controls.<sup>3</sup>

This enables operation and display on your iPod, and this receiver's remote control and OSD become inactive.

#### 2 Press **iPod CTRL** again to switch back to the receiver controls.

*iPod is a trademark of Apple Inc., registered in the U.S. and other countries.*

## Connecting a USB device

It is possible to listen to two-channel audio<sup>1</sup> using the USB interface on the front of this receiver. Connect a USB mass storage device<sup>2</sup> as shown below.

- Push down on the **PUSH OPEN** tab to access the **iPod DIRECT USB** terminal.

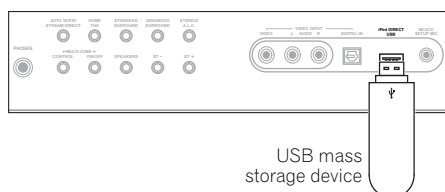

## Connecting your USB device to the receiver

- 1 Switch on the receiver and your TV.
- 2 Press **iPod USB** on the remote control to switch the receiver to the iPod USB.

**No Device** appears in the OSD.

- 3 Connect your USB device.<sup>3</sup>

The USB terminal is located on the front panel.

**Loading** appears in the OSD as this receiver starts recognizing the USB device connected. After the recognition, a playback screen appears in the OSD and playback starts automatically.<sup>4</sup>

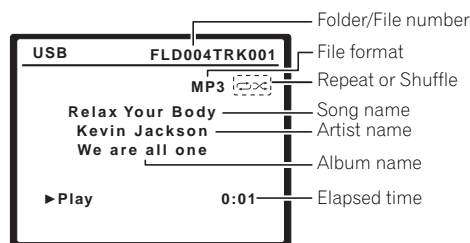

## Basic playback controls

The following table shows the basic controls on the remote for USB playback. Press **iPod USB** to switch the remote control to the iPod USB operation mode.

Button	What it does
▶	Starts normal playback.
	Pauses/unpauses playback.
⏮️/⏭️	Press to skip to previous/next track.
🔄	Press repeatedly to switch between <b>Repeat Folder</b> , <b>Repeat One</b> and <b>Repeat All</b> .
🔀	Press repeatedly to switch between <b>Shuffle On</b> and <b>Shuffle Off</b> .
DISPLAY	Press repeatedly to change the song playback information displayed in the front panel display.
⏮️/⏭️	During playback, press to skip to previous/next track.

**TOP MENU** Press to skip to first track.



### Important

If a **USB ERROR** message lights in the display, try following the points below:

USB ERROR	What it means
USB ERROR1	The power requirements of the USB device are too high for this receiver.
USB ERROR2	The USB device is incompatible.
USB ERROR3	See <i>Troubleshooting</i> on page 82 for more on this error message.
DECODE ERROR <sup>5</sup>	There is some problem with the audio data or the file's additional information.

- Switch the receiver off, then on again.
- Reconnect the USB device with the receiver switched off.
- Select another input source (like **DVD**), then switch back to **iPod USB**.
- Use a dedicated AC adapter (supplied with the device) for USB power.

If this doesn't remedy the problem, it is likely your USB device is incompatible.

### Note

<sup>1</sup> This includes playback of WMA/MP3/MPEG-4 AAC files (except files with copy-protection or restricted playback).

<sup>2</sup> • Compatible USB devices include external magnetic hard drives, portable flash memory (particularly keydrives) and digital audio players (MP3 players) of format FAT16/32. It is not possible to connect this receiver to a personal computer for USB playback.

<sup>3</sup> Pioneer cannot guarantee compatibility (operation and/or bus power) with all USB mass storage devices and assumes no responsibility for any loss of data that may occur when connected to this receiver.

• With large amounts of data, it may take longer for the receiver to read the contents of a USB device.

<sup>4</sup> Make sure the receiver is in standby when disconnecting the USB device.

<sup>5</sup> If the file selected cannot be played back, this receiver automatically skips to the next file playable.

• When the file currently being played back has no title assigned to it, the file name is displayed in the OSD instead; when neither the album name nor the artist name is present, the row is displayed as a blank space.

• Note that non-roman characters in the playlist are displayed as #.

• It is not possible to output the USB audio to ZONE 2.

<sup>6</sup> If this error occurs, playback is interrupted and the next playable file is played automatically.

• This error may occur if the title information is changed on a computer, etc.

## Other connections

### Compressed audio compatibility

Note that although most standard bit/sampling rate combinations for compressed audio are compatible, some irregularly encoded files may not play back. The list below shows compatible formats for compressed audio files:

- **MP3** (MPEG-1/2/2.5 Audio Layer 3) – Sampling rates: 8 kHz to 48 kHz; Bit rates: 8 kbps to 320 kbps (128 kbps or higher recommended); File extension: **.mp3**
- **WMA** (Windows Media Audio) – Sampling rates: 32 kHz / 44.1 kHz; Bit rates: 32 kbps to 192 kbps (128 kbps or higher recommended); File extension: **.wma**; WMA9 Pro and WMA lossless encoding: No
- **AAC** (MPEG-4 Advanced Audio Coding) – Sampling rates: 11.025 kHz to 48 kHz; Bit rates: 16 kbps to 320 kbps (128 kbps or higher recommended); File extension: **.m4a**; Apple lossless encoding: No

### Other compatibility information

- VBR (variable bit rate) MP3/WMA/MPEG-4 AAC playback: Yes<sup>1</sup>
- DRM (Digital Rights Management) protection compatible: Yes (DRM-protected audio files will not play in this receiver).

### About MPEG-4 AAC

Advanced Audio Coding (AAC) is at the core of the MPEG-4 AAC standard, which incorporates MPEG-2 AAC, forming the basis of the MPEG-4 audio compression technology. The file format and extension used depend on the application used to encode the AAC file. This receiver plays back AAC files encoded by iTunes® bearing the extension **.m4a**. DRM-protected files will not play, and files encoded with some versions of iTunes® may not play.

*Apple and iTunes are trademarks of Apple Inc., registered in the U.S. and other countries.*

### About WMA



The Windows Media logo printed on the box indicates that this receiver can playback Windows Media Audio content.

WMA is an acronym for Windows Media Audio and refers to an audio compression technology developed by Microsoft Corporation. This receiver plays back WMA files encoded using Windows Media® Player bearing the extension **.wma**. Note that DRM-protected files will not play, and files encoded with some versions of Windows Media® Player may not play.

*Windows Media, and the Windows logo are trademarks or registered trademarks of Microsoft Corporation in the United States and/or other countries.*

## Using XM Radio

XM is North America's number one satellite radio company, offering an extraordinary variety of commercial-free music, plus the best in premier sports, news, talk radio, comedy, children's and entertainment programming, broadcast in superior digital audio quality coast to coast. For more information, or to subscribe, U.S. customers visit [xmradio.com](http://xmradio.com) or call XM Listener Care at 1-800-XMRADIO (1-800-967-2346); Canadian customers visit [xmradio.ca](http://xmradio.ca) or call XM Listener Care at 1-877-GETXMSR (1-877-438-9677).

For more details see *About XM* on page 95.

### Connecting your XM Radio receiver

After purchasing an XM Mini-Tuner (sold separately), you will also need to activate the XM Radio service to begin receiving broadcasts.

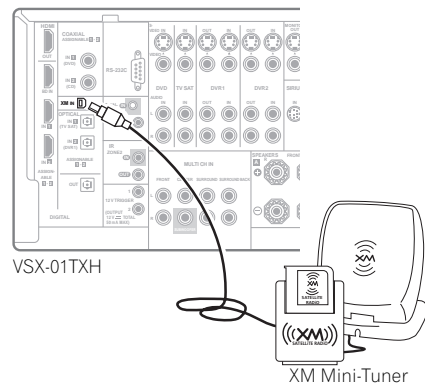

#### 1 Connect an XM Mini-Tuner to the XM IN jack on the rear of this receiver.

You will also need to activate the XM Radio service.

#### 2 Press XM to switch to the XM Radio input.

For best reception, you may need to move the XM Mini-Tuner antenna near a window (the southernmost window should produce the best results).

### Note

<sup>1</sup> Note that in some cases playback time will not be displayed correctly.

- If after pressing **XM** the display shows **Check XM Tuner** or **Check Antenna**, try disconnecting the receiver and tuner connections, and then plugging them back in.<sup>1</sup>

### Listening to XM Radio

After connecting, you will be able to use this receiver to select channels and navigate categories using the on-screen display.<sup>2</sup> The information displayed is as follows:

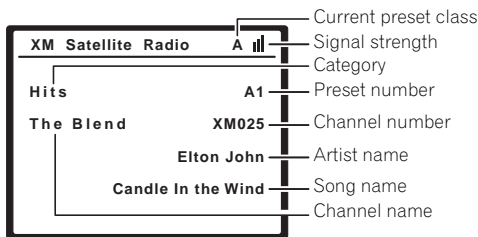

### Selecting channels and browsing by genre

From the XM Channel List, you can browse XM Radio channels in the order that they appear, or you can narrow your channel search by genre.<sup>3</sup>

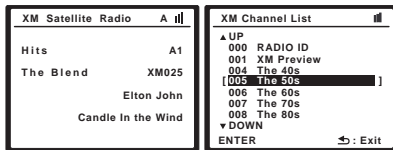

- Use **↑/↓** to select a channel, then press **ENTER** to listen to the XM radio broadcast.
  - To browse by genre, first press **CATEGORY**, use **↑/↓** to select a genre, then press **ENTER**.
  - To cancel and exit any time, press **RETURN**.

#### Tip

- You can select channels directly by pressing **D.ACCESS**, then the three-digit channel number.
- You can press **DISPLAY** to change XM Radio information in the front panel display.
- The currently selected channel is automatically chosen (without pressing **ENTER**) after 5 seconds.

### Using XM HD Surround

XM HD Surround uses Neural Surround™, THX® technologies to achieve optimal surround sound from XM radio. XM HD Surround Sound is available on select XM channels only.

- **While listening to XM Radio, press AUTO/DIRECT for XM HD Surround listening.**

See *About Neural – THX Surround* on page 94 for more on this.

XM HD Surround can be selected also with the **STANDARD** button.

### Saving channel presets

This receiver can memorize up to 30 channels, stored in three banks, or classes, (A, B and C) of 10 channels each.

#### 1 Select the channel you want to memorize.

See *Selecting channels and browsing by genre* above.

#### 2 Press T.EDIT.

The display shows a blinking memory class.

#### 3 Press CLASS to select one of the three classes, then press ←/→ to select the channel preset you want.

You can also use the number buttons to select a preset.

- The default for all presets is **XM001**.

#### 4 Press ENTER.

After pressing **ENTER**, the preset class and number stop blinking and the receiver stores the XM channel.

#### Tip

- You can also press **MEM** (Memory) during reception display to save the information of up to five songs. See *Using the XM Menu* below to recall this information.

### Listening to channel presets

You will need to have some presets stored to do this.

#### 1 Press CLASS to select the class in which the channel is stored.

Press repeatedly to cycle through classes A, B and C.

#### 2 Press ←/→ to select the channel preset you want.

You can also use the number buttons on the remote control to recall the channel preset.

#### Note

<sup>1</sup> You can check the strength of reception in *Using the XM Menu* on page 57.

<sup>2</sup> It's easiest if you have your TV switched on to take advantage of the OSDs. You can, however, use just the front panel display to do everything if you prefer.

<sup>3</sup> Select **XM000 (RADIO ID)** from the on-screen display to check the Radio ID of the XM Mini-Tuner.



## Using the XM Menu

The XM Menu provides additional XM Radio features.

### 1 Press TOP MENU.

### 2 Use ↑/↓ to select a menu item, then press ENTER.

Choose between the following menu items:

- **Channel Skip/Add** – Use ↑/↓ and **ENTER** to select channels you would like to remove/restore from/to the channel list.
- **Antenna Aiming** – Check the strength of satellite and terrestrial reception.
- **Memory Recall** – Use ↑/↓ to browse your saved song information (See *Tip* above)

### 3 When you're finished press TOP MENU to return to the reception display.

## Using SIRIUS Radio

With SIRIUS you get The Best Radio on Radio™ with all your favorite entertainment including 100 % commercial-free music, plus superior sports coverage, uncensored talk and comedy, world-class entertainment, news, weather and more for your car, home or office. For more information visit [sirius.com](http://sirius.com) or [siriuscanada.ca](http://siriuscanada.ca)

SIRIUS is available in the US for subscribers with addresses in the continental US and is available in Canada for subscribers with a Canadian address. Required subscription plus compatible SIRIUS tuner and antenna are required and sold separately. SIRIUS Programming is subject to change. Visit HYPERLINK "http://www.sirius.com" [sirius.com](http://www.sirius.com) for the most complete and up-to-date channel lineup and product information.

## Connecting your SiriusConnect™ Tuner

To receive SIRIUS Satellite Radio broadcasts, you will need to activate your SiriusConnect™ tuner.<sup>1</sup>

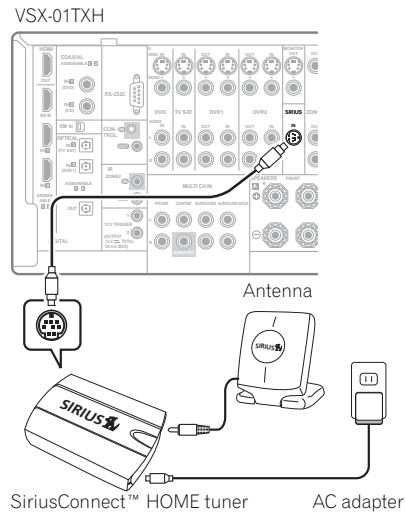

### 1 Connect a SiriusConnect™ tuner to the SIRIUS IN jack on the rear of this receiver.

You will also need to connect the antenna and AC adapter to the SiriusConnect™ tuner.

### 2 Press SIRIUS to switch to the SIRIUS input.

For best reception, you may need to move the SiriusConnect™ tuner antenna near a window (refer to the manual for the SiriusConnect™ Home tuner for antenna placement recommendations).

- If after pressing **SIRIUS** the display shows **Antenna Error**, try disconnecting the antenna and reconnecting.<sup>2</sup> If the display shows **Check Sirius Tuner**, check the connection of the AC adapter and this receiver to the SiriusConnect™ tuner.

### Note

<sup>1</sup> • In order to activate your radio subscription, you will need the SIRIUS ID (SID) which uniquely identifies your tuner. The SID may be found on a sticker located on the packaging, or on the bottom of the tuner itself. The label will have a printed 12-digit SID number. When you have located the SID, write it down in the space provided near the end of this manual. Connect SIRIUS on the internet at: <https://activate.siriusradio.com> Follow the prompts to activate your subscription, or you can also call SIRIUS toll-free at 1-888-539-SIRIUS (1-888-539-7474).

• Select **000 (SIRIUS ID)** from the on-screen display to check the Radio ID of the SIRIUS Connect tuner (see *Selecting channels and browsing by genre* on page 58).

<sup>2</sup> You can check the strength of reception in *Using the SIRIUS Menu* on page 58.

## Listening to SIRIUS Radio

After connecting, you will be able to use this receiver to select channels and navigate categories using the on-screen display.<sup>1</sup> The information displayed is as follows:

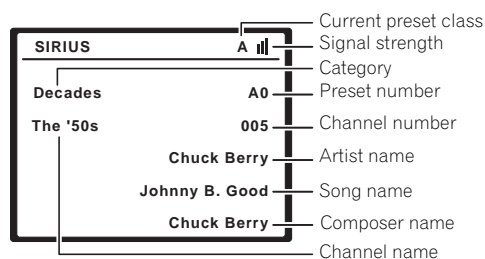

## Selecting channels and browsing by genre

From the SIRIUS Channel Guide, you can browse SIRIUS Radio channels in the order that they appear, or you can narrow your channel search by genre.

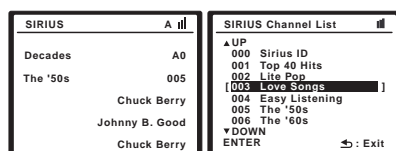

• Press **↑/↓** to enter the SIRIUS Channel Guide, then navigate through the channels one at a time with **↑/↓**, then press **ENTER** to listen to the SIRIUS radio broadcast.

- To browse by genre, first press **CATEGORY**, use **↑/↓** to select a genre, then press **ENTER**.
- To cancel and exit any time, press **RETURN**.

### Tip

- You can select channels directly by pressing **D.ACCESS**, then the three-digit channel number.
- You can press **DISPLAY** to change SIRIUS Radio information in the front panel display.
- The currently selected channel is automatically chosen (without pressing **ENTER**) after 5 seconds.

## Saving channel presets

This receiver can memorize up to 30 channels, stored in three banks, or classes, (A, B and C) of 10 channels each.

**1 Select the channel you want to memorize.**

See *Selecting channels and browsing by genre* above.

**2 Press T.EDIT.**

The display shows a blinking memory class.

**3 Press CLASS** to select one of the three classes, then press **←/→** to select the channel preset you want.

You can also use the number buttons to select a preset.

**4 Press ENTER.**

After pressing **ENTER**, the preset class and number stop blinking and the receiver stores the SIRIUS channel.<sup>2</sup>

### Tip

- You can also press **MEM** (Memory) during reception display to save the information of up to five songs. See *Using the SIRIUS Menu* below to recall this information.<sup>2</sup>

## Listening to channel presets

You will need to have some presets stored to do this.

**1 Press CLASS** to select the class in which the channel is stored.

Press repeatedly to cycle through classes A, B and C.

**2 Press ←/→** to select the channel preset you want.

- You can also use the number buttons on the remote control to recall the channel preset.

## Using the SIRIUS Menu

The SIRIUS Menu provides additional SIRIUS Radio features.<sup>2</sup>

**1 Press TOP MENU.**

**2 Use ↑/↓** to select a menu item, then press **ENTER**.

Choose from the following menu items:

- **Channel Skip/Add** – Use **↑/↓** and **ENTER** to select channels you would like to remove/restore from/to the channel guide.
- **Parental Lock** – Use **↑/↓** and **ENTER** to select channels you would like to place under parental lock. Channels put under parental lock are not displayed in the Channel Guide, but may be accessed by directly inputting their channel number and providing the parental lock password.
- **Antenna Aiming** – Check the strength of satellite and terrestrial reception.
- **Memory Recall** – Use **↑/↓** to browse your saved song information (see *Tip* above).
- **Password Set** – Set the parental lock password.

**3 When you're finished, press TOP MENU** to return to the reception display.

### Note

- <sup>1</sup> It's easiest if you have your TV switched on to take advantage of the OSDs. You can, however, use just the front panel display to do everything if you prefer.
- <sup>2</sup> You can reset the Channel presets, Memory, Channel Skip/Add, Parental Lock and Password settings in *Resetting the system* on page 77.

## Connecting the multichannel analog inputs

For DVD Audio and SACD playback, your DVD player may have 5.1, 6.1 or 7.1 channel analog outputs (depending on whether your player supports surround back channels).<sup>1</sup> Make sure that the player is set to output multichannel analog audio.

### 1 Connect the front, surround, center and subwoofer outputs on your DVD player to the corresponding MULTI CH IN jack on this receiver.

- Use standard RCA/phono jack cables for the connections.

### 2 If your DVD player also has outputs for surround back channels, connect these to the corresponding MULTI CH IN jacks on this receiver.

- Use standard RCA/phono jack cables for the connections.
- If there is a single surround back output, connect it to the **SURROUND BACK L (Single)** jack on this receiver.
- To use a 5.1-channel speaker set, use the surround speakers for the surround channel, not the surround back channel.

## Selecting the multichannel analog inputs

If you have connected a decoder or a DVD player as above, you must select the analog multichannel inputs for surround sound playback.<sup>2</sup>

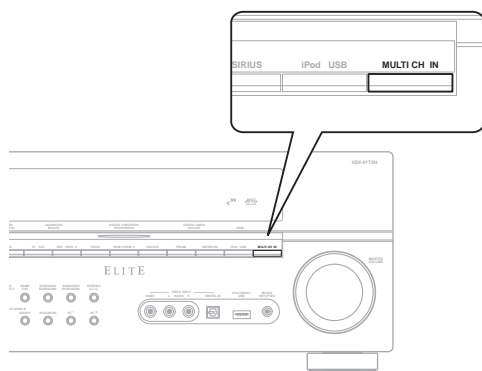

### 1 Make sure you have set the playback source to the proper output setting.

For example, you might need to set your DVD player to output multichannel analog audio.

### 2 Press MULTI CH IN on the front panel to turn the multi-channel input on.

- Depending on the DVD player you're using, the analog output level of the subwoofer channel may be too low. In this case, the output level of the subwoofer can be increased by 10 dB in the Multi Ch In Setup in Other Setup. For details, see *Multi Channel Input Setup* on page 71.

## Speaker B setup

### ⚠ Caution

- Before making or changing the connections, switch off the power and disconnect the power cord from the power outlet. Plugging in components should be the last connection you make with your system.
- Be careful not to allow any contact between speaker wires from different terminals.
- You can use speakers with a nominal impedance between 6 Ω to 16 Ω (please see *Switching the speaker impedance* on page 76 if you plan to use speakers with an impedance of less than 8 Ω).

After selecting **Speaker B** in *Surround back speaker setting* on page 41, you can use the speakers connected to the (surround back) B speaker terminals on the rear panel to listen to stereo playback in another room. See *Switching the speaker system* below for the listening options with this setup.

### 1 Connect a pair of speakers to the surround back speaker terminals on the rear panel.

Connect them the same way you connected your speakers in *Installing your speaker system* on page 21. Make sure to review *Placing the speakers* on page 22 when placing the speakers in another room.

### 2 Select 'Speaker B' from the Surround Back System menu.

See *Surround back speaker setting* on page 41 to do this.

## Switching the speaker system

If you selected **Speaker B** in *Surround back speaker setting* on page 41, three speaker system settings are possible using the **SPEAKERS** button. If you selected **Normal** or **Front Bi-Amp**, the button will simply switch your main speaker system on or off. The options below are for the **Speaker B** setting only.<sup>3</sup>

### 📌 Note

1 To listen to multichannel analog audio you'll need to select **MULTI CH IN** (see *Selecting the multichannel analog inputs* below for more on this).

2 When playback from the multichannel inputs is selected, only the volume and channel levels can be set.

• You can't listen to your speaker B system during playback from the multichannel inputs.

3 The subwoofer output depends on the settings you made in *Manual speaker setup* on page 48. However, if **SP►B** is selected above, no sound is heard from the subwoofer (the LFE channel is not downmixed).

• Depending on the settings in *Surround back speaker setting* on page 41 output from the surround back pre-out terminals may change.

• All speaker systems (except **Speaker B** connections) are switched off when headphones are connected.

- Use the **SPEAKERS** button on the front panel to select a speaker system setting.

As mentioned above, if you have selected **Normal**, the button will simply switch your main speaker system (A) on or off.



Press repeatedly to choose a speaker system option:

- **SP►A** – Sound is output from speaker system A and the same signal is output from the pre-out terminals.
- **SP►B** – Sound is output from the two speakers connected to speaker system B. Multichannel sources will not be heard. The same signal is output from the surround back channel pre-out terminals.
- **SP►AB** – Sound is output from speaker system A (up to 5 channels, depending on the source), the two speakers in speaker system B, and the subwoofer. The sound from speaker system B will be the same as the sound from speaker system A (multichannel sources will be downmixed to 2 channels).
- **SP►** (off) – No sound is output from the speakers. The same sound is output from the pre-out terminals (including from your subwoofer, if connected) as when selecting speaker system A (above).

## Bi-amping your front speakers

Bi-amping is when you connect the high frequency driver and low frequency driver of your speakers to different amplifier (in this case, to both front and surround back terminals) for better crossover performance. Your speakers must be bi-ampable to do this (having separate terminals for high and low) and the sound improvement will depend on the kind of speakers you're using.

### 1 Connect your speakers as shown below.

This illustration below shows the connections for bi-amping your front left speaker. Hook up your front right speaker in the same way.

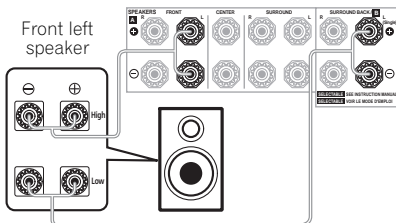

Since both front and surround back speaker terminals output the same audio, it doesn't matter which set (front or surround back) is powering which part (**High** or **Low**) of the speaker.

- Make sure that the + / – connections are properly inserted.

### 2 Select the 'Front Bi-Amp' setting from the Surround Back System menu.

See *Surround back speaker setting* on page 41 to specify how you're using the surround back speaker terminals.

### ⚠ Caution

- Most speakers with both **High** and **Low** terminals have two metal plates that connect the **High** to the **Low** terminals. These must be removed when you are bi-amping the speakers or you could severely damage the amplifier. See your speaker manual for more information.
- If your speakers have a removable crossover network, make sure you do not remove it for bi-amping. Doing so may damage your speakers.

## Bi-wiring your speakers

The reasons for bi-wiring are basically the same as bi-amping, but additionally, interference effects within the wire could be reduced, producing better sound. Again, to do this your speakers must be bi-wireable (that is they must have separate terminals for the high and low frequencies). When bi-wiring, make sure you've selected **Normal** or **Speaker B** in *Surround back speaker setting* on page 41.

- To bi-wire a speaker, connect two speaker cords to the speaker terminal on the receiver.

Using a banana plug for the second connection is recommended.

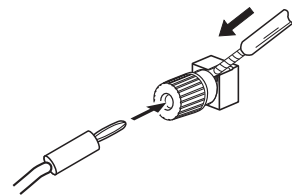

### ⚠ Caution

- Make sure you use a parallel (not series, which are fairly uncommon) connection when bi-wiring your speakers.
- Don't connect different speakers from the same terminal in this way.

## Other connections

### Connecting additional amplifiers

This receiver has more than enough power for any home use, but it's possible to add additional amplifiers to every channel of your system using the pre-outs. Make the connections shown below to add amplifiers to power your speakers.

- Before making or changing the connections, switch off the power and disconnect the power cord from the AC outlet.

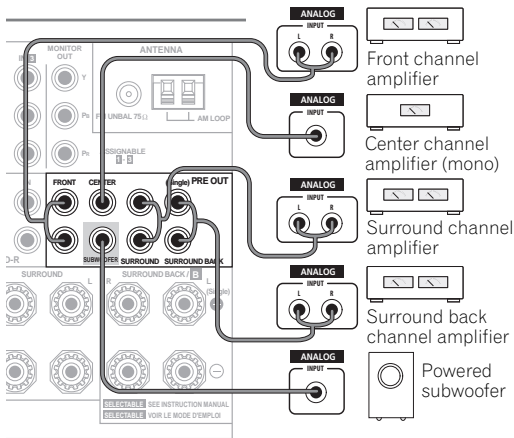

VSX-01TXH

- You can use the additional amplifier on the surround back channel pre-outs for a single speaker as well. In this case plug the amplifier into the left (**L (Single)**) terminal only.
- The sound from the surround back terminals will depend on how you have configured the *Surround back speaker setting* on page 41.
- To hear sound only from the pre-outs, switch the speaker system to **OFF**, or simply disconnect any speakers that are connected directly to the receiver.
- If you're not using a subwoofer, change the front speaker setting (see *Speaker Setting* on page 48) to **LARGE**.

### MULTI-ZONE listening

This receiver can power up to two independent systems in separate rooms after you have made the proper MULTI-ZONE connections. An example MULTI-ZONE setup is shown below.

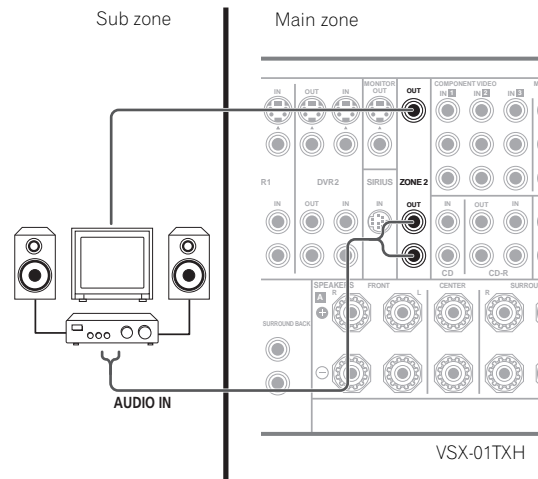

Different sources can be playing in two zones at the same time or, depending on your needs, the same source can also be used. The main and sub zones have independent power (the main zone power can be off while the sub zone is on) and the sub zone can be controlled by the remote or front panel controls. However, you may need to specify the volume settings in *ZONE Audio Setup* on page 71.

### Making MULTI-ZONE connections

It is possible to make these connections if you have a separate TV and speakers for your sub zone (**ZONE 2**).<sup>1</sup> You will also need a separate amplifier if you are not using the Surround Back System setup (page 62) for your sub zone.

#### Note

<sup>1</sup> You can't use sound controls (such as the bass/treble controls or Midnight listening) or any surround modes with a separate amplifier in the sub zone. You can, however, use the features available with your sub zone amplifier.

### MULTI-ZONE listening options

The following table shows what you can listen to in the sub zone:

Sub Zone	Input sources available
ZONE2	iPod, XM or SIRIUS Radio, the built-in tuner and other analog audio sources. <sup>a</sup> With video sources, only composite video is possible.

a. • With the **MULTI CH IN** input, sound is output only from the front L/R channels.

- The USB audio cannot be output to ZONE 2.

### Basic MULTI-ZONE setup (ZONE 2)

- Connect a separate amplifier to the **ZONE 2 AUDIO OUT** jacks and a TV monitor to the **ZONE 2 VIDEO OUT** jacks, both on the rear of this receiver.

You should have a pair of speakers attached to the sub zone amplifier as shown in the following illustration.

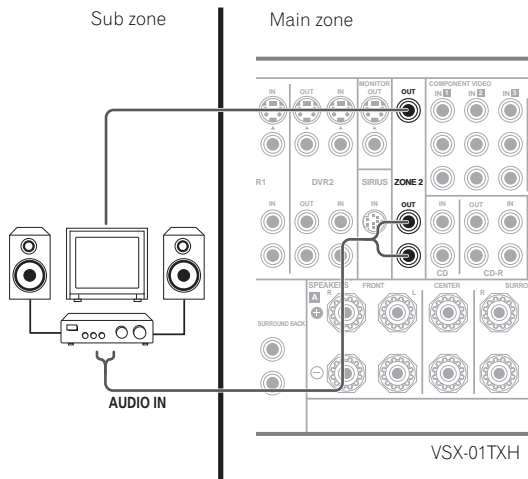

### Surround Back System MULTI-ZONE setup (ZONE 2)

You must select **ZONE 2** in *Surround back speaker setting* on page 41 to use this setup. Note that the sound in the sub zone will be temporarily interrupted when controlling the main zone (for example, changing the input source or starting playback).

- Connect a TV monitor to the **ZONE 2 VIDEO OUT** jacks on the rear of this receiver.

You should have a pair of speakers attached to the surround back speaker terminals as shown below.

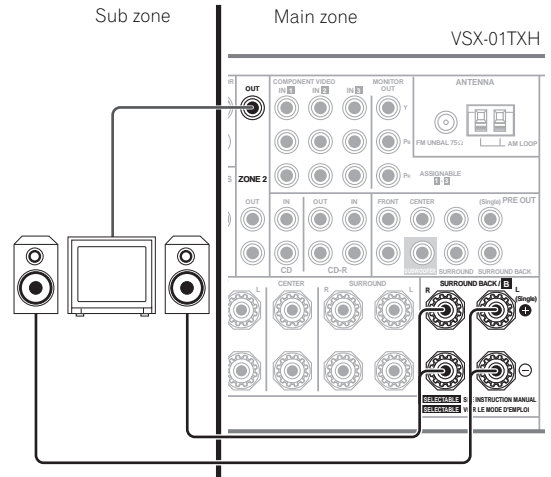

### Using the MULTI-ZONE controls

The following steps use the front panel controls to adjust the sub zone volume and select sources. See *MULTI-ZONE remote controls* on page 63.

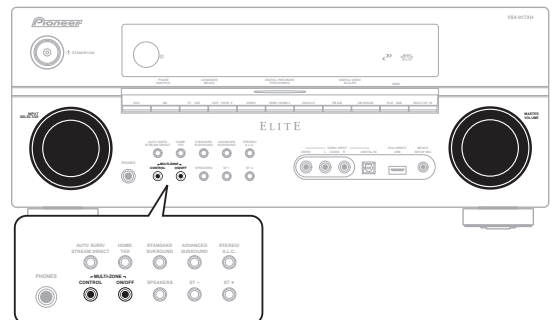

- 1 Press the **MULTI-ZONE ON/OFF** button on the front panel.

Each press selects a MULTI-ZONE option:

- **ZONE 2 ON** – Switches the MULTI-ZONE feature on
- **ZONE 2 OFF** – Switches the MULTI-ZONE feature off

The **MULTI-ZONE** indicator lights when the MULTI-ZONE control has been switched ON.

**2 Press CONTROL.**

- When the receiver is on,<sup>1</sup> make sure that any operations for the sub zone are done while **ZONE 2** shows in the display. If this is not showing, the front panel controls affect the main zone only.

**3 Use the INPUT SELECTOR dial to select the source for the zone you have selected.**

For example, **ZONE 2 CD-R** sends the source connected to the **CD-R** inputs to the sub room (**ZONE 2**).

- If you select **FM/AM**, you can use the tuner controls to select a preset station (see *Saving station presets* on page 36 if you're unsure how to do this).<sup>2</sup>
- You can't use the **iPod USB**, **XM** and **SIRIUS** Radio functions simultaneously with using the **MULTI-ZONE** feature.

**4 Use the MASTER VOLUME dial to adjust the volume.**

This is only possible if you selected the **VARIABLE** volume control in *ZONE Audio Setup* on page 71.<sup>3</sup>

**5 When you're finished, press CONTROL again to return to the main zone controls.**

You can also press the **MULTI-ZONE ON/OFF** button on the front panel to switch off all output to the sub zone.<sup>4</sup>

**MULTI-ZONE remote controls**

Set the **MULTI-ZONE** operation switch to **ZONE 2** to operate the corresponding zone.

The following table shows the possible **MULTI-ZONE** remote controls:

Button	What it does
	Switches on/off power in the sub zone.
<b>INPUT SELECT</b>	Use to select the input source in the sub zone.
Input source buttons	Use to select the input source directly (this may not work for some functions) in the sub zone.
<b>MASTER VOLUME +/-</b>	Use to set the listening volume in the sub zone.

**Connecting an IR receiver**

If you keep your stereo components in a closed cabinet or shelving unit, or you wish to use the sub zone remote control in another zone, you can use an optional IR receiver (such as a Niles or Xantech unit) to control your system instead of the remote sensor on the front panel of this receiver.<sup>5</sup>

**1 Connect the IR receiver sensor to the IR ZONE2 IN jack on the rear of this receiver.**

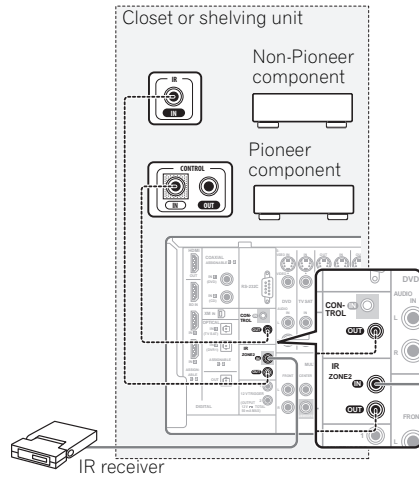

**2 Connect the IR ZONE2 IN jack of another component to the IR ZONE2 OUT jack on the rear of this receiver to link it to the IR receiver.**

Please see the manual supplied with your IR receiver for the type of cable necessary for the connection.

- If you want to link a Pioneer component to the IR receiver, see *Operating other Pioneer components with this receiver's sensor* on page 81 to connect to the **CONTROL** jacks instead of the **IR ZONE2 OUT** jack.

**Note**

- 1 If the receiver is in standby, the display is dimmed, and **ZONE 2** continues to show in the display.
- 2 The tuner cannot be tuned to more than one station at a time. Therefore, changing the station in one zone also changes the station in the other zone. Please be careful not to change stations when recording a radio broadcast.
- 3 The volume levels of the main and sub zones are independent.
- 4 • You won't be able to switch the main zone off completely unless you've switched off the **MULTI-ZONE** control first.
  - If you don't plan to use the **MULTI-ZONE** feature for a while, turn off the power in both the sub and main rooms so that this receiver is in standby.
- 5 • Remote operation may not be possible if direct light from a strong fluorescent lamp is shining on the IR receiver remote sensor window.
  - Note that other manufacturers may not use the IR terminology. Refer to the manual that came with your component to check for IR compatibility.
  - If using two remote controls (at the same time), the IR receiver's remote sensor takes priority over the remote sensor on the front panel.



## Switching components on and off using the 12 volt trigger

You can connect components in your system (such as a screen or projector) to this receiver so that they switch on or off using 12 volt triggers when you select an input function. However, you must specify which input functions switch on the trigger using the *The Input Setup menu* on page 69. Note that this will only work with components that have a standby mode.

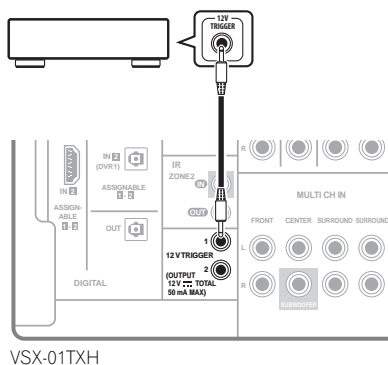

VSX-01TXH

- **Connect the 12 V TRIGGER jack of this receiver to the 12 V trigger of another component.**

Use a cable with a mono mini-plug on each end for the connection.

- The trigger maximum power is DC OUT 12 V/50 mA (50 mA total for terminals 1 and 2).

After you've specified the input functions that will switch on the trigger, you'll be able to switch the component on or off just by pressing the input function(s) you've set on *The Input Setup menu* on page 69.

## Using this receiver with a Pioneer flat panel TV

If you have a Pioneer flat panel TV, you can use an SR+ cable<sup>1</sup> to connect it to this receiver and take advantage of various convenient features, such as automatic video input switching of the flat panel TV when the input is changed.<sup>2</sup>

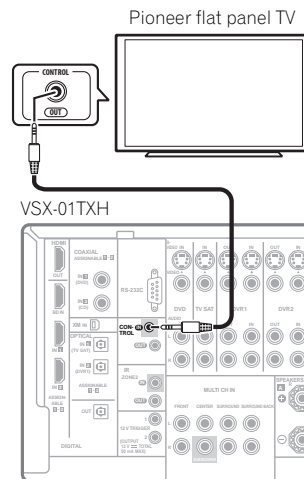

### Important

- You can't use the SR+ features when HDMI Control is set to ON. Make sure to set HDMI Control to OFF when you use the SR+ features (page 67).
- If you connect to a Pioneer flat panel TV using an SR+ cable, you will need to point the remote control at the flat panel TV remote sensor to control the receiver. In this case, you won't be able to control the receiver using the remote control if you switch the flat panel TV off.
- Before you can use the extra SR+ features, you need to make a few settings in the receiver. See *The Input Setup menu* on page 69 and *SR+ Setup for Pioneer flat panel TVs* on page 72 for detailed instructions.

### Note

<sup>1</sup> The 3-ringed SR+ cable from Pioneer is commercially available under the part number ADE7095. Contact the Pioneer Customer Support division for more information on obtaining an SR+ cable (you can also use a commercially available 3-ringed mini phone plug for the connection).

<sup>2</sup> This receiver is compatible with all SR+ equipped Pioneer flat panel TVs from 2003 onward.



- Use a 3-ringed miniplug SR+ cable to connect the CONTROL IN jack of this receiver with the CONTROL OUT jack of your flat panel TV.

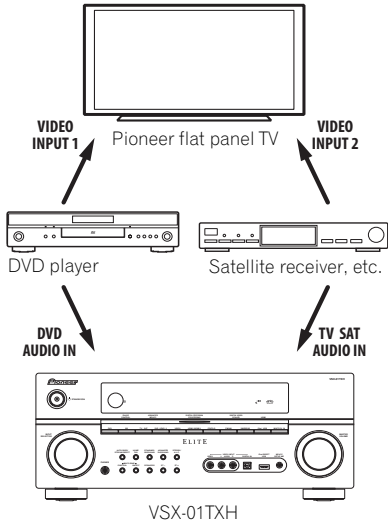

To make the most of the SR+ features, you should connect your source components (DVD player, etc.) in a slightly different way to that described in this chapter. For each component, connect the video output directly to the flat panel TV, and just connect the audio (analog and/or digital) to this receiver.

## Using the SR+ mode with a Pioneer flat panel TV

When connected using an SR+ cable, a number of features become available to make using this receiver with your Pioneer flat panel TV even easier. These features include:

- On-screen displays when making receiver settings, such as speaker setup, MCACC setup, and so on.
- On-screen volume display.
- On-screen display of listening mode.
- Automatic video input switching on the flat panel TV.
- Automatic volume muting on the flat panel TV.

See also *SR+ Setup for Pioneer flat panel TVs* on page 72 for more on setting up the receiver.

### Important

- The SR+ features do not work when any of the **iPod USB**, **XM** or **SIRIUS** Radio function is selected.

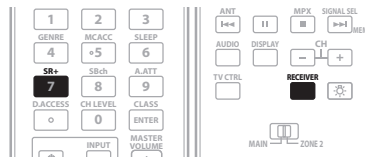

### 1 Make sure that the flat panel TV and this receiver are switched on and that they are connected with the SR+ cable.

See *Using this receiver with a Pioneer flat panel TV* on page 64 for more on connecting these components.

- Make sure you have also selected the display input to which you've connected the receiver in *The Input Setup menu* on page 69.

### 2 To switch SR+ mode on/off, press RECEIVER, then press the SR+ button.

The front panel display shows **SR+ ON** or **SR+ OFF**.

- The automatic video input switching and the automatic volume muting features are enabled separately; see *SR+ Setup for Pioneer flat panel TVs* on page 72.

## Connecting a PC for Advanced MCACC output

When using the Acoustic Calibration EQ Professional (see page 43) to calibrate the reverb characteristics of your listening room, you can graphically check the results on your computer connected to this receiver.

Use a commercially-available RS-232C cable to connect the RS-232C jack on your computer to the 9-pin RS-232C jack on the back panel of this receiver (the cable must be cross type, female–female).

The software to output the results is available from the support area of the Pioneer website (<http://www.pioneerelectronics.com/PUSA/Home+Entertainment+Custom+Install>). Instructions for using the software are also available here. If you have any questions regarding, please contact the Customer Support Division of Pioneer.

Please make sure your system meets the following requirements:

- Operating system must be Microsoft Windows® XP (Service Pack 2) or Windows® 2000.
  - CPU must be at least Pentium 3 / 300 MHz or AMD K6 / 300 MHz (or equivalent) with at least 128 MB of memory, and your monitor must be able to display a minimum resolution of 800x600.
  - An RS-232C port connector is necessary for graphical output. Refer to the operating instructions and/or the PC manufacturer for more information on making the proper port settings.
  - System must have internet access.
- **Connect your computer to the RS-232C jack on the rear panel of the receiver.**

Make sure that the receiver and all connected components are switched off and disconnected from the power outlet when you do this.<sup>1</sup>

Use a commercially-available cable to connect the RS-232C jack on your computer to the 9-pin RS-232C jack on this receiver. See the documentation provided with the Advanced MCACC application for more information.

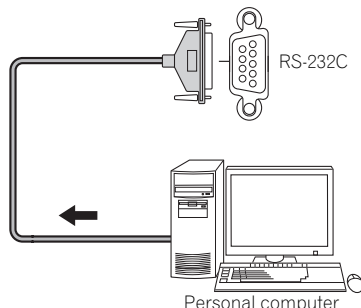

## Advanced MCACC output using your PC

Before continuing, make sure you have completed step 1 in *Data Management* on page 46. Note that transmission data is erased when the receiver is turned off.

### 1 Select 'Output PC' and press ENTER.

When the receiver is ready for transmission, **Start the MCACC application on your PC** shows on the OSD.

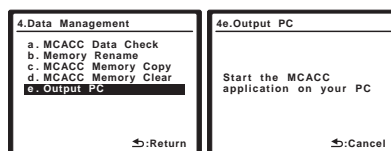

### 2 Start the MCACC application on your computer.

Follow the instructions provided with the application. It will take about ten seconds for the transmission to complete, then you will be able to analyze the output on your computer. Since the data will be cleared from the receiver when you restart reverb measurement or turn off the receiver, you might want to save the information on your PC after measurement.

### 3 When you're finished, press RETURN.

You will return to the Data Management menu. Continue with other settings in the Data Management menu if necessary. Press **RETURN** again to exit the Data Management menu.

#### Note

<sup>1</sup> Make sure that you do this before continuing to the **Reverb Measurement** option in *Using Acoustic Calibration EQ Professional* on page 45 (measurement data is cleared if you switch off the power).

## Chapter 9: HDMI Control

### Important

- The KURO LINK function name used on the web and in catalogues is referred to as HDMI Control in the operating instructions and on the product.

By connecting this receiver to an HDMI Control-compatible Pioneer flat panel TV or the HDD/DVD recorder with an HDMI cable, you can control this receiver from the remote control of a connected flat panel TV, as well as have the connected flat panel TV automatically change inputs in response to operations carried out on this receiver.

Refer to the operating manual for your flat panel TV for more information about which operations can be carried out by connecting via HDMI cable.

- You cannot use this function with components that do not support HDMI Control.
- We cannot guarantee this receiver will work with HDMI Control-compatible components other than those made by Pioneer.

### Making the HDMI Control connections

You can use synchronized operation for a connected flat panel TV and up to three other components.

Be sure to connect the flat panel TV's audio cable to the audio input of this receiver.

### Important

- When connecting this system or changing connections, be sure to switch the power off and disconnect the power cord from the wall socket. After completing all connections, connect the power cords to the wall socket.
- After connecting this receiver to an AC outlet, a 15 second initialization process begins. You cannot carry out any operations during initialization. The HDMI indicator on the display unit blinks during initialization, and you can turn this receiver on once it has stopped blinking.

- To get the most out of this function, we recommend that you connect your HDMI component not to a flat panel TV but rather directly to the HDMI terminal on this receiver.

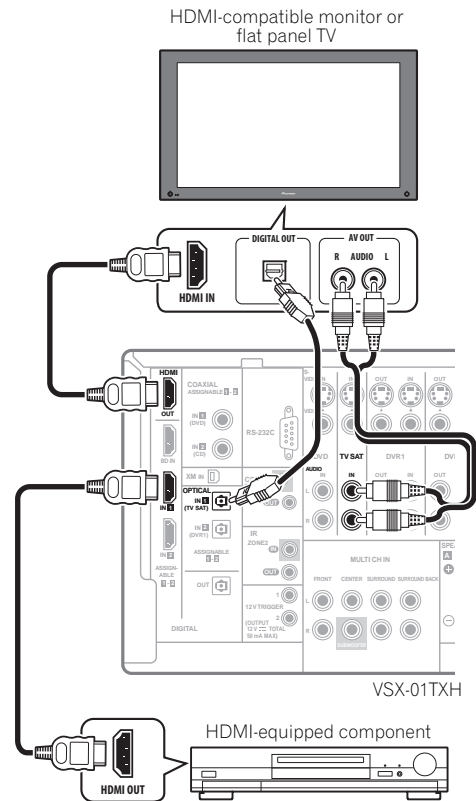

### Setting the HDMI options

You must adjust the settings of this receiver as well as HDMI Control-compatible connected components in order to make use of the HDMI Control function. For more information see the operating instructions for each component.

### Setting the HDMI Control mode

Choose whether to set this receiver's HDMI Control function **ON** or **OFF**. You will need to set it to **ON** to use the HDMI Control function.

- When using a TV not manufactured by Pioneer, put this setting to **OFF**.

- 1 Press **RECEIVER**, then press the **SETUP** button.
- 2 Select **'Other Setup'**, then press **ENTER**.
- 3 Select **'HDMI Control Setup'** from the **Other Setup** menu.

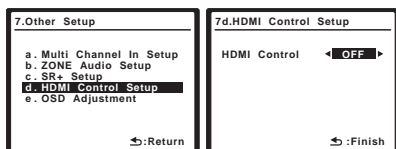

- 4 Select the **'HDMI Control'** setting you want.
  - **ON** – Enables the HDMI Control function. When this receiver's power is turned off and you have a supported source begin playback while using the HDMI Control function, the audio and video output from the HDMI connection are output from the flat panel TV.<sup>1</sup>
  - **OFF** – The HDMI Control is disabled. Synchronized operations cannot be used. When this receiver's power is turned off, audio and video of sources connected via HDMI are not output.
- 5 **When you're finished, press SETUP.**  
You will finish to System Setup menu.

## Before using synchronization

Once you have finished all connections and settings, you must:

- 1 **Put all components into standby mode.**
- 2 **Turn the power on for all components, with the power for the flat panel TV being turned on last.**
- 3 **Choose the HDMI input to which the TV is connected to this receiver, and see if video output from connected components displays properly on the screen or not.**
- 4 **Check whether the components connected to all HDMI inputs are properly displayed.**

## Synchronized amp mode

Synchronized amp mode begins once you carry out an operation for the flat panel TV. For more information, see the operating manual of your flat panel TV.

## Synchronized amp mode operations

By connecting a component to this receiver with an HDMI cable you can use synchronized amp mode, which allows you to synchronize the following operations<sup>2</sup>:

- Displays on the flat panel TV when you mute or adjust the volume of this receiver.
- The input of this receiver is automatically changed when playback occurs on a connected component.
- Even if you change this receiver's input to a device that is not connected by HDMI, the synchronized amp mode remains in effect.
- This receiver's input switches automatically when the channel is switched on an HDMI control-compatible flat panel TV.
- By pressing **GENRE** when listening to a source from a HDD/DVD recorder, the most appropriate listening mode is automatically selected (see *Using the genre synchronizing function* on page 35 for more on this).

## Canceling synchronized amp mode

Operate the flat panel TV to cancel the synchronized amp mode.

If you cancel synchronized amp mode while connected via HDMI to a flat panel TV or while you are watching a TV programme, the power for this receiver is turned off.

## About HDMI Control

- Connect the flat panel TV directly to this receiver. Interrupting a direct connection with other amps or an AV converter (such as an HDMI switch) can cause operational errors.
- Only connect components you intend to use as a source to the HDMI input of this receiver. Interrupting a direct connection with other amps or an AV converter (such as an HDMI switch) can cause operational errors.

### Note

- 1 • When **HDMI Control** is set to **ON**, the audio/video signals input at the **HDMI IN** terminals are output at the **HDMI OUT** terminal even when this receiver is switched off.
  - With **HDMI Control** set to **ON**, Input Setup and HDMI Input are automatically set to **OFF**.
- 2 The linked mode remains in effect even when this receiver's input is switched to something other than HDMI.

## Chapter 10: Other Settings

### The Input Setup menu

You only need to make settings in the Input Setup menu if you didn't hook up your digital equipment according to the default settings (see *Input function default and possible settings* on page 70). In this case, you need to tell the receiver what equipment is hooked up to which terminal so the buttons on the remote correspond to the components you've connected.

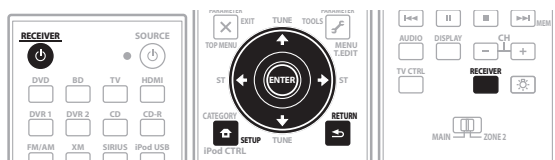

#### 1 Switch on the receiver and your TV.

Use the **RECEIVER** button to switch on.

#### 2 Press RECEIVER on the remote control, then press SETUP.

An on-screen display (OSD) appears on your TV. Use **↑/↓/←/→** and **ENTER** to navigate through the screens and select menu items. Press **RETURN** to confirm and exit the current menu.

#### 3 Select 'Input Setup' from the System Setup menu.

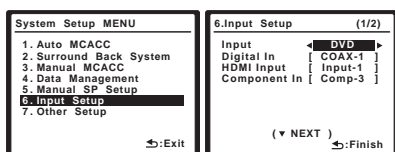

#### 4 Select the input function that you want to set up.

The default names correspond with the names next to the terminals on the rear panel (such as **DVD** or **VIDEO**) which, in turn, correspond with the names on the remote control.

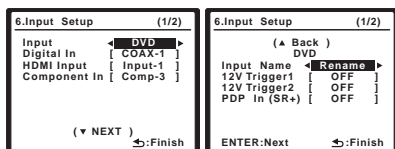

#### 5 Select the input(s) to which you've connected your component.

For example, if your DVD player only has an optical output, you will need to change the **DVD** input function's **Digital In** setting from **COAX-1** (default) to the optical input you've connected it to. The numbering (**OPT-1** and **2**) corresponds with the numbers beside the inputs on the back of the receiver.

- If you change the setting to an input that has been previously assigned to another function (for example, **TV SAT**), the setting for that function will automatically be switched off.
- If your component is connected via a component video cable to an input terminal other than the default, you must tell the receiver which input terminal your component is connected to, or else you may see the S-Video or composite video signals instead of the component video signals.<sup>1</sup>

#### 6 When you're finished, select 'Next' to continue to the next screen.

The second screen of the Input Setup has three optional settings:

- **Input Name** – You can choose to rename the input function for easier identification. Select **Rename** to do so, or **Default** to return to the system default.
- **12V Trigger 1 / 2** – After connecting a component to one of the 12 volt triggers (see *Switching components on and off using the 12 volt trigger* on page 64), select **MAIN, ZONE 2** or **OFF** for the corresponding trigger setting to switch it on automatically along with the (main or sub) zone specified.
- **PDP In (SR+)** – To control certain functions on this receiver from a flat panel TV, select the display input to which you've connected the receiver.<sup>2</sup>

#### 7 When you're finished, press RETURN.

You will return to the System Setup menu.

#### Note

<sup>1</sup> For high-definition video (using component video connections), or when digital video conversion is switched off (in *Setting the Video options* on page 74), you must connect your TV to this receiver using the same type of video cable as you used to connect your video component.

<sup>2</sup> You will have to make an SR+ cable connection from a **CONTROL OUT** jack on the display to the **CONTROL IN** jack on this receiver (opposite from the setup in *Using this receiver with a Pioneer flat panel TV* on page 64). Note that to control this receiver using the remote, you will have to point it at the flat panel TV's remote sensor after making this connection.

## Input function default and possible settings

The terminals on the rear of the receiver generally correspond to the name of one of the input source functions. If you have connected components to this receiver differently from (or in addition to) the defaults below, see *The Input Setup menu* on page 69 to tell the receiver how you've connected up. The dots (●) indicate possible assignments.

Input source	Input Terminals		
	Digital	HDMI	Component
DVD	COAX 1	● <sup>a</sup>	●
BD		(BD)	
TV SAT	OPT 1	● <sup>a</sup>	●
DVR1	OPT 2	● <sup>a</sup>	●
DVR2		● <sup>a</sup>	●
VIDEO	(Fixed)	● <sup>a</sup>	
HDMI 1		(HDMI-1)	
HDMI 2		(HDMI-2)	
iPod USB			
XM			
SIRIUS			
CD	COAX 2		
CD-R	●		
FM/AM			

a. With HDMI Control set to ON, assignments cannot be made (see *HDMI Control* on page 67).

## The Other Setup menu

The Other Setup menu is where you can make customized settings to reflect how you are using the receiver.

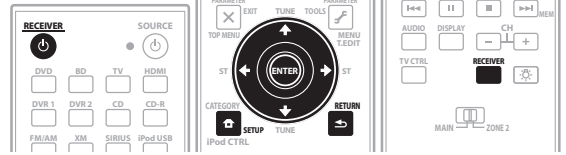

### 1 Switch on the receiver and your TV.

Use the **RECEIVER** button to switch on.

### 2 Press RECEIVER on the remote control, then press the SETUP.

An on-screen display (OSD) appears on your TV. Use **↑/↓/←/→** and **ENTER** to navigate through the screens and select menu items. Press **RETURN** to confirm and exit the current menu.

### 3 Select 'Other Setup' then press ENTER.

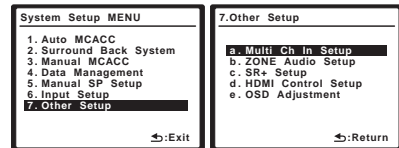

### 4 Select the setting you want to adjust.

If you are doing this for the first time, you may want to adjust these settings in order:

- **Multi Ch In Setup** – Specifies the optional settings for a multi-channel input.
- **ZONE Audio Setup** – Specifies your volume setting for a MULTI-ZONE setup (see *ZONE Audio Setup* on page 71).
- **SR+ Setup** – Specifies how you want to control your Pioneer flat panel TV (see *SR+ Setup for Pioneer flat panel TVs* on page 72).
- **HDMI Control Setup** – Synchronizes this receiver with your Pioneer component supporting HDMI Control (see *Setting the HDMI Control mode* on page 67).
- **OSD Adjustment** – Adjusts the position of the on-screen display on your TV (see *OSD Adjustment* on page 72).

### 5 Make the adjustments necessary for each setting, pressing RETURN to confirm after each screen.

## Multi Channel Input Setup

You can adjust the level of the subwoofer for a multi-channel input.

- 1 Select 'Multi Ch In Setup' from the Other Setup menu.

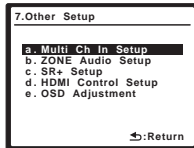

- 2 Select the 'SW Input Gain' setting you want.

- **0dB** – Outputs sound of the subwoofer at the level originally recorded on the source.
- **+10dB** – Outputs sound of the subwoofer at the level increased by 10 dB.

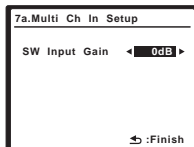

- 3 When you're finished, press RETURN.

You will return to the Other Setup menu.

## ZONE Audio Setup

If you've made MULTI-ZONE connections (see *MULTI-ZONE listening* on page 61) you may need to specify your volume setting.

- 1 Select 'ZONE Audio Setup' from the Other Setup menu.

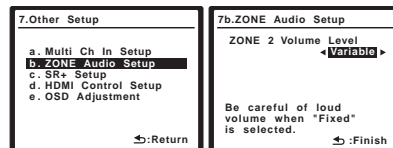

- 2 Select the volume level setting.<sup>1</sup>

- **Variable** – Use this setting if you've connected a power amplifier in the sub room (this receiver is simply being used as a pre-amp) and you will be using this receiver's controls to adjust the volume.
- **Fixed** – Use this setting if you've connected a fully integrated amplifier (such as another Pioneer VSX receiver) in the sub room and want to use that receiver's volume controls. (This setting is not available if the surround back system setting is set to **ZONE 2**.)

With the **Fixed** setting, the source is sent from this receiver at maximum volume, so make sure the volume is quite low in the sub zone at first, and then experiment to find the correct level.

- 3 When you're finished, press RETURN.

You will return to the Other Setup menu.

### Note

<sup>1</sup> If you selected **ZONE 2** in the *Surround back speaker setting* on page 41, you won't be able to change the volume level.

### SR+ Setup for Pioneer flat panel TVs

Make the following settings if you have connected a Pioneer flat panel TV to this receiver using an SR+ cable. Note that the number of function settings available will depend on the flat panel TV you've connected.

See also *Using this receiver with a Pioneer flat panel TV* on page 64 and *Using the SR+ mode with a Pioneer flat panel TV* on page 65.

#### 1 Select 'SR+ Setup' from the Other Setup menu.

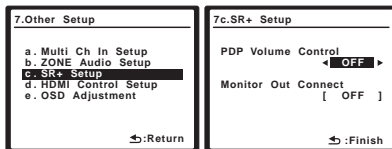

#### 2 Select the 'PDP Volume Control' setting you want.

- **OFF** – The receiver does not control the volume of the flat panel TV.
- **ON** – When the receiver is switched to one of the inputs that use the flat panel TV (**DVD**, for example), the volume on the flat panel TV is muted so only sound from the receiver is heard.

#### 3 Assign any input source connected to the flat panel TV to the corresponding input number.

This matches the receiver's input source with a numbered video input on the flat panel TV. For example, assign **DVD** to **input-2** if you have connected the your DVD video output to video input 2 on the flat panel TV.

- The **Monitor Out Connect** should be set to the input that you've used to connect this receiver to your flat panel TV.

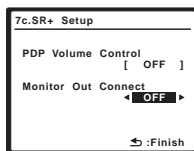

#### 4 When you're finished, press RETURN.

You will return to the Other Setup menu.

### OSD Adjustment

Use this feature to adjust your TV display if it seems difficult to see all the instructions on the screen.

#### 1 Select 'OSD Adjustment' from the Other Setup menu.

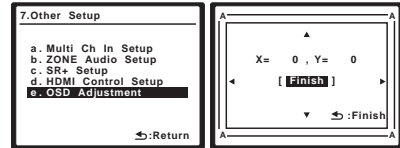

#### 2 Use ↑/↓/←/→ to move the display field around until you get one that you feel best suits your TV.

#### 3 When you're finished, press ENTER.

You will return to the Other Setup menu.



## Chapter 11: Using other functions

### Setting the Audio options

There are a number of additional sound settings you can make using the Audio Parameter menu. The defaults, if not stated, are listed in bold.



#### Important

- Note that if a setting doesn't appear in the Audio Parameter menu, it is unavailable due to the current source, settings and status of the receiver.

#### 1 Press RECEIVER, then press AUDIO PARAMETER.

**2 Use ↑/↓ to select the setting you want to adjust.** Depending on the current status/mode of the receiver, certain options may not be able to be selected. Check the table below for notes on this.

#### 3 Use ←/→ to set it as necessary.

See the table below for the options available for each setting.

#### 4 Press RETURN to confirm and exit the menu.

Setting	What it does	Option(s)
<b>MCACC</b> (MCACC preset)	Selects your favorite MCACC preset memory when multiple preset memories are saved. When a MCACC preset memory has been renamed, the name given is displayed.	<i>M1. MEMORY1</i> to <i>M6. MEMORY6</i> Default: <b>M1. MEMORY 1</b> <i>MCACC OFF<sup>a</sup></i>
<b>EQ<sup>b</sup></b> (Acoustic Calibration EQ)	Switches on/off the effects of EQ Pro. only for the MCACC preset memory selected. This setting is available for each MCACC preset memory.	<b>ON</b> <i>OFF<sup>c</sup></i>
<b>S-WAVE<sup>b</sup></b> (Standing Wave)	Switches on/off the effects of Standing Wave Control only for the MCACC preset memory selected. This setting is available for each MCACC preset memory.	<b>ON</b> <i>OFF</i>
<b>DELAY</b> (Sound Delay)	Some monitors have a slight delay when showing video, so the soundtrack will be slightly out of sync with the picture. By adding a bit of delay, you can adjust the sound to match the presentation of the video.	0.0 to 6.0 (frames) <i>1 second = 30 frames (NTSC)</i> Default: <b>0.0</b>

Setting	What it does	Option(s)
<b>MIDNIGHT</b>	Allows you to hear effective surround sound of movies at low volumes.	<b>MID/LDN OFF</b> <i>MIDNIGHT ON</i>
<b>LOUDNESS</b>	Used to get good bass and treble from music sources at low volumes.	<i>LOUDNESS ON</i>
<b>BASS</b>	Adjusts the amount of bass.	-6 to +6 (dB) Default: <b>0</b> (dB)
<b>TREBLE</b>	Adjusts the amount of treble.	-6 to +6 (dB) Default: <b>0</b> (dB)
<b>S.RTRV</b> (Sound Retriever)	When audio data is removed during the WMA/MP3/MPEG-4 AAC compression process, sound quality often suffers from an uneven sound image. The Sound Retriever feature employs new DSP technology that helps bring CD quality sound back to compressed 2-channel audio by restoring sound pressure and smoothing jagged artifacts left over after compression.	<b>OFF</b> <i>ON</i>
<b>DNR</b> (Digital Noise Reduction)	May improve the quality of sound in a noisy source (for example, cassette or video tape with lots of background noise) when switched on.	<b>OFF</b> <i>ON</i>
<b>DIALOG E</b> (Dialog Enhancement)	Localizes dialog in the center channel to make it stand out from other background sounds in a TV or movie soundtrack.	<b>OFF</b> <i>ON</i>
<b>HIBITSMP</b> (High Bit)	Creates a wider dynamic range with digital sources like CDs or DVDs (Smoother, more delicate musical expression can be achieved by quantizing 16 bit PCM or 20 bit compressed audio signals to 24 bits).	<b>OFF</b> <i>ON</i>
<b>DUAL</b> (Dual Mono)	Specifies how dual mono encoded Dolby Digital soundtracks should be played. Dual mono is not widely used, but is sometimes necessary when two languages need to be sent to separate channels.	<b>CH1</b> – Channel 1 is heard only <i>CH2</i> – Channel 2 is heard only <i>CH1 CH2</i> – Both channels heard from front speakers

Setting	What it does	Option(s)
<b>DRC</b> (Dynamic Range Control)	Adjusts the level of dynamic range for movie soundtracks optimized for Dolby Digital, DTS, Dolby Digital Plus, Dolby TrueHD, DTS-HD and DTS-HD Master Audio (you may need to use this feature when listening to surround sound at low volumes).	<b>AUTO</b> <sup>d</sup> <hr/> <i>OFF</i> <hr/> <i>MAX</i> <hr/> <i>MID</i>
<b>LFE ATT</b> (LFE Attenuate)	Some Dolby Digital and DTS audio sources include ultra-low bass tones. Set the LFE attenuator as necessary to prevent the ultra-low bass tones from distorting the sound from the speakers.  The LFE is not limited when set to 0 dB, which is the recommended value. When set to -5 dB, -10 dB, -15 dB or -20 dB, the LFE is limited by the respective degree. When OFF is selected, no sound is output from the LFE channel.	<b>0dB</b> <hr/> <i>-5dB/ -10dB/</i> <i>-15dB/ -20dB/</i> <i>OFF</i>
<b>SACD GAIN</b> <sup>e</sup>	Brings out detail in SACDs by maximizing the dynamic range (during digital processing).	0 to 6 (dB) Default: <b>0</b> (dB)
<b>HDMI</b> <sup>f</sup> (HDMI Audio)	Specifies the routing of the HDMI audio signal out of this receiver ( <i>amp</i> ) or <i>through</i> to a TV or flat panel TV. When THROUGH is selected, no sound is output from this receiver.	<b>AMP</b> <hr/> <i>THROUGH</i>
<b>A. DELAY</b> (Auto delay)	This feature automatically corrects the audio-to-video delay between components connected with an HDMI cable. The audio delay time is set depending on the operational status of the display connected with an HDMI cable. The video delay time is automatically adjusted according to the audio delay time. <sup>9</sup>	<b>OFF</b> <hr/> <i>ON</i>
<b>C. WIDTH</b> <sup>h</sup> (Center Width) (Applicable only when using a center speaker)	Provides a better blend of the front speakers by spreading the center channel between the front right and left speakers, making it sound wider (higher settings) or narrower (lower settings).	0 to 7 Default: <b>3</b>
<b>DIMENSION</b> <sup>h</sup>	Adjusts the depth of the surround sound balance from front to back, making the sound more distant (minus settings), or more forward (positive settings).	-3 to +3 Default: <b>0</b>
<b>PANORAMA</b> <sup>h</sup>	Extends the front stereo image to include the surround speakers for a 'wraparound' effect.	<b>OFF</b> <hr/> <i>ON</i>

#### Note

<sup>1</sup> Brightness, Contrast, Hue, Chroma, Resolution and Aspect can be set for each input source.

Setting	What it does	Option(s)
<b>C. IMAGE</b> <sup>i</sup> (Center Image) (Applicable only when using a center speaker)	Adjusts the center image to create a wider stereo effect with vocals. Adjust the effect from <b>0</b> (all center channel sent to front right and left speakers) to <b>10</b> (center channel sent to the center speaker only).	0 to 10 Default: <b>3</b> (Neo:6 Music), <b>10</b> (Neo:6 Cinema)
<b>EFFECT</b>	Sets the effect level for the currently selected Advanced Surround mode (each mode can be set separately).	10 to 90

a. When **MCACC OFF** is selected, all MCACC preset memories become deactivated.

b. Cannot be selected when DTS-HD and DTS-EXPRESS audio signals are being input and the HOME THX mode is set. In this case, the ADVANCED MCACC indicator automatically turns off.

c. When **EQ OFF** is selected, the MCACC indicator does not light even when a MCACC preset memory is selected.

d. The initially set **AUTO** is only available for Dolby TrueHD signals. Select **MAX** or **MID** for signals other than Dolby TrueHD.

e. You shouldn't have any problems using this with most SACD discs, but if the sound distorts, it is best to switch the gain setting back to **0** dB.

f. • HDMI Audio setting cannot be switched while performing synchronized amp mode operations.

• The synchronized amp mode must be turned on in order to play the receiver's HDMI audio and video input signals from the TV with the receiver's power in the standby mode. See *Synchronized amp mode* on page 68.

g. This feature is only available when the connected display supports the automatic audio/video synchronizing capability ('lip-sync') for HDMI. If you find the automatically set delay time unsuitable, set **A. DELAY** to **OFF** and adjust the delay time manually. For more details about the lip-sync feature of your display, contact the manufacturer directly.

h. Only when listening to 2-channel sources in Dolby Pro Logic IIx Music/ Dolby Pro Logic II Music mode.

i. Only when listening to 2-channel sources in Neo:6 Cinema and Neo:6 Music mode.

## Setting the Video options

There are a number of additional picture settings you can make using the Video Parameter menu. The defaults, if not stated, are listed in bold.



### Important

- Note that if a setting doesn't appear in the Video Parameter menu, it is unavailable due to the current source, setting and status of the receiver.

**1 Press RECEIVER, then press VIDEO PARAMETER.**

**2 Use ↑/↓ to select the setting you want to adjust.**

Depending on the current status/mode of the receiver, certain options may not be able to be selected. Check the table below for notes on this.

**3 Use ←/→ to set it as necessary.**

See the table below for the options available for each setting.<sup>1</sup>

**4 Press RETURN to confirm and exit the menu.**

Setting	What it does	Option(s)
<b>V. CONV</b> (Digital Video Conversion)	Converts video signals for output from the <b>MONITOR OUT</b> jacks for all video types.	<b>ON</b> <i>OFF</i>
<b>BRIGHT</b> (Brightness)	Adjusts the overall brightness.	-10 to +10 Default: <b>0</b>
<b>CONTRAST</b>	Adjusts the contrast between light and dark.	-10 to +10 Default: <b>0</b>
<b>HUE</b>	Adjusts the red/green balance.	-10 to +10 Default: <b>0</b>
<b>CHROMA</b>	Adjusts saturation from dull to bright.	-10 to +10 Default: <b>0</b>
<b>RES<sup>a</sup></b> (Resolution)	Specifies the output resolution of the video signal (when analog video input signals are output at the HDMI OUT connector, select this according to the resolution of your monitor and the images you wish to watch). When <b>AUTO</b> is selected, the resolution is automatically selected depending on the capability of the display connected to this receiver. When <b>PURE</b> is selected, the signals are output with the same resolution as when input.	<b>AUTO</b> <i>PURE</i> <i>480p/576p</i> <i>720p</i> <i>1080i</i> <i>1080p</i>
<b>ASP<sup>b</sup></b> (Aspect)	Specifies the aspect ratio when analog video input signals are output at the HDMI output. Make your desired settings while checking each setting on your display.	<b>THROUGH</b> <i>NORMAL</i> <i>ZOOM</i>

a. When a resolution value is selected in this setting and the analog signals input are converted and output as HDMI signals, images may not appear depending on the video signals being input or the resolution of your monitor. Also, depending on the source component or the monitor being used, the output resolution may be different from this setting. Conversion to 1080p is available only for the input signals of 480i/576i/480p/576p.

b. If the image doesn't match your monitor type, adjust the aspect ratio on the source component or on the monitor.

## Making an audio or a video recording

You can make an audio or a video recording from the built-in tuner, or from an audio or video source connected to the receiver (such as a CD player or TV).<sup>1</sup>

Keep in mind you can't make a digital recording from an analog source or vice-versa, so make sure the components you are recording to/from are hooked up in the same way (see *Connecting your equipment* on page 13 for more on connections).

Since the video converter is not available when making recordings (from the video **OUT** jacks) make sure to use the same type of video cable for connecting your recorder as you used to connect your video source (the one you want to record) to this receiver. For example, you must connect your recorder using S-Video if your source has also been connected using S-Video.

For more information about video connections, see *Connecting a DVD/HDD recorder, VCR and other video sources* on page 18.

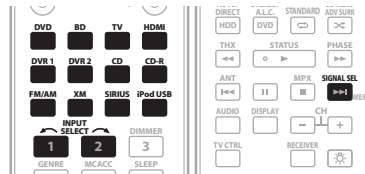

### 1 Select the source you want to record.

Use the input source buttons (or **INPUT SELECT**).

- If necessary, press **SIGNAL SEL** to select the input signal corresponding to the source component (see *Choosing the input signal* on page 33 for more on this).

### 2 Prepare the source you want to record.

Tune to the radio station, load the CD, video, DVD, etc.

### 3 Prepare the recorder.

Insert a blank tape, MD, video, etc. into the recording device and set the recording levels.

Refer to the instructions that came with the recorder if you are unsure how to do this. Most video recorders set the audio recording level automatically—check the component's instruction manual if you're unsure.

### 4 Start recording, then start playback of the source component.

#### Note

- The receiver's volume, Audio parameters (the bass/treble controls, for example), and surround effects have no effect on the recorded signal.
  - Some digital sources are copy-protected, and can only be recorded in analog.
  - Some video sources are copy-protected. These cannot be recorded.

## Reducing the level of an analog signal

The input attenuator lowers the input level of an analog signal when it's too strong. You can use this if you find that the **OVER** indicator lights often, or you can hear distortion in the sound.<sup>1</sup>

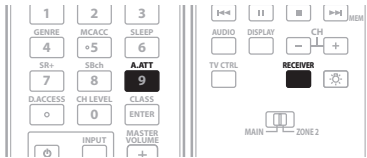

- Press **RECEIVER**, then press **A.ATT** to switch the input attenuator on or off.

## Using the sleep timer

The sleep timer switches the receiver into standby after a specified amount of time so you can fall asleep without worrying about the receiver being left on all night. Use the remote control to set the sleep timer.

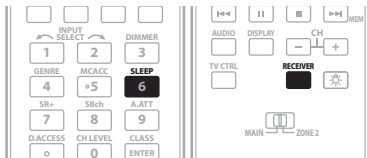

- Press **RECEIVER**, then press **SLEEP** repeatedly to set the sleep time.

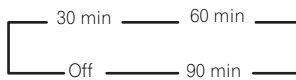

- You can check the remaining sleep time at any time by pressing **SLEEP** once. Pressing repeatedly will cycle through the sleep options again.<sup>2</sup>

## Dimming the display

You can choose between four brightness levels for the front panel display. Note that when selecting sources, the display automatically brightens for a few seconds.

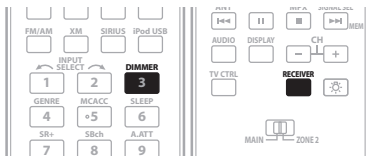

- Press **RECEIVER**, then press **DIMMER** repeatedly to change the brightness of the front panel display.

## Switching the speaker impedance

We recommend using speakers of 8  $\Omega$  with this system, but it is possible to switch the impedance setting if you plan to use speakers with a 6  $\Omega$  impedance rating. Use the front panel controls to do this.

- With the receiver in standby, press **STANDBY/ON** while holding down the **SPEAKERS** button.

Each time you do this, you switch between the impedance settings:

- **Speaker 6  $\Omega$**  – Use this setting if your speakers are rated at 6  $\Omega$ .
- **Speaker 8  $\Omega$**  – Use this setting if your speakers are rated at 8  $\Omega$  or more.

## Checking your system settings

Use the status display screen to check your current settings for features such as surround back channel processing and your current MCACC preset.

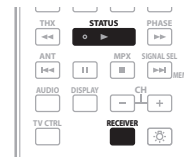

- 1 Press **RECEIVER**, then press **STATUS** to check the system settings.

These appear on the front panel display.<sup>3</sup>

The front panel display shows each of the following settings for three seconds each:

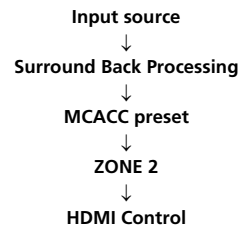

- 2 When you're finished, press **STATUS** again to switch off the display.

### Note

<sup>1</sup> The attenuator isn't available with digital sources, or when using the Stream Direct modes.

<sup>2</sup> You can also switch off the sleep timer simply by switching off the receiver.

<sup>3</sup> If the Pure Direct mode is switched on, some settings above will show **OFF**, even though they are on.

## Resetting the system

Use this procedure to reset all the receiver's settings to the factory default. Use the front panel controls to do this.

### 1 Switch the receiver into standby.

### 2 While holding down the front panel STEREO/A.L.C button, press and hold $\odot$ STANDBY/ON for about two seconds.

The display shows **RESET?**.

### 3 Press the front panel AUTO SURR/STREAM DIRECT button.

The display shows **OK**.

### 4 Press HOME THX to confirm.

**OK** appears in the display to indicate that the receiver has been reset to the factory default settings.

- Note that all settings will be saved, even if the receiver is unplugged.

## Default system settings

Setting	Default
HDMI Audio	Amp
HDMI Control	ON
Digital Video Conversion	ON
Speakers	A
Surround Back System	Normal
Speaker System	Front
	Center
	Surr
	SB
	SW
	SMALL
	SMALL
	SMALL
	SMALLx2
	YES
Crossover	80 Hz
X-Curve	OFF
THX Audio Setting	0–1 ft.
<b>Inputs</b>	
See <i>Input function default and possible settings</i> on page 70.	
<b>MULTI-ZONE</b>	
Zone 2 Volume Type	Variable
Zone 2 Volume	–60 dB
<b>SR+</b>	
SR+ Control On/Off	OFF
SR+ Volume Control On/Off	OFF
Monitor Out	OFF
<b>DSP</b>	
Surround back channel Processing	ON
Phase Control	ON
Sound Retriever	OFF

Setting	Default
Sound Delay	0.0 frame
Dual Mono	CH1
DRC	OFF
SACD Gain	0 dB
LFE Attenuate	0 dB
Auto delay	OFF
Digital Safety	OFF
Effect Level	Extended Stereo
	Other modes
	90
	50
$\square$ PL II Music Options	Center Width
	Dimension
	Panorama
	3
	0
	OFF
Neo:6 Options	Center Image
	3 (Neo:6 Music)
	10 (Neo:6 Cinema)
All Inputs	Listening Mode (2 ch)
	AUTO
	SURROUND
	Listening Mode (x ch)
	AUTO
	SURROUND
	Listening Mode (HP)
	STEREO

See also *Setting the Audio options* on page 73 for other default DSP settings.

<b>MCACC</b>	
MCACC Position Memory	M1: MEMORY 1
Channel Level (M1–M6)	0.0 dB
Speaker Distance (M1–M6)	10'00" (10 ft. 00 in.)
Standing Wave (M1–M6)	ATT
	SWch Wide Trim
	0.0 dB
EQ Data (M1–M6)	All channels/bands
	EQ Wide Trim
	0.0 dB

## Chapter 12:

# Controlling the rest of your system

## Setting the remote to control other components

Most components can be assigned to one of the input source buttons (such as **DVD** or **CD**) using the component's manufacturer preset code stored in the remote.

However, there are cases where only certain functions may be controllable after assigning the proper preset code, or the codes for the manufacturer in the remote control will not work for the model that you are using.

### Note

- You can cancel or exit any of the steps by pressing **RECEIVER**. To go back a step, press **RETURN**.
- After one minute of inactivity, the remote automatically exits the operation.

## Selecting preset codes directly

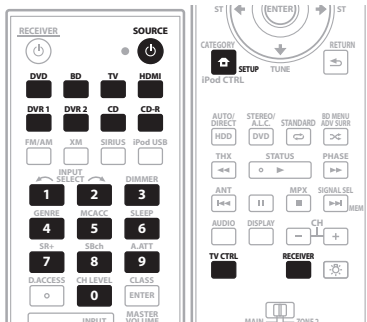

**1 While pressing the RECEIVER button, press SETUP.** The indicator on the remote control blinks.

**2 Press the input source button for the component you want to control.**

When assigning preset codes to **TV CONTROL**, press **TV CTRL** here.

The indicator lights up.<sup>1</sup>

**3 Use the number buttons to enter the 3 digit preset code (see below).**

The indicator blinks for half a second after you input each digit and shows a long, two second blink once you have entered a valid code. If the LED blinks three times, it means an invalid code has been input or an error has occurred.

**4 Repeat steps 1 through 3 for the other components you want to control.**

**5 When you're done, press RECEIVER.**

To try out the remote control, switch the component on or off (into standby) by pressing **SOURCE**. If it doesn't seem to work, select the next code from the list (if there is one).

## Preset code list

You should have no problem controlling a component if you find the manufacturer in this list, but please note that there are cases where codes for the manufacturer in the list will not work for the model that you are using. There are also cases where only certain functions may be controllable after assigning the proper preset code.

### DVD

#### Manufacturer Code

AKAI 007  
 DENON 003, 010  
 GOLDSTAR 014  
 HITACHI 012  
 JVC 004  
 LOEWE 013  
 MICROSOFT 017 (video game)  
 PANASONIC 003, 019  
 PHILIPS 013  
 PIONEER 000, 003, 009, 018, 020, 021 (BDP), 023 (BDP)  
 RCA 008, 011  
 SAMSUNG 005  
 SHARP 006  
 SONY 002, 016 (video game)  
 THOMSON 015  
 TOSHIBA 001, 022 (HD DVD)  
 ZENITH 014

### LD

#### Manufacturer Code

KENWOOD 103  
 MITSUBISHI 100  
 PANASONIC 105, 106  
 PHILIPS 104  
 PIONEER 100, 111  
 RCA 107  
 SONY 101

### SAT

#### Manufacturer Code

BELL 208  
 ECHOSTAR 205  
 PIONEER 200, 210  
 PRIMESTAR 206  
 RCA 201, 203, 209  
 SONY 202

### CD

#### Manufacturer Code

California Audio labs 304  
 DENON 309  
 JVC 303  
 KENWOOD 310, 311, 321  
 KODAK 322  
 MARANTZ 304, 312, 323, 324  
 MCS 304  
 MEMOREX 300  
 NAD 316  
 ONKYO 307, 308, 320  
 OPTIMUS 300  
 PANASONIC 304, 326  
 PHILIPS 312, 322  
 PIONEER 300, 348 (SACD)  
 QUASAR 304  
 RCA 302, 313, 319  
 SANYO 313  
 SONY 301, 316, 317, 318  
 TEAC 305, 306, 324, 325, 327  
 THOMSON 319  
 YAMAHA 314, 315, 328

### Note

<sup>1</sup> You can't assign the **RECEIVER**, **FM/AM**, **iPod USB**, **XM** or **SIRIUS** buttons.

## DVR

*Manufacturer Code*  
**PANASONIC** 491, 492  
**PIONEER** 480, 481, 482, 483, 484, 487, 488, 489, 493  
**SHARP** 496  
**SONY** 490, 494  
**TOSHIBA** 485, 495

## DTV

*Manufacturer Code*  
**PANASONIC** 230  
**PIONEER** 207, 229

## VCR

*Manufacturer Code*  
**AIWA** 441  
**AKAI** 417  
**ALBA** 424  
**AMSTRAD** 441  
**ASA** 411, 414  
**BAIRD** 417, 441  
**BLAUPUNKT** 408, 417, 432  
**BRANDT ELECTRONIQUE** 417  
**BUSH** 424  
**CGB** 441  
**DECCA** 414, 441  
**DUAL** 417  
**DUMONT** 414, 441  
**FERGUSON** 417  
**FIDELITY** 441  
**FINLANDIA** 414  
**FINLUX** 406, 414, 441  
**FIRST LINE** 405, 409, 411, 424  
**FISHER** 410, 412, 420, 425, 426, 427  
**FUNAI** 441  
**GBC** 414  
**GOLDSTAR** 409, 411  
**GOODMANS** 411, 441  
**GRADIENTE** 441  
**GRAETZ** 417  
**GRANADA** 414  
**GRANDIG** 408, 414, 441  
**GRANDIN** 411, 441  
**HITACHI** 401, 406, 408, 417, 434, 436, 441  
**IMPERIAL** 441  
**INTERFUNK** 414  
**ITT** 417, 428  
**ITV** 411  
**JVC** 407, 408, 414, 417, 428, 429, 430, 431  
**KENDO** 424  
**LOEWE** 414, 432  
**LUXOR** 409  
**MAGNAVOX** 403, 408, 414, 426  
**MANESTH** 405  
**MARANTZ** 414  
**MATSUI** 424  
**MEMOREX** 411, 441  
**METZ** 432  
**M-ELECTRONIC** 441  
**MINISUBISHI** 407, 408, 409, 414, 420, 421, 422, 423, 424  
**MULTITECH** 441  
**MURPHY** 441  
**NBC** 417  
**NECKERMANN** 414  
**NOKIA** 417  
**NORDMENDE** 417, 428  
**OCEANIC** 417, 441  
**OPTIMUS** 402, 408, 418, 419, 432, 433  
**ORION** 424, 445, 446  
**OSAKI** 411, 441  
**OTTO VERSAND** 414  
**PALLADIUM** 411, 417  
**PANASONIC** 408, 432, 433

**PATHE MARCONI** 417  
**PENTAX** 406  
**PERDIO** 441  
**PHILIPS** 414, 428  
**PHONOLA** 414  
**PIONEER** 400, 407, 414, 437, 438, 439  
**PROLINE** 441  
**PYE** 414  
**QUELLE** 414  
**RADIOLA** 414  
**RCA** 401, 405, 406, 408, 411, 413, 414, 415, 435, 460, 461, 462, 463  
**REX** 417, 428  
**ROADSTAR** 411  
**SABA** 417, 428  
**SAISHO** 424  
**SALORA** 409  
**SANSUI** 407, 417  
**SANYO** 410, 412, 425, 435  
**SBR** 414  
**SCHAUB LORENZ** 417, 441  
**SCHNEIDER** 414, 441  
**SEI** 414  
**SELECO** 417  
**SHARP** 402, 418, 419  
**SIEMENS** 411  
**SINGER** 405  
**SINUDYNE** 414  
**SONY** 408, 416, 417, 457, 458, 459, 404 (Beta)  
**SUNSTAR** 441  
**SUNTRONIC** 441  
**TASHIKO** 441  
**TATUNG** 414, 417, 441  
**TELEAVIA** 417  
**TELEFUNKEN** 417, 428  
**TENSAI** 441  
**THOMSON** 417, 428  
**THORN** 417  
**TOSHIBA** 405, 409, 414, 417, 426, 428  
**UNIVERSUM** 411, 414, 441  
**ZENITH** 403, 404, 417

## CATV

*Manufacturer Code*  
**GENERAL INSTRUMENT** 701  
**JERROLD** 701, 702, 703, 704, 711, 712, 713, 714, 715, 716  
**PIONEER** 700, 718  
**PVP STEREO VISUAL MATRIX** 701  
**S.ATLANTA** 705, 706, 708, 709  
**ZENITH** 707, 710, 717

## TAPE

*Manufacturer Code*  
**ARCAM** 810  
**DENON** 810  
**FISHER** 813  
**JVC** 802  
**KENWOOD** 804, 807  
**ONKYO** 808, 809  
**OPTIMUS** 800  
**PIONEER** 800, 814  
**SONY** 801, 806  
**TEAC** 805  
**TECHNICS** 803  
**YAMAHA** 811, 812

## MD

*Manufacturer Code*  
**DENON** 906  
**KENWOOD** 903  
**ONKYO** 905  
**PIONEER** 900, 907, 908  
**SHARP** 902  
**SONY** 901  
**TEAC** 904

## CD-R

*Manufacturer Code*  
**PHILIPS** 346  
**PIONEER** 345  
**YAMAHA** 347

## TV

*Manufacturer Code*  
**AIWA** 660  
**AKAI** 635  
**ALBA** 607  
**AMSTRAD** 635  
**AUDIOGONIC** 607, 634  
**BAUR** 607, 635  
**BEON** 607  
**BLUE STAR** 618  
**BPL** 618  
**BRANDT** 634  
**BUSH** 607, 635  
**CATHAY** 607  
**CENTURION** 607  
**CGB** 635  
**CLARIVOX** 607  
**CRYSTAL** 635  
**DAEWOO** 607, 676, 677  
**DANSAI** 607  
**DECCA** 607  
**DIXI** 607  
**ELIN** 607  
**EMERSON** 635  
**EPSON** 681  
**ERRS** 607  
**FERGUSON** 607, 634, 636  
**FINLUX** 607  
**FORMENTI** 607, 635  
**FRONTECH** 635  
**FUNAI** 629, 658  
**GBC** 635  
**GE** 600, 602, 607, 608, 610, 611, 617, 618, 628  
**GEC** 607  
**GENERAL** 629, 666  
**GOLDSTAR** 602, 607, 610, 623, 621  
**GOODMAN** 607  
**FRANZ** 635  
**GRANADA** 607, 635  
**GRADIENTE** 630  
**GRANDIN** 618  
**HANSEATIC** 607, 635

**HCM** 618  
**HISAWA** 618  
**HITACHI** 606, 610, 618, 624, 625, 634, 635, 664  
**HYPSON** 618  
**IMPERIAL** 635  
**INTERFUNK** 635  
**ITC** 635  
**JVC** 613, 623, 665, 683  
**KAISUI** 618  
**KENDO** 635  
**KENNEDY** 635  
**LOEWE** 607  
**LUXOR** 635  
**MAGNAVOX** 603, 607, 610, 612, 629  
**MATSUI** 635  
**M-ELECTRONIC** 634, 636  
**MINISUBISHI** 602, 609, 610, 621, 682  
**NEC** 659  
**NOKIA** 632, 635  
**NORDEENTE** 636  
**ORION** 607  
**PANASONIC** 607, 608, 622, 635, 671  
**PHILCO** 635  
**PHILIPS** 607  
**PIONEER** 600, 631, 632, 634, 635, 636, 637, 638, 639, 667, 668, 669, 670, 678, 679, 688, 689  
**PROFEX** 635  
**PROTECH** 635  
**RADIOLA** 607  
**RADIOHACK** 602, 610, 621, 623  
**RCA** 601, 609, 610, 615, 616, 617, 618  
**SABA** 634, 635, 636  
**SAMSUNG** 607, 673, 674, 675  
**SANYO** 614, 621, 685  
**SCHNEIDER** 607  
**SHARP** 602, 619, 627, 661  
**SONY** 604, 684  
**TELEAVIA** 634  
**TELEFUNKEN** 634  
**THOMSON** 636  
**TOMASHI** 618  
**TOSHIBA** 602, 605, 621, 626, 663  
**UNIDEN** 687  
**YAMAHA** 686  
**ZENITH** 603, 620

## Controls for TVs

This remote control can control components after entering the proper codes or teaching the receiver the commands (see *Setting the remote to control other components* above for more on this). Use the input source buttons to select the component.

- The **TV CONTROL** buttons on the remote control are dedicated to control the TV assigned to the **TV CTRL** button. If you have two TVs, assign the main TV to the **TV CTRL** button.

Button(s)	Function	Components
TV	Press to switch the component assigned to the <b>TV CTRL</b> button on or off.	Cable TV/ Satellite TV/TV/ DTV
INPUT	Switches the TV input. (Not possible with all models.)	Cable TV/ Satellite TV/TV/ DTV

Button(s)	Function	Components
<b>CH +/-</b>	Selects channels.	Cable TV/ Satellite TV/TV/ DTV
<b>VOL +/-</b>	Adjust the TV volume.	Cable TV/ Satellite TV/TV/ DTV
<b>SOURCE</b> 	Switches the DTV on or off. Switches the TV or CATV between standby and on.	DTV Cable TV/ Satellite TV/TV
<b>▶▶</b>	Press to get information on DTV programs.	DTV
<b>AUTO/DIRECT</b>	Use to choose the BLUE commands on a DTV menu.	DTV
<b>ADV SURR</b>	Use to choose the YELLOW commands on a DTV menu.	DTV
<b>STEREO/A.L.C.</b>	Use to choose the RED commands on a DTV menu.	DTV
<b>STANDARD</b>	Use to choose the GREEN commands on a DTV menu.	DTV
<b>AUDIO</b>	Use to switch DTV audio tracks.	DTV
<b>ANT</b>	Use to select the VHF/UHF antennas or Cable TV.	Cable TV/TV
<b>TOOLS</b>	Use to display the TOOLS menu on the flat panel TV.	TV
<b>EXIT</b>	Use to return to the normal screen in one step.	TV
<b>RETURN</b>	Use to select <b>RETURN</b> or <b>EXIT</b> .	DTV
Number buttons	Use to select a specific TV channel.	Cable TV/ Satellite TV/TV/ DTV
<b>D.ACCESS</b>	Use to add a decimal point when selecting a TV channel.	DTV
<b>ENTER/CLASS</b>	Use to enter a channel.	Cable TV/ Satellite TV/TV/ DTV
<b>MENU</b>	Select different menus from the DTV functions. Select the menu screen.	DTV Cable TV/ Satellite TV/TV
<b>↑/↓/←/→ &amp; ENTER</b>	Select, adjust and navigate items on the menu screen.	Cable TV/ Satellite TV/TV/ DTV

## Controls for other components

This remote control can control these components after entering the proper codes or teaching the receiver the commands (see *Setting the remote to control other components* on page 78 for more on this). Use the input source buttons to select the component.

Button(s)	Function	Components
<b>SOURCE</b> 	Press to switch the component between standby and on.	CD/MD/CD-R/ VCR/DVD/LD/ BD/DVR player/ Cassette deck
<b>◀◀</b>	Press to return to the start of the current track or chapter. Repeated presses skips to the start of previous tracks or chapters.	CD/MD/CD-R/ DVD/LD/BD player
<b>▶▶</b>	Press to advance to the start of the next track or chapter. Repeated presses skips to the start of following tracks or chapters.	CD/MD/CD-R/ DVD/LD/BD player
<b>  </b>	Pause playback or recording.	CD/MD/CD-R/ VCR/DVD/LD/ BD/DVR player/ Cassette deck
<b>▶</b>	Start playback.	CD/MD/CD-R/ VCR/DVD/LD/ BD/DVR player/ Cassette deck
<b>▶▶▶</b>	Hold down for fast forward playback.	CD/MD/CD-R/ VCR/DVD/LD/ BD/DVR player/ Cassette deck
<b>◀◀◀</b>	Hold down for fast reverse playback.	CD/MD/CD-R/ VCR/DVD/LD/ BD/DVR player/ Cassette deck
<b>■</b>	Stops playback.	CD/MD/CD-R/ VCR/DVD/LD/ BD/DVR player/ Cassette deck
Number buttons	Directly access tracks on a program source. Use the number buttons to navigate the on-screen display.	CD/MD/CD-R/ VCR/LD/BD player DVD/DVR player
<b>D.ACCESS</b>	Selects tracks higher than 10. (For example, press <b>+10</b> , then <b>3</b> to select track 13.)	CD/MD/CD-R/ VCR/LD player



Button(s)	Function	Components
<b>ENTER/CLASS</b>	Chooses the disc.	Multiple CD player
	Use as the <b>ENTER</b> button.	VCR/DVD/BD player
	Displays the setup screen for DVR players.	DVR player
	Changes sides of the LD.	LD player
<b>TOP MENU</b>	Displays the disc 'top' menu of a DVD player.	DVD/BD/DVR player
<b>MENU</b>	Displays menus concerning the current DVD or DVR you are using.	DVD/BD/DVR player
<b>↑</b>	Pauses the tape.	Cassette deck
<b>↓</b>	Stops the tape.	Cassette deck
<b>ENTER</b>	Starts playback.	Cassette deck
<b>←/→</b>	Fast rewinds/fast forwards the tape.	Cassette deck
<b>↑/↓/←/→ &amp; ENTER</b>	Navigates DVD menu/options.	DVD/DVR player
<b>CH +/-</b>	Selects channels.	VCR/DVD/DVR player
<b>AUDIO</b>	Changes the audio language or channel.	DVD/BD/DVR player
<b>DISPLAY</b>	Press to display information.	DVD/BD/DVR player
<b>HDD</b>	Switches to the hard disk controls when using a DVD/HDD recorder.	DVR player
<b>DVD</b>	Switches to the DVD controls when using a DVD/HDD recorder.	DVR player

### 1 Decide which component you want to use the remote sensor of.

When you want to control any component in the chain, this is the remote sensor at which you'll point the corresponding remote control.

### 2 Connect the CONTROL OUT jack of that component to the CONTROL IN jack of another Pioneer component.

Use a cable with a mono mini-plug on each end for the connection.

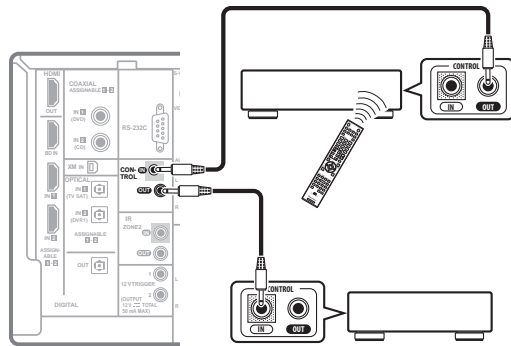

### 3 Continue the chain in the same way for as many components as you have.

## Operating other Pioneer components with this receiver's sensor

Many Pioneer components have **CONTROL** jacks which can be used to link components together so that you can use just the remote sensor of one component. When you use a remote control, the control signal is passed along the chain to the appropriate component.<sup>1</sup>

### Important

- Note that if you use this feature, *make sure that you also have at least one set of analog audio, video or HDMI jacks connected to another component for grounding purposes.*

### Note

- <sup>1</sup> • If you want to control all your components using this receiver's remote control, refer to *Setting the remote to control other components* on page 78. If you have connected a remote control to the **CONTROL IN** jack (using a mini-plug cable), you won't be able to control this receiver using the remote sensor.
- See *Using this receiver with a Pioneer flat panel TV* on page 64 if you are connecting a Pioneer flat panel TV.

## Chapter 13: Additional information

### Troubleshooting

Incorrect operations are often mistaken for trouble and malfunctions. If you think that there is something wrong with this component, check the points below. Sometimes the trouble may lie in another component. Investigate the other components and electrical appliances being used. If the trouble cannot be rectified even after exercising the checks listed below, ask your nearest Pioneer authorized independent service company to carry out repair work.

#### Power

Symptom	Remedy
The power does not turn on.	<ul style="list-style-type: none"> <li>• Make sure that the power cable is plugged in to an active power outlet.</li> <li>• Try disconnecting from the power outlet, then plugging back in.</li> </ul>
The receiver suddenly switches off or the PHASE CONTROL indicator blinks.	<ul style="list-style-type: none"> <li>• Check that there are no loose strands of speaker wire touching the rear panel or another set of wires. If so, re-attach the speaker wires, making sure there are no stray strands.</li> <li>• The receiver may have a serious problem. Disconnect from the power and call a Pioneer authorized independent service company.</li> </ul>
During loud playback the power suddenly switches off.	<ul style="list-style-type: none"> <li>• Turn down the volume.</li> <li>• Lower the 63 Hz and 125 Hz equalizer levels in the <i>Manual MCACC setup</i> on page 41.</li> <li>• Try switching on the digital safety feature (put the receiver into standby, hold down the <b>ADVANCED/SURROUND</b> button on the front panel and press <b>STANDBY/ON</b> to switch between <b>SAFETY 1 ON</b> (medium effect), <b>SAFETY 2 ON</b> (more effect) and <b>SAFETY OFF</b>). If the power switches off even with <b>SAFETY 2 ON</b>, turn down the volume. With <b>SAFETY 1 ON</b> or <b>SAFETY 2 ON</b> on, some features may be unavailable.</li> </ul>
The unit does not respond when the buttons are pressed.	<ul style="list-style-type: none"> <li>• Try switching the receiver off, then back on again.</li> <li>• Try disconnecting the power cable, then connect again.</li> </ul>
<b>AMP ERR</b> blinks in the display, then the power automatically switches off. The <b>MCACC</b> blinks and the power does not turn on.	<ul style="list-style-type: none"> <li>• The receiver may have a serious problem. Do not try switching the receiver on. Contact a Pioneer authorized independent service company for help.</li> </ul>
<b>AMP OVERHEAT</b> blinks in the display, then the power automatically switches off.	<ul style="list-style-type: none"> <li>• Allow the unit to cool down in a well-ventilated place before switching back on. Check the safety precautions on page 2 for information on improving heat dispersal.</li> </ul>
Display blinks <b>12 TRG ERR</b> .	<ul style="list-style-type: none"> <li>• An error has arisen in the 12 V trigger jacks. Reconnect accurately then turn the power back on.</li> </ul>
The receiver suddenly switches off or DIGITAL PRECISION PROCESSING indicator blinks.	<ul style="list-style-type: none"> <li>• The receiver may have a serious problem. Do not try switching the receiver on. Contact a Pioneer authorized independent service company for help.</li> </ul>

#### No sound

Symptom	Remedy
No sound is output when an input source is selected.	<ul style="list-style-type: none"> <li>• Check the volume, mute setting (press <b>MUTE</b>) and speaker setting (press <b>SPEAKERS</b>).</li> <li>• Make sure the correct input source is selected.</li> </ul>
No sound output from the front speakers.	<ul style="list-style-type: none"> <li>• Check that the MCACC setup microphone is disconnected.</li> <li>• Make sure the correct input signal is selected (press <b>SIGNAL SEL</b>). Note that when <b>PCM</b> is selected, you won't be able to hear any other signal format.</li> <li>• Check that the source component is connected properly (see <i>Connecting your equipment</i> on page 13).</li> <li>• Check that the speakers are connected properly (see <i>Connecting the speakers</i> on page 21).</li> </ul>

Symptom	Remedy
No sound from the surround or center speakers.	<ul style="list-style-type: none"> <li>• Check that the Stereo listening mode or the Front Stage Surround Advance mode isn't selected; select one of the surround listening modes (see <i>Listening in surround sound</i> on page 30).</li> <li>• Check that the surround/center speakers are not set to <b>NO</b> (see <i>Speaker Setting</i> on page 48).</li> <li>• Check the channel level settings (see <i>Channel Level</i> on page 49).</li> <li>• Check the speaker connections (see <i>Connecting the speakers</i> on page 21).</li> </ul>
No sound from surround back speakers.	<ul style="list-style-type: none"> <li>• Check that the surround back speakers are set to <b>LARGE</b> or <b>SMALL</b> (see <i>Speaker Setting</i> on page 48).</li> <li>• Make sure surround back processing is set to <b>SBch ON</b> (see <i>Using surround back channel processing</i> on page 34).</li> <li>• If the source is Dolby Surround EX or DTS-ES with no flag to indicate 6.1 compatibility, then with surround back processing set to <b>SBch Auto</b>, there will be no sound from the surround back speakers. In this case, set to <b>SBch ON</b> (see <i>Using surround back channel processing</i> on page 34).</li> <li>• If the source does not have 6.1 playback channels, make sure that surround back processing is set to <b>SBch ON</b> and a surround mode is selected (see <i>Listening in surround sound</i> on page 30).</li> <li>• Check the speaker connections (see <i>Connecting the speakers</i> on page 21). If only one surround back speaker is connected, make sure it's connected to the left channel speaker terminal.</li> </ul>
No sound from subwoofer.	<ul style="list-style-type: none"> <li>• Check that the subwoofer is connected properly, switched on and the volume turned up.</li> <li>• If your subwoofer has a sleep function, make sure it is switched off.</li> <li>• Make sure that the Subwoofer setting is <b>YES</b> or <b>PLUS</b> (see <i>Speaker Setting</i> on page 48).</li> <li>• The crossover frequency may be set too low; try setting it higher to match the characteristics of your other speakers (see <i>Speaker Setting</i> on page 48).</li> <li>• If there is very little low frequency information in the source material, change your speaker settings to Front: <b>SMALL</b> / Subwoofer: <b>YES</b>, or Front: <b>LARGE</b> / Subwoofer: <b>PLUS</b> (see <i>Speaker Setting</i> on page 48).</li> <li>• Check that the LFE channel is not set to <b>OFF</b>, or a very quiet setting (see <i>Setting the Audio options</i> on page 73).</li> <li>• Check the speaker level settings (see <i>Channel Level</i> on page 49).</li> </ul>
No sound from one speaker.	<ul style="list-style-type: none"> <li>• Check the speaker connection (see <i>Connecting the speakers</i> on page 21).</li> <li>• Check the speaker level settings (see <i>Channel Level</i> on page 49).</li> <li>• Check that the speaker hasn't been set to <b>NO</b> (see <i>Speaker Setting</i> on page 48).</li> <li>• The channel may not be recorded in the source. By using one of the advanced effect listening mode, you may be able to create the missing channel (see <i>Listening in surround sound</i> on page 30).</li> </ul>
Sound is produced from analog components, but not from digital ones (DVD, LD, CD-ROM, etc.).	<ul style="list-style-type: none"> <li>• Check that the input signal type is set to <b>DIGITAL</b> (see <i>Choosing the input signal</i> on page 33).</li> <li>• Make sure that the digital input is assigned correctly for the input jack the component is connected to (see <i>The Input Setup menu</i> on page 69).</li> <li>• Check the digital output settings on the source component.</li> <li>• If the source component has a digital volume control, make sure this is not turned down.</li> <li>• Make sure that the multichannel analog inputs are not selected. Select any other input source.</li> </ul>
No sound is output or a noise is output when Dolby Digital/DTS software is played back.	<ul style="list-style-type: none"> <li>• Check that your DVD player is compatible with Dolby Digital/DTS discs.</li> <li>• Check the digital output settings of your DVD player. Make sure that the DTS signal output is set to On.</li> <li>• If the source component has a digital volume control, make sure this is not turned down.</li> </ul>
No sound when using the System Setup or Status menu.	<ul style="list-style-type: none"> <li>• If the HDMI input source is selected, sound is muted until exiting either menu.</li> <li>• If sound is muted in the sub zone (<b>ZONE 2</b>), it will be restored after exiting the System Setup menu.</li> </ul>

## Other audio problems

Symptom	Remedy
Broadcast stations cannot be selected automatically, or there is considerable noise in radio broadcasts.	<p><i>For FM broadcasts</i></p> <ul style="list-style-type: none"> <li>Fully extend the FM wire antenna, adjust the position for best reception and secure to a wall, etc.</li> <li>Use an outdoor antenna for better reception (see page 24).</li> </ul> <p><i>For AM broadcasts</i></p> <ul style="list-style-type: none"> <li>Adjust the position and direction of the AM antenna.</li> <li>Use an outdoor antenna for better reception (see page 24).</li> <li>Noise may be caused by interference from other equipment, such as a fluorescent light, motor, etc. Switch off or move the other equipment, or move the AM antenna.</li> </ul>
A multichannel DVD source appears to be downmixed to 2 channels during playback.	<ul style="list-style-type: none"> <li>Make sure that the multichannel analog inputs are selected (see <i>Selecting the multichannel analog inputs</i> on page 59).</li> </ul>
Noise is output when scanning a DTS CD.	<ul style="list-style-type: none"> <li>This is not a malfunction of the receiver. The scan function of your player alters the digital information, making it unreadable, resulting in noise being output. Lower the volume when scanning.</li> </ul>
When playing a DTS format LD there is audible noise on the soundtrack.	<ul style="list-style-type: none"> <li>Make sure that the input signal type is set to <b>DIGITAL</b> (see <i>Choosing the input signal</i> on page 33).</li> </ul>
Can't record audio.	<ul style="list-style-type: none"> <li>You can only make a digital recording from a digital source, and an analog recording from an analog source.</li> <li>For digital sources, make sure that what you're recording isn't copy protected.</li> <li>Check that the <b>OUT</b> jacks are properly connected to the recorders input jacks (see <i>Connecting analog audio sources</i> on page 20).</li> </ul>
Subwoofer output is very low.	<ul style="list-style-type: none"> <li>To route more signal to the subwoofer, set it to <b>PLUS</b> or set the front speakers to <b>SMALL</b> (see <i>Speaker Setting</i> on page 48).</li> </ul>
Everything seems to be set up correctly, but the playback sound is odd.	<ul style="list-style-type: none"> <li>The speakers may be out of phase. Check that the positive/negative speaker terminals on the receiver are matched with the corresponding terminals on the speakers (see <i>Connecting the speakers</i> on page 21).</li> </ul>
The <b>PHASE CONTROL</b> feature doesn't seem to have an audible effect.	<ul style="list-style-type: none"> <li>If applicable, check that the lowpass filter switch on your subwoofer is off, or the lowpass cutoff is set to the highest frequency setting. If there is a <b>PHASE</b> setting on your subwoofer, set it to 0° (or depending on the subwoofer, the setting where you think it has the best overall effect on the sound).</li> <li>Make sure the speaker distance setting is correct for all speakers (see <i>Speaker Distance</i> on page 50).</li> </ul>
Noise or hum can be heard even when there is no sound being input.	<ul style="list-style-type: none"> <li>Check that personal computers or other digital components connected to the same power source are not causing interference.</li> </ul>
There seems to be a time lag between the speakers and the output of the subwoofer.	<ul style="list-style-type: none"> <li>See <i>Automatically setting up for surround sound (Auto MCACC)</i> on page 10 to set up your system again using MCACC (this will automatically compensate for a delay in the subwoofer output).</li> </ul>
Can't use the SR+ features.	<ul style="list-style-type: none"> <li>Make sure that HDMI Control is set to OFF (see <i>Setting the HDMI Control mode</i> on page 67).</li> </ul>
The maximum volume available (shown in the front panel display) is lower than the <b>+12dB</b> maximum.	<ul style="list-style-type: none"> <li>This is not a malfunction. If the levels in <i>Channel Level</i> on page 49 have been adjusted, the maximum volume will change accordingly.</li> </ul>

## Video

Symptom	Remedy
No image is output when an input is selected.	<ul style="list-style-type: none"> <li>• Check the video connections of the source component (see page 18).</li> <li>• For high-definition video (using component video connections), or when digital video conversion is switched off (in <i>Setting the Video options</i> on page 74), you must connect your TV to this receiver using the same type of video cable as you used to connect your video component.</li> <li>• Make sure the input assignment is correct for components connected using component or HDMI cables (see <i>The Input Setup menu</i> on page 69).</li> <li>• Check the video output settings of the source component.</li> <li>• Check that the video input you selected on your TV is correct.</li> <li>• Some components (such as video game units) have resolutions that may not be converted. If adjusting this receiver's Resolution setting (in <i>Setting the Video options</i> on page 74) and/or the resolution settings on your component or display doesn't work, try switching Digital Video Conversion (in <i>Setting the Video options</i> on page 74) <b>OFF</b>.</li> </ul>
Can't record video.	<ul style="list-style-type: none"> <li>• Check that the source is not copy-protected.</li> <li>• The video converter is not available when making recordings. Check that the same type of video cable is used for connecting both the recorder and the video source (the one you want to record) to this receiver.</li> </ul>
Noisy, intermittent, or distorted picture.	<ul style="list-style-type: none"> <li>• Sometimes a video deck may output a noisy video signal (during scanning, for example), or the video quality may just be poor (with some video game units, for example). The picture quality may also depend on the settings, etc. of your display device. Switch off the video converter and reconnect the source and display device using the same type of connection (component, S-Video or composite), then start playback again.</li> </ul>

## Settings

Symptom	Remedy
The Auto MCACC Setup continually shows an error.	<ul style="list-style-type: none"> <li>• The ambient noise level may be too high. Keep the noise level in the room as low as possible (see also <i>Problems when using the Auto MCACC Setup</i> on page 11). If the noise level cannot be kept low enough, you will have to set up the surround sound manually (page 41).</li> <li>• When using only one surround back speaker, connect it to the <b>SURROUND BACK L</b> (Single) terminals.</li> <li>• To use a 5.1-channel speaker set, use the surround speakers for the surround channel, not the surround back channel.</li> <li>• Make sure there are no obstacles between the speakers and the microphone.</li> </ul>
After using the Auto MCACC Setup, the speaker size setting is incorrect.	<ul style="list-style-type: none"> <li>• There may have been some low frequency noise in the room from an air-conditioner, motor, etc. Switch off all other appliances in the room and use Auto MCACC Setup again.</li> <li>• Depending on a number of factors (room size, speaker placement, etc.) this may occur in some cases. Change the speaker setting manually in <i>Speaker Setting</i> on page 48, and use the <b>ALL (Keep SP System)</b> option for the <b>Custom Menu</b> in <i>Automatic MCACC (Expert)</i> on page 38 if this is a recurring problem.</li> </ul>
Can't adjust the Fine Speaker Distance setting (page 42) properly.	<ul style="list-style-type: none"> <li>• Check that the speakers are all in phase (make sure the positive (+) and negative (-) terminals are matched up properly).</li> </ul>
The display shows <b>KEY LOCK ON</b> when you try to make settings.	<ul style="list-style-type: none"> <li>• With the receiver in standby, press <b>⏻ STANDBY/ON</b> while holding down the <b>SPEAKERS</b> button to disable the key lock.</li> </ul>
Most recent settings have been erased.	<ul style="list-style-type: none"> <li>• The power cord was disconnected from the wall while adjusting this setting.</li> </ul>

## Professional Calibration EQ graphical output

Symptom	Remedy
The EQ response displayed in the graphical output following calibration does not appear entirely flat.	<ul style="list-style-type: none"> <li>• There are cases where the graph does not appear flat (even when selecting <b>ALL CH ADJUST</b> in the Auto MCACC Setup) due to adjustments made to compensate for room characteristics to achieve optimal sound.</li> <li>• Areas of the graph may appear identical (before and after) when there is little or no adjustment needed.</li> <li>• The graph may appear to have shifted vertically when comparing before and after measurements.</li> </ul>
EQ adjustments made using the <i>Manual MCACC setup</i> on page 41 do not appear to change the graphical output.	<ul style="list-style-type: none"> <li>• Despite level adjustments being made, the filters used for analysis may not display these adjustments in the graphical output. However, these adjustments are taken into account by the filters dedicated to overall system calibration.</li> </ul>
Lower frequency response curves do not seem to have been calibrated for <b>SMALL</b> speakers.	<ul style="list-style-type: none"> <li>• Low frequencies used in bass management (the subwoofer channel) will not change for speakers that have been specified as <b>SMALL</b> in the configuration, or do not output these frequencies.</li> <li>• Calibration is performed, but due to your speakers' low frequency limitations, no measurable sound is output for display.</li> </ul>
Graphical output data seems to have disappeared.	<ul style="list-style-type: none"> <li>• If the power is switched off, the measurement data for graphical output to a PC is cleared.</li> </ul>

## Display

Symptom	Remedy
The display is dark or off.	<ul style="list-style-type: none"> <li>• Press <b>DIMMER</b> on the remote control repeatedly to select a different brightness.</li> </ul>
After making an adjustment the display goes off.	<ul style="list-style-type: none"> <li>• Press <b>DIMMER</b> on the remote control repeatedly to select a different brightness.</li> </ul>
You can't get <b>DIGITAL</b> to display when using the <b>SIGNAL SEL</b> button.	<ul style="list-style-type: none"> <li>• Check the digital connections and make sure that the digital inputs are assigned correctly (see <i>The Input Setup menu</i> on page 69).</li> <li>• If the multichannel analog inputs are selected, select a different input source.</li> </ul>
The Dolby/DTS indicator doesn't light when playing Dolby/DTS software.	<ul style="list-style-type: none"> <li>• These indicators do not light if playback is paused.</li> <li>• Check the playback (especially the digital output) settings of the source component.</li> </ul>
When playing a DVD-Audio disc, the DVD player display shows <b>96 kHz</b> . However, the receiver's display does not.	<ul style="list-style-type: none"> <li>• This is not a malfunction. 96 kHz audio from DVD-Audio discs is only output from the analog outputs of the DVD player. This receiver cannot show the playback sample rate when using the analog inputs.</li> </ul>
During playback of a DTS 96/24 source, the display doesn't show <b>96 kHz</b> .	<ul style="list-style-type: none"> <li>• Make sure that the receiver is set to <b>AUTO</b> or <b>DIGITAL</b> (see <i>Choosing the input signal</i> on page 33).</li> </ul>
When playing Dolby Digital or DTS sources, the receiver's format indicators do not light.	<ul style="list-style-type: none"> <li>• Check that the player is connected using a digital connection.</li> <li>• Make sure that the receiver is set to <b>AUTO</b> or <b>DIGITAL</b> (see <i>Choosing the input signal</i> on page 33).</li> <li>• Check that the player isn't set up so that Dolby Digital and DTS sources are converted to PCM.</li> <li>• Ensure that if there are several audio tracks on the disc, the Dolby Digital or DTS is selected.</li> </ul>

Symptom	Remedy
When playing certain discs, none of the receiver's format indicators light.	<ul style="list-style-type: none"> <li>The disc may not contain 5.1/6.1 channel material. Check the disc packaging for more on what audio tracks are recorded on the disc.</li> </ul>
When playing a disc with the listening mode set to Auto Surround, the <b>DD PL II</b> or <b>Neo:6</b> indicator lights on the receiver.	<ul style="list-style-type: none"> <li>Make sure that the receiver is set to <b>AUTO</b> or <b>DIGITAL</b> (see <i>Choosing the input signal</i> on page 33).</li> <li>If a two channel soundtrack is currently playing (including Dolby Surround encoded), then this is not a malfunction. Check the disc packaging for details about the audio tracks available.</li> </ul>
During playback of a Surround EX or DTS-ES source on the <b>SBch AUTO</b> setting, the <b>EX</b> and <b>ES</b> indicators don't light, or the signal is not properly processed.	<ul style="list-style-type: none"> <li>The source may be Dolby Surround EX/DTS-ES software, but it has no flag to indicate it is 6.1 compatible. Set to <b>SBch ON</b> (see <i>Using surround back channel processing</i> on page 34), then switch to the THX Surround EX or Standard EX listening mode (see <i>Listening in surround sound</i> on page 30).</li> </ul>
During playback of DVD-Audio, the display shows <b>PCM</b> .	<ul style="list-style-type: none"> <li>This will occur when playing DVD-Audio material over the HDMI connection. This is not a malfunction.</li> </ul>

## Remote control

Symptom	Remedy
Cannot be remote controlled.	<ul style="list-style-type: none"> <li>Try replacing the batteries in the remote control (see <i>Loading the batteries</i> on page 8).</li> <li>Be sure to operate within 7 m (23 feet) and a 30° angle of the remote sensor on the front panel (see <i>Operating range of remote control unit</i> on page 26).</li> <li>Check that there are no obstacles between the receiver and the remote control.</li> <li>Make sure that there is no fluorescent or other strong light shining on to the remote sensor.</li> <li>Check the connections of the <b>CONTROL IN</b> jack (see <i>Operating other Pioneer components with this receiver's sensor</i> on page 81).</li> </ul>
Other components can't be operated with the system remote.	<ul style="list-style-type: none"> <li>If the battery ran down, the preset codes may have been cleared. Re-enter the preset codes.</li> <li>The preset code may be incorrect. Redo the procedure for entering preset codes.</li> </ul>
The SR cable is connected, but the connected components can't be operated with the remote.	<ul style="list-style-type: none"> <li>Reinsert the SR cable, making sure it's connected to the right jack (see <i>Using this receiver with a Pioneer flat panel TV</i> on page 64).</li> <li>Make sure that there is an analog or HDMI connection between the units. This is necessary for the SR feature to work.</li> <li>Check that the other component is made by Pioneer. The SR feature only works with Pioneer equipment.</li> </ul>

## USB interface

Symptom	Remedy
USB mass storage device is not recognized by the receiver.	<ul style="list-style-type: none"> <li>Try switching the receiver off, then on again.</li> <li>Make sure you have completely inserted the USB connector to this receiver.</li> <li>Check that the memory format is FAT16 or FAT32 (FAT12, NTFS and HFS are not supported).</li> <li>USB devices with an internal USB hub are not supported.</li> </ul>
<b>USB ERROR3</b> shows in the display when connecting a USB device.	<ul style="list-style-type: none"> <li>If this message continues to appear after going through all the checks in <i>Important</i> on page 54 of <i>Connecting a USB device</i>, take the unit to your nearest Pioneer authorized service center or your dealer for servicing.</li> </ul>
Can't play audio files.	<ul style="list-style-type: none"> <li>The WMA or MPEG-4 AAC files were recorded using DRM (digital rights management), or the bit rate/sampling rate is not compatible (see <i>Compressed audio compatibility</i> on page 55). This is not a malfunction.</li> </ul>

## HDMI

Symptom	Remedy
The HDMI indicator blinks continuously.	<ul style="list-style-type: none"> <li>• Check all the points below.</li> </ul>
No picture or sound.	<ul style="list-style-type: none"> <li>• This receiver is HDCP-compatible. Check that the components you are connecting are also HDCP-compatible. If they are not, please connect them using the component, S-Video or composite video jacks.</li> <li>• Depending on the connected source component, it's possible that it will not work with this receiver (even if it is HDCP-compatible). In this case, connect using the component, S-Video or composite video jacks between source and receiver.</li> <li>• If the problem still persists when connecting your HDMI component directly to your monitor, please consult the component or monitor manual or contact the manufacturer for support.</li> <li>• If video images do not appear on your TV or flat panel TV, try adjusting the resolution, DeepColor or other setting for your component.</li> <li>• If '<b>NOT SUPPORT</b>' appears in the receiver's display, try adjusting the resolution, DeepColor or other setting for your component.</li> <li>• While analog video signals are being output over HDMI, use a separate connection for audio output.</li> <li>• When this receiver reproduces MULTI CH IN audio sources with the HDMI setting set to THROUGH, you cannot hear audio output from all channels. In this case, make a digital or analog audio connection.</li> <li>• To output signals in DeepColor, use an HDMI cable (high speed HDMI cable) to connect this receiver to a component or TV with the DeepColor feature.</li> </ul>
No picture.	<ul style="list-style-type: none"> <li>• Try changing the Resolution setting (in <i>Setting the Video options</i> on page 74).</li> </ul>
No sound, or sound suddenly ceases.	<ul style="list-style-type: none"> <li>• Check that the HDMI AV setting is set to <b>AMP/THROUGH</b>.</li> <li>• If the component is a DVI device, use a separate connection for the audio.</li> <li>• If analog video is being output over HDMI, please use a separate connection for the audio.</li> <li>• Check the audio output settings of the source component.</li> </ul>
Noisy or distorted picture.	<ul style="list-style-type: none"> <li>• Sometimes a video deck may output a noisy video signal (during scanning, for example), or the video quality may just be poor (with some video game units, for example). The picture quality may also depend on the settings, etc. of your display device. Switch off the video converter and reconnect the source and display device using the same type of connection (component, S-Video or composite), then start playback again.</li> <li>• If the problem still persists when connecting your HDMI component directly to your monitor, please consult the component or monitor manual or contact the manufacturer for support.</li> </ul>
<b>HDCP ERROR</b> shows in the display.	<ul style="list-style-type: none"> <li>• Check whether or not the connected component is compatible with HDCP. If it is not compatible with HDCP, reconnect the source device using a different type of connection (component, S-Video or composite). Some components that are compatible with HDCP still cause this message to be displayed, but so long as there is no problem with displaying video, this is not a malfunction.</li> </ul>



**Important information regarding the HDMI connection**

There are cases where you may not be able to route HDMI signals through this receiver (this depends on the HDMI-equipped component you are connecting—check with the manufacturer for HDMI compatibility information).

If you aren't receiving HDMI signals properly through this receiver (from your component), please try one of the following configurations when connecting up.

**Configuration A**

Use component video cables to connect the video output of your HDMI-equipped component to the receiver's component video input. The receiver can then convert the analog component video signal to a digital HDMI signal for transmission to the display. For this configuration, use the most convenient connection (digital is recommended) for sending audio to the receiver. See the operating instructions for more on audio connections.



**Note**

- The picture quality will change slightly during conversion.

**Configuration B**

Connect your HDMI-equipped component directly to the display using an HDMI cable. Then use the most convenient connection (digital is recommended) for sending audio to the receiver. See the operating instructions for more on audio connections. Set the display volume to minimum when using this configuration.



**Note**

- If your display only has one HDMI terminal, you can only receive HDMI video from the connected component.
- Depending on the component, audio output may be limited to the number of channels available from the connected display unit (for example audio output is reduced to 2 channels for a monitor with stereo audio limitations).
- If you want to switch the input source, you'll have to switch functions on both the receiver and your display unit.
- Since the sound is muted on the display when using the HDMI connection, you must adjust the volume on the display every time you switch input sources.

**XM radio messages**

Symptom	Cause	Action
<b>Check XM Tuner</b>	The XM Mini-Tuner is not installed or not fully seated in the XM Mini-Tuner Dock or the XM Mini-Tuner dock is not connected to this receiver.	Confirm the XM Mini-Tuner is fully seated in the dock and check the XM Mini-Tuner dock cable is connected to this receiver.
<b>Check Antenna</b>	The XM antenna is not connected to the XM Mini-Tuner Dock or the XM antenna cable is damaged.	Check that the XM antenna is securely connected to the XM Mini-Tuner Dock and check the antenna cable for damage. Replace the XM antenna if the cable is damaged.
<b>Loading</b>	The XM Mini-Tuner is acquiring audio or program information from the XM satellite signal. This message can also occur in weak XM signal conditions.  Note that this receiver may not respond to some buttons while this message is displayed.	This message should disappear in a few seconds in good signal conditions.  If you see this message often, reposition the XM antenna for better signal reception.  Use the Antenna Aiming option to optimize the antenna position.
<b>No Signal</b>	The XM Mini-Tuner is not receiving the XM satellite signal. Something may be blocking the XM antenna's view of the satellites or the antenna is not properly aimed.	Check for antenna obstructions and reposition the XM antenna to get better signal reception. Use the Antenna Aiming option to optimize the antenna position.  See instructions supplied with the XM Mini-Tuner and Dock for antenna installation information.
<b>Off Air</b>	You selected an XM channel that is not currently broadcasting.	Check back later; in the mean time, select another channel.
<b>CH Unauthorized</b>	You selected an XM channel that is blocked or cannot be receive with your XM subscription package.	Consult the latest channel guide at <a href="http://www.xmradio.com">www.xmradio.com</a> for the current list of channels. For information on receiving this channel, visit <a href="http://www.xmradio.com">www.xmradio.com</a> or contact XM Satellite Radio at 1-800-967-2346.

Symptom	Cause	Action
<b>CH Unavailable</b>	The selected channel is not available. The channel may have been reassigned to a different channel number. This message may occur initially with a new radio or a radio that has not received XM's signal for an extended period.	Consult the latest channel guide at <a href="http://www.xmradio.com">www.xmradio.com</a> for the current list of channels. For cases of a new radio or a radio that has not received XM's signal for an extended period, allow the radio to receive the XM satellite signal for at least 5 minutes and then try to select the channel again.
-----	No artist name or song title is available for this selection.	No action required.
<b>Upgrade XM Tuner</b>	The connected XM CNP-1000 is incompatible. This receiver features advanced technology that is designed for use with the XM Mini-Tuner.	Contact XM Listener Care (1-800-967-2346) and ask about upgrading your XM CNP-1000 to an XM Mini-Tuner.  Have this receiver's model name and CNP-1000 XM Radio ID number ready beforehand, and explain that this receiver is displaying the message <b>Upgrade XM Tuner</b> .  If you already have an XM Mini-Tuner connected and you see this message, turn off this receiver, make sure the XM Mini-Tuner is properly seated in the Mini-Tuner Dock, and then turn this receiver On again. If the message reappears, contact XM Listener Care and explain the issue that you're experiencing and the corrective actions you've tried.
<b>XM Power Error</b>	A short-circuit occurring in the antenna or surrounding antenna cable.	Make sure that there is nothing unusual with the antenna or antenna cable. Switch the power off, then back on again.

### SIRIUS radio messages

Symptom	Cause	Action
<b>Antenna Error</b>	Antenna is not properly connected.	Check that the antenna cable is attached securely.
<b>Check Sirius Tuner</b>	SIRIUS Connect tuner is not properly connected.	Check that the 8 pin mini DIN cable and AC Adapter are attached securely.
<b>Acquiring Signal</b>	The SIRIUS signal is too weak at the current location.	<i>n/a</i>
<b>Subscription Updating</b>	Unit is updating subscription.	Wait until the encryption code has been updated.
<b>Updating Channels</b>	Unit is updating channels.	Wait until the encryption code has been updated.
<b>Invalid Channel</b>	Selected channel is not available/does not exist.	Select another channel.



#### Note

- If the unit does not operate normally due to external effects such as static electricity disconnect the power plug from the outlet and insert again to return to normal operating conditions.

## Surround sound formats

Below is a brief description of the main surround sound formats you'll find on DVDs, satellite, cable and terrestrial broadcasts, and video cassettes.

### Dolby

The Dolby technologies are explained below. See [www.dolby.com](http://www.dolby.com) for more detailed information.



### Dolby Digital

Dolby Digital is a multichannel digital audio coding system widely used in cinemas, and in the home for DVD and digital broadcast soundtracks. It can deliver up to six discrete audio channels, comprising five full range channels and a special LFE (low frequency effects) channel used mainly for deep, rumbling sound effects; hence the term "5.1-channel" Dolby Digital.

In addition to the format features above, Dolby Digital decoders offer downmixing for compatibility with mono, stereo and Dolby Pro Logic audio from a number of bit rates and channels. Another feature, called Dialog Normalization, attenuates programs based on the average level of dialog in a program relative to its peak level (also known as Dialnorm) in order to achieve uniform playback level.

### Dolby Digital Surround EX

Dolby Digital Surround EX (the EX stands for EXtended) is an extension of Dolby Digital encoding whereby a surround back channel is matrixed into the surround left/right channels for 6.1 channel playback. This allows for compatibility with Dolby Digital 5.1 channel decoding, as well as for decoding using Dolby Digital EX.

### Dolby Pro Logic IIx and Dolby Surround

Dolby Pro Logic IIx is an improved version of the Dolby Pro Logic II (and Dolby Pro Logic) *decoding* system. Using the innovative "steering logic" circuit, this system extracts surround sound from sources as follows:

- **Dolby Pro Logic** – 4.1 channel sound (mono surround) from any stereo source
- **Dolby Pro Logic II** – 5.1 channel sound (stereo surround) from any stereo source
- **Dolby Pro Logic IIx** – 6.1 or 7.1 channel sound (stereo surround and surround back) from two channel or 5.1 (and 6.1) channel sources

*With two channel sources, the ".1" subwoofer channel is generated by bass management in the receiver.*

Dolby Surround is an *encoding* system which embeds surround sound information within a stereo soundtrack, which a Dolby Pro Logic decoder can then use for enhanced surround listening with greater sound detail.

### Dolby Digital Plus

Dolby Digital Plus is the next-generation audio technology for all high-definition programming and media. It combines the efficiency to meet future broadcast demands with the power and flexibility to realize the full audio potential expected in the upcoming high-definition era. Built on Dolby Digital, the multi-channel audio standard for DVD and HD broadcasts worldwide, Dolby Digital Plus was designed for the next-generation A/V receivers but remains fully compatible with all current A/V receivers.

Dolby Digital Plus delivers multi-channel audio programs of up to 7.1 channels (\*) and supports multiple programs in a single encoded bitstream with the maximum bit rate potential of up to 6 Mbps and the maximum bit rate performance of up to 3 Mbps on HD DVD and 1.7 Mbps on Blu-ray Disc, and it outputs Dolby Digital bitstreams for playback on existing Dolby Digital systems. Dolby Digital Plus can accurately reproduce the sound originally intended by directors and producers.

It also features multi-channel sound with discrete channel output, interactive mixing and streaming capability in advanced systems. Supported by High-Definition Media Interface (HDMI), a single-cable digital connection is possible for high-definition audio and video.

### Dolby TrueHD

Dolby TrueHD is the next-generation lossless encoding technology developed for high-definition optical discs in the upcoming era. Dolby TrueHD delivers tantalizing sound that is bit-for-bit identical to the studio master, unlocking the true high-definition entertainment experience on high-definition optical discs in the next generation. When coupled with high-definition video, Dolby TrueHD offers an unprecedented home theater experience with stunning sound and high-definition picture.

It supports bit rates of up to 18 Mbps and records up to 8 full-range channels (\*) individually with 24-bit/96 kHz audio. It also features extensive metadata including dialogue normalization and dynamic range control. Supported by High-Definition Media Interface (HDMI), a single-cable digital connection is possible for high-definition audio and video.

- \* HD DVD and Blu-ray Disc standards currently limit their maximum number of audio channels to eight, whereas Dolby Digital Plus and Dolby TrueHD support more than eight audio channels.

*Manufactured under license from Dolby Laboratories. "Dolby", "Pro Logic", "Surround EX" and the double-D symbol are trademarks of Dolby Laboratories.*

## DTS

The DTS technologies are explained below. See [www.dtstech.com](http://www.dtstech.com) for more detailed information.



### DTS Digital Surround

DTS Digital Surround is a 5.1-channel audio coding system from DTS Inc. now widely used for DVD-Video, DVD-Audio, 5.1 music discs, digital broadcasts, and video games. It can deliver up to six discrete audio channels, comprising five full range channels, including an LFE channel. Higher sound quality is achieved through the use of a low compression rate, and high rates of transmittance during playback.

### DTS-ES

DTS-ES (the ES stands for Extended Surround) is a decoder that is capable of decoding both DTS-ES Discrete 6.1 and DTS-ES Matrix 6.1 encoded sources. DTS-ES Discrete 6.1 gives 'true' 6.1 channel sound, with a completely separate (discrete) surround back channel. DTS-ES Matrix 6.1 has a surround back channel matrixed into the surround left/right channels. Both sources are also compatible with a conventional DTS 5.1 channel decoder.

### DTS Neo:6

DTS Neo:6 can generate 6.1 channel surround sound from any matrixed stereo source (such as video or TV) and from 5.1 channel sources. It uses both the channel information already encoded into the source, as well as its own processing to determine channel localization (with two channel sources, the ".1" subwoofer channel is generated by bass management in the receiver). Two modes (Cinema and Music) are available using DTS Neo:6 with two channel sources.

### DTS 96/24

DTS 96/24 is an extension of the original DTS Digital Surround which offers high quality 96 kHz/24-bit audio using a DTS 96/24 decoder. This format is also fully backward compatible with all existing decoders. This means that DVD players can play this software using a conventional DTS 5.1 channel decoder.

## DTS-EXPRESS

DTS-EXPRESS is a low-bitrate encoding technology supporting up to 5.1 channels with fixed data transfer rates. This format is incorporated with sub audio on HD DVD and secondary audio on Blu-ray Disc while boasting the potential applicability to upcoming broadcasts and memory audio contents.

## DTS-HD Master Audio

DTS-HD Master Audio is a technology that delivers master audio sources recorded in a professional studio to listeners without any loss of data, preserving audio quality. DTS-HD Master Audio adopts variable data transfer rates, facilitating data transfer to the maximum rate of 24.5 Mbps in the Blu-ray disc format, 18.0 Mbps in the HD-DVD format, which by far exceeds that of a standard DVD. These high data transfer rates enable lossless transmission of 96 kHz/24-bit 7.1-channel audio sources without deteriorating the quality of the original sound. DTS-HD Master Audio is an irreplaceable technology that can reproduce sound faithfully as intended by the creator of music or movies.

*Manufactured under license under U.S. Patent #'s: 5,451,942; 5,956,674; 5,974,380; 5,978,762; 6,226,616; 6,487,535 & other U.S. and worldwide patents issued & pending. DTS is a registered trademark and the DTS logos, Symbol, DTS-HD and DTS-HD Master Audio are trademarks of DTS, Inc. © 1996-2007 DTS, Inc. All Rights Reserved.*

## Windows Media Audio 9 Professional

Windows Media Audio 9 Professional (WMA9 Pro) is a discrete surround format developed by Microsoft Corporation.



WMA9 Pro can support up to 5.1/7.1 channel playback with sampling rates up to 24-bit/96 kHz. Using the unique WMA compression techniques, WMA9 Pro can deliver multichannel music and soundtracks over high-speed internet networks at low bit rates with minimal audio degradation. Playback may be enjoyed with the Windows Media™ Player 9 Series (or above) and other third-party media players on a personal computer, or with an AV amplifier with on-board WMA9 Pro decoding.

*Windows Media and the Windows logo are trademarks or registered trademarks of Microsoft Corporation in the United States and/or other countries.*

## About THX

The THX technologies are explained below. See [www.thx.com](http://www.thx.com) for more detailed information.



- **THX Cinema processing**

THX is an exclusive set of standards and technologies established by THX Ltd. THX grew from George Lucas' personal desire to make your experience of the film soundtrack, in both movie theatres and in your home theatre, as faithful as possible to what the director intended. Movie soundtracks are mixed in special movie theatres called dubbing stages and are designed to be played back in movie theatres with similar equipment and conditions. This same soundtrack is then transferred directly onto Laserdisc, VHS tape, DVD, etc., and is not changed for playback in a small home theatre environment. THX engineers developed patented technologies to accurately translate the sound from the movie theatre environment into the home, correcting the tonal and spatial errors that occur. On this product, when the THX indicator is on, THX features are automatically added in Cinema modes (e.g. THX Cinema, THX Surround EX).

- **Re-Equalization**

The tonal balance of a film soundtrack will be excessively bright and harsh when played back over audio equipment in the home because film soundtracks were designed to be played back in large movie theaters using very different professional equipment. Re-Equalization restores the correct tonal balance for watching a movie soundtrack in a small home environment.

- **Timbre Matching**

The human ear changes our perception of a sound depending on the direction from which the sound is coming. In a movie theatre, there is an array of surround speakers so that the surround information is all around you. In a home theatre, you use only two speakers located to the side of your head. The Timbre Matching feature filters the information going to the surround speakers so that they more closely match the tonal characteristics of the sound coming from the front speakers. This ensures seamless panning between the front and surround speakers.

- **Adaptive Decorrelation**

In a movie theatre, a large number of surround speakers help create an enveloping surround sound experience, but in a home theatre there are usually only two speakers. This can make the surround speakers sound like headphones that lack spaciousness and envelopment. The surround sounds will also collapse into the closest speaker as you move away from the middle seating position. Adaptive Decorrelation slightly changes one surround channel's time and phase relationship with respect to the other surround channel. This expands the listening position and creates—with only two speakers—the same spacious surround experience as in a movie theatre.

- **THX Select2 Plus**

Before any home theatre component can be THX Select2 Plus certified, it must incorporate all the features above and also pass a rigorous series of quality and performance tests. Only then can a product feature the THX Select2 Plus logo, which is your guarantee that the Home Theatre products you purchase will give you superb performance for many years to come. THX Select2 Plus requirements cover every aspect of the product including pre-amplifier and power

amplifier performance and operation, and hundreds of other parameters in both the digital and analog domain.

- **THX Surround EX**

THX Surround EX - Dolby Digital Surround EX is a joint development of Dolby Laboratories and the THX Ltd. In a movie theater, film soundtracks that have been encoded with Dolby Digital Surround EX technology are able to reproduce an extra channel which has been added during the mixing of the program. This channel, called Surround Back, places sounds behind the listener in addition to the currently available front left, front center, front right, surround right, surround left and subwoofer channels. This additional channel provides the opportunity for more detailed imaging behind the listener and brings more depth, spacious ambience and sound localization than ever before. Movies that were created using the Dolby Digital Surround EX technology, when released into the home consumer market may exhibit wording to that effect on the packaging. A list of movies created using this technology can be found on the Dolby web site at [www.dolby.com](http://www.dolby.com).

Only amplifier and controller products bearing the THX Surround EX logo, when in the THX Surround EX mode, faithfully reproduce this new technology in the home.

This product may also engage the "THX Surround EX" mode during the playback of 5.1 channel material that is not Dolby Digital Surround EX encoded. In such case the information delivered to the Surround Back channel will be program dependent and may or may not be very pleasing depending on the particular soundtrack and the tastes of the individual listener.

- **Advanced Speaker Array (ASA)**

ASA is a proprietary THX technology which processes the sound fed to 2 side and 2 back surround speakers to provide the optimal surround sound experience. When you set up your home theater system using all eight speaker outputs (Left, Center, Right, Surround Right, Surround Back Right, Surround Back Left, Surround Left and Subwoofer) placing the two Surround Back speakers close together facing the front of the room as shown in the diagram will provide the largest sweet spot. If for practical reasons you have to place the Surround Back speakers apart, you will need to go THX Audio Set-up screen and choose the setting that most closely corresponds to the speaker spacing, which will re-optimize the surround sound-field. ASA is used in three new modes; THX Select2 CINEMA, THX Select2 MUSIC and THX Select2 GAMES.

- **THX Music**

For the replay of multi-channel music the THX MusicMode should be selected. In this mode THX ASA processing is applied to the surround channels of all 5.1 encoded music sources such as DTS, Dolby Digital and DVD-Audio to provide a wide stable rear soundstage.

- **THX Games**

For the replay of stereo and multi-channel game audio the THX Games Mode should be selected. In this mode THX ASA processing is applied to the surround channels of all 5.1 and 2.0 encoded game sources such as analog, PCM, DTS and Dolby Digital. This accurately places all game audio surround information, providing a full 360 degree playback environment. THX Games Mode is unique as it gives you a smooth transition of audio in all points of the surround field.

- **THX Loudness Plus Description**

THX Loudness Plus is a new volume control technology featured in THX Ultra2 Plus™ and THX Select2 Plus™ Certified amplifiers. With THX Loudness Plus, home theater audiences can now experience the rich details in a surround mix at any volume level. A consequence of turning the volume below Reference Level is that certain sound elements can be lost or perceived differently by the listener. THX Loudness Plus compensates for the tonal and spatial shifts that occur when the volume is reduced by intelligently adjusting ambient surround channel levels and frequency response. This enables users to experience the true impact of soundtracks regardless of the volume setting. THX Loudness Plus is automatically applied when listening in any THX listening mode. The new THX Cinema, THX Music, and THX Games modes are tailored to apply the proper THX Loudness Plus settings for each type of content.

- **ASA Description**

ASA is a proprietary THX technology which processes the sound fed to 2 side and 2 back surround speakers to provide the optimal surround sound experience. When you set up your home theater system using all eight speaker outputs (Left, Center, Right, Surround Right, Surround Back Right, Surround Back Left, Surround Left and Subwoofer), be sure to go to the THX Audio Set-up screen and choose the setting that most closely corresponds to the speaker spacing, which will re-optimize the surround sound-field. ASA is used in three modes; THX Ultra2 Cinema, THX Ultra2 Music and THX Ultra2 Games.

- **THX Select2 Cinema**

THX Select2 Cinema mode plays 5.1 movies using all 8 speakers giving you the best possible movie watching experience. In this mode, ASA processing blends the side surround speakers and back surround speakers providing the optimal mix of ambient and directional surround sounds.

DTS-ES (Matrix and 6.1 Discrete) and Dolby Digital Surround EX encoded soundtracks will be automatically detected in Select2 Cinema mode if the appropriate flag has been encoded.

Some Dolby Digital Surround EX soundtracks are missing the digital flag that allows automatic switching. If you know that the movie that you are watching is encoded in Surround EX, you can manually select the THX Surround EX playback mode, otherwise THX Select2 Cinema mode will apply ASA processing to provide optimum replay.

- **THX Select2 Music**

For the playback of multi-channel music the THX Select2 Music mode should be selected. In this mode THX ASA processing is applied to the surround channels of all 5.1 encoded music sources such as DTS, Dolby Digital and DVD-Audio to provide a wide stable rear soundstage.

- **THX Select2 Games**

For the playback of stereo and multi-channel game audio the THX Select2 Games mode should be selected. In this mode THX ASA processing is applied to the surround channels of all 5.1 and 2.0 encoded game sources such as analog, PCM, DTS and Dolby Digital. This accurately places all game audio surround information, providing a full 360 degree playback environment. THX Select2 Games mode is unique as it gives you a smooth transition of audio in all points of the surround field.

*THX, the THX logo and Select2 Plus are trademarks of THX Ltd. which may be registered in some jurisdictions. All rights reserved. All other trademarks are the property of their respective owners.*

## About Neural – THX Surround



*Neural-THX® Surround is taking surround sound to the next level. This revolutionary new technology delivers the rich envelopment and discrete image detail of surround sound in a format that is fully compatible with stereo from various content sources. Neural-THX Surround enables 5.1, 6.1 and 7.1-channel support for gaming, movies and digital music. By unmasking the audio details, typically lost by other playback modes, audiences will experience the deep ambience and subtle details of movies, music and games.*

*Neural-THX® Digital Music™ is a new surround mode specifically designed to enhance the playback of compressed digital music content. It provides listeners with an expanded sound stage and clean surround experience, even with compressed audio sources such as MP3s and Internet streams.*

*Neural-THX Surround has been chosen as the official surround sound format for XM Satellite Radio's "XM HD Surround," TV sports broadcasting, 7.1 games, Music Direct Internet streaming as well as leading FM/HD radio stations worldwide. And with this technology being used by sound designers during content creation, as well as embedded into playback devices, Neural-THX Surround promises a listening experience that is true to the original mix.*

*For additional information, please visit [www.neuralsurround.com](http://www.neuralsurround.com). This product is manufactured under license from Neural Audio Corporation and THX Ltd. PIONEER hereby grants the user a non-exclusive, non-transferable, limited right of use to this product under USA and foreign patent, patent pending and other technology or trademarks owned by Neural Audio Corporation and THX Ltd. "Neural Surround", "Neural Audio", "Neural" and "NRL" are trademarks and logos owned by Neural Audio Corporation, THX is a trademark of THX Ltd., which may be registered in some jurisdictions. All rights reserved.*

**About XM**



**About XM Radio**

XM is North America's number one satellite radio company, offering an extraordinary variety of commercial-free music, plus the best in premier sports, news, talk radio, comedy, children's and entertainment programming, broadcast in superior digital audio quality coast to coast. For more information, or to subscribe, U.S. customers visit [xmradio.com](http://xmradio.com) or call XM Listener Care at 1-800-XMRADIO (1-800-967-2346); Canadian customers visit [xmradio.ca](http://xmradio.ca) or call XM Listener Care at 1-877-GETXMSR (1-877-438-9677).

**XM Ready® Legal**

XM monthly service subscription sold separately. XM Mini-Tuner and Home Dock required (each sold separately) to receive XM service. It is prohibited to copy, decompile, disassemble, reverse engineer, hack, manipulate or otherwise make available any technology or software incorporated in receivers compatible with the XM satellite Radio System. Installation costs and other fees and taxes, including a one-time activation fee may apply. All fees and programming subject to change. Channels with frequent explicit language are indicated with an XL. Channel blocking is available for XM radio receivers by calling 1-800-XMRADIO (U.S. residents) and 1-877-GETXMSR (Canadian residents). XM service only available in the 48 contiguous United States. ©2008 XM Satellite Radio Inc. All rights reserved.

**XM Ready® Subscription**

Once you have installed the XM Mini-Tuner Home Dock, inserted the XM Mini-Tuner, connected the XM Mini-Tuner Home Dock to your XM Ready® audio system, and installed the antenna, you are ready to subscribe and begin receiving XM programming. There are three places to find your eight character XM Radio ID: On the XM Mini-Tuner, on the XM Mini-Tuner package, and on XM Channel 0. Record the Radio ID below for reference.

--	--	--	--	--	--	--	--

**Note:** The XM Radio ID does not use the letters "I", "O", "S" or "F".

Activate your XM Satellite Radio service in the U.S. online at <http://activate.xmradio.com> or call 1-800-XMRADIO (1-800-967-2346). Activate your XM Satellite Radio service in Canada online at <https://activate.xmradio.ca> or call 1-877-GET-XMSR (1-877-438-9677). You will need a major credit card. XM will send a signal from the satellites to activate the full channel lineup. Activation normally takes 10-15 minutes, but during peak busy periods you may need to keep your XM Ready audio system on for up to an hour. When you can access the full lineup on your XM Ready audio system you are done. XM Ready® is a registered trademark of XM Satellite Radio Inc. The XM® name and related logo are registered trademarks of XM Satellite Radio Inc. All rights reserved.

**About SIRIUS**



SIRIUS and the Sirius READY logo are registered trademarks of SIRIUS Satellite Radio Inc.

## Listening modes with different input signal formats

The following charts outline the listening modes available with different input signal formats, depending on the surround back channel processing and decoding method you have selected.

### Stereo (2 channel) signal formats

SBch Processing	Input signal format	Standard	THX	Auto Surround
<b>SBch Processing ON/AUTO</b> (Automatically selects 6.1/7.1 channel decoding)	Dolby Digital Plus Dolby TrueHD (except for 176.4 kHz/ 192 kHz)	<input type="checkbox"/> Pro Logic IIx MOVIE <input type="checkbox"/> Pro Logic IIx MUSIC <input type="checkbox"/> Pro Logic IIx GAME <input type="checkbox"/> PRO LOGIC <sup>a</sup>	<input type="checkbox"/> Pro Logic IIx MOVIE+THX <input type="checkbox"/> PRO LOGIC+THX <sup>a</sup> THX Select2 GAMES <sup>b</sup> <input type="checkbox"/> Pro Logic IIx MUSIC+THX MUSIC <input type="checkbox"/> Pro Logic IIx GAME+THX GAMES	Stereo playback
	Dolby TrueHD (176.4 kHz/192 kHz)	<i>As above</i>	Stereo playback	<i>As above</i>
	DTS-HD Master Audio DTS-HD DTS-EXPRESS	Stereo playback	THX CINEMA THX MUSIC THX GAMES	<i>As above</i>
	Dolby Digital Surround	<input type="checkbox"/> Pro Logic IIx MOVIE <input type="checkbox"/> Pro Logic IIx MUSIC <input type="checkbox"/> Pro Logic IIx GAME <input type="checkbox"/> PRO LOGIC <sup>a</sup> Neo:6 CINEMA Neo:6 MUSIC	<input type="checkbox"/> Pro Logic IIx MOVIE+THX <input type="checkbox"/> Pro Logic IIx MUSIC+THX MUSIC <input type="checkbox"/> Pro Logic IIx GAME+THX GAMES Neo:6 CINEMA+THX THX Select2 GAMES <sup>b</sup> Neo:6 MUSIC+THX MUSIC <input type="checkbox"/> PRO LOGIC+THX CINEMA <sup>a</sup>	<input type="checkbox"/> Pro Logic IIx MOVIE
	DTS Surround	<i>As above</i>	<i>As above</i>	<b>Neo:6 CINEMA</b>
	SACD	<i>As above</i>	Neo:6 MUSIC+THX MUSIC <input type="checkbox"/> Pro Logic IIx MUSIC+THX MUSIC	Stereo playback
	XM Radio	<input type="checkbox"/> Pro Logic IIx MOVIE <input type="checkbox"/> Pro Logic IIx MUSIC <input type="checkbox"/> Pro Logic IIx GAME <input type="checkbox"/> PRO LOGIC Neo:6 CINEMA Neo:6 MUSIC XM HD Surround	<input type="checkbox"/> Pro Logic IIx MOVIE+THX <input type="checkbox"/> PRO LOGIC+THX <sup>a</sup> Neo:6 CINEMA+THX THX GAMES MODE <sup>b</sup>	<b>XM HD Surround</b>
	Other stereo sources	<input type="checkbox"/> Pro Logic IIx MOVIE <input type="checkbox"/> Pro Logic IIx MUSIC <input type="checkbox"/> Pro Logic IIx GAME <input type="checkbox"/> PRO LOGIC <sup>a</sup> Neo:6 CINEMA Neo:6 MUSIC Neural THX <sup>c</sup>	<input type="checkbox"/> Pro Logic IIx MOVIE+THX <input type="checkbox"/> Pro Logic IIx MUSIC+THX MUSIC <input type="checkbox"/> Pro Logic IIx GAME+THX GAMES Neo:6 CINEMA+THX THX Select2 GAMES <sup>b</sup> Neo:6 MUSIC+THX MUSIC <input type="checkbox"/> PRO LOGIC+THX CINEMA <sup>a</sup>	Stereo playback



SBch Processing	Input signal format	Standard	THX	Auto Surround
SBch Processing OFF <sup>d</sup>	Dolby Digital Plus Dolby TrueHD (except for 176.4 kHz/ 192 kHz)	<input checked="" type="checkbox"/> Pro Logic II MOVIE <input checked="" type="checkbox"/> Pro Logic II MUSIC <input checked="" type="checkbox"/> Pro Logic II GAME <input checked="" type="checkbox"/> PRO LOGIC	<input checked="" type="checkbox"/> PRO LOGIC+THX <input checked="" type="checkbox"/> Pro Logic II MOVIE+THX CINEMA <input checked="" type="checkbox"/> Pro Logic II MUSIC+THX MUSIC <input checked="" type="checkbox"/> Pro Logic II GAME+THX GAMES Neo:6 MUSIC+THX MUSIC Neo:6 CINEMA+THX	Stereo playback
	Dolby TrueHD (176.4 kHz/192 kHz)	<i>As above</i>	Stereo playback	<i>As above</i>
	DTS-HD Master Audio DTS-HD DTS-EXPRESS	Stereo playback	THX CINEMA THX MUSIC THX GAMES	<i>As above</i>
	Dolby Digital Surround	<input checked="" type="checkbox"/> Pro Logic II MOVIE <input checked="" type="checkbox"/> Pro Logic II MUSIC <input checked="" type="checkbox"/> Pro Logic II GAME <input checked="" type="checkbox"/> PRO LOGIC Neo:6 CINEMA Neo:6 MUSIC	<input checked="" type="checkbox"/> PRO LOGIC+THX <input checked="" type="checkbox"/> Pro Logic II MOVIE+THX CINEMA <input checked="" type="checkbox"/> Pro Logic II MUSIC+THX MUSIC <input checked="" type="checkbox"/> Pro Logic II GAME+THX GAMES Neo:6 MUSIC+THX MUSIC Neo:6 CINEMA+THX	<input checked="" type="checkbox"/> Pro Logic II MOVIE
	DTS Surround	<i>As above</i>	<i>As above</i>	Neo:6 CINEMA
	SACD	<i>As above</i>	Neo:6 MUSIC+THX MUSIC <input checked="" type="checkbox"/> PRO LOGIC II MUSIC+THX MUSIC	Stereo playback
	XM Radio	<input checked="" type="checkbox"/> Pro Logic II MOVIE <input checked="" type="checkbox"/> Pro Logic II MUSIC <input checked="" type="checkbox"/> Pro Logic II GAME <input checked="" type="checkbox"/> PRO LOGIC Neo:6 CINEMA Neo:6 MUSIC XM HD Surround	<input checked="" type="checkbox"/> Pro Logic II MOVIE+THX <input checked="" type="checkbox"/> PRO LOGIC+THX Neo:6 CINEMA+THX	XM HD Surround
	Other stereo sources	<input checked="" type="checkbox"/> Pro Logic II MOVIE <input checked="" type="checkbox"/> Pro Logic II MUSIC <input checked="" type="checkbox"/> Pro Logic II GAME <input checked="" type="checkbox"/> PRO LOGIC <sup>a</sup> Neo:6 CINEMA Neo:6 MUSIC Neural THX <sup>c</sup>	<input checked="" type="checkbox"/> Pro Logic II MOVIE+THX CINEMA Neo:6 MUSIC+THX MUSIC <input checked="" type="checkbox"/> Pro Logic II GAME+THX GAMES <input checked="" type="checkbox"/> Pro Logic II MUSIC+THX MUSIC Neo:6 CINEMA+THX <input checked="" type="checkbox"/> PRO LOGIC+THX	Stereo playback

a. No sound is output from the surround back speakers when  Pro Logic is selected.

b. Unavailable with only one surround back speaker connected.

c. This is only selectable when the input signal is an analog or PCM signal.

d. Automatically selected if no surround back speakers are connected.

## Multichannel signal formats

SBch Processing	Input signal format	Standard	THX	Auto Surround
<b>SBch Processing ON</b> (7.1 channel decoding used for all sources)	Dolby Digital Plus Dolby TrueHD DTS-HD DTS-HD Master Audio WMA9 Pro PCM (6.1/7.1 channel)	Straight decoding	<b>THX CINEMA</b> <b>THX MUSIC</b> <b>THX GAMES</b>	Straight decoding
	Dolby Digital Plus Dolby TrueHD (except for 176.4 kHz/192 kHz) (5.1 channel)	<b>Dolby Digital EX</b> <input type="checkbox"/> <b>Pro Logic IIx MOVIE<sup>a</sup></b> <input type="checkbox"/> <b>Pro Logic IIx MUSIC</b>	<b>THX SURROUND EX</b> <input type="checkbox"/> <b>Pro Logic IIx MOVIE+THX<sup>a</sup></b> <b>THX Select2 CINEMA<sup>a</sup></b> <b>THX Select2 MUSIC<sup>a</sup></b> <b>THX Select2 GAMES<sup>a</sup></b> <input type="checkbox"/> <b>Pro Logic IIx MUSIC+THX</b> <input type="checkbox"/> <b>EX+THX GAMES<sup>b</sup></b>	<b>Dolby Digital EX</b> <input type="checkbox"/> <b>Pro Logic IIx MOVIE<sup>a</sup></b>
	Dolby TrueHD (176.4 kHz/192 kHz) (5.1 channel)	<i>As above</i>	Straight decoding	<i>As above</i>
	DTS-EXPRESS DTS-HD DTS-HD Master Audio (5.1 channel)	Straight decoding	<b>THX CINEMA<sup>b</sup></b> <b>THX Select2 CINEMA<sup>a</sup></b> <b>THX Select2 MUSIC<sup>a</sup></b> <b>THX Select2 GAMES<sup>a</sup></b> <b>THX MUSIC<sup>b</sup></b> <b>THX GAMES<sup>b</sup></b>	Straight decoding
	Dolby Digital EX (6.1 channel flagged)	<b>Dolby Digital EX</b> <input type="checkbox"/> <b>Pro Logic IIx MOVIE<sup>a</sup></b> <input type="checkbox"/> <b>Pro Logic IIx MUSIC</b>	<b>THX SURROUND EX</b> <input type="checkbox"/> <b>Pro Logic IIx MOVIE+THX<sup>a</sup></b> <b>THX Select2 CINEMA<sup>a</sup></b> <b>THX Select2 MUSIC<sup>a</sup></b> <b>THX Select2 GAMES<sup>a</sup></b> <input type="checkbox"/> <b>Pro Logic IIx MUSIC+THX</b> <input type="checkbox"/> <b>EX+THX GAMES<sup>b</sup></b>	<b>Dolby Digital EX</b> <input type="checkbox"/> <b>Pro Logic IIx MOVIE<sup>a</sup></b>

<b>SBch Processing</b>	<b>Input signal format</b>	<b>Standard</b>	<b>THX</b>	<b>Auto Surround</b>
<b>SBch Processing ON</b> (7.1 channel decoding used for all sources)	DTS-ES (6.1 channel sources/ 6.1 channel flagged)	<b>DTS-ES</b> (Matrix/Discrete) <b>DTS+ <input type="checkbox"/> <input type="checkbox"/> Pro Logic IIx MOVIE<sup>a</sup></b> <b>DTS+ <input type="checkbox"/> <input type="checkbox"/> Pro Logic IIx MUSIC</b>	<b>DTS-ES Matrix+THX CINEMA</b> <b>DTS-ES Discrete+THX CINEMA</b> <b>DTS+ <input type="checkbox"/> <input type="checkbox"/> Pro Logic IIx MOVIE+THX<sup>a</sup></b> <b>THX Select2 CINEMA<sup>a</sup></b> <b>THX Select2 MUSIC<sup>a</sup></b> <b>THX Select2 GAMES<sup>a</sup></b> <b>DTS-ES Matrix+THX MUSIC<sup>b</sup></b> <b>DTS-ES Matrix+THX GAMES<sup>b</sup></b> <b>DTS-ES Discrete+THX MUSIC<sup>b</sup></b> <b>DTS-ES Discrete+THX GAMES<sup>b</sup></b>	<b>DTS-ES</b> (Matrix/Discrete)
	DTS and DTS 96/24 (5.1 channel encoding)	<b>DTS+Neo:6</b> <b>DTS+ <input type="checkbox"/> <input type="checkbox"/> Pro Logic IIx MOVIE<sup>a</sup></b> <b>DTS+ <input type="checkbox"/> <input type="checkbox"/> Pro Logic IIx MUSIC</b>	<b>DTS+Neo:6+THX CINEMA</b> <b>DTS+ <input type="checkbox"/> <input type="checkbox"/> Pro Logic IIx MOVIE+THX<sup>a</sup></b> <b>THX Select2 CINEMA<sup>a</sup></b> <b>THX Select2 MUSIC<sup>a</sup></b> <b>THX Select2 GAMES<sup>a</sup></b> <b>DTS+Neo:6+THX MUSIC<sup>b</sup></b> <b>DTS+Neo:6+THX GAMES<sup>b</sup></b> <b><input type="checkbox"/> Pro Logic IIx MUSIC+THX<sup>a</sup></b>	<b>DTS+Neo:6</b>
	Dolby Digital WMA9 Pro PCM (5.1 channel encoding)	<b>Dolby Digital EX</b> <b><input type="checkbox"/> <input type="checkbox"/> Pro Logic IIx MOVIE<sup>a</sup></b> <b><input type="checkbox"/> <input type="checkbox"/> Pro Logic IIx MUSIC</b>	<b>THX SURROUND EX</b> <b><input type="checkbox"/> <input type="checkbox"/> Pro Logic IIx MOVIE+THX<sup>a</sup></b> <b>THX Select2 CINEMA<sup>a</sup></b> <b>THX Select2 MUSIC<sup>a</sup></b> <b>THX Select2 GAMES<sup>a</sup></b> <b><input type="checkbox"/> <input type="checkbox"/> Pro Logic IIx MUSIC+THX<sup>a</sup></b> <b><input type="checkbox"/> <input type="checkbox"/> EX+THX GAMES<sup>b</sup></b>	<b>Dolby Digital EX</b> <b><input type="checkbox"/> <input type="checkbox"/> Pro Logic IIx MOVIE<sup>a</sup></b>
	SACD (5.1 channel encoding)	<i>As above</i>	<b>THX Select2 MUSIC</b> <b><input type="checkbox"/> <input type="checkbox"/> Pro Logic IIx MUSIC+THX MUSIC</b>	<i>As above</i>

SBch Processing	Input signal format	Standard	THX	Auto Surround
<b>SBch Processing AUTO</b> (Automatically selects 6.1/7.1 channel decoding)	Dolby Digital Plus Dolby TrueHD DTS-HD DTS-HD Master Audio WMA9 Pro PCM (6.1/7.1 channel)	Straight decoding	<b>THX CINEMA</b>	Straight decoding
	Dolby TrueHD (176.4 kHz/192 kHz) (5.1 channel)	<i>As above</i>	Straight decoding	<i>As above</i>
	Dolby Digital EX (6.1 channel flagged)	<b>Dolby Digital EX</b> <b>Pro Logic IIx MOVIE<sup>a</sup></b>	<b>THX SURROUND EX</b>	<b>Dolby Digital EX</b> <b>Pro Logic IIx MOVIE<sup>a</sup></b>
	DTS-ES (6.1 channel sources/6.1 channel flagged)	<b>DTS-ES</b> (Matrix/Discrete)	<b>DTS-ES + THX</b> (Matrix/Discrete)	<b>DTS-ES</b> (Matrix/Discrete)
	Other 5.1 channel sources (5.1 channel encoding)	Straight decoding	<b>THX Select2 CINEMA<sup>a</sup></b> <b>THX CINEMA<sup>b</sup></b>	Straight decoding
	SACD (5.1 channel encoding)	<i>As above</i>	<b>THX Select2 MUSIC<sup>a</sup></b> <b>THX MUSIC<sup>b</sup></b>	<i>As above</i>
<b>SBch Processing OFF<sup>c</sup></b>	SACD (5.1 channel)	Straight decoding	<b>THX MUSIC</b>	Straight decoding
	Other 5.1/6.1/7.1 channel sources	<i>As above</i>	<b>THX CINEMA</b> <b>THX MUSIC</b> <b>THX GAMES</b>	<i>As above</i>

a. Unavailable with only one surround back speaker connected.

b. This can be selected when only one surround speaker is connected.

c. Automatically selected if no surround back speakers are connected.

## Stream direct with different input signal formats

The following charts show what you will hear with different input signal formats, depending on the Stream Direct mode (see *Using Stream Direct* on page 33) you have selected.

### Stereo (2 channel) signal formats

Surround Back speaker(s)	Input signal format	DIRECT	PURE DIRECT
<b>Connected</b>	Dolby Digital Surround	<b>ⓧ Pro Logic IIx MOVIE</b>	<b>ⓧ Pro Logic IIx MOVIE</b>
	DTS Surround	<b>Neo:6 CINEMA</b>	<b>Neo:6 CINEMA</b>
	Other stereo sources	Stereo playback	Stereo playback
	Analog sources	<i>As above</i>	ANALOG DIRECT (stereo)
<b>Not connected</b>	Dolby Digital Surround	<b>ⓧ Pro Logic IIx MOVIE</b>	<b>ⓧ Pro Logic IIx MOVIE</b>
	DTS Surround	<b>Neo:6 CINEMA</b>	<b>Neo:6 CINEMA</b>
	Other stereo sources	Stereo playback	Stereo playback
	Analog sources	<i>As above</i>	ANALOG DIRECT (stereo)

### Multichannel signal formats

Surround Back speaker(s)	Input signal format	DIRECT	PURE DIRECT
<b>Connected</b>	Dolby Digital EX (6.1 channel flagged)	<b>Dolby Digital EX</b> <b>ⓧ Pro Logic IIx MOVIE<sup>a</sup></b>	<b>Dolby Digital EX</b> <b>ⓧ Pro Logic IIx MOVIE<sup>a</sup></b>
	DTS-ES (6.1 channel sources/6.1 channel flagged)	<b>DTS-ES (Matrix/Discrete)</b>	<b>DTS-ES (Matrix/Discrete)</b>
	Other 5.1/6.1/7.1 channel sources	Straight decoding	Straight decoding
<b>Not connected</b>	All 5.1/6.1/7.1 channel sources	Straight decoding	Straight decoding

a. Unavailable with only one surround back speaker connected.

## Specifications

### Amplifier section

**Continuous average power output of 110 watts\* per channel, min., at 8 ohms, from 20 Hz to 20 000 Hz with no more than 0.09 %\*\* total harmonic distortion (front).**

Continuous Power Output (20 Hz to 20 kHz, 8 $\Omega$ , 0.09 %)	
Front.....	110 W + 110 W
Center.....	110 W
Surround.....	110 W + 110 W
Surround back.....	110 W + 110 W

Continuous Power Output (1 kHz, 6 $\Omega$ , 1.0 %)	
Front.....	150 W + 150 W
Center.....	150 W
Surround.....	150 W + 150 W
Surround back.....	150 W + 150 W

Total harmonic distortion.....	0.09 % (20 Hz to 20 kHz, 110 W, 8 $\Omega$ )
--------------------------------	-------------------------------------------------

\* Measured pursuant to the Federal Trade Commission's Trade Regulation rule on Power Output Claims for Amplifiers  
\*\* Measured by Audio Spectrum Analyzer

### Audio Section

Input (Sensitivity/Impedance)	
LINE.....	335 mV/47 k $\Omega$
Frequency Response (LINE).....	5 Hz to 100 000 Hz $\pm 3$ dB
Output (Level/Impedance)	
REC.....	335 mV/2.2 k $\Omega$
Tone Control	
BASS.....	$\pm 6$ dB (100 Hz)
TREBLE.....	$\pm 6$ dB (10 kHz)
LOUDNESS.....	+4 dB/+2 dB (100 Hz/10 kHz) (at volume position -40 dB)
Signal-to-Noise Ratio (IHF, short circuited, A network)	
LINE.....	103 dB
Signal-to-Noise Ratio [EIA, at 1 W (1 kHz)]	
LINE.....	83 dB

### Composite Video/S-Video Section

Input (Sensitivity/Impedance).....	1 Vp-p/75 $\Omega$
Output (Level/Impedance).....	1 Vp-p/75 $\Omega$
Signal-to-Noise Ratio.....	65 dB
Frequency Response.....	5 Hz to 10 MHz

### Component Video Section

Input (Sensitivity/Impedance).....	1 Vp-p/75 $\Omega$
Output (Level/Impedance).....	1 Vp-p/75 $\Omega$
Signal-to-Noise Ratio.....	65 dB
Frequency Response.....	5 Hz to 100 MHz

### HDMI Section

Input.....	19-pin x 3
Output.....	19-pin (5 V, 100 mA)

### FM Tuner Section

Frequency Range.....	87.5 MHz to 108 MHz
Usable Sensitivity.....	Mono: 13.2 dBf, IHF (1.3 $\mu$ V/75 $\Omega$ )
50 dB Quieting Sensitivity.....	Mono: 20.2 dBf Stereo: 38.6 dBf
Signal-to-Noise Ratio.....	Mono: 73 dB (at 85 dBf) Stereo: 70 dB (at 85 dBf)
Distortion.....	Stereo: 0.5 % (1 kHz)
Alternate Channel Selectivity.....	60 dB (400 kHz)
Stereo Separation.....	40 dB (1 kHz)
Frequency Response.....	30 Hz to 15 kHz $\pm 1$ dB
Antenna Input.....	75 $\Omega$ unbalanced

### AM Tuner Section

Frequency Range.....	530 kHz to 1 700 kHz
Sensitivity (IHF, Loop antenna).....	350 $\mu$ V/m
Selectivity.....	25 dB
Signal-to-Noise Ratio.....	50 dB
Antenna.....	Loop antenna

### Miscellaneous

Power Requirements.....	AC 120 V, 60 Hz
Power Consumption.....	390 W
In standby.....	0.6 W (HDMI Control OFF) 0.75 W (HDMI Control ON)
Dimensions.....	420 (W) mm x 173 (H) mm x 433 (D) mm (16 <sup>9</sup> / <sub>16</sub> (W) in. x 6 <sup>13</sup> / <sub>16</sub> (H) in. x 17 <sup>1</sup> / <sub>16</sub> (D) in.)
Weight (without package).....	13.3 kg (29 lbs 6 oz)

### Furnished Parts

Setup microphone (for Auto MCACC setup).....	1
AA/IEC R6P dry cell batteries.....	2
Remote control unit.....	1
AM loop antenna.....	1
FM wire antenna.....	1
Warranty card.....	1
These operating instructions	



### Note

- Specifications and the design are subject to possible modifications without notice, due to improvements.

## Cleaning the unit

- Use a polishing cloth or dry cloth to wipe off dust and dirt.
- When the surface is dirty, wipe with a soft cloth dipped in some neutral cleanser diluted five or six times with water, and wrung out well, and then wipe again with a dry cloth. Do not use furniture wax or cleansers.
- Never use thinners, benzene, insecticide sprays or other chemicals on or near this unit, since these will corrode the surface.



*Dear Customer:*

Selecting fine audio equipment such as the unit you've just purchased is only the start of your musical enjoyment. Now it's time to consider how you can maximize the fun and excitement your equipment offers. This manufacturer and the Electronic Industries Association's Consumer Electronics Group want you to get the most out of your equipment by playing it at a safe level. One that lets the sound come through loud and clear without annoying blaring or distortion-and, most importantly, without affecting your sensitive hearing.

Sound can be deceiving. Over time your hearing "comfort level" adapts to higher volumes of sound. So what sounds "normal" can actually be loud and harmful to your hearing. Guard against this by setting your equipment at a safe level BEFORE your hearing adapts.

**To establish a safe level:**

- Start your volume control at a low setting.
- Slowly increase the sound until you can hear it comfortably and clearly, and without distortion.

**Once you have established a comfortable sound level:**

- Set the dial and leave it there.

Taking a minute to do this now will help to prevent hearing damage or loss in the future. After all, we want you listening for a lifetime.

**We Want You Listening For A Lifetime**

Used wisely, your new sound equipment will provide a lifetime of fun and enjoyment. Since hearing damage from loud noise is often undetectable until it is too late, this manufacturer and the Electronic Industries Association's Consumer Electronics Group recommend you avoid prolonged exposure to excessive noise. This list of sound levels is included for your protection.

**Decibel Level Example**

30	Quiet library, soft whispers
40	Living room, refrigerator, bedroom away from traffic
50	Light traffic, normal conversation, quiet office
60	Air conditioner at 20 feet, sewing machine
70	Vacuum cleaner, hair dryer, noisy restaurant
80	Average city traffic, garbage disposals, alarm clock at two feet.

**THE FOLLOWING NOISES CAN BE DANGEROUS UNDER CONSTANT EXPOSURE**

90	Subway, motorcycle, truck traffic, lawn mower
100	Garbage truck, chain saw, pneumatic drill
120	Rock band concert in front of speakers, thunderclap
140	Gunshot blast, jet plane
180	Rocket launching pad

Information courtesy of the Deafness Research Foundation.



5001\_En

Should this product require service in the U.S.A. and you wish to locate the nearest Pioneer Authorized Independent Service Company, or if you wish to purchase replacement parts, operating instructions, service manuals, or accessories, please call the number shown below.

1-800-421-1404

Please do not ship your product to Pioneer without first calling the Customer Support at the above listed number for assistance.

Pioneer Electronics Service, Inc.  
P.O. BOX 1760, Long Beach,  
CA 90801-1760, U.S.A.

For warranty information please see the Limited Warranty sheet included with your product.

Should this product require service in Canada, please contact a Pioneer Canadian Authorized Dealer to locate the nearest Pioneer Authorized Service Company in Canada. Alternatively, please contact the Customer Satisfaction Department at the following address:

Pioneer Electronics of Canada, Inc.  
Customer Satisfaction Department  
300 Allstate Parkway, Markham, Ontario L3R 0P2  
1-877-283-5901  
905-479-4411

For warranty information please see the Limited Warranty sheet included with your product.

Si ce produit doit être réparé au Canada, veuillez vous adresser à un distributeur autorisé Pioneer du Canada pour obtenir le nom du Centre de Service Autorisé Pioneer le plus près de chez-vous. Vous pouvez aussi contacter le Service à la clientèle de Pioneer:

Pioneer Électroniques du Canada, Inc.  
Service Clientèle  
300, Allstate Parkway, Markham, Ontario L3R 0P2  
1-877-283-5901  
905-479-4411

Pour obtenir des renseignements sur la garantie, veuillez vous reporter au feuillet sur la garantie restreinte qui accompagne le produit.

S018\_C\_EF

Register Your Product on

<http://www.pioneerelectronics.com> (US)

<http://www.pioneerelectronics.ca> (Canada)

## PIONEER CORPORATION

4-1, Meguro 1-Chome, Meguro-ku, Tokyo 153-8654, Japan

### PIONEER ELECTRONICS (USA) INC.

P.O. BOX 1540, Long Beach, California 90801-1540, U.S.A. TEL: (800) 421-1404

### PIONEER ELECTRONICS OF CANADA, INC.

300 Allstate Parkway, Markham, Ontario L3R 0P2, Canada TEL: 1-877-283-5901, 905-479-4411

### PIONEER EUROPE NV

Haven 1087, Keetberglaan 1, B-9120 Melsele, Belgium TEL: 03/570.05.11

### PIONEER ELECTRONICS ASIACENTRE PTE. LTD.

253 Alexandra Road, #04-01, Singapore 159936 TEL: 65-6472-7555

### PIONEER ELECTRONICS AUSTRALIA PTY. LTD.

178-184 Boundary Road, Braeside, Victoria 3195, Australia, TEL: (03) 9586-6300

### PIONEER ELECTRONICS DE MEXICO S.A. DE C.V.

Blvd.Manuel Avila Camacho 138 10 piso Col.Lomas de Chapultepec, Mexico,D.F. 11000 TEL: 55-9178-4270

K002\_B\_En

PIONEER, ELITE, SOUND.VISION.SOUL, and the Pioneer, Elite and sound.vision.soul logos are trademarks of Pioneer Corporation.

Published by Pioneer Corporation.  
Copyright © 2008 Pioneer Corporation.  
All rights reserved.



## Free Manuals Download Website

<http://myh66.com>

<http://usermanuals.us>

<http://www.somanuals.com>

<http://www.4manuals.cc>

<http://www.manual-lib.com>

<http://www.404manual.com>

<http://www.luxmanual.com>

<http://aubethermostatmanual.com>

Golf course search by state

<http://golfingnear.com>

Email search by domain

<http://emailbydomain.com>

Auto manuals search

<http://auto.somanuals.com>

TV manuals search

<http://tv.somanuals.com>