

Pioneer

**AUDIO/VIDEO
MULTI-CHANNEL RECEIVER**

VSX-409RDS

Operating Instructions

Congratulations on buying this fine Pioneer product.

Please read through these operating instructions so you will know how to operate your model properly. After you have finished reading the instructions, put them away in a safe place for future reference.

In some countries or regions, the shape of the power plug and power outlet may sometimes differ from that shown in the explanatory drawings. However the method of connecting and operating the unit is the same.

THE POWER SWITCH IS SECONDARY CONNECTED AND THEREFORE DOES NOT SEPARATE THE UNIT FROM MAINS POWER IN STANDBY POSITION.

WARNING: TO PREVENT FIRE OR SHOCK HAZARD, DO NOT EXPOSE THIS APPLIANCE TO RAIN OR MOISTURE.

VENTILATION

- When installing this unit, make sure to leave space around the unit for ventilation to improve heat radiation (at least 20 cm at top, 15 cm at rear, and 15 cm at each side). If not enough space is provided between the unit and walls or other equipment, heat will build up inside, interfering with performance or causing malfunctions.
- Do not place on a thick carpet, bed, sofa, or fabric having a thick pile. Do not cover with fabric or covering.

Anything that blocks ventilation will cause internal temperature to rise, which may lead to breakdown or fire hazard.

This product complies with the Low Voltage Directive (73/23/EEC), EMC Directives (89/336/EEC, 92/31/EEC) and CE Marking Directive (93/68/EEC).

IMPORTANT



The lightning flash with arrowhead symbol, within an equilateral triangle, is intended to alert the user to the presence of uninsulated "dangerous voltage" within the product's enclosure that may be of sufficient magnitude to constitute a risk of electric shock to persons.

CAUTION

RISK OF ELECTRIC SHOCK
DO NOT OPEN

CAUTION:

TO PREVENT THE RISK OF ELECTRIC SHOCK, DO NOT REMOVE COVER (OR BACK). NO USER-SERVICEABLE PARTS INSIDE. REFER SERVICING TO QUALIFIED SERVICE PERSONNEL.



The exclamation point within an equilateral triangle is intended to alert the user to the presence of important operating and maintenance (servicing) instructions in the literature accompanying the appliance.

IMPORTANT

FOR USE IN THE UNITED KINGDOM

The wires in this mains lead are coloured in accordance with the following code:

Blue : neutral
Brown : live

If the plug provided is unsuitable for your socket outlets, the plug must be cut off and a suitable plug fitted.

The cut-off plug should be disposed of and must not be inserted into any 13 amp socket as this can result in electric shock. The plug or adaptor of the distribution panel should be provided with a 5 amp fuse. As the colours of the wires in the mains lead of this appliance may not correspond with coloured markings identifying the terminals in your plug, proceed as follows:

The wire which is coloured blue must be connected to the terminal which is marked with the letter N or coloured black.

The wire which is coloured brown must be connected to the terminal which is marked with the letter L or coloured red.

Do not connect either wire to the earth terminal of a three-pin plug.

NOTE

After replacing or changing a fuse, the fuse cover in the plug must be replaced with a fuse cover which corresponds to the colour of the insert in the base of the plug or the word that is embossed on the base of the plug, and the appliance must not be used without a fuse cover. If lost, replacement fuse covers can be obtained from your dealer.

Only 5 A fuses approved by B.S.I. or A.S.T.A. to B.S. 1362 should be used.

Information to User

Alteration or modifications carried out without appropriate authorization may invalidate the user's right to operate the equipment.

Introductory Information	5
Checking the Supplied Accessories	5
Using this Manual	5
Preparing the Remote Control	6
<hr/>	
Connecting Your System	7
Connecting Antennas	7
Connecting Audio Components	8
Connecting DVD 5.1 Channel Components	9
Connecting Video Components	10
Connecting Speakers	11
<hr/>	
Setting Up for Surround Sound	13
Setting Up for Surround Sound	13
<hr/>	
Displays & Controls	17
Front Panel	17
Display	18
Remote Control	19
<hr/>	
Listening in Surround Sound	20
Listening in Dolby Pro Logic Mode	20
Listening in DVD 5.1 Channel Input Mode	21
Listening in DSP Mode	22
<hr/>	
Using the Tuner	23
Finding a Station	23
Tuning Directly to a Station	24
Memorizing Stations	25
Naming Memorized Stations	26
Recalling Memorized Stations	27
An Introduction to RDS & EON	28
Searching for RDS Programmes	30
Using EON Search	31
<hr/>	
Making a Recording	32
Making an Audio Recording	32
Making a Video Recording	33
<hr/>	
Controlling the Rest of Your System	34
CD/MD/CD-R Player Controls	34
Cassette Deck Controls	35
DVD Player Controls	36
TV Controls	37
<hr/>	
Additional Information	38
Troubleshooting	38
Specifications	40

Features

Five channels of independent amplification

Five independent power amplifiers, each rated at 80W, ensure accurate, dynamic reproduction of all multi-channel material.

Dolby* Pro Logic

Enjoy stunning multi-channel, surround sound effects from movies and other material recorded in Dolby Surround/Pro Logic. Enhance your listening experience further with built-in signal processing that recreates the movie theater ambience in your living room.

Digital surround effects

Using Digital Signal Processing (DSP) technology, various listening environments, such as a theater or a jazz club, may be simulated and applied to any music or video source.

Convenient RDS/EON radio tuning

Use the fast and convenient RDS system to immediately find the type of radio programme you want to listen to. This program identification system could also be extremely useful in locating helpful broadcasts in emergencies or adverse weather conditions.

DVD 5.1 channel input

A special 5.1 Channel input makes the VSX-409RDS fully compatible with Dolby Digital decoders and DVD players with 5.1 channel outputs.

The Energy-saving Design

This unit is designed to use minimal electricity when power is switched OFF (in Standby mode). Regarding the value of the power consumption in standby mode, refer to "Specifications" on pages 40.

** Manufactured under license from Dolby Laboratories. "Dolby", "Pro Logic" and double-D symbol are trademarks of Dolby Laboratories. Confidential unpublished works. © 1992-1997 Dolby Laboratories. All rights reserved.*

Checking the Supplied Accessories

Please check that you've received the following supplied accessories:

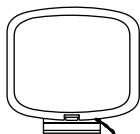

AM loop antenna

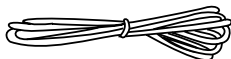

FM wire antenna

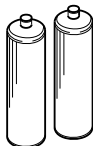

'AA' size IEC R6P
batteries (x2)

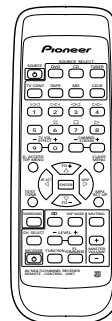

Remote control unit

Using this Manual

This manual is for the VSX-409RDS audio/video multi-channel receiver. It is divided into two main sections:

Set up

This section covers installing your receiver and connecting up all the other components in your home theater system to it. It also describes how to set up a multi-channel speaker system to take full advantage of the great surround sound features of your receiver.

Operation

This section shows you how to use every feature of the receiver and its remote control unit. It also covers using the supplied remote control to operate your other Pioneer home theater components. To find out more about a specific button, control or indicator, see Displays & Controls starting on page 17. This will point you to the relevant chapter in the manual.

In the Additional Information section (p.38-40) you'll find a troubleshooting section and specifications.

The following symbols are used throughout this manual:



Provides detailed precautions and advice on operations, etc.



Indicates that display is blinking.

Preparing the Remote Control

Loading the batteries

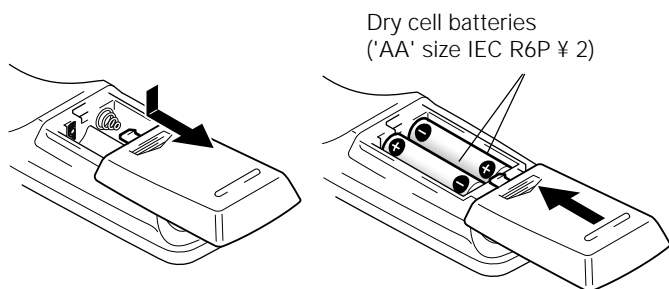

CAUTION!

Incorrect use of batteries may result in such hazards as leakage and bursting. Observe the following precautions:

- Never use new and old batteries together.
- Insert the plus and minus sides of the batteries properly according to the marks in the battery case.
- Batteries with the same shape may have different voltages. Do not use different batteries together.

Operating range of remote control unit



The remote control may not work properly if:

- There are obstacles between the remote control and the receiver's remote sensor.
- Direct sunlight or fluorescent light is shining onto the remote sensor.
- The receiver is located near a device that is emitting infrared rays.
- The receiver is operated simultaneously with another infrared remote control unit.

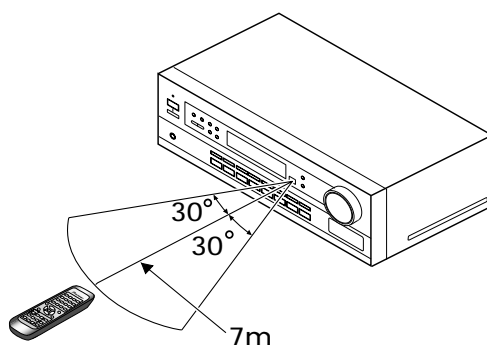

Special note on the remote control

Please note that the remote control has two types of buttons, one called FUNCTION and a set of buttons called SOURCE SELECT. Use the FUNCTION button to choose the component you want to listen to (CD, CDR/TAPE, TUNER, etc.) and use the SOURCE SELECT buttons to change which component the remote control itself will operate. Thus, if the VSX-409RDS is in TUNER mode, for example, and you want to listen to your CD player, you need to select the CD mode with the FUNCTION button.

Operating other Pioneer components

By connecting a control cord (optional), you can control other Pioneer equipment using this remote control unit. Point the remote control unit towards the remote sensor of this unit, even when operating other equipment.

The remote control signals are received by the remote sensor of this unit, and sent to the other devices via the **CONTROL OUT** terminal.

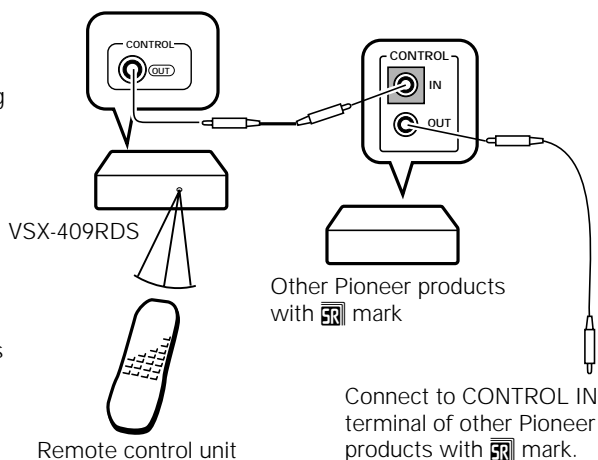

You can also control Pioneer components by pointing the receiver's remote control directly at the component. This type of operation does not require control cords.

Connecting Your System

Before making or changing the connections, switch off the power switch and disconnect the power cord from the AC outlet.

Connecting Antennas

Connect the AM loop antenna and the FM wire antenna as shown below. To improve reception and sound quality, connect external antennas (see Using external antennas, below). Always make sure that the receiver is switched off and unplugged from the wall outlet before making or changing any connections.

AM loop antenna

Assemble the antenna and connect to the receiver. Attach to a wall, etc. (if desired) and face in the direction that gives the best reception.

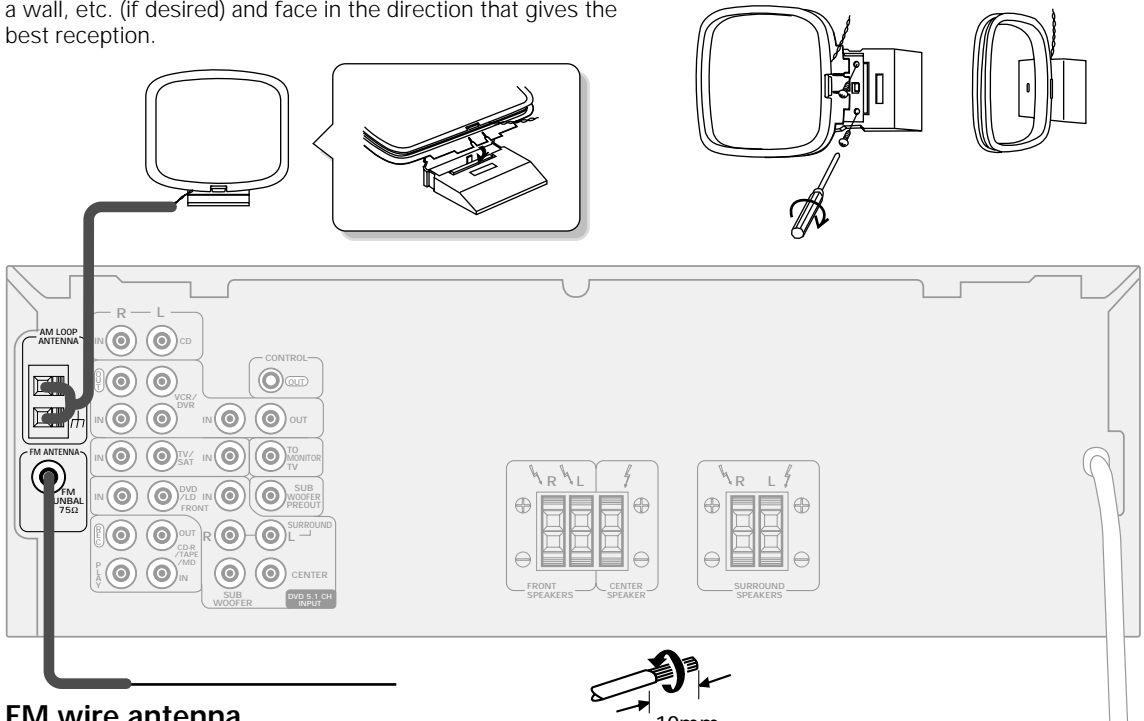

FM wire antenna

Connect the FM wire antenna and fully extend vertically along a window frame, etc.

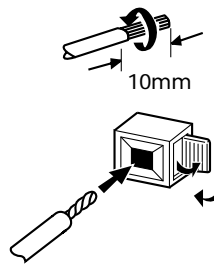

Antenna snap connectors

Twist the exposed wire strands together and insert into the hole, then snap the connector shut.

Using external antennas

■ To improve FM reception

Connect an external FM antenna.

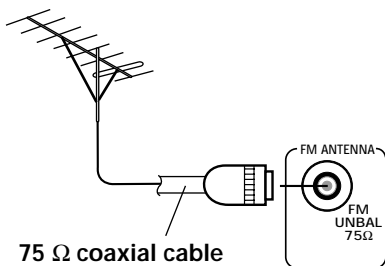

■ To improve AM reception

Connect a 5–6 meter length of vinyl-coated wire to the AM antenna terminal without disconnecting the supplied AM loop antenna. For the best possible reception, suspend horizontally outdoors.

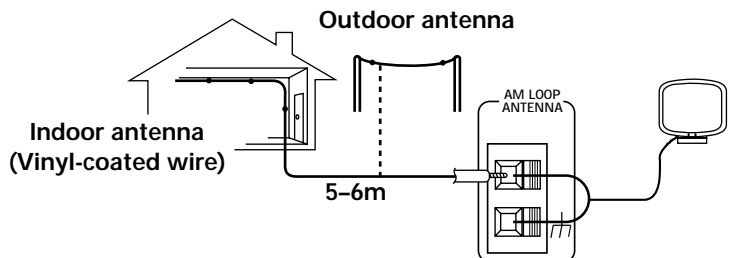

Connecting Audio Components

Connect your audio components as shown below. When connecting equipment, always make sure the power switched off and the power cord is disconnected from the wall outlet.

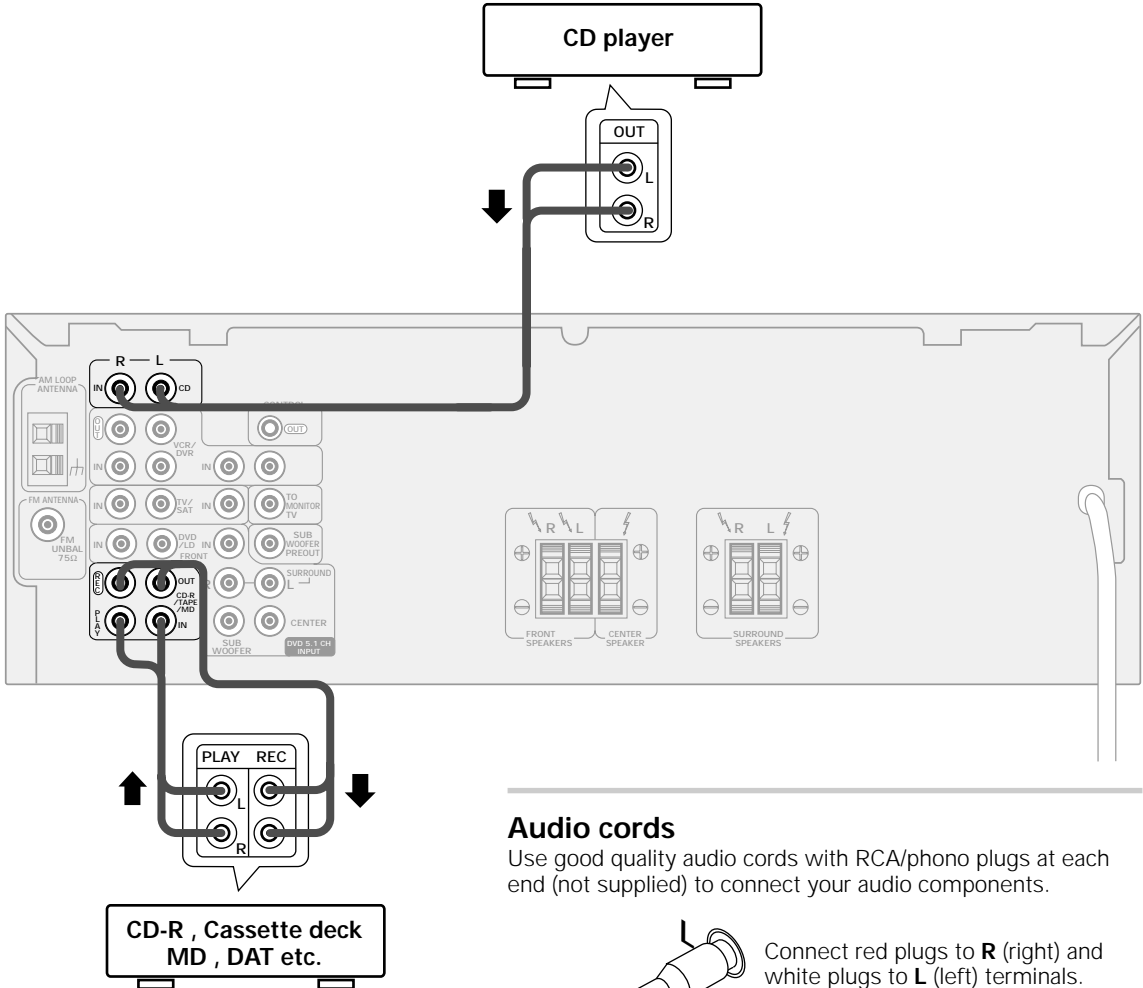

Audio cords

Use good quality audio cords with RCA/phono plugs at each end (not supplied) to connect your audio components.

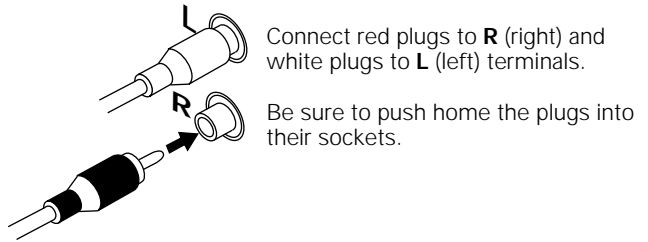

Cassette deck placement

Depending on where the cassette deck is placed, noise caused by leakage flux from the transformer in the receiver may occur during playback. If you experience noise, move the cassette deck farther away from the receiver.

Connecting DVD 5.1 Channel Components

DVD and LD discs are often compatible with both 2 channel and 5.1 channel audio output formats. Refer to page 21 for more information on how to switch between the two input methods.

Connections can be made from a DVD player, multi channel decoder equipped with 5.1 analogue outputs to the 5.1 analogue inputs on this unit. When connecting equipment, always make sure the power switched off and the power cord is disconnected from the wall outlet. When connecting equipment, always make sure the power switched off and the power cord is disconnected from the wall outlet.

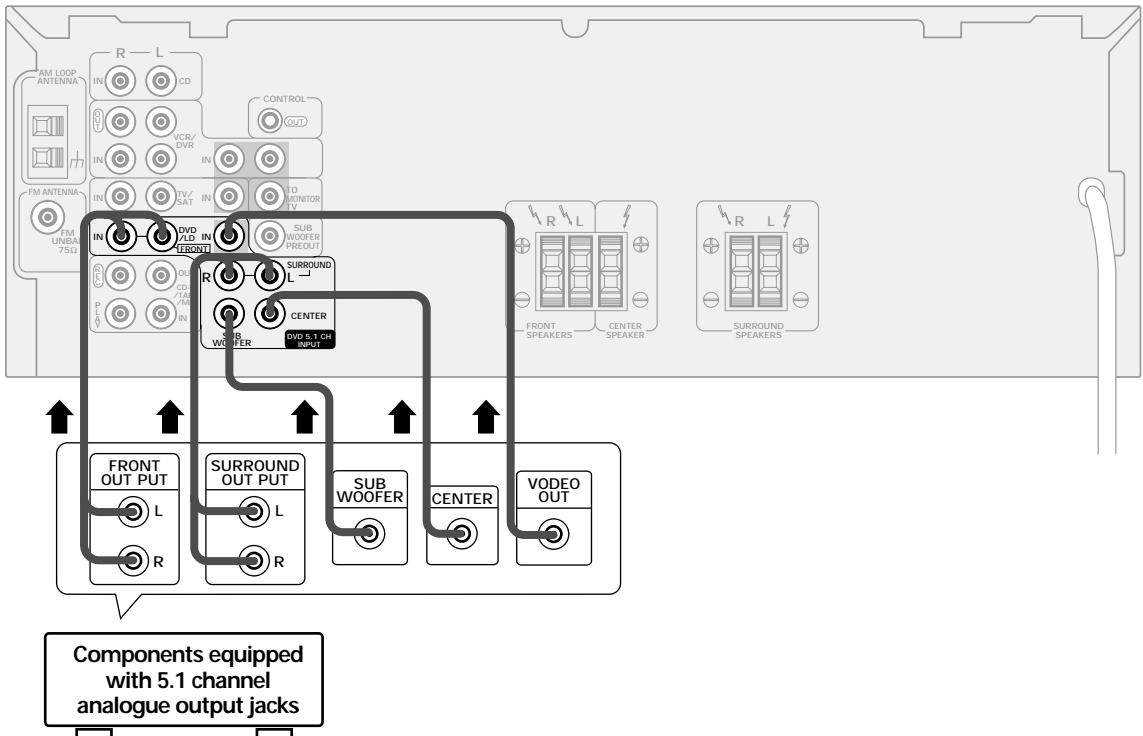

The 5.1 channel input can only be used when DVD 5.1 CH is selected.

Connecting Video Components

Connect your video components as shown below. When connecting equipment, make sure the power is switched off and the power cord disconnected from the wall outlet.

Audio/Video cords

Use good quality audio/video cords with RCA/phono plugs at each end (not supplied) to connect the video components and a video cord to connect the monitor/TV.

Connect red plugs to R (right), white plugs to L (left), and the yellow plugs to VIDEO.

Be sure to push home the plugs into their sockets.

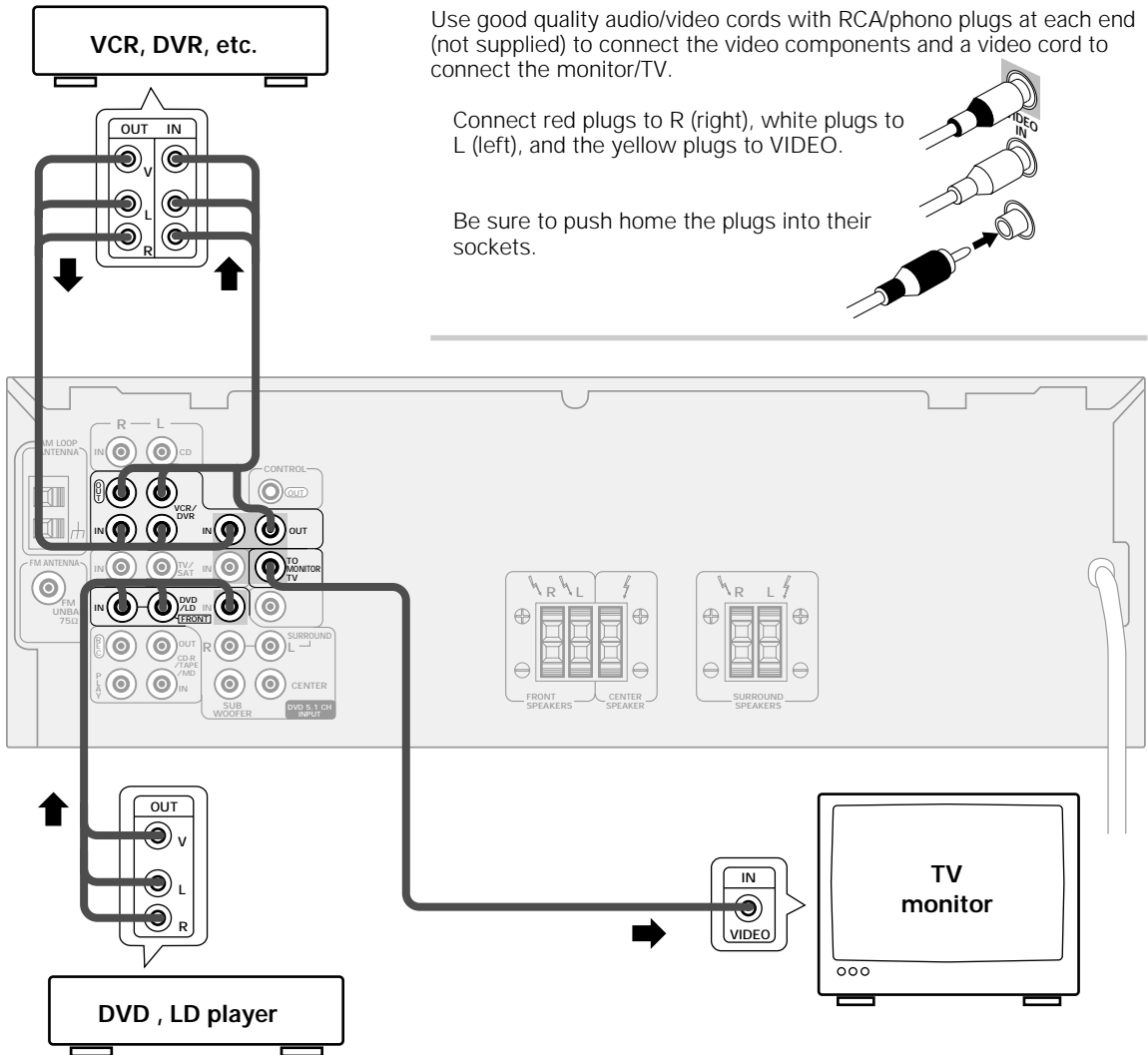
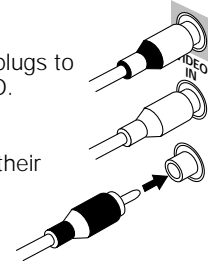

Connecting Speakers

Connect your speakers as shown below. Be sure to connect each speaker to the appropriate speaker terminals, and also to connect the positive and negative terminals correctly (positive to positive, negative to negative). When connecting equipment, always make sure the power switched off and the power cord is disconnected from the wall outlet.

- Use speakers with a nominal impedance of 8 Ω to 16 Ω.

When connecting equipment, always make sure the power switched off and the power cord is disconnected from the wall outlet.

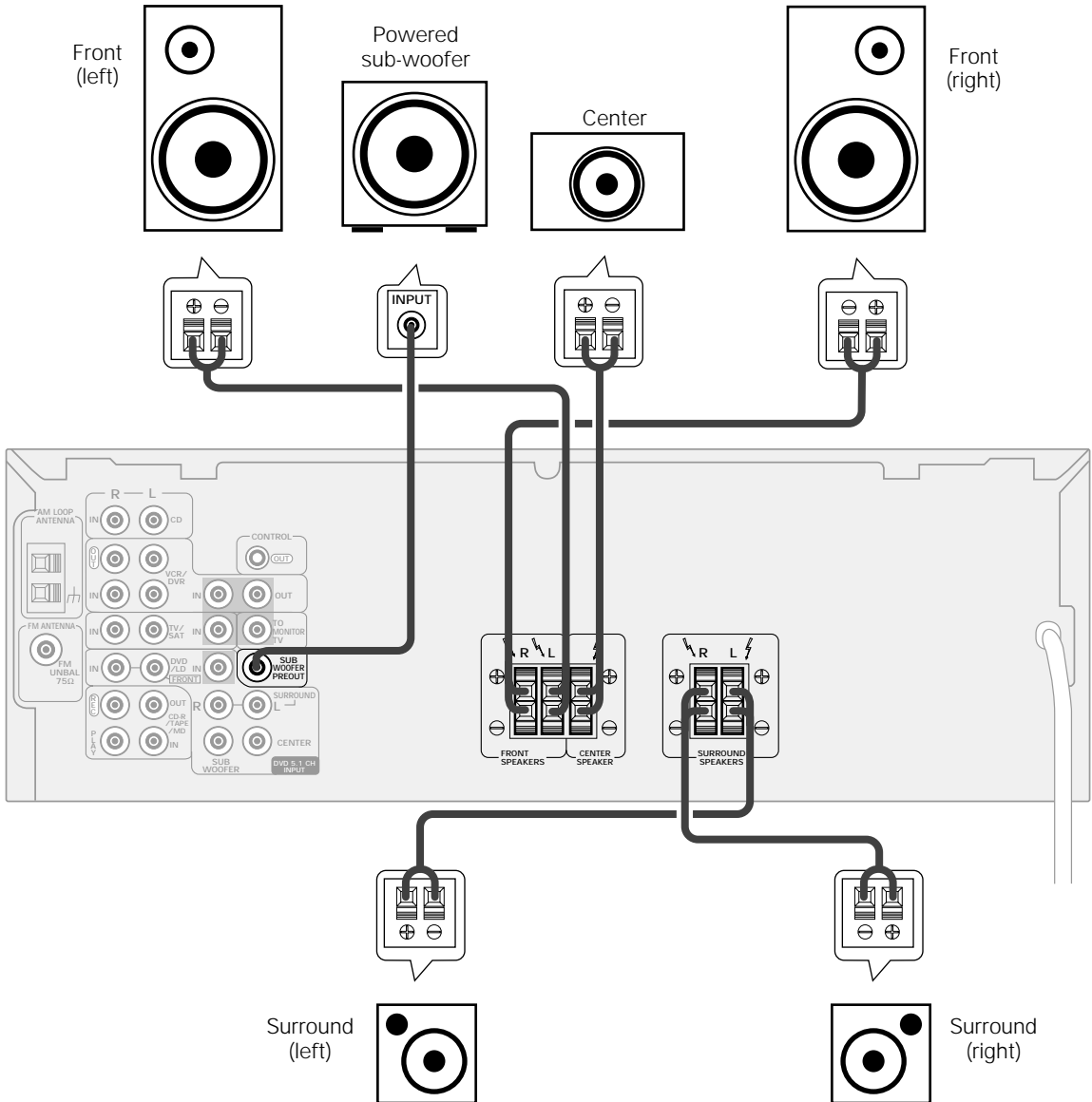

Speaker terminals

Use good quality speaker wire to connect the speakers to the receiver.

- ① Twist around 10 mm of bare wire strands together.
- ② Unclip the speaker terminal and insert the wire.
- ③ Snap shut the speaker terminal to secure.

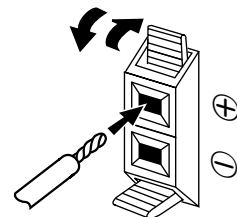

Hints on speaker placement

Speakers are usually designed with a particular placement in mind. Some are designed to be floorstanding, while others should be placed on stands to sound their best. Some should be placed near a wall; others should be placed away from walls. Follow the guidelines on placement that the speaker manufacturer provided with your particular speakers to get the most out of them.

- Place the front left and right speakers at equal distances from the TV.
- When placing speakers near the TV, we recommend using magnetically shielded speakers to prevent possible interference, such as discoloration of the picture when the TV is switched on. If you do not have magnetically shielded speakers and notice discoloration of the TV picture, move the speakers farther away from the TV.
- Install the center speaker above or below the TV so that the sound of the center channel is localized at the TV screen.

CAUTION!

If you choose to install the center speaker on top of the TV, be sure to secure it with putty, or by other suitable means, to reduce the risk of damage or injury resulting from the speaker falling from the TV in the event of external shocks such as earthquakes.

- If possible, install the surround speakers slightly above ear level.
- Try not to install the surround speakers farther away from the listening position than the front and center speakers. Doing so can weaken the surround sound effect.

To achieve the best possible surround sound, install your speakers as shown below. Be sure all speakers are installed securely to prevent accidents and improve sound quality.

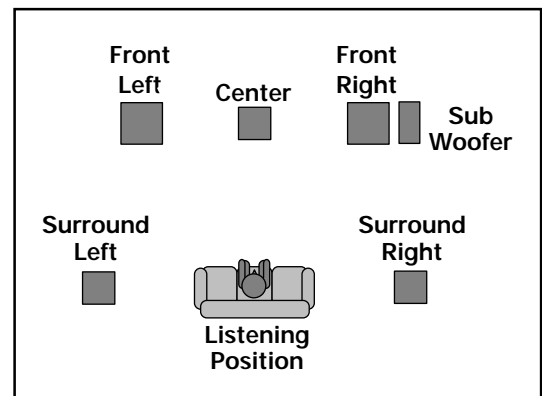

3-D View of speaker set up

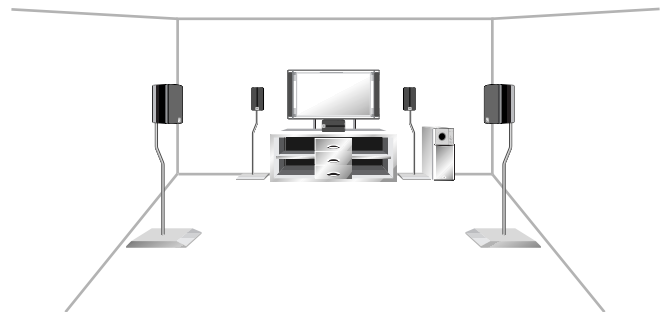

Setting Up for Surround Sound

Setting Up for Surround Sound

The VSX-409RDS offers several options for surround sound listening, depending on the speakers in your set up. Having installed the speakers in your room it's important to set up the relative volume levels and speaker distances in order to make the most of the receiver's surround sound capabilities. You only need to make these settings once, unless you change the placement of your current speaker system or add new speakers, etc.

Setting the center mode, the subwoofer and speaker distances

It is important to set the type of center mode which corresponds to your speaker system, set the subwoofer on/off and set speaker distances as well as set volume levels of each speaker. From your normal listening position, the volumes of the various speakers in your system should appear to be equal. Follow the steps below to do all of these things, especially adjust the volumes of the center and surround speakers relative to the main front speakers for Dolby Pro Logic mode, 5.1 CH. mode and the DSP mode.

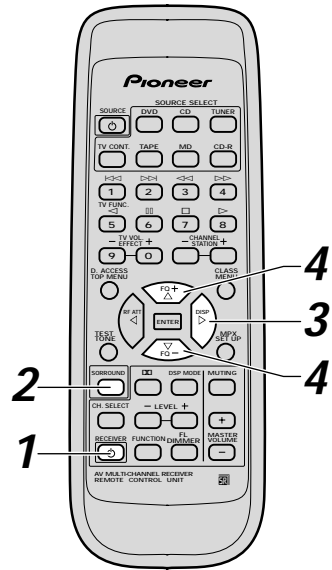

1 Switch on the receiver.

The STANDBY indicator goes out.

2 Press the SURROUND button.

3 Press the ► button to select the surround sound setup mode.

Repeatedly pressing the button cycles through the three setup modes (center mode setup; subwoofer setup; distance setup). The mode appears in the display on the front panel.

4 Use the ▲▼ buttons to select one of the four types of center mode.

See the center mode cycle shown here and the diagrams below explaining each center mode to decide which center mode to choose

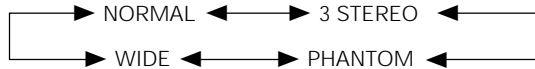

Normal

Middle and high frequency sounds are heard from the center speaker.
Bass frequencies from the center channel are played through the front speakers.

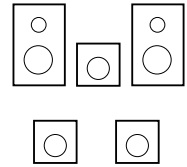

3 Stereo

Surround channel sounds and center channel bass frequencies are heard through the front stereo speakers.

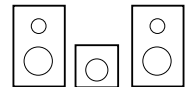

Phantom

Center channel sounds are played through both front speakers equally.

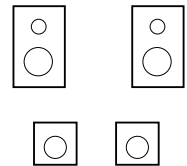

Wide

If a full range speaker is used for the center channel, all center channel sound, including bass frequencies, are heard through the center speaker.

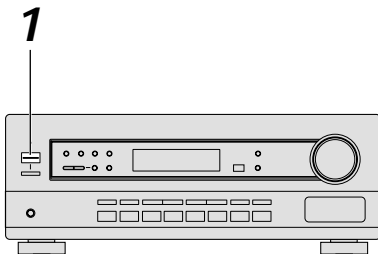
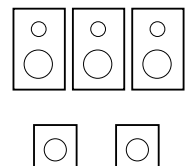

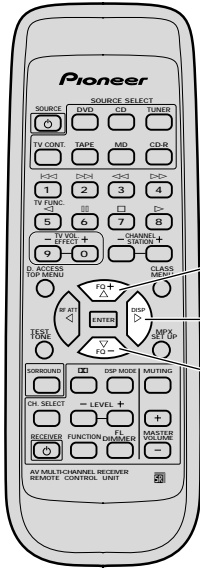

5 Press the ► button to select the SUBWF (subwoofer) select mode.

6 Use the ▲▼ buttons to turn the subwoofer function on or off.

Select SUBWF ON if you have a subwoofer and SUBWF OFF if you don't have a subwoofer.

7 Press the ► button to select the distance mode for the FRNT (front) speakers.

For true surround sound effect the sound from the front speakers and the surround speakers should arrive to the listener's ears at a slightly different time. Telling the receiver how far your front and surround speakers are from your listening position will allow the receiver to do this correctly for you. The first distance setting you'll see will be FRNT for your front speakers. You can set the distance in a range from 0.3-9 metres.

8 Press the ▲▼ buttons to increase/decrease the distance of the FRNT speakers.

You need to judge how far the speakers are from your normal listening position and set the distance accordingly. You can set the distance in a range from 0.3-9 metres.

9 Press the ► button to select the distance mode for the SURR (surround) speakers.

10 Press the ▲▼ buttons to increase/decrease the distance of the SURR speakers.

Again, You need to judge how far the speakers are from your normal listening position and set the distance accordingly. As above, you can set the distance in a range from 0.3-9 metres.

When you are finished setting up the distance the receiver will return to normal operating mode after about 20 seconds. Alternatively, you can cycle through the setup mode options with the 2, 3 buttons until you return to the regular operating mode.



You only need to do the distance settings if your system has surround speakers.

Setting up speaker levels for Dolby Pro Logic

In order to get the best surround sound you need to set up the relative speaker levels so that they all have the same volume from your normal listening position. Follow the steps below using the TEST TONE to do this.

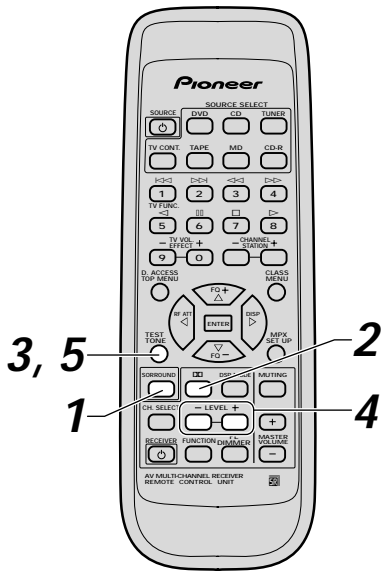

1 Press the SURROUND button.

2 Press the TEST TONE button.

3 Press the TEST TONE button.

A short test tone will be heard from each speaker in your set up in turn. No test tone is heard from the sub woofer, however.

4 Adjust the respective speaker levels with the LEVEL +/- buttons when the TEST TONE sounds from that speaker.

Adjust the volumes of the speakers so that the volume of all speakers appears equal from your normal listening position.

5 Press TEST TONE again.

When you are satisfied that the set up is complete, press the TEST TONE button to return to normal operation.



- No TEST TONE sounds for the subwoofer
- These speaker level settings are applicable to PRO LOGIC, PRO LOGIC THEATER 1 & PRO LOGIC THEATER 2 settings.

Setting up speaker levels for DVD 5.1 CH

1 Use the FUNCTION button to select DVD 5.1 CH input mode.

2 Play a DVD 5.1 CH source and set volume.

3 Press the CH. SELECT button.

The first speaker, FL (front left), and its relative volume level (+/-**dB) appears in the display.

4 Adjust the front left (FL) speaker level with the LEVEL +/- buttons.

Adjust the volumes of the speakers to a standard level of your choice when seated in your normal listening position.

5 Press CH. SELECT again to move to the next speaker.

The second speaker CT (center) and it's relative volume level (+/-**dB) appears in the display.

6 Adjust the center (CT) speaker level with the LEVEL +/- buttons.

Adjust the speaker volume so it seems the same as the previous speaker from your normal listening position.

7 Repeat steps 3 & 4 for all of your speakers.

Adjust the volumes of the all speakers so their volume seems the same from your normal listening position.

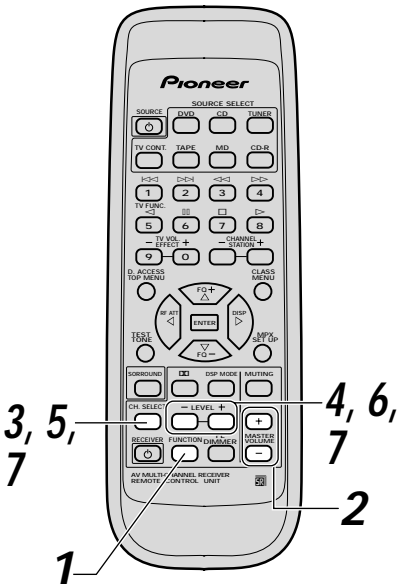

Setting up speaker levels for DSP

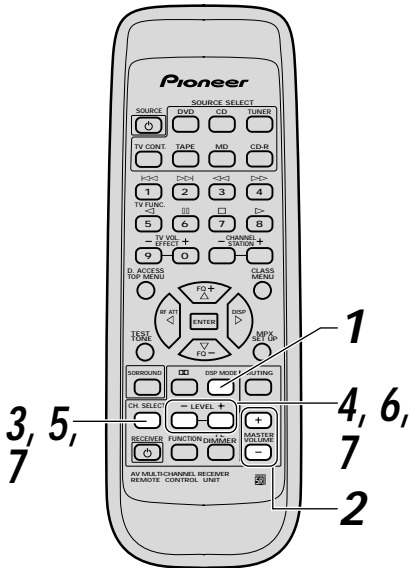

1 Use the DSP MODE button to turn on a DSP effect. You can cycle through the five different types with the DSP button.

2 Play a source (CD, tape, etc.) and set master volume to a moderate level.

3 Press the CH. SELECT button.

The first speaker FL (front left) and its relative volume level (+/- **dB) appears in the display.

4 Adjust the front left (FL) speaker level with the LEVEL +/- buttons.

Adjust the volumes of the speakers to a standard level of your choice when seated in your normal listening position.

5 Press CH. SELECT again to move to the next speaker.

The second speaker CT (center) and its relative volume level (+/- **dB) appears in the display.

6 Adjust the center (CT) speaker level with the LEVEL +/- buttons.

Adjust the volume of the speaker so its volume seems the same as the previous speaker from your normal listening position.

7 Repeat steps 3 & 4 for all of your speakers.

Adjust the volumes of the all speakers so their volume seems the same from your normal listening position.



- These speaker level settings are applicable to DSP effects only.
- Each effect level applies only to the DSP type (HALL for example) that it is set in. You can set the effect levels for each type independently.

Front Panel

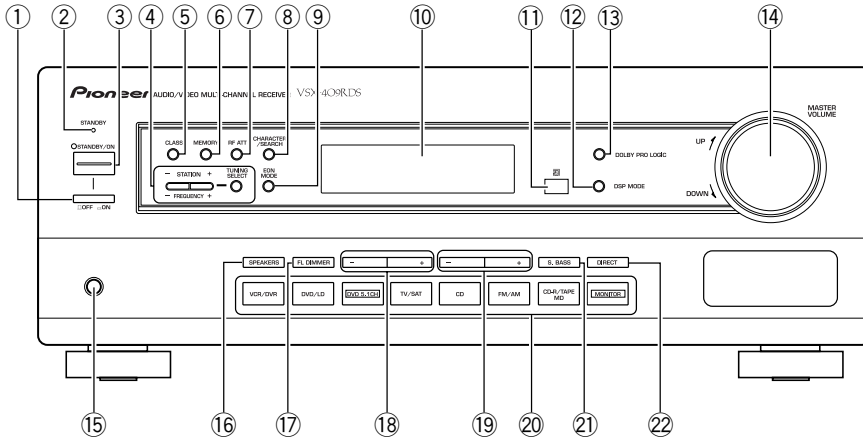

- ① **MAIN POWER button**
Push to send electricity to the receiver. Note the STANDBY/ON button below actually turns the receiver on and standby.
- ② **STANDBY indicator**
Lights when the receiver is in standby mode (note that the receiver consumes a small amount of power (1W) in standby mode).
- ③ **STANDBY/ON button**
Switches the receiver between on and standby.
- ④ **STATION (+/-), FREQUENCY (+/-), TUNING SELECT buttons (see p. 23–27)**
STATION (+/-)
Selects station memories when using the tuner.
FREQUENCY (+/-)
Selects the frequency when using the tuner.
TUNING SELECT
Switches between station memory and frequency select modes.
- ⑤ **CLASS button (see p. 25-27)**
Switches between the three banks (classes) of station memories.
- ⑥ **MEMORY button (see p. 25, 26, 29, 30)**
Press to memorize a station for recall using the STATION (+/-) buttons. Also use to search in RDS mode
- ⑦ **RF ATT button (see p. 23)**
Use to lower the input level of a radio signal that is too powerful or has interfering waves, thus causing the receiver to distort
- ⑧ **CHARACTER/SEARCH button (see p. 30)**
Use this button to search for different program types in RDS mode. It is also used to input station names.
- ⑨ **EON MODE button (see p. 31)**
Use this button to search for different programs that are transmitting traffic or news information (this search method is called EON).
- ⑩ **Display (see p. 18)**
- ⑪ **Remote sensor**
Receives the signals from the remote control.
- ⑫ **DSP MODE button (see p. 22)**
Use to switch between the various DSP modes available (**HALL, JAZZ, DANCE, THEATER1, THEATER2**) and DSP off. Use to create different surround sound effects from any stereo source.
- ⑬ **DOLBY PRO LOGIC button (see p. 20)**
Use to switch between the various Pro Logic modes (**PRO LOGIC, PRO LOGIC THEATER1, PRO LOGIC THEATER2**) and Pro Logic off.
- ⑭ **MASTER VOLUME**
Use to set the overall listening volume.
- ⑮ **PHONES jack**
Connect headphones for private listening .
- ⑯ **SPEAKERS button**
Use to switch the speaker system on or off.
- ⑰ **FL DIMMER button**
Use this button to make the fluorescent display (FL) dimmer or brighter. There are three brightness settings as well as an off setting.
- ⑱ **BASS (+/-) buttons**
Use to increase/decrease bass (within a range of - 6dB to 6dB in 2dB steps). It cannot be used when S.BASS is on.
- ⑲ **TREBLE (+/-) buttons**
Use to increase/decrease treble (within a range of - 6dB to 6 dB in 2dB steps).
- ⑳ **Function buttons**
Use to select a source for playback or recording.
- ㉑ **S.BASS button**
Use to switch on and off the bass boost. Use for a more powerful bass sound. Negates use of BASS buttons.
- ㉒ **DIRECT button**
Use to switch DIRECT playback on or off. This mode bypasses all tone controls, Dolby, DSP and channel levels for the most accurate reproduction of a program source.

Display

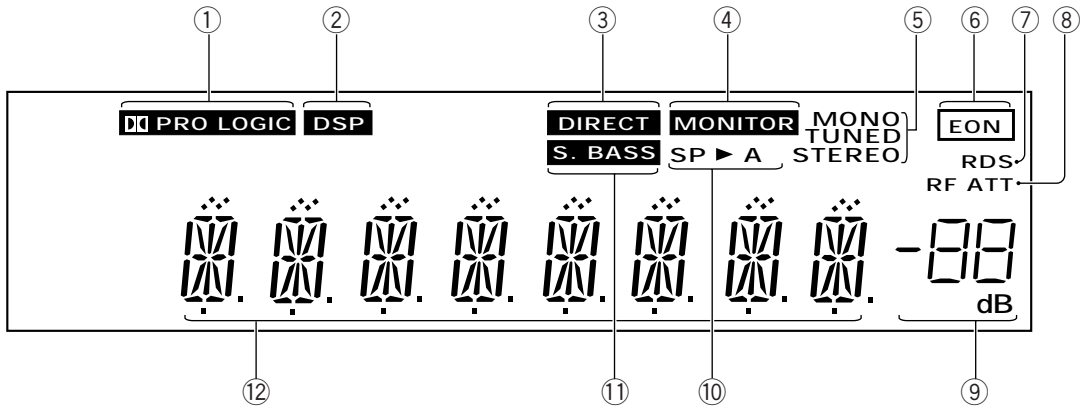

- ① **PRO LOGIC indicator**
Lights when any Dolby Pro Logic mode is selected.
The main character display briefly shows the current Pro Logic mode (**PRO LOGIC**, **THEATER1**, **THEATER2**) after selection (see page 20).
- ② **DSP indicator**
Lights when any DSP mode is selected. The main character display briefly shows the current DSP mode (**HALL**, **JAZZ**, **DANCE**, **THEATER1** and **THEATER2**) after selection (see page 22).
- ③ **DIRECT indicator**
Lights when source DIRECT is on. This function bypasses all tone, channel level, DSP and Dolby Surround effects.
- ④ **MONITOR indicator**
Lights when **MONITOR** is selected to hear a recording as it's being made (see p. 32).
- ⑤ **TUNER indicators**
MONO:
Lights when the mono mode is set using the MPX MODE button (see p. 23).
TUNED:
Lights when a broadcast is being received.
STEREO:
Lights when a stereo FM broadcast is being received in auto stereo mode.
- ⑥ **EON indicator**
When the EON mode is set the EON indicator with a box around it lights, but during actual reception of an EON broadcast the EON indicator will flash. An empty box in the EON indicator spot means it is possible to pick up an EON broadcast but the receiver has not been set to do so (this will only appear when RDS is switched on).
- ⑦ **RDS indicator**
Lights when an RDS broadcast is received.
- ⑧ **RF ATT indicator**
Lights when the RF ATT is on (see p. 23).
- ⑨ **MASTER VOLUME LEVEL**
Shows the overall volume level. Volume level is maintained even when the power is off. ---dB indicates the minimum level, and 0dB indicates the maximum level.
 - Depending on the level settings for individual channels, the MAX level can range between -10dB and 0dB.
- ⑩ **SPEAKER indicator**
Shows if the speaker system is on or not. If SP►A appears speakers are switched on. If SP► appears speakers are switched off.
- ⑪ **S. BASS indicator**
Lights when the S. BASS is on (see p. 17).
- ⑫ **CHARACTER display**
Shows radio frequency or function (DVD/LD, CD, etc.) receiver is using .

Remote Control

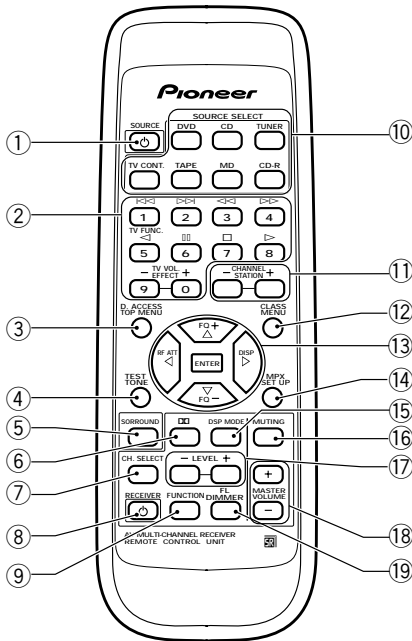

- ① **SOURCE \odot (POWER) button**
This button turns on/off the power for PIONEER components connected to the VSX-409RDS.
- ② **NUMBER/PLAYER COMMAND buttons (see p. 24, 34-37)**
Use to select radio frequency in tuner mode. Also, you can use to control PIONEER components like CD players, cassette decks, etc. according to the commands printed above the button ($\blacktriangleleft\blacktriangleright\blacksquare$, etc.)
- ③ **D.ACCESS/TOP MENU button (see p. 24, 36)**
This button gives you direct access to radio frequency input, allowing you to input a station directly. In DVD mode this button brings you to the top menu.
- ④ **TEST TONE button (see p.15, 23&24)**
Use this button to hear a test tone from each speaker in turn to set the relative speaker volumes. Also switches the BAND in TUNER mode.
- ⑤ **SURROUND button (see p.13,15, 20, 22)**
Use this button to set up the surround sound features of the VSX-409RDS. In particular, it's used to select the type of center mode, turn on/off subwoofer option and select distance for each speaker. Also used to start the process of setting the effect levels
- ⑥ **\square button(see p.15, 20)**
Use to select a Dolby Pro Logic mode. Also used to access Test Tone.

- ⑦ **CH. SELECT button (see p. 15, 16)**
Used to start the process of setting the speaker levels (see ⑰ below).
- ⑧ **RECEIVER STANDBY/ON button**
Use to switch the receiver between on and standby modes.
- ⑨ **FUNCTION button**
Use select the playback or recording source.
- ⑩ **SOURCE SELECT keys**
Use to put the remote control (NOT the receiver) in the stated mode.
For other equipment controls, see Controlling the Rest of Your System starting on page 34-37.
- ⑪ **CHANNEL/STATION +/- buttons (see p.37)**
Use to select the station of memorized frequencies or change channels on Pioneer-made TVs.
- ⑫ **CLASS/MENU button (see p.27)**
Use to switch between the three banks (classes) of station memories.
- ⑬ **\blacktriangleleft (RF ATT) \blacktriangleright (DISP) \blacktriangleup \blacktriangledown (FQ +/-) & ENTER buttons (see p.13, 14, 23, 35, 36)**
Use these arrow buttons when setting up your surround sound system (see p. 13-16). These buttons are also used to control DVD menus/options and for deck 1 of a double cassette deck player. The FQ +/- buttons can be used to find radio frequencies and the RF ATT (see p. 23) and DISP (see p. 28) buttons have special functions.
- ⑭ **MPX/SETUP button (see p. 23, 35, 36)**
Use to switch between auto stereo and mono reception of FM broadcasts. If the signal is weak then switching to MONO will improve the sound quality. In DVD mode this button brings up the SETUP menus.
- ⑮ **DSP MODE button (see page 22)**
Use to switch between the various DSP modes available (HALL, JAZZ, DANCE, THEATER1, THEATER2) and DSP off. Use to create different surround sound effects from any stereo source.
- ⑯ **MUTING button**
Use to mute all audio without affecting any of the current sound settings. If you adjust the volume the muting is automatically cancelled.
- ⑰ **LEVEL +/- buttons**
Use to set the relative speaker volumes for all the speakers in your system (see ⑦ above).
- ⑱ **MASTER VOLUME +/- buttons**
Use to set the overall listening volume.
- ⑲ **FL DIMMER button**
Use this button to make the fluorescent display (FL) dimmer or brighter. There are three brightness settings and an off setting.

Listening in Dolby Pro Logic Mode

To really appreciate what the VSX-409RDS can do, sit back and experience a movie encoded in Dolby Digital or Dolby Pro Logic with five speaker surround sound creating theater-like sound effects in your living room. When choosing software, look out for the **DOLBY SURROUND** mark on DVD discs, laser discs, and video tapes (sometimes, unmarked software is also recorded in Dolby Pro Logic).

To enjoy Dolby Digital surround sound from DVD discs, you'll need to have connected your DVD player (or Dolby Digital decoder) to the receiver's 5.1 channel inputs (see page 9), and set the receiver to DVD 5.1 CH input mode.

Many video tapes feature Dolby Surround/Pro Logic these days. The VSX-409RDS takes advantage of this to provide dramatic and realistic surround sound. The effect can be further enhanced by choosing a Pro Logic with DSP mode. Follow the steps on this page when playing Dolby Surround or Dolby Pro Logic material.

When using any of these modes, it's really important that your speakers are set up correctly (see p.11-12), and that you've worked through the steps in Setting Up for Surround Sound on pages 13-15.

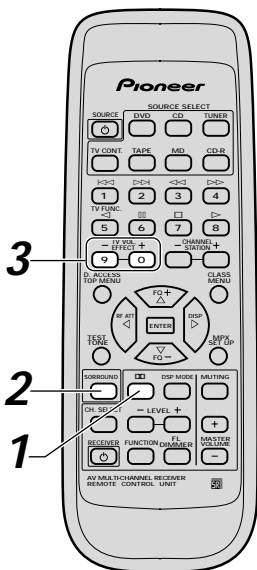

1 Press **DOLBY PRO LOGIC** on the receiver.

Pressing repeatedly changes the Pro Logic mode in the following sequence:

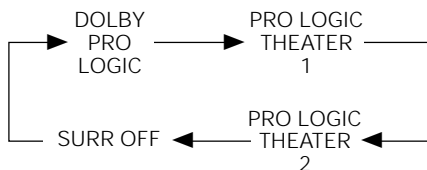

2 Press the **SURROUND** button.

This starts the process of setting the effect level.

3 Use the **EFFECT +/-** to adjust the DSP effect level **PRO LOGIC THEATER1** and **PRO LOGIC THEATER2**.

You can adjust the effect level within an range of 10-90 (the default setting is 50).



- You need to input mode/distance/level settings specifically for your Pro Logic mode (see p. 13-15).
- If you turn the speakers off PRO LOGIC goes off as well. When you turn the speakers back on, PRO LOGIC will NOT go back on.
- If you try and turn PRO LOGIC on when the speakes are off, SP OFF will flash on the display, informing you that you can't turn on PRO LOGIC when the speakers are off.
- You can't use the tone controls, the DIRECT function with PRO LOGIC mode.

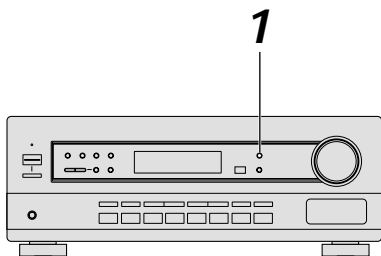

Listening in DVD 5.1 Channel Input Mode

Some DVD players feature a built-in Dolby Digital decoder with separate analogue audio outputs for the front left and right, centre, surround left and right, and sub-woofer channels. Connect these to the 5.1 channel inputs of the VSX-409RDS for enhanced playback of Dolby Digital material—see page 9 for instructions on connecting up. 5.1 channel mode of the VSX-409RDS provides better surround-channel sound and overall channel separation than the Dolby Pro Logic mode.

Follow the steps below to use the 5.1 channel mode.

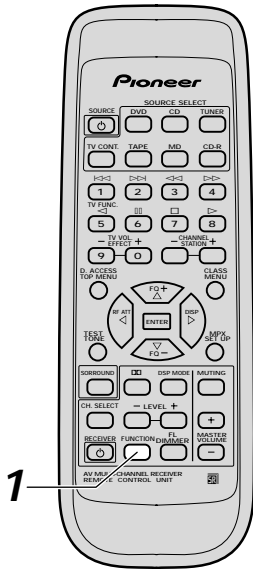

1 Use the FUNCTION button to select DVD 5.1 CH.

On the receiver, press the **DVD 5.1 CH** function button to select the DVD input mode directly.

On the remote control, repeated presses of the FUNCTION button switches between 5.1 channel input and the other inputs.



- You can input level settings specifically for your 5.1 CH mode and this will enhance your surround sound experience (see p. 15).
- You can't use the tone controls S.BASS, DIRECT, DSP, or the PRO LOGIC functions with 5.1 CH mode.

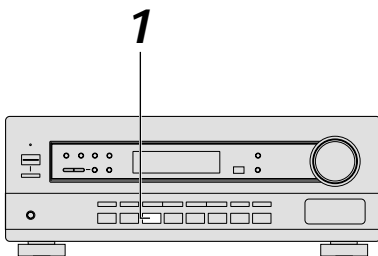

Listening in DSP Mode

The DSP (Digital Signal Processing) modes transform your living room into a variety of different sound environments when playing standard (two channel) stereo sources. Optionally, you can adjust the amount of effect added to the source. The descriptions below give an idea of what the five different modes sound like, but the best idea is to play a source and experiment.

HALL

Simulates the acoustic environment of a large classical concert hall. Long delay and reverb decay times create a sense of music being played in a large space.

JAZZ

Simulates the acoustic environment of a jazz club. Shorter delay times and a tighter reverb help to give the sound a live, small club feel.

DANCE

Simulates the acoustic environment and strong bass sound of a dance music club.

THEATER 1

Simulates the acoustic environment of a mid-sized movie theater.

THEATER 2

Similar to the above but maintains proper localization of each channel.

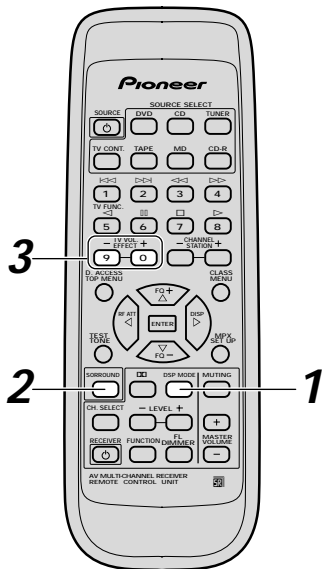

1 Select a DSP MODE.

Repeated presses of **DSP MODE** changes the DSP mode in the following sequence:

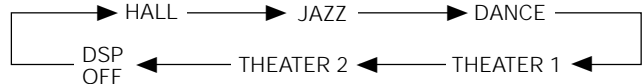

2 Press the SURROUND button.

3 Use the EFFECT +/- buttons to adjust the DSP effect level.

You can adjust the effect level within an range of 10–90 (the default setting is 50).



- All DSP effect levels are independent of each other.
- You can input level settings specifically for each DSP mode and this will enhance your surround sound experience.
- If you turn the speakers off, DSP goes off as well.
- When the speakers are off you can't use the DSP mode.
- You can't use the tone controls, the DIRECT function with DSP mode.

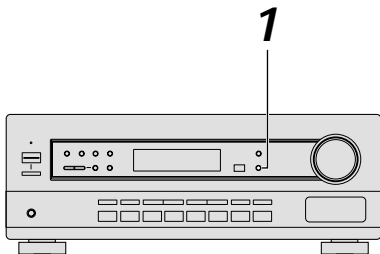

Finding a Station

The following steps show you how to tune in to FM and AM radio broadcasts using the automatic (search) and manual (step) tuning functions. If you already know the exact frequency of the station you want to listen to, see Tuning Directly to a Station on the following page. Once you are tuned to a station you can memorize the frequency for recall later—see Memorizing Stations on page 25 for more on how to do this.

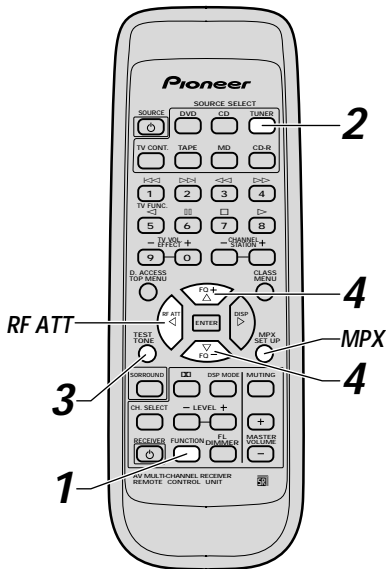

1 Use the **FUNCTION** button to put the receiver in tuner mode .

On the receiver, press the **FM/AM** button to select the tuner mode.

2 Press the **TUNER** button on the remote control to put the remote control in tuner mode.

3 Use the **TEST TONE** button to change the band (**FM** or **AM**), if necessary.

Each press switches the band between FM and AM (on the front panel use the FM/AM button).

4 Tune to a station.

Automatic tuning

To search for stations in the currently selected band, press and hold either the **FQ. +** or **FQ. -** button for about a second. The receiver will start searching for the next station, stopping when it has found one. Repeat this step to search for other stations.

Manual tuning

To change the frequency one step at a time, press the **FQ. + / FQ. -** (**▲▼**) buttons.

To change frequency more quickly, press and hold the **FQ. + / FQ. -** buttons until the desired frequency is reached, then release.

Once you've found a station, you can store it in the receiver's memory for easy recall anytime—turn to page 25 for more on this.

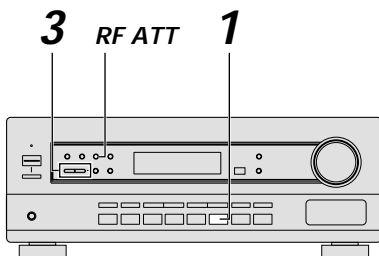

MPX mode

If the **TUNED** or **STEREO** indicators don't light when tuning to an FM station because the signal is weak, press the **MPX** button to switch the receiver into mono reception mode. This should improve the sound quality and allow you to enjoy the broadcast.

RF ATT mode

If the radio signal is too strong and/or the sound is distorting press the **RF ATT** button to attenuate (lower) the radio signal input and reduce the distortion.

Tuning Directly to a Station

Sometimes, you'll already know the frequency of the station you want to listen. In this case, you can simply enter the frequency directly using the number buttons on the remote control (this function is not available using the front panel controls of the receiver).

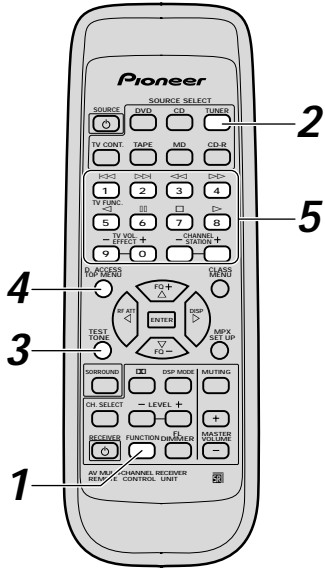

1 Use the **FUNCTION** button to put the receiver in tuner mode .

On the receiver, press the **FM/AM** button to select the tuner mode.

2 Press the **TUNER** button on the remote control to put the remote control in tuner mode.

3 Press the **TEST TONE** button to select either **FM** or **AM**.

Each press switches the band between FM and AM. On the receiver, pressing the **FM/AM** button switches between bands.

4 Press **D. ACCESS (DIRECT ACCESS)**.

5 Use the number buttons to enter the frequency of the radio station.

Example:

To tune to 106.00 (FM), press **1 - 0 - 6 - 0 - 0**

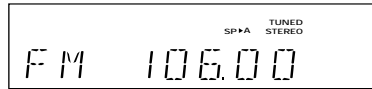

If you make a mistake while inputting the frequency, press the **D.ACCESS** button twice to cancel the frequency and start again.

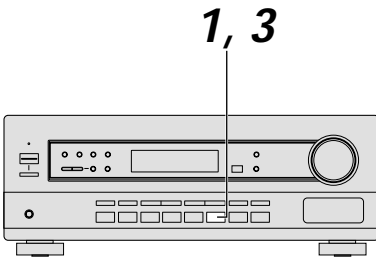

Memorizing Stations (front panel only)

If you often listen to a particular radio station, it's convenient to have the receiver store the frequency for easy recall whenever you want to listen to that station. This saves the effort of manually tuning in each time. The VSX-409RDS can memorise up to 30 stations, stored in three banks, or classes (A, B and C) of 10 presets each. When memorizing FM frequencies, the receiver also stores the MPX setting (auto stereo or mono), and RF ATT settings. The process for memorizing stations is only possible from the controls on the front panel of the receiver.

1 Tune to a station you want to memorize.

See Finding a Station and Tuning Directly to a Station on pages 23 and 24 for more on how to do this.

2 Press MEMORY.

The display shows a blinking memory class.

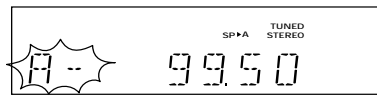

3 Press CLASS to select one of the three classes.

Repeatedly pressing this button cycles through the three available classes, A, B and C.

4 Press STATION +/- to choose the preset memory number.

Pressing these buttons repeatedly cycles through the 10 available preset memories in each class.

After choosing the location you want, the preset class and number blink for about 5 seconds and the receiver stores the station.

Repeat steps 1 to 4 to memorize up to 30 stations.

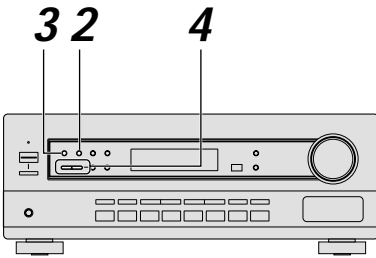

Naming Memorized Stations (front panel only)

You can input a name of up to four characters for each preset station in the receiver's memory (see the previous page). This name can be anything you choose. For example, you could input "BBC1" for that station and when you listen to it the name, rather than the frequency number, will appear on your display.

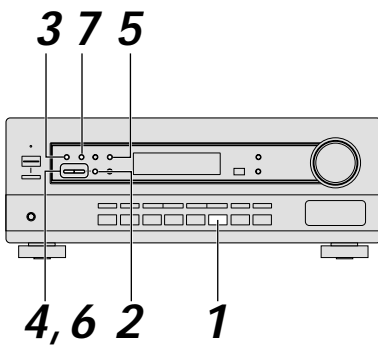

1 Press FM/AM to set the tuner function.

2 Press TUNING SELECT to select the STATION mode.

3 Press CLASS repeatedly to select the class.

Repeatedly pressing this button cycles through the three available classes, A, B and C.

4 Press STATION (+/-) to select the preset channel.

5 Press CHARACTER/SEARCH to select the character input mode.

6 Press STATION (+/-) to choose the first character.

The STATION +/- buttons scroll through the letters, numbers and symbols you can input.



7 Press MEMORY to input the first of the four characters.

That character appears in the display and the cursor automatically moves to the next space. After four characters have been entered, the character input mode is exited.

Repeat steps 3 to 7 to memorize up to 30 preset broadcast station names.



To erase or change the station name

Perform the procedures of "Naming Memorized Stations" and enter four spaces to erase the memorized station name.

When you want to change a memorized station name, input the new station name using the same procedure.

Recalling Memorized Stations

Having memorized up to 30 stations (see the previous page for how to do this), you can quickly recall one of these stations.

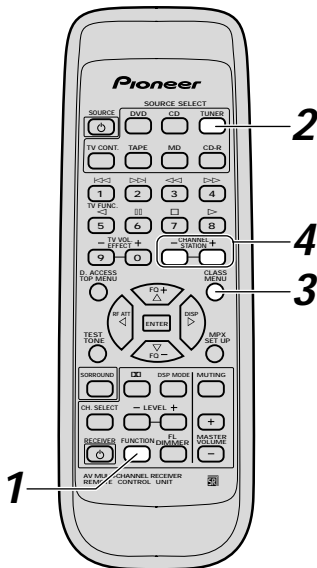

1 Use the **FUNCTION** button to put the receiver in tuner mode .

On the receiver, press the **FM/AM** button to select the tuner mode.

2 Press the **TUNER** button on the remote control to put the remote control in tuner mode.

3 Press **CLASS** to select the class in which the station is stored.

Repeatedly pressing this button cycles through the three available classes, A, B and C.

4 Use the **STATION +/-** buttons to select the station memory in which the station is stored.

Alternatively, recall the station memory using the number buttons on the remote control.

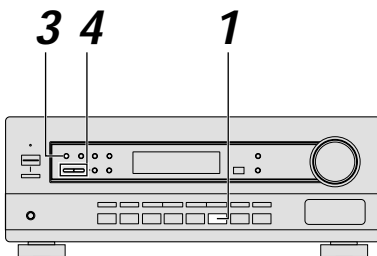

If the receiver is left disconnected from the AC power outlet for a lengthy period, the station memories will be lost and will have to be reprogrammed.

An Introduction to RDS & EON

Radio Data System, or RDS as it's usually known, is a system used by FM radio stations to provide listeners with various kinds of information—the name of the station and the kind of show they're broadcasting, for example. This information shows up as text on the display, and you can switch between the kind of information shown. Although you don't get RDS information from all FM radio stations, you do with most.

Probably the best feature of RDS is that you can search automatically by type of programme. So, if you felt like listening to jazz, you could search for a station that's broadcasting a show with the programme type, "JAZZ." There are around 30 such programme types, including various genres of music, news, sport, talk shows, financial information, and so on.

The VSX-409RDS receiver lets you display three different kinds of RDS information: Radio Text, Programme Service Name, and Programme Type.

Radio Text (**RT**) is messages sent by the radio station. These can be anything the broadcaster chooses—a talk radio station might give out its telephone number as RT, for example.

Programme Service Name (**PS**) is the name of the radio station.

Programme Type (**PTY**) indicates the kind of programme currently being broadcast.

The VSX-409RDS can search for and display the following programme types:

News	
Affairs	Current affairs
Info	General information
Sport	
Educate	Educational material
Drama	Radio plays or serials
Culture	
Science	Science and technology
Varied	Usually talk-based material, such as quiz shows or interviews.
Pop M	Pop music
Rock M	Rock music
M.O.R. M	"Middle of the road" music
Light M	'Light' classical music
Classics	'Serious' classical music
Other M	Other music not fitting any of the above categories
Weather	
Finance	stock market reports, commerce, trading, etc.
Children	Children's entertainment
Social A	Social affairs
Religion	
Phone in	
Travel	Holiday-type travel rather than traffic announcements.
Leisure	Leisure interests and hobbies
Jazz	
Country	Country music
Nation M	Popular music in a language other than English
Oldies	Popular music from the '50s
Folk M	Folk music
Document	Documentaries

In addition, there is a programme type, ALARM!, used for exceptional emergency announcements. You can't search for this, but the tuner will switch automatically to this RDS broadcast signal.

Using the RDS display

To display the different types of RDS information available (RT, PT and PTY as explained on the previous page), press TUNER on the remote control and use the DISP button (also marked ►) to cycle through the types of RDS information.

Each press changes the display as follows.

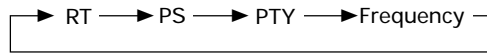

Basics of EON

EON (Enhanced Other Network information)

EON is a function that allows you to set the receiver to switch to a frequency automatically when a programme featuring traffic information or news is being broadcast. It cannot be used in areas that EON information is not transmitted and when FM broadcast stations do not transmit PTY data. When the broadcast ends, the tuner returns to the original frequency or function.

There are two types of EON you can set the tuner to:

- 1) TA (Traffic Announcement)
This mode will set the tuner to pick up traffic information when it is broadcast.
- 2) NEWS
This mode will set the tuner to pick up news when it is broadcast.

Setting EON allows automated reception of TA/NEWS broadcasts

When EON is turned on, the receiver will automatically jump to those EON-linked broadcasts. Even if a receiver function other than the tuner is being used, the receiver function will switch to the FM station automatically when an EON-linked Traffic Information or News programme begins. When the programme ends, the original function will be restored. The EON function will not operate, however, when the the tuner is on AM.

The receiver's internal Program Identification function

PI (Programme Identification)

This is an identifying marker the tuner automatically attaches to stations stored in your preset memory classes (see p. 25). The marker distinguishes between stations which transmit RDS data and those that don't, so that the receiver knows which stations to look at when searching for RDS or EON transmissions. The code is not displayed on the receiver and you don't need to do anything in regards to setting the PI codes.

PI code registration and erasure

The receiver will automatically register a PI code for any station you input into the memory classes (see p. 25) which can receive RDS or EON data. If you want to have a station preset in your memory banks but DON'T want the receiver to search this station for RDS information you can erase the PI code and then the receiver will ignore this station when searching for RDS transmissions.

To erase PI codes, follow this procedure:

1. When tuned to the station whose PI code you want to erase press the EON MODE button for two seconds or more.
"ERASE PI" will be displayed.
2. Press MEMORY button within 5 seconds.

Searching for RDS Programmes (front panel only)

One of the most useful features of RDS is the ability to search for a particular kind of radio programme. You can search for any of the programme types listed on page 27—this covers all kinds of music, as well as news, weather forecasts, sports programmes, and a variety of others.

1 Put the receiver in FM band by pressing the FM/AM button.

RDS is only broadcast on FM.

2 To select the PTY search mode press the CHARACTER/SEARCH button until you see SEARCH in the display.

If you are on a preset station you'll have to press the button twice, if not then one press will bring up the PTY search mode.

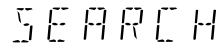

3 Use the STATION +/- buttons to select the programme type you want to hear.

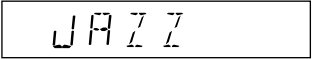

4 Press MEMORY search for the programme type.

The tuner searches through the FM stations stored in the station memories.

If the tuner finds a matching programme type, the tuner plays 5 seconds of the station. To listen to that station, press the CHARACTER/SEARCH button. (The tuner stops searching.)

If you don't press the CHARACTER/SEARCH button during the above mentioned 5 seconds, the tuner resumes the search.

When the tuner finds a programme type you searched for, the frequency display will blink for about 5 seconds and then the display will show FINISH briefly.

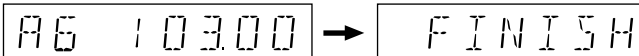

If NO PTY is displayed it means the tuner couldn't find that programme type at the time of the search.

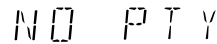

The tuner stops on any station that is broadcasting that programme type

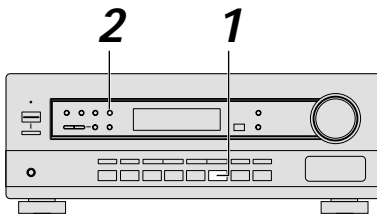

This function searches RDS stations preset in the 30ch memory. If this function is set when no stations have been preset, "NO PTY" will be displayed. If the desired PTY could not be found amongst the RDS stations in memory, the same display appears.

Using EON search (front panel only)

1 Put the receiver in FM band by pressing the FM/AM button.

EON is only broadcast on FM.

2 Choose a station stored in the receiver's preset memory (see p. 25-26).

3 Press the EON MODE button and choose the EON search you want.

There are two EON modes: EON TA and EON NEWS. EON TA will automatically search for traffic reports and EON NEWS will automatically search for news reports among your preset stations.

Each press changes the display as follows.

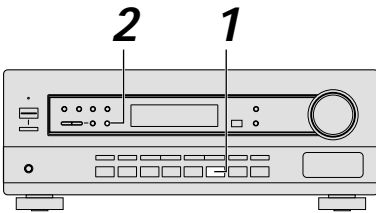

3 EON search has been set. If the receiver finds an EON-linked broadcast it will automatically jump to it.

The receiver is set to receive EON information even when it is not in TUNER mode. If such information is found the receiver will automatically switch into TUNER mode to pick up the EON broadcast. When the programme ends the receiver will return to the original mode.

When the EON mode is set the EON indicator with a box around it lights, but during actual reception of an EON-linked broadcast the EON indicator will flash. An empty box in the EON indicator spot means it is possible to pick up an EON-linked broadcast but the receiver has not been set to do so (this will only appear when RDS is switched on).



- The EON mode is cancelled if you switch to AM reception while setting EON. It starts once again when you return to FM reception.
 - Simultaneous requests for Traffic Information (TA) and News programmes is not possible.
 - You cannot operate the MEMORY and CHARACTER/SEARCH buttons while the EON indicator lights.
 - Functions other than TUNER cannot be changed while the EON indicator flashes (while receiving on EON-linked broadcast).
- If you want to change to a function other than TUNER, press the EON MODE button and turn the EON mode off.

Making an Audio Recording

The following steps show you how to make an audio recording from the built in tuner, or from an audio source connected to the receiver (such as a CD player or MD player). Recordings can be made to a CD-Recorder, cassette deck or MD deck connected to the CD-R/TAPE/MD in/out connectors.



The receiver's volume, channel levels, tone (bass, treble), S.bass, and surround effects (Dolby Pro Logic and DSP settings) have no effect on the recorded signal.

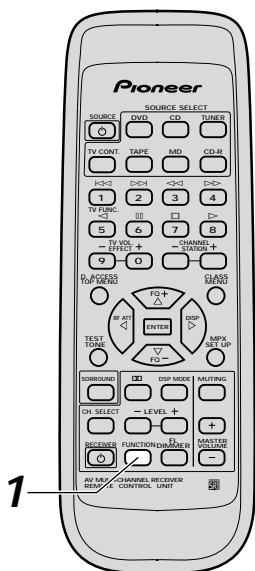

1 Press the **FUNCTION** button to select a source to record.

All functions except MONITOR are accessible from the remote control.

On the receiver, select the source directly using the front panel buttons.

2 Prepare the programme source.

Tune to the radio station, load the CD, etc.

3 Insert a blank CD-R, MD, tape etc. into the recording device connected to either CD-R/TAPE/MD and set the recording levels.

Refer to the instructions that came with the recorder if you are unsure how to do this.

4 Start recording, then start playback of the source component.

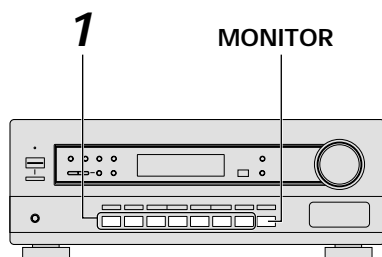

Record **MONITOR**

You can listen to (monitor) the recording as it's being made using the MONITOR button on the Front Panel (a cassette deck would have to have a record monitor function).

Press the MONITOR button to switch between the recorded signal and the original source signal.

Making a Video Recording

The following steps show you how to make a video recording from a video source connected to the receiver, such as a DVD player, LD player, etc., to a video deck connected to the **VCR/DVR** connectors.



The receiver's volume, channel levels, tone (bass, treble), S. bass, and surround effects (Dolby Pro Logic and DSP settings) have no effect on the recorded audio signal.

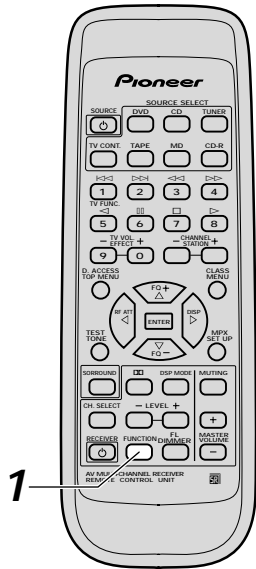

1 Press the **FUNCTION** button to select a source to record.

On the receiver, select the source directly using the front panel buttons.

2 Prepare the programme source.

Load the DVD, LD, etc.

3 Insert a blank tape or DVR into the **VCR/DVR** and set the audio recording level (if applicable).

Most video recorders set the audio recording level automatically—check your video's instruction manual if you are unsure whether yours has manual controls.

4 Start recording on the **VCR/DVR**, then start playback from the source component.

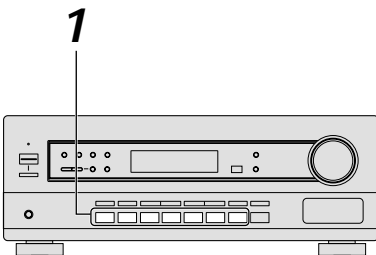

CD/MD/CD-R Player Controls



The following controls are available from the receiver's remote if your CD, MD or CD-R player is made by Pioneer.
To control your CD, MD or CD-R player with this remote control, first put the remote into CD, MD or CD-R mode with the proper SOURCE SELECT button (i.e. the CD, MD, or CD-R button).

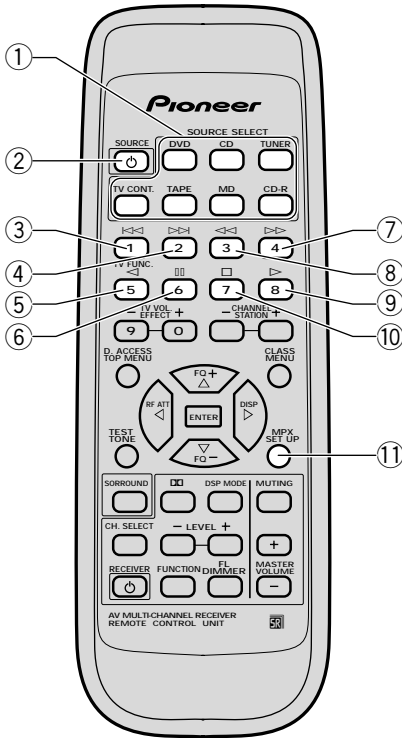

- ① **Use SOURCE SELECT buttons to put the remote control in the stated mode.**
- ② **SOURCE (power)**
Press to switch the CD, MD or CD-R player between **STANDBY** and **ON**.
- ③
- Press to return to the start of the current track. Repeated presses skips to the start of previous tracks.
- ④
- Press to advance to the start of the next track. Repeated presses skips to the start of following tracks.
- ⑤
- This button has no function.
- ⑥
- Press to pause playback.
- ⑦
- Hold down for fast forward playback.
- ⑧
- Hold down for fast reverse playback.
- ⑨
- Press to start playback.
- ⑩
- Press to stop playback (on some models, pressing this when the disc is already stopped will cause the disc tray to open).
- ⑪ **MPX/SETUP(MENU) (MD players only)**
Use to change discs in MD decks that can play multiple discs.

Cassette Deck Controls



The following controls are available from the receiver's remote if your cassette deck is made by Pioneer.

To control your cassette deck with this remote control, first put the remote into the TAPE mode with the TAPE SOURCE SELECT button.

For regular cassette decks use buttons ③-⑩ below for the tape control functions. For double deck models, use buttons ③-⑩ to control deck 2 and buttons ⑪-⑫ to control deck 1.

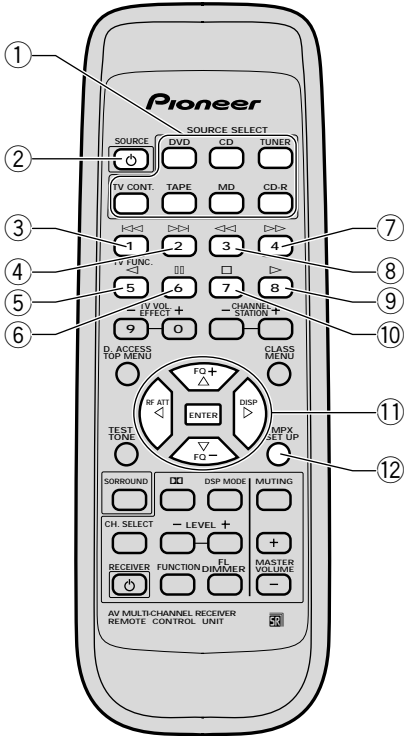

- ① **Use SOURCE SELECT buttons to put the remote control in the stated mode.**
- ② **SOURCE (power)**
Press to switch the cassette deck between STANDBY and ON (not possible on all models).
- ③
- ④
- ⑤
- ⑥
- ⑦
- ⑧
- ⑨
- ⑩
- ⑪ : Press to fast forward the tape. Pressing during playback starts forward search.
 : Press to rewind the tape. Pressing during playback starts reverse search.
ENTER : PRESS TO STOP PLAYBACK, ETC.
 : Press to start playback of reverse side of tape (auto- reverse models only).
 : Press to start playback.
- ⑫ **MPX/SETUP(II)**
Press to pause playback or recording.

DVD Player Controls



The following controls are available from the receiver's remote if your DVD player is made by Pioneer.

To control your DVD player with this remote control, first put the remote into DVD mode with the DVD SOURCE SELECT button.

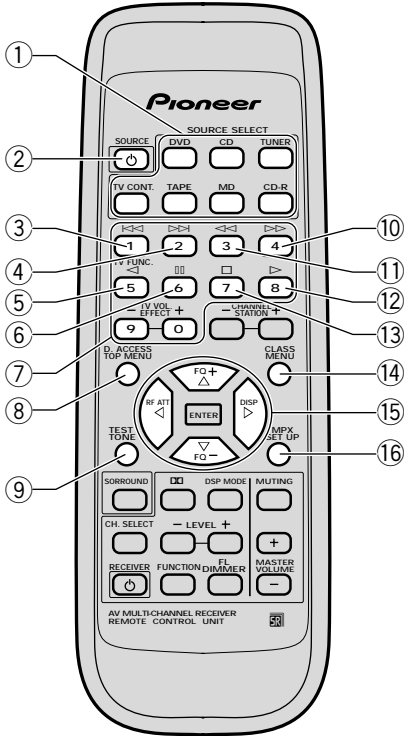

① **Use SOURCE SELECT buttons to put the remote control in the stated mode.**

② **SOURCE (power)**
Press to switch the DVD/LD player between STANDBY and ON.

③

Press to return to the start of the current chapter (track). Repeated presses skips to the start of previous tracks.

④

Press to advance to the start of the next chapter (track). Repeated presses skips to the start of following tracks.

⑤

Use to switch the language on discs that feature multi-lingual soundtracks (on some models this will switch the angle).

⑥

Press to pause playback (on some models this will freeze-frame the picture).

⑦ **Number buttons**
For other DVD models:
Use the number buttons to navigate the on-screen display:

⑧ **TOP MENU**
Use to display or close the top menu screen

⑨ **AUDIO**
Press repeatedly to select one of the audio languages and or audio formats programmed on a DVD.

⑩

Hold down for fast forward playback.

⑪

Hold down for fast reverse playback.

⑫

Press to start playback (on some models, pressing this when the disc tray is empty will cause the disc tray to open).

⑬

Press to stop playback (on some models, pressing this when the disc is already stopped will cause the disc tray to open).

⑭ **MENU**
Displays menus for adjusting default settings of picture quality, etc.

⑮ : up
 : down

ENTER

: left

: right

⑯ **SET UP**
Press when the player is in either play or stop mode to open and close the Setup screen.

TV Controls



The following controls are available from the receiver's remote if your TV is made by Pioneer. To control your TV with this remote control, first put the remote into TV mode with the TV CONT SOURCE SELECT button.

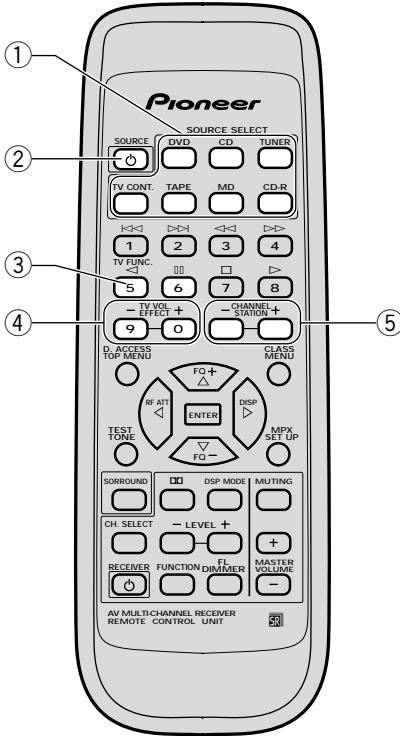

- ① Use **SOURCE SELECT** buttons to put the remote control in the stated mode.
- ② **SOURCE** (**power**)
Press to switch the TV or CATV between **STANDBY** and **ON**.
- ③ **TV FUNC. (TV only)**
Press to switch the TV input (not possible with all models).
- ④ **TV VOL +/-**
Use to adjust the TV volume.
- ⑤ **CHANNEL +/-**
Use to select channels.

Troubleshooting

Incorrect operation is often mistaken for trouble and malfunctions. If you think that there is something wrong with this component, check the points below. Sometimes the trouble may lie in another component. Investigate the other components and electrical appliances being used. If the trouble cannot be rectified even after exercising the checks listed below, ask your nearest Pioneer authorized service center or your dealer to carry out repair work.

Symptom	Cause	Remedy
The power does not turn on.	<ul style="list-style-type: none"> The power plug is disconnected. The protection circuit may have activated. 	<ul style="list-style-type: none"> Connect the power plug to the wall outlet. Disconnect the power plug from the outlet, and insert again.
The unit does not respond when the buttons are pressed.	<ul style="list-style-type: none"> Static electricity caused by dry air. 	<ul style="list-style-type: none"> Disconnect the power plug from the outlet, and insert again.
No sound is output when a function is set.	<ul style="list-style-type: none"> Improper connections. Sound is muted. The volume is turned down. Speakers are turned off. Monitor is on. 	<ul style="list-style-type: none"> Make sure the component is connected correctly (see pages 7 through 11). Press MUTING on the remote control. Adjust MASTER VOLUME. Press SPEAKERS to switch on the speakers. Press the MONITOR button.
No image is output when a function is set.	<ul style="list-style-type: none"> Improper connections. The input source is not properly selected. 	<ul style="list-style-type: none"> Make sure the component is connected correctly (see pages 7 through 11). Press the correct function button.
Considerable noise in radio broadcasts	<ul style="list-style-type: none"> Incorrect frequency. The antenna is not connected. 	<ul style="list-style-type: none"> Tune in the correct frequency. Connect the antenna (see page 7).
FM broadcasts		
	<ul style="list-style-type: none"> The FM antenna is not fully extended or poorly positioned. Weak radio signal. Interfering radio waves causing distortion. 	<ul style="list-style-type: none"> Fully extend the FM wire antenna, position for best reception, and secure to a wall. Connect an outdoor FM antenna. (see page 7). Press RF ATT button.
AM broadcasts		
	<ul style="list-style-type: none"> The AM antenna is poorly positioned. Weak radio signal. Interference cause by other equipment (fluorescent lamp, motor, etc.). 	<ul style="list-style-type: none"> Adjust the direction and position for best reception. Connect an additional internal or external AM antenna (see page 7). Turn off the equipment causing the noise or move it away from the receiver. Place the antenna farther away from the equipment causing the noise.

Symptom	Cause	Remedy
Broadcast stations cannot be selected automatically.	<ul style="list-style-type: none"> Weak radio signal. 	<ul style="list-style-type: none"> Connect an outdoor antenna (see page 7).
No sound from surround or center speakers.	<ul style="list-style-type: none"> Incorrect center mode. The surround and/or center levels are turned down. The surround and/or center speakers are disconnected. 	<ul style="list-style-type: none"> Set the correct center mode according to the speakers in your system (see page 13). See Setting Volume Levels on page 15-16 to check the speaker levels. Connect the speakers (see pages 11-12).
Cannot be remote controlled.	<ul style="list-style-type: none"> The remote control unit batteries have worn out. Too far away or bad angle of operation. There is an obstacle between the receiver and the remote control. Strong light such as fluorescent light is shining onto the unit's remote control signal light-receiving window. 	<ul style="list-style-type: none"> Replace the batteries (see page 6). Operate within 7 m, 30° of the remote sensor on the front panel (see page 6). Remove the obstacle or operate from another position. Avoid exposing the remote sensor on the front panel to direct light.

If the unit does not operate normally due to external effects such as static electricity

- Disconnect the power plug from the outlet and insert again to return to normal operating conditions.

Specifications

Continuous Power Output

Front 80 W + 80 W (DIN,1kHz, 0.9 %, 8 Ω)
Center 80 W (DIN,1kHz, 0.9 %, 8 Ω)
Surround 80 W + 80 W (DIN,1kHz, 0.9 %, 8 Ω)
● Above specifications are for when power supply is 230 V.

Input (Sensitivity/Impedance)

CD, VCR/DVR, CD-R/TAPE/MD, DVD/LD, TV/SAT
..... 200 mV/47 k Ω

Frequency Response

CD, VCR/DVR, CD-R/TAPE/MD, DVD/LD, TV/SAT
..... 5 Hz to 100,000 Hz

Output (Level/Impedance)

VCR/DVR REC, CD-R/TAPE/MD REC
..... 200 mV/2.2 k Ω

Tone Control

BASS \pm 6 dB (100 Hz)
TREBLE \pm 6 dB (10 kHz)
S.BASS + 8 dB (100 Hz)

Signal-to-Noise Ratio [DIN(Rated power output/50 mW)]

CD, VCR/DVR, CD-R/TAPE/MD, DVD/LD, TV/SAT
..... 88 dB/64 dB

Video Section

Input (Sensitivity/Impedance)

VCR, DVD/LD, TV/SAT 1 V_{p-p}/75 Ω

Output (Level/Impedance)

VCR 1 V_{p-p}/75 Ω

Frequency Response

VCR, DVD/LD, TV/SAT → MONITOR
..... 5 Hz to 7 MHz $\frac{+0}{-3}$ dB

Signal-to-Noise Ratio 55 dB

Cross Talk 55 dB

FM Tuner Section

Frequency Range 87.5 MHz to 108 MHz

Usable Sensitivity
..... Mono:15.2 dBf, IHF (1.6 μ V/75 Ω)

50 dB Quieting Sensitivity Mono: 20.2 dBf
Stereo: 41.2 dBf

Signal-to-Noise Ratio Mono: 76 dB (at 85 dBf)
Stereo: 72 dB (at 85 dBf)

Distortion Stereo: 0.6 % (1 kHz)

Alternate Channel Selectivity 70 dB (400 kHz)

Stereo Separation 40 dB (1 kHz)

Frequency Response 30 Hz to 15 kHz (\pm 1) dB

Antenna Input 75 Ω unbalanced

Sensitivity (DIN) Mono: 1.1 μ V(S/N 26dB)
Stereo 50 μ V(S/N 46dB)

Signal-to-Noise Ratio (DIN) Mono: 62dB
Stereo: 58dB

AM Tuner Section

Frequency Range 531 kHz to 1,602 kHz

Sensitivity (IHF, Loop antenna) 350 μ V/m

Selectivity 30 dB

Signal-to-Noise Ratio 50 dB

Antenna Loop antenna

Miscellaneous

Power Requirements AC 220-230 V, 50/60 Hz

Power Consumption 220 W

In Standby Condition 1 W

Dimensions 420 (W) x 158 (H) x 391 (D) mm

Weight (without package) 8.4 kg

Furnished Parts

FM Wire Antenna 1

AM Loop Antenna 1

Dry Cell Batteries
size "AA" (IEC R6P) 2

Remote Control Unit 1

Operating Instructions 1

NOTE:

Specifications and the design are subject to possible modifications without notice, due to improvements.

MAINTENANCE OF EXTERNAL SURFACES

- Use a polishing cloth or dry cloth to wipe off dust and dirt.
- When the surfaces are very dirty, wipe with a soft cloth dipped in some neutral cleanser diluted five or six times with water, and wrung out well, and then wipe again with a dry cloth. Do not use furniture wax or cleaners.
- Never use thinners, benzene, insecticide sprays or other chemicals on or near this unit, since these will corrode surfaces.

Published by Pioneer Electronic Corporation.
Copyright © 1999 Pioneer Electronic Corporation.
All rights reserved.

PIONEER ELECTRONIC CORPORATION

4-1, Meguro 1-Chome, Meguro-ku, Tokyo 153-8654, Japan

PIONEER ELECTRONICS [USA] INC. P.O. BOX 1540, Long Beach, California 90801-1540, U.S.A.

PIONEER ELECTRONICS OF CANADA, INC. 300 Allstate Parkway, Markham, Ontario L3R 0P2, Canada

PIONEER ELECTRONIC [EUROPE] N.V. Haven 1087, Keetberglaan 1, 9120 Melsele, Belgium TEL: 03/570.05.11

PIONEER ELECTRONICS AUSTRALIA PTY. LTD. 178-184 Boundary Road, Braeside, Victoria 3195, Australia, TEL: 03-9586-6300

PIONEER ELECTRONICS DE MEXICO S.A. DE C.V. San Lorenzo Num 1009 3er piso Desp. 302 Col. Del Valle, Mexico D.F. C.P. 03100 TEL: 5-688-52-90

Free Manuals Download Website

<http://myh66.com>

<http://usermanuals.us>

<http://www.somanuals.com>

<http://www.4manuals.cc>

<http://www.manual-lib.com>

<http://www.404manual.com>

<http://www.luxmanual.com>

<http://aubethermostatmanual.com>

Golf course search by state

<http://golfingnear.com>

Email search by domain

<http://emailbydomain.com>

Auto manuals search

<http://auto.somanuals.com>

TV manuals search

<http://tv.somanuals.com>