

**Pioneer** *sound.vision.soul*

## AUDIO/VIDEO MULTI-CHANNEL RECEIVER

# VSX-815

# VSX-915

Register your product at:

**[www.pioneerelectronics.com](http://www.pioneerelectronics.com)**

- **Protect your new investment**

The details of your purchase will be on file for reference in the event of an insurance claim such as loss or theft.

- **Receive free tips, updates and service bulletins on your new product**

- **Improve product development**

Your input helps us continue to design products that meet your needs.

- **Receive a free Pioneer newsletter**

Registered customers can opt in to receive a monthly newsletter.

## Operating Instructions

Thank you for buying this Pioneer product. Please read through these operating instructions so you will know how to operate your model properly. After you have finished reading the instructions, put them away in a safe place for future reference.

If the AC plug of this unit does not match the AC outlet you want to use, the plug must be removed and appropriate one fitted. Replacement and mounting of an AC plug on the power supply cord of this unit should be performed only by qualified service personnel. If connected to an AC outlet, the cut-off plug can cause severe electrical shock. Make sure it is properly disposed of after removal. The equipment should be disconnected by removing the mains plug from the wall socket when left unused for a long period of time (for example, when on vacation).

D3-4-2-1a\_A\_En

**WARNING** – TO PREVENT FIRE OR SHOCK HAZARD, DO NOT EXPOSE THIS APPLIANCE TO RAIN OR MOISTURE.

D1-4-2-1\_En

**CAUTION** – PREVENT ELECTRIC SHOCK DO NOT USE THIS (POLARIZED) PLUG WITH AN EXTENSION CORD. RECEPTACLE OR OTHER OUTLET UNLESS THE BLADES CAN BE FULLY INSERTED TO PREVENT BLADE EXPOSURE.

**ATTENTION** – POUR PREVENIR LES CHOCS ELECTRIQUES NE PAS UTILISER CETTE FICHE POLARISEE AVEC UN PROLONGATEUR UNE PRISE DE COURANT OU UNE AUTRE SORTIE DE COURANT, SAUF SI LES LAMES PEUVENT ETRE INSEREES A FOND SANS EN LAISSER AUCUNE PARTIE A DECOUVERT.

D2-4-4-1\_EF

**WARNING:** Handling the cord on this product or cords associated with accessories sold with the product will expose you to lead, a chemical known to the State of California and other governmental entities to cause cancer and birth defects or other reproductive harm.

**Wash hands after handling**

D36-P4\_En

**IMPORTANT NOTICE** – THE SERIAL NUMBER FOR THIS EQUIPMENT IS LOCATED IN THE REAR. PLEASE WRITE THIS SERIAL NUMBER ON YOUR ENCLOSED WARRANTY CARD AND KEEP IN A SECURE AREA. THIS IS FOR YOUR SECURITY.

D1-4-2-6-1\_En

**NOTE:** This equipment has been tested and found to comply with the limits for a Class B digital device, pursuant to Part 15 of the FCC Rules. These limits are designed to provide reasonable protection against harmful interference in a residential installation. This equipment generates, uses, and can radiate radio frequency energy and, if not installed and used in accordance with the instructions, may cause harmful interference to radio communications. However, there is no guarantee that interference will not occur in a particular installation. If this equipment does cause harmful interference to radio or television reception, which can be determined by turning the equipment off and on, the user is encouraged to try to correct the interference by one or more of the following measures:

- Reorient or relocate the receiving antenna.
- Increase the separation between the equipment and receiver.
- Connect the equipment into an outlet on a circuit different from that to which the receiver is connected.
- Consult the dealer or an experienced radio/TV technician for help.

D8-10-1-2\_En

This Class B digital apparatus complies with Canadian ICES-003.

Cet appareil numérique de la Classe B est conforme à la norme NMB-003 du Canada.

D8-10-1-3\_EF

#### Information to User

Alteration or modifications carried out without appropriate authorization may invalidate the user's right to operate the equipment.

D8-10-2\_En

**CAUTION:** This product satisfies FCC regulations when shielded cables and connectors are used to connect the unit to other equipment. To prevent electromagnetic interference with electric appliances such as radios and televisions, use shielded cables and connectors for connections.

D8-10-3a\_En

*Manufactured under license from Dolby Laboratories. "Dolby", "Pro Logic", "Surround EX", and the double-D symbol are trademarks of Dolby Laboratories.*

*"DTS", "DTS-ES Extended Surround" and "Neo:6" are trademarks of Digital Theater Systems, Inc.*

For U.S. and Australia Model



C67-7-3\_En



The lightning flash with arrowhead, within an equilateral triangle, is intended to alert the user to the presence of uninsulated "dangerous voltage" within the product's enclosure that may be of sufficient magnitude to constitute a risk of electric shock to persons.

## CAUTION

RISK OF ELECTRIC SHOCK  
DO NOT OPEN



**CAUTION:**  
TO PREVENT THE RISK OF ELECTRIC SHOCK, DO NOT REMOVE COVER (OR BACK). NO USER-SERVICEABLE PARTS INSIDE. REFER SERVICING TO QUALIFIED SERVICE PERSONNEL.

The exclamation point within an equilateral triangle is intended to alert the user to the presence of important operating and maintenance (servicing) instructions in the literature accompanying the appliance.

D1-4-2-3\_En

# IMPORTANT SAFETY INSTRUCTIONS

**READ INSTRUCTIONS** — All the safety and operating instructions should be read before the product is operated.

**RETAIN INSTRUCTIONS** — The safety and operating instructions should be retained for future reference.

**HEED WARNINGS** — All warnings on the product and in the operating instructions should be adhered to.

**FOLLOW INSTRUCTIONS** — All operating and use instructions should be followed.

**CLEANING** — The product should be cleaned only with a polishing cloth or a soft dry cloth. Never clean with furniture wax, benzene, insecticides or other volatile liquids since they may corrode the cabinet.

**ATTACHMENTS** — Do not use attachments not recommended by the product manufacturer as they may cause hazards.

**WATER AND MOISTURE** — Do not use this product near water — for example, near a bathtub, wash bowl, kitchen sink, or laundry tub; in a wet basement; or near a swimming pool; and the like.

**ACCESSORIES** — Do not place this product on an unstable cart, stand, tripod, bracket, or table. The product may fall, causing serious injury to a child or adult, and serious damage to the product. Use only with a cart, stand, tripod, bracket, or table recommended by the manufacturer, or sold with the product. Any mounting of the product should follow the manufacturer's instructions, and should use a mounting accessory recommended by the manufacturer.

**CART** — A product and cart combination should be moved with care. Quick stops, excessive force, and uneven surfaces may cause the product and cart combination to overturn.



**VENTILATION** — Slots and openings in the cabinet are provided for ventilation and to ensure reliable operation of the product and to protect it from overheating, and these openings must not be blocked or covered. The openings should never be blocked by placing the product on a bed, sofa, rug, or other similar surface. This product should not be placed in a built-in installation such as a bookcase or rack unless proper ventilation is provided or the manufacturer's instructions have been adhered to.

**POWER SOURCES** — This product should be operated only from the type of power source indicated on the marking label. If you are not sure of the type of power supply to your home, consult your product dealer or local power company.

**LOCATION** — The appliance should be installed in a stable location.

**NONUSE PERIODS** — The power cord of the appliance should be unplugged from the outlet when left un-used for a long period of time.

## GROUNDING OR POLARIZATION

- If this product is equipped with a polarized alternating current line plug (a plug having one blade wider than the other), it will fit into the outlet only one way. This is a safety feature. If you are unable to insert the plug fully into the outlet, try reversing the plug. If the plug should still fail to fit, contact your electrician to replace your obsolete outlet. Do not defeat the safety purpose of the polarized plug.

- If this product is equipped with a three-wire grounding type plug, a plug having a third (grounding) pin, it will only fit into a grounding type power outlet. This is a safety feature. If you are unable to insert the plug into the outlet, contact your electrician to replace your obsolete outlet. Do not defeat the safety purpose of the grounding type plug.

**POWER-CORD PROTECTION** — Power-supply cords should be routed so that they are not likely to be walked on or pinched by items placed upon or against them, paying particular attention to cords at plugs, convenience receptacles, and the point where they exit from the product.

**OUTDOOR ANTENNA GROUNDING** — If an outside antenna or cable system is connected to the product, be sure the antenna or cable system is grounded so as to provide some protection against voltage surges and built-up static charges. Article 810 of the National Electrical Code, ANSI/NFPA 70, provides information with regard to proper grounding of the mast and supporting structure, grounding of the lead-in wire to an antenna discharge unit, size of grounding conductors, location of antenna-discharge unit, connection to grounding electrodes, and requirements for the grounding electrode. See Figure A.

**LIGHTNING** — For added protection for this product during a lightning storm or when it is left unattended and unused for long periods of time, unplug it from the wall outlet and disconnect the antenna or cable system. This will prevent damage to the product due to lightning and power-line surges.

**POWER LINES** — An outside antenna system should not be located in the vicinity of overhead power lines or other electric light or power circuits, or where it can fall into such power lines or circuits. When installing an outside antenna system, extreme care should be taken to keep from touching such power lines or circuits as contact with them might be fatal.

**OVERLOADING** — Do not overload wall outlets, extension cords, or integral convenience receptacles as this can result in a risk of fire or electric shock.

**OBJECT AND LIQUID ENTRY** — Never push objects of any kind into this product through openings as they may touch dangerous voltage points or short-out parts that could result in a fire or electric shock. Never spill liquid of any kind on the product.

**SERVICING** — Do not attempt to service this product yourself as opening or removing covers may expose you to dangerous voltage or other hazards. Refer all servicing to qualified service personnel.

**DAMAGE REQUIRING SERVICE** — Unplug this product from the wall outlet and refer servicing to qualified service personnel under the following conditions:

- When the power-supply cord or plug is damaged.
- If liquid has been spilled, or objects have fallen into the product.
- If the product has been exposed to rain or water.
- If the product does not operate normally by following the operating instructions. Adjust only those controls that are covered by the operating instructions as an improper adjustment of other controls may result in damage and will often require extensive work by a qualified technician to restore the product to its normal operation.
- If the product has been dropped or damaged in any way.
- When the product exhibits a distinct change in performance — this indicates a need for service.

**REPLACEMENT PARTS** — When replacement parts are required, be sure the service technician has used replacement parts specified by the manufacturer or have the same characteristics as the original part. Unauthorized substitutions may result in fire, electric shock, or other hazards.

**SAFETY CHECK** — Upon completion of any service or repairs to this product, ask the service technician to perform safety checks to determine that the product is in proper operating condition.

**WALL OR CEILING MOUNTING** — The product should not be mounted to a wall or ceiling.

**HEAT** — The product should be situated away from heat sources such as radiators, heat registers, stoves, or other products (including amplifiers) that produce heat.

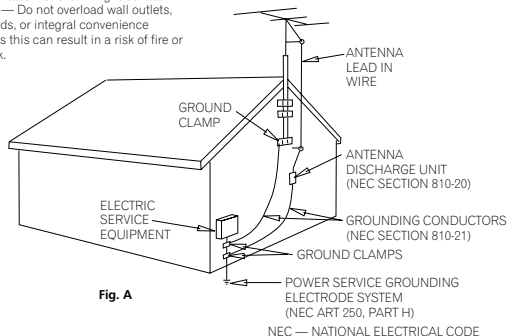

D1-4-2-2\_En

# Contents

## 01 Before you start

Introduction to home theater .....	6
Checking what's in the box .....	6
Loading the batteries .....	7
Installing the receiver .....	7
Ventilation.....	7

## 02 5 minute guide

Listening to Surround Sound .....	8
Using the Quick Setup .....	11

## 03 Quick surround sound setup

Automatically setting up for surround sound (MCACC).....	12
Other problems when using the Auto MCACC Setup .....	14

## 04 Connecting up

Making cable connections .....	15
Analog audio cables.....	15
Digital audio cables .....	15
Video cables .....	15
About the video converter .....	16
Connecting a DVD player and TV .....	17
Connecting the multichannel analog outputs.....	18
Connecting a satellite receiver or other digital set-top box .....	18
Connecting other audio components .....	19
About the WMA9 Pro decoder .....	19
Connecting other video components .....	20
Using the component video jacks.....	21
Connecting to the front panel video terminal .....	21
Connecting antennas .....	22
FM wire antenna.....	22
AM loop antenna .....	22
Using external antennas.....	22
Connecting the speakers .....	23
Hints on speaker placement.....	24
AC outlet.....	25
Operating other Pioneer components.....	26

## 05 Controls and displays

Front panel .....	27
Display .....	29
Remote control.....	30
Operating range of remote control unit .....	33

## 06 Listening to your system

Auto playback .....	34
Listening in surround sound .....	34
Using the Advanced surround effects.....	35
Dolby Pro Logic IIx Music settings .....	36
Neo:6 Music settings .....	36
Listening in stereo.....	37
Listening with Acoustic Calibration EQ.....	37
Choosing the input signal .....	38
Using the surround back channel (Extended mode) .....	39
Using the Virtual Surround Back mode (VirtualSB).....	40
Using Loudness and Midnight listening .....	41
Enhancing dialog .....	41
Using the tone controls.....	41
Playing other sources .....	42
Selecting the multichannel analog inputs .....	42
Using the sleep timer .....	42

## 07 The System Setup menu

Making receiver settings from the System Setup menu.....	43
Surround back speaker setting .....	43
Manual MCACC speaker setup .....	44
Fine Channel Level .....	44
Fine Channel Distance .....	45
Acoustic Calibration EQ .....	46
Manual speaker setup.....	48
Speaker setting.....	48
Crossover network .....	49
Channel level .....	49
Speaker Distance .....	50

## 08 Using the tuner

Listening to the radio.....	51
Improving FM stereo sound .....	51
Tuning directly to a station .....	51
Saving station presets.....	52
Naming station presets.....	52
Listening to station presets.....	53

## 09 Making recordings

Making an audio or a video recording .....	54
--	----

## 10 Controlling the rest of your system

Setting the remote to control other components .....	55
Selecting preset codes directly .....	55
Programming signals from other remote controls .....	56
Erasing one of the remote control button settings .....	57
Erasing all of the remote control presets .....	57
Direct function .....	57
Confirming preset codes .....	58
Controls for TVs .....	59
Controls for other components .....	60

## 11 Other connections

Second Zone speaker B setup .....	62
Switching the speaker system .....	62
Bi-amping your front speakers .....	63
Bi-wiring your speakers .....	63
Connecting additional amplifiers .....	64

Using this receiver with a Pioneer plasma display .....	64
Using the SR+ mode with a Pioneer plasma display .....	65

## 12 Other Settings

The Input Assign menu .....	66
The Other setup menu .....	67
Dynamic Range Control Setup .....	67
Dual Mono Setup .....	67
LFE Attenuator Setup .....	68
SR+ Setup for Pioneer plasma displays .....	68

## 13 Additional information

Troubleshooting .....	69
Resetting the main unit .....	72
Switching the speaker impedance .....	72
Specifications .....	73
Power cord caution .....	74
Cleaning the unit .....	74

## Chapter 1: Before you start

### Introduction to home theater

You are probably used to using stereo equipment to listen to music, but may not be used to home theater systems that give you many more options (such as surround sound) when listening to soundtracks.

Home theater refers to the use of multiple audio tracks to create a surround sound effect, making you feel like you're in the middle of the action or concert. The surround sound you get from a home theater system depends not only on the speakers you have set up in your room, but also on the source and the sound settings of the receiver.

DVD-Video has become the basic source material for home theater due to its size, quality, and ease of use. Depending on the DVD, you can have up to seven different audio tracks coming from one disc, all of them being sent to different speakers in your system. This is what creates a surround sound effect and gives you the feeling of 'being there'.

This receiver will automatically decode Dolby Digital, DTS, or Dolby Surround DVD-Video discs, according to your speaker setup. In most cases, you won't have to make changes for realistic surround sound, but other possibilities (like listening to a CD with multichannel surround sound) are explained in *Listening to your system* on page 34.

### Checking what's in the box

Please check that you've received the following supplied accessories:

- Setup microphone

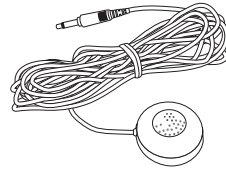

- Remote control unit

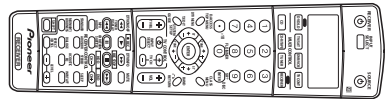

- Dry cell batteries (AA size IEC R6) x2

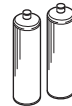

- AM loop antenna



- FM wire antenna



- Warranty card
- These operating instructions

## Loading the batteries

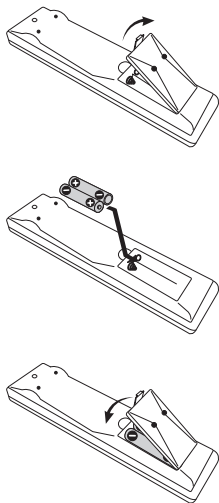

### Caution

Incorrect use of batteries may result in such hazards as leakage and bursting. Observe the following precautions:

- Never use new and old batteries together.
- Insert the plus and minus sides of the batteries properly according to the marks in the battery case.
- Batteries with the same shape may have different voltages. Do not use different batteries together.
- When disposing of used batteries, please comply with governmental regulations or environmental public instruction's rules that apply in your country or area.

## Installing the receiver

- When installing this unit, make sure to put it on a level and stable surface.

Don't install it on the following places:

- on a color TV (the screen may distort)
- near a cassette deck (or close to a device that gives off a magnetic field). This may interfere with the sound.
- in direct sunlight
- in damp or wet areas
- in extremely hot or cold areas
- in places where there is vibration or other movement
- in places that are very dusty
- in places that have hot fumes or oils (such as a kitchen)

## Ventilation

When installing this unit, make sure to leave space around the unit for ventilation to improve heat dispersal (at least 8 in. (20 cm) at the top). If not enough space is provided between the unit and walls or other equipment, heat will build up inside, interfering with performance and/or causing malfunctions.

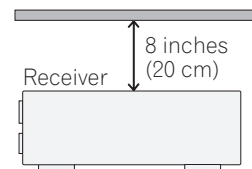

Slot and openings in the cabinet are provided for ventilation and to protect the equipment from overheating. To prevent fire hazard, do not place anything directly on top of the unit, make sure the openings are never blocked or covered with items (such as newspapers, table-cloths and curtains), and do not operate the equipment on thick carpet or a bed.

## Chapter 2: 5 minute guide

### Listening to Surround Sound

This receiver was designed with the easiest possible setup in mind, so with the following quick setup guide, you should have your system hooked up for surround sound in no time at all. In most cases, you can simply leave the receiver in the default settings.

- Be sure to complete all connections before connecting this unit to an AC power source.

#### 1 Hook up your DVD player.

For surround sound, you'll want to hook up using a digital connection from the DVD player to the receiver. You can do this with either a coaxial (recommended), or an optical connection (you don't need to connect both). If you hook up using an optical cable, you should refer to *The Input Assign menu* on page 66 to assign the optical input to **DVD**.

Use a video cord to connect the video output on your DVD player to the receiver using the jacks shown below.

#### 2 Hook up your TV.

Use a video cord to connect your receiver to the TV using the jacks as shown below.

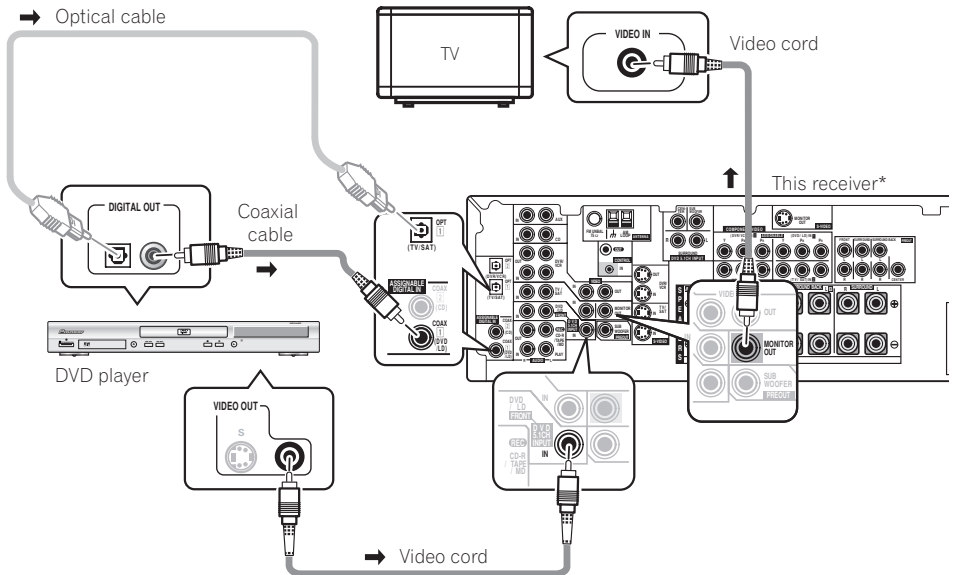

\* The illustration shows the VSX-915, but connections for the VSX-815 are the same.



### 3 Connect your speakers.

A complete setup of eight speakers (including the subwoofer) is shown here but everyone's home setup will vary. Simply connect the speakers you have in the manner shown below.<sup>1</sup> The receiver will work with just two stereo speakers (the front speakers in the diagram) but using at least three speakers is recommended, and a complete setup is best.

Make sure you connect the speaker on the right to the right terminal and the speaker on the left to the left terminal. Also make sure the positive and negative (+/-) terminals on the receiver match those on the speakers. You can use speakers with a nominal impedance between 6–16Ω (please see *Switching the speaker impedance* on page 72 if you plan to use speakers with an impedance of less than 8Ω).

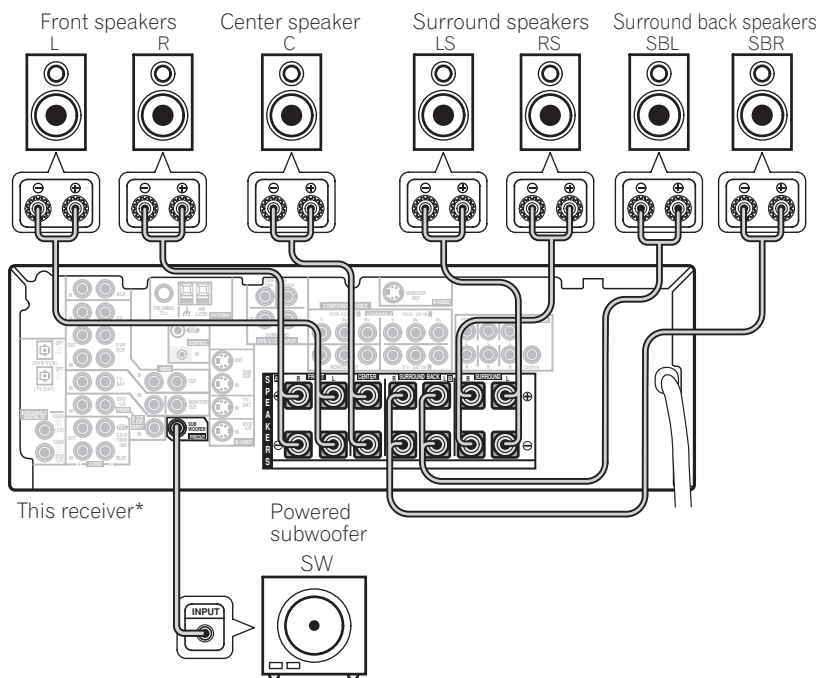

\* The illustration shows the VSX-915, but connections for the VSX-815 are the same.



#### Caution

- Make sure that all the bare speaker wire is twisted together and inserted fully into the speaker terminal. Use good quality speaker wire to connect the speakers to the receiver.

#### Note

- 1 If you're not using a subwoofer, change the front speaker setting (see *Speaker setting* on page 48) to large.
- If you are using only one surround back speaker, connect it to the surround back left (L) terminal.

Make sure that the speaker cable you're using is properly prepared with about  $\frac{3}{8}$  in. (10 mm) of insulator stripped from each wire, with the exposed wire strands twisted together (fig. A). Unscrew the terminal a few turns until there is enough space to insert the exposed wire (fig. B). Once the wire is in position, tighten the terminal until the wire is firmly clamped (fig. C).

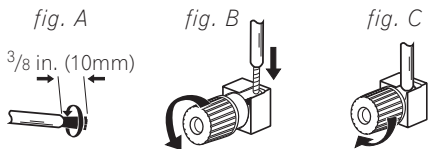

Where you place the speakers will have a big effect on the sound. Place your speakers as shown below for the best surround sound effect. See *Hints on speaker placement* on page 24 for more on this.

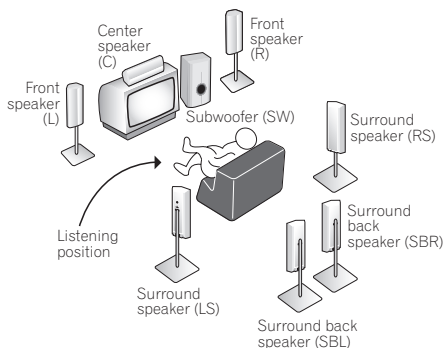

#### 4 Plug in the receiver and switch it on, followed by your DVD player, your subwoofer and the TV.

Make sure you've set the video input on your TV to this receiver. Check the manual that came with the TV if you don't know how to do this.

#### Note

<sup>1</sup> See also *Making receiver settings from the System Setup menu* on page 43 for more setup options.

<sup>2</sup> • You may need to set your DVD player to output Dolby Digital, DTS and 88.2/96kHz PCM (2 channel) audio (see your DVD player's manual for more on this).

<sup>3</sup> Depending on your DVD player or source discs, you may only get digital 2 channel stereo and analog sound. In this case, the listening mode must be set to **STANDARD** (see *Listening in surround sound* on page 34 if you need to do this) if you want multichannel surround sound.

#### 5 Press QUICK SETUP on the front panel to specify your speaker setup, room size and listening position.

Use the **MULTI JOG** dial to select and **ENTER** to confirm your selection. See *Using the Quick Setup* below if you're unsure about the settings.<sup>1</sup>

#### 6 Play a DVD, and adjust the volume to your liking.

Make sure that **DVD/LD** is showing in the receiver's display, indicating that the DVD input is selected. If it isn't, press **DVD/LD** on the remote control to set the receiver to the DVD input.<sup>2</sup>

There are several other sound options you can select. See *Listening to your system* on page 34 for more on this.<sup>3</sup>

## Using the Quick Setup

You can use the Quick Setup to get your system up and running with just a few button presses. The receiver automatically makes the necessary settings after you have selected your speaker setup, room size and listening position. Use the front panel controls for the steps below.

- If you want a more complete setup option, refer to *Automatically setting up for surround sound (MCACC)* on page 12. If you choose to do so, you can skip the Quick Setup.

### 1 If the receiver is off, press

**STANDBY/ON** to turn the power on.

### 2 Press QUICK SETUP.

**SW DET** flashes in the display while the receiver checks your setup for a subwoofer.

**SW YES** or **SW NO** confirms the subwoofer check, then the display prompts you to select your speaker setup.

### 3 Use the MULTI JOG dial to choose your speaker setup.

When a subwoofer was detected in step 2, you can cycle between the following choices:

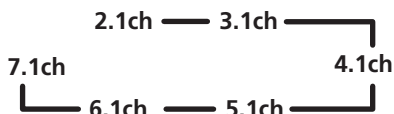

If a subwoofer wasn't detected in step 2, you can cycle between the following choices:

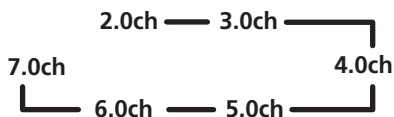

- Check the table below to find the speaker setup that corresponds with your system.

	Front Speakers	Center Speaker	Surround Speakers	Surround Back Sp.	Sub Woofer
<b>2.0 ch</b>	✓				
<b>2.1 ch</b>	✓				✓
<b>3.0 ch</b>	✓	✓			
<b>3.1 ch</b>	✓	✓			✓
<b>4.0 ch</b>	✓		✓		
<b>4.1 ch</b>	✓		✓		✓
<b>5.0 ch</b>	✓	✓	✓		
<b>5.1 ch</b>	✓	✓	✓		✓
<b>6.0 ch</b>	✓	✓	✓	(1 speaker)	
<b>6.1 ch</b>	✓	✓	✓	(1 speaker)	✓
<b>7.0 ch</b>	✓	✓	✓	(2 speakers)	
<b>7.1 ch</b>	✓	✓	✓	(2 speakers)	✓

### 4 Press ENTER.

### 5 Use the MULTI JOG dial to choose your room size.

Depending on the distance of your speakers from the listening position, choose between small, medium, or large (**S**, **M** or **L**), **M** being an average-sized room.

### 6 Press ENTER.

### 7 Use the MULTI JOG dial to choose your listening position.

You can cycle between the following choices:

- FWD** – If you are nearer to the front speakers than the surround speakers
- MID** – If you are equal distance from the front and surround speakers
- BACK** – If you are nearer to the surround speakers than the front speakers

### 8 Press ENTER to confirm your setup.

The display shows the speaker setup, room size and listening position that you have selected.

## Chapter 3:

## Quick surround sound setup

## Automatically setting up for surround sound (MCACC)

The Auto Multi-Channel Acoustic Calibration (MCACC) setup measures the acoustic characteristics of your listening area, taking into account ambient noise, speaker size and distance, and tests for both channel delay and channel level. After you have set up the microphone provided with your system, the receiver uses the information from a series of test tones to optimize the speaker settings<sup>1</sup> and equalization for your particular room.

**Important**

- The Auto MCACC Setup will overwrite any existing speaker settings you've made.
- Make sure the headphones are unplugged.

**Caution**

- The test tones used in the Auto MCACC Setup are output at high volume.

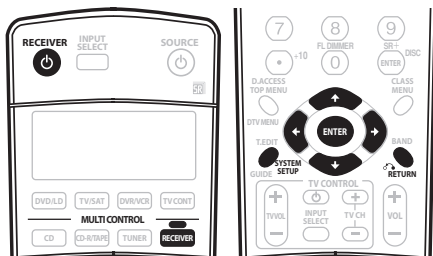
**1 Connect the microphone to the MCACC SETUP MIC jack on the front panel.**

Make sure there are no obstacles between the speakers and the microphone.



If you have a tripod, use it to place the microphone so that it's about ear level at your normal listening position. Otherwise, place the microphone at ear level using a table or a chair.

**2 If the receiver is off, press  $\text{O}$  RECEIVER to turn the power on.****3 If you have a subwoofer, turn it on.****4 Press RECEIVER on the remote control, then press the SYSTEM SETUP button.**

- Press **SYSTEM SETUP** again at any time to exit the System Setup menu.<sup>2</sup>

**5 Select 'A. MCACC' from the System Setup menu then press ENTER.****6 Make sure 'SB NORM.' is selected then press ENTER.<sup>3</sup>**

Try to be as quiet as possible after pressing **ENTER**. The system outputs a series of test tones to establish the ambient noise level.

**Note**

<sup>1</sup> If you are planning on bi-amping your front speakers, or setting up a separate speaker system in another room, read through *Surround back speaker setting* on page 43 and make sure to connect your speakers as necessary before continuing.

<sup>2</sup> The receiver will automatically exit the current menu after three minutes of inactivity. If you cancel the Auto MCACC Setup at any time, the receiver automatically exits and no settings will be made.

<sup>3</sup> If you are planning on bi-amping your front speakers, or setting up a separate speaker system in another room, read through *Surround back speaker setting* and make sure to connect your speakers as necessary before continuing.

## Quick surround sound setup

If the noise level is too high, **NOISY!** blinks in the display for five seconds. To exit and check the noise levels again, press **SYSTEM SETUP** (see the notes about ambient noise below) or press **ENTER** when you're prompted to **RETRY?**

- Do not adjust the volume during the test tones. This may result in incorrect speaker settings.

The system now checks the microphone and your speaker setup.

If you see an **ERR** message in the display, there may be a problem with your mic or the speaker connections. Turn off the power, and check the problem indicated by the **ERR** message (see below), then try the auto surround setup again.

- **ERR MIC** – Check the microphone connection.
- **ERR Fch** – Check the front speaker connections.
- **ERR Sch** – Check the surround speaker connections.
- **ERR SBch** – Check the surround back speaker connections.
- **ERR SW** – Make sure the subwoofer has been switched on and volume on the subwoofer is turned up.

### 7 When you see CHECK OK in the display, confirm your speaker configuration.

Use **↑/↓** (cursor up/down) to check each speaker in turn. **YES** or **NO** should reflect the actual speakers connected. If the speaker configuration displayed isn't correct, use **←/→** (cursor left/right) to change the setting. When you're finished, go to the next step.

### 8 Select CHECK OK in the display then press ENTER.

The Auto MCACC finishes by checking the subwoofer level.

- If the subwoofer output level is too high/low, **SW.VOL.DWN/SW.VOL.UP** blinks in the display for five seconds. To exit and check your subwoofer output level, press **SYSTEM SETUP** or simply press **ENTER** when you're prompted to **RETRY?**

### 9 The Auto MCACC Setup has finished!

The MCACC indicator on the front panel will light to show the surround settings are complete.

The settings made in the Auto MCACC Setup should give you excellent surround sound from your system, but it is also possible to adjust these settings manually using the System Setup menu (starting on page 43).<sup>1</sup>

Optionally, when you see **SKIP?** you can press **←/→** (cursor left/right) to select one of the following options then **↑/↓** (cursor up/down) to check the settings:

- **CHK SP** – Check the size and number of speakers you've connected (see page 48 for more on this)
- **CHK DIST.** – Check the distance of your speakers from the listening position (see page 50 for more on this)
- **CHK LEVEL** – Check the overall balance of your speaker system (see page 49 for more on this)
- **CHK EQ** – Select either **ALL CH** or **F ALIGN** to check the adjustments to the frequency balance of your speaker system based on the acoustic characteristics of your room (see page 46 for more on this)

### 10 When you're finished, select 'SKIP?' to go back to the System Setup menu.

- Remember to disconnect the microphone after completing the Auto MCACC Setup.

#### Note

<sup>1</sup> • Depending on the characteristics of your room, sometimes identical speakers with cone sizes of around 5 inches (12cm) will end up with different size settings. You can correct the setting manually using the *Speaker setting* on page 48.

• The subwoofer distance setting may be farther than the actual distance from the listening position. This setting should be accurate (taking delay and room characteristics into account) and generally does not need to be changed.

### **Other problems when using the Auto MCACC Setup**

If the room environment is not optimal for the Auto MCACC Setup (too much background noise, echo off the walls, obstacles blocking the speakers from the microphone) the final settings may be incorrect. Check for household appliances (air conditioner, fridge, fan, etc.), that may be affecting the environment and switch them off if necessary. If there are any instructions showing in the front panel display, please follow them.

- Some older TVs may interfere with the operation of the microphone. If this seems to be happening, switch off the TV when doing the Auto MCACC Setup.

## Chapter 4: Connecting up

### Making cable connections

Make sure not to bend the cables over the top of this unit (as shown in the illustration). If this happens, the magnetic field produced by the transformers in this unit may cause a humming noise from the speakers.

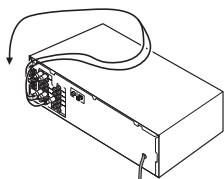

#### Important

- Before making or changing any connections, switch off the power and disconnect the power cord from the AC outlet.

### Analog audio cables

Use stereo RCA phono cables to connect analog audio components. These cables are typically red and white, and you should connect the red plugs to R (right) terminals and white plugs to L (left) terminals.

Analog audio cables

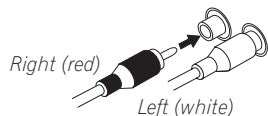

### Digital audio cables

Commercially available coaxial digital audio cables or optical cables should be used to connect digital components to this receiver.

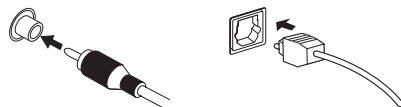

Coaxial digital audio cable

Optical cable

- When connecting optical cables, be careful when inserting the plug not to damage the shutter protecting the optical socket.
- When storing optical cable, coil loosely. The cable may be damaged if bent around sharp corners.
- You can also use a standard RCA video cable for coaxial digital connections.

### Video cables

#### Standard RCA video cables

These cables are the most common type of video connection and should be used to connect to the composite video terminals. They have yellow plugs to distinguish them from cables for audio.

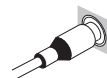

Standard RCA video cable

### S-video cables

S-video cables give you clearer picture reproduction than standard RCA video cables by sending separate signals for the luminance and color.



### Component video cables

Use component video cables to get the best possible color reproduction of your video source. The color signal of the TV is divided into the luminance (**Y**) signal and the color (**Pb** and **Pr**) signals and then output. In this way, interference between the signals is avoided.

Component video cables

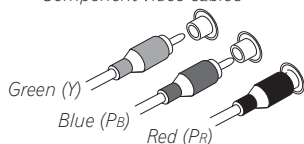

## About the video converter

*V SX-915 model only*

The video converter allows you to connect video sources using composite connections and the signal will be output through both the composite and S-video **MONITOR OUT** jacks<sup>1</sup>. If more than one video component is connected to the same input function, the converter gives priority to the S-video connection.

The following chart shows when the video signal will be converted from the various video inputs (left column) for output to the

**MONITOR OUT** jacks (top row):

Video terminal	MONITOR OUT		
	VIDEO (Composite)	S-VIDEO	COMPONENT VIDEO
VIDEO IN (Composite)	✓	✓	✗
S-VIDEO IN	✗	✓	✗
COMPONENT VIDEO IN	✗	✗	☑

- The ☑ mark above indicates that the component video input must be assigned before it will be output (see *Assigning the component video inputs* on page 66 for more on this).
- When recording video sources, they must be connected using the same type of video cable as you used to connect the recorder to the receiver.
- Also note that this feature is available with NTSC signals only. For PAL signals, make sure you've used the same type of cable for your video component and monitor connections.

### Note

<sup>1</sup> The **COMPONENT VIDEO MONITOR OUT** jacks only output the signal from the component video input.



## Connecting a DVD player and TV

This page shows you how to connect your DVD player and TV to the receiver.

### 1 Connect a coaxial digital audio output on your DVD player to the DIGITAL COAX 1 (DVD/LD) input on this receiver.

Use a coaxial digital audio cable for the connection.<sup>1</sup>

### 2 Connect the composite video output and the stereo analog audio outputs<sup>2</sup> on your DVD player to the DVD/LD inputs on this receiver.

Use a standard RCA video cable<sup>3</sup> and a stereo RCA phono cable for the connection.

- If your DVD player has multichannel analog outputs, see *Connecting the multichannel analog outputs* below for how to connect it.

### 3 Connect the analog audio outputs from your TV to the TV/SAT inputs on this receiver.

This will allow you to play the sound from the TV's built-in tuner. Use a stereo RCA phono cable to do this.

- If your TV has a built-in digital decoder, you can also connect an optical digital audio output from your TV to the **DIGITAL OPT 1 (TV/SAT)** input on this receiver. Use an optical cable for the connection.

### 4 Connect the MONITOR OUT video jack on this receiver to a video input on your TV.

Use a standard RCA video cable to connect to the composite video jack.<sup>4</sup>

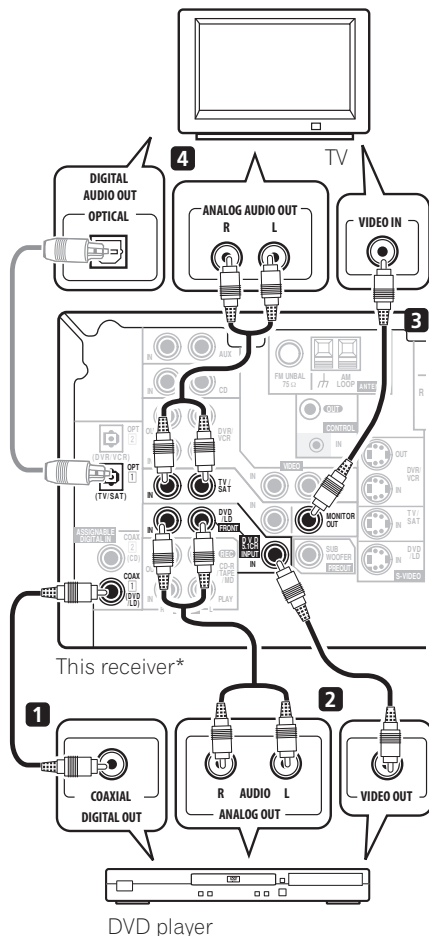

\* The illustration shows the VSX-915, but connections for the VSX-815 are the same.

#### Note

1 If your DVD player only has an optical digital output, you can connect it to the optical input on this receiver using an optical cable. When you set up the receiver you'll need to tell the receiver which input you connected the player to (see *The Input Assign menu* on page 66).

2 This connection will allow you to make analog recordings from your DVD player.

3 For better quality, you can also connect with S-video using the **S-VIDEO DVD/LD** jack. If your player also has a component video output, you can connect this too. See *Using the component video jacks* on page 21 for more on this.

4 For better quality, you can also connect with S-video using the **S-VIDEO MONITOR OUT** jack. See *Using the component video jacks* on page 21 if you want to use the component video outputs to connect this receiver to your TV.

## Connecting the multichannel analog outputs

For DVD Audio and SACD playback, your DVD player may have 5.1 channel analog outputs. In this case, you can connect the multichannel analog outputs to the multichannel inputs of this receiver as shown below.<sup>1</sup>

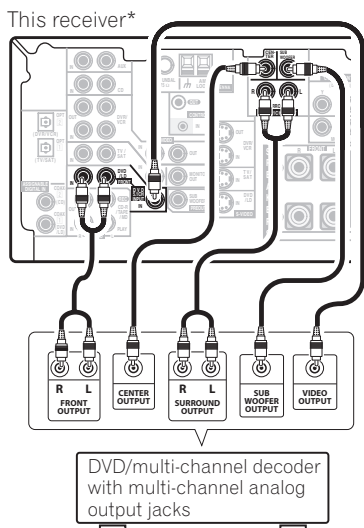

\* The illustration shows the VSX-915, but connections for the VSX-815 are the same.

## Connecting a satellite receiver or other digital set-top box

Satellite and cable receivers, and terrestrial digital TV tuners are all examples of so-called 'set-top boxes'.

**1** Connect a set of audio/video outputs on the set-top box component to the TV/SAT AUDIO and VIDEO inputs on this receiver.<sup>2</sup> Use a stereo RCA phono cable for the audio connection and a standard RCA video cable for the video connection.<sup>3</sup>

**2** Connect an optical digital audio output from your set-top box component to the DIGITAL OPT 1 (TV/SAT) input on this receiver. Use an optical cable for the connection.<sup>4</sup>

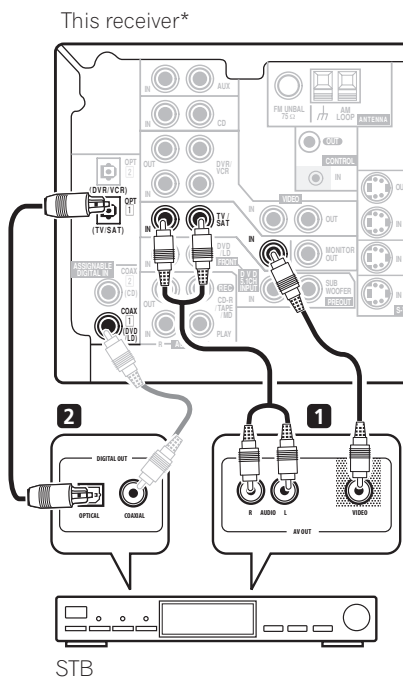

\* The illustration shows the VSX-915, but connections for the VSX-815 are the same.

### Note

<sup>1</sup> The multichannel input can only be used when **DVD 5.1 ch** is selected (see page 42).

<sup>2</sup> If you've already connected your TV to the **TV/SAT** inputs, simply choose another input. However, to receive a signal, you'll need to press the input select button for the input you connected the set-top box to.

<sup>3</sup> For better quality, you can also connect with S-video using the **S-VIDEO TV/SAT** jack. If your set-top box also has a component video output, you can connect this too. See *Using the component video jacks* on page 21 for more on this.

<sup>4</sup> If your satellite/cable receiver doesn't have a digital audio output, omit this step. If it only has a coaxial digital output, you can connect it to one of the coaxial inputs on this receiver using a coaxial digital audio cable. When you set up the receiver you'll need to tell the receiver which input you connected the set-top box to (see *The Input Assign menu* on page 66).

## Connecting other audio components

The number and kind of connections depends on the kind of component you're connecting.<sup>1</sup> Follow the steps below to connect a CD-R, MD, DAT, tape recorder or other audio component.

**1 If your component has a digital output, connect this to a digital input on the receiver as shown.**

The example shows a coaxial connection to the **CD** digital input jack using a coaxial digital audio cable.

**2 If necessary, connect the analog audio outputs of the component to a set of spare audio inputs on this receiver.**

You'll need to make this connection for components without a digital output, or if you want to record from a digital component. Use a stereo RCA phono cable as shown.

**3 If you're connecting a recorder, connect the analog audio outputs (REC) to the analog audio inputs on the recorder.**

The example shows an analog connection to the **CD-R/TAPE/MD** analog output jack using a stereo RCA phono cable.

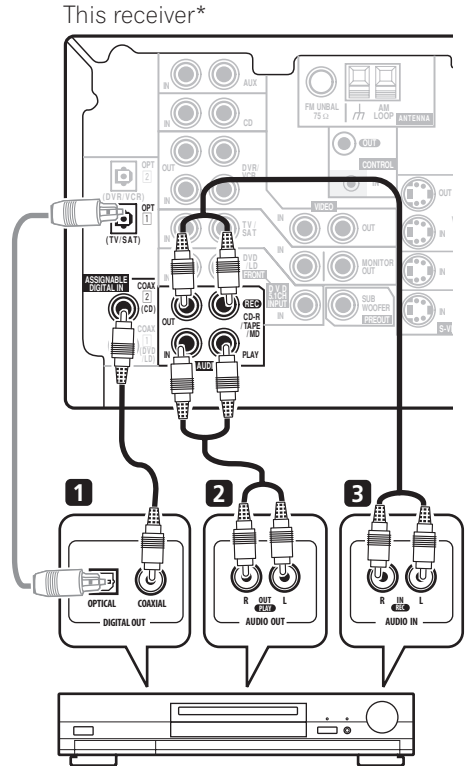

CD-R, MD, DAT, Tape recorder, etc.

\* The illustration shows the VSX-915, but connections for the VSX-815 are the same.

## About the WMA9 Pro decoder

This unit has an on-board Windows Media<sup>®</sup> Audio 9 Professional (WMA9 Pro) decoder, so it is possible to playback WMA9 Pro-encoded audio using a coaxial or optical digital connection when connected to a WMA9 Pro-

**Note**

<sup>1</sup> Note that you must connect digital components to analog audio jacks if you want to record to/from digital components (like an MD) to/from analog components.

compatible player. However, the connected PC, DVD player, set-top box, etc. must be able to output WMA9 Pro format audio signals through a coaxial or optical digital output.



*Microsoft, Windows Media®, and the Windows logo are trademarks, or registered trademarks of Microsoft Corporation in the United States and/or other countries.*

## Connecting other video components

This receiver has audio/video inputs and outputs suitable for connecting analog or digital video recorders, including VCRs, DVD-recorders and HDD recorders.

### 1 Connect a set of audio/video outputs on the recorder to the DVR/VCR AUDIO and VIDEO inputs on this receiver.

Use a stereo RCA phono cable for the audio connection and a standard RCA video cable for the video connection.<sup>1</sup>

### 2 Connect a set of audio/video inputs on the recorder to the DVR/VCR AUDIO and VIDEO outputs on this receiver.

Use a stereo RCA phono cable for the audio connection and a standard RCA video cable for the video connection.<sup>2</sup>

### 3 If your video component has a digital audio output, connect it to a digital input on this receiver.

The example shows a recorder connected to the **DIGITAL COAX 1 (DVD/LD)** input.<sup>3</sup>

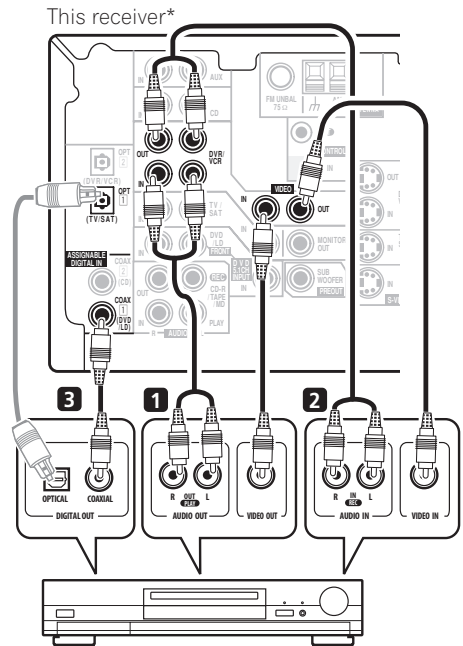

VCR, DVR, LD player, etc.

\* The illustration shows the VSX-915, but connections for the VSX-815 are the same.

#### Note

<sup>1</sup> For better quality, you can also connect with S-video using the **S-VIDEO DVR/VCR IN** jack. If your set-top box also has a component video output, you can connect this too. See *Using the component video jacks* on page 21 for more on this.

<sup>2</sup> For better quality, you can also connect with S-video using the **S-VIDEO DVR/VCR OUT** jack.

<sup>3</sup> If your video component doesn't have a digital audio output, omit this step. If it only has an optical digital output, you can connect it to the optical input on this receiver using an optical cable. When you set up the receiver you'll need to tell the receiver which input you connected the component to (see *The Input Assign menu* on page 66).

## Using the component video jacks

Component video should deliver superior picture quality when compared to composite video. A further advantage (if your source and TV are both compatible) is progressive-scan video, which delivers a very stable, flicker-free picture. See the manuals that came with your TV and source component to check whether they are compatible with progressive-scan video.



### Important

- If you connect any source component to the receiver using a component video input, you must also have your TV connected to this receiver's **COMPONENT VIDEO MONITOR OUT** jacks.

### 1 Connect the component video outputs of your source to a set of component video inputs on this receiver.

Use a three-way component video cable for the connection.

### 2 If necessary, assign the component video inputs to the input source you've connected.

This only needs to be done if you didn't connect according to the following defaults:

- **COMP 1 – DVD**
- **COMP 2 – TV**
- **COMP 3 – DVR**

See *Assigning the component video inputs* on page 66 for more on this.

### 3 Connect the COMPONENT VIDEO MONITOR OUT jacks on this receiver to the component video inputs on your TV or monitor.

Use a three-way component video cable.

## Connecting to the front panel video terminal

Front video connections are accessed via the front panel using the **VIDEO** button. There are standard audio/video jacks as well as an S-video jack and an optical input. Hook them up the same way you made the rear panel connections.

This receiver

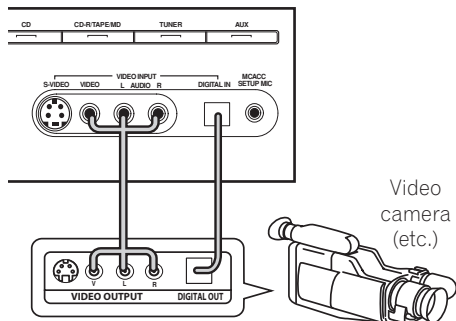

## Connecting antennas

Connect the AM loop antenna and the FM wire antenna as shown below. To improve reception and sound quality, connect external antennas (see *Using external antennas* below). Always make sure that the receiver is switched off and unplugged from the wall outlet before making or changing any connections.

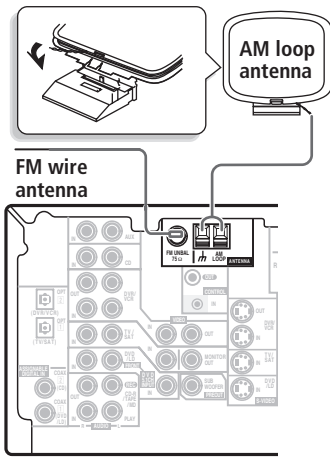

### FM wire antenna

Connect the FM wire antenna and fully extend vertically along a window frame or another suitable place that gives good reception.

### AM loop antenna

Assemble the antenna and connect to the receiver. Attach (if necessary) and face in the direction that gives the best reception.

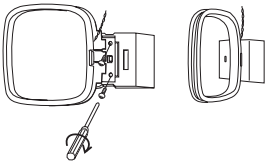

### Antenna snap connectors

Twist the exposed wire strands together and insert into the hole, then snap the connector shut.

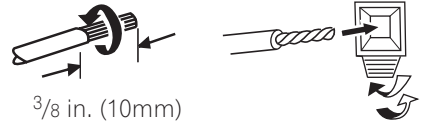

### Using external antennas

#### To improve FM reception

Use an F connector to connect an external FM antenna.

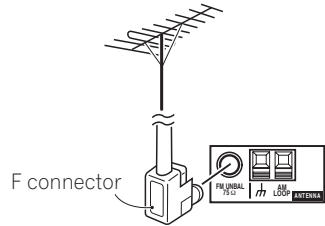

#### To improve AM reception

Connect a 15–18 foot length of vinyl-coated wire to the AM antenna terminal without disconnecting the supplied AM loop antenna.

For the best possible reception, suspend horizontally outdoors.

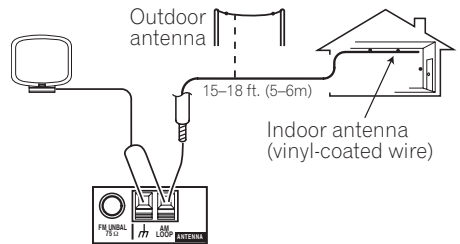

## Connecting the speakers

A complete setup of eight speakers (including the subwoofer) is shown here but everyone's home setup will vary. Simply connect the speakers you have in the manner shown below.<sup>1</sup> The receiver will work with just two stereo speakers (the front speakers in the diagram) but using at least three speakers is recommended, and a complete setup is best.

Make sure you connect the speaker on the right to the right terminal and the speaker on the left to the left terminal. Also make sure the positive and negative (+/-) terminals on the receiver match those on the speakers.<sup>2</sup> You can use speakers with a nominal impedance between 6–16Ω (please see *Switching the speaker impedance* on page 72 if you plan to use speakers with an impedance of less than 8Ω).

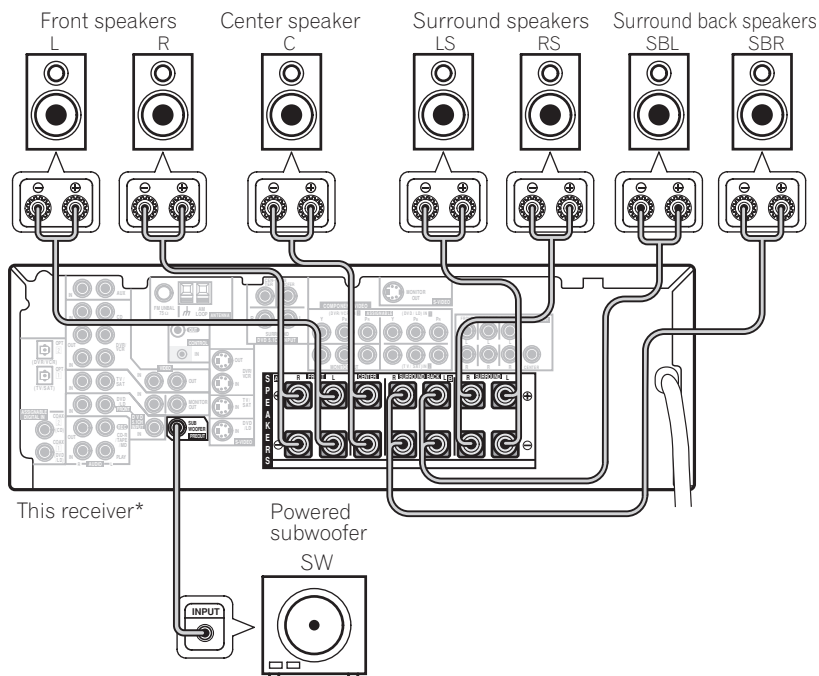

\* The illustration shows the VSX-915, but connections for the VSX-815 are the same.



### Caution

- Make sure that all the bare speaker wire is twisted together and inserted fully into the speaker terminal. Use good quality speaker wire to connect the speakers to the receiver.

### Note

- 1 If you're not using a subwoofer, change the front speaker setting (see *Speaker setting* on page 48) to large.
- 2 If you are using only one surround back speaker, connect it to the surround back left (L) terminal.

Make sure that the speaker cable you're using is properly prepared with about  $\frac{3}{8}$  in. (10 mm) of insulator stripped from each wire, with the exposed wire strands twisted together (*fig. A*). Unscrew the terminal a few turns until there is enough space to insert the exposed wire (*fig. B*). Once the wire is in position, tighten the terminal until the wire is firmly clamped (*fig. C*).

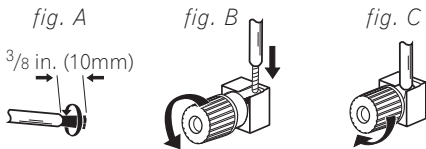

- The speaker terminals also accept single banana plugs. (Refer to speaker manual for details.)

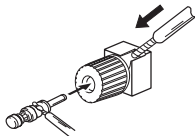

### Caution

- These speaker terminals are hazardous when live. To prevent the risk of electric shock when connecting or disconnecting the speaker cables, disconnect the power cord.

## Hints on speaker placement

Speakers are usually designed with a particular placement in mind. Some are designed to be floorstanding, while others should be placed on stands to sound their best. Some should be placed near a wall; others should be placed away from walls. We have provided a few tips on getting the best sound from your speakers (following), but you should also follow the guidelines on placement that the speaker manufacturer provided with your particular speakers to get the most out of them.

- Place the front left and right speakers at equal distances from the TV.
- When placing speakers near the TV, we recommend using magnetically shielded speakers to prevent possible interference, such as discoloration of the picture when the TV is switched on. If you do not have magnetically shielded speakers and notice discoloration of the TV picture, move the speakers farther away from the TV.
- If you're using a center speaker, place the front speakers at a wider angle. If not, place them at a narrower angle.
- Place the center speaker above or below the TV so that the sound of the center channel is localized at the TV screen. Also, make sure the center speaker does not cross the line formed by the leading edge of the front left and right speakers.
- It is best to angle the speakers towards the listening position. The angle depends on the size of the room. Use less of an angle for bigger rooms.
- Surround and surround back speakers should be positioned a foot-and-a-half to three feet (60 cm–90 cm) higher than your ears and tilted slightly downward. Make sure the speakers don't face each other.
- To achieve the best possible surround sound, install your speakers as shown below. Be sure all speakers are installed securely to prevent accidents and improve sound quality.



### Caution

- If you choose to install the center speaker on top of the TV, be sure to secure it with putty, or by other suitable means, to reduce the risk of damage or injury resulting from the speaker falling from the TV in the event of external shocks such as earthquakes.



- Make sure no exposed speaker wire is touching the rear panel, this may cause the receiver to turn off automatically.

### Overhead view of speaker setup

You can also refer to the 3-D speaker setup illustration on page 10.

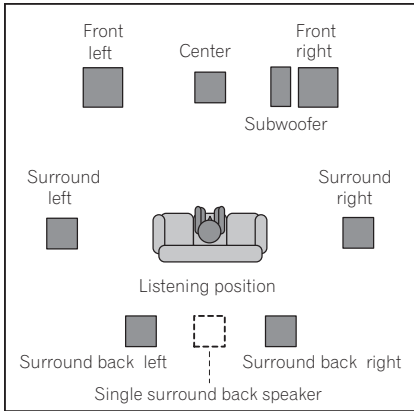

The diagrams below show suggested surround and surround back speaker orientation. The first diagram (fig. A) shows orientation with one surround back speaker (or none) connected. The second (fig. B) shows orientation with two surround back speakers connected.

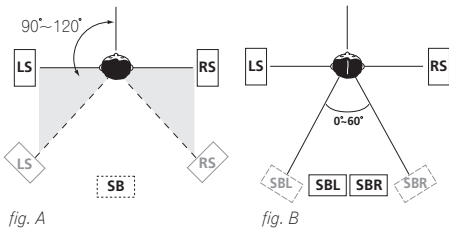

### 3-D view of 7.1 channel speaker setup

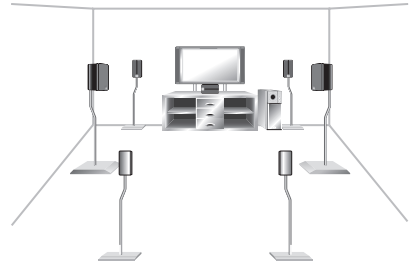

### AC outlet

Power supplied through this outlet is turned on and off by the receiver's power switch. Total electrical power consumption of connected equipment should not exceed 100 W (0.8 A).

- This unit should be disconnected by removing the power plug from the wall socket when not in regular use (ex. when on vacation).

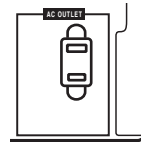

### Caution

- Do not connect a TV set, monitor, heater, or similar appliance to this unit's AC outlet.
- Do not connect appliances with high power consumption to the AC outlet in order to avoid overheating and fire risk. This can also cause the receiver to malfunction.
- Since a subwoofer or power amplifier can exceed the 100W maximum when playing sources at a high volume, this type of equipment should not be connected to the AC outlet.

## Operating other Pioneer components

Many Pioneer components have SR **CONTROL** jacks which can be used to link components together so that you can use just the remote sensor of one component. When you use a remote control, the control signal is passed along the chain to the appropriate component.<sup>1</sup>

Note that if you use this feature, *make sure that you also have at least one set of analog audio or video jacks connected to another component for grounding purposes.*

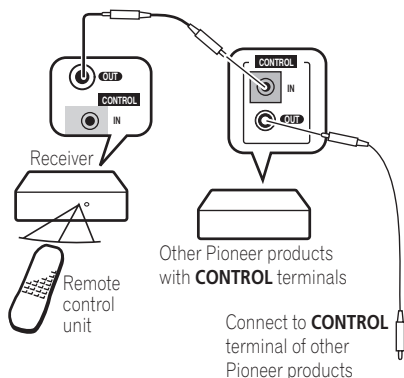

### Note

- 1 • If you want to control all your components using this receiver's remote control, refer to *Controlling the rest of your system* on page 55.
- If you have connected a remote control to the **CONTROL IN** jack (using a mini-plug cable), you won't be able to control this unit using the remote sensor.

# Chapter 5: Controls and displays

## Front panel

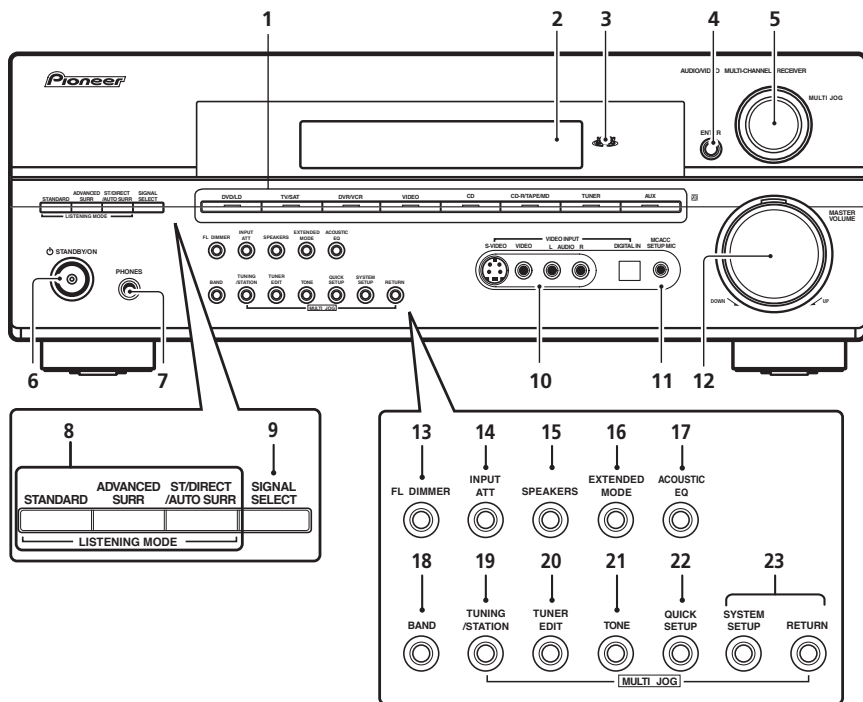

### 1 Input select buttons

Press to select an input source.

### 2 Character display

See *Display* on page 29.

### 3 MCACC indicator

Lights when Acoustic Calibration EQ (page 37) is on (Acoustic Calibration EQ is automatically set to **ALL CH ADJUST** after the Auto MCACC Setup (page 12) or EQ Auto Setup (page 46) is complete).

### 4 ENTER

### 5 MULTI JOG dial

Use the **MULTI JOG** dial to select various settings and menu options.

### 6 STANDBY/ON

Switches the receiver between on and standby.

**7 PHONES jack**

Use to connect headphones. When the headphones are connected, there is no sound output from the speakers.

**8 LISTENING MODE buttons****STANDARD**

Press for Standard decoding and to switch between the various Pro Logic IIx and Neo:6 options (page 34).

**ADVANCED SURROUND**

Use to switch between the various surround modes (page 35).

**STEREO/DIRECT (AUTO SURR)**

Switches between direct and stereo playback. Direct playback bypasses the tone controls and any other signal processing for the most accurate reproduction of a source (page 37). Also selects the Auto Surround mode (*Auto playback* on page 34).

**9 SIGNAL SELECT**

Use to select an input signal (page 38).

**10 VIDEO INPUT**

See *Connecting to the front panel video terminal* on page 21.

**11 MCACC SETUP MIC jack**

Use to connect the supplied microphone.

**12 MASTER VOLUME dial****13 FL DIMMER**

Dims or brightens the display.

**14 INPUT ATT**

Attenuates (lowers) the level of an analog input signal to prevent distortion.

**15 SPEAKERS**

Use to change the speaker system (page 62) and to change the impedance setting (page 72).

**16 EXTENDED MODE**

Selects the surround back channel mode (page 39) or virtual surround back mode (page 40).

**17 ACOUSTIC EQ**

Press to select an Acoustic Calibration EQ setting (page 37).

**18 BAND**

Switches between the tuner AM and FM bands (page 51).

**19 TUNING / STATION buttons**

Selects the frequency (page 51) and station presets (page 52) when using the tuner.

**20 TUNER EDIT**

Press to memorize and name a station for recall (page 52).

**21 TONE**

Press this button to access the bass and treble controls, which you can then adjust with the **MULTI JOG** dial (page 41).

**22 QUICK SETUP**

See *Using the Quick Setup* on page 11.

**23 System Setup menu controls****SYSTEM SETUP**

Use with the **MULTI JOG** dial to access the System Setup menu (page 11, page 43, page 66).

**RETURN**

Press to confirm and exit the current menu.

## Display

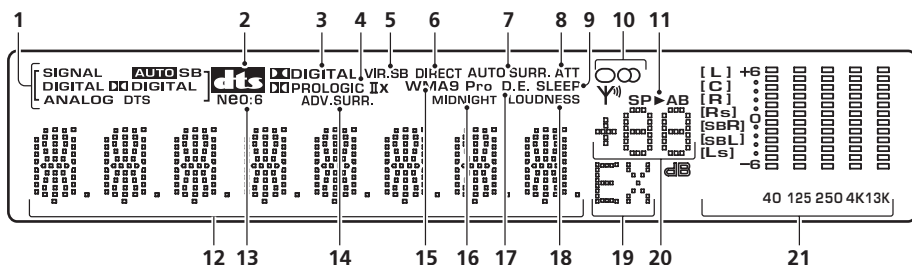

### 1 SIGNAL SELECT indicators

Lights to indicate the type of input signal:

#### AUTO

Lights when **AUTO** signal select is on.

#### SB

Depending on the source, this lights when a signal with surround back channel encoding is detected.

#### DIGITAL

Lights when a digital audio signal is detected.

#### DIGITAL

Lights when a Dolby Digital encoded signal is detected.

#### ANALOG

Lights when an analog signal is detected.

#### DTS

Lights when a source with DTS encoded audio signals is detected.

### 2

When the **STANDARD** mode is on, this lights to indicate decoding of a DTS multichannel signal.

### 3 DIGITAL

When the **STANDARD** mode of the receiver is on, this lights to indicate decoding of a Dolby Digital multichannel signal.

### 4 PRO LOGIC IIx

When the (**STANDARD**) Pro Logic II mode of the receiver is on, **PRO LOGIC II** lights to indicate Pro Logic II decoding. **PRO LOGIC IIx** lights to indicate Pro Logic IIx decoding (see *Listening in surround sound* on page 34).

### 5 VIR.SB

Lights during Virtual surround back processing (page 40).

### 6 DIRECT

Lights when source direct playback is in use. Direct playback bypasses the tone controls and channel levels for the most accurate reproduction of a source.

### 7 AUTO SURR.

Lights when the Auto Surround feature is switched on (see *Auto playback* on page 34).

### 8 ATT

Lights when **INPUT ATT** is used to attenuate (reduce) the level of the analog input signal.

### 9 SLEEP

Lights when the sleep mode is active (page 42).

### 10 Tuner indicators



Lights when the mono mode is set using the **MPX** button.



Lights when a stereo FM broadcast is being received in auto stereo mode.



Lights when a broadcast is being received.

### 11 Speaker indicators

Lights to indicate the current speaker system, **A** and/or **B** (page 62).

### 12 Character display

### 13 Neo:6

When the (**STANDARD**) Neo:6 mode of the receiver is on, this lights to indicate Neo:6 processing.

### 14 ADV.SURR. (Advanced Surround)

Lights when one of the Advanced Surround modes has been selected.

### 15 WMA9 Pro

Lights to indicate decoding of a WMA9 Pro signal.

### 16 MIDNIGHT

Lights during Midnight listening (page 41).

### 17 D.E.

Lights when Dialog Enhancement (**DIALOG E**) is switched on (page 41).

### 18 LOUDNESS

Lights during Loudness listening (page 41).

### 19 EX

Lights when a Dolby Digital Surround EX encoded signal is detected.

### 20 Master volume level

Shows the overall volume level. **---dB** indicates the minimum level, and **- 0 dB** indicates the maximum level.

Depending on your level settings for each channel, the maximum volume can range between **-10 dB** and **-0 dB**.

### 21 MCACC channel EQ indicators

These indicators show the EQ balance for each channel when checking your Acoustic Calibration EQ settings. See *Checking your Acoustic Calibration EQ settings* on page 47 for more on this.

## Remote control

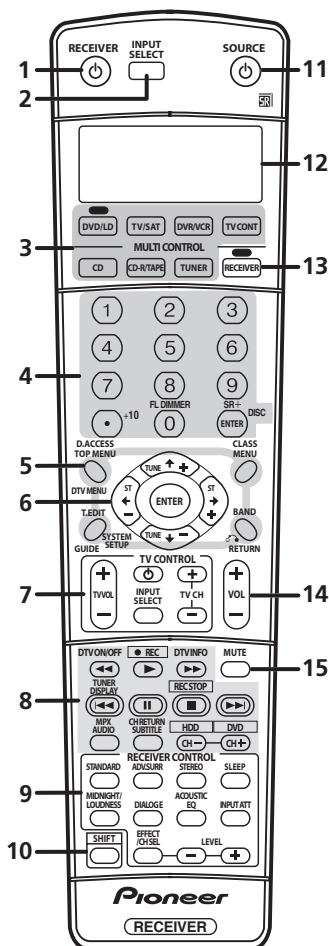

### 1 RECEIVER

This switches between standby and on for this receiver.

### 2 INPUT SELECT

Use to select the input source.

### 3 MULTI CONTROL buttons

Press to select control of other components (see *Controlling the rest of your system* on page 55).

### 4 Number buttons and other receiver/component controls

Use the number buttons to directly select a radio frequency (page 51) or the tracks on a CD, DVD, etc.

**DISC (ENTER)** can be used to enter commands for TV or DTV, and can also be used to select a disc in a multi-CD player.

The following are accessed by pressing the **RECEIVER** button first:

#### FL DIMMER

Dims or brightens the display.

#### SR+

Switches the SR+ mode on/off (page 65).

### 5 Tuner/component control buttons/ SYSTEM SETUP

The following button controls (except **SYSTEM SETUP**) can be accessed after you have selected the corresponding **MULTI CONTROL** button (**TUNER**, **DVD/LD**, **TV/SAT**, etc.)

#### D. ACCESS

After pressing, you can access a radio station directly using the number buttons (page 51).

#### TOP MENU

Displays the disc 'top' menu of a DVD.

#### DTV MENU

Displays menus on a digital TV.

#### T. EDIT

Press to memorize and name a station for recall (page 52).

#### GUIDE

Displays the guides on a digital TV.

#### SYSTEM SETUP

(Press **RECEIVER** first to access)

Use to access the System Setup menu (see page 43).

#### CLASS

Switches between the three banks (classes) of radio station presets (page 52).

#### MENU

Displays the disc menu of DVD-Video discs. It also displays TV and DTV menus.

#### BAND

Switches between the tuner AM and FM bands (page 51).

#### RETURN

Press to confirm and exit the current menu (also use to return to the previous menu with DVDs or to select closed captioning with DTV).

### 6 ←→ ↓↑ (TUNE/ST +/-) /ENTER

Use the arrow buttons when setting up your surround sound system (see page 43). Also used to control DVD menus/options and for deck 1 of a double cassette deck player. Use the **TUNE +/-** buttons to find radio frequencies and use **ST +/-** to find preset stations (page 52).

### 7 TV CONTROL buttons

These buttons are dedicated to control the TV assigned to the **TV CONT** button. Thus if you only have one TV to hook up to this system assign it to the **TV CONT MULTI CONTROL** button. If you have two TVs, assign the main TV to the **TV CONT** button (see page 55 for more on this).

#### TV ⏻

Use to turn on/off the power of the TV.

#### TV VOL +/-

Use to adjust the volume on your TV.

#### INPUT SELECT

Use to select the TV input signal.

#### TV CH +/-

Use to select channels.

## 8 Component control buttons

The main buttons (▶, ■, etc.) are used to control a component after you have selected it using the **MULTI CONTROL** buttons.

The controls above these buttons can be accessed after you have selected the corresponding **MULTI CONTROL** button (for example **DVD/LD**, **DVR/VCR** or **TV/SAT** (when connected to a DTV)).

### DTV ON/OFF

Switches a digital TV on/off.

### DTV INFO

Use to bring up information screens on a digital TV.

### TUNER DISPLAY

Switches between named station presets and radio frequencies (page 53).

### MPX

Switches between stereo and mono reception of FM broadcasts. If the signal is weak then switching to mono will improve the sound quality (page 51).

### AUDIO

Changes the audio language or channel on DVD discs.

### CH RETURN

Returns to the last channel selected with DTV, SAT and some TVs.

### SUBTITLE

Displays/changes the subtitles included in multilingual DVD-Video discs.

### CH +/-

Use to select channels when using a TV, VCR, DVR, etc.

The following DVR controls can be accessed by pressing **SHIFT**:

#### ● REC

Starts recording.

#### REC STOP

Stops recording.

## HDD/DVD

These buttons switch between the hard disk and DVD controls for DVD/HDD recorders.

## 9 RECEIVER CONTROL buttons

### STANDARD

Press for Standard decoding and to switch between the various Pro Logic IIx and Neo:6 options (page 34).

### ADV. SURR

Use to switch between the various surround modes (page 35).

### STEREO

Switches between direct and stereo playback. Direct playback bypasses the tone controls and any other signal processing for the most accurate reproduction of a source (page 37). Also selects the Auto Surround mode (*Auto playback* on page 34).

### SLEEP

Use to put the receiver in sleep mode and select the amount of time before the receiver turns off (page 42).

### MIDNIGHT/LOUDNESS

Use Midnight when listening to movie soundtracks at low volume. Use Loudness to boost the bass and treble at low volume (page 41).

### DIALOG E

Use to make dialog stand out when watching TV or a movie (page 41).

### ACOUSTIC EQ

Press to select an Acoustic Calibration EQ setting (page 37).

### INPUT ATT

Attenuates (lowers) the level of an analog input signal to prevent distortion.



## EFFECT/CH SEL

Press repeatedly to select a channel, then use **LEVEL +/-** to adjust the level (see *Tip* on page 50). Also adjusts the level of the Advanced Surround effects (page 35) as well as Dolby Pro Logic IIx Music (page 36) and Neo:6 Music parameters (page 36). You can then use the **LEVEL +/-** buttons to make these adjustments.

## LEVEL +/-

Use to adjust the effect and channel levels, as well as to change Dolby Pro Logic IIx and Neo:6 Music parameter settings.

## 10 SHIFT

Press to access the DVR controls (above the component control buttons) as well as some **RECEIVER** controls.

## 11 SOURCE

Press to turn on/off other components connected to the receiver (see page 55 for more on this).

## 12 Character display (LCD)

This display shows information when transmitting control signals.

The following commands are shown when you're setting the remote to control other components (see *Controlling the rest of your system* on page 55):

### SETUP

Indicates the setup mode, from which you choose the options below.

### PRESET

See *Selecting preset codes directly* on page 55.

### LEARN

See *Programming signals from other remote controls* on page 56.

### DIRECT F

See *Direct function* on page 57.

## ERASE

See *Erasing one of the remote control button settings* on page 57.

## RESET

See *Erasing all of the remote control presets* on page 57.

## READ ID

See *Confirming preset codes* on page 58.

## 13 RECEIVER

Switches the remote to control the receiver (used to select the green commands above the number buttons (**FL DIMMER**, etc). Also use this button to set up surround sound (page 11, page 43).

## 14 VOL +/-

Use to set the listening volume.

## 15 MUTE

Mutes the sound or restores the sound if it has been muted (adjusting the volume also restores the sound).

## Operating range of remote control unit

The remote control may not work properly if:

- There are obstacles between the remote control and the receiver's remote sensor.
- Direct sunlight or fluorescent light is shining onto the remote sensor.
- The receiver is located near a device that is emitting infrared rays.
- The receiver is operated simultaneously with another infrared remote control unit.

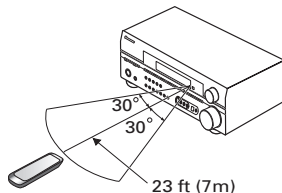

## Chapter 6:

## Listening to your system

**Important**

- Certain features explained in this section will not be possible depending on the source (for example, PCM 88.2 / 96kHz, DTS 96kHz (24 bit) or WMA 9 Pro sources).

**Auto playback**

There are many ways to listen back to sources using this receiver, but for the simplest, most direct listening option is the Auto Surround feature. With this, the receiver automatically detects what kind of source you're playing and selects multichannel or stereo playback as necessary.<sup>1</sup>

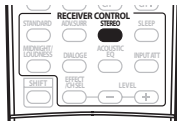

- **While listening to a source, press STEREO for auto playback of a source.**

Press repeatedly until **AUTO SURR.** shows briefly in the display (it will then show the decoding or playback format). Check the digital format indicators in the display to see how the source is being processed.

**Listening in surround sound**

Using this receiver, you can listen to any source in surround sound. However, the options available will depend on your speaker setup and the type of source you're listening to.

If you connected surround back speakers, see also *Using the surround back channel (Extended mode)* on page 39.<sup>2</sup>

The following modes provide basic surround sound for stereo and multichannel sources.

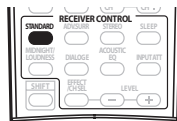

- **While listening to a source, press STANDARD.**

If necessary, press repeatedly to select a listening mode.

- If the source is Dolby Digital, DTS, or Dolby Surround encoded, the proper decoding format will automatically be selected and shows in the display.<sup>3</sup>

With two channel sources, you can select from:

- **Pro Logic IIx MOVIE** – Up to 7.1 channel sound, especially suited to movie sources

**Note**

1 • Stereo surround (matrix) formats are decoded accordingly using **Neo:6 CINEMA** or **Pro Logic IIx MOVIE** (see *Listening in surround sound* above for more on these decoding formats).

2 If the Extended mode (page 39) is switched to **OFF**, or the surround back speakers are set to **NO** (this happens automatically if the *Surround back speaker setting* on page 43 is set to anything but **SB NORM.**), **Pro Logic IIx** becomes **Pro Logic II** (5.1 channel sound).

3 If the Extended mode (page 39) is switched to **OFF**, or the surround back speakers are set to **NO** (page 42), **Pro Logic IIx** becomes **Pro Logic II** (5.1 channel sound).



surround sound. Use with Dolby Pro Logic for a stereo surround effect. You can also use with Dolby Digital sources for a wider stereo field than the Standard modes.

- **7-STEREO** – This can be selected to give multichannel sound to a stereo source, using all of the speakers in your setup.
- **VIR. SURR** – Creates a virtual surround effect using just the subwoofer and front speakers.
- **PHONES SURROUND** – When listening through headphones, you can still get the effect of overall surround.



### Tip

- When an Advanced Surround listening mode is selected, the effect level can be adjusted in the range of **10** to **90** by pressing **EFFECT/CH SEL** (until **EFFECT** shows in the display). The effect level can be set for each Advanced Surround mode by pressing **+/-**.

## Dolby Pro Logic IIx Music settings

When listening to 2-channel sources in Dolby Pro Logic IIx Music mode, there are three further parameters you can adjust: Center Width, Dimension, and Panorama.<sup>1</sup>

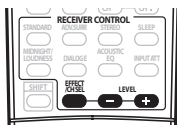

**1 With 'Dolby Pro Logic IIx MUSIC' mode active, press EFFECT/CH SEL repeatedly to select 'C WIDTH', 'DIMEN.' or 'PNRM'.**

- **C WIDTH** – Center Width provides a better blend of the front speakers by spreading the center channel between the front right and left speakers, making it sound wider (higher settings) or narrower (lower settings). (This is applicable only when using a center speaker.)
- **DIMEN.** – Dimension adjusts the depth of the surround sound balance from front to back, making the sound more distant (minus settings), or more forward (positive settings).
- **PNRM.** – Panorama extends the front stereo image to include the surround speakers for a 'wraparound' effect.

**2 Use the +/- buttons to adjust the setting.**

Center Width is adjustable between **0** and **7** (default : **3**); Dimension between **-3** and **+3** (default : **0**); Panorama is **On** or **Off** (default : **Off**).

**3 Press EFFECT/CH SEL again to adjust other settings.**

## Neo:6 Music settings

- Default setting: **3**

When listening to 2-channel sources in Neo:6 Music mode, you can adjust the center image to create a wider stereo effect with vocals. Note that this is only available when using a center speaker.

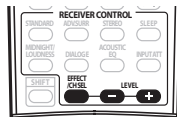

### Note

<sup>1</sup> If the Extended mode is switched off, **Dolby Pro Logic IIx** becomes **Dolby Pro Logic II** (5.1 channel sound), however these settings will still be effective.

**1** With Neo:6 MUSIC mode active, press **EFFECT/CH SEL** repeatedly to select **C. IMAGE**.

**2** Use the **+/-** buttons to adjust the setting.

Adjust the effect from **0** (all center channel sent to front right and left speakers) to **10** (center channel sent to the center speaker only).

## Listening in stereo

When you select **STEREO** or **DIRECT**, you will hear the source through just the front left and right speakers (and possibly your subwoofer depending on your speaker settings). Dolby Digital and DTS multichannel sources are downmixed to stereo.

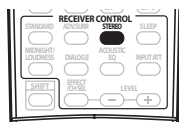

• While listening to a source, press **STEREO** for stereo playback.

Press repeatedly to switch between:

- **STEREO** – The audio is heard with your surround settings (such as channel level) and you can still use digital processing (such as the Midnight, Loudness, and Tone control functions).
- **DIRECT** – Bypass all effects and surround settings so that the audio remains as close to the source audio signal as possible.<sup>1</sup>
- **AUTO SURR.** – See *Auto playback* on page 34 for more on this.

## Listening with Acoustic Calibration EQ

- Default setting: **OFF / ALL CH** (after the Auto MCACC Setup or EQ Auto Setting)

You can listen to sources using the Acoustic Calibration Equalization set in *Automatically setting up for surround sound (MCACC)* on page 12 or *Acoustic Calibration EQ* on page 46. Refer to these pages for more on Acoustic Calibration Equalization.

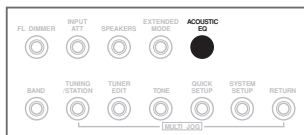
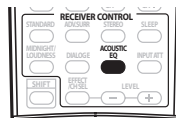

• While listening to a source, press **ACOUSTIC EQ**.

Press repeatedly to select between:

- **ALL CH** – No special weighting is given to any one channel.
- **F. ALIGN** – All speakers are heard in accordance with the front speaker settings.
- **CUSTOM 1/2** – Custom settings
- **EQ OFF** – Switches Acoustic Calibration EQ off.

The MCACC indicator on the front panel lights when Acoustic Calibration EQ is active.<sup>2</sup>

### Note

<sup>1</sup> If you switch on Midnight listening, Loudness, Dialog Enhancement, or the Tone controls when **DIRECT** is selected, the receiver automatically switches to **STEREO**.

<sup>2</sup> • You can't use Acoustic Calibration EQ when **DVD 5.1ch** is on, and it has no effect when headphones are connected.  
• If you switch on Acoustic Calibration EQ when **DIRECT** is selected, the receiver automatically switches to **STEREO**.

## Choosing the input signal

You need to hook up a component to both analog and digital inputs on the rear of the receiver to select between input signals.<sup>1</sup>

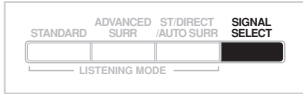

### 1 Press SIGNAL SELECT on the front panel to select the input signal corresponding to the source component.

Press repeatedly to select between:

- **AUTO** – This automatically switches to **DIGITAL** if a digital source is detected, otherwise it remains on **ANALOG**.
- **ANALOG** – Selects the analog inputs.
- **DIGITAL** – Selects the digital input.

When set to **DIGITAL** or **AUTO**, **DIGITAL** lights when a Dolby Digital signal is input, and **DTS** lights when a DTS signal is input.

#### Note

- This receiver can only play back Dolby Digital, PCM (32kHz–96 kHz), WMA9 Pro and DTS digital signal formats. With other digital signal formats, set to **ANALOG**.
  - You may get digital noise when a LD or CD player compatible with DTS is playing an analog signal. To prevent noise, make the proper digital connections (page 15) and set the signal input to **DIGITAL**.
  - Some DVD players don't output DTS signals. For more details, refer to the instruction manual supplied with your DVD player.

## Using the surround back channel (Extended mode)

- Default setting: **EXT. ON**

You can have the receiver automatically use 6.1 or 7.1 decoding for 6.1 encoded sources (for example, Dolby Digital EX or DTS-ES), or you can choose to always use 6.1 or 7.1 decoding (for example, with 5.1 encoded material). With 5.1 encoded sources, a surround back channel will be generated, but the material may sound better in the 5.1 format for which it was originally encoded (in which case, you can simply switch the Extended mode off).<sup>1</sup>

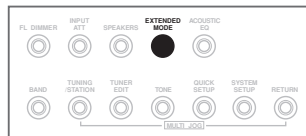

- **Press EXTENDED MODE (front panel) to select a surround back channel option.**

Press repeatedly to select between:

- **EXT. ON** – 6.1 or 7.1 decoding is always used (for example, a surround back channel will be generated for 5.1 encoded material)
- **EXT. AUTO** – Automatically switches to 6.1 or 7.1 decoding for 6.1 encoded sources (for example, Dolby Digital EX or DTS-ES)
- **EXT. OFF** – Maximum 5.1 playback

Type of source	Extended mode	Standard				Advanced surround
		Multichannel sources	Stereo sources			
			Pro Logic II x	Pro Logic	Neo:6	
Dolby Digital EX/ DTS-ES/WMA9 Pro encoded multi-channel source with 6.1/7.1ch surround	<b>ON</b>	●				●*
	<b>AUTO</b>	●				●*
Dolby Digital/DTS/ WMA9 Pro encoded multichannel source	<b>ON</b>	●				●*
	<b>AUTO</b>					●*
Dolby Digital/WMA9 Pro/DTS encoded stereo source; other digital stereo source	<b>ON</b>		●		●	●*
	<b>AUTO</b>		●		●	●*
Analog 2-channel (stereo) source	<b>ON</b>		●		●	●
	<b>AUTO</b>		●		●	●

\* Excluding WMA9 Pro format

### Note

<sup>1</sup> • You must have surround back speakers connected (and set to **LARGE** or **SMALL** in the *Speaker setting* on page 48) and the *Surround back speaker setting* on page 43 must be set to **SB NORM.** to hear the surround back channel.

- You can't use the surround back channel with headphones, or the **STEREO / DIRECT** or **AUTO SURR.** modes.
- You can't hear the surround back channel with DTS 96kHz/24 bit sources or PCM 96/88.2kHz sources.

## Using the Virtual Surround Back mode (VirtualSB)

Selecting this mode allows you to hear a virtual back channel through your surround speakers. For example, you can choose to listen to sources with no surround back channel information (for example, 5.1 encoded material) with emulated 6.1 encoding (**VSB ON**). Sometimes the material may sound better in the 5.1 format for which it was originally encoded. In this case you can have the receiver only apply this effect to 6.1 encoded sources like Dolby Digital EX or DTS-ES (**VSB AUTO**), or you can simply switch it off (**VSB OFF**).<sup>1</sup>

The table indicates when you will hear the virtual surround back channel.

- Press **EXTENDED MODE** (front panel) repeatedly to select a virtual surround back channel option.

Press repeatedly to select between:

- **VSB ON** – Virtual Surround Back is always used (for example, on 5.1 encoded material)
- **VSB AUTO** – Virtual Surround Back is automatically applied to 6.1 encoded sources (for example, Dolby Digital EX or DTS-ES)
- **VSB OFF** – Virtual Surround Back mode is switched off

Type of source	VSB mode	Standard				Advanced surround
		Multichannel sources	Stereo sources			
			Pro Logic II	Pro Logic	Neo:6	
Dolby Digital EX/ DTS-ES encoded multichannel source with 6.1ch surround	<b>ON</b>	●				●
	<b>AUTO</b>	●				●
Dolby Digital/DTS encoded multichannel source	<b>ON</b>	●				●
	<b>AUTO</b>					●
Dolby Digital/DTS encoded stereo source; other digital stereo source	<b>ON</b>		●	●	●	●
	<b>AUTO</b>				●	●
Analog 2-channel (stereo) source	<b>ON</b>		●	●	●	●
	<b>AUTO</b>				●	●

### Note

- 1 • You can't use the Virtual Surround Back mode with headphones or the **STEREO / DIRECT** mode.
  - You can only use the Virtual Surround Back mode if the surround speakers are on and the **Surr Back** setting is set to **NO** in the *Speaker setting* on page 48.
  - The Virtual Surround Back mode cannot be applied to sources that do not have surround channel information.
  - You can't adjust the surround back channel level when you're listening to the virtual surround back channel.



## Using Loudness and Midnight listening

The Loudness listening feature can be used to get good bass and treble from music sources at low volume levels.

The Midnight listening feature allows you to hear effective surround sound of movies at low volume levels. The effect automatically adjusts according to the volume at which you're listening.

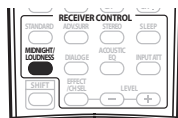

- 1 Press **MIDNIGHT/LOUDNESS** to switch between **MIDNIGHT**, **LOUDNESS**, and **OFF**.<sup>1</sup>

## Enhancing dialog

- Default setting: **OFF**

The Dialog Enhancement feature localizes dialog in the center channel to make it stand out from other background sounds in a TV or movie soundtrack.

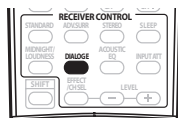

- Press **DIALOG E** to switch dialog enhancement on or off.

## Using the tone controls

Depending on what you are listening to, you may want to adjust the bass or treble using the front panel tone control.<sup>2</sup>

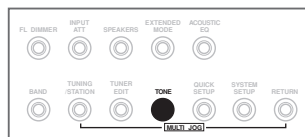
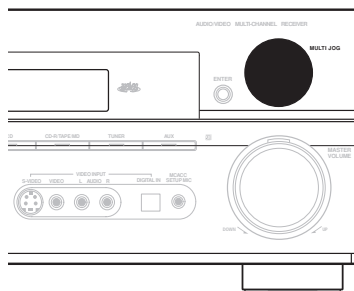

- 1 Press **TONE** to select the frequency you want to adjust.

Press to switch between **BASS** and **TREBLE**.

- 2 Use the **MULTI JOG** dial to change the amount of bass or treble as necessary.

The bass and treble can be adjusted from **-6** to **+6** (dB).

- Wait about five seconds for your changes to be input automatically.

### Note

- 1 • You can't use **MIDNIGHT/LOUDNESS** when **DVD 5.1ch** has been selected.
  - If you switch on Loudness or Midnight listening when **DIRECT** is selected, the receiver automatically switches to **STEREO**.
- 2 You can only use the tone controls when **STEREO/DIRECT** is selected. **DIRECT** will switch to **STEREO** when the tone controls are used.

## Playing other sources

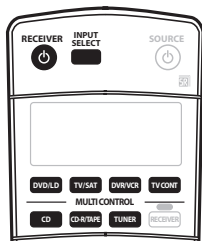

- 1 Turn on the power of the playback component.
- 2 Turn on the power of the receiver.
- 3 Select the source you want to playback. Use the **MULTI CONTROL** buttons (or **INPUT SELECT**).<sup>1</sup>
- 4 Start playback of the component you selected in step 1.

## Selecting the multichannel analog inputs

If you have connected a decoder or a DVD player with multichannel analog outputs to this receiver (page 18), you can select them for surround sound playback.<sup>2</sup>

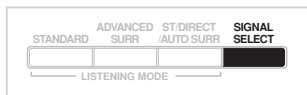

- 1 Make sure you have set the playback source to the proper output setting.

For example, you might need to set your DVD player to output multichannel analog audio.

- 2 Press DVD/LD.

- 3 Press **SIGNAL SELECT** to select the multichannel analog inputs.

DVD 5.1ch will show in the display and the **ANALOG SIGNAL SELECT** indicator will light.

## Using the sleep timer

The sleep timer switches the receiver into standby after a specified amount of time so you can fall asleep without worrying about the receiver being left on all night. Use the remote control to set the sleep timer.

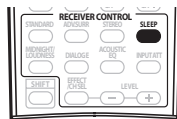

- Press **SLEEP** repeatedly to set the sleep time.

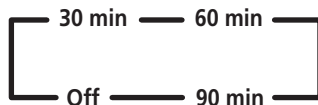

- You can check the remaining sleep time at any time by pressing **SLEEP** once. Pressing repeatedly will cycle through the sleep options again.<sup>3</sup>

### Note

1 If your source is the TV's built-in tuner, switch to the channel you want to watch, otherwise make sure that the TV's video input is set to this receiver (For example, if you connected this receiver to the **VIDEO 1** jacks on your TV, make sure that the **VIDEO 1** input is selected). Turn down the volume of your TV so that all the sound is coming from the speakers connected to this receiver.

2 • When playback from the multichannel inputs is selected, you can't use **ACOUSTIC CAL EQ**, **DIALOG E**, **INPUT ATT**, **TONE**, **VSB** and **MIDNIGHT/LOUDNESS**, as well as any of the listening modes (including **STEREO/DIRECT** and the Extended mode).

• When playback from the multichannel inputs is selected, only the volume and channel levels can be set.

• You can't listen to your speaker B (Second Zone) system during playback from the multichannel inputs.

3 You can also switch off the sleep timer simply by switching off the receiver.

## Chapter 7: The System Setup menu

### Making receiver settings from the System Setup menu

The following section shows you how to make detailed settings to specify how you're using the receiver (for example, if you want to set up two speaker systems in separate rooms), and also explains how to fine-tune individual speaker system settings to your liking.

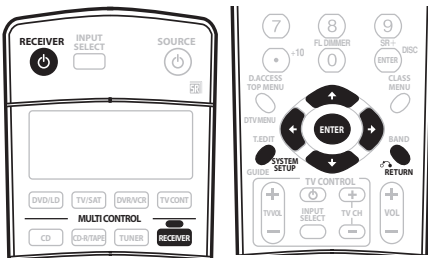

- 1 If the receiver is off, press **RECEIVER** to turn the power on.
  - If headphones are connected to the receiver, disconnect them.
- 2 Press **RECEIVER** on the remote control, then press the **SYSTEM SETUP** button.
  - Press **SYSTEM SETUP** again at any time to exit the System Setup menu.
- 3 Use **←/→** (cursor left/right) to select the setting you want to adjust then press **ENTER**. Press **RETURN** to confirm and exit the current menu.
  - **SB. SYSTEM** – Specify how you are using your surround back speakers (see *Surround back speaker setting* below).

- **A. MCACC** – This is a quick and effective automatic surround setup (see *Automatically setting up for surround sound (MCACC)* on page 12).
- **M. MCACC** – Fine tune your speaker settings and customize the Acoustic Calibration EQ (see *Manual MCACC speaker setup* below).
- **SP SETUP** – Specify the size, number, distance and overall balance of the speakers you've connected (see *Manual speaker setup* on page 48).
- **IN ASSIG.** – Specify what you've connected to the digital and component video inputs (see *The Input Assign menu* on page 66).
- **OTHER** – Make customized settings to reflect how you are using the receiver (see *The Other setup menu* on page 67).

### Surround back speaker setting

- Default setting: **SB NORM.**

There are several ways you can use the surround back speaker channels with this system. In addition to a normal home theater setup where they are used for the surround back speakers, they can be used for bi-amping the front speakers or as a separate speaker system in another room.

- 1 Select '**SB. SYSTEM**' from the **System Setup menu**.  
See *Making receiver settings from the System Setup menu* above.
- 2 Select the **surround back speaker setting**.
  - **SB NORM.** – Select for normal home theater use with surround back speakers in your main (speaker system A) setup.

- **SB 2ND Z** – Select to use the (surround back) B speaker terminals to listen to stereo playback in another room (see *Second Zone speaker B setup* on page 62).
- **SB BIAMP** – Select this setting if you're bi-amping your front speakers (see *Bi-amping your front speakers* on page 63).

### 3 When you're finished, press RETURN.

You will return to the System Setup menu.

## Manual MCACC speaker setup

You can use the settings in the Manual MCACC setup menu to make detailed adjustments when you're more familiar with the system. Before making these settings, you should have already completed *Automatically setting up for surround sound (MCACC)* on page 12.

You only need to make these settings once (unless you change the placement of your current speaker system or add new speakers).



### Important

- For some of the settings below, you'll have to connect the setup microphone to the front panel and place it about ear level at your normal listening position. See *Automatically setting up for surround sound (MCACC)* on page 12 if you're unsure how to do this. Also see *Other problems when using the Auto MCACC Setup* on page 14 for notes regarding high background noise levels and other possible interference.
- If you're using a subwoofer, switch it on and turn up the volume to the middle position.

### 1 Select 'M MCACC' from the System Setup menu.

See *Making receiver settings from the System Setup menu* above if you're not already at this menu.

### 2 Select the setting you want to adjust.

If you're doing this for the first time, you might want to make these settings in order.

- **CH LEVEL** – Make fine adjustments to the overall balance of your speaker system (see *Fine Channel Level* below).
- **CH DISTN.** – Make precise delay settings for your speaker system (see *Fine Channel Distance* below).

The last five settings are specifically for customizing the parameters explained in *Acoustic Calibration EQ* on page 46:

- **EQ A. SET** – Measure the acoustic characteristics of your room and automatically adjust the frequency balance of your speaker system (see *Setting the Acoustic Calibration EQ automatically* on page 46).
- **EQ COPY** – Copy Acoustic Calibration EQ settings for manual adjustment (see *Copying your Acoustic Calibration EQ settings* on page 46).
- **C1 ADJ/C2 ADJ** – Make detailed manual adjustments to your custom Acoustic Calibration EQ settings (see *Setting the Acoustic Calibration EQ manually* on page 46).
- **EQ CHECK** – Check the **ALL CH, F. ALIGN** and custom settings (see *Checking your Acoustic Calibration EQ settings* on page 47).

## Fine Channel Level

- Default setting: **0dB** (all channels)

You can achieve better surround sound by properly adjusting the overall balance of your speaker system. The following setting can help you make detailed adjustments that you may not achieve using the *Quick surround sound setup* on page 12.

## 1 Select 'CH LEVEL' from the Manual MCACC setup menu.

You'll hear test tones from each speaker in turn. Since the left speaker is the main reference speaker, the level is fixed and cannot be changed.

### Caution

- The test tones used in the System Setup are output at high volume (the volume increases to **-18dB** automatically).

## 2 Use $\leftarrow/\rightarrow$ (cursor left/right) to select each channel in turn and adjust the levels (+/-10dB) as necessary.

Use  $\uparrow/\downarrow$  (cursor up/down) to adjust the volume of the selected speaker to match the reference speaker. When it sounds like both tones are the same volume, press  $\leftarrow$  (cursor left) to continue to the next channel.

- For comparison purposes, the reference speaker will change depending on which speaker you select.
- If you want to go back and adjust a channel, simply use  $\leftarrow/\rightarrow$  (cursor left/right) to select it.

## 3 When you're finished, press RETURN.

You will return to the Manual MCACC setup menu.

## Fine Channel Distance

- Default setting: **10.0 ft** (all channels)

For proper sound depth and separation with your system, it is necessary to add a slight bit of delay to some speakers so that all sounds will arrive at the listening position at the same time. The following setting can help you make detailed adjustments that you may not achieve using the *Quick surround sound setup* on page 12.

## 1 Select 'CH DISTN.' from the Manual MCACC setup menu.

## 2 Use $\uparrow/\downarrow$ (cursor up/down) to adjust the distance of the left channel from the listening position then press ENTER.

## 3 Use $\leftarrow/\rightarrow$ (cursor left/right) to select each channel in turn and adjust the distance as necessary.

Use  $\uparrow/\downarrow$  (cursor up/down) to adjust the delay of the selected speaker to match the reference speaker. The delay is measured in terms of speaker distance from **0.5** to **45.0** feet.

Listen to the reference speaker and use it to measure the target channel. From the listening position, face the two speakers with your arms outstretched pointing at each speaker. Try to make the two tones sound as if they are arriving simultaneously at a position slightly in front of you and between your arm span.

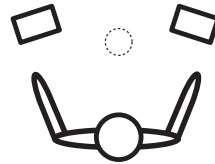

When it sounds like the delay settings are matched up, press  $\rightarrow$  (cursor right) to confirm and continue to the next channel.

- For comparison purposes, the reference speaker will change depending on which speaker you select.
- If you want to go back and adjust a channel, simply use  $\leftarrow/\rightarrow$  (cursor left/right) to select it.

## 4 When you're finished, press RETURN.

You will return to the Manual MCACC setup menu.

## Acoustic Calibration EQ

Acoustic Calibration Equalization is a kind of room equalizer for your speakers (excluding the subwoofer). It works by measuring the acoustic characteristics of your room and neutralizing the ambient characteristics that can color the original source material. This provides a 'flat' equalization setting. If you're not satisfied with the automatic adjustment, you can also adjust these settings manually to get a frequency balance that suits your tastes.

### Setting the Acoustic Calibration EQ automatically

If you have already completed *Automatically setting up for surround sound (MCACC)* on page 12, **A. CH ADJ** and **F.ALG ADJ** (below) should already be set. Therefore, if you want to adjust your settings manually, you can skip to *Setting the Acoustic Calibration EQ manually* below.

#### 1 Select 'EQ A. SET' from the Manual MCACC setup menu.

- Make sure the microphone is connected.
- If you're using a subwoofer, it is automatically detected every time you switch on the system. Make sure it is on and the volume is at the middle position.
- See *Other problems when using the Auto MCACC Setup* on page 14 for notes regarding high background noise levels and other possible interference.

#### 2 Wait for the Auto MCACC Setup to finish.

As the receiver outputs test tones, the frequency balance is adjusted automatically for the following settings:

- **A. CH** – *All Channel Adjust* is a 'flat' setting where all the speakers are set individually so no special weighting is given to any one channel.

- **F.ALG** – *Front Align Adjust* balances the overall sound so that all speakers are set in accordance with the front speaker settings (no equalization is applied to the front left and right channels).

You will return to the Acoustic Cal EQ setup menu after the Acoustic Calibration Equalization is set.

### Copying your Acoustic Calibration EQ settings

If you want to manually adjust the Acoustic Calibration EQ (see *Setting the Acoustic Calibration EQ manually* below), we recommend copying the **A. CH** or the **F.ALG** settings from the **EQ A. SET** setup above (or from *Automatically setting up for surround sound (MCACC)* on page 12) to one of the custom (**C1** or **C2**) settings. Instead of just a flat EQ curve, this will give you a reference point from which to start.

#### 1 Select 'EQ COPY' from the Manual MCACC setup menu.

#### 2 Use ←/→ (cursor left/right) to select C1 or C2 then use the ↑/↓ (cursor up/down) buttons to select the setting you want to copy.

- You can also copy from one custom setting to another. For more on the **A. CH** and **F.ALG** settings, see *Setting the Acoustic Calibration EQ automatically* above.

#### 3 Use ←/→ (cursor left/right) to select 'COPY? YES' to copy and confirm.

You can also use ↑/↓ (cursor up/down) to select **COPY? NO** to cancel.

### Setting the Acoustic Calibration EQ manually

Before manually adjusting the Acoustic Calibration EQ, we recommend copying the **A. CH** or the **F.ALG** settings from the auto setup above (or from *Automatically setting up for surround sound (MCACC)* on page 12) to one of the custom settings. Instead of just a flat EQ

curve, this will give you a reference point from which to start (see *Copying your Acoustic Calibration EQ settings* above for how to do this).

**1 Select 'C1 ADJ' or 'C2 ADJ' from the Manual MCACC setup menu.**

**2 Use ←/→ (cursor left/right) and ENTER to select which method you want to use to adjust the overall frequency balance.**

It is best to choose whichever one you copied to the custom setting in *Copying your Acoustic Calibration EQ settings* above.

- **A. CH ADJ** – All the speakers can be set independently so no special weighting is given to any one channel. When adjusting, test tones will sound for each individual channel.
- **F.ALG ADJ** – Speakers are set in accordance with the front speaker settings. The sound of the test tone will alternate between the left front (reference) speaker and the target speaker.

**3 Use ↑/↓ (cursor up/down) to select the channel you want and adjust to your liking.**

Use the ←/→ (cursor left/right) buttons to select the frequency and ↑/↓ (cursor up/down) to boost or cut the EQ. When you're finished, use the ←/→ (cursor left/right) buttons to select the channel display (for example **R EQ** for the right channel or **SBR EQ** for the surround back right channel) then ↑/↓ (cursor up/down) to proceed to the next channel.

- The front speakers can't be adjusted if you selected **F.ALG ADJ**.
- The **OVER!!** indicator shows in the display if the frequency adjustment is too drastic and might distort. If this happens, bring the level down until **OVER!!** disappears from the display.



**Tip**

- Changing the frequency curve of one channel too drastically will affect the overall balance. If the speaker balance seems uneven, you can raise or lower channel levels using test tones with the 'trim' band (**TRM** shows in the display). Use ←/→ (cursor left/right) to select **TRM** then use ↑/↓ (cursor up/down) to raise or lower the channel level for the current speaker.

**4 When you're finished, press RETURN.**

Press **RETURN** once more to go back to the Manual MCACC setup menu.

**Checking your Acoustic Calibration EQ settings**

After you have completed an automatic or manual Acoustic Calibration EQ adjustment, you can check the **ALL CH**, **F.ALIGN** and **CUSTOM1/2** settings in the display.

**1 Select 'EQ CHECK' from the Manual MCACC setup menu.**

**2 Use ↑/↓ (cursor up/down) and ENTER to select the setting you want to check.**

- It is useful to do this while a source is playing so you can compare the different settings.

**3 Use ↑/↓ (cursor up/down) to select the channel you want, using ←/→ (cursor left/right) to check the settings.**

The MCACC channel EQ indicators in the front panel display will light accordingly.

**4 When you're finished, press RETURN.**

You will return to the Manual MCACC setup menu.

## Manual speaker setup

This receiver allows you to make detailed settings to optimize the surround sound performance. You only need to make these settings once (unless you change the placement of your current speaker system or add new speakers.).

These settings are designed to fine-tune your system, but if you're satisfied with the settings made in *Automatically setting up for surround sound (MCACC)* on page 12, it isn't necessary to make all of these settings.

### 1 Select 'SP SETUP' from the System Setup menu then press ENTER.

See *Making receiver settings from the System Setup menu* above.

### 2 Use ←/→ (cursor left/right) to select the setting you want to adjust then press ENTER.

If you are doing this for the first time, you may want to adjust these settings in order:

- **SP SET** – Specify the size and number of speakers you've connected (see *Speaker setting* below).
- **X.OVER**– Specify which frequencies will be sent to the subwoofer (see *Crossover network* on page 49).
- **CH LEVEL** – Adjust the overall balance of your speaker system (see *Channel level* on page 49).
- **SP DISTN.** – Specify the distance of your speakers from the listening position (see *Speaker Distance* on page 50).

## Speaker setting

Use this setting to specify your speaker configuration (size, number of speakers). It is a good idea to make sure that the settings made in *Automatically setting up for surround sound (MCACC)* on page 12 are correct.

### Note

<sup>1</sup> If you select **SMALL** for the front speakers the subwoofer will automatically be fixed to **YES**. Also, the center, surround, and surround back speakers can't be set to **LARGE** if the front speakers are set to **SMALL**. In this case, all bass frequencies are sent to the subwoofer.

### 1 Select SP SET from the SP SETUP menu.

### 2 Use ←/→ (cursor left/right) to choose the speaker(s) that you want to set then select a speaker size.

Use ↑/↓ (cursor up/down) to select the size (and number) of each of the following speakers:

- **Front (F)** – Select **LARGE** if your front speakers reproduce bass frequencies effectively, or if you didn't connect a subwoofer. Select **SMALL** to send the bass frequencies to the subwoofer.<sup>1</sup>
- **Center (C)** – Select **LARGE** if your center speaker reproduces bass frequencies effectively, or select **SMALL** to send bass frequencies to the other speakers or subwoofer. If you didn't connect a center speaker, choose **NO** (the center channel is sent to the front speakers).
- **Surround (S)** – Select **LARGE** if your surround speakers reproduce bass frequencies effectively. Select **SMALL** to send bass frequencies to the other speakers or subwoofer. If you didn't connect surround speakers choose **NO** (the sound of the surround channels is sent to the front speakers or a subwoofer).
- **Surround Back (SB)** – Select the number and size of surround back speakers you have. Select **LARGE** if your surround back speakers reproduce bass frequencies effectively. Select **SMALL** to send bass frequencies to the other speakers or subwoofer. If you didn't connect surround back speakers choose **NO**.<sup>2</sup>
- **Subwoofer (SW)** – LFE signals and bass frequencies of channels set to **SMALL** are output from the subwoofer when **YES** is selected (see notes below). Choose the **PLUS** setting if you want the subwoofer to



output bass sound continuously or you want deeper bass (the bass frequencies that would normally come out the front and center speakers are also routed to the subwoofer). If you did not connect a subwoofer choose **NO** (the bass frequencies are output from other speakers).

### 3 When you're finished, press RETURN.

#### Tip

- If you have a subwoofer and like lots of bass, it may seem logical to select **LARGE** for your front speakers and **PLUS** for the subwoofer. This may not, however, yield the best bass results. Depending on the speaker placement of your room you may actually experience a decrease in the amount of bass due low frequency cancellations. In this case, try changing the position or direction of speakers. If you can't get good results, listen to the bass response with it set to **PLUS** and **YES** or the front speakers set to **LARGE** and **SMALL** alternatively and let your ears judge which sounds best. If you're having problems, the easiest option is to route all the bass sounds to the subwoofer by selecting **SMALL** for the front speakers.

## Crossover network

- Default setting: **100Hz**

This setting decides the cutoff between bass sounds playing back from the speakers selected as **LARGE**, or the subwoofer, and bass sounds playing back from those selected as **SMALL**.<sup>1</sup> It also decides where the cutoff will be for bass sounds in the LFE channel.

### 1 Select 'X.OVER' from the SP SETUP menu.

### 2 Use ↑/↓ (cursor up/down) to choose the frequency cutoff point.

Frequencies below the cutoff point will be sent to the subwoofer (or **LARGE** speakers).

### 3 When you're finished, press RETURN.

## Channel level

Using the channel level settings, you can adjust the overall balance of your speaker system, an important factor when setting up a home theater system.

### 1 Select CH LEVEL from the SP SETUP menu.

### 2 Use ↑/↓ (cursor up/down) to select a setup option.

- **T. TONE M.** – Move the test tone manually from speaker to speaker and adjust individual channel levels.
- **T. TONE A.** – Adjust channel levels as the test tone moves from speaker to speaker automatically.

### 3 Confirm your selected setup option.

The test tones will start after you press **ENTER**.

### 4 Adjust the level of each channel using the ↑/↓ (cursor up/down) buttons.

If you selected **T. TONE M.**, use ←/→ (cursor left/right) to switch speakers.

The **T. TONE A.** setup will output test tones in the following order (depending on the speaker setting):



#### Note

- <sup>2</sup> If the surround speakers are set to **NO**, the surround back speakers will automatically be set to **NO**.
- If you selected **SB 2ND Z** or **SB BIAMP** (in *Surround back speaker setting* on page 43) you can't adjust the surround back settings.
- If you select one surround back speaker only, make sure that speaker is hooked up to the left surround back terminal.

<sup>1</sup> For more on selecting the speaker sizes, see *Speaker setting* above.

Adjust the level of each speaker as the test tone is emitted.<sup>1</sup>

**5 When you're finished, press RETURN.**

**Tip**

- You can change the channel levels at any time by using **EFFECT/CH SEL** and **+/-** on the remote control. You can set two channel levels: one for **DVD 5.1 CH** and one for the listening modes.

## Speaker Distance

For good sound depth and separation from your system, you need to specify the distance of your speakers from the listening position. The receiver can then add the proper delay needed for effective surround sound.

**1 Select 'SP DISTN.' from the SP SETUP menu.**

**2 Use ←/→ (cursor left/right) to choose the speaker that you want then set the distance.**

Use ↑/↓ (cursor up/down) to adjust the distance of each speaker (in 0.5 feet increments).

**3 When you're finished, press RETURN.**

**Note**

<sup>1</sup> • If you are using a Sound Pressure Level (SPL) meter, take the readings from your main listening position and adjust the level of each speaker to 75 dB SPL (C-weighting/slow reading).

- The subwoofer test tone is output at low volumes. You may need to adjust the level after testing with an actual soundtrack.

## Chapter 8: Using the tuner

### Listening to the radio

The following steps show you how to tune in to FM and AM radio broadcasts using the automatic (search) and manual (step) tuning functions. If you already know the frequency of the station you want, see *Tuning directly to a station* below. Once you are tuned to a station you can memorize the frequency for recall later—see *Saving station presets* on the next page for more on how to do this.

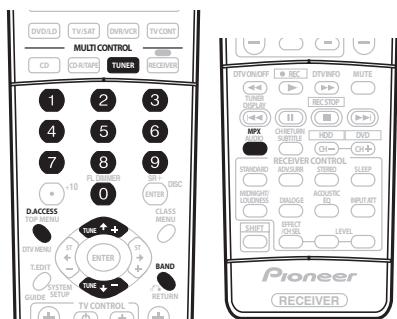

- 1 Press **TUNER** to select the tuner.
- 2 Use the **BAND** button to change the band (FM or AM), if necessary.

Each press switches the band between FM and AM.

- 3 Tune to a station.

There are three ways to do this:

#### Automatic tuning

To search for stations in the currently selected band, press and hold **TUNE +/-** for about a second. The receiver will start searching for the next station, stopping when it has found one. Repeat to search for other stations.

#### Manual tuning

To change the frequency one step at a time, press **TUNE +/-**.

#### High speed tuning

Press and hold **TUNE +/-** for high speed tuning. Release the button at the frequency you want.

### Improving FM stereo sound

If the **TUNED** or **STEREO** indicators don't light when tuning to an FM station because the signal is weak, press the **MPX** button to switch the receiver into mono reception mode. This should improve the sound quality and allow you to enjoy the broadcast.

### Tuning directly to a station

Sometimes, you'll already know the frequency of the station you want to listen to. In this case, you can simply enter the frequency directly using the number buttons on the remote control.

- 1 Press the **TUNER** button to select the tuner.
- 2 Use the **BAND** button to change the band (FM or AM), if necessary.
- 3 Press **D.ACCESS** (Direct Access).
- 4 Use the number buttons to enter the frequency of the radio station.

For example, to tune to **106.00** (FM), press **1, 0, 6, 0, 0**.

If you make a mistake halfway through, press **D.ACCESS** twice to cancel the frequency and start over.

## Saving station presets

If you often listen to a particular radio station, it's convenient to have the receiver store the frequency for easy recall whenever you want to listen to that station. This saves the effort of manually tuning in each time. This unit can memorize up to 30 stations, stored in three banks, or classes, (A, B and C) of 10 stations each. When saving an FM frequency, the **MPX** setting (see previous page) is also stored.<sup>1</sup>

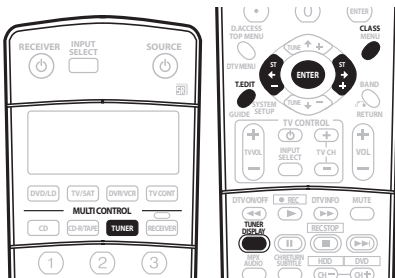
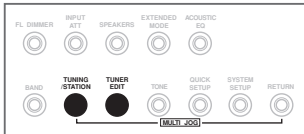
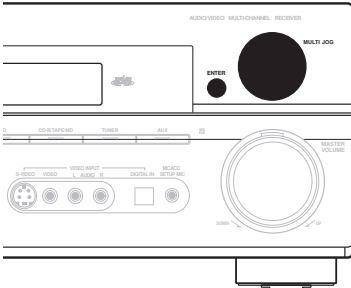

### 1 Tune to a station you want to memorize.

See *Listening to the radio* on the previous page for more on this.

### 2 Press T.EDIT (TUNER EDIT).

The display shows **ST. MEMORY**, then a blinking memory class.

### 3 Press CLASS to select one of the three classes then press ST +/- to select the station preset you want.

You can also use the number buttons or the **MULTI JOG** dial (front panel) to select a station preset.

### 4 Press ENTER.

After pressing **ENTER**, the preset class and number stop blinking and the receiver stores the station.

## Naming station presets

For easier identification, you can name your station presets.

### 1 Choose the station preset you want to name.

See *Listening to station presets* below for how to do this.

### 2 Press T.EDIT (TUNER EDIT).

The display shows **ST. NAME**, then a blinking cursor at the first character position.

### 3 Input the name you want.

Choose a name up to four characters long.

- Use the **MULTI JOG** dial (front panel) or the **ST +/-** buttons (remote) to select characters.
- Press **ENTER** to confirm a character. If no character is input, a space is input.
- The name is stored when **ENTER** is pressed after choosing the fourth character.

#### Note

<sup>1</sup> If the receiver is left disconnected from the AC power outlet for over a month, the station memories will be lost and will have to be reprogrammed.



### Tip

- To erase a station name, simply repeat steps 1-3 and input four spaces instead of a name.
- Once you have named a station preset, you can press **TUNER DISPLAY** when listening to a station to switch the display between name and frequency.

### Listening to station presets

You will need to have some presets stored to do this. See *Saving station presets* above if you haven't done this already.

**1 Press TUNER to select the tuner.**

**2 Press CLASS to select the class in which the station is stored.**

Press repeatedly to cycle through classes A, B and C.

**3 Press ST +/- to select the station preset you want.**

- You can also use the number buttons on the remote control to recall the station preset.

## Chapter 9:

# Making recordings

## Making an audio or a video recording

You can make an audio or a video recording from the built-in tuner, or from an audio or video source connected to the receiver (such as a CD player or TV).

Keep in mind you can't make a digital recording from an analog source or vice-versa, so make sure the components you are recording to/from are hooked up in the same way (see *Connecting up* on page 15 for more on connections).

If you want to record a video source, you also need to use the same type of connection for the source as for the recorder. For example, you can't record a component hooked up to S-video jacks with a recorder hooked up to the composite video outputs (see page 20 for more on video connections).

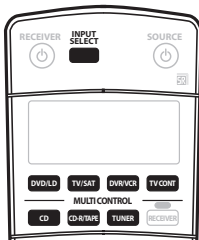

### 1 Select the source you want to record.

Use the **MULTI CONTROL** buttons (or **INPUT SELECT**).

### 2 Select the input signal (if necessary).

Press **SIGNAL SELECT** to select the input signal corresponding to the source component (see page 38 for more on this).

### 3 Prepare the source you want to record.

Tune to the radio station, load the CD, video, DVD etc.

### 4 Prepare the recorder.

Insert a blank tape, MD, video etc. into the recording device and set the recording levels.

Refer to the instructions that came with the recorder if you are unsure how to do this. Most video recorders set the audio recording level automatically—check the component's instruction manual if you're unsure.

### 5 Start recording, then start playback of the source component.<sup>1</sup>

#### Note

- The receiver's volume, balance, tone (bass, treble, loudness), and surround effects have no effect on the recorded signal.
- Some digital sources are copy-protected, and can only be recorded in analog.
- Some video sources are copy-protected. These cannot be recorded.

## Chapter 10:

# Controlling the rest of your system

## Setting the remote to control other components

Most components can be assigned to one of the **MULTI CONTROL** buttons using the component's manufacturer preset code stored in the remote.

However, please note that there are cases where only certain functions may be controllable after assigning the proper preset code, or the codes for the manufacturer in the remote control will not work for the model that you are using.<sup>1</sup>

*VSX-915 only* – If you can't find a preset code that matches the component you want to control, you can still teach the remote individual commands from another remote control (page 56).

### Note

- You can cancel or exit any of the steps by pressing **RECEIVER**. To go back a step, press **RETURN**.
- After one minute of inactivity, the remote automatically exits the operation.

## Selecting preset codes directly

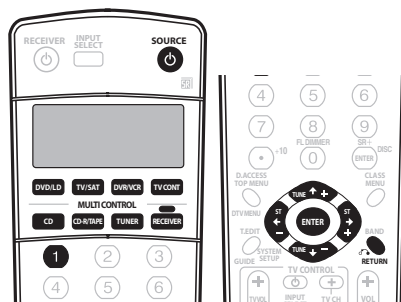

**1** While pressing the **RECEIVER** button, press and hold the **1** button.

The remote LCD display shows **SETUP**.

**2** Press the **MULTI CONTROL** button for the component you want to control.

The LCD on the remote displays the component you want to control.<sup>2</sup>

**3** Use **←/→** (cursor left/right) to select **PRESET** then press **ENTER**.

**4** Use **↑/↓** (cursor up/down) to select the first letter of the brand name of your component then press **ENTER**.

This should be the manufacturer's name (for example, **P** for Pioneer).

### Note

- TV codes (for example, codes for TV, CATV, Satellite TV or DTV) can only be assigned to the **TV/SAT** or **TV CONT** button.
  - If you assign the **TUNER** function to another component, you will have to reassign it to the Pioneer preset code to use this receiver's built-in tuner.
- You can't assign the **RECEIVER** button.

**5 Use ↑/↓ (cursor up/down) to select the manufacturer's name from the list then press ENTER.**

**6 Use ↑/↓ (cursor up/down) to select the proper code from the list, then try using this remote control with your component.**

The code should start with the component type (for example, **DVD 009**). If there is more than one, start with the first one.

To try out the remote control, switch the component on or off (into standby) by pressing **SOURCE** . If it doesn't seem to work, select the next code from the list (if there is one).

- *VSX-915 only* – If you can't find or properly enter a preset code, you can still teach the remote individual commands from another remote control (see *Programming signals from other remote controls* below).

**7 If your component is controlled successfully, press ENTER to confirm.**

The remote LCD display shows **OK**.

## Programming signals from other remote controls

*VSX-915 model only*

If the preset code for your component is not available, or the available preset codes do not operate correctly, you can program signals from the remote control of another component. This can also be used to program additional operations (buttons not covered in the presets) after assigning a preset code.

**1 While pressing the RECEIVER button, press and hold the 1 button.**

The remote LCD display shows **SETUP**.

**2 Press the MULTI CONTROL button for the component you want to control.**

The LCD on the remote displays the component you want to control.<sup>1</sup>

**3 Use ←/→ (cursor left/right) to select LEARN then press ENTER.**

**PRES KEY** shows in the LCD display.

- To exit or cancel press **RECEIVER**.

**4 Point the two remote controls towards each other then press the button that will be doing the learning on this receiver's remote control.**

**PRES KEY** starts flashing to indicate the remote is ready to accept a signal.

- The remote controls should be 1–2 inches apart.



**5 Press the corresponding button on the other remote control that is sending (teaching) the signal to this receiver's remote control.**

For example, if you want to learn the playback control signal, press and hold **▶** for a couple of seconds. The LCD display will show **OK** if the operation has been learned.

If for some reasons the operation hasn't been learned the LCD will display **ERROR** briefly and then display **PRES KEY** again. If this happens, keep pressing the (teaching) button as you vary the distance between the two remotes, until the LCD display shows **OK**.<sup>2</sup>

### Note

<sup>1</sup> • You can't assign the **RECEIVER** button.

• **TV CONTROL** buttons (**TV** , **TV VOL +/-**, **TV CH +/-** and **INPUT SELECT**) can only be learned after selecting **TV CONT**.

<sup>2</sup> • Some commands from other remote controls cannot be learned, but in most cases the remotes just need to be moved closer together or farther apart.

• If the remote LCD shows **ERROR**, it may also mean the memory is full. See *Erasing one of the remote control button settings* below to erase a programmed button you're not using to free up more memory.



Certain buttons represent operations that cannot be learned from other remote controls. The buttons available are shown below:

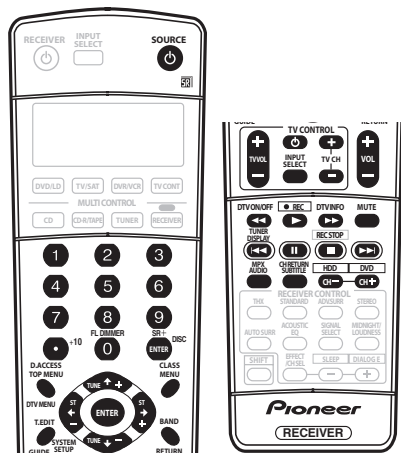

**6 To program additional signals for the current component repeat steps 4 and 5.**  
To program signals for another component, exit and repeat steps 1 through 5.

**7 Press the RECEIVER button to exit and store the operation(s).**

**3 Use ←/→ (cursor left/right) to select ERASE then press ENTER.**  
The LCD display flashes **PRES KEY**.

**4 Press and hold the button to be erased for two seconds.**  
The LCD display shows **OK** or **NO CODE** to confirm the button has been erased.

**5 Repeat step 4 to erase other buttons.**

**6 Press the RECEIVER button when you're done.**

## Erasing all of the remote control presets

This will erase all preset remote control preset codes and (VSX-915 model only) programmed buttons.

**1 While pressing the RECEIVER button, press and hold the 1 button.**  
The remote LCD display shows **SETUP**.

**2 Press the DVD/LD MULTI CONTROL button.**

**3 Use ←/→ (cursor left/right) to select RESET then press and hold ENTER for about two seconds.**  
The LCD shows **OK** to confirm the remote presets have been erased.

## Erasing one of the remote control button settings

*VSX-915 model only*

This erases one of the buttons you have programmed and restores the button to the factory default.

**1 While pressing the RECEIVER button, press and hold the 1 button.**  
The remote LCD display shows **SETUP**.

**2 Press the MULTI CONTROL button corresponding to the button setting to be erased.**  
The LCD on the remote displays the component.

## Direct function

- Default setting: **ON**

You can use the direct function feature to control one component using the remote control while at the same time, using your receiver to playback a different component. This could let you, for example, use the remote control to set up and listen to a CD on the receiver and then use the remote control to rewind a tape in your VCR while you continue to listen to your CD player.

When direct function is on, any component you select (using the **MULTI CONTROL** buttons) will be selected by both the receiver and the remote control. When you turn direct function off, you can operate the remote control without affecting the receiver.<sup>1</sup>

**1 While pressing the RECEIVER button, press and hold the 1 button.**

The remote LCD display shows **SETUP**.

**2 Press the MULTI CONTROL button for the component you want to control.**

The LCD on the remote displays the component you want to control.

**3 Use ←/→ (cursor left/right) to select DIRECT F then press ENTER.**

The LCD on the remote displays the component you want to control.

**4 Use ↑/↓ (cursor up/down) to switch direct function ON or OFF then press ENTER.**

The LCD shows **OK** to confirm the setting.

---

## Confirming preset codes

Use this feature to check which preset code is assigned to a **MULTI CONTROL** button.

**1 While pressing the RECEIVER button, press and hold the 1 button.**

The remote LCD display shows **SETUP**.

**2 Press the MULTI CONTROL button of the component for which you want to check the preset code.**

**3 Use ←/→ (cursor left/right) to select READ ID then press ENTER.**

The brand name and preset code appears in the display for three seconds.

---









 **Note**

<sup>1</sup> You can't use direct function with the **TV CONT** function.

## Controls for TVs

This remote control can control components after entering the proper codes or teaching the receiver the commands (see *Setting the remote to control other components* on page 55 for more on this). Use the **MULTI CONTROL** buttons to select the component

- The **TV CONTROL** buttons on the remote control are dedicated to control the TV assigned to the **TV CONT** button. If you have two TVs, assign the main TV to the **TV CONT** button.

Button(s)	Function	Components
TV 	Switches the DTV on or off.	DTV
	Switches the TV or CATV between standby and on.	Cable TV/Satellite TV/TV
<b>INPUT SELECT</b>	Switches the TV input. (Not possible with all models.)	TV
<b>TV CH +/-</b>	Selects channels.	Cable TV/Satellite TV/TV/DTV
<b>TV VOL +/-</b>	Adjust the TV volume.	Cable TV/Satellite TV/TV/DTV
<b>SOURCE</b> 	Press to switch the component assigned to the <b>TV CONT</b> button on or off.	Cable TV/Satellite TV/TV/DTV
	Switches the DTV on or off.	DTV
	Press to get information on DTV programs.	DTV
	Use to choose the BLUE commands on a DTV menu.	DTV
	Use to choose the YELLOW commands on a DTV menu.	DTV
	Use to choose the GREEN commands on a DTV menu.	DTV
	Use to choose the RED commands on a DTV menu.	DTV
<b>AUDIO</b>	Use to switch DTV audio tracks.	DTV
<b>CH RETURN</b>	Use to return to the previously selected channel.	Cable TV/Satellite TV/TV/DTV
<b>DTV MENU</b>	Press to display the DTV menu.	DTV
<b>GUIDE</b>	Use as the <b>GUIDE</b> button for navigating.	Cable TV/Satellite TV/TV/DTV
<b>RETURN</b>	Use to select closed captioning with DTV.	DTV
Number Buttons	Use to select a specific TV channel.	Cable TV/Satellite TV/TV/DTV

Button(s)	Function	Components
<b>+10</b> button	Use to add a decimal points when selecting TV channels.	DTV
<b>ENTER/ DISC</b>	Use to enter a channel.	Cable TV/Satellite TV/TV/DTV
<b>MENU</b>	Select different menus from the DTV functions.	DTV
	Select the menu screen.	Cable TV/Satellite TV/TV
<b>←→↓↑ &amp; ENTER</b>	Press to select or adjust and navigate items on the menu screen.	Cable TV/Satellite TV/TV/DTV

## Controls for other components

This remote control can control these components after entering the proper codes or teaching the receiver the commands (see *Setting the remote to control other components* on page 55 for more on this). Use the **MULTI CONTROL** buttons to select the component.

Button (s)	Function	Components
<b>SOURCE</b> 	Press to switch the component between standby and on.	CD/MD/CD-R/VCR/DVD/LD/DVR player/Cassette deck
<b>⏮</b>	Press to return to the start of the current track. Repeated presses skips to the start of previous tracks.	CD/MD/CD-R/DVD/LD player
	Go back channels (channel -).	DVR/VCR
<b>⏭</b>	Press to advance to the start of the next track. Repeated presses skips to the start of following tracks.	CD/MD/CD-R/DVD/LD player
	Go forward channels (channel +).	VCR
<b>⏸</b>	Pause playback or recording.	CD/MD/CD-R/VCR/DVD/LD/DVR player/Cassette deck
<b>▶</b>	Start playback.	CD/MD/CD-R/VCR/DVD/LD/DVR player/Cassette deck
<b>⏩</b>	Hold down for fast forward playback.	CD/MD/CD-R/VCR/DVD/LD/DVR player/Cassette deck
<b>⏪</b>	Hold down for fast reverse playback.	CD/MD/CD-R/VCR/DVD/LD/DVR player/Cassette deck
<b>■</b>	Stops playback (on some models, pressing this when the disc is already stopped will cause the disc tray to open).	CD/MD/CD-R/VCR/DVD/LD/DVR player/Cassette deck
<b>● REC (SHIFT+▶)</b>	Starts recording. To prevent accidental recording, this button must be pressed twice to take effect.	MD/CD-R/VCR/ DVR player/Cassette deck

Button (s)	Function	Components
<b>REC STOP</b> (SHIFT+■)	Stops recording.	DVR player
Number buttons	Directly access tracks on a program source.  Use the number buttons to navigate the on-screen display.	CD/MD/CD-R/VCR/LD player  DVD/DVR player
<b>+10</b> button	Selects tracks higher than 10. (For example, press <b>+10</b> then <b>3</b> to select track 13.)	CD/MD/CD-R/VCR/LD player
<b>ENTER/</b> <b>DISC</b>	Chooses the disc.  Ejects the disc.  Use as the <b>ENTER</b> button.  Use as the <b>CLEAR</b> button.  Displays the setup screen for DVR players.  Changes sides of the LD.	Multiple CD player  MD player  VCR  DVD  DVR player  LD player
<b>TOP MENU</b>	Displays the disc 'top' menu of a DVD player.	DVD/DVR player
<b>MENU</b>	Displays menus for the current DVD or DVR you are using.	DVD/DVR player
<b>↑</b>	Pauses the tape.	Cassette deck
<b>↓</b>	Stops the tape.	Cassette deck
<b>ENTER</b>	Starts playback.	Cassette deck
<b>←/→</b>	Fast rewinds/fast forwards the tape.	Cassette deck
<b>←→↓↑ &amp;</b> <b>ENTER</b>	Navigates DVD menu/options.	DVD/DVR Player
<b>GUIDE</b>	Press to access the DVD player setup screen.	DVD/DVR Player
<b>CH +/-</b>	Selects channels.  Selects tracks.	VCR/DVD/DVR Player  CD/MD/CD-R/Cassette deck
<b>AUDIO</b>	Changes the audio language or channel.	DVD/DVR Player
<b>SUBTITLE</b>	Displays/changes the subtitles on multilingual DVDs.	DVD/DVR Player
<b>HDD (SHIFT</b> <b>+ CH-)</b>	Switches to the hard disk controls when using a DVD/ HDD recorder.	DVR Player
<b>DVD (SHIFT</b> <b>+ CH+)</b>	Switches to the DVD controls when using a DVD/HDD recorder.	DVR Player

## Chapter 11: Other connections



### Caution

- Before making or changing the connections, switch off the power and disconnect the power cord from the power outlet. Plugging in components should be the last connection you make with your system.
- Be careful not to allow any contact between speaker wires from different terminals.
- You can use speakers with a nominal impedance between 6–16Ω (please see *Switching the speaker impedance* on page 72 if you plan to use speakers with an impedance of less than 8Ω).

### Second Zone speaker B setup

After selecting **SB 2ND Z** in *Surround back speaker setting* on page 43, you can use the speakers connected to the (surround back) B speaker terminals on the rear panel to listen to stereo playback in another room. See *Switching the speaker system* below for the listening options with this setup.

#### 1 Connect a pair of speakers to the surround back speaker terminals on the rear panel.

Connect them the same way you connected your speakers in *Connecting the speakers* on page 23. Make sure to review *Hints on speaker placement* on page 24 when placing the speakers in another room.

#### 2 Select **SB 2ND Z** from the 'SB. SYSTEM' menu.

See *Surround back speaker setting* on page 43 to do this.

### Switching the speaker system

If you selected **SB 2ND Z** in *Surround back speaker setting* on page 43, three speaker system settings are possible using the **SPEAKERS** button. If you selected **SB NORM.** or **SB BIAMP**, the speaker system is fixed as **SP▶A** or **SP▶AB** (respectively). The options below are for the **SB 2ND Z** setting only.<sup>1</sup>

- Use the **SPEAKERS** button on the front panel to select a speaker system setting.

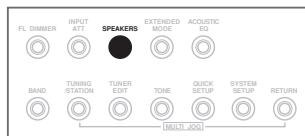

Press repeatedly to choose a speaker system option:

- **SP▶A** – Sound is output from the speakers connected to the A speaker terminals (multichannel playback is possible).
- **SP▶B** – Sound is output from the two speakers connected to speaker system B (only stereo playback is possible).

### Note

- <sup>1</sup> • The subwoofer output depends on the settings you made in *Speaker setting* on page 48. However, if **SP▶B** is selected above, no sound is heard from the subwoofer (the LFE channel is not downmixed).
- Depending on the *Surround back speaker setting* on page 43 output from the surround back pre-out terminals may change.
  - All speaker systems (except **SB 2ND Z** connections) are switched off when headphones are connected.

- **SP►AB** – Sound is output from speaker system A (up to 5 channels, depending on the source), the two speakers in speaker system B, and the subwoofer. Multichannel sources (heard through speaker system A) are downmixed for stereo output from speaker system B.

## Bi-amping your front speakers

Bi-amping is when you connect the high frequency driver and low frequency driver of your speakers to different amplifiers (in this case, to both front and surround back terminals) for better crossover performance. Your speakers must be bi-ampable to do this (having separate terminals for high and low) and the sound improvement will depend on the kind of speakers you're using.

### 1 Connect your speakers as shown below.

This illustration below shows the connections for bi-amping your front left speaker. Hook up your front right speaker in the same way.

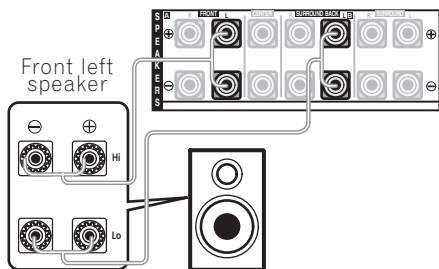

Since both front and surround back speaker terminals output the same audio, it doesn't matter which set (front or surround back) is powering which part (**Hi** or **Low**) of the speaker.

- Make sure that the + / - connections are properly inserted.

### 2 Select the **SB BIAMP** setting from the '**SB. SYSTEM**' menu.

See *Surround back speaker setting* on page 43 to specify how you're using the surround back speaker terminals.

### ⚠ Caution

- Most speakers with both **Hi** and **Low** terminals have two metal plates that connect the **Hi** to the **Low** terminals. These must be removed when you are bi-amping the speakers or you could severely damage the amplifier. See your speaker manual for more information.
- If your speakers have a removable crossover network, make sure you do not remove it for bi-amping. Doing so may damage your speakers.

## Bi-wiring your speakers

The reasons for bi-wiring are basically the same as bi-amping, but additionally, interference effects within the wire could be reduced, producing better sound. Again, to do this your speakers must be bi-wireable (that is they must have separate terminals for the high and low frequencies). When bi-wiring, make sure you've selected **SB NORM.** or **SB 2ND Z** in *Surround back speaker setting* on page 43.

- **To bi-wire a speaker, connect two speaker cords to the speaker terminal on the receiver.** Using a banana plug for the second connection is recommended.

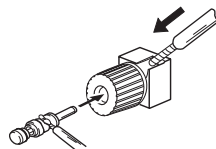

**Caution**

- Make sure you use a parallel (not series, which are fairly uncommon) connection when bi-wiring your speakers.
- Don't connect different speakers from the same terminal in this way.

**Connecting additional amplifiers**

This receiver has more than enough power for any home use, but it's possible to add additional amplifiers to every channel of your system using the pre-outs. Make the connections shown below to add amplifiers to power your speakers.<sup>1</sup>

- Before making or changing the connections, switch off the power and disconnect the power cord from the AC outlet.

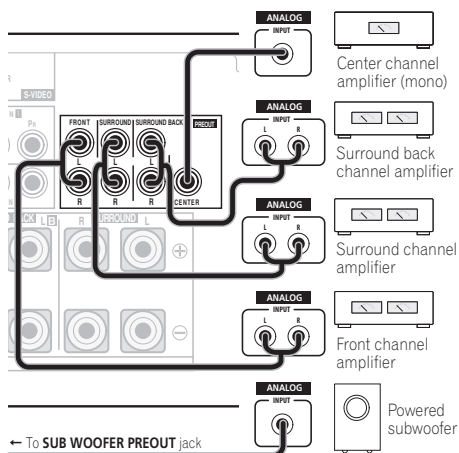
**Using this receiver with a Pioneer plasma display**

If you have a Pioneer plasma display<sup>2</sup>, you can use an SR+ cable to connect it to this unit and take advantage of various convenient features, such as automatic video input switching of the plasma display when the input is changed.

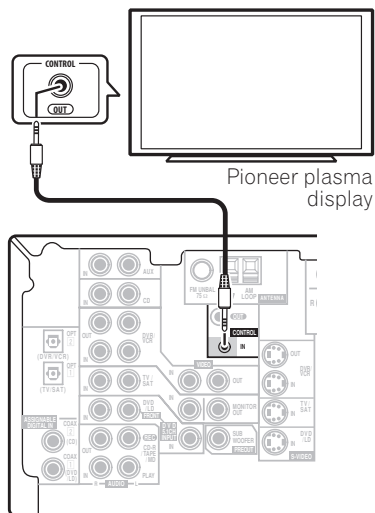
**Note**

<sup>1</sup> • You can use the additional amplifier on the surround back channel pre-outs for a single speaker as well. In this case plug the amplifier into the left (**L (Single)**) terminal only.

- The sound you hear from the surround back terminals depends on the *Surround back speaker setting* on page 43.
- To hear sound only from the pre-outs, simply disconnect any speakers that are connected directly to the receiver.
- If you're not using a subwoofer, change the front speaker setting (see *Speaker setting* on page 48) to large.

<sup>2</sup> This receiver is compatible with all Pioneer plasma displays from 2003 onward.



- Use a 3-ringed miniplug SR+ cable<sup>1</sup> to connect the **CONTROL IN** jack of this receiver with the **CONTROL OUT** of your plasma display.

Before you can use the extra SR+ features, you need to make a few settings in the receiver. See *The Input Assign menu* on page 66 for detailed instructions.

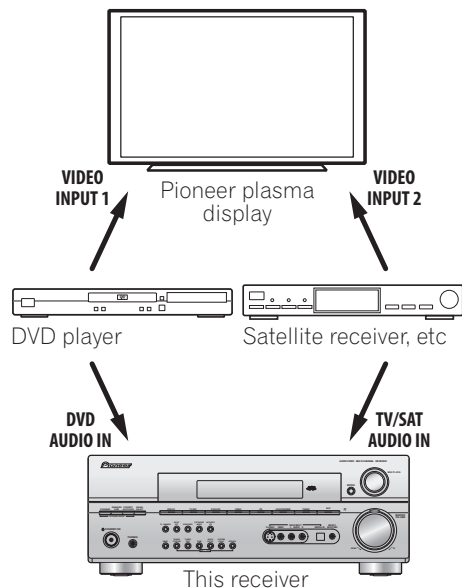

To make the most of the SR+ features, you should connect your source components (DVD player, etc.) in a slightly different way to that described in this chapter. For each component, connect the video output directly to the plasma display, and just connect the audio (analog and/or digital) to this receiver.

## Using the SR+ mode with a Pioneer plasma display

When connected using an SR+ cable, a number of features become available to make using this receiver with your Pioneer plasma display even easier. These features include:

- On-screen volume display.
- On-screen display of listening mode.
- Automatic video input switching on the plasma display.
- Automatic volume muting on the plasma display.<sup>2</sup>

See also *The Input Assign menu* on page 66 for more on setting up the receiver.

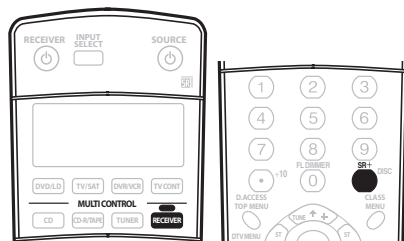

- 1 Make sure that the plasma display and this receiver are switched on and that they are connected with the SR+ cable.

See *Using this receiver with a Pioneer plasma display* above for more on this.

- 2 To switch SR+ mode on/off, press **RECEIVER**, then the **SR+** button.

The front panel display shows **SR+ ON** or **OFF**.

### Note

<sup>1</sup> • The 3-ringed SR+ cable from Pioneer is commercially available under the part number ADE7095. Contact the Pioneer Customer Support division for more information on obtaining an SR+ cable (you can also use a commercially available 3-ringed mini phone plug for the connection).

• If you connect to a Pioneer plasma display using an SR+ cable, you will need to point the remote control at the plasma display remote sensor to control the receiver. In this case, you won't be able to control the receiver using the remote control if you switch the plasma display off.

<sup>2</sup> The automatic volume muting feature is enabled separately; see *The Input Assign menu* on page 66.

## Chapter 12: Other Settings

### The Input Assign menu

You only need to make settings in the Input Assign menu if you didn't hook up your digital equipment according to the default settings for the digital inputs, or if you have connected equipment using component video cables.

#### 1 Select 'IN ASSIG.' from the System Setup menu.

See *Making receiver settings from the System Setup menu* on page 43 for more on this.

#### 2 Use ←/→ (cursor left/right) to select the setting you want to adjust then press ENTER.

- **DIG. IN** – See *Assigning the digital inputs* below.
- **COMP. IN** – See *Assigning the component video inputs* below.

### Assigning the digital inputs

- Default settings:

**COAX 1** (coaxial) – DVD

**COAX 2** (coaxial) – CD

**OPT 1** (optical) – TV

**OPT 2** (optical) – DVR

You only need to do this if you didn't hook up your digital equipment according to the default settings for the digital inputs (see above). This setting tells the receiver what digital equipment is hooked up to which terminal so the buttons on the remote correspond to what you have hooked up.

#### 1 Select 'DIG. IN' from the 'IN ASSIG.' menu.

#### 2 Select the number of the digital input to which you've connected your digital component.

Use the ←/→ (cursor left/right) buttons to do this.

- The numbers correspond with the numbers beside the inputs on the back of the receiver.

#### 3 Select the component that corresponds with the one you connected to that input.

Use the ↑/↓ (cursor up/down) buttons to select **DVD**, **TV**, **CD**, **CDR**, **DVR** or **OFF**.

- If you assign a digital input to a certain function (for example, **DVD**) then any digital inputs previously assigned to that function will automatically be switched off.

#### 4 When you're finished, press RETURN.

### Assigning the component video inputs

- Default settings:

**COMP 1** – DVD

**COMP 2** – TV

**COMP 3** – DVR

When you select an input source (**DVD/LD**, **TV/SAT**, etc.), the receiver outputs the component video signal assigned to that source. If you didn't make component video connections according to the defaults above, you must assign the numbered input to the component you've connected (or else you may see the video signal of a different component). For more on this, see *Using the component video jacks* on page 21.

#### 1 Select COMP. IN from the IN ASSIG. menu.

## 2 Select the number of the component video input to which you've connected your video component.

Use **←/→** (cursor left/right) to do this.

- The numbers correspond with the numbers beside the inputs on the back of the receiver.

## 3 Select the component that corresponds with the one you connected to that input.

Use the **↑/↓** (cursor up/down) buttons to select between **DVD**, **TV**, **DVR** or **OFF**.

- Make sure you have connected the audio from the component to the corresponding inputs on the rear of the receiver.
- If you connect any source component to the receiver using a component video input, you should also have your TV connected to this receiver's **COMPONENT VIDEO MONITOR OUT** jacks.

## 4 When you're finished, press RETURN.

## The Other setup menu

The Other menu is where you can make customized settings to reflect how you are using the receiver.

### 1 Select OTHER from the System Setup menu.

See *Making receiver settings from the System Setup menu* on page 43 for more on this.

### 2 Use **←/→** (cursor left/right) to select the setting you want to adjust then press ENTER.

If you are doing this for the first time, you may want to adjust these settings in order:

- **DRC** – Specify the amount of dynamic range adjustment to Dolby Digital soundtracks (see *Dynamic Range Control Setup* below).

- **DUALMONO** – Isolate one channel when listening to discs with dual mono encoding (see *Dual Mono Setup* below).

- **LFE ATT** – Set the attenuator level for the LFE channel (see *LFE Attenuator Setup* below).

- **SR+** – Specify how you want to control your Pioneer plasma display (see *SR+ Setup for Pioneer plasma displays* below)

### 3 Make the adjustments necessary for each setting, pressing RETURN to confirm after each menu.

## Dynamic Range Control Setup

- Default setting: **OFF**

This setting specifies the amount of dynamic range adjustment to Dolby Digital and DTS movie soundtracks. You may want to use this when listening to surround sound at low volumes.

### 1 Select DRC from the OTHER setup menu.

### 2 Use **↑/↓** (cursor up/down) to choose the setting that you want.

- **OFF** – No dynamic range adjustment (use when listening at higher volume).
- **MID** – Mid setting.
- **MAX** – Dynamic range is reduced (loud sounds are reduced in volume while quieter sounds are increased).

### 3 When you're finished, press RETURN.

## Dual Mono Setup

- Default setting: **CH1**

You can specify how dual mono encoded Dolby Digital soundtracks should be played. Dual mono is not widely used, but is sometimes necessary when two languages need to be sent to separate channels.<sup>1</sup>

### Note

<sup>1</sup> This setting works only with dual mono encoded Dolby Digital and DTS soundtracks.

- 1 Select **DUAL MONO** from the **OTHER** setup menu.
- 2 Use **↑/↓** (cursor up/down) to choose the setting that you want.
  - **CH1** – Only channel 1 is played
  - **CH2** – Only channel 2 is played
  - **CH1 CH2** – Both channels are played through the front speakers
- 3 When you're finished, press **RETURN**.

### LFE Attenuator Setup

- Default setting: **ATT 0 dB**

Some Dolby Digital and DTS audio sources include ultra-low bass tones. Set the LFE attenuator as necessary to prevent the ultra-low bass tones from distorting the sound from the speakers.

- 1 Select **LFE ATT** from the **OTHER** setup menu.
- 2 Use **↑/↓** (cursor up/down) to choose the setting that you want.
  - **LFEAT 0** – No limiting (recommended setting)
  - **LFEAT 10** – 10dB of limiting
  - **LFEAT \*\*** – No sound from LFE channel
- 3 When you're finished, press **RETURN**.

### SR+ Setup for Pioneer plasma displays

Make the following settings if you have connected a Pioneer plasma display to this receiver using an SR+ cable. Note that the number of function settings available will depend on the plasma display you've connected.

See also *Using this receiver with a Pioneer plasma display* on page 64 and *Using the SR+ mode with a Pioneer plasma display* on page 65.

- 1 Select **'SR+'** from the **OTHER** setup menu.

- 2 Use **↑/↓** (cursor up/down) and **ENTER** to select the **'VOL C.'** setting you want.

- **VOL C. OFF** – The receiver does not control the volume of the plasma display
- **VOL C. ON** – When the receiver is switched to one of the inputs that use the plasma display (**DVD/LD**, or another one of functions below), the volume on the plasma display is muted so only sound from the receiver is heard.

- 3 Assign any input source connected to the plasma display to the corresponding input number.

Use **←/→** (cursor left/right) to select the source (**DVD**, **TV**, **DVR** or **VDEO**), then **↑/↓** (cursor up/down) to select the input number.

This matches the receiver's input source with a numbered video input on the plasma display. For example, assign **DVD:3** if you have connected the your DVD video output to video input 3 on the plasma display.

- 4 When you're finished, press **RETURN**.

## Chapter 13:

# Additional information

## Troubleshooting

Incorrect operations are often mistaken for trouble and malfunctions. If you think that there is something wrong with this component, check the points below. Sometimes the trouble may lie in another component. Investigate the other components and electrical appliances being used. If the trouble cannot be rectified even after exercising the checks listed below, ask your nearest Pioneer authorized independent service company to carry out repair work.

- If the unit does not operate normally due to external effects such as static electricity disconnect the power plug from the outlet and insert again to return to normal operating conditions.

Problem	Remedy
The power does not turn on.	<ul style="list-style-type: none"> <li>• Connect the power plug to the wall outlet.</li> <li>• Disconnect the power plug from the outlet, and insert again.</li> <li>• Make sure there are no loose strands of speaker wire touching the rear panel. This could cause the receiver to shut off automatically.</li> <li>• If the power shuts off automatically, take the unit to your nearest Pioneer authorized service center or your dealer for servicing.</li> </ul>
No sound is output when a function is selected.	<ul style="list-style-type: none"> <li>• Make sure the component is connected correctly (refer to <i>Connecting up</i> on page 15).</li> <li>• Press <b>MUTE</b> on the remote control to turn muting off.</li> <li>• Press <b>SPEAKERS</b> to select the proper speaker set (see <i>Switching the speaker system</i> on page 62).</li> <li>• Press <b>SIGNAL SELECT</b> to select the proper input signal (see <i>Choosing the input signal</i> on page 38).</li> </ul>
No image is output when a function is selected.	<ul style="list-style-type: none"> <li>• Make sure the component is connected correctly (refer to <i>Connecting up</i> on page 15).</li> <li>• Select the correct component (use the input select buttons).</li> <li>• Check <i>Assigning the component video inputs</i> on page 66 to make sure you're assigned the correct input.</li> <li>• The video input selected on the TV monitor is incorrect. Refer to the instruction manual supplied with the TV.</li> <li>• <i>V SX-915 only</i> – The video converter can convert composite video to S-video, but not vice-versa (and not component video). See <i>About the video converter</i> on page 16 for more on this.</li> </ul>

Problem	Remedy
Considerable noise in radio broadcasts.	<ul style="list-style-type: none"> <li>• Tune in the correct frequency.</li> <li>• Connect the antenna (refer to page 22).</li> <li>• Route any loose cables away from the antenna terminals and wires.</li> <li>• Fully extend the FM wire antenna, position for best reception, and secure to a wall.</li> <li>• Connect an outdoor FM antenna (refer to page 22).</li> <li>• Adjust the direction and position for best reception.</li> <li>• Connect an additional internal or external AM antenna (refer to page 22).</li> <li>• Turn off the equipment causing the noise or move it away from the receiver.</li> <li>• Move antennas farther away from equipment causing the noise.</li> </ul>
Broadcast stations cannot be selected automatically.	<ul style="list-style-type: none"> <li>• Connect an outdoor antenna (refer to page 22).</li> </ul>
No sound from surround or center speakers.	<ul style="list-style-type: none"> <li>• Connect the speakers properly (refer to page 23).</li> <li>• Refer to <i>Speaker setting</i> on page 48 to check the speaker settings.</li> <li>• Refer to <i>Channel level</i> on page 49 to check the speaker levels.</li> </ul>
No sound from surround back speakers.	<ul style="list-style-type: none"> <li>• Refer to <i>Speaker setting</i> on page 48 to check the surround back speaker settings.</li> <li>• Refer to <i>Channel level</i> on page 49 to check the speaker levels.</li> <li>• Refer to <i>Using the surround back channel (Extended mode)</i> on page 39 to make sure the Extended mode and the sound mode are set for surround back sound.</li> </ul>
No sound from subwoofer.	<ul style="list-style-type: none"> <li>• Make sure the subwoofer is switched on.</li> <li>• If the subwoofer has a volume knob, make sure it's turned up.</li> <li>• The Dolby Digital or DTS source you are listening to may not have an LFE channel.</li> <li>• Switch the subwoofer setting in <i>Speaker setting</i> on page 48 to <b>YES</b> or <b>PLUS</b>.</li> <li>• Switch the <i>LFE Attenuator Setup</i> on page 68 to <b>LFEAT 0</b> or <b>LFEAT 10</b>.</li> </ul>
Noise during playback of a cassette deck.	<ul style="list-style-type: none"> <li>• Move the cassette deck further from your receiver, until the noise disappears.</li> </ul>
Sound is produced from other components, but not from LD or DVD player.	<ul style="list-style-type: none"> <li>• Set the <b>SIGNAL SELECT</b> to <b>AUTO</b>, <b>DIGITAL</b> or <b>ANALOG</b> according to the type of connections made. (refer to page 38).</li> <li>• Set the digital input settings correctly (refer to page 66).</li> <li>• Make digital connections (refer to page 17) and set the <b>SIGNAL SELECT</b> to <b>DIGITAL</b> (refer to page 38).</li> <li>• Refer to the instruction manual supplied with the DVD player.</li> </ul>

Problem	Remedy
No sound is output or a noise is output when software with DTS is played back.	<ul style="list-style-type: none"> <li>• Set the digital volume level of the player to full, or to the neutral position.</li> <li>• Make sure the player's settings are correct and/or the DTS signal out is on. Refer to the instruction manual supplied with the DVD player.</li> <li>• Set the input signal type to <b>DIGITAL</b> (see <i>Choosing the input signal</i> on page 38)</li> </ul>
When a search is performed by a DTS compatible CD player during playback, noise is output.	<ul style="list-style-type: none"> <li>• This is not a malfunction, but be sure to turn the volume down to prevent the output of loud noise from your speakers.</li> </ul>
Everything seems to be set up correctly, but the playback sound is odd.	<ul style="list-style-type: none"> <li>• Check that the positive/negative speaker terminals on the receiver are matched with the corresponding terminals on the speakers (see <i>Connecting the speakers</i> on page 23).</li> </ul>
There seems to be a time lag between the speakers and the output of the subwoofer.	<ul style="list-style-type: none"> <li>• See <i>Automatically setting up for surround sound (MCACC)</i> on page 12 to set up your system again using MCACC (this will automatically compensate for a delay in the subwoofer output).</li> </ul>
After using the Auto MCACC Setup, the speaker size setting ( <b>LARGE</b> or <b>SMALL</b> ) is incorrect.	<ul style="list-style-type: none"> <li>• Low-frequency noise could have been caused by an air conditioner or motor. Switch off all appliances in the room and rerun the Auto MCACC Setup.</li> </ul>
Can't operate the remote control.	<ul style="list-style-type: none"> <li>• Replace the batteries (refer to page 7).</li> <li>• Operate within 23 ft. (7 m), 30° of the remote sensor on the front panel (refer to page 33).</li> <li>• Remove the obstacle or operate from another position.</li> <li>• Avoid exposing the remote sensor on the front panel to direct light.</li> <li>• Unplug anything connected to the <b>CONTROL IN</b> jack and use remote normally (see <i>Operating other Pioneer components</i> on page 26).</li> </ul>
The SR cable is connected, but the connected components can't be operated with the remote.	<ul style="list-style-type: none"> <li>• Reinsert the SR cable, making sure it's connected to the right jack (see <i>Operating other Pioneer components</i> on page 26).</li> <li>• Make sure an analog connection has been made between the units.</li> <li>• This feature only works with Pioneer products.</li> </ul>
The display is dark or off.	<ul style="list-style-type: none"> <li>• Press <b>FL DIMMER</b> on the remote control repeatedly to return to the default.</li> </ul>

## Resetting the main unit

Use this procedure to reset all the receiver's settings to the factory default. Use the front panel controls to do this.

- 1 **Switch the receiver into standby.**
- 2 **While holding down the TONE button, press and hold the  $\odot$  STANDBY/ON button for about three seconds.**
- 3 **When you see RESET? appear in the display, press ENTER.**  
OK? shows in the display.
- 4 **Press SYSTEM SETUP to confirm.**  
OK appears in the display to indicate that the receiver has been reset to the factory default settings.

## Switching the speaker impedance

We recommend using speakers of  $8\Omega$  with this system, but it is possible to switch the impedance setting if you plan to use speakers with a  $6\Omega$  impedance rating.

- **With the receiver in standby, press  $\odot$  STANDBY/ON while holding down the SPEAKERS button.**

Each time you do this, you switch between the impedance settings:

- **SP 6 OHM** – Use this setting if your speakers are rated at  $6\Omega$ .
- **SP 8 OHM** – Use this setting if your speakers are rated at  $8\Omega$  or more.



## Specifications

### Amplifier section

- Continuous power output (stereo)<sup>1</sup>**

Front:

VSX-815 . . . 100 W (20–20,000 Hz, THD 0.7%, 8 Ω)

VSX-915 . . . 120 W (20–20,000 Hz, THD 0.7%, 8 Ω)

- Continuous power output (surround)**

VSX-815 model:

Front . . . . . 100 W per channel (1kHz, 1.0%, 8 Ω)

Center . . . . . 100 W (1kHz, 1.0%, 8 Ω)

Surround . . . . . 100 W per channel  
(1kHz, 1.0%, 8 Ω)

Surround Back. . . . . 100 W per channel  
(1kHz, 1.0%, 8 Ω)

VSX-915 model:

Front . . . . . 110 W per channel (1kHz, 1.0%, 8 Ω)

Center . . . . . 110 W (1kHz, 1.0%, 8 Ω)

Surround . . . . . 110 W per channel  
(1kHz, 1.0%, 8 Ω)

Surround Back. . . . . 110 W per channel  
(1kHz, 1.0%, 8 Ω)

- Total harmonic distortion**

VSX-815 . . . . . 0.09% (1kHz, 100 W, 8 Ω)

VSX-915 . . . . . 0.09% (1kHz, 120 W, 8 Ω)

### Audio section

- Input (Sensitivity/Impedance)**

CD, DVR/VCR, CD-R/TAPE/MD,  
DVD/LD, TV/SAT. . . . . 200 mV/47 kΩ

- Frequency response**

CD, DVR/VCR, CD-R/TAPE/MD, DVD/LD,  
TV/SAT . . . . . 5 Hz to 100,000 Hz ±3 dB

- Output (Level/Impedance)**

DVR/VCR REC, CD-R/TAPE/  
MD REC . . . . . 200 mV/2.2 kΩ

- Tone control**

Bass . . . . . ± 6 dB (100 Hz)  
Treble . . . . . ± 6 dB (10 kHz)  
Loudness . . . . . +10 dB/+5 dB (100 Hz/10 kHz)  
(at volume level –50 dB)

- Signal-to-Noise Ratio (IHF, short circuited, A network)**

CD, DVR/VCR, CD-R/TAPE/MD,  
DVD/LD, TV/SAT . . . . . 96 dB

- Signal-to Noise Ratio [EIA, at 1 W (1 kHz)]**

CD, DVR/VCR, CD-R/TAPE/MD,  
DVD/LD, TV/SAT . . . . . 79 dB

### Video Section

- Input (Sensitivity/Impedance)**

DVR/VCR, DVD/LD, TV/SAT . . . . . 1 Vp-p/75 Ω

- Output (Level/Impedance)**

DVR/VCR, MONITOR OUT . . . . . 1 Vp-p/75 Ω

- Frequency response**

DVR/VCR, DVD/LD,  
TV/SAT ⇔ MONITOR . . . . . 5 Hz to 7 MHz ±3 dB  
Signal-to-Noise Ratio . . . . . 55 dB  
Crosstalk . . . . . 50 dB

### Component video section

- Input (Sensitivity)**

DVD/LD, TV/SAT, DVR/VCR . . . . . 1 Vp-p/75 Ω

- Output (Level/Impedance)**

MONITOR OUT . . . . . 1 Vp-p/75 Ω

- Frequency response**

DVD/LD, TV/SAT,  
DVR/VCR ⇔ MONITOR . . . 5 Hz to 40 MHz ±3 dB  
Signal-to-Noise Ratio . . . . . 60 dB

#### Note

<sup>1</sup> Continuous average power output of 100 watts (VSX-815) / 120 watts (VSX-915)\* per channel, min., at 8ohms, from 20 Hz to 20,000 Hz with no more than 0.2%\*\* total harmonic distortion (front).

\* Measured pursuant to the Federal Trade Commission's Trade Regulation rule on Power Output Claims for Amplifiers.

\*\* Measured by Audio Spectrum Analyzer.

### • FM Tuner Section

Frequency Range . . . . .	87.5 MHz to 108 MHz
Usable Sensitivity . . . . .	Mono: 13.2 dBf, IHF (1.3 $\mu$ V/ 75 $\Omega$ )
50 dB Quieting Sensitivity . . . . .	Mono: 20.2 dB Stereo: 38.6 dBf
Signal-to-Noise Ratio . . . . .	Mono: 73 dB (at 85 dBf) Stereo: 70 dB (at 85 dBf)
Distortion . . . . .	Stereo: 0.5 % (1 kHz)
Alternate Channel Selectivity . . . . .	60 dB (400 kHz)
Stereo Separation . . . . .	40 dB (1 kHz)
Frequency Response . . . . .	30 Hz to 15 kHz ( $\pm 1$ dB)
Antenna Input (DIN) . . . . .	75 $\Omega$ unbalanced

### AM Tuner Section

Frequency Range . . . . .	530 kHz to 1,700 kHz
Sensitivity (IHF, Loop antenna) . . . . .	350 $\mu$ V/m
Signal-to-Noise Ratio . . . . .	50 dB
Antenna . . . . .	Loop antenna

### Miscellaneous

Power requirements . . . . .	AC 120V / 60Hz
Power consumption . . . . .	360W / 480 VA
In standby . . . . .	0.5 W
Dimensions . . . . .	16 <sup>9</sup> / <sub>16</sub> (W) x 6 <sup>1</sup> / <sub>4</sub> (H) x 15 <sup>7</sup> / <sub>8</sub> (D) in. 420 (W) x 158 (H) x 402.5 (D) mm
Weight (without package) . . . . .	22.4 lb (10.2 kg)

### Furnished Parts

Microphone (for Auto MCACC setup) . . . . .	1
Dry cell batteries (AA size IEC R6) . . . . .	2
Remote control . . . . .	1
AM loop antenna . . . . .	1
FM wire antenna . . . . .	1
Warranty card . . . . .	1
These operating instructions	



### Note

- Specifications and the design are subject to possible modifications without notice, due to improvements.

## Power cord caution

Handle the power cord by the plug. Do not pull out the plug by tugging the cord and never touch the power cord when your hands are wet as this could cause a short circuit or an electric shock. Do not place the unit, a piece of furniture, etc., on the power cord, or pinch the cord. Never make a knot in the cord or tie it with other cords. The power cords should be routed such that they are not likely to be stepped on. A damaged power cord can cause a fire or give you an electrical shock. Check the power cord once in a while. When you find it damaged, ask your nearest Pioneer authorized service center or your dealer for a replacement.

## Cleaning the unit

- Use a polishing cloth or dry cloth to wipe off dust and dirt.
- When the surface is dirty, wipe with a soft cloth dipped in some neutral cleanser diluted five or six times with water, and wrung out well, and then wipe again with a dry cloth. Do not use furniture wax or cleansers.
- Never use thinners, benzene, insecticide sprays or other chemicals on or near this unit, since these will corrode the surface.



## Dear Customer:

Selecting fine audio equipment such as the unit you've just purchased is only the start of your musical enjoyment. Now it's time to consider how you can maximize the fun and excitement your equipment offers. This manufacturer and the Electronic Industries Association's Consumer Electronics Group want you to get the most out of your equipment by playing it at a safe level. One that lets the sound come through loud and clear without annoying blaring or distortion-and, most importantly, without affecting your sensitive hearing.

Sound can be deceiving. Over time your hearing "comfort level" adapts to higher volumes of sound. So what sounds "normal" can actually be loud and harmful to your hearing. Guard against this by setting your equipment at a safe level BEFORE your hearing adapts.

### To establish a safe level:

- Start your volume control at a low setting.
- Slowly increase the sound until you can hear it comfortably and clearly, and without distortion.

### Once you have established a comfortable sound level:

- Set the dial and leave it there.

Taking a minute to do this now will help to prevent hearing damage or loss in the future. After all, we want you listening for a lifetime.

## We Want You Listening For A Lifetime

Used wisely, your new sound equipment will provide a lifetime of fun and enjoyment. Since hearing damage from loud noise is often undetectable until it is too late, this manufacturer and the Electronic Industries Association's Consumer Electronics Group recommend you avoid prolonged exposure to excessive noise. This list of sound levels is included for your protection.

### Decibel

#### Level Example

30	Quiet library, soft whispers
40	Living room, refrigerator, bedroom away from traffic
50	Light traffic, normal conversation, quiet office
60	Air conditioner at 20 feet, sewing machine
70	Vacuum cleaner, hair dryer, noisy restaurant
80	Average city traffic, garbage disposals, alarm clock at two feet.

### THE FOLLOWING NOISES CAN BE DANGEROUS UNDER CONSTANT EXPOSURE

90	Subway, motorcycle, truck traffic, lawn mower
100	Garbage truck, chain saw, pneumatic drill
120	Rock band concert in front of speakers, thunderclap
140	Gunshot blast, jet plane
180	Rocket launching pad

Information courtesy of the Deafness Research Foundation.



5001\_En

Should this product require service in the U.S.A. and you wish to locate the nearest Pioneer Authorized Independent Service Company, or if you wish to purchase replacement parts, operating instructions, service manuals, or accessories, please call the number shown below.

8 0 0 - 4 2 1 - 1 4 0 4

Please do not ship your product to Pioneer without first calling the Customer Support Division at the above listed number for assistance.

Pioneer Electronics (USA) Inc.  
Customer Support Division  
P.O. BOX 1760, Long Beach,  
CA 90801-1760, U.S.A.

For warranty information please see the Limited Warranty sheet included with your product.

Should this product require service in Canada, please contact a Pioneer Canadian Authorized Dealer to locate the nearest Pioneer Authorized Service Company in Canada. Alternatively, please contact the Customer Satisfaction Department at the following address:

Pioneer Electronics of Canada, Inc.  
Customer Satisfaction Department  
300 Allstate Parkway, Markham, Ontario L3R OP2  
1(877)283-5901

For warranty information please see the Limited Warranty sheet included with your product.

Si ce produit doit être réparé au Canada, veuillez vous adresser à un distributeur autorisé Pioneer du Canada pour obtenir le nom du Centre de Service Autorisé Pioneer le plus près de chez-vous. Vous pouvez aussi contacter le Service à la clientèle de Pioneer:

Pioneer Électroniques du Canada, Inc.  
Service à la clientèle  
300, Allstate Parkway, Markham, Ontario L3R OP2  
1(877)283-5901

Pour obtenir des renseignements sur la garantie, veuillez vous reporter au feuillet sur la garantie restreinte qui accompagne le produit.

5018\_A\_EF

Published by Pioneer Corporation  
Copyright©2004 Pioneer Corporation  
All rights reserved

## **PIONEER CORPORATION**

4-1, Meguro 1-Chome, Meguro-ku, Tokyo 153-8654, Japan

### **PIONEER ELECTRONICS (USA) INC.**

P.O. BOX 1540, Long Beach, California 90810-1540, U.S.A. TEL: (800) 421-1404

### **PIONEER ELECTRONICS OF CANADA, INC.**

300 Allstate Parkway, Markham, Ontario L3R OP2, Canada TEL: 1-877-283-5901

### **PIONEER EUROPE NV**

Haven 1087, Keetberglaan 1, B-9120 Melsele, Belgium TEL: 03/570.05.11

### **PIONEER ELECTRONICS ASIACENTRE PTE. LTD.**

253 Alexandra Road, #04-01, Singapore 159936 TEL: 65-6472-7555

### **PIONEER ELECTRONICS AUSTRALIA PTY. LTD.**

178-184 Boundary Road, Braeside, Victoria 3195, Australia, TEL: (03) 9586-6300

### **PIONEER ELECTRONICS DE MEXICO S.A. DE C.V.**

Bldv.Manuel Avila Camacho 138 10 piso Col.Lomas de Chapultepec, Mexico,D.F. 11000 TEL: 55-9178-4270

K002\_A\_En

## Free Manuals Download Website

<http://myh66.com>

<http://usermanuals.us>

<http://www.somanuals.com>

<http://www.4manuals.cc>

<http://www.manual-lib.com>

<http://www.404manual.com>

<http://www.luxmanual.com>

<http://aubethermostatmanual.com>

Golf course search by state

<http://golfingnear.com>

Email search by domain

<http://emailbydomain.com>

Auto manuals search

<http://auto.somanuals.com>

TV manuals search

<http://tv.somanuals.com>