

***Pioneer***

**AUDIO/VIDEO  
MULTI-CHANNEL RECEIVER**

**VSX-C300  
VSX-C300-S**

**Operating Instructions**

## IMPORTANT



The lightning flash with arrowhead symbol, within an equilateral triangle, is intended to alert the user to the presence of uninsulated "dangerous voltage" within the product's enclosure that may be of sufficient magnitude to constitute a risk of electric shock to persons.



**CAUTION:**  
TO PREVENT THE RISK OF ELECTRIC SHOCK, DO NOT REMOVE COVER (OR BACK). NO USER-SERVICEABLE PARTS INSIDE. REFER SERVICING TO QUALIFIED SERVICE PERSONNEL.



The exclamation point within an equilateral triangle is intended to alert the user to the presence of important operating and maintenance (servicing) instructions in the literature accompanying the appliance.

Replacement and mounting of an AC plug on the power supply cord of this unit should be performed only by qualified service personnel.

## IMPORTANT

### FOR USE IN THE UNITED KINGDOM

The wires in this mains lead are coloured in accordance with the following code :

Blue : Neutral  
Brown : Live

If the plug provided is unsuitable for your socket outlets, the plug must be cut off and a suitable plug fitted.

The cut-off plug should be disposed of and must not be inserted into any 13 amp socket as this can result in electric shock. The plug or adaptor or the distribution panel should be provided with 5 A fuse. As the colours of the wires in the mains lead of this appliance may not correspond with coloured markings identifying the terminals in your plug, proceed as follows ;

The wire which is coloured blue must be connected to the terminal which is marked with the letter N or coloured black.

The wire which is coloured brown must be connected to the terminal which is marked with the letter L or coloured red.

Do not connect either wire to the earth terminal of a three pin plug.

#### NOTE

After replacing or changing a fuse, the fuse cover in the plug must be replaced with a fuse cover which corresponds to the colour of the insert in the base of the plug or the word that is embossed on the base of the plug, and the appliance must not be used without a fuse cover. If lost replacement fuse covers can be obtained from: your dealer.

Only 5 A fuses approved by B.S.I. or A.S.T.A to B.S. 1362 should be used. **H005BEn**

Thank you for buying this Pioneer product.

Please read through these operating instructions so you will know how to operate your model properly. After you have finished reading the instructions, put them away in a safe place for future reference.

In some countries or regions, the shape of the power plug may sometimes differ from that shown in the explanatory drawings. However, the method of connecting and operating the unit is the same.



*This product complies with the Low Voltage Directive (73/23/EEC, amended by 93/68/EEC), EMC Directives (89/336/EEC, amended by 92/31/EEC and 93/68/EEC).*

**WARNING:** BEFORE PLUGGING IN THE UNIT FOR THE FIRST TIME, READ THE FOLLOWING SECTION CAREFULLY. THE VOLTAGE OF THE AVAILABLE POWER SUPPLY DIFFERS ACCORDING TO COUNTRY OR REGION, BE SURE THAT THE POWER SUPPLY VOLTAGE OF THE AREA WHERE THIS UNIT WILL BE USED MEETS THE REQUIRED VOLTAGE (E.G., 230V OR 120V) WRITTEN ON THE REAR PANEL. **H041 En**

**WARNING:** NO NAKED FLAME SOURCES, SUCH AS LIGHTED CANDLE, SHOULD BE PLACED ON THE APPARATUS. IF NAKED FLAME SOURCES ACCIDENTALLY FALL DOWN, FIRE SPREAD OVER THE APPARATUS THEN MAY CAUSE FIRE. **H044 En**

**WARNING:** THE APPARATUS IS NOT WATERPROOF, TO PREVENT FIRE OR SHOCK HAZARD, DO NOT EXPOSE THIS APPLIANCE TO RAIN OR MOISTURE AND DO NOT PUT ANY WATER SOURCE NEAR THIS APPARATUS, SUCH AS VASE, FLOWER POT, COSMETICS CONTAINER AND MEDICINE BOTTLE ETC. **H001AEn**

#### CAUTION:

THE  OFF/ ON BUTTON IS SECONDARY CONNECTED AND THEREFORE DOES NOT SEPARATE THE UNIT FROM MAINS POWER IN STANDBY POSITION. THEREFORE INSTALL THE UNIT SUITABLE PLACES EASY TO DISCONNECT THE MAINS PLUG IN CASE OF THE ACCIDENT. THE MAINS PLUG OF UNIT SHOULD BE UNPLUGGED FROM THE WALL SOCKET WHEN LEFT UNUSED FOR A LONG PERIOD OF TIME. **H017BEn**

This product is for general household purposes. Any failure due to use for other than household purposes (such as long-term use for business purposes in a restaurant or use in a car or ship) and which requires repair will be charged for even during the warranty period. **K041\_En**

## Operating Environment **H045 En**

Operating environment temperature and humidity: +5°C – +35°C (+41°F – +95°F); less than 85%RH (cooling vents not blocked)

Do not install in the following locations

- Location exposed to direct sunlight or strong artificial light
- Location exposed to high humidity, or poorly ventilated location

**VENTILATION:** When installing this unit, make sure to leave space around the unit for ventilation to improve heat radiation (at least 20 cm at top, 50 cm at rear and front, and 10 cm at each side).

**WARNING:** Slot and openings in the cabinet are provided for ventilation and to ensure reliable operation of the product and to protect it from overheating, to prevent fire hazard, the openings should never be blocked and covered with items, such as newspapers, tablecloths, curtains, etc. Also do not put the apparatus on the thick carpet, bed, sofa, or fabric having a thick pile.

**H040 En**

# Features

## Compatibility with the Home Theater Formats

### Dolby Digital, DTS Sound Decoders

These highly evolved multichannel sound formats are the heart of home theater. They deliver realistic multichannel sound that can turn any living room into a theater, reproducing all the sound effects of the original movie. The VSX-C300/C300-S has the flexibility to decode all these formats.

### MPEG-2 Decoder

The MPEG-2 sound format is emerging as an important medium to deliver multichannel soundtracks, especially for music, and the VSX-C300/C300-S is fully equipped to handle MPEG-2 format discs.

### Dolby Pro Logic Decoder

This was the first multichannel sound format and many videos and other media can still be found in Pro Logic. The VSX-C300/C300-S reproduces this long-standing format with excellent clarity. With it you can get multichannel surround sound even from two channel and Dolby Surround sources. In addition, you can use this decoder with the 5-D Theater mode for a stronger surround sound effect.

## Home Theater Listening Modes

### Custom Designed Listening Modes (p.30)

These modes enhance the sound of sources from movies and music to TV and video games for a more dramatic effect. These are each designed to accentuate specific sound qualities, giving the listener a wide range of possibilities.

### Virtual Listening Mode (p.30)

This especially designed listening mode uses only two channels but through sound imaging imitates a full surround sound. It allows you to experience surround sound with only two speakers.

### Headphones Surround Mode (p.30)

This new headphone mode allows the user to get a surround-like sound while listening on headphones designed to accommodate this technology.

### Midnight Listening Mode (p.32)

The Midnight listening mode allows you to obtain excellent surround sound effects even when listening at low volumes, something that was previously impossible.

### Quiet Mode (p.30)

The Quiet mode provides good sound by smoothing out harsh noises in the soundtrack. This is achieved by reducing the bass and treble.

## Easy-to-use Remote Control

This new remote control is extremely convenient to use. One button is dedicated to one task in the control of the receiver, eliminating confusing buttons whose purpose are unclear. In addition, this remote can be used to operate a variety of other components simply by recalling the appropriate setup codes.

## Easy Setup for Quick Home Use

This receiver features an automatic setup function that senses which speakers you have hooked up and automatically sets the receiver for proper surround sound. Thus, you can start enjoying home theater immediately after hooking up your speakers and components, without worrying about difficult setup procedures.

## The Energy-saving Design

This unit is designed to use less than 1 W of energy when the receiver is in standby mode.

*Manufactured under license from Dolby Laboratories. "Dolby", "Pro Logic", and the double-D symbol are trademarks of Dolby Laboratories. Confidential unpublished works. © 1992-1997 Dolby Laboratories. All rights reserved.*

*"DTS" and "DTS Digital Surround" are trademarks of Digital Theater Systems, Inc.*

*TruSurround and the  symbol are trademarks of SRS Labs, Inc. TruSurround technology is incorporated under license from SRS Labs, Inc.*

# Contents

---

Congratulations on buying this fine Pioneer product.

Please read through these operating instructions so you will know how to operate your model properly. After you have finished reading the instructions, put them away in a safe place for future reference.

<b>Contents</b>	<b>4</b>	<b>06 Listening Modes</b>	<b>30</b>
<b>Quick Start Guide</b>	<b>5</b>	Listening Modes	30
<b>01 Introductory Information</b>	<b>9</b>	Selecting a Listening Mode	31
Checking the Supplied Accessories	9	Tone Effects	32
Installing the Receiver	9	MIDNIGHT Listening Mode	32
When Making Cable Connections	9	<b>07 Using the Tuner</b>	<b>33</b>
Loading the Batteries	10	Finding a Station	33
Operating Range of Remote Control Unit	10	Tuning Directly to a Station	34
Maintenance of External Surfaces	10	Memorizing Stations	34
<b>02 Connecting Your Equipment</b>	<b>11</b>	Naming Memorized Stations	35
Connecting a DVD Player & a TV	11	Recalling Memorized Stations	35
Audio/Video Cords	11	An Introduction to RDS	36
Optical Cables	11	Searching for RDS Programs	37
Connecting a Digital Tuner/Set Top Box	12	<b>08 Using Other Functions</b>	<b>38</b>
Connecting a TV with an Internal Digital Tuner	12	Muting the Sound	38
Connecting Video Components	13	Using the Headphones	38
Connecting Speakers	14	Changing the Display Brightness	38
Hints on Speaker Placement	15	Checking your Settings	39
Connecting Antennas	16	Analog Input Mode	39
Using External Antennas	16	Resetting the System	39
Operating other Pioneer Components with this Unit's Sensor	17	Default Settings for the Receiver	40
Plugging in the Receiver	17	<b>09 Controlling the Rest of Your System</b>	<b>41</b>
<b>03 Displays &amp; Controls</b>	<b>18</b>	Changing the Remote Control Mode	41
Front Panel	18	Recalling Preset Codes	42
Rear Panel	19	Clearing the Preset Codes	43
Remote Control	20	Direct Selection	43
<b>04 Basic Playback</b>	<b>22</b>	CD/MD/CD-R/VCR/DVD/LD/DVD recorder/ Cassette Deck Controls	44
Automatic Switching between Analog & Digital Signals	22	Cable TV/Satellite TV/Digital TV/TV Controls	45
Checking the Settings on Your DVD (or other) Player	22	Preset Code List	46
Playing a Source	23	<b>10 Additional Information</b>	<b>49</b>
<b>05 Fine Tuning Your Surround Sound</b>	<b>24</b>	Troubleshooting	49
Room Setup	24	<b>11 Techno Know How</b>	<b>52</b>
Personalizing Your Surround Sound	25	Understanding DVD Packaging	52
Setting the Volume Level of Each Channel	29	Digital Audio Formats	52
		Recording Formats	53
		Playback Formats	54
		Specifications	55

## Home Theater: The Basics

Most consumers are used to using stereo equipment to listen to music but many people are not used to home theater systems that give you many more options when listening to soundtracks. In fact, home theater is not really complicated and this little guide should give you an understanding of basics.

The main reasons why it seems so difficult is that there are three different factors involved in home theater and each will contribute to what kind of sound you get.

These factors are:

- 1) The equipment you are using for your home theater set up. Particularly important is the number of speakers you are using. We call this your speaker configuration. The default settings should be fine in most cases.
  - 2) The 'source' material you are using. This is the actual product (like a DVD) or broadcast (like cable TV) you are listening to/watching. We call this the source.
  - 3) The last factor is the listening mode you choose on the VSX-C300/C300-S receiver. These are explained below and in subsequent chapters but most likely the default setting will be fine.
- Let's start with the home theater set up you have in your home.

## Your Home System

The heart of your system is the VSX-C300/C300-S receiver and it is very flexible in getting you theater-like surround sound. You can use this receiver with anywhere from two to five speakers (front left, front right, center, surround left and right) and a subwoofer to get home theater surround sound. However we recommend you use five speakers. If you only have two speakers choose the Listening mode that offers surround sound for your home setup. Also, a DVD player is essential for home theater and you can also hook up satellite or cable TV tuner to this receiver and get a more home theater like sound from those programs.

## The Source Material

DVDs have become the basic source material for home theater because they offer excellent sound and picture quality, allow users to choose the movies they want, and are easy to store, etc. You can also enjoy home theater with other sources, such as digital satellite TV, cable TV and VHS videotapes. The important part here is all these sources have soundtracks recorded on them with various kinds of technology (this is called the sound encoding). Home theater sources are recorded (encoded) with multiple sound channels, that is discrete parts of the overall sound. CDs (which are stereo sources) work the same way but they only have two sound channels, the left channel and the right channel. These two channels carry different parts of the soundtrack and mix together when you hear it to make an enjoyable, stereo sound. The same idea applies to home theater sources except home theater sources are recorded with multichannels, that is, more than two channels. For example, Dolby Pro Logic encoding has four channels (front left, front right, center and a single channel for both surround speakers), Dolby Digital, DTS, and MPEG-2 encoding usually have six channels (front left, front right, center, surround left and right and a channel that powers the subwoofer). Since the subwoofer channel is only for bass sounds this multichannel set up has been named 5.1 channel sound. These multiple channels are what create a surround sound effect and give you the experience of being in a movie theater. It is important you consult the manual that came with your DVD player as well to make sure the player is outputting a surround soundtrack and all the other settings are appropriate for home theater.

## The Listening Modes

This receiver has many different listening modes and they are designed to cover all the speaker configurations and types of sources you might be using. In general, if you follow the recommend advice and have five speakers hooked up in most cases the AUTO listening mode is the easiest way to get realistic home theater sound. This is the default setting so you don't have to do anything. Other possibilities (like listening to a stereo CD with all five speakers or, conversely taking a stereo source and it getting multichannel home theater-like sound) are explained in Listening modes (page 30).

These are the three basic factors that contribute to your home theater sound. The easiest thing is to hook up five speakers and simply play your DVDs with AUTO mode. This will give you realistic and enjoyable home theater sound.

# Quick Start Guide

## No Frills Setup

This receiver was designed with the easiest possible setup in mind so if you just want to hook up your equipment and start enjoying quality home theater movies follow the four steps below and use these easy settings on the VSX-C300/C300-S. In most cases you can leave the receiver in the default settings.

### Default Settings:

- Speaker Setting: Automatically sensed by the receiver
- Input Setting: DVD
- Analog/Digital Signal Select: Digital has priority but analog will play automatically if it is the only signal
- Listening Mode: AUTO

## 1) Hook up your DVD player, speakers, subwoofer and TV.

First, look on the back of your DVD player and figure out if it has an optical output (if you're not sure consult the manual that came with your DVD player). If it does hook up your DVD player to this receiver with this digital terminal. If your DVD player doesn't have an optical digital output hook the player up with the analog terminals. Then, hook up the speakers you want to use with this receiver. This receiver can be used with just two speakers but it's better to have five speakers to get accurate surround sound. See page 14 for more details on connecting your speakers. Next, hook up your powered subwoofer, if you have one. For all speakers make sure to connect the positive (+) and negative (-) terminals on the receiver and speakers with the same wire (positive to positive, negative to negative).

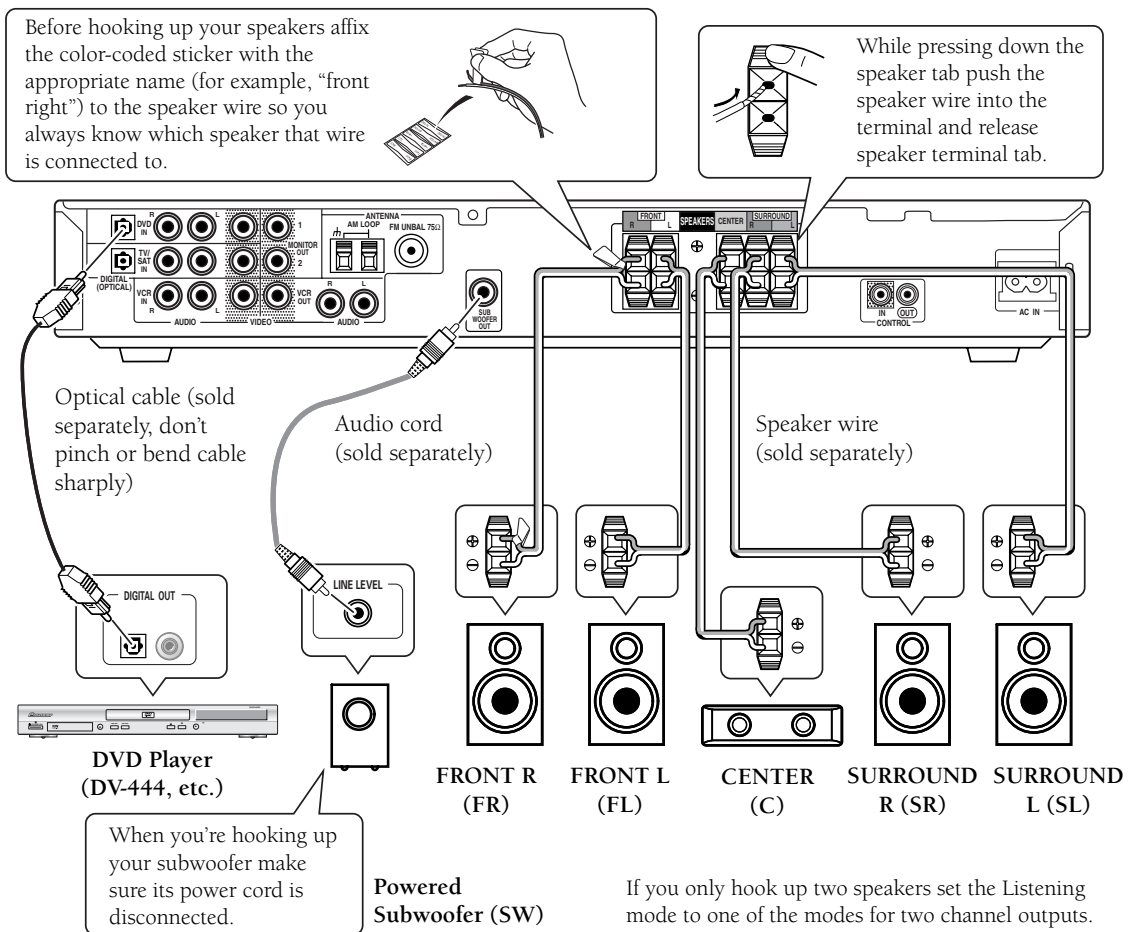

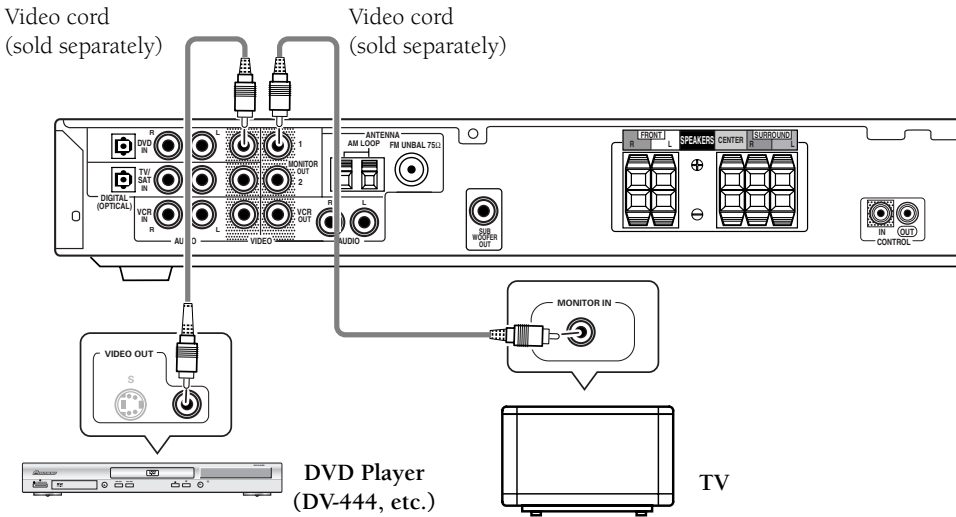

Lastly, hook up your DVD player to the DVD IN VIDEO and your TV to the MONITOR OUT VIDEO terminals as shown above.

### Automatic speaker setup (receiver automatically configures Front, Center Surround speakers and Subwoofer)

Once you have completed the above tasks, the receiver will automatically detect which speakers you have connected and configure your speaker settings according to that. You don't have to do anything. This setup establishes the size and configuration of the speaker system you have connected and is the easy way to setup your speakers for surround sound. If you don't have surround speakers or want to make more exact speaker settings should go to page 25.

The Automatic speaker setup will give you acceptable surround sound.

FRONT	CENTER	SURROUND	SUBWOOFER	Display 1	Display 2
S (SMALL)	S (SMALL)	S (SMALL)	ON	FS - CS - SS - S0	SUBWF ON-S0
L (LARGE)	S (SMALL)	S (SMALL)	OFF	FL - CS - SS - S0	SUBWFOFF-S0
S (SMALL)	_ (NONE)	S (SMALL)	ON	FS - C _ - SS - S0	SUBWF ON-S0
L (LARGE)	_ (NONE)	S (SMALL)	OFF	FL - C _ - SS - S0	SUBWFOFF-S0

## 2) Turn on the power on the receiver, your DVD player, your powered subwoofer and TV.

- Make sure your TV is set to the receiver. If it is not, check the input jack this receiver is hooked up to on your TV and consult the manual that came with the TV to figure out the proper TV setting.
- Confirm that "DVD" appears in the receiver's display, indicating that the receiver is set to the DVD input. If it does not, press the DVD button to set the receiver to DVD input.

## 3) Confirm the settings on your DVD player are correct for the source you want to play.

Make sure your DVD player is outputting a digital signal and choose the soundtrack (Dolby Digital, DTS, etc.) that you want to hear. If you are unsure about your DVD player's settings, see page 22 for more information and/or consult the manual that came with your DVD player.

## 4) Play a source (like a DVD) and adjust the volume to your liking.

You are now ready to experience home theater with your new surround sound system.

# Quick Start Guide

---

## Advanced/Customized Settings

If you want to customize your home theater to your environment, equipment or personal tastes, many settings are available. One of the most important advanced settings, called Room Setup, establishes the distances between your speakers and your normal listening position (as well as volume levels, etc.). Making this setting should improve your surround sound. Room Setup is explained on page 24. After that you could go on to fine tune your surround sound for maximum sound quality. These settings start on page 25.

The VSX-C300/C300-S has many different listening modes to accommodate many different kinds of sources, speaker configurations and sound reproduction. Experiment with these features to figure out what suits your tastes. The listening mode explanations and settings start on page 30.

The above is a quick guide to getting you started with your home theater system and a few setup suggestions. It is a good idea, however, to read this manual in its entirety so you understand what you can do with the VSX-C300/C300-S and the possibilities of home theater in general. You may find many hints in these explanations that help you get better sound and let you operate all your equipment more effectively.

## Automatic Switching between Analog & Digital Signals

This receiver is equipped with the ability to automatically select a digital or analog signal depending upon what is being input. If both a digital and an analog signal are being input the receiver will give priority to the digital one. The DIGITAL indicator will light (see page 18) when the VSX-C300/C300-S is receiving a digital signal. If you have made a digital connection (see above) and are playing a digital source but the DIGITAL indicator isn't lit, meaning the receiver is not playing a digital signal, there are a number of possible reasons for this problem. Check the list below to try and find the cause.

- The power of the player sending the signal is turned off.
- The digital output of the player sending the signal is turned off (refer to the instruction manual that came with the player).
- The software or source (usually a DVD disc) you are playing doesn't output an optical signal (refer to the instruction manual that came with the player).
- Analog input mode is selected (see page 39).

### **MEMO:**

There is also a way to select an analog input whether a digital signal is being input or not. To do this see "Analog Input Mode" on page 39.



## Checking the Supplied Accessories

Please check that you've received the following supplied accessories:

- AM loop antenna
- FM wire antenna
- Power cord
- Dry cell batteries (AA Size / IEC R6P) x2
- Remote control unit
- Operating instructions
- Speaker cord labels

## Installing the Receiver

- When installing this unit, make sure to put it on a secure and level plane that is stable.
- Don't place it on the following places:
  - on a color TV (the screen may distort)
  - near a cassette deck (or close to a device that gives of a magnetic field) This may interfere with the sound.
  - in direct sunlight
  - in damp or wet areas
  - in extremely hot or cold areas
  - in places where there is a vibration or other movement
  - in places that are very dusty
  - in places that have hot fumes or oils (such as a kitchen)

## Ventilation

- When installing this unit, make sure to leave space around the unit for ventilation to improve heat dispersal (at least 20 cm at the top, 50 cm at the rear and front, and 10 cm at each side). If not enough space is provided between the unit and walls or other equipment, heat will build up inside, interfering with performance and/or causing malfunctions.
- If using a rack to hold the receiver make sure the back of the rack and the left side are open.
- Also, if you're using a case with glass doors, leave the glass doors open when using the receiver.
- Do not place on a thick carpet, bed, sofa or fabric having a thick pile. Do not cover the receiver with fabric or other covering. Anything that blocks ventilation will cause the internal temperature to rise, which may lead to breakdown or fire hazard.
- Don't place anything on top of the receiver except for a Pioneer DV-444 or 545 DVD player. If you do place one of these pieces of equipment on top of the receiver be sure to leave ventilation space over that as prescribed above.
- The receiver may become hot while in use, please take care around it.

## When Making Cable Connections

Be careful not to arrange cables in a manner that bends the cables over the top of this unit. If the cables are laid on top of the unit, the magnetic field produced by the transformers in this unit may cause a humming noise to come from the speakers.

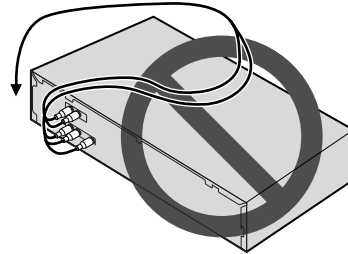

### Cassette deck placement

Depending on where the cassette deck is placed, noise may occur during playback of your cassette deck which is caused by leakage flux from the transformer in the receiver. If you experience noise, move the cassette deck farther away from the receiver.

## Storing optical cable

When storing optical cable, coil loosely as shown below. The cable may be damaged if bent around sharp corners.

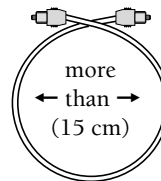

# Introductory Information

---

## Loading the Batteries

The remote control operates on two AA batteries (supplied).

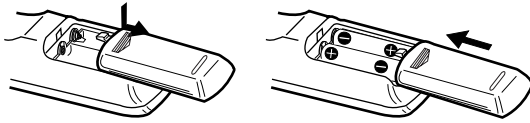

### CAUTION:

Incorrect use of batteries may result in such hazards as leakage and bursting. Observe the following precautions:

- Never use new and old batteries together.
- Insert the plus and minus sides of the batteries properly according to the marks in the battery case.
- Batteries of the same shape may have different voltages. Do not use different batteries together.
- When disposing of used batteries, please comply with governmental regulations or environmental public institution's rules that apply in your country or area.

## Operating Range of the Remote Control Unit

The remote control may not work properly if:

- There are obstacles between the remote control and the receiver's remote sensor.
- Direct sunlight or fluorescent light is shining onto the remote sensor.
- The receiver is located near a device that is emitting infrared rays.
- The receiver is operated simultaneously with another infrared remote control unit.

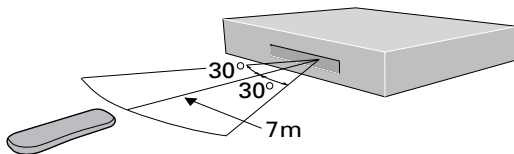

## Maintenance of External Surfaces

- Use a polishing cloth or dry cloth to wipe off dust and dirt.
- When the surfaces are dirty, wipe with a soft cloth dipped in some neutral cleanser diluted five or six times with water, and wrung out well, and then wipe again with a dry cloth. Do not use furniture wax or cleansers.
- Never use thinners, benzene, insecticide sprays or other chemicals on or near this unit, since these will corrode the surfaces.

Before making or changing the connections, switch off the power and disconnect the power cord from the AC wall outlet.

## Connecting a DVD Player & a TV

In order to play PCM/Digital/DTS/MPEG multichannel soundtracks, you need to make digital audio connections.

Connect your DVD player as shown below.

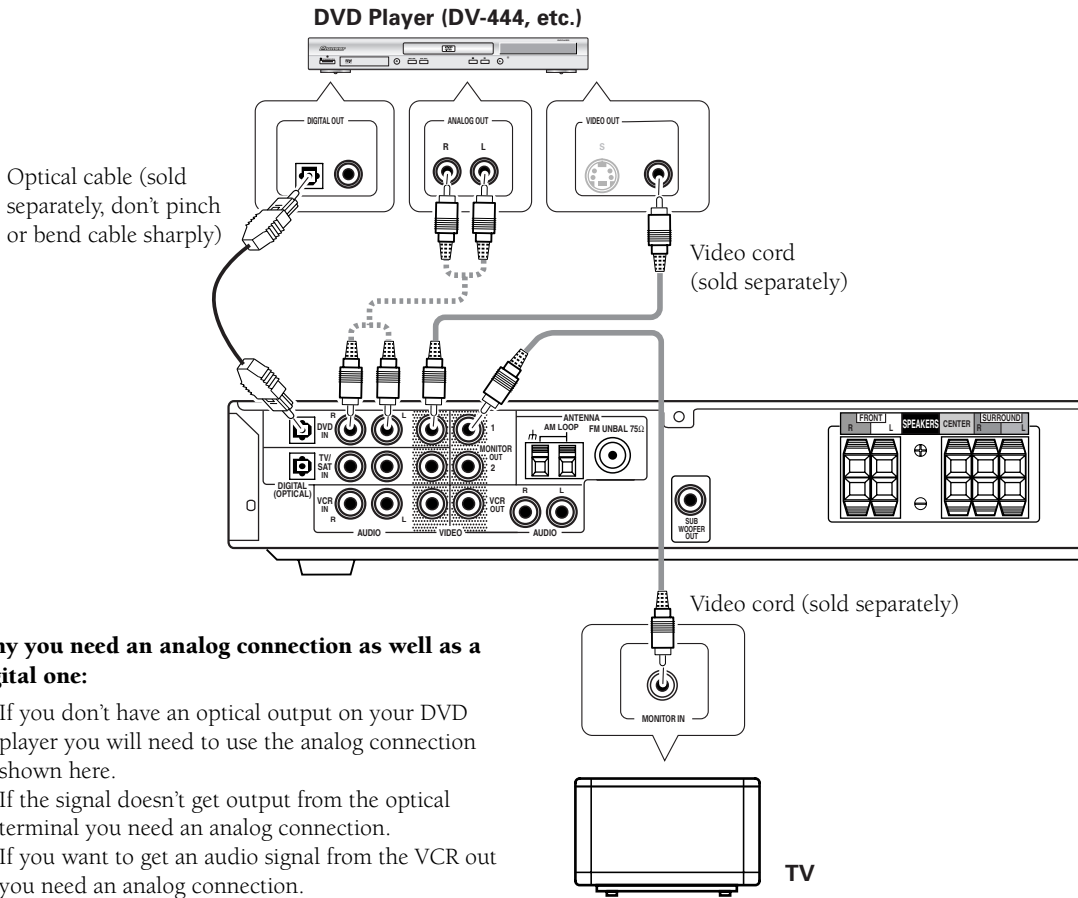

### Why you need an analog connection as well as a digital one:

- If you don't have an optical output on your DVD player you will need to use the analog connection shown here.
- If the signal doesn't get output from the optical terminal you need an analog connection.
- If you want to get an audio signal from the VCR out you need an analog connection.
- If you want to use your DVD player for karaoke you need an analog connection.

### Audio/Video Cords

Use audio/video cords (not supplied) to make analog audio and video connections. Connect red plugs to **R** (right), white plugs to **L** (left), and the yellow plugs to **VIDEO**. Be sure to insert completely.

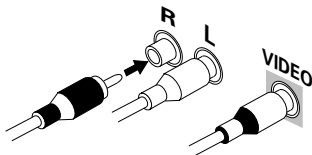

### Optical Cables

Commercially available optical cables are used to connect digital components to this receiver. When plugging in, match the shape of terminal and the plug. If you have plugged it in incorrectly the cover won't be able to close. Make sure the cover can close after you've plugged in the optical cable. Be sure to insert completely.

Optical cable

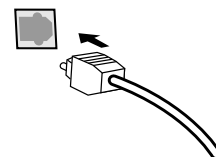

## Connecting Your Equipment

Before making or changing the connections, switch off the power and disconnect the power cord from the AC wall outlet.

### Connecting a Digital Tuner/Set Top Box

If you have an external digital tuner (like a set top box for satellite or cable TV) you need to connect it and your TV to the jacks shown below in order to play MPEG signals (which most digital satellite broadcasting uses). Make sure you use a digital connection as well as an analog one for the audio on the satellite tuner, as pictured below.

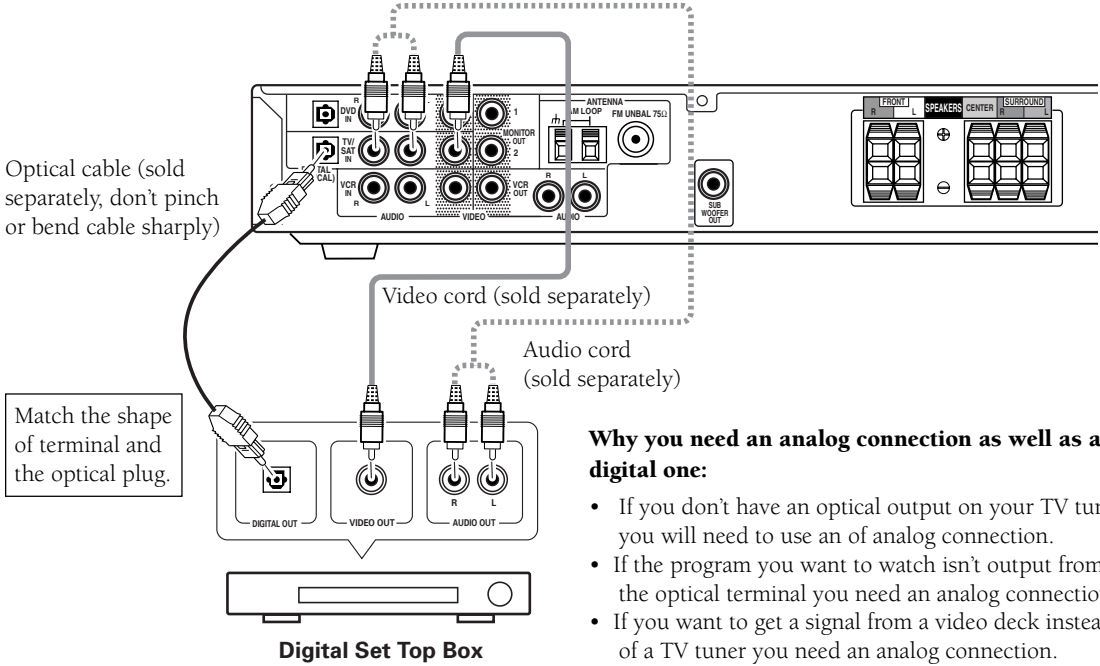

### Connecting a TV with an Internal Digital Tuner

If you have a TV with an internal digital tuner you need to connect it to the jacks shown below in order to play MPEG signals (which most digital satellite broadcasting uses). Make sure you use a digital connection as well as an analog one for the audio, as pictured below.

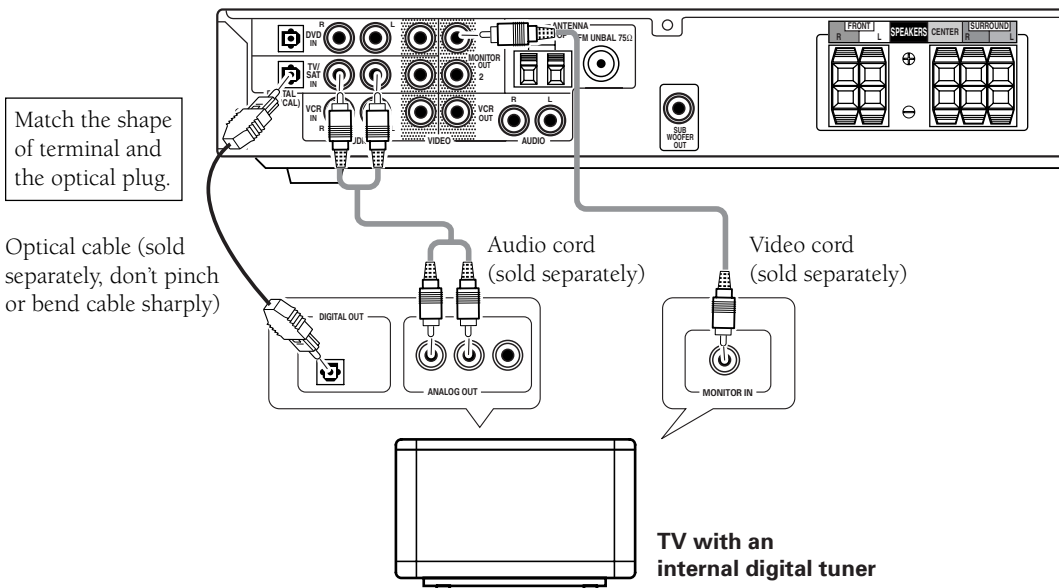

Before making or changing the connections, switch off the power and disconnect the power cord from the AC wall outlet.

### Connecting Video Components

Connect your video components to the jacks as shown below. All video decks are hooked up with analog connections. If you want to record programs it is necessary to connect to the IN terminals on your VCR as shown below.

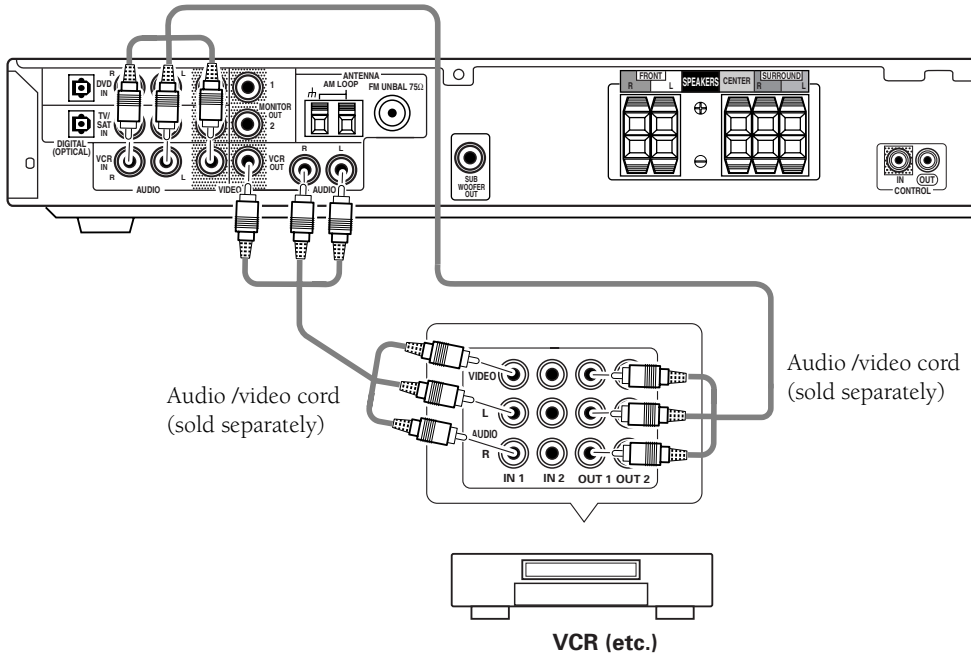

**You can only record audio signals from video components hooked up with analog connections.**

If the input component and the receiver are only connected with an optical digital cable (which is for audio) you need to connect analog video and audio cables in order to be able to record video programs with soundtracks.

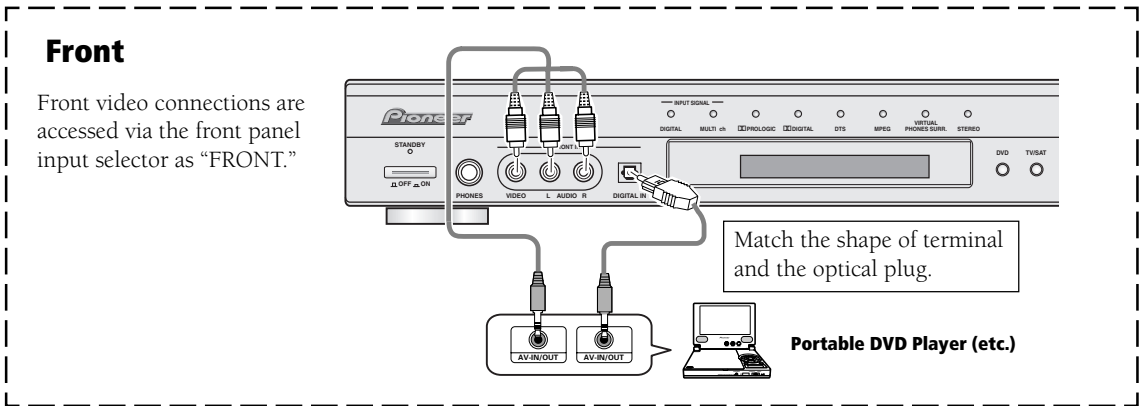

# Connecting Your Equipment

Before making or changing the connections, switch off the power and disconnect the power cord from the AC wall outlet.

## Connecting Speakers

A full complement of five speakers is shown here but, naturally, everyone's home setup will vary. Simply connect the speakers you have in the manner described below. The receiver will work with just two stereo speakers (called "front" speakers in the diagram) but we recommend you use five speakers. If you don't hook up surround speakers you need to adjust the Listening mode settings (see page 30).

Make sure you connect the speaker on the right to the right terminal and the speaker on the left to the left terminal. Also make sure the positive and negative (+/-) terminals on the receiver match those on the speakers.

**MEMO:**

- Use speakers with a nominal impedance of 6 Ω to 16 Ω.

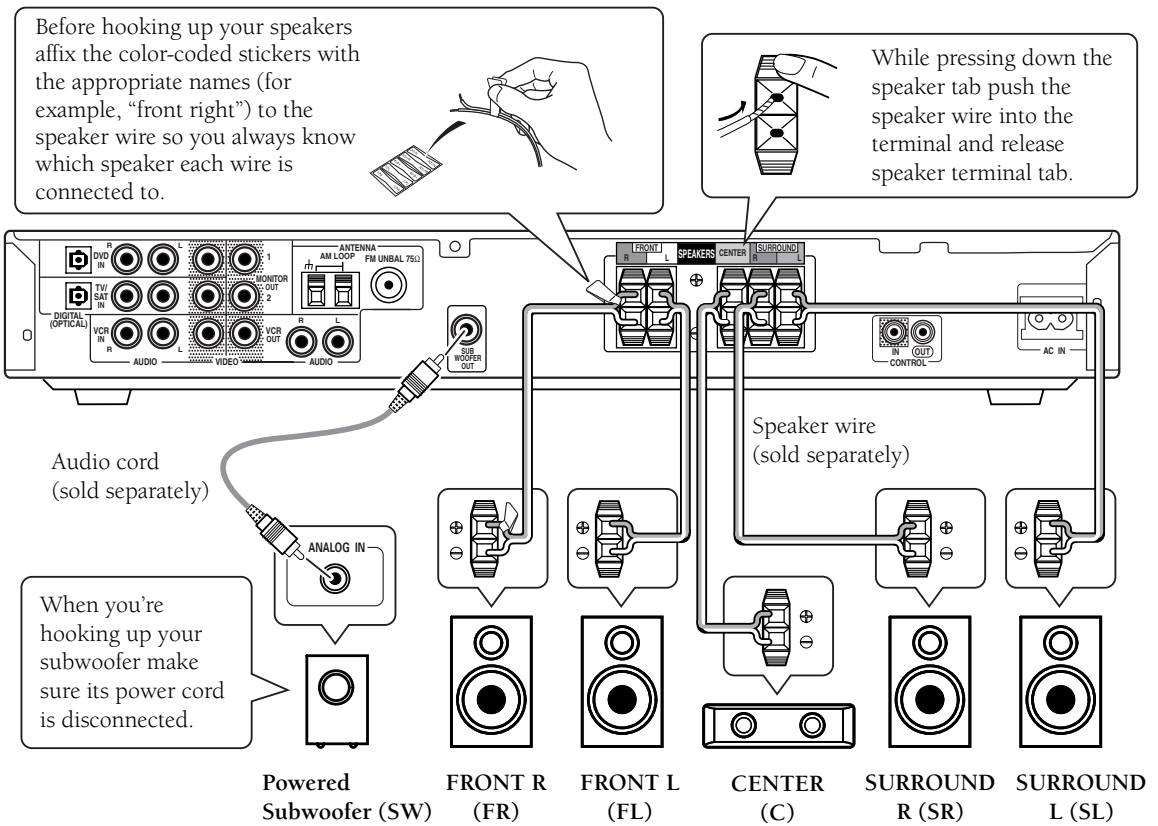

## Speaker terminals

Use good quality speaker wire to connect the speakers to the receiver.

- 1 Twist about 10 mm of bare wire strands together.
- 2 Push in the speaker terminal tab and insert the wire.
- 3 Release speaker terminal tab, it should snugly grip the speaker wire.

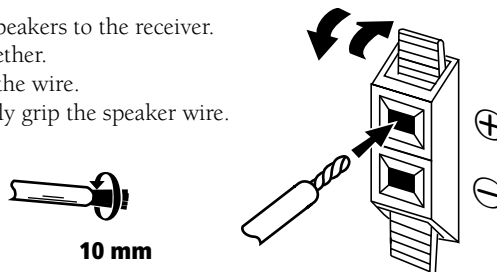

**Caution:**

Make sure that all the bare speaker wire is twisted together and inserted fully into the speaker terminal. If any of the bare speaker wire touches the back panel it may cause the power to cut off as a safety measure.

## Hints on Speaker Placement

Speakers are usually designed with a particular placement in mind. Some are designed to be floor standing, while others should be placed on stands to sound their best. Some should be placed near a wall; others should be placed away from walls. Follow the guidelines on placement that the speaker manufacturer provided with your particular speakers to get the most out of them.

- Place the front left and right speakers at equal distances from the TV.
- When placing speakers near the TV, we recommend using magnetically shielded speakers to prevent possible interference, such as discoloration of the picture when the TV is switched on. If you do not have magnetically shielded speakers and notice discoloration of the TV picture, move the speakers farther away from the TV.
- Install the center speaker above or below the TV so that the sound of the center channel is localized at the TV screen.

### CAUTION!

If you choose to install the center speaker on top of the TV, be sure to secure it by suitable means to reduce the risk of damage or injury resulting from the speaker falling from the TV in the event of external shocks such as earthquakes.

- If possible, install the surround speakers slightly above ear level.
- Try not to install the surround speakers farther away from the listening position than the front and center speakers. Doing so can weaken the surround sound effect.
- Install the subwoofer on the same plane as the front speakers.

To achieve the best possible surround sound, install your speakers as shown on the right. Be sure all speakers are installed securely to prevent accidents and improve sound quality.

Overhead view of speaker set up

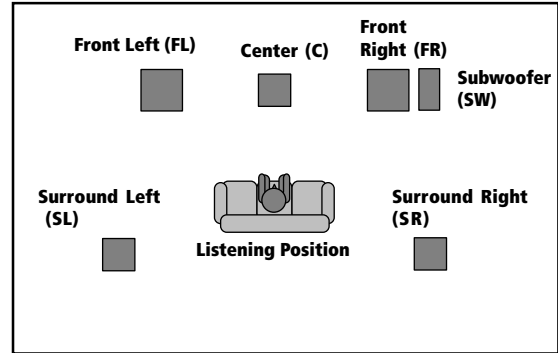

3-D view of speaker set up

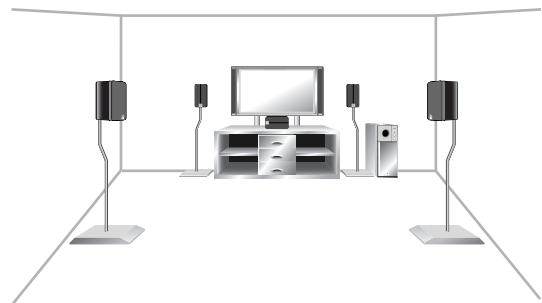

## Connecting Your Equipment

Before making or changing the connections, switch off the power and disconnect the power cord from the AC wall outlet.

### Connecting Antennas

Connect the AM loop antenna and the FM wire antenna as shown below. To improve reception and sound quality, connect external antennas (see Using External Antennas, below).

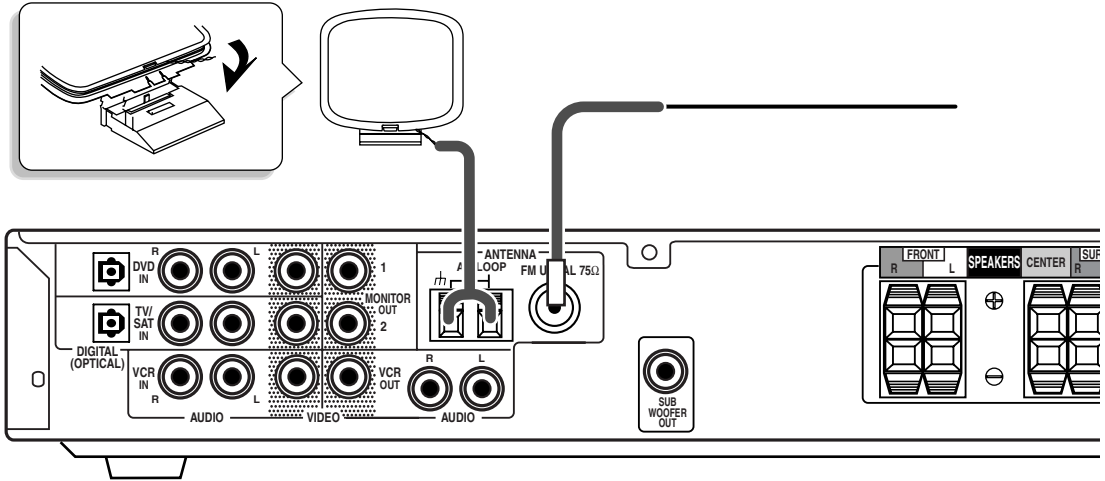

#### AM loop antenna

Assemble the antenna and connect to the receiver. Attach to a wall, etc. (if desired) and face in the direction that gives the best reception.

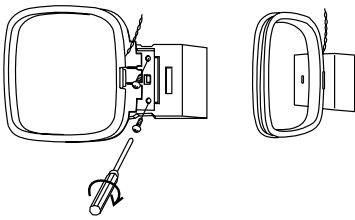

#### FM wire antenna

Connect the FM wire antenna and fully extend vertically along a window frame or other suitable area.

#### Antenna connectors

Twist the exposed wire strands together push the tab back, insert into the hole and release connector.

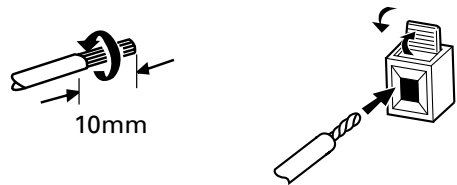

### Using External Antennas

#### To improve FM reception

Connect an external FM antenna.

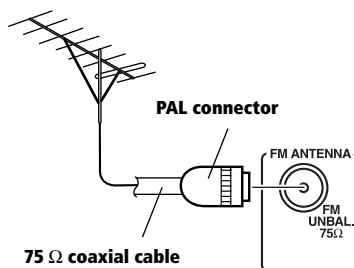

#### To improve AM reception

Connect a 5-6 m length of vinyl-coated wire to the AM antenna terminal without disconnecting the supplied AM loop antenna. For the best possible reception, suspend horizontally outdoors.

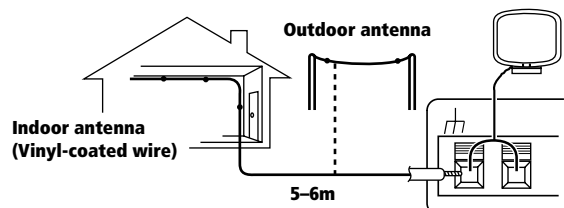



## Operating other Pioneer Components with this Unit's Sensor

By connecting a control cord to the **CONTROL** terminals of the respective equipment, you can control several Pioneer components using one remote sensor. Following the diagram below you will see that one component feeds the **CONTROL OUT** terminal and on the other end another component is connected to the **CONTROL IN** terminal. The component that is the end point (the one that has a cord hooked up to its **CONTROL OUT** only) it is the component whose sensor you will use. Point the remote control at that sensor when you want operate the any of the equipment connected by this system. In the example below you would point the remote control unit towards the remote sensor of the equipment on the left.

**MEMO:**

- You can also control Pioneer components by pointing the receiver's remote control directly at the component. This type of operation does not require control cords. See page 41 for more information.
- To use this kind of remote control you have to hook up a control cord AND the have the component and receiver hooked up with analog RCA audio/video cords as well (see page 11-13).

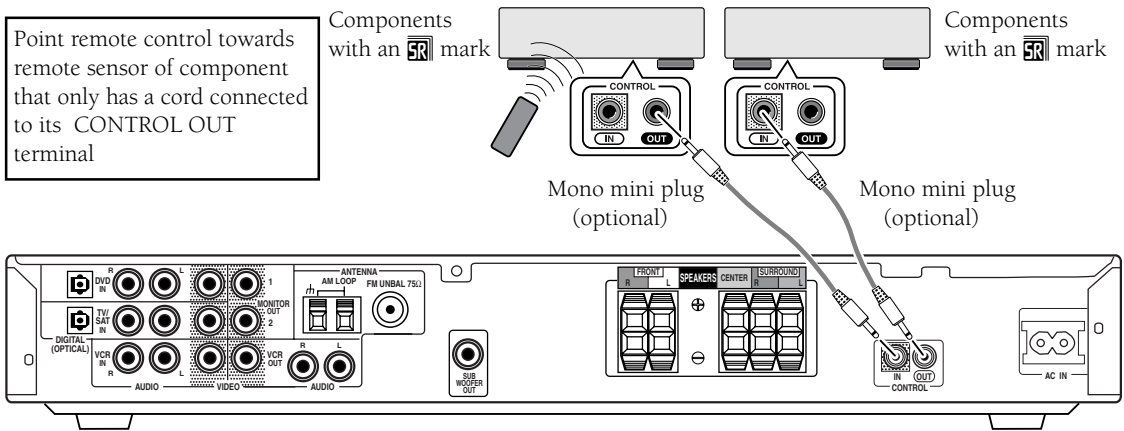

## Plugging in the Receiver

After you have connected all your components, including the speakers, plug the receiver into a wall outlet.

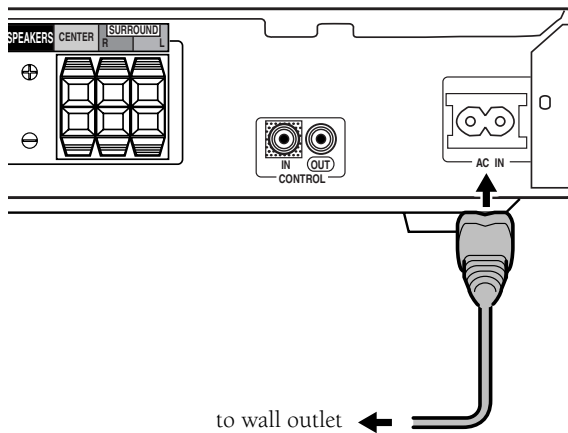

**Power cord CAUTION!**

Handle the power cord by the plug. Do not pull out the plug by tugging the cord and never touch the power cord when your hands are wet as this could cause a short circuit or electric shock. Do not place the unit or a piece of furniture, etc., on the power cord, or pinch the cord. Never make a knot in the cord or tie it with other cords. The power cords should be routed such that they are not likely to be stepped on. A damaged power cord can cause a fire or give you an electrical shock. Check the power cord once in a while. When you find it damaged, ask your nearest PIONEER authorized service center or your dealer for a replacement.

**MEMO:**

- The power cord is removable from main unit for storage.

## Front Panel

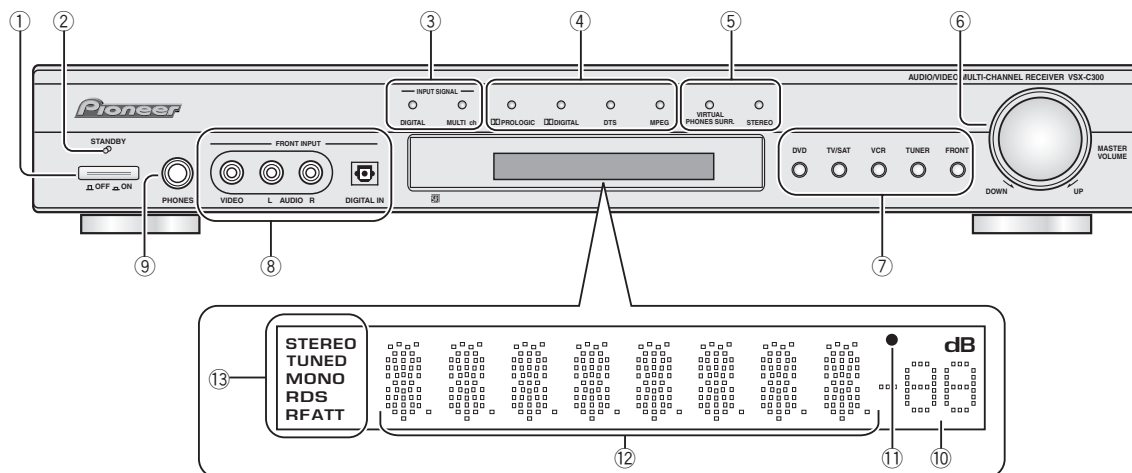

- ① **OFF/ ON (Main power) button**  
Press this button to the ON position so that the power button on the remote control will be operational. If the button is OFF (■), the power of the receiver is shut off and the RECEIVER button on the remote control does not function. When this button is ON, the power button on the remote control toggles between ON and STANDBY mode.
- ② **STANDBY indicator**  
Lights when the receiver is in standby mode. The receiver uses a small amount of electricity (1W) in standby mode.
- ③ **INPUT SIGNAL indicators**  
Indicates the kind of input signal.  
DIGITAL :  
When a digital source is input this indicator will light.  
MULTI :  
When a multichannel source is input this indicator will light.
- ④ **DECODE MODE indicators**  
Indicates how the signal is being decoded.  
■ PRO LOGIC:  
Lights when ■ PRO LOGIC decoding is in use.  
■ DIGITAL:  
Lights when playing a ■ DIGITAL sound source  
DTS:  
lights when playing a DTS sound source .  
MPEG:  
Lights when playing an MPEG source.
- ⑤ **2 Ch Listening Mode indicators**  
When these indicators are lit sound is only coming from the front speakers (and possibly the subwoofer in some settings) or headphones.
- VIRTUAL/PHONES SURR.:  
Lights when the VIRTUAL or PHONES SURR. listening modes are selected.  
STEREO: Lights in stereo mode.
- ⑥ **MASTER VOLUME**  
Use to set the overall listening volume.
- ⑦ **Input buttons**  
Use to select the playback source: the possibilities are DVD, TV/SAT, VCR, TUNER and FRONT.
- ⑧ **FRONT jacks**  
You can connect a portable DVD player, video camera, video game system, or whatever equipment you would like to have handy, to the **FRONT** jacks (refer to page 13).
- ⑨ **PHONES jack**  
Use to connect headphones (this switches the speakers off).
- 
- DISPLAY**
- ⑩ **Volume level indicator**
- ⑪ **MIDNIGHT indicator**  
Lights when Midnight Listening mode is on.
- ⑫ **CHARACTER display**  
Shows the current input (DVD, TV/SAT, etc.), listening mode, radio frequency, etc.
- ⑬ **TUNER indicators**  
STEREO: Lights when a stereo FM broadcast is being received in auto stereo mode.  
TUNED: Lights when a broadcast is being received.  
MONO: Lights when the mono mode is set using the MPX button.  
RDS: Lights when an RDS broadcast is received.  
RF ATT: Lights when the RF ATT is on (see p. 33).

Rear Panel

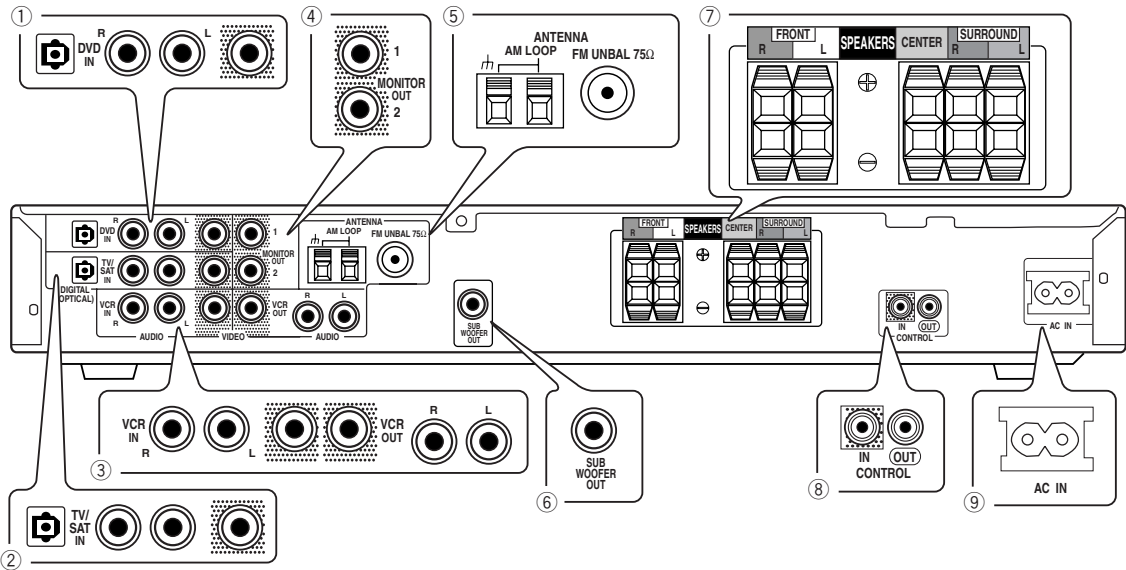

① **DVD input terminals (connect a DVD player here, see page 11)**

Use these terminals to input the signal from a DVD player (or another kind of video player, if you choose). Make sure to connect to the video terminals and both the analog and optical digital terminals for audio. To be able to play Dolby Digital and other surround soundtracks you need to make digital connections. To do this use the optical digital terminal here.

② **TV/SAT input terminals (connect a TV/SAT set top box here, see page 12)**

Use these terminals to input a TV/SAT signal (or from another kind of source, if you choose). Make sure to connect to the video terminals and both the analog and optical digital terminals for audio. To be able to play MPEG and other surround soundtracks you need to make digital connections. To do this use the optical digital terminal here.

③ **VCR IN/OUT terminals (connect a VCR here, see page 13)**

Use these terminals to input and output the video signal from a VCR (or a video camera, DVD recorder, etc.). These are analog jacks.

④ **MONITOR output terminals (connect a TV or monitor here, see page 11)**

Use these terminals to output the signal from the above terminals ①, ② or ③ and FRONT. These are video jacks. MONITOR 2 outputs the same signal as MONITOR 1.

⑤ **RADIO antenna terminals**

Connect AM or FM antennas here (see page 16).

⑥ **SUBWOOFER output terminals**

Use this terminal to connect a powered subwoofer to the receiver (see page 14).

⑦ **SPEAKER terminals**

Use these terminals to connect speakers to the receiver (see page 14).

⑧ **CONTROL IN/OUT terminal**

You can use this jack to hook up other PIONEER equipment, that bears the **SR** mark, so that you can control them all with the remote control for this receiver (see page 17).

⑨ **AC IN (Power In)**

Hook up the power cord to this terminal.

## Remote Control

The remote control is divided into roughly three parts for easier understanding: 1) Receiver controls; 2) TV controls and 3) Playback controls, sound setup and other component controls. All the buttons on the remote control are explained here.

### 1) Receiver controls

These controls are for the receiver itself.

**RECEIVER** (Power) button: This switches between STANDBY mode and power ON for this receiver.

**Input/Control Mode Select** buttons: Use to put the receiver/remote control in the input stated on the button. If the Direct Selection is off, then these buttons won't put the receiver in the input written on the button.

**Control Mode Select** buttons: Use these buttons to put the remote control in receiver or TV mode (see page 23).

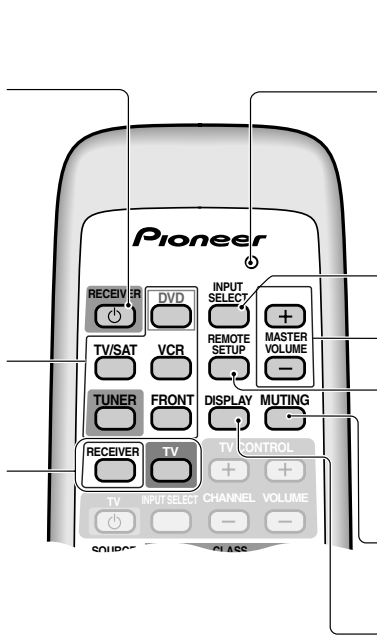

**LED indicator:** This indicator flashes when a command is sent from the remote control to the receiver. It also flashes at when teaching the receiver preset codes.

**INPUT SELECT** button (see page 23): Use to select the playback source. This button lets you cycle through the different inputs: DVD, TV/SAT, VCR, TUNER and FRONT.

**MASTER VOLUME +/-** buttons: Use to set the overall listening volume.

**REMOTE SETUP** button (see page 42): Use this button when setting up the remote control with the REMOTE SETUP feature.

**MUTING** button: Use to mute the sound or restore the sound if it has been muted.

**DISPLAY** button (see page 39): Use to display information. You can confirm what settings have been made by going through the various displays.

### 2) TV controls

These controls are for your TV. They are dedicated TV controls and will work no matter what mode the remote control is in.

**TV** (Power) button: Use to turn on/off the power of the TV.

**INPUT SELECT** button: Use to select the TV input.

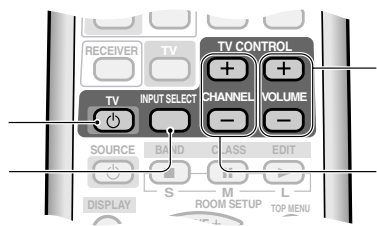

**VOLUME +/-** buttons: Use to adjust the volume on your TV.

**CHANNEL +/-** buttons: Use to select channels on your TV.

### 3) Playback controls

These controls are for the receiver, setup, and other components. If you push the RECEIVER button these buttons will control the receiver. Once you put the remote control in another mode (for example DVD) the buttons which are applicable to DVD control will be available for that component (after you have entered the proper preset codes, see page 42). For explanations of the controls on this remote control for other components see page 44-45.

**SOURCE** (Power) button: Use this button to turn on and off the power of other components.

**CH SELECT** button (see page 29): Use to select a speaker when setting the volume level of each channel.

**TEST TONE** button (see page 29): Use to sound the TEST TONE when setting the volume level of each channel.

**DIMMER** button (see page 38): Press to change the display brightness. The DIMMER button allows you to cycle through the four different brightness strengths for the display.

**2 channel listening mode buttons** (see page 30):  
**VIRTUAL** button- Press for VIRTUAL listening mode. This listening mode imitates surround sound but only uses two channels.  
**PHONES SURR.** button- Press for PHONES SURR. listening mode. This listening mode imitates surround sound for headphones (also only two channel reproduction).  
**STEREO** button- Press for STEREO listening mode. This is regular stereo reproduction (always two channel sound).

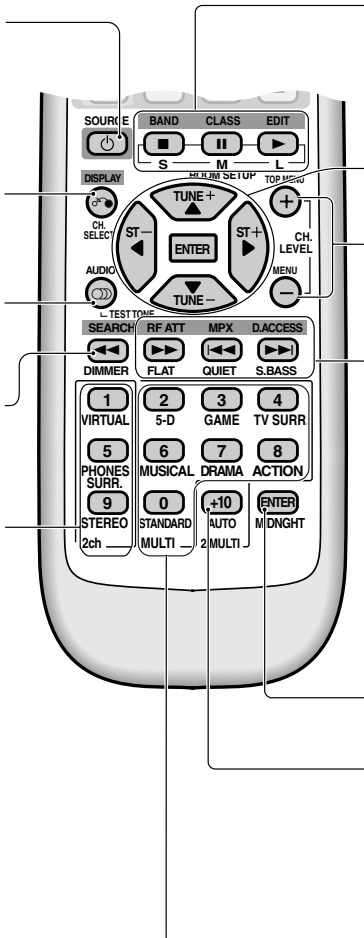

**ROOM SETUP (S-M-L)** buttons (see page 24): Use these functions when setting up the surround sound speaker distances with the Quick Start, easy-to-do method (see page 3).

**Left, Right, Up, Down & ENTER** buttons (see pages 25-28): Use these arrow buttons when setting up your surround system

**CH.LEVEL +/-** buttons (see pages 29): Use these buttons to control the volume level of each channel or add or subtract the amount of effect in a listening mode.

**Tone Effect buttons:**  
**FLAT** button (see page 32)- Press for FLAT mode. This mode plays as recorded with no tone adjustments.  
**QUIET** button (see page 32)- Press for QUIET mode. This mode is for delicate soundtracks.  
**S. BASS** button (see page 32)- Press for S.BASS mode, which adds additional bass to the sound.

**MIDNIGHT** button (see page 32): Use to put receiver in MIDNIGHT mode.

**2/MULTI channel listening mode** button (see page 30). **AUTO** button: Use to put receiver in the AUTO mode, where the receiver automatically switches between STEREO (2 ch) and STANDARD (MULTI) according to the input.

**MULTI channel listening mode buttons :**  
**STANDARD** button-Press for STANDARD listening mode. This is the basic listening mode for listening to Dolby Digital 5.1, DTS 5.1 and other surround soundtracks as well as Dolby Surround soundtracks. It offers pure decoding of the signal with no added effects. 2 channel sources will get decoded and played back as Dolby Pro Logic surround soundtracks.  
**5-D** button-Press for 5-D sound mode. This listening mode takes two channel sources and simulates surround sound.  
**GAME** button-Press for GAME listening mode. This listening mode is best for games and other soundtracks with lots of electronic sounds.  
**TV SURR.** button-Press for TV SURR. listening mode. This listening mode takes mono (TV sound) sources and simulates surround sound.  
**MUSICAL** button- Press for MUSICAL listening mode. This listening mode is best for music and other soundtracks with lots of melody.  
**DRAMA** button-Press for DRAMA listening mode. This listening mode is best for dramatic movies and other soundtracks with lots of dialog.  
**ACTION** button-Press for ACTION listening mode. This listening mode is best for action movies and other soundtracks with lots of animated sounds.

## Automatic Switching between Analog & Digital Signals

This receiver will automatically choose the digital signal when both analog and digital signals are input into the receiver.

The digital indicator will light when a digital signal is being used by the receiver. If the digital indicator doesn't light even though you have your DVD player connected with an optical cable it may be due to the problems below. Please check the list if you experience this problem.

- The power cord to the DVD player is disconnected.
- The DVD player's digital output setting is turned off.
- You're playing a disc that doesn't output a digital signal.
- You've selected the Analog input mode (see page 39).

### **MEMO:**

There is also a way to select an analog input whether a digital signal is being input or not. To do this see "Analog Input Mode" on page 39.

## Checking the Settings on Your DVD (or other) Player

If you don't set the following two features correctly you may experience problems with your surround sound (for example: no sound whatsoever; the sound is unidimensional or lacks punch; or other problems).

### **1 Digital output from your DVD player or other component outputting a digital source,**

Set the DVD player so the signals below are output from the optical terminal (if you are unsure how to do this check the manual that came with your DVD player). It may or may not be necessary to set the digital output on other components, like a satellite tuner. Check the manual that came with the component.

- Dolby Digital
- DTS
- MPEG
- 96 kHz PCM (2 channel stereo)

### **2 Checking the soundtrack on your disc**

Choose the surround sound signal (for example, Dolby Digital 5.1 or Dolby Surround) that you want to hear from the disc. Check the manual that came with your DVD player for more information.

### **MEMO:**

- Depending on your DVD player or source discs you may not be able to output sound from other than digital 2 channel stereo and analog. In this case you need to change the listening mode to STANDARD if you want multichannel surround sound.

## Playing a Source

Here are the basic instructions for playing a disc or videotape (or any other source) with your home theater system. The following pages will tell you about refinements you can make to the sound but the below procedure (with the settings you have already made) should allow you to get enjoyable home theater.

### 3 INPUT buttons    6 MASTER VOLUME

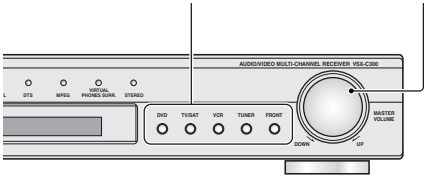

### STANDBY indicator

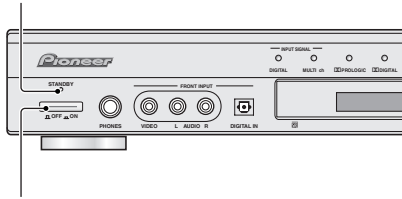

### 2 OFF ON button

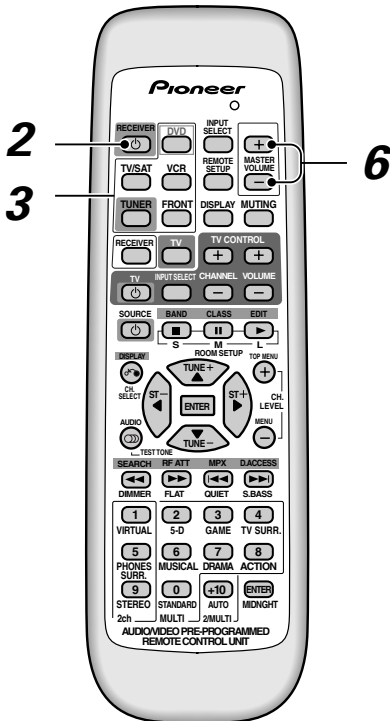

1 Turn on the power of the playback component (for example a DVD player), your TV and subwoofer (if you have one).

2 Press **RECEPTOR** to turn the power on.

The STANDBY indicator goes out. (If it's the first time for you to turn on the receiver you'll have to turn the main power on by pressing the ON/OFF button. If the STANDBY indicator lights when you do this, press the RECEPTOR button as above.)

3 Select the source (like a DVD player) you want to playback using the individual **INPUT** buttons on the remote control .

If the Direct Selection (see page 43) is off you have to use the INPUT SELECT button which cycles through the different inputs. Or, you can use the INPUT buttons on the front panel.

4 Make sure the TV is set to this receiver.

If you're not sure which input on your TV this receiver is hooked up to confirm the input jack on the back of the TV and consult the manual that came with your TV to figure out the proper setting.

5 Start playback of the component you selected in step 3.

6 Press **MASTER VOLUME (+/-)** to adjust the volume level.

#### MEMO:

- If you want to use the Analog input select the Analog input mode (see page 39).
- When you're using your TV's internal tuner the TV shouldn't be set to this receiver (step 4 above).

## Room Setup

This setup establishes the distances from your speakers to your normal listening position. It is important for the receiver to know these distances so it can output proper surround sound. Alternatively, you can make more precise speaker distance settings on page 27-28. You don't have to do both, however.

There are three choices for speaker distances here. They are marked 'S', 'M' and 'L' but they represent the relationship between how far your front speakers and your surround speakers are from your normal listening position, i.e. the relationship in distance between the speakers and your listening position. 'S' should be used when your surround speakers are nearer your main listening position than your front speakers. 'M' should be used when your all your speakers are equidistant from your main listening position. 'L' should be used when your surround speakers are farther from your main listening position than your front speakers..

Follow the instructions below to set the room type.

**S** (surround speakers closer to listening position)

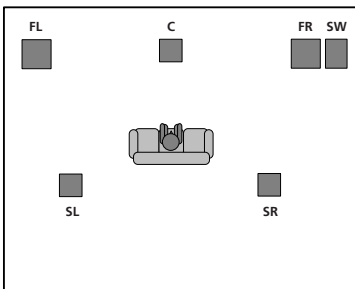

**M** (speakers are equidistant to listening position)

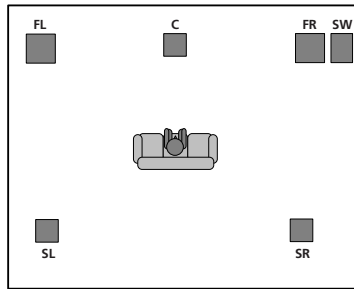

**L** (front speakers are closer to listening position)

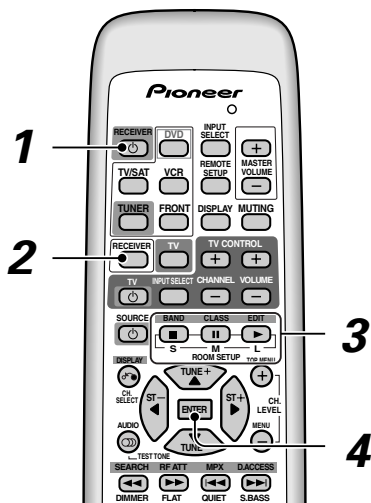
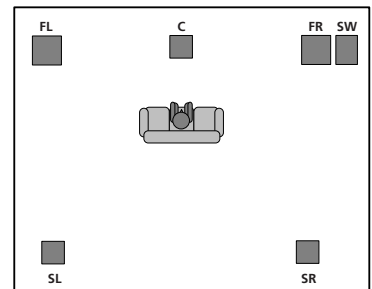

1 Press **RECEIVER** to turn the power on.

The STANDBY indicator goes out.

2 Press **RECEIVER**.

This sets the remote to select the receiver control mode.

3 Choose the setting, 'S', 'M', or 'L', that best represents the placement of your speakers around the room.



4 While the display is blinking press **ENTER**.

The setting is input into the system and the display shows ENTERED. If you fail to press ENTER while the display is blinking the setting will not be input. In this case start over from step 3.



STANDBY indicator

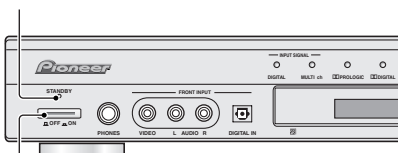

OFF ON button

**MEMO:**

- These speaker settings will automatically adjust the distance between your listening position and the speakers as well as the output level from each speaker. It is also possible to select these functions manually. To do so see below. For the distance between the listening position and the speakers see page 27-28; For the output level of each speaker see page 29.
- The settings made most recently, whether here or manually, on the pages mentioned directly above, will supercede any previous settings.
- The default setting is 'M'.



## Personalizing Your Surround Sound

This receiver will make the necessary speakers settings automatically so you can use it to get enjoyable surround sound without doing anything, but making more exact settings here will give you finer surround sound.

For better surround sound complete the instructions that follow the speaker settings. Use the first three steps on this page and continue on page 26. In this way you can get maximum performance out of the receiver.

You only need to do these settings once (unless you change the placement of your current speaker system or add new speakers, etc.). The following pages offer a more detailed description of the settings available for each mode. The default setting is also shown on each page.

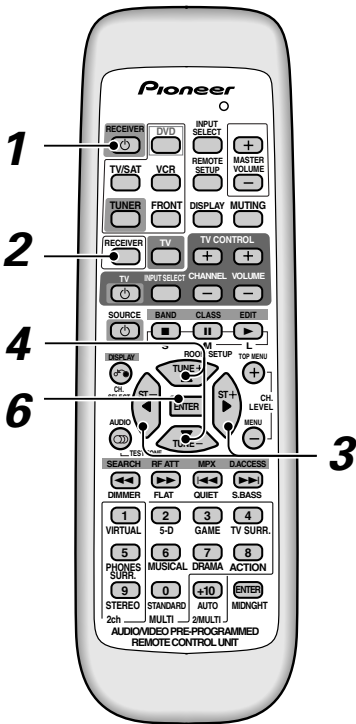

1 Press **RECEIVER** to turn the power on.

The **STANDBY** indicator goes out.

2 Press **RECEIVER**.

This button switches the remote to the receiver control mode.

3 Press or to select the mode you want to set.

For best results, start with “**SPEAKERS setting mode**” and make your initial adjustments in the order described below.

The current settings are displayed automatically.

- **SPEAKERS (Front, Center, Surround) setting mode (page 26)**  
Use to specify the size and configuration of the speakers you have connected.
  - **SUBWOOFER ON/PLUS/OFF setting mode (page 26)**  
Use to specify if the subwoofer is set to on, plus or off.
  - **Crossover frequency setting mode (page 26)**  
Use to determine at which frequency the bass tones will be sent to the subwoofer (or “Large” speakers).
  - **LFE (Low Frequency Effects) attenuator setting mode (page 27)**  
Use to lower the level for the LFE channel (a special bass channel) when the LFE level is so high as to distort.
  - **FRONT speakers distance setting mode (page 27)**  
Use to specify the distance from your listening position to your front speaker.
  - **CENTER speakers distance setting mode (page 27)**  
Use to specify the distance from your listening position to your center speaker.
  - **SURROUND speakers distance setting mode (page 28)**  
Use to specify the distance from your listening position to your surround speakers.
  - **Dynamic range control setting mode (page 28)**  
Use to compress the dynamic range of a Dolby Digital soundtrack with this feature (for non-Dolby Digital soundtracks use the Midnight mode for the same effect).
  - **Dual mono setting (page 28)**  
Use with soundtracks that have dual mono encoding if you want to isolate one channel to a particular speaker.
  - **Input Attenuator setting (page 28)**  
Use to reduce the analog input level coming into the receiver when it is so loud as to make it distort.
- 4 Press or to select the setting you want.  
The setting is entered automatically.
- 5 Repeat steps 3 and 4 to set other surround setting modes.
- 6 Press **ENTER** to exit the setting mode.

**MEMO:**

The setting mode is automatically exited if no operation is performed within 20 seconds.

## Fine Tuning Your Surround Sound

### SPEAKERS (Front, Center, Surround) setting mode

This setting establishes the size and configuration of the speaker system you have connected more exactly than the automatic setup. Set here, for example, what speakers you have connected and which size they are. Selecting “Large” or “Small” will determine if bass sounds are sent by the receiver to the speakers being set.

In the display, “F”, “C”, and “S” refer to front, center, and surround speakers respectively. Speaker size is denoted as “L” for large speakers, “S” for small speakers, and “\_” (underscore) if no speaker is connected.

Below is a diagram showing exactly what each display for the speaker setup means and how to decide whether to choose “Large”, “Small” or none ( \_ ) for your set up.

If you only have two speakers none of the below will not match your setup. In this case just ignore this setting and choose the appropriate 2 channel listening mode (see page 30) for what you want to hear.

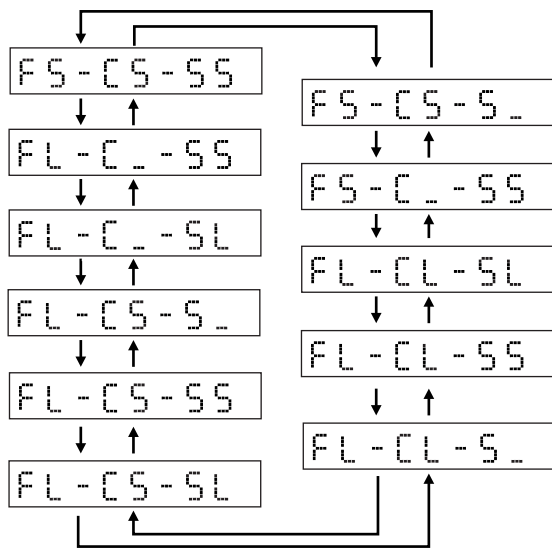

**LARGE:** If the cone size (diameter) of your speaker(s) is larger than 12 centimeters, set to “Large”.

**SMALL:** If the cone size (diameter) of your speaker(s) is 12 centimeters or smaller, set to “Small”.

**None ( \_ ):**  Choose this setting if you have no speaker(s) hooked up to this terminal. Sound coming from this channel in the original source will be down-mixed to one of the active speakers.

**Follow steps 1-3 on page 25.**

**Use the  $\Delta$  or  $\nabla$  buttons to choose a speaker setting mode according to the speakers you hooked up.**

The configurations shown above will appear in the display. Cycle through the different possibilities until you find the one that matches your set up (or is closest to it).

Press  $\triangleright$  to advance to the next receiver setting mode, or press  $\triangleleft$  to return to a previous receiver setting mode.

**Press ENTER if you want to exit the setting mode.**

### SUBWOOFER ON/Plus/OFF setting mode

Set the SUBWOOFER to ON, OFF or Plus.

ON: When you are using a subwoofer .

OFF: When you are not using a subwoofer.

Plus: When a subwoofer is used, you have the option of selecting the **PLS** setting, which adds extra bass.

**Follow steps 1-3 on page 25 (if necessary).**

**Press  $\Delta$  or  $\nabla$  to select subwoofer ON, Plus or OFF.**

Press  $\triangleright$  to advance to the next receiver setting mode, or press  $\triangleleft$  to return to a previous receiver setting mode.

**Press ENTER if you want to exit the setting mode.**

#### MEMO:

- The setting will switch ON or OFF automatically, depending on whether you have connected a subwoofer or not.
- Plus is expressed as PLS in the display.
- Setting the front speaker size to “Small” in the SPEAKERS setting mode automatically locks the subwoofer in the **ON** position.
- There are some cases where no sound will come from the subwoofer even if it is set to ON (this depends on the speaker setting, the listening mode and/or the kind of source material).

### Crossover frequency setting mode

Crossover frequency is the point where the receiver divides the high and low sounds (the frequencies) between the speakers. Since most smaller speakers can't handle deep bass tones, this setting allows you to send those sounds to the subwoofer (or speakers set to “Large”) instead of the speakers set to “Small” in your system. Choose the point at which you want the frequency routed to the subwoofer. We recommend setting this to 200 Hz if smaller bookshelf-type speakers are used for your “Small” speakers.

Follow steps 1-3 on page 25 (if necessary).

Press  $\Delta$  or  $\nabla$  to specify the crossover frequency for your small speakers (100 Hz, 150 Hz or 200 Hz).

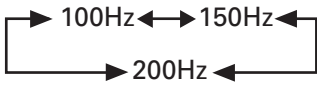

**100 Hz**

Sends bass frequencies below 100 Hz to the subwoofer (or “Large” speakers).

**150 Hz**

Sends bass frequencies below 150 Hz to the subwoofer (or “Large” speakers).

**200 Hz**

Sends bass frequencies below 200 Hz to the subwoofer (or “Large” speakers).

Press  $\triangleright$  to advance to the next receiver setting mode, or press  $\triangleleft$  to return to a previous receiver setting mode.

Press **ENTER** if you want to exit the setting mode.

**MEMO:**

- The default setting is “200 Hz”.
- If there are no “Small” speakers in SPEAKERS setting mode, crossover frequency cannot be set (— appears in the display).

**LFE attenuator setting mode**

Dolby Digital and DTS audio sources include ultra-low bass tones. Set the LFE attenuator as needed to prevent the ultra-low bass tones from distorting the sound from all the active speakers.

Follow steps 1-3 on page 25 (if necessary).

Press  $\Delta$  or  $\nabla$  to set the attenuation level:



**0 dB** : no attenuation

**10 dB** : LFE volume is reduced

**LFE OFF** : LFE channel is off.

Press  $\triangleright$  to advance to the next receiver setting mode, or press  $\triangleleft$  to return to a previous receiver setting mode.

Press **ENTER** if you want to exit the setting mode.

**MEMO:**

- The default setting is “0 dB”.

**FRONT speakers distance setting mode**

Set the distance from the FRONT speakers to the listening position.

Follow steps 1-3 on page 25 (if necessary).

Press  $\Delta$  or  $\nabla$  to set the distance of the FRONT speakers from the main listening position (within a range from 0.3 m to 9.0 m).

Press  $\triangleright$  to advance to the next receiver setting mode, or press  $\triangleleft$  to return to a previous receiver setting mode.

Press **ENTER** if you want to exit the setting mode.

**MEMO:**

- The default setting is 1.8 m.
- One step equals about 0.3 m.
- If you do the ROOM SETUP settings after the settings here, those will take precedence.

**CENTER speaker distance setting mode**

Set the distance from the CENTER speakers to the listening position.

Follow steps 1-3 on page 25 (if necessary).

Press  $\Delta$  or  $\nabla$  to set the distance of the CENTER speaker from the main listening position (within a range from 0.3 m to 9.0 m).

Press  $\triangleright$  to advance to the next receiver setting mode, or press  $\triangleleft$  to return to a previous receiver setting mode.

Press **ENTER** if you want to exit the setting mode.

**MEMO:**

- The default setting is 1.5 m.
- One step equals about 0.3 m.
- When “C\_” is selected in SPEAKERS setting mode, the Center distance cannot be set.
- If you do the ROOM SETUP settings after making the settings here, those will take precedence.

### SURROUND speakers distance setting mode

Set the distance from the SURROUND speakers to the listening position.

Follow steps 1-3 on page 25 (if necessary).

Press  $\Delta$  or  $\nabla$  to set the distance of the SURROUND speakers from the main listening position (within a range from 0.3 m to 9.0 m).

Press  $\triangleright$  to advance to the next receiver setting mode, and press  $\triangleleft$  to return to a previous receiver setting mode.

Press **ENTER** if you want to exit the setting mode.

#### MEMO:

- The default setting is 1.8 m.
- One step equals about 0.3 m.
- When “S\_” is selected in SPEAKERS setting mode, the SURROUND distance cannot be set.
- If you do the ROOM SETUP settings after the settings here, those will take precedence.

### Dynamic range control setting mode

Dynamic range is the difference between the loudest and softest sounds in any given signal. The dynamic range control helps you playback sounds so the quieter sounds are audible yet the louder sounds don't get distorted. It does this by compressing the dynamic range. When watching a movie at low volume, setting this function enables low level sounds to be heard more easily but you won't be jolted by louder sounds.

Follow steps 1-3 on page 25 (if necessary).

Press  $\Delta$  or  $\nabla$  to set the dynamic range control (OFF, MAX, or MID).

Dynamic range control is operative only when a Dolby Digital soundtracks with this feature encoded into it is being played back. For other sources use the Midnight mode (see page 32) to achieve the same effect.

Press  $\triangleright$  to advance to the next receiver setting mode, and press  $\triangleleft$  to return to a previous receiver setting mode.

Press **ENTER** if you want to exit the setting mode.

#### MEMO:

- The default setting is “OFF”.
- When listening at high volume, set to OFF.
- For best results at low volumes, set to “MAX” for maximum dynamic range compression.

### Dual mono setting

Dual mono has two different audio channels in it. You can use it to listen to soundtracks that have one language on one channel and a different language on the other. The dual mono setting can only be used when listening to discs that have dual mono software encoded in them, for example some Dolby Digital discs. As of now these are not that widely used.

The **ch1** setting plays channel 1 through your center speaker. If you have selected no Center speaker in the speakers setting (or are in a 2 ch listening mode) then you will hear ch1 out of both front speakers. The **ch2** setting plays channel 2 through your center speaker. If you have selected no Center speaker in the speakers setting (or are in a 2 ch listening mode) then you will hear channel 2 out of both front speakers. In the **L. c1 R. c2** setting the speakers will play the soundtrack independently of each other. The left front speaker will play channel 1 and the right front speaker will play channel 2.

Follow steps 1-3 on page 25 (if necessary).

Press  $\Delta$  or  $\nabla$  to cycle through the possible DUAL MONO settings.

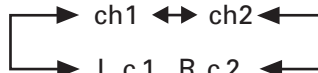

Press  $\triangleright$  to advance to the next receiver setting mode, and press  $\triangleleft$  to return to a previous receiver setting mode.

Press **ENTER** if you want to exit the setting mode.

#### MEMO:

- The default setting of this feature is **ch1**.

### Input Attenuator setting

You can set the input signal to be lowered if it is distorting. This is only possible for analog signals, digital signals can't be attenuated.

Follow steps 1-3 on page 25 (if necessary).

Press  $\Delta$  or  $\nabla$  to select input attenuator ON or OFF.

Press  $\triangleright$  to advance to the next receiver setting mode, and press  $\triangleleft$  to return to a previous receiver setting mode.

Press **ENTER** if you want to exit the setting mode.

#### MEMO:

- The default setting is **OFF**.

## Setting the Volume Level of each Channel (adjusting the speaker volume balance)

Use to set the relative volume of each channel as you find necessary.

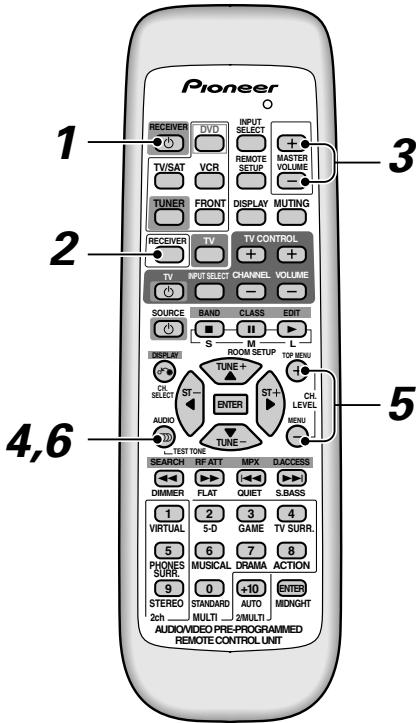

- 5 Use the + or – buttons to adjust speaker levels so that you hear the test tone at the same volume from each speaker when seated in your main listening position.
  - If a speaker is deselected in the speaker setting mode (see page 16) then no test tone will be output for that speaker.
  - The channel level range is  $\pm 10$  dB.
  - Levels can be set for each surround mode.
- 6 Press **TEST TONE** to turn off the test tone.

**MEMO:**

- Since the subwoofer transmits an ultra-low frequency its sound may seem quieter than it actually is. Be careful not to turn up your subwoofer too much and check the volume with an actual source.
- The subwoofer volume is best controlled with the volume control on the powered subwoofer.
- The speaker volume can be adjusted without outputting the test tone by pressing CH SELECT and CH LEVEL +/- button.
- The default setting is 0 dB for all channels.
- If you have adjusted the channel level using the + button, even if the master volume is all the way up you'll never actually get a volume level that is 0dB (full volume).

- 1 Press **RECEPTOR** to turn the power on.  
The STANDBY indicator goes out.
- 2 Press **RECEPTOR**.  
This button switches the remote to the receiver control mode.  
If a speaker is deselected in the speaker setting mode (see page 16) then no test tone will be output for that speaker.
- 3 Press **+** or **-** to adjust the volume to an appropriate level.
- 4 Press **TEST TONE** to output the test tone.  
The test tone is output in the following order.

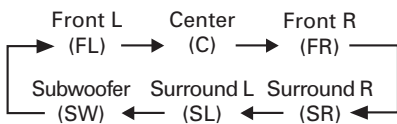

The test tone sequence corresponds to the speaker settings.

## Listening Modes

There are three types of listening modes, one for two channel (stereo) outputs, one for multichannel sources and one that automatically selects STEREO or STANDARD (multichannel) mode according to whether you're using a two channel or multichannel source. Intrinsic to home theater, surround sound delivers a realistic and powerful soundtrack that recreates the movie theater experience. You may need to experiment with these different modes to see which suit your home system and personal tastes, but in general you should listen to movie sources (like DVDs) in one of the listening modes for multichannel outputs.

### 2 Channel Listening modes (for two channel outputs)

If you only have two speakers choose one of these modes.  
(According to the speaker settings you have made and the signal input you may or may be output from a subwoofer in these modes.)

#### VIRTUAL

This mode imitates surround sound with two speakers. The sound will only be heard from two speakers in this mode but the feeling of an all-encompassing surround sound is reproduced.

#### PHONES SURROUND (PHONES SURR.)

This mode imitates surround sound when listening to headphones. Though you're using headphones and only have two channels the effect of overall surround sound is reproduced. (It's displayed as P.SURR in "Checking your Settings" on page 39.)

#### STEREO

Use this mode to listen to conventional stereo sources and retain a stereo sound. Even if a multichannel source is input when you are using this listening mode, you will only hear 2 channel sound.

### Multichannel Listening modes (for multichannel outputs)

#### STANDARD

This mode is for pure decoding of multichannel sources like Dolby Digital 5.1, DTS 5.1, MPEG etc., and for Dolby Pro Logic decoding of two channel sources (Dolby Surround, PCM, etc.). No special effects are added. It is good choice for getting surround sound.

#### 5-D THEATER (5-D)

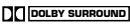
This mode is especially designed to give sound depth to Dolby Surround sources. The overall effect builds a dynamic and broad sound space, allowing a faithful reproduction of five speaker sound. The mode should be used in conjunction with Dolby sources bearing the  mark.

#### GAME

Use this mode when playing a video game. It works especially well with sound moving from left to right in such software as racing games, shooting games, and those kind of games with movement in them.

#### TV SURROUND (TV SURR.)

This mode produces surround sound even for mono or stereo TV sources. It is useful for old movies. A mono TV signal will be able to approximate the effect of overall surround sound.

#### MUSICAL

This mode simulates the acoustics of a large concert hall and is suitable for music or musical sources marked .

() or .

#### DRAMA

This mode simulates the relaxed environment of a medium size movie theater, and is suitable for watching drama.

#### ACTION

This mode simulates the acoustics of a large modern movie theater. You can enjoy the power and dynamics of motion picture audio. This mode is best used with action movies.

## Automatic Listening mode (automatically selects 2 channel or multichannel outputs. This is the receiver's default mode)

### AUTO

This mode automatically detects what kind of signal is being input and employs the proper listening mode of the receiver (switching between STEREO and STANDARD depending on the source). If you don't know what kind of signal (stereo, multichannel, etc.) you are using or don't want to bother with switching listening modes, use this feature.

## Selecting a Listening Mode

Choose one that suits the soundtrack you are listening to or achieves the effect you want, as explained on the previous page.

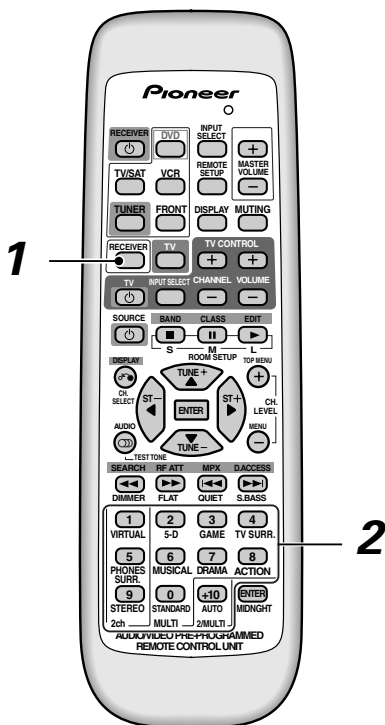

### 1 Press RECEIVER.

This sets the remote control to the receiver control mode.

### 2 Press the button for the listening mode you want.

The listening modes are written below the number buttons. Refer to page 30 for more details about each listening mode.

### MEMO:

- The default setting is AUTO.
- You can only select the PHONES SURR. mode when headphones are plugged into the headphone jack.
- The listening mode you choose with headphones is fully independent of the listening mode with speakers.
- If you disconnect the headphones while in PHONES SURR. mode the receiver will return to the listening mode it was in before you selected PHONES SURR.
- If you're using a DTS 2 channel stereo source it doesn't matter what listening mode you select, the sound will only play in stereo.
- When inputting a 96 kHz PCM signal you can only use AUTO or STEREO listening modes. If you select another mode the receiver will automatically switch to AUTO mode.
- Each playback component can be set independently and retains its sound mode when another component is being used.

# Sound Modes

## Tone Effects

The Tone Effects allow you to add certain sound elements when playing all kinds of sources (two-channel/stereo sources, Dolby Surround sources, Dolby Digital, DTS or MPEG sources). They can be used in conjunction with the listening modes explained on the previous page.

### FLAT

No tone effects added

### QUIET

This mode reduces the bass and treble in the signal. It is best used when you feel sounds are too harsh or sharp and would like to smooth them out.

### S.BASS

This mode increases the bass in the signal and puts the beat of the music or soundtrack in the forefront.

## Selecting a Tone Effect

The receiver has three tone effect types that you can add to the Listening mode you are using.

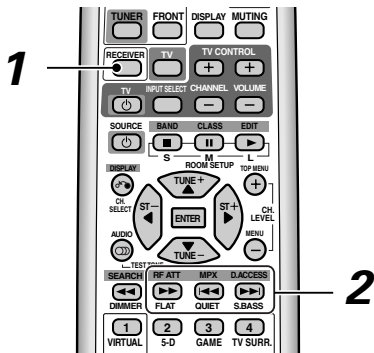

### 1 Press RECEIVER.

This sets the remote control to the receiver control mode.

### 2 Press FLAT or QUIET, S.BASS.

Choose the sound effect that suits that sound you want.

### MEMO:

- The default setting is FLAT.
- Each playback component can be set independently and retains its sound mode when another component is being used.

## MIDNIGHT Listening Mode

When listening at low volume surround effects tend to fade away and the surround sound feeling is lost. Turn on the MIDNIGHT listening mode to enjoy the effects of quality surround sound at low volumes. It makes quiet sounds and dialog easily audible at low volumes.

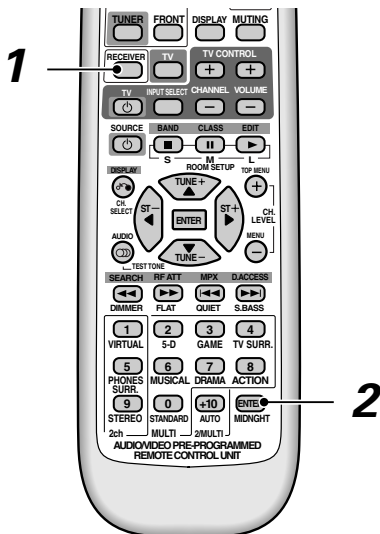

### 1 Press RECEIVER.

This sets the remote control to the receiver control mode.

### 2 Press MIDNIGHT.

Each press switches MIDNIGHT listening mode on or off. When in MIDNIGHT listening mode the ● indicator lights, as shown in the diagram below.

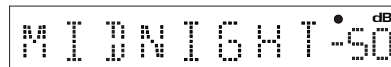

### MEMO:

- The effect automatically adjusts according to the volume level.
- Each playback component can be set independently and retains its sound mode when another component is being used.
- The default setting is OFF.



## Finding a Station

The following steps show you how to tune in to FM and AM radio broadcasts using the automatic (search) and manual (step) tuning functions. If you already know the exact frequency of the station you want to listen to, see “Tuning Directly to a Station” on page 34. Once you are tuned to a station you can memorize the frequency for recall later—see “Memorizing Stations” on page 34 for more on how to do this.

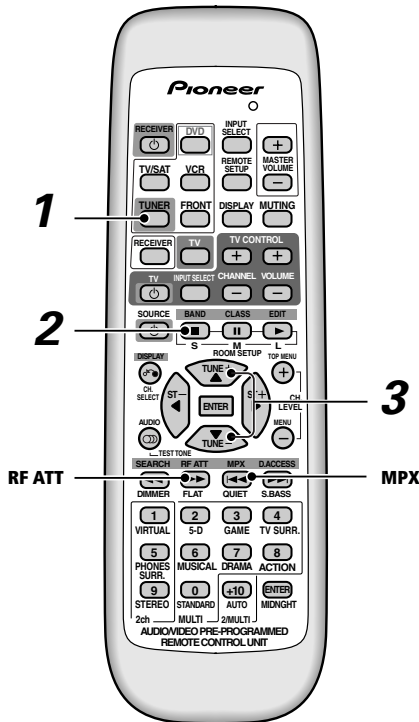

- 1 Press the **TUNER** button on the remote control to put it in Tuner mode.  
On the receiver, press the **TUNER** button to select the tuner mode.
- 2 Use the **BAND** button to change the band (FM or AM), if necessary.  
Each press switches the band between FM and AM.

- 3 Tune to a station using the **TUNE +** or **TUNE –** buttons.

### Automatic tuning

To search for stations in the currently selected band, press and hold either the **TUNE +** or **TUNE –** buttons for about a second. The receiver will start searching for the next station, stopping when it has found one. Repeat this step to search for other stations.

### Manual tuning

To change the frequency one step at a time, press the **TUNE +** or **TUNE –** buttons.

### High speed tuning

Press and hold the **TUNE +** or **TUNE –** buttons for high speed tuning, releasing the button once the desired frequency is reached.

## MPX mode

If there is interference or noise during a FM radio broadcast, or the radio reception is weak, press the **MPX** button to switch the receiver into mono reception mode. This should improve the sound quality and allow you to enjoy the broadcast.

## RF ATT mode

If the radio signal is too strong and/or the sound is distorting press the **RF ATT** button to attenuate (lower) the radio signal input and reduce the distortion (for FM stations only).

## Tuning Directly to a Station

Sometimes, you'll already know the frequency of the station you want to listen to. In this case, you can simply enter the frequency directly using the number buttons on the remote control.

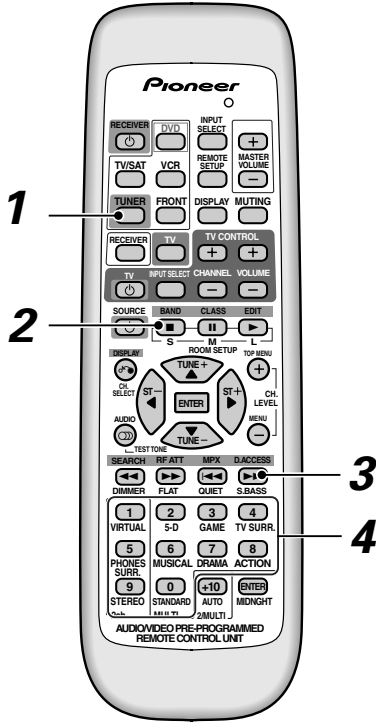

- 1 Press the **TUNER** button on the remote control.
- 2 Press the **BAND** button to select either FM or AM.  
Each press switches the band between FM and AM.
- 3 Press **D.ACCESS** (**DIRECT ACCESS**).
- 4 Use the number buttons to enter the frequency of the radio station.

Example: To tune to 106.00 (FM), press 1 - 0 - 6 - 0 - 0





**MEMO:**

- If you make a mistake while inputting the frequency, press the **D.ACCESS** button twice to cancel the frequency and start again.

## Memorizing Stations

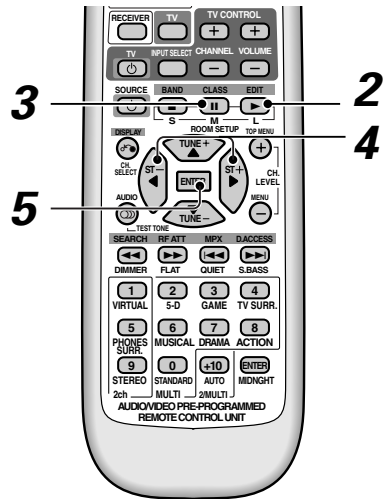
If you often listen to a particular radio station, it's convenient to have the receiver store the frequency for easy recall whenever you want to listen to that station. This saves the effort of manually tuning in each time. The receiver can memorize up to 30 stations, stored in three banks, or classes, (A, B and C) of 10 stations each. When memorizing FM frequencies, the receiver also stores the MPX setting (auto stereo or mono, see page 30) and the RF ATT setting (see p. 33).



- 1 Tune to a station you want to memorize.  
See "Finding a Station" on page 33 and "Tuning Directly to a Station" on this page for more detail on how to do this.
- 2 Press **EDIT**.  
The display shows a blinking memory class.
 
- 3 Press **CLASS** to select one of the three classes.  
Repeatedly pressing this button cycles through the three available classes, A, B and C.
- 4 Press the **◀** or **▶** buttons (or the number buttons) to select the station memory number you want.  
Pressing these buttons repeatedly cycles through the 10 available station memories in each class. After choosing the location you want, the preset class and number blink for about 5 seconds.
- 5 Press **ENTER** while the display is blinking to input your choice.  
Repeat steps 1 to 4 to memorize up to 30 stations.

## Naming Memorized Stations

You can input a name of up to four characters for each preset station (FM only) in the receiver's memory (see the previous page). This name can be anything you choose. For example, you could input "BBC1" for that station and when you listen to it the name, rather than the frequency number, will appear on your display.

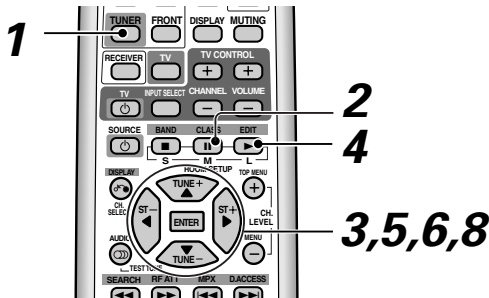

- 1 Press the **TUNER** button on the remote control.
- 2 Press **CLASS** repeatedly to select the class. Repeatedly pressing this button cycles through the three available classes, A, B and C.
- 3 Press **ST +** or **ST -** to select the FM preset channel.
- 4 Press **EDIT** twice to select the station name mode.



- 5 Press **▲** (TUNE +) or **▼** (TUNE -) to choose the first character. Scroll through the letters, numbers and symbols you can input. Stop on the one you want.



- 6 Press **▶** to input the first of the four characters. That character lights steadily in the display and the cursor automatically moves to the next space.
- 7 Enter up to three more characters in the same way.



Any time you want to exit the process you can press the **EDIT** button.

- 8 Press **ENTER** when you have got the characters you want to enter. Repeat steps 2 to 6 to memorize up to 30 preset broadcast station names.

To erase or change the station name Perform the procedures of "Naming Memorized Stations" and enter four spaces to erase the memorized station name.

When you want to change a memorized station name, input the new station name using the same procedure.

## Recalling Memorized Stations

Having memorized up to 30 stations (see the previous explanation for how to do this), preset stations can be easily recalled.

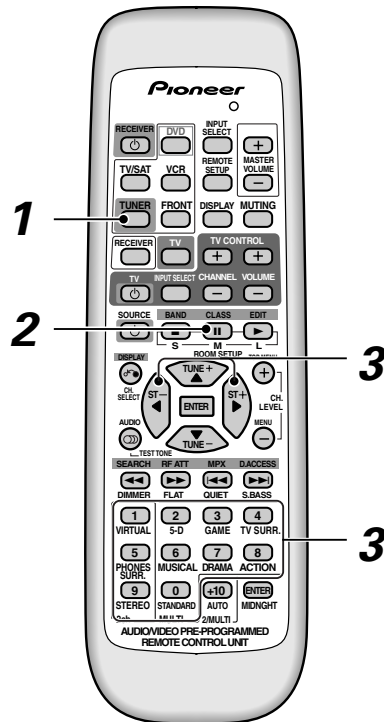

- 1 Press the **TUNER** button on the remote control.
- 2 Press **CLASS** to select the class in which the station is stored. Repeatedly pressing this button cycles through the three available classes, A, B and C.
- 3 Use the **ST +** or **ST -** buttons (or the number buttons) to select the station memory in which the station is stored.

Alternatively, recall the station memory using the number buttons on the remote control.

### MEMO:

- If the receiver is left disconnected from the AC power outlet or the power is turned off for more than one month, the station memories will be lost and will have to be reprogrammed.

### An Introduction to RDS

Radio Data System, or RDS as it's usually known, is a system used by FM radio stations to provide listeners with various kinds of information—the name of the station and the kind of show they're broadcasting, for example. This information shows up as text on the display, and you can switch between the kind of information shown. Although you don't get RDS information from all FM radio stations, you do with most.

Probably the best feature of RDS is that you can search automatically by type of program. So, if you felt like listening to jazz, you could search for a station that's broadcasting a show with the program type, "JAZZ." There are around 30 such program types, including various genres of music, news, sport, talk shows, financial information, and so on.

The receiver lets you display three different kinds of RDS information: "Radio Text", "Program Service Name", and "Program Type".

"Radio Text" (RT) is messages sent by the radio station. These can be anything the broadcaster chooses—a talk radio station might give out its telephone number as RT, for example.

"Program Service Name" (PS) is the name of the radio station.

"Program Type" (PTY) indicates the kind of program currently being broadcast.

The receiver can search for and display the following program types:

<b>NEWS AFFAIRS</b>	Current affairs
<b>INFO</b>	General information
<b>SPORT</b>	
<b>EDUCATE</b>	Educational material
<b>DRAMA</b>	Radio plays or serials
<b>CULTURE</b>	National or regional culture, theatre, etc.
<b>SCIENCE</b>	Science and technology
<b>VARIED</b>	Usually talk-based material, such as quiz shows or interviews.
<b>POP M</b>	Pop music
<b>ROCK M</b>	Rock music
<b>M.O.R. M</b>	"Middle of the road" music
<b>LIGHT M</b>	'Light' classical music
<b>CLASSICS</b>	'Serious' classical music
<b>OTHER M</b>	Other music not fitting any of the above categories
<b>WEATHER</b>	
<b>FINANCE</b>	Stock market reports, commerce, trading, etc.
<b>CHILDREN</b>	
<b>SOCIAL A</b>	Social affairs
<b>RELIGION</b>	
<b>PHONE IN</b>	Public expressing their views by phone
<b>TRAVEL</b>	Holiday-type travel rather than traffic announcements

<b>LEISURE</b>	Leisure interests and hobbies
<b>JAZZ</b>	
<b>COUNTRY</b>	Country music
<b>NATION M</b>	Popular music in a language other than English
<b>OLDIES</b>	Popular music from the '50s
<b>FOLK M</b>	Folk music
<b>DOCUMENT</b>	Documentaries

In addition, there is a program type, **ALARM!**, used for exceptional emergency announcements. You can't search for this, but the tuner will switch automatically to this RDS broadcast signal.

### Using the RDS display

To display the different types of RDS information available (RT, PS and PTY as explained on the previous page), press **TUNER** on the remote control and use the **DISPLAY** button to cycle through the types of RDS information.

Each press changes the display as follows:

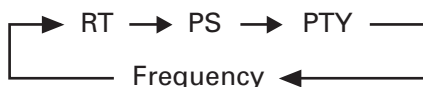

#### MEMO:

- In the RT mode, if any noise is picked up while displaying the RT scroll, some characters may be displayed incorrectly temporarily.
- In the RT, when no RT data is transmitted from the broadcast station, "NO TEXT DATA" is displayed once and after that the PS data is displayed. If you have entered a name for that station it will be displayed.
- In the PTY mode, there are cases where "NO TYPE" is displayed. In this case the tuner will automatically switch to the PS mode after a few seconds.
- If reception conditions are strong but the RDS data is displayed incorrectly, press RF ATT.

## Searching for RDS Programs

One of the most useful features of RDS is the ability to search for a particular kind of radio program. You can search for any of the program types listed on page 33—these cover all kinds of music, as well as news, weather forecasts, sports programs, and a variety of others.

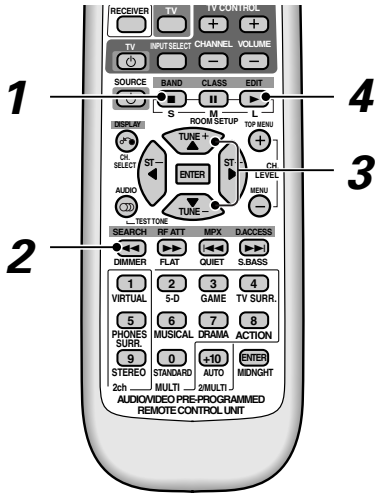

- 1 Press the **BAND** button to select the FM band.

RDS is only broadcast on FM.

- 2 To select the PTY search mode press the **SEARCH** button.

SEARCH -50 dB

- 3 Use the ▲ (TUNE +) or ▼ (TUNE -) buttons to select the program type you want to hear.

NEWS -50 dB

- 4 Press **ENTER** to search for the program type.

The tuner searches through the FM stations stored in the station memories.

If the tuner finds a matching program type, the tuner plays 5 seconds of the station. To listen to that station, press the **ENTER** button. (The tuner stops searching.)

If you don't press the **ENTER** button during the above mentioned 5 seconds, the tuner resumes the search.

When the tuner finds a program type you searched for, the frequency display will blink for about 5 seconds and then the display will show **FINISH** briefly.

R6 10300-50 dB



FINISH -50 dB

If **NO PTY** is displayed it means the tuner couldn't find that program type at the time of the search.

NO PTY -50 dB

### MEMO

- This function searches RDS stations preset in the 30-station memory. If this function is set when no stations have been preset, "NO PTY" will be displayed. If the desired PTY could not be found amongst the RDS stations in memory, the same display appears.

## Muting the Sound

Use this feature to mute the volume.

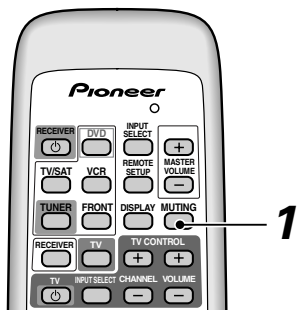

- 1 Press the **MUTING** button on the remote control.

No sound will be audible until the MUTING button is pressed again to cancel the muting. Alternatively, you can press the MASTER VOLUME +/- buttons to cancel the muting.

## Using the Headphones

The headphone features are explained here.



headphone jack

Plug headphones into the headphone jack on the front of the receiver.

No sound will be audible from the speakers when headphones are plugged in.

### MEMO:

- When using the headphones you can only select STEREO or PHONES SURR. listening modes.

## Changing the Display Brightness (DIMMER button)

The display on the receiver has four brightness settings. Use the instructions below to adjust the brightness of the display.

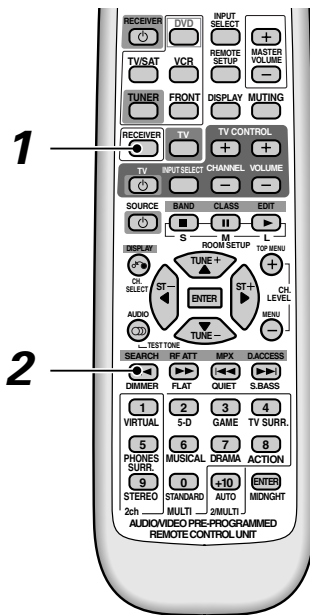

- 1 Press the **RECEIVER** button.
- 2 Press the **DIMMER** button on the remote control.

There are four display brightness settings including display off. Each press will cycle you through these four settings.

### MEMO:

- In the off mode all the lights in the display are off except for the master volume indicator, which appears very dimly.
- If you operate the receiver when the display is in the off or dimmed modes the display will light for about two seconds and then go off again.

## Checking your Settings

Use this feature to check your settings on the receiver's display. The meaning of the displays for the input signal are explained below.

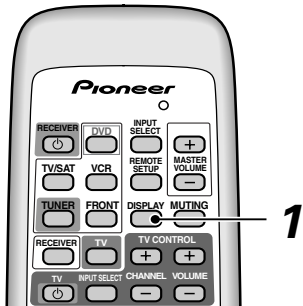

- 1 Press the **DISPLAY** button on the remote control.

Each press cycles through the five displays you can check for information with this function. These are:

- ① The listening mode (see page 30)
- ② The tone mode (see page 32)
- ③ The Midnight listening mode (see page 32)
- ④ The input signal (see below)
- ⑤ Returns to the normal display

**MEMO:**

- If you don't press any buttons the receiver returns to the normal mode after five seconds.
- The listening mode P. SURR refers to Headphones Surround mode.

## The Input Signal Displays Explained

- \*\*k : sampling rate (PCM)
- \*\*ch : number of channels
- DUAL : Dual Mono signal
- D.SRD : Dolby Surround signal

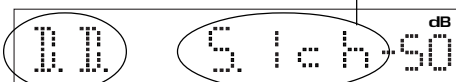

- D.D. : Dolby Digital signal
- DTS : DTS signal
- MPG : MPEG signal
- PCM : PCM signal
- ANALOG : analog signal

## Analog Input Mode

With this feature you can set the receiver to analog input mode.

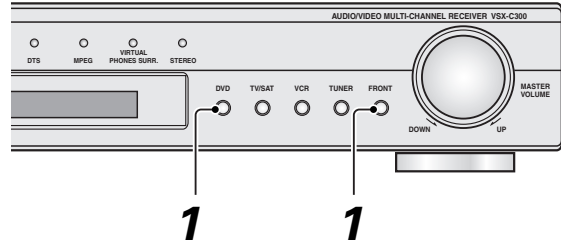

- 1 While pressing the **DVD** button press the **FRONT** button. Hold for about one second. This sets all inputs (DVD, TV/SAT, etc.) to analog. You will see the following display.



- 2 Select the input you want to use for your analog input.

**MEMO:**

- When you change to another input the mode will be cancelled.
- The mode is cancelled by turning the receiver off or doing step 1 again.

## Resetting the System

Use this feature to reset the system to its factory default settings.

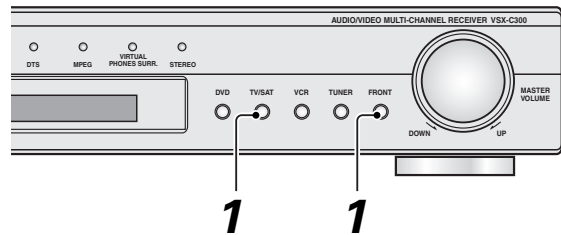

- 1 Press the **TV/SAT** button and the **FRONT** button at the same time for five seconds to return all of the settings to their default mode.

**MEMO:**

- If the receiver is disconnected from a power source for more than a month, or the main power is turned off, it will reset to the default settings.
- The above reset doesn't affect the presets that you have programmed into the remote control (see page 42).

### Default Settings for the Receiver

All the settings that return to their defaults when you reset the system are listed here (see the previous page to Reset the System).

Setting Type	Default Settings	Page
SPEAKERS (Front, Center, Surround) setting	automatically sensed	page 26
SUBWOOFER ON/PLUS/OFF	automatically sensed	page 26
Crossover frequency	200 Hz	page 26
LFE attenuator	0 dB	page 27
FRONT speakers distance	1.8 m	page 27
CENTER speakers distance	1.5 m	page 27
SURROUND speakers distance	1.8 m	page 28
Dynamic range control	OFF	page 28
Dual mono	ch1	page 28
Input Attenuator	OFF	page 28
Listening Mode	AUTO (all inputs)	page 30
Listening Mode (with headphones)	STEREO (all inputs)	page 30
Tone Effects	FLAT	page 32
MIDNIGHT Listening Mode	OFF	page 32
Setting the Volume Level of each Channel	Front L/R "0 dB", Center "0 dB", Surround L/R "0 dB", Subwoofer "0 dB"	page 29
INPUT	DVD	page 19
MASTER VOLUME	--- dB (no sound)	page 18

**MEMO:**

- The default settings for the remote control to control other components are listed on page 43.



## Changing the Remote Control Mode

The remote control that comes with this receiver is very flexible and can be switched from controlling this receiver to controlling other components, even components not made by Pioneer. You can set up the remote to control so it will be able to control everything in your system and thus you'll only need to use this remote when operating your home theater system.

The default settings to control other components on this remote control are for Pioneer equipment but you can change these to cover most brand makers. You do this by inputting preset codes that have been decided for each brand maker into the remote (see the next page). After these codes are input you'll be able to operate the equipment.

For this remote, when you press an input button (like DVD) it also changes the remote control from controlling the receiver to controlling DVD functions as well as switching the input to the receiver. If the Direct Selection function is off (see page 43), the remote won't change the input of the receiver when an input button is pressed but only change what the remote control itself is operating.

## Switching the Operation Mode of the Remote

Press the button for the piece of equipment you want to control with this remote (for example DVD). Since the buttons have different functions when operating different equipment pages 44 and 45 will give you detailed information on what each button does in each operation mode.

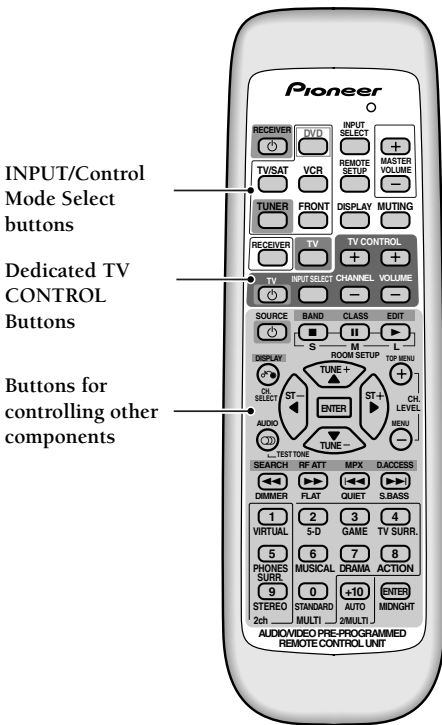

Press the button of the component you want to use this remote to operate. This will both change the input into the receiver and the remote control operation mode.

The factory settings for all the buttons are explained here. All the settings are all for Pioneer components but you can change this.

DVD: DVD player

TV/SAT: TV

VCR: DVD recorder

TUNER: the built-in radio tuner

FRONT: VCR

TV: TV

(For a detailed chart of the factory settings see "Clearing the Preset Codes" on page 43.)

### MEMO:

- If you can't operate other components, input the preset codes using the procedure on the following page.
- When the Direct Selection is off (page 43) you can't switch the input. You can only switch the operation mode of the remote.
- When you press the RECEIVER button the remote control mode will switch back to the receiver.
- The TV CONTROL buttons are dedicated to controlling the TV. They will always control the TV no matter what operation mode the remote is in. Of course, you need to input the preset code for your TV (if it is not Pioneer-made) in order to control it with this remote. If, however, you input the code for a similar component (like a satellite TV tuner) for a different button (like the TV/SAT button) the TV CONTROL buttons may take on the controls of that component when in that mode (i.e. when you press the TV/SAT button the TV CONTROL buttons might control your satellite TV tuner, not your TV).

## Recalling Preset Codes

The following steps show you how to recall preset codes for each INPUT/Control Mode Select button. Once the preset code is assigned, pressing the button will automatically set the remote to operate the respective component.

**MEMO:**

- Refer to “Preset Code List” on pages 46 to 48 for the components and manufacturers available.
- Refer to “Controlling the Rest of Your System” on pages 44–45 for detailed explanations on how to operate your other components.

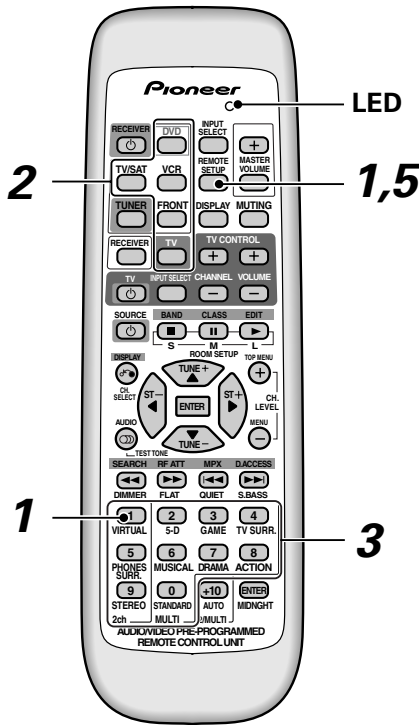

- 1 While pressing the **REMOTE SETUP** button press the **VIRTUAL** button to select the Preset mode.

The LED lights will blink.

To cancel the preset mode at any time

Press **REMOTE SETUP**.

The remote control will also return to the previous mode after thirty seconds of inactivity.

- 2 Press the **INPUT/Control Mode Select** button for the component you want to control.

The LED lights steadily.

Each button can be set to control one of the following components

<b>DVD</b>	DVD/LD player or DVD Recorder
<b>TV/SAT</b>	TV, Satellite tuner or Cable TV tuner
<b>VCR</b>	VCR or DVD Recorder
<b>FRONT</b>	The component (usually a portable DVD or video camera) connected to the jacks on the front of the receiver
<b>TV</b>	TV

- 3 Use the **number buttons** to enter the 3 digit setup code (see pages 46-48 for “Preset Code List”).

The LED will blink.

After a code has been input the power of the component being input will turn on or off.

The remote will return to the previous mode after thirty seconds of inactivity.

**MEMO:**

- The power of the component being input will only turn on or off if that component is able to be turned on directly by remote control.

- 4 Repeat steps 2–3 to assign preset codes for as many components as necessary.

- 5 Press the **REMOTE SETUP** button to return to the previous mode.

**MEMO:**

- You can only input a code for the component type written on each **INPUT/Control Mode Select** button.
- Even if you don't input a preset code for the TV (**TV INPUT/Control Mode Select** button) you will be able to control your TV using the dedicated **TV CONTROL** on the remote.

## Clearing the Preset Codes

Clears all presets, all learned functions and restores the factory presets.

- 1 While pressing the **REMOTE SETUP** button press and hold the **STANDARD** button for three seconds.

The LED on the remote control blinks three times indicating all the preset codes have been cleared. The remote control will reset as described in the box below.

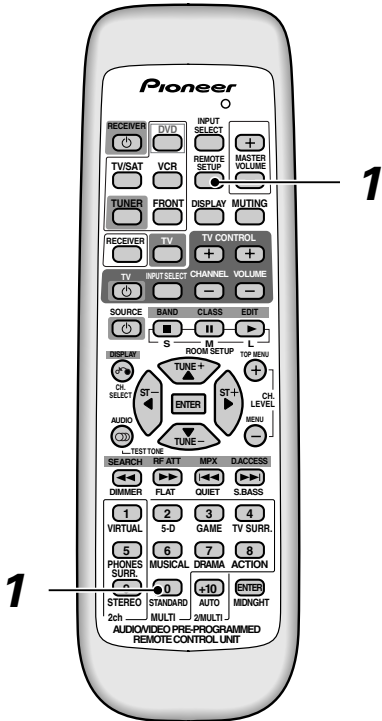

## Direct Selection

Turning the direct selection off is a useful feature which allows you keep the receiver in one function (for example, DVD) while putting the remote control in a different function. This could let you, for example, use the remote control to set up and watch a DVD and then use the remote control to rewind a tape in your VCR while you continue to watch the DVD on your DVD player.

When the direct selection is on any **INPUT/Control Mode Select** button you press will change the function of both the receiver and the remote control. When you turn the direct selection off, you can operate the remote control without affecting the receiver, as explained above.

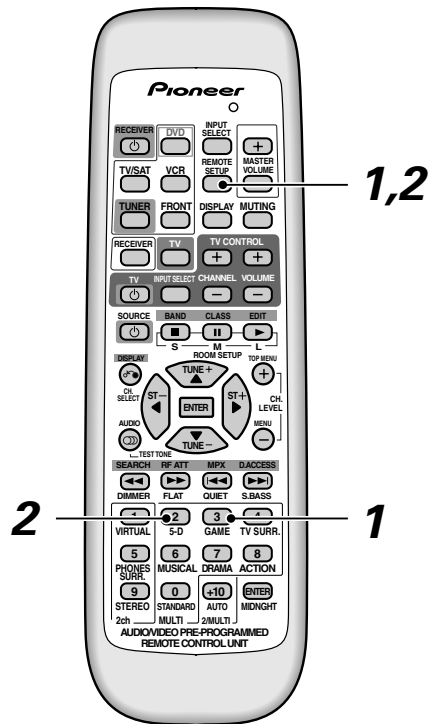

INPUT/Control Mode Select button	Preset Code	Component (Manufacturer)
DVD	000	DVD (PIONEER)
TV/SAT	600	TV (PIONEER)
VCR	456	DVD Recorder (PIONEER)
FRONT	400	VCR (PIONEER)
TV	600	TV (PIONEER)

To set a **INPUT/Control Mode Select** button to direct off:

- 1 While pressing the **REMOTE SETUP** button, press the number 3 (**GAME**) button.

To set a **INPUT/Control Mode Select** button to direct on:

- 2 While pressing the **REMOTE SETUP** button, press the number 2 (**5-D**) button.

**MEMO:**













- The default setting is on.

## Controlling the Rest of Your System

### CD/MD/CD-R/VCR/DVD/LD/DVD recorder/Cassette Deck Controls

This remote control can control these components after entering the proper codes or teaching the receiver the commands (see page 41-42).

Use **MULTI CONTROL** buttons to put the remote control in the stated mode.

Button(s)	Function	Components
SOURCE 	Press to switch the components between <b>STANDBY</b> and <b>ON</b> .	CD/MD/CD-R/VCR/DVD/LD/ DVD recorder/Cassette deck
	Press to return to the start of the current track or chapter. Repeated presses skips to the start of previous tracks or chapter.	CD/MD/CD-R/DVD/LD/ DVD recorder
	Go back channels (channel -).	VCR
	Play the reverse side of the tape on a reversible deck.	Cassette deck
	Press to advance to the start of the next track or chapter. Repeated presses skips to the start of following tracks or chapter.	CD/MD/CD-R/DVD/LD/ DVD recorder
	Go forward channels (channel +).	VCR
	Play the forward side of the tape on a reversible deck.	Cassette deck
	Pause playback or recording.	CD/MD/CD-R/VCR/DVD/LD/ DVD recorder/Cassette deck
	Hold down for fast forward playback.	CD/MD/CD-R/VCR/DVD/LD/ DVD recorder/Cassette deck
	Hold down for fast reverse playback.	CD/MD/CD-R/VCR/DVD/LD/ DVD recorder/Cassette deck
	Start playback.	CD/MD/CD-R/VCR/DVD/LD/ DVD recorder/Cassette deck
	Stop playback (on some models, pressing this when the disc is already stopped will cause the disc tray to open).	CD/MD/CD-R/VCR/DVD/LD/ DVD recorder/Cassette deck
Number Buttons	Directly access tracks on a program source.	CD/MD/CD-R/LD
	Directly access chapter on a program source.	DVD/DVD recorder
	Directly select a channel.	VCR
+10 Button	Select tracks or chapter higher than 10. Press this button and the remaining number to get the track or chapter (+10 Button + 3= track or chapter 13).	CD/MD/CD-R/VCR/ DVD/LD/DVD recorder
	Switches subtitles for DVD or video game control pad.	Video game
	Start recording. To prevent accidental recording, these buttons must be pressed together.	VCR/DVD recorder
MENU	Displays menus concerning the current DVD or DVR you are using.	DVD/DVD recorder
	Go back channels (channel -).	VCR
TOP MENU	Displays the top menu of the current DVD or DVR you are using.	DVD/LD/DVD recorder
	Go forward channels (channel +).	VCR
AUDIO	Changes the audio track of discs with more than one audio track.	DVD/LD/DVD recorder
RETURN	Takes you to the previous menu.	DVD/LD/DVD recorder
MIDNIGHT	Takes you to the DVD setup screen.	DVD
	Takes you to the disc navigator.	DVD recorder
	Changes between sides A & B of the disc.	LD
	Changes between the VCR tuner and the TV tuner.	VCR
	Menus specific to video game control pads appear. Use arrow buttons and ENTER button to select.	Video game
    & ENTER	Navigate DVD menus/options.	DVD/DVD recorder

#### MEMO:

- Depending on the maker and individual model, there are some buttons that may not be able operate some equipment or may operate it in a different way.

## Cable TV/Satellite TV/Digital TV/TV Controls

This remote control can control these components after entering the proper codes or teaching the receiver the commands (see page 41-42).

Use **MULTI CONTROL** buttons to put the remote control in the stated mode.

Button(s)	Function	Components
TV	Press to switch the TV or CATV between <b>STANDBY</b> and <b>ON</b> .	Cable TV/ Satellite TV/ TV
INPUT SELECT	Press to switch the TV input.	Cable TV/ Satellite TV/ TV
CHANNEL +/-	Select channels.	Cable TV/ Satellite TV/ TV
VOLUME +/-	Adjust the TV volume.	Cable TV/ Satellite TV/ TV
MENU	Takes you to the TV menu of that system.	Cable TV/ Satellite TV/ TV/ Digital TV
TOP MENU	Takes you to the guide menu of that system.	Cable TV/ Satellite TV/ TV/ Digital TV
DISPLAY	Takes you to the previous channel	TV
	Exits the menu you are viewing.	Cable TV/ Satellite TV/ Digital TV
TEST TONE	A	Satellite TV
	Use to move back a page in the menu.	Cable TV
	D/YELLOW	Satellite TV/ Digital TV
	Use to move forward a page in the menu.	Cable TV
	E/BLUE	Satellite TV/ Digital TV
	B/RED	Satellite TV/ Digital TV
	C/GREEN	Satellite TV/ Digital TV
+10 Button	Select channel higher than 10. Press this button and the remaining number to get the track or chapter (+10 Button + 3= track or chapter 13).	TV
Number Buttons	Use to select a specific TV channel.	Cable TV/ Satellite TV/ TV
MIDNIGHT	Use this button to immediately enter a new channel.	Cable TV/ TV
& ENTER	Press to select or adjust and navigate items on the menu screen.	Cable TV/ Satellite TV/ TV

**MEMO:**

- The first four buttons are dedicated to control the TV assigned to the **TV** button. Thus if you only have one TV to hook up to this system assign it to the **TV INPUT/Control Mode Select** button. If you have two TVs, assign the main TV to the **TV** button. If you hook up your system this way, the first four TV controls will always be accessible.
- Depending on the maker and individual model, there are some buttons that may not be able operate some equipment or may operate it in a different way.

## Preset Code List

### DVD

Manufacturer	Code
TOSHIBA	001
SONY	002
PANASONIC	003
JVC	004
SAMSUNG	005
SHARP	006
AKAI	007
RCA	009, 011
DENON	003, 010
HITACHI	012
PHILIPS	013
ZENITH	014
THOMSON	015
SONY (video game)	016
LOEWE	013
GOLDSTAR	014
PIONEER	000, 003, 008, 111

### LD

Manufacturer	Code
SONY	101, 102
PHILIPS	104
HITACHI	109
RADIOLA	104
MITSUBISHI	100
DENON	110
TELEFUNKEN	100
PIONEER	100, 111(DVD/LD)

### TV

Manufacturer	Code
PHILIPS	607, 631, 634, 656
SONY	604
GRUNDIG	631, 653
PANASONIC	608, 622, 631, 642
TOSHIBA	605, 653
TELEFUNKEN	636, 637, 652
SHARP	602
SAMSUNG	607, 638, 644, 646
HITACHI	606, 631, 633, 634, 636, 642, 643, 654
SABA	631, 636, 642, 651
BRANDT	636
SANYO	635, 645, 648
THOMSON	636, 651, 652
FERGUSON	607, 636, 651
NOKIA	632, 642, 652
MITSUBISHI	609, 631
SCHNEIDER	607, 641, 647
GOLDSTAR	607, 650
BLAUPUNKT	631
NORDMENDE	632, 636, 651, 652
RADIOLA	607
JVC	613
DAEWOO	607, 644, 656
ORION	607, 632, 639, 640
SIEMENS	631
ACURA	644
ADMIRAL	631
AKAI	632, 635, 642
AKUBA	641
ALBA	607, 639, 641, 644

AMSTRAD	642, 644, 647
ANITECH	644
ASA	645
ASUKA	641
AUDIOGONIC	607, 636
BASIC LINE	641, 644
BAUR	607, 631, 642
BEKO	638
BEON	607
BLUE SKY	641
BLUE STAR	618
BPL	618
BTC	641
BUSH	607, 641, 642, 644, 647, 656
CASCADE	644
CATHAY	607
CENTURION	607
CGB	642
CIMLINE	644
CLARIVOX	607
CLATRONIC	638
CONDOR	638
CONTEC	644
CROSLEY	632
CROWN	638, 644
CRYSTAL	642
CYBERTRON	641
DAINICHI	641
DANSAI	607
DAYTON	644
DECCA	607, 648
DIXI	607, 644
DUMONT	653
ELIN	607
ELITE	641
ELTA	644
EMERSON	642
ERRES	607
FINLANDIA	635, 643, 655
FINLUX	607, 632, 645, 648, 653, 654, 655
FIRSTLINE	640, 644
FISHER	632, 635, 638, 645
FORMENTI	607, 632, 642
FRONTECH	631, 642, 646
FRONTECH/ PROTECH	632
FUJITSU	648
FUNAI	640, 646
GBC	632, 642
GEC	607, 634, 648
GELOSO	632, 644
GENEXXA	631, 641
GOODMANS	607, 639, 647, 648, 656
GORENJE	638
GPM	641
GRAETZ	631, 642
GRANADA	607, 635, 642, 643, 648
GRANDIENTE	657
GRANDIN	618
HANSEATIC	607, 642
HCM	618, 644
HINARI	607, 641, 644
HISAWA	618
HUANYU	656

HYPSON	607, 618, 646
ICE	646, 647
IMPERIAL	638, 642
INDIANA	607
INGELEN	631
INTERFUNK	607, 631, 632, 642
INTERVISION	646, 649
ISUKAI	641
ITC	642
ITT	631, 632, 642
JEC	605
KAISUI	618, 641, 644
KAPSCH	631
KENDO	642
KENNEDY	632, 642
KORPEL	607
KOYODA	644
LEYCO	607, 640, 646, 648
LIESENK & TTER	607
LOEWE	607
LUXOR	632, 642, 643
M ELECTRONIC	631, 644, 645, 654, 655, 656
M-ELECTRONIC	607, 636, 651
MAGNADYNE	632, 649
MAGNAFON	649
MANESTH	639, 646
MARANTZ	607
MARK	607
MATSUI	607, 639, 640, 642, 644, 647, 648
MCMICHAEL	634
MEDIATOR	607
MEMOREX	644
METZ	631
MINERVA	631, 653
MULTITECH	644, 649
NECKERMANN	607, 631
NEI	607, 642
NIKKAI	605, 607, 641, 646, 648
NOBLIKO	649
OCEANIC	631, 632, 642
OSAKI	641, 646, 648
OSO	641
OSUME	648
OTTO VERSAND	607, 631, 632, 642
PALLADIUM	638
PANAMA	646
PATHO CINEMA	642
PAUSA	644
PHILCO	632, 642
PHOENIX	632
PHONOLA	607
PROFEX	642, 644
PROTECH	607, 642, 644, 646, 649
QUELLE	607, 631, 632, 642, 645, 653
R-LINE	607
RBM	653
REDIFFUSION	632, 642
REX	631, 646
ROADSTAR	641, 644, 646
SAISHO	639, 644, 646
SALORA	631, 632, 642, 643
SAMBERS	649
SBR	607, 634

SCHAUB LORENZ	642
SEG	642, 646
SEI	632, 640, 649
SELECO	631, 642
SIAREM	632, 649
SINUDYNE	632, 639, 640, 649
SKANTIC	643
SOLAVOX	631
SONOKO	607, 644
SONOLOR	631, 635
SONTEC	607
SOUNDWAVE	607
STANDARD	641, 644
STERN	631
SUSUMU	641
SYSLINE	607
TANDY	631, 641, 648
TASHIKO	634
TATUNG	607, 648
TEC	642
TELEAVIA	636
TELETECH	644
TENSAI	640, 641
THORN	607, 631, 642, 645, 648
TOMASHI	618
TOWADA	642
ULTRAVOX	632, 642, 649
UNIVERSUM	607, 631, 638, 642, 645, 646, 654, 655
VESTEL	607
VOXSON	631
WALTHAM	643
WATSON	607
WATT RADIO	632, 642, 649
WHITE	
WESTINGHOUSE	607
YOKO	607, 642, 646
PIONEER	600, 607, 631, 632, 636, 642, 651

## STB (SATELLITE/CATV)

Manufacturer	Code
JERROLD	716
SA	706, 708
ZENITH	717
PIONEER	200, 204, 231, 700

## On digital STB

Manufacturer	Code
PIONEER	200

## VCR

Manufacturer	Code
PHILIPS	414, 428
PANASONIC	408, 432
THOMSON	417, 428, 449
SONY	416, 417, 457, 458, 459
JVC	407, 417, 428
GRUNDIG	408, 414, 441, 453, 454, 455
AKAI	417, 442
HITACHI	406, 417, 441

TOSHIBA	405, 409, 414, 417, 428
MITSUBISHI	407, 409, 414
SHARP	402
ORION	424, 445, 446
SANYO	444
FERGUSON	417, 449, 450
BLAUPUNKT	408, 417, 432, 455
NOKIA	417, 442, 444
SELECO	417
AIWA	441, 446
AKIBA	453
ALBA	424, 446, 447, 448, 452
AMBASSADOR	452
AMSTRAD	441
ANITECH	453
ASA	411, 414
BAIRD	417, 441, 444, 450
BASIC LINE	448, 452, 453
BRANDT	449, 451
BRANDT	
ELECTRONIQUE	417
BUSH	424, 446, 447, 448, 453
CATRON	452
CGB	441
CIMLINE	453
CLATRONIC	452
CONDOR	452
CROWN	448, 452, 453
DAEWOO	448, 452
DANSAI	453
DE GRAAF	406
DECCA	414, 441
DUAL	417
DUMONT	414, 441, 444
ELCATECH	453
FIDELITY	441
FINLANDIA	414, 444
FINLUX	406, 414, 441, 444
FIRSTLINE	405, 409, 411, 424, 453
FISHER	444
FRONTECH	452
FUNAI	441
GBC	414
GENERAL	452
GOLDSTAR	411
GOODMANS	411, 441, 448, 452, 453
GRAETZ	417, 444
GRANADA	414, 444
GRANDIENTE	441
GRANDIN	411, 441, 453
HCM	453, 454
HINARI	445, 446, 453, 454
HYPSON	453
IMPERIAL	441
INTERFUNK	414
ITT	417, 428, 442, 444
ITV	411, 448
KAISUI	453
KENDO	424, 444
KORPEL	453
LEYCO	453
LOEWE	411, 414, 432

LUXOR	409, 442, 444
M-ELECTRONIC	441
MANESTH	405, 453
MARANTZ	414
MATSUI	424, 445, 446
MEMOREX	411, 441, 444
MEMPHIS	453
METZ	432, 455
MINERVA	455
MULTITECH	441, 453
MURPHY	441
NBC	407, 417
NECKERMANN	414
NESCO	453
NORDMENDE	417, 428
OCEANIC	417, 441
OSAKI	411, 441, 453
OTTO VERSAND	414
PALLADIUM	411, 417, 453
PATHE MARCONI	417
PENTAX	406
PERDIO	441
PHONOLA	414
PORTLAND	452
PROLINE	441, 454
PYE	414
QUELLE	414
RADIOLA	414
REX	417, 428
ROADSTAR	411, 448, 453
SABA	417, 428, 449
SAISHO	424, 445
SALORA	409, 442
SANSUI	407, 417
SBR	414
SCHAUB LORENZ	417, 441
SCHNEIDER	414, 441, 453
SEI	414
SENTRA	452
SHINTOM	453
SIEMENS	411, 444, 455
SINGER	405
SINUDYNE	414
SOLAVOX	452
SUNSTAR	441
SUNTRONIC	441
TASHIKO	441
TATUNG	414, 417, 441
TEC	452
TELEAVIA	417
TELEFUNKEN	417, 428, 449, 451
TENOSAL	453
TENSAI	441
THORN	417, 444
UNIVERSUM	411, 414, 441, 442, 455
YAMISHI	453
YOKAN	453
YOKO	452
PIONEER	400, 407, 414, 443

## Controlling the Rest of Your System

### DVD Recorder

Manufacturer	Code
PIONEER	456

### TAPE

Manufacturer	Code
AKAI	829
ARCAM	810
DENON	810, 827
FISHER	813
GRUNDIG	821
JVC	802
KENWOOD	804, 807, 822
LUXMAN	815
MARANTZ	821
MEMOREX	825
MITSUBISHI	829
NAKAMICHI	816
ONKYO	817, 819
PHILIPS	821
SANSUI	824
SHERWOOD	818
SONY	814, 823
TANDBERG	820
TECHNICS	803
TOSHIBA	826, 828
YAMAHA	811, 822
PIONEER	800, 825

### CD

Manufacturer	Code
AKAI	335
ARCAM	336
ASUKA	337
AUDIO TON	336
BUSH	332
CALIFORNIA	
AUDIO LAB	304
CYRUS	336
DENON	309
DUAL	319, 337
FISHER	340
GOLDSTAR	330
GRUNDIG	336
HITACHI	334
INTERSOUND	337
JVC	331
KENWOOD	310, 311
KODAK	322
LINN	336
LUXMAN	341
M ELECTRONIC	344
MARANTZ	304, 336
MATSUI	336
MCS	304
MEMOREX	300
MERIDIAN	336
MITSUBISHI	335
NAD	316
NAIM	336
ONKYO	342
PANASONIC	304
PHILIPS	322, 336
QUAD	336

QUASAR	304
ROADSTAR	344
ROTEL	336
SABA	319
SANYO	340
SHARP	343
SONY	316, 329
TECHNICS	304, 333
TELEFUNKEN	319
THOMSON	319
UNIVERSUM	336
YAMAHA	338, 339
PIONEER	300

### CD-R

Manufacturer	Code
PIONEER	345
PHILIPS	346
DENON	346
MARANTZ	346

### MD

Manufacturer	Code
SONY	901
KENWOOD	903
SHARP	902
TEAC	904
ONKYO	905
DENON	906
PIONEER	900, 902,

### DAT

Manufacturer	Code
PIONEER	907



## Troubleshooting

Incorrect operations are often mistaken for trouble and malfunctions. If you think that there is something wrong with this component, check the points below. Sometimes the trouble may lie in another component. Investigate the other components and electrical appliances being used. If the trouble cannot be rectified even after exercising the checks listed below, ask your nearest PIONEER authorized service center or your dealer to carry out repair work.

Symptom	Cause	Remedy
The power does not turn on.	<ul style="list-style-type: none"> <li>The power plug is disconnected.</li> <li>The protection circuit may have been activated.</li> <li>Speaker wire may be touching the rear panel.</li> <li>Static electricity caused by dry air.</li> </ul>	<ul style="list-style-type: none"> <li>Connect the power plug to the wall outlet.</li> <li>Disconnect the power plug from the outlet, and insert again.</li> <li>Make sure there are no loose strands of speaker wire touching the rear panel. This could cause the receiver to shut off automatically.</li> <li>Disconnect the power plug from the outlet, and insert again.</li> </ul>
AMP ERR blinks in the display and the unit turns off.	<ul style="list-style-type: none"> <li>The receiver has a serious problem.</li> </ul>	<ul style="list-style-type: none"> <li>Call a Pioneer-accredited repair center.</li> </ul>
HEAT UP blinks in the display.	<ul style="list-style-type: none"> <li>The receiver has gotten too hot.</li> </ul>	<ul style="list-style-type: none"> <li>Allow the receiver to cool down with good ventilation. If problem persists turn off receiver and allow it to cool down.</li> </ul>
OVERHEAT blinks in the display and no sound is output.	<ul style="list-style-type: none"> <li>The receiver has gotten too hot.</li> </ul>	<ul style="list-style-type: none"> <li>Turn the receiver off and allow it to cool down with good ventilation. If problem persists turn the volume down.</li> </ul>
THDCT NG blinks in the display and no sound is output.	<ul style="list-style-type: none"> <li>The thermistor (temperature sensor) is out of order.</li> </ul>	<ul style="list-style-type: none"> <li>Call a Pioneer-accredited repair center.</li> </ul>
The unit does not respond when the buttons are pressed.	<ul style="list-style-type: none"> <li>Improper connections.</li> <li>Sound is muted.</li> <li>The volume is turned down.</li> </ul>	<ul style="list-style-type: none"> <li>Make sure the component is connected correctly (refer to pages 11 to 14).</li> <li>Press MUTING on the remote control.</li> <li>Adjust the MASTER VOLUME.</li> </ul>
No sound is output when the TUNER is selected.	<ul style="list-style-type: none"> <li>Incorrect frequency.</li> <li>The antenna is not connected.</li> </ul>	<ul style="list-style-type: none"> <li>Tune in the correct frequency.</li> <li>Connect the antenna (refer to page 16).</li> </ul>
Considerable noise in radio broadcasts.	<b>FM broadcasts</b> <ul style="list-style-type: none"> <li>The FM antenna is not fully extended or is poorly positioned.</li> <li>Weak radio signals.</li> </ul>	<ul style="list-style-type: none"> <li>Fully extend the FM wire antenna, position for best reception, and secure to a wall.</li> <li>Connect an outdoor FM antenna (refer to page 16).</li> </ul>
	<b>AM broadcasts</b> <ul style="list-style-type: none"> <li>The AM antenna is poorly positioned.</li> <li>Weak radio signals.</li> <li>Interference caused by other equipment (fluorescent lamp, motor, etc.).</li> </ul>	
Broadcast stations cannot be selected automatically.	<ul style="list-style-type: none"> <li>The radio signal is too weak .</li> </ul>	<ul style="list-style-type: none"> <li>Connect an outdoor antenna (refer to page 16).</li> </ul>

## Additional Information





Symptom	Cause	Remedy
No sound from surround or center speakers.	<ul style="list-style-type: none"> <li>• Speaker settings are incorrect.</li> <li>• The surround and/or center levels are turned down.</li> <li>• The surround and/or center speakers are disconnected.</li> </ul>	<ul style="list-style-type: none"> <li>• Refer to “Speakers setting mode” on page 26 to check the speaker settings.</li> <li>• Turn levels up. Refer to “Setting the volume level of each channel” on page 29 to check the speaker levels.</li> <li>• Connect the speakers (refer to page 14).</li> </ul>
No sound from subwoofer	<ul style="list-style-type: none"> <li>• The subwoofer is disconnected.</li> <li>• The subwoofer's settings are incorrect.</li> <li>• The subwoofer's levels are too low.</li> <li>• The LFE Attenuator is set to OFF.</li> </ul>	<ul style="list-style-type: none"> <li>• Connect the subwoofer (refer to page 14).</li> <li>• Set subwoofer to ON or PLUS (refer to page 26).</li> <li>• Set the FRONT speakers to SMALL (refer to page 26).</li> <li>• Refer to “Setting the volume level of each channel” on page 29 to check the speaker levels.</li> <li>• Set the LFE Attenuator to either 0dB or -10dB (refer to page 27).</li> </ul>
Sound is produced from analog components, but not from digital ones (DVD, LD, CD-ROM etc.).	<ul style="list-style-type: none"> <li>• Digital connections are incorrect.</li> <li>• The digital output of the player is turned off.</li> <li>• The CD-ROM player is outputting a data stream (not an audio signal) which is incompatible with this receiver.</li> <li>• Digital connections are incorrect.</li> <li>• Analog input has been selected.</li> </ul>	<ul style="list-style-type: none"> <li>• Make digital connections (refer to page 11)</li> <li>• Turn on the digital output of the player on (consult the manual that came with the player, if necessary).</li> <li>• Use a player that is compatible with this receiver.</li> <li>• Make digital connections (refer to page 11).</li> <li>• Select digital input (refer to page 39).</li> </ul>
No sound is output or a noise is output when Dolby Digital/DTS software is played back.	<ul style="list-style-type: none"> <li>• A DVD player not compatible with Dolby Digital/DTS is being used.</li> <li>• The settings on the DVD player are incorrect and/or the DTS signal output is turned off.</li> <li>• The digital output level is turned down on a CD player or other component equipped with digital output level adjustment capability. (The DTS signal has been altered by the player, and cannot be read.)</li> </ul>	<ul style="list-style-type: none"> <li>• Make sure your DVD player is compatible with Dolby Digital/DTS.</li> <li>• Make sure the player's settings are correct and/or the DTS signal out is on. Refer to the instruction manual supplied with the DVD player.</li> <li>• Set the digital volume level of the player to full, or to the neutral position.</li> </ul>
When a search is performed by a DTS compatible CD player during playback, noise is output.	<ul style="list-style-type: none"> <li>• The search function performed by the player slightly alters the digital information, making it unreadable.</li> </ul>	<ul style="list-style-type: none"> <li>• This is not a malfunction, but be sure to turn the volume down to prevent the output of loud noise from your speakers.</li> </ul>
The Dolby/DTS indicator doesn't light when playing Dolby/DTS software.	<ul style="list-style-type: none"> <li>• The player is paused</li> <li>• The player's sound output settings are wrong.</li> </ul>	<ul style="list-style-type: none"> <li>• Press play.</li> <li>• Set the player correctly (consult the manual that came with the player, if necessary).</li> </ul>
When playing a 96 kHz/24bit disc the sound is too loud.	<ul style="list-style-type: none"> <li>• Different discs have different recording levels so some may be louder than others.</li> </ul>	<ul style="list-style-type: none"> <li>• Turn the volume down.</li> </ul>

Symptom	Cause	Remedy
The sound distorts.	<ul style="list-style-type: none"> <li>The analog signal is too strong.</li> <li>Master volume is too loud.</li> </ul>	<ul style="list-style-type: none"> <li>Turn on input attenuator (see page 28).</li> <li>Turn the volume down.</li> </ul>
You can only hear treble from speakers.	<ul style="list-style-type: none"> <li>The FRONT speakers are set to small.</li> </ul>	<ul style="list-style-type: none"> <li>Set the FRONT speakers to large (refer to page 26).</li> </ul>
No image is output when an input is selected.	<ul style="list-style-type: none"> <li>The video connections are incorrect.</li> <li>The input source is not properly selected.</li> <li>The DVD/video player settings are incorrect.</li> </ul>	<ul style="list-style-type: none"> <li>Make sure the video component is connected correctly (refer to pages 11 to 14).</li> <li>Make sure the proper component is selected by pressing the correct function button (see page 20).</li> <li>Set correctly. Refer to the instruction manual supplied with the DVD/video player.</li> </ul>
The settings have all been cleared.	<ul style="list-style-type: none"> <li>The receiver has been unplugged or the main power turned off for more than a month.</li> </ul>	<ul style="list-style-type: none"> <li>Set the receiver again (refer to page 24-29).</li> </ul>
OVERLOAD blinks in the display and the power turns off automatically.	<ul style="list-style-type: none"> <li>There is a short in your speaker cable.</li> <li>The output is too high.</li> </ul>	<ul style="list-style-type: none"> <li>Fix the short or get new speaker cable.</li> <li>Turn the volume down.</li> </ul>
You can't set the crossover frequency.	<ul style="list-style-type: none"> <li>All the speakers are set to either large or NO (i.e. no speakers are set to small).</li> </ul>	<ul style="list-style-type: none"> <li>Change the speaker settings (refer to page 26).</li> </ul>
The display is dark or off.	<ul style="list-style-type: none"> <li>The DIMMER feature is set to dark or off.</li> </ul>	<ul style="list-style-type: none"> <li>Press DIMMER on the remote control repeatedly to select a different brightness.</li> </ul>
After making an adjustment the display goes off.	<ul style="list-style-type: none"> <li>The DIMMER feature is set to off.</li> </ul>	<ul style="list-style-type: none"> <li>Press DIMMER on the remote control repeatedly to select a different brightness.</li> </ul>
The receiver cannot be remote controlled.	<ul style="list-style-type: none"> <li>The remote control batteries have worn out.</li> <li>You are too far away or at a bad angle for operation.</li> <li>There is an obstacle between the receiver and the remote control.</li> <li>Strong light such as fluorescent light.</li> <li>The remote is not in the proper mode to control the receiver.</li> </ul>	<ul style="list-style-type: none"> <li>Replace the batteries (refer to page 10).</li> <li>Operate within 7 m, 30° of the remote sensor on the front panel (refer to page 10).</li> <li>Remove the obstacle or operate from another angle of position.</li> <li>Avoid exposing the remote sensor on the front panel to direct light.</li> <li>Press RECEIVER button.</li> </ul>
Other components cannot be remote controlled.	<ul style="list-style-type: none"> <li>The proper code hasn't been input into the remote control to control that component.</li> <li>The remote control is in a mode to make some setting or control something on the receiver.</li> <li>Something is plugged into the "Control Terminal in" (see page 17).</li> </ul>	<ul style="list-style-type: none"> <li>Input the proper code into the remote control (see page 42).</li> <li>Press the button of the component you want to control.</li> <li>Either point remote at the remote sensor of the unit that is plugged into the "Control Terminal in" or unplug the cable from the "Control Terminal in" and use remote normally.</li> </ul>
The shutter of the optical terminal doesn't close after removing plug..	<ul style="list-style-type: none"> <li>The plug was inserted improperly</li> </ul>	<ul style="list-style-type: none"> <li>The terminal is fine but the shutter won't close.</li> </ul>

If the unit does not operate normally due to external effects such as static electricity. Disconnect the power plug from the outlet and insert again to return to normal operating conditions.

## Understanding DVD Packaging

DVD packaging usually states what sound formats are included on the DVD. The diagram here shows what you might see on a typical DVD box. The terms used (Dolby Digital, etc.) are explained in the following sections.

LANGUAGE	English
 DOLBY DIGITAL	 5.1 SURROUND
 DTS	 5.1 SURROUND
CAPTIONS SUBTITLES	Captioned

## Digital Audio Formats

Home theater uses various types of methods to encode the sound on to the digital sources and these are known as digital formats. The most common digital formats are explained below.

### Dolby Digital and Dolby Surround

Dolby Digital is the most widely used system to record soundtracks on DVDs and other media. It's a sound compression format which records the sound of 6 channels of the theater surround system (Dolby Digital) on a movie film digital track. Of the 6 channels, the subwoofer channel is intended for bass only, and because the frequency range is smaller than a main channel, the overall soundtrack is called 5.1 channels.

Dolby Digital is the name of the Dolby surround multichannel digital system that was developed after the Dolby Surround System and Dolby Pro Logic Surround System.

Dolby Digital is also known as the 5.1 channel system. It is equipped with 5 channels (front left, front right, center, surround left, surround right) in the frequency range from 20 Hz to 20 kHz and an independent Low Frequency Effect (LFE) channel. The subwoofer channel is also called Low Frequency Effect (LFE).

This channel can be used with a powered subwoofer to get strong bass sounds.

### DTS

DTS is another widely used system to record soundtracks on DVDs and other media. It has been adopted as a sound recording format in the latest movie theaters since the release of "JURASSIC PARK" in 1993, and has a good reputation for high quality sound and dynamic surround effects.

In this system, 6 channels of digital sound are recorded on CD-ROM, rather than on the film. DTS adopts a simultaneous playback format. With a low rate of compression of sound signals and a high rate of transmittance, a higher sound quality format is produced. Also, unlike the process of recording digital sounds on film directly, the only components required are a CD-ROM player as might be used with a personal computer and a DTS processor, and therefore less investment is required than with other formats. For this reason, the format is being introduced in more and more movie theaters, and is being adopted in home movie software (DVD, LD) and music software (5.1 channel CD).

	Dolby Digital	DTS	Dolby Pro Logic Surround
No. of recorded channels	5.1 channels (Max.)	5.1 channels (Max.)	2 channels
No. of playback channels	5.1 channels (Max.)	5.1 channels (Max.)	4 channels
Playback channel structure	Front Left, Front Right, Center, Surround Left, Surround Right, Subwoofer	Front Left, Front Right, Center, Surround Left, Surround Right, Subwoofer	Front Left, Front Right, Center, Surround
Sound processing	Digital discrete processing	Digital discrete processing	Analog matrix processing
Rear (Surround) high frequency playback limit	20,000 Hz	20,000 Hz	7,000 Hz
Other	<ul style="list-style-type: none"> <li>• 5.1 completely independent channels</li> <li>• High dynamic range</li> <li>• Stable position, high phase characteristics, and advanced surround effects reproduction</li> <li>• High efficiency (Compression rate of about one-tenth)</li> </ul>	<ul style="list-style-type: none"> <li>• 5.1 completely independent channels</li> <li>• High dynamic range</li> <li>• Stable position, high phase characteristics, and advanced surround effects reproduction</li> <li>• Low compression rate (about one-fourth), high quality sound</li> </ul>	

## MPEG-2

This is a standard audio format used on Video CDs, some DVD discs and, importantly, most digital satellite TV broadcasting. Its advantages include a low bit rate that still affords good sounds quality for multichannel soundtracks. This is a patented system in the USA.

## PCM (Pulse Code Modulation)

This is an uncompressed 2 channel stereo format found on most CDs and DATs. PCM can be used as one of the audio recording formats for DVD but as it's only 2 channel stereo. It is sometimes used for DVD audio discs (or DVD-A).

## Recording Formats

These are the recording formats. Determining what kind of playback format is being employed with any particular recording format depends on three things: 1) how the signal is encoded and transmitted; 2) how the signal is decoded; and 3) how the sound is actually heard through the speakers (where your speaker configuration and the sound mode you choose have a big effect).

All the possibilities are listed below.

### 2 Channel Stereo

In this format the signal is recorded on two channels (i.e. stereo), left and right. Most music CDs use this format.

### 2 Channel Surround (Dolby Surround)

Used mainly for videotape, this is one of the original home theater formats and can be decoded by this receiver. Because it developed over a time it is the most complicated system explained here. The developers had to solve the problem of how to offer surround sound to the people who had the proper decoder but at the same time deliver 2 channel sound to those without the proper decoder. Thus the Dolby Surround format encodes four channels (left, right, center, surround) into two channels for storage and transmission.

This signal is decoded back into four channels (as above) by Dolby Pro Logic as explained on the right.

### 5.1 Channel Surround

This is a format with five channels (front left & right, center, surround left & right) and a channel for bass. (This is called the LFE channel and is usually output from a subwoofer. Since it is only for bass sounds is and thus expressed as .1 of a channel.) With this format you can get movie theater-like, powerful surround sound.

### Playback Formats

This receiver is equipped with many different playback formats and this flexibility should allow you to get stereo or surround sound playback (depending on the kind of source you're using) with all speaker configurations.

#### **2 Channel Stereo Playback (STEREO indicator lights)**

This is conventional stereo playback from the left and right speakers (called "front" speakers on this receiver).

#### **Virtual Surround Playback (VIRTUAL/PHONES indicator lights)**

You can get multichannel-like surround sound even when using just two speakers. This is achieved by the Virtual surround listening mode which uses SRS Tru Surround technology.

#### **Dolby Pro Logic Surround Playback (DOLBY PRO LOGIC indicator lights)**

As explained in the 2 channel surround signals entry on the left, this receiver allows you to hear four channel surround sound from 2 channel surround sound signals (i.e. Dolby Surround). Actually the surround speakers will be mono, outputting the same sound but you will still be able to get theater-like sound.

#### **Multichannel Surround Playback (MULTI ch indicator lights)**

Technically speaking your source needs to have at least three channels and you need to be listening on at least three speakers to have multichannel surround playback. Practically speaking almost all DVDs have 5.1 channel surround sound so you should have at least three speakers hooked up so you can experience this playback mode, which is the heart of home theater. We strongly recommend you hook up five speakers for realistic and powerful surround sound playback.

#### **Headphone Surround Playback (VIRTUAL/PHONES indicator lights)**

This receiver allows you to experience surround sound like effects even when listening on headphones. This new technology is useful for getting a surround sound feeling even when listening with the privacy of headphones.

## Specifications

### Amplifier Section

Continuous Power Output (STEREO MODE)  
FRONT ..... 25 W + 25 W (DIN 1 kHz, THD 1 %, 8 Ω)

Continuous Power Output (SURROUND MODE)  
FRONT ..... 30 W/ch (1 kHz, THD 1 %, 8 Ω)  
CENTER ..... 30 W (1 kHz, THD 1 %, 8 Ω)  
SURROUND ..... 30 W/ch (1 kHz, THD 1 %, 8 Ω)

Input (Sensitivity/Impedance)  
DVD, TV/SAT, VCR, FRONT ..... 200 mV/47 kΩ  
Frequency Response  
DVD, TV/SAT, VCR, FRONT  
..... 5 Hz to 100,000 Hz  $\pm 3$  dB

Output (Level/Impedance)  
VCR OUT ..... 200 mV/2.2 kΩ

Signal-to-Noise Ratio  
[DIN (Continuous rated power output/50 mW)]  
DVD, TV/SAT, VCR, FRONT ..... 88 dB/64 dB

### VIDEO Section

Input (Sensitivity/Impedance)  
DVD, TV/SAT, VCR, FRONT ..... 1 V<sub>p-p</sub>/75 Ω  
Output (Level/Impedance)  
VCR, MONITOR ..... 1 V<sub>p-p</sub>/75 Ω  
Frequency Response  
DVD, TV/SAT, VCR, FRONT → MONITOR  
..... 5 Hz to 7 MHz  $\pm 3$  dB  
Signal-to-Noise Ratio ..... 55 dB

### FM Tuner Section

Frequency Range ..... 87.5 MHz to 108 MHz  
Usable Sensitivity  
Mono: 15.2 dBf, IHF (1.6 μV/ 75 Ω)  
50 dB Quieting Sensitivity ..... Mono: 20.2 dBf  
..... Stereo: 41.2 dBf  
Signal-to-Noise Ratio ..... Mono: 76 dB (at 85 dBf)  
..... Stereo: 72 dB (at 85 dBf)  
Distortion ..... Stereo: 0.6 % (1 kHz)  
Alternate Channel Selectivity ..... 70 dB (400 kHz)  
Stereo Separation ..... 40 dB (1 kHz)  
Frequency Response ..... 30 Hz to 15 kHz (±1dB)  
Antenna Input (DIN) ..... 75 Ω unbalanced

### AM Tuner Section

Frequency Range ..... 531 kHz to 1,602 kHz  
Sensitivity (IHF, Loop antenna) ..... 350 μV/m  
Selectivity ..... 30 dB  
Signal-to-Noise Ratio ..... 50 dB  
Antenna ..... Loop antenna

### Miscellaneous

Power Requirements  
UK model ..... AC 220 – 230 V, 50/60 Hz  
European model ..... AC 220 – 230 V, 50/60 Hz  
Power Consumption ..... 130 W  
In Standby ..... 1 W  
Dimensions ..... 420 (W) x 65 (H) x 322 (D) mm  
Weight (without package) ..... 5.2 kg

### Furnished Parts

AM loop antenna ..... 1  
FM wire antenna ..... 1  
Dry cell batteries (AA size IEC R6P) ..... 2  
Remote control unit ..... 1  
Power cord ..... 1  
Speaker cord labels ..... 1  
Operating instructions ..... 1

### NOTE:

- Specifications and the design are subject to possible modifications without notice, due to improvements.

Published by Pioneer Corporation.  
Copyright © 2000 Pioneer Corporation.  
All rights reserved.

---

**PIONEER CORPORATION** 4-1, Meguro 1-Chome, Meguro-ku, Tokyo 153-8654, Japan  
**PIONEER ELECTRONICS [USA] INC.** P.O. BOX 1540, Long Beach, California 90801-1540, U.S.A.  
**PIONEER ELECTRONICS OF CANADA, INC.** 300 Allstate Parkway, Markham, Ontario L3R 0P2, Canada  
**PIONEER EUROPE NV** Haven 1087, Keetberglaan 1, B-9120 Melsele, Belgium TEL: 03/570.05.11  
**PIONEER ELECTRONICS AUSTRALIA PTY. LTD.** 178-184 Boundary Road, Braeside, Victoria 3195, Australia, TEL: [03] 9586-6300  
**PIONEER ELECTRONICS DE MEXICO S.A. DE C.V.** San Lorenzo 1009 3er Piso Desp. 302 Col. Del Valle Mexico D.F. C.P. 03100  
TEL: 5-688-52-90



## Free Manuals Download Website

<http://myh66.com>

<http://usermanuals.us>

<http://www.somanuals.com>

<http://www.4manuals.cc>

<http://www.manual-lib.com>

<http://www.404manual.com>

<http://www.luxmanual.com>

<http://aubethermostatmanual.com>

Golf course search by state

<http://golfingnear.com>

Email search by domain

<http://emailbydomain.com>

Auto manuals search

<http://auto.somanuals.com>

TV manuals search

<http://tv.somanuals.com>