

Pioneer *sound.vision.soul*

**AUDIO/VIDEO MULTI-CHANNEL
RECEIVER**

VSX-D514

VSX-D714

VSX-D814

Operating Instructions

IMPORTANT



The lightning flash with arrowhead, within an equilateral triangle, is intended to alert the user to the presence of uninsulated "dangerous voltage" within the product's enclosure that may be of sufficient magnitude to constitute a risk of electric shock to persons.

CAUTION

RISK OF ELECTRIC SHOCK
DO NOT OPEN

CAUTION:

TO PREVENT THE RISK OF ELECTRIC SHOCK, DO NOT REMOVE COVER (OR BACK). NO USER-SERVICEABLE PARTS INSIDE. REFER SERVICING TO QUALIFIED SERVICE PERSONNEL.



The exclamation point within an equilateral triangle is intended to alert the user to the presence of important operating and maintenance (servicing) instructions in the literature accompanying the appliance.

D3-4-2-1-1_En

NOTE: This equipment has been tested and found to comply with the limits for a Class B digital device, pursuant to Part 15 of the FCC Rules. These limits are designed to provide reasonable protection against harmful interference in a residential installation. This equipment generates, uses, and can radiate radio frequency energy and, if not installed and used in accordance with the instructions, may cause harmful interference to radio communications. However, there is no guarantee that interference will not occur in a particular installation. If this equipment does cause harmful interference to radio or television reception, which can be determined by turning the equipment off and on, the user is encouraged to try to correct the interference by one or more of the following measures:

- Reorient or relocate the receiving antenna.
- Increase the separation between the equipment and receiver.
- Connect the equipment into an outlet on a circuit different from that to which the receiver is connected.
- Consult the dealer or an experienced radio/TV technician for help.

D8-10-1-2_En

Information to User

Alteration or modifications carried out without appropriate authorization may invalidate the user's right to operate the equipment.

D8-10-2_En

CAUTION: This product satisfies FCC regulations when shielded cables and connectors are used to connect the unit to other equipment. To prevent electromagnetic interference with electric appliances such as radios and televisions, use shielded cables and connectors for connections.

D8-10-3a_En

WARNING: The apparatus is not waterproofs, to prevent fire or shocks hazard, do not expose this apparatus to rain or moisture and do not put any water source near this apparatus, such as vase, flower pot, cosmetics container and medicine bottle etc.

D3-4-2-1-3_En

Before changing the voltage, disconnect the AC power cord. Use a medium size screwdriver to change the voltage selector switch.

If the voltage is not properly set or if you move to an area where the voltage requirements differ, adjust the selector switches as follows.

1. Use a medium-size screwdriver.
2. First, insert the screwdriver in the groove of the voltage selector at the right, and adjust so that the tip of the groove points to the voltage value of your area.
3. Next, insert the screwdriver in the groove of the voltage selector at the left and adjust until the voltage is the same as at the right.

The STANDBY/ON switch is secondary connected and therefore, does not separate the unit from mains power in STANDBY position. Therefore install the unit suitable places easy to disconnect the MAINS plug in case of the accident. The MAINS plug of unit should be unplugged from the wall socket when left unused for a long period of time.

D3-4-2-2a_En

Voltage selector

You can find the voltage selector switch on the rear panel of multi-voltage models.

The factory setting for the voltage selector is 220 V. Please set it to the correct voltage for your country or region.

- Saudi Arabia operates on 127V and 220V mains voltage. Please set to the correct voltage before using.
- For Taiwan please set to 110 V before using.

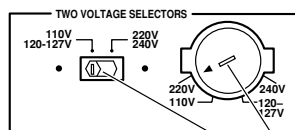

Medium-size screwdriver

D3-4-2-1-5_En

Thank you for buying this Pioneer product.

Please read through these operating instructions so that you will know how to operate your model properly. After you have finished reading the instructions, put them in a safe place for future reference.

01 Before you start

Checking what's in the box	5
Making cable connections	5
Loading the batteries	5
Operating range of remote control unit	6

02 5 minute guide

Introduction to home theater	7
Listening to Surround Sound	8
Using the Quick Setup	12

03 Connecting up

Audio/Video cords	14
S-video cables	14
Component video cords	14
Digital audio coaxial cords/Optical cables	14
Connecting digital components	15
Connecting audio components	16
Connecting DVD 5.1 channel components	17
Connecting video components	18
Connecting to the front panel video terminal	18
Connecting antennas	19
FM wire antenna	19
AM loop antenna	19
Using external antennas	19
Connecting the speakers	
(VSX-D514/D714)	20
Connecting the speakers (VSX-D814)	21
Speaker terminals	22
A and B speaker systems	22
Hints on speaker placement	22
Speaker placement diagrams	23
Connecting additional amplifiers	24
Power cord caution	25
Operating other Pioneer components	25
Using this receiver with a Pioneer plasma display	26

04 Controls and displays

Front panel (VSX-D514)	27
Front panel (VSX-D714/D814)	29
Display	31
Remote control	32

05 Listening to your system

Listening in surround sound	36
Using the Advanced surround effects	37
Listening in stereo	38
Choosing the input signal	38
Using the Surround Back Channel (SB CH)	39
Using the Virtual Surround Back mode (VSB)	40
Using Midnight and Loudness listening	41
Using the tone controls	41
Playing other sources	42
Selecting the multichannel analog inputs	42
VSX-D514 model:	42
VSX-D714/D814 model:	42
Using the sleep timer	43

06 Setting up the receiver

Choosing your receiver setup	44
Speaker setting	46
Surround back speaker setting	46
Subwoofer setting	47
Crossover frequency setting	47
LFE attenuator setting	47
Front speaker distance setting	48
Front left speaker distance setting	48
Center speaker distance setting	48
Front right speaker distance setting	48
Surround speaker distance setting	48
Surround right speaker distance setting	49
Surround back speaker distance setting	49
Surround left speaker distance setting	49
Subwoofer distance setting	49

Dynamic range control setting	50
Dual mono setting	50
Component video input settings	50
Digital input settings	50
SR+ control for Pioneer plasma displays	51
Manually calibrating your listening area (MCACC)	52
Setting separate channel levels for listening modes	53
Using the SR+ mode with a Pioneer plasma display	54

07 Using the tuner

Listening to the radio	56
Improving FM stereo sound	56
Tuning directly to a station	56
Saving station presets	57
Naming station presets	58
Listening to station presets	58
Changing the frequency step	58

08 Making recordings

Making an audio or a video recording	59
--	----

09 Controlling the rest of your system

Setting the remote to control other components	60
Selecting preset codes directly	60
Programming signals from other remote controls	61
Erasing all of your programmed settings	62
Clearing all the remote control settings	62
Direct function	62
Controls for TVs	63
Controls for other components	64

Preset Code List (VSX-D514/D714)	66
Preset Code List (VSX-D814)	68

10 Additional information

Troubleshooting	70
Resetting the main unit	72
Switching the speaker impedance	72
Specifications	73
Amplifier section	73
Audio section	73
Video Section	73
Component video section	73
FM Tuner Section	74
AM Tuner Section	74
Miscellaneous	74
Cleaning the unit	74

"DTS", "DTS-ES Extended Surround" and "Neo:6" are trademarks of Digital Theater Systems, Inc.

Manufactured under license from Dolby Laboratories. "Dolby", "Pro Logic", "Surround EX", and the double-D symbol are trademarks of Dolby Laboratories.

For U.S. and Australia Model



C67-7-3_En

Chapter 1: Before you start

Checking what's in the box

Please check that you've received the following supplied accessories:

- AM loop antenna
- FM wire antenna
- Dry cell batteries (AA size IEC R6) x2
- Remote control
- Power cords (make sure you use the correct cord for your country/region):
 - VSX-D514/D714/D814-K (black models)*
Round 2-pin type and Australian type
 - VSX-D514/D714-S (silver models)*
Round 2-pin type, flat blade 2-pin type and UK 3-pin type (Except Australian model)
 - VSX-D814-S (silver model)*
Round 2-pin type, flat blade 2-pin type, UK 3-pin type and Australian type
- Power plug adaptor (*VSX-D514/D714/D814-K only*) x1
- J-shape plug (*VSX-D514/D714/D814-K only*) x1
- These operating instructions

Making cable connections

Make sure not to bend the cables over the top of this unit (as shown in the illustration). If this happens, the magnetic field produced by the transformers in this unit may cause a humming noise from the speakers.

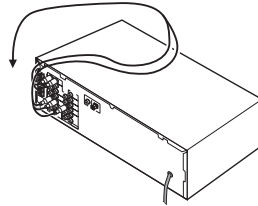

Loading the batteries

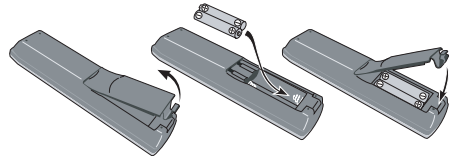

Important

Incorrect use of batteries may result in such hazards as leakage and bursting. Observe the following precautions:

- Never use new and old batteries together.
- Insert the plus and minus sides of the batteries properly according to the marks in the battery case.
- Batteries with the same shape may have different voltages. Do not use different batteries together.
- When disposing of used batteries, please comply with governmental regulations or environmental public instruction's rules that apply in your country or area.

Operating range of remote control unit

The remote control may not work properly if:

- There are obstacles between the remote control and the receiver's remote sensor.
- Direct sunlight or fluorescent light is shining onto the remote sensor.
- The receiver is located near a device that is emitting infrared rays.
- The receiver is operated simultaneously with another infrared remote control unit.

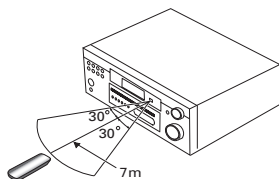

Chapter 2:

5 minute guide

Introduction to home theater

You are probably used to using stereo equipment to listen to music, but may not be used to home theater systems that give you many more options (such as surround sound) when listening to soundtracks.

Home theater refers to the use of multiple audio tracks to create a surround sound effect, making you feel like you're in the middle of the action or concert. The surround sound you get from a home theater system depends not only on the speakers you have set up in your room, but also on the source and the sound settings of the receiver.

DVD-Video has become the basic source material for home theater due to its size, quality, and ease of use. Depending on the DVD, you can have up to seven different audio tracks coming from one disc, all of them being sent to different speakers in your system. This is what creates a surround sound effect and gives you the feeling of 'being there'.

This receiver will automatically decode Dolby Digital, DTS, or Dolby Surround DVD-Video discs, according to your speaker setup. In most cases, you won't have to make changes for realistic surround sound, but other possibilities (like listening to a CD with multichannel surround sound) are explained in *Listening to your system* on page 36.

Listening to Surround Sound

This receiver was designed with the easiest possible setup in mind, so with the following quick setup guide, you should have your system hooked up for surround sound in no time at all. In most cases, you can simply leave the receiver in the default settings.

Be sure to complete all connections before connecting this unit to the AC power source.

1 Hook up your DVD player.

For surround sound, you'll want to hook up using a digital connection from the DVD player to the receiver. You can do this with either a coaxial, or an optical connection (you don't need to connect both). If you hook up using an optical cable, you should refer to *Digital input settings* on page 50 to assign the optical input to **DVD**.

Use a video cord to connect the video output on your DVD player to the receiver using the jacks shown below.

2 Hook up your TV.

Use a video cord to connect your receiver to the TV using the jacks as shown below.

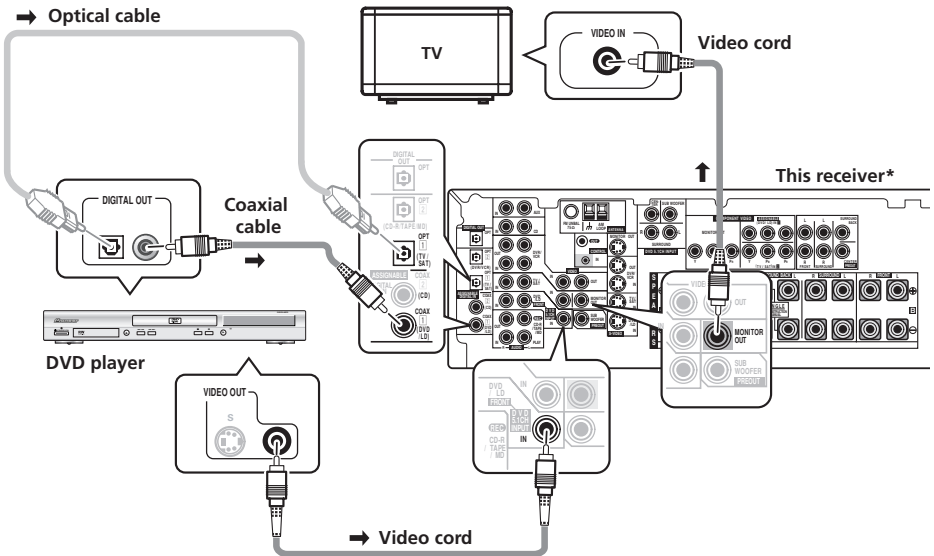

* The illustration shows the VSX-D814, but connections for the VSX-D514/D714 are the same.

3 Connect your speakers.

A complete setup of speakers is shown here (six speakers for the VSX-D514/D714, and eight for the VSX-D814), but different home setups may vary. Simply connect the speakers you have in the manner shown below. The receiver will work with just two stereo speakers (the front speakers in the diagram) but using at least three speakers is recommended, and a complete setup is best.

Make sure you connect the speaker on the right to the right terminal and the speaker on the left to the left terminal. Also make sure the positive and negative (+/-) terminals on the receiver match those on the speakers. You can use speakers with a nominal impedance between 6–16Ω (please see *Switching the speaker impedance* on page 72 if you plan to use speakers with an impedance of less than 8Ω).

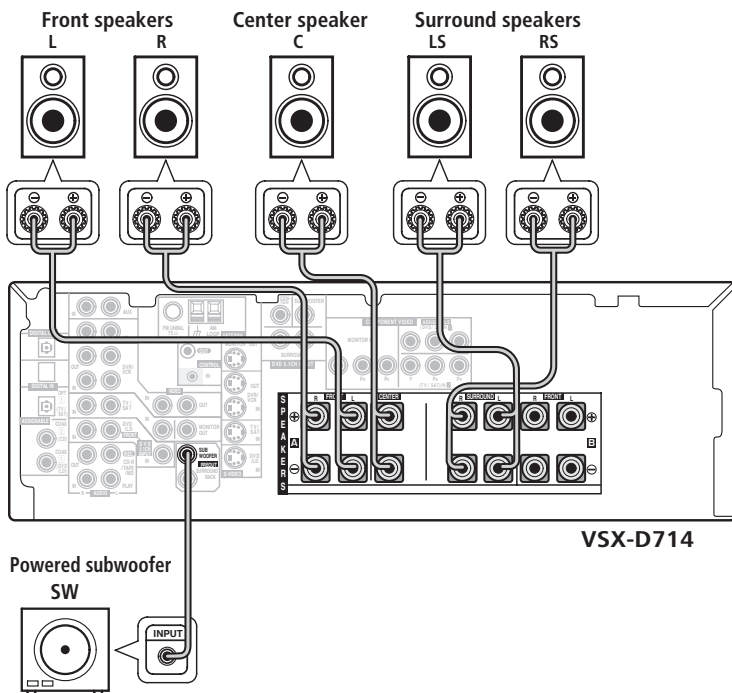

* The illustration shows the VSX-D714, but connections for the VSX-D514 are the same.

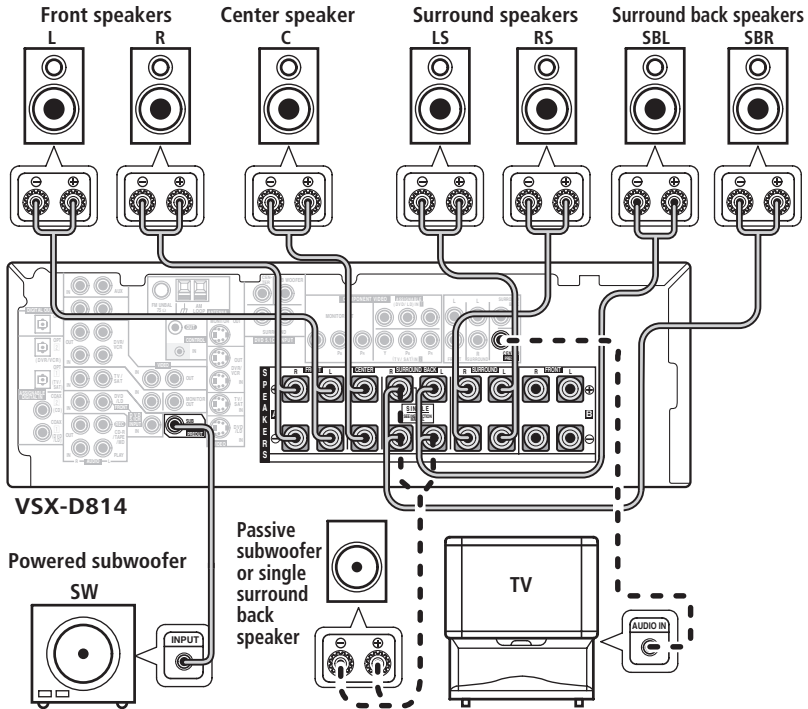

- If you're not using a subwoofer, change the front speaker setting (see *Speaker setting* on page 46) to large.

VSX-D814 only

- To use the speaker on your TV as the center speaker (C), connect the **CENTER PREOUT** jack on this unit to the audio input jack on your TV. In this case the center speaker shown is unnecessary.
- If you are using only one surround back speaker, connect the positive wire to the right channel (+) terminal, and the negative wire to the left channel (-) terminal (shown below).

- If you select subwoofer (**SB SW**) in the *Surround back speaker* setting on page 46 you can hook up a subwoofer instead of speakers to the surround back speaker terminals. Connect the wires just as above (and as shown below), connecting the positive wire to the right channel (+) terminal, and the negative wire to the left channel (–) terminal.

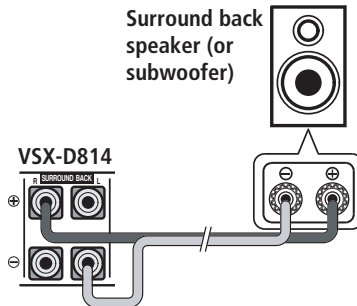

4 Plug in the receiver and switch it on, followed by your DVD player, your subwoofer and the TV.

Make sure you've set the video input on your TV to this receiver. Check the manual that came with the TV if you don't know how to do this.

Also make sure that **DVD/LD** is showing in the receiver's display, indicating that the DVD input is selected. If it isn't, press **DVD** on the remote control to set the receiver to the DVD input.

5 Press QUICK SETUP on the front panel to specify your speaker setup, room size and listening position.

Use the **MULTI JOG** dial to select and **ENTER** to confirm your selection. See *Using the Quick Setup* on page 12 if you're unsure about the settings.

6 Play a DVD, and adjust the volume to your liking.

There are several other sound options you can select. See *Listening to your system* on page 36 for more on this. See also *Choosing your receiver setup* on page 44 for more setup options.

Note

- Depending on your DVD player or source discs, you may only get digital 2 channel stereo and analog sound. In this case, the listening mode must be set to **STANDARD** (it should already be set—see *Listening in surround sound* on page 36 if you need to do this) if you want multichannel surround sound.

Using the Quick Setup

You can use the Quick Setup to get your system up and running with just a few button presses. The receiver automatically makes the necessary settings after you have selected your speaker setup, room size and listening position.

If you want to make more specific settings, refer to *Choosing your receiver setup* on page 44.

Use the front panel controls for the steps below.

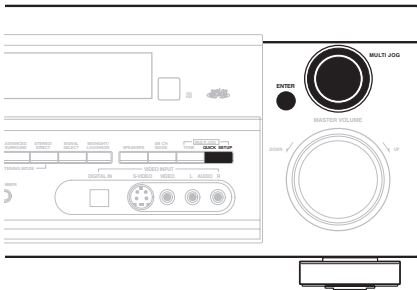

1 If the receiver is off, press **STANDBY/ON** to turn the power on.

2 Press **QUICK SETUP**.

VSX-D714/D814 only – **SW DET** flashes in the display while the receiver checks your setup for a subwoofer. **SW YES** or **SW NO** confirms the subwoofer check, then the display prompts you to select your speaker setup.

3 Use the **MULTI JOG** dial to choose your speaker setup.

VSX-D714/D814 – When a subwoofer was detected in step 2, you can cycle between the following choices:

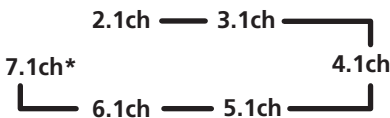

** VSX-D814 only*

If a subwoofer wasn't detected in step 2, you can cycle between the following choices:

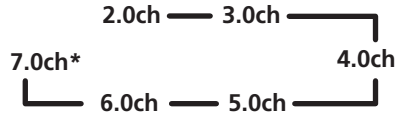

** VSX-D814 only*

VSX-D514 – Cycle between the following choices:

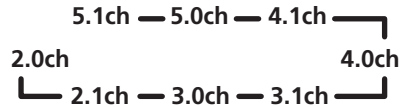

- Check the table below to find the speaker setup that corresponds with your system.

	Front Speakers	Center Speaker	Surround Speakers	Surround Back Sp.	Sub Woofer
2.0 ch	√				
2.1 ch	√				√
3.0 ch	√	√			
3.1 ch	√	√			√
4.0 ch	√		√		
4.1 ch	√		√		√
5.0 ch	√	√	√		
5.1 ch	√	√	√		√
6.0 ch*	√	√	√	(1 speaker)	
6.1 ch*	√	√	√	(1 speaker)	√
7.0 ch**	√	√	√	(2 speakers)	
7.1 ch**	√	√	√	(2 speakers)	√

** VSX-D714/D814 only*

*** VSX-D814 only*

4 Press ENTER.**5 Use the MULTI JOG dial to choose your room size.**

Depending on the distance of your speakers from the listening position, choose between small, medium, or large (**S**, **M** or **L**), **M** being an average-sized room.

6 Press ENTER.**7 Use the MULTI JOG dial to choose your listening position.**

You can cycle between the following choices:

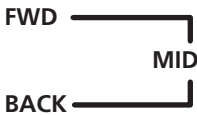

FWD – If you are nearer to the front speakers than the surround speakers

MID – If you are equal distance from the front and surround speakers

BACK – If you are nearer to the surround speakers than the front speakers

8 Press ENTER to confirm your setup.

The display shows the speaker setup, room size and listening position that you have selected.

Chapter 3: Connecting up



Important

- Before making or changing any connections, switch off the power and disconnect the power cord from the AC outlet.

Audio/Video cords

Use audio/video cords (not supplied) to connect the audio/video components and a video cord to connect the monitor TV.

Connect red plugs to R (right), white plugs to L (left), and the yellow plugs to **VIDEO**.

Be sure to insert completely.

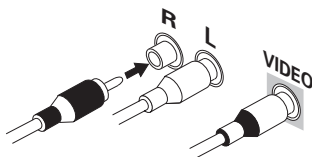

S-video cables

Use S-video cables (not supplied) to get clearer picture reproduction than regular video cords.

Connect from an S-video jack on the rear of the receiver to an S-video jack on the video component you are hooking up.

Be sure to insert completely.

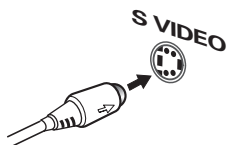

Component video cords

VSX-D714/D814 only

Use component video cords to get the best possible color reproduction of your video source. The color signal of the TV is divided into the luminance (**Y**) signal and the color (**PB** and **PR**) signals and then output. In this way, interference between the signals is avoided. Connect from the component video jacks on the rear of the receiver to the component video jacks on the video component you are hooking up.

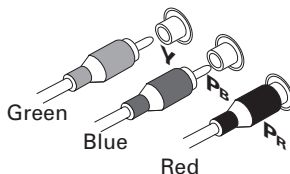

Digital audio coaxial cords/ Optical cables

Commercially available digital audio coaxial cords (standard video cords can also be used) or optical cables (not supplied) are used to connect digital components to this receiver.

Be sure to insert completely.

Digital audio coaxial cord (or standard video cord)

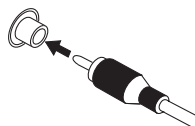

Optical cable

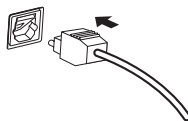

Connecting digital components

The easiest way to hook up this receiver for surround sound is to use a digital input. You can do this by either coaxial or optical connections (you do not need to do both). The quality of these two types of connections is the same but since some digital components only have one type of digital terminal, it is a matter of matching like with like (for example, the coaxial output from the component to coaxial input on the receiver).

The VSX-D514/D714 has three digital inputs on the rear panel (two coaxial inputs and an optical input) and the VSX-D814 has four (two coaxial inputs and two optical inputs). Connect your digital components to the rear panel as shown below.

- *VSX-D714/D814 only* – There is one digital output jack which is marked **DIGITAL OUT**. If you connect this to the optical input on a digital recorder (currently these include MD, DAT and CD-R) you can make direct digital recordings with this unit.

When connecting your equipment, always make sure the power is turned off and the power cord is disconnected from the AC outlet.

- The arrows indicate the direction of the digital audio signal.

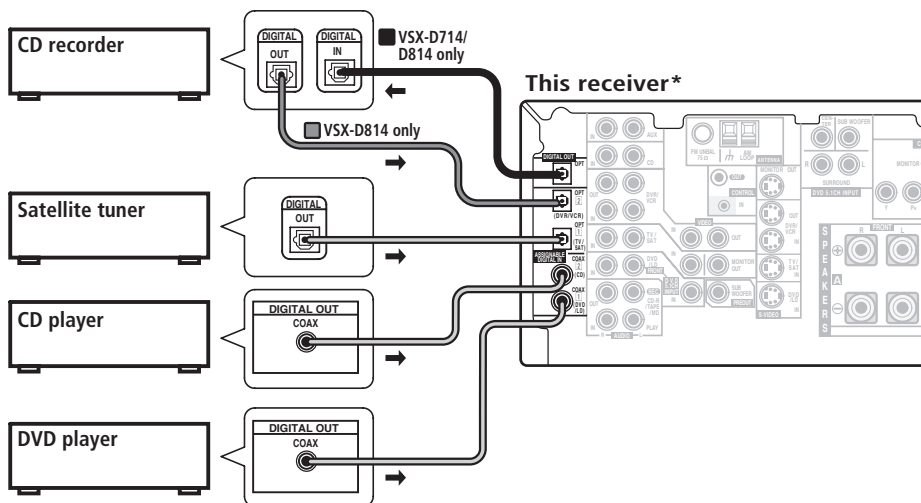

* The illustration shows the VSX-D814, but connections for the VSX-D514/D714 are the same.

**Note**

- If you have an LD player, you need to make special connections to ensure you can play **DD** RF format LDs on your system. If this is the case, hook up your DVD or LD player directly to an RF demodulator using both the **DD** RF output and either a coaxial or optical digital connection. We also recommend hooking up your digital components to analog audio jacks as well. Make sure the RF demodulator digital in switch is set correctly (optical or coaxial depending on the connection). See the component's instruction manual if you are unsure about its input and output jacks.

Connecting audio components

To begin set up, connect your analog audio components (such as a cassette deck) to the jacks. For components you want to record with, you need to hook up four plugs to the receiver (a set of stereo inputs and a set of stereo outputs), but for components that only play, you only need to hook up one set of stereo plugs. You must also hook up your digital components to analog audio jacks if you want to record to/from digital components (like an MD) to/from analog components. See page 15 for more on digital connections.

When connecting your equipment, always make sure the power is turned off and the power cord is disconnected from the AC outlet.

- The arrows indicate the direction of the audio signal.

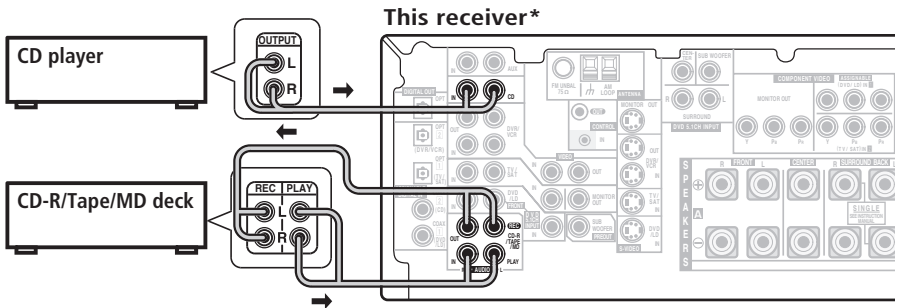

* The illustration shows the VSX-D814, but connections for the VSX-D514/D714 are the same.

Connecting DVD 5.1 channel components

If you prefer to use a separate component for decoding DVDs, you can connect a decoder or a DVD player with multichannel analog outputs to the multichannel inputs of this receiver.

When connecting your equipment, always make sure the power is turned off and the power cord is disconnected from the AC outlet.

- The arrows indicate the direction of the signal.

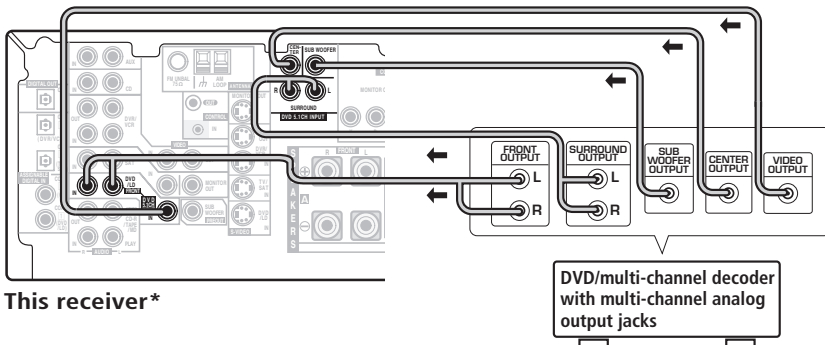

This receiver*

DVD/multi-channel decoder with multi-channel analog output jacks

* The illustration shows the VSX-D814, but connections for the VSX-D514/D714 are the same.

 **Note**

- The multichannel input can only be used when **DVD 5.1 ch** is selected (see page 42).

Connecting video components

Connect your video components to the jacks as shown below. With digital video components (like a DVD player), you must use the connections shown on this page for the video signal, but in order to hear a digital source (like a DVD) you should hook up the audio to a digital input (see page 15). It is also a good idea to hook up your digital components with analog audio connections (see page 16).

For better quality video, you can hook up using the component video jacks or the S-video jacks (quality descends in this order) on the rear of the receiver instead of the regular video jacks. Make sure they are connected to the video component using the same kind of connection.

When connecting your equipment, always make sure the power is turned off and the power cord is disconnected from the AC outlet.

- The arrows indicate the direction of the signal

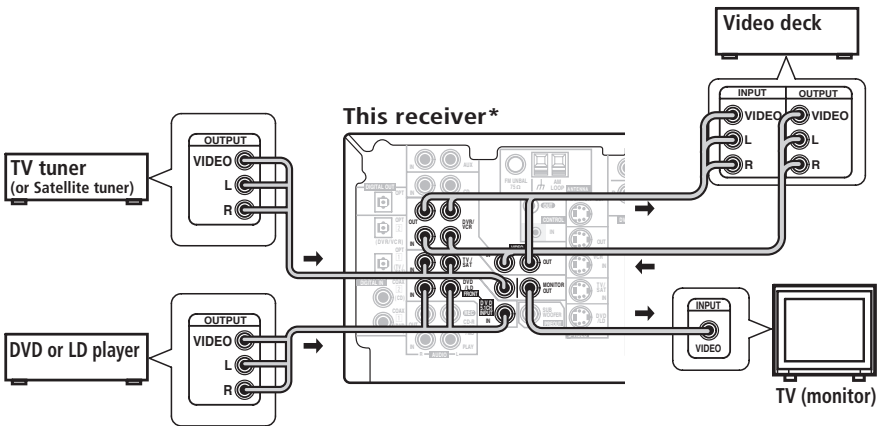

* The illustration shows the VSX-D814, but connections for the VSX-D514/D714 are the same.

Connecting to the front panel video terminal

VSX-D714/D814 only

Front video connections are accessed via the front panel using the **VIDEO** button. There are standard audio/video jacks as well as an S-video jack (the VSX-D814 also has an optical input). Hook them up the same way you made the rear panel connections.

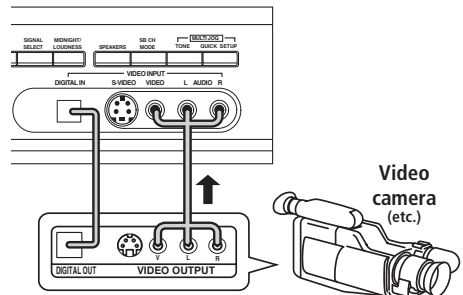

Connecting antennas

Connect the AM loop antenna and the FM wire antenna as shown below. To improve reception and sound quality, connect external antennas (see *Using external antennas* below). Always make sure that the receiver is switched off and unplugged from the wall outlet before making or changing any connections.

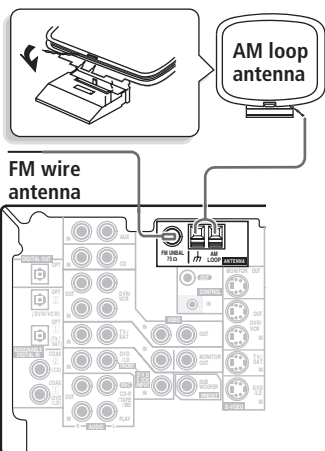

FM wire antenna

Connect the FM wire antenna and fully extend vertically along a window frame or another suitable place that gives good reception.

AM loop antenna

Assemble the antenna and connect to the receiver. Attach (if necessary) and face in the direction that gives the best reception.

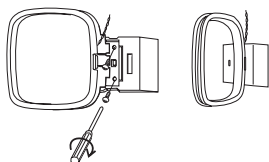

Antenna snap connectors

Twist the exposed wire strands together and insert into the hole, then snap the connector shut.

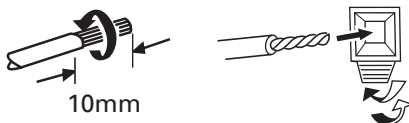

Using external antennas

To improve FM reception

Connect an external FM antenna.

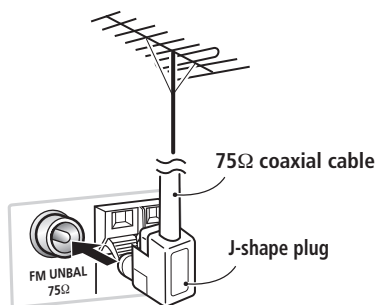

To improve AM reception

Connect a 5–6 metre length of vinyl-coated wire to the AM antenna terminal without disconnecting the supplied AM loop antenna.

For the best possible reception, suspend horizontally outdoors.

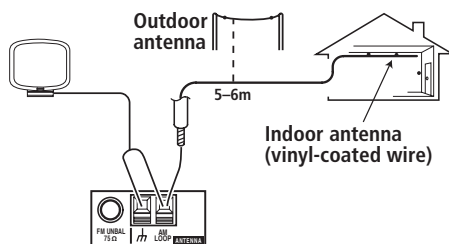

Connecting the speakers (VSX-D514/D714)

A complete setup of six speakers (including the subwoofer) is shown below, but everyone's home setup will vary. Simply connect the speakers you have in the manner shown below. The receiver will work with just two stereo speakers (the front speakers in the diagram) but using at least three speakers is recommended, and a complete setup is best. If you're not using a subwoofer, change the front speaker setting (see *Speaker setting* on page 46) to large.

Make sure you connect the speaker on the right to the right terminal and the speaker on the left to the left terminal. Also make sure the positive and negative (+/-) terminals on the receiver match those on the speakers. You can use speakers with a nominal impedance between 6–16 Ω (please see *Switching the speaker impedance* on page 72 if you plan to use speakers with an impedance of less than 8 Ω).

Be sure to complete all connections before connecting this unit to the AC power source.

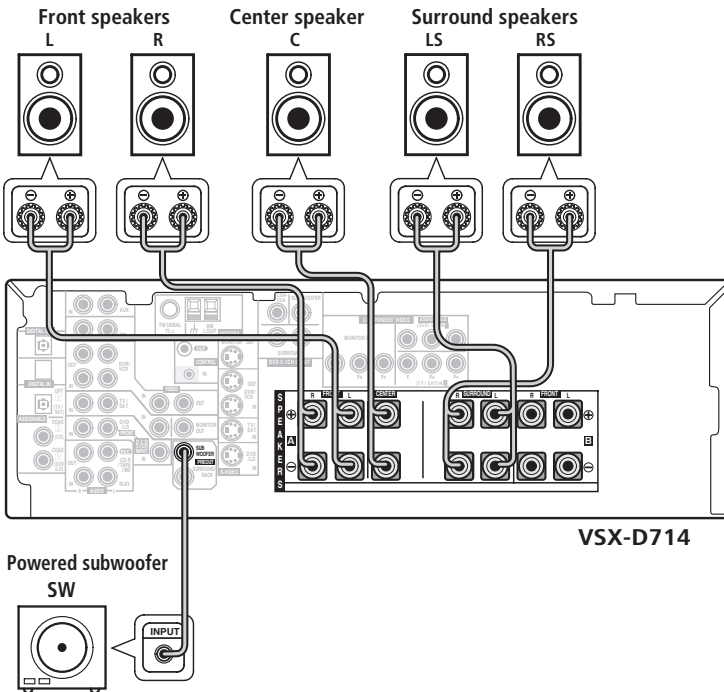

* The illustration shows the VSX-D714, but connections for the VSX-D514 are the same.

Connecting the speakers (VSX-D814)

A complete setup of eight speakers (including the subwoofer) is shown below, but everyone's home setup will vary. Simply connect the speakers you have in the manner shown below. The receiver will work with just two stereo speakers (the front speakers in the diagram) but using at least three speakers is recommended, and a complete setup is best for surround sound. If you're not using a subwoofer, change the front speaker setting (see *Speaker setting* on page 46) to large.

Make sure you connect the speaker on the right to the right terminal and the speaker on the left to the left terminal. Also make sure the positive and negative (+/-) terminals on the receiver match those on the speakers. You can use speakers with a nominal impedance between 6–16Ω (please see *Switching the speaker impedance* on page 72 if you plan to use speakers with an impedance of less than 8Ω).

Be sure to complete all connections before connecting this unit to the AC power source.

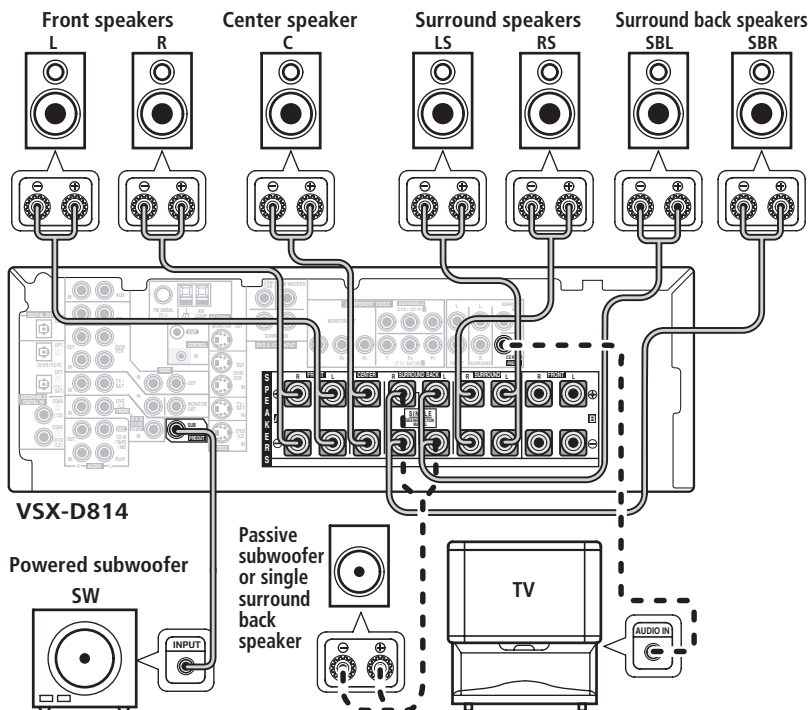

**Note**

- When using the speaker on your TV as the center speaker (**C**), connect the **CENTER PREOUT** jack on this unit to the audio input jack on your TV. In this case the center speaker shown is unnecessary.
- If you are using only one surround back speaker, connect the positive wire to the right channel (**+**) terminal, and the negative wire to the left channel (**-**) terminal (see illustration on page 11).
- If you select subwoofer (**SB SW**) in the *Surround back speaker setting* on page 46 you can hook up a subwoofer instead of speakers to the surround back speaker terminals. Connect the positive wire to the right channel (**+**) terminal, and the negative wire to the left channel (**-**) terminal (see illustration on page 11).

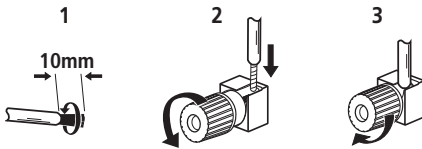
Speaker terminals**1 Twist exposed wire strands together.****2 Loosen speaker terminal and insert exposed wire.**

Make sure that all the bare speaker wire is twisted together and inserted fully into the speaker terminal. If any of the bare speaker wire is touching the back panel when you switch the unit on, the power may cut off as a safety measure. Use good quality speaker wire to connect the speakers to the receiver.

3 Tighten terminal.**A and B speaker systems**

VSX-D714/D814 only

The receiver has two speaker systems: A and B. A is the main system supporting the full speaker setup. If you switch on both A and B speaker systems, only the front speakers and the (active) subwoofer will be audible. No sound will come from the center, surround, or surround back speakers, but multichannel sources will be down-mixed to the active speakers so no sound will be lost. Similarly, if you choose just the B system you'll only hear the front speakers connected to the B system and multi channel sources will be down-mixed to these two speakers.

- **Press the SPEAKERS button on the front panel to switch between speaker systems (A, B or both).**

Hints on speaker placement

Speakers are usually designed with a particular placement in mind. Some are designed to be floorstanding, while others should be placed on stands to sound their best. Some should be placed near a wall; others should be placed away from walls. We have provided a few tips on getting the best sound from your speakers (following), but you should also follow the guidelines on placement that the speaker manufacturer provided with your particular speakers to get the most out of them.

- Place the front left and right speakers at equal distances from the TV.
- When placing speakers near the TV, we recommend using magnetically shielded speakers to prevent possible interference, such as discoloration of the picture when the TV is switched on. If you do not have magnetically shielded speakers and notice discoloration of the TV picture, move the speakers farther away from the TV.

- Place the center speaker above or below the TV so that the sound of the center channel is localized at the TV screen.
- If possible, place the surround speakers slightly above ear level.
- Try not to place the surround speakers further away from the listening position than the front and center speakers. Doing so can weaken the surround sound effect.
- To achieve the best possible surround sound, install your speakers as shown below. Be sure all speakers are installed securely to prevent accidents and improve sound quality.



Caution

- If you choose to install the center speaker on top of the TV, be sure to secure it with putty, or by other suitable means, to reduce the risk of damage or injury resulting from the speaker falling from the TV in the event of external shocks such as earthquakes.
- Make sure no exposed speaker wire is touching the rear panel, this may cause the receiver to turn off automatically.

Speaker placement diagrams

The following illustrations show 6.1 and 7.1 channel speaker setups.



Note

- *VSX-D514 only* – Follow the speaker placement diagrams below, disregarding the surround back speakers.
- *VSX-D714 only* – See *Connecting additional amplifiers* on page 24 for more on connecting a surround back speaker.

Overhead view of speaker setup

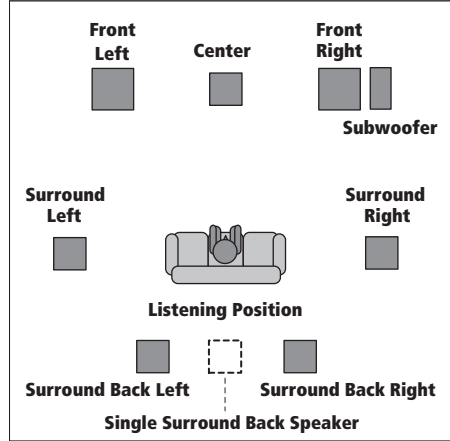

3-D view of 6.1 channel speaker setup



3-D view of 7.1 channel speaker setup



Connecting additional amplifiers

VSX-D714/D814 only

This receiver has more than sufficient power for any home use, however it is possible to add additional amplifiers to every channel on the VSX-D814 or the surround back channel of the VSX-D714. Make the connections shown below to add amplifiers to power your speakers. Always make sure that the receiver is switched off and unplugged from the wall outlet before making or changing any connections.

- The arrows indicate the direction of the audio signal.

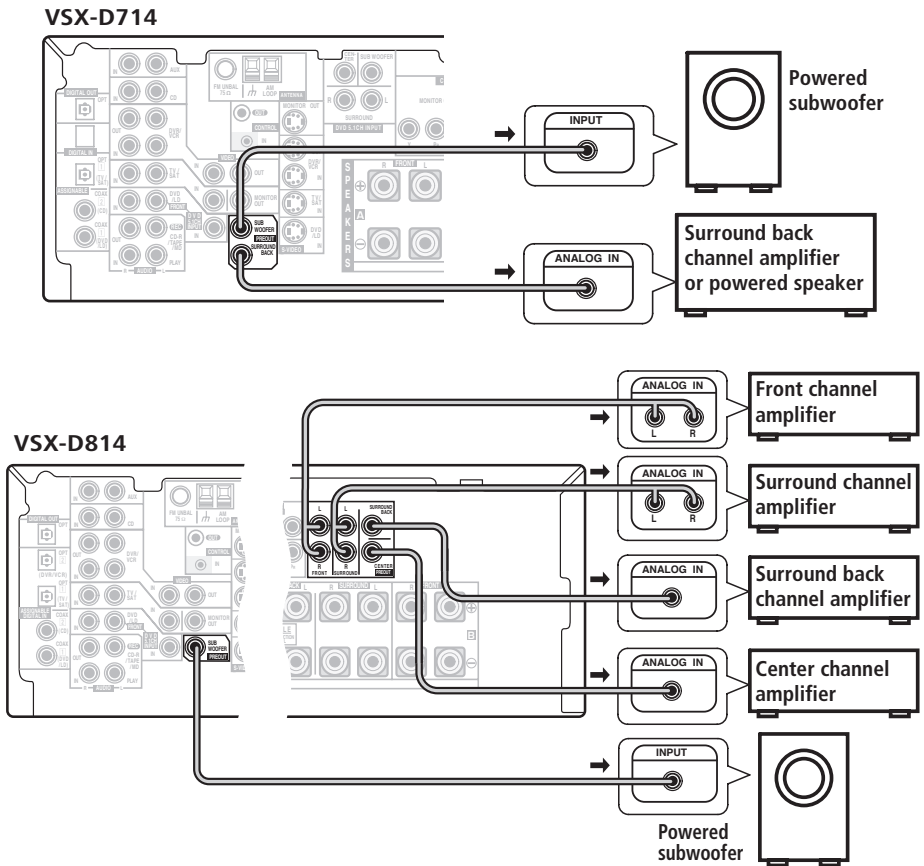

Note

- To hear sound only from the pre-outs, disconnect any speakers that are connected directly to the receiver.
- If you're not using a subwoofer, change the front speaker setting (see *Speaker setting* on page 46) to large.
- *VSX-D714 only* – If you connect to a surround back speaker, make sure the *Surround back speaker setting* on page 46 is switched on and set to the proper speaker size.

Caution

- These speaker terminals are hazardous when live. To prevent the risk of electric shock when connecting or disconnecting the speaker cables, disconnect the power cord.

Power cord caution

Handle the power cord by the plug. Do not pull out the plug by tugging the cord and never touch the power cord when your hands are wet as this could cause a short circuit or an electric shock. Do not place the unit, a piece of furniture, etc., on the power cord, or pinch the cord. Never make a knot in the cord or tie it with other cords. The power cords should be routed such that they are not likely to be stepped on. A damaged power cord can cause a fire or give you an electrical shock. Check the power cord once in a while. When you find it damaged, ask your nearest Pioneer authorized service center or your dealer for a replacement.

Operating other Pioneer components

VSX-D714/D814 only

By connecting a control cord (optional), you can point the remote controls of other Pioneer components at the receiver's remote sensor. The remote control signals are received by the remote sensor of this unit, and sent to the other devices via the **CONTROL OUT** terminal of the receiver.

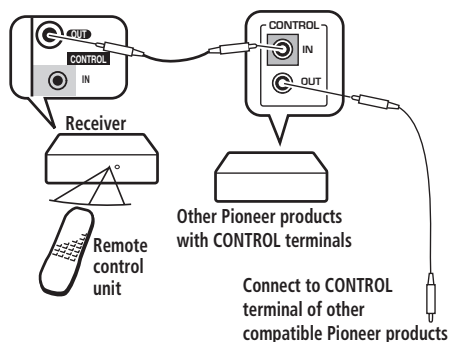

Using this receiver with a Pioneer plasma display

VSX-D714/D814 only

If you have a Pioneer plasma display (models PDP-504HDG and PDP-434HDG), you can use an SR+ cable (see note below) to connect it to this unit and take advantage of various convenient features, such as automatic video input switching of the plasma display when the input is changed.

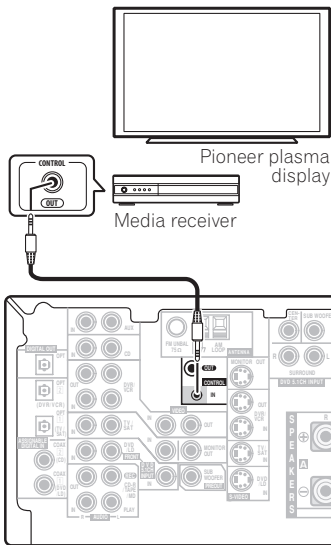

* The illustration shows the VSX-D814, but connections for the VSX-D714 are the same.



Important

- If you connect to a Pioneer plasma display using an SR+ cable, you will need to point the remote control at the plasma display remote sensor to control the receiver. In this case, you won't be able to control the receiver using the remote control if you switch the plasma display off.

- Use a 3-ringed miniplug SR+ cable to connect the CONTROL IN jack of this receiver with the CONTROL OUT of your plasma display.

Before you can use the extra SR+ features, you need to make a few settings in the receiver. See *Using the SR+ mode with a Pioneer plasma display* on page 54 for detailed instructions.

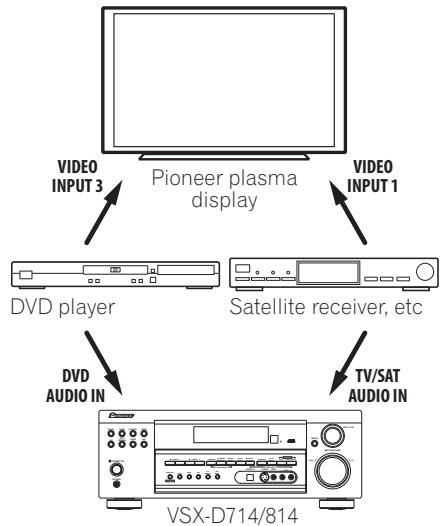

To make the most of the SR+ features, you should connect your source components (DVD player, etc.) in a slightly different way to that described in this chapter. For each component, connect the video output directly to the plasma display, and just connect the audio (analog and/or digital) to this receiver.



Note

- The 3-ringed miniplug SR+ cable from Pioneer is commercially available under the part number ADE7095. Contact the Pioneer Customer Support division for more information on obtaining an SR+ cable.

Chapter 4:

Controls and displays

Front panel (VSX-D514)

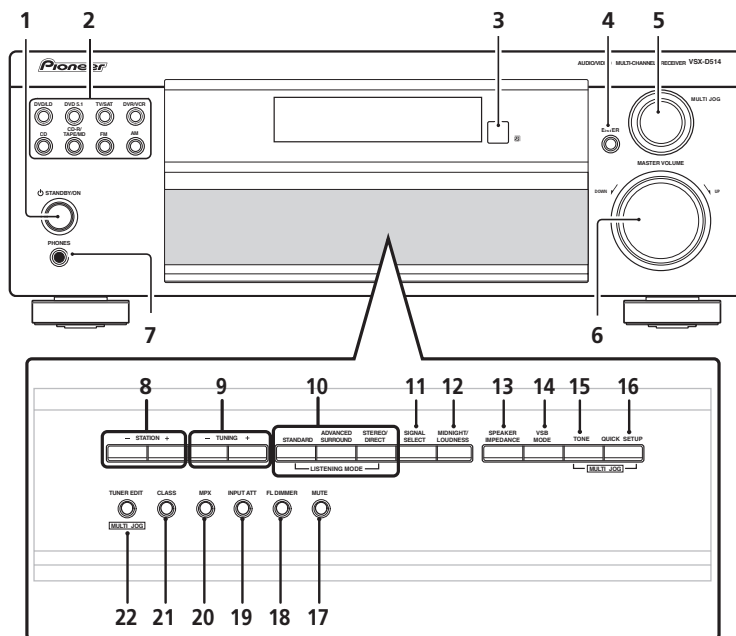

1 **STANDBY/ON**

Switches the receiver between on and standby.

2 **Input select buttons**

Press to select an input source.

3 **Remote sensor**

Receives the signals from the remote control.

4 **ENTER**

5 **MULTI JOG dial**

The **MULTI JOG** dial performs a number of tasks. Use it to select options after pressing **TONE**, **QUICK SETUP** or **TUNER EDIT**.

6 **MASTER VOLUME**

7 **PHONES jack**

Use to connect headphones. When the headphones are connected, there is no sound output from the speakers.

8 STATION +/- buttons

Selects station presets when using the tuner (page 58).

9 TUNING +/- buttons

Selects the frequency when using the tuner (page 56).

10 LISTENING MODE buttons**STANDARD**

Press for Standard decoding and to switch between the various Pro Logic II and (VSX-D714/D814 only) Neo:6 options (page 36).

ADVANCED SURROUND

Use to switch between the various surround modes (page 37).

STEREO/DIRECT

Switches between direct and stereo playback. Direct playback bypasses the tone controls and channel levels for the most accurate reproduction of a source (page 38).

11 SIGNAL SELECT

Use to select an input signal (page 38).

12 MIDNIGHT/LOUDNESS

Use Midnight when listening to movie soundtracks at low volume. Use Loudness to boost the bass and treble at low volume (page 41).

13 SPEAKER IMPEDANCE

Use to change the impedance setting (page 72)

14 VSB MODE

Selects the Virtual Surround Back (VSB) mode (page 40).

15 TONE

Press this button to access the bass and treble controls, which you can then adjust with the **MULTI JOG** dial (page 41).

16 QUICK SETUP

See *Using the Quick Setup* on page 12.

17 MUTE

Mutes the sound (or restores the sound if it has been muted).

18 FL DIMMER

Dims or brightens the display.

19 INPUT ATT

Attenuates (lowers) the level of an analog input signal to prevent distortion.

20 MPX

Press to receive a radio broadcast in mono (page 56).

21 CLASS

Switches between the three banks (classes) of station presets (page 57).

22 TUNER EDIT

Press to memorize and name a station for recall (page 57).

Front panel (VSX-D714/D814)

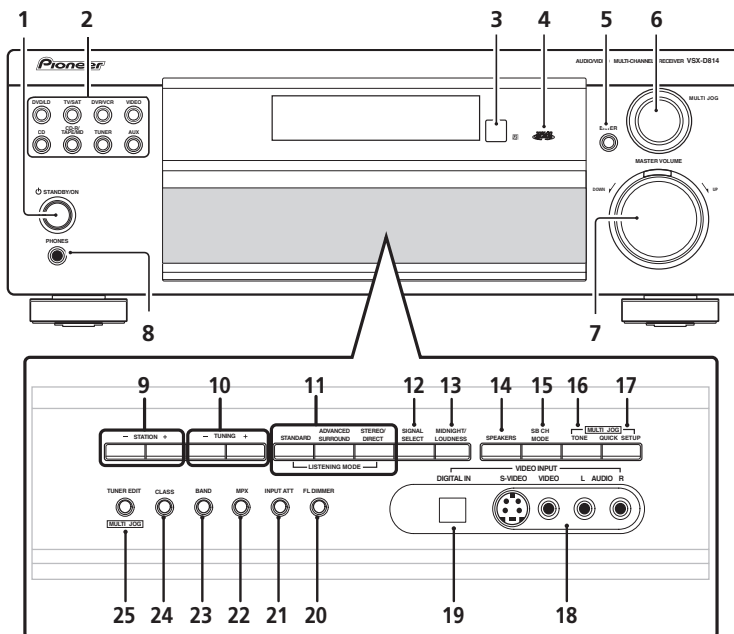

1 **STANDBY/ON**

Switches the receiver between on and standby.

2 **Input select buttons**

Press to select an input source.

3 **Remote sensor**

Receives the signals from the remote control.

4 **MCACC indicator**

Lights after the MCACC setup is complete (page 52).

5 **ENTER**

6 **MULTI JOG dial**

The **MULTI JOG** dial performs a number of tasks. Use it to select options after pressing **tone**, **QUICK SETUP** or **TUNER EDIT**.

7 **MASTER VOLUME**

8 **PHONES jack**

Use to connect headphones. When the headphones are connected, there is no sound output from the speakers.

9 **STATION +/- buttons**

Selects station presets when using the tuner (page 58).

10 **TUNING +/- buttons**

Selects the frequency when using the tuner (page 56).

11 LISTENING MODE buttons**STANDARD**

Press for Standard decoding and to switch between the various Pro Logic II and (VSX-D714/D814 only) Neo:6 options (page 36).

ADVANCED SURROUND

Use to switch between the various surround modes (page 37).

STEREO/DIRECT

Switches between direct and stereo playback. Direct playback bypasses the tone controls and channel levels for the most accurate reproduction of a source (page 38).

12 SIGNAL SELECT

Use to select an input signal (page 38).

13 MIDNIGHT/LOUDNESS

Use Midnight when listening to movie soundtracks at low volume. Use Loudness to boost the bass and treble at low volume (page 41).

14 SPEAKERS

Use to cycle through the speaker system:
A → B → A+B (page 22)

15 SB CH MODE

Selects the Surround back channel mode (page 39) and the Virtual Surround Back (VSB) mode (page 40).

16 TONE

Press this button to access the bass and treble controls, which you can then adjust with the **MULTI JOG** dial (page 41).

17 QUICK SETUP

See *Using the Quick Setup* on page 12.

18 VIDEO INPUT

See *Connecting to the front panel video terminal* on page 18.

19 DIGITAL IN

VSX-D814 only

See *Connecting to the front panel video terminal* on page 18.

20 FL DIMMER

Dims or brightens the display.

21 INPUT ATT

Attenuates (lowers) the level of an analog input signal to prevent distortion.

22 MPX

Press to receive a radio broadcast in mono (page 56).

23 BAND

Switches between AM and FM radio bands (page 56).

24 CLASS

Switches between the three banks (classes) of station presets (page 57).

25 TUNER EDIT

Press to memorize and name a station for recall (page 57).

Display

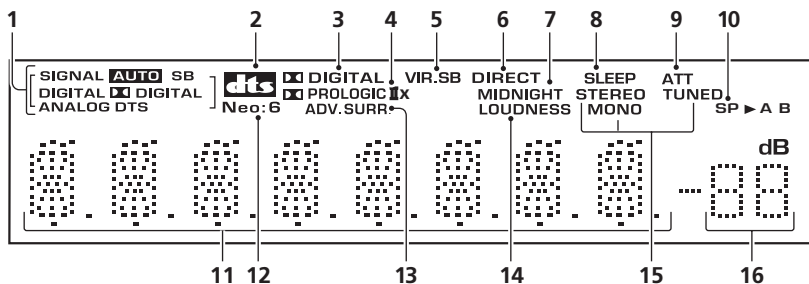

1 SIGNAL SELECT indicators

Lights to indicate the type of input signal assigned for the current component:

AUTO

Lights when **AUTO** signal select is on.

SB

Depending on the source, this lights when a signal with surround back channel encoding is detected.

DIGITAL

Lights when a digital audio signal is detected.

DIGITAL

Lights when a Dolby Digital encoded signal is detected.

ANALOG

Lights when an analog signal is detected.

DTS

Lights when a source with DTS encoded audio signals is detected.

2

When the **STANDARD** mode of the receiver is on, this lights to indicate decoding of a DTS signal.

3 DIGITAL

When the **STANDARD** mode of the receiver is on, this lights to indicate decoding of a Dolby Digital signal.

4 PRO LOGIC II (x)

When the (**STANDARD**) Pro Logic II mode of the receiver is on, this lights to indicate Pro Logic II decoding.

V SX-D714/D814 only – The **x** lights to indicate Pro Logic IIx decoding (see *Listening in surround sound* on page 36 for more on this).

5 VIR.SB

Lights during Virtual surround back processing.

6 DIRECT

Lights when source direct playback is in use. Direct playback bypasses the tone controls and channel levels for the most accurate reproduction of a source.

7 MIDNIGHT

Lights during Midnight listening.

8 SLEEP

Lights when the receiver is in sleep mode.

9 ATT

Lights when **INPUT ATT** is used to attenuate (reduce) the level of the analog input signal.

10 Speaker indicator*VSX-D714/D814 only*

Shows the speaker system currently in use.

11 Character display**12 Neo:6***VSX-D714/D814 only*When the (**STANDARD**) NEO:6 mode of the receiver is on, this lights to indicate NEO:6 processing.**13 ADV.SURR. (Advanced Surround)**

Lights when one of the Advanced Surround modes has been selected.

14 LOUDNESSLights when **LOUDNESS** has been selected.**15 TUNER indicators****STEREO**

Lights when a stereo FM broadcast is being received in auto stereo mode.

MONOLights when the mono mode is set using the **MPX** button.**TUNED**

Lights when a broadcast is being received.

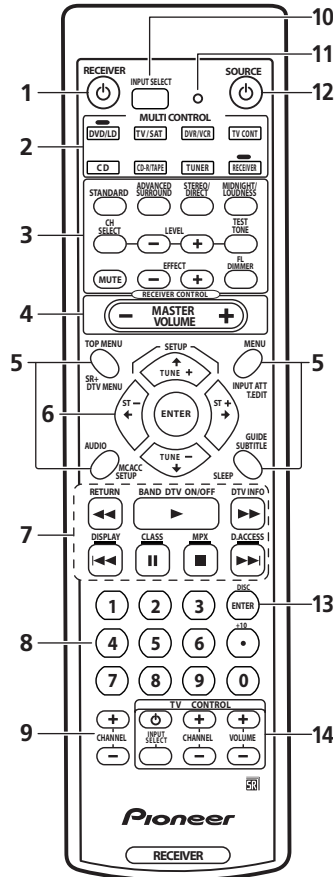
16 Master volume levelShows the overall volume level. **---dB** indicates the minimum level, and **- 0 dB** indicates the maximum level.Depending on your level settings for each channel, the maximum volume can range between **-10 dB** and **-0 dB**.**Remote control***Illustration shows the VSX-D714/D814 remote control***1 RECEIVER**

This switches between standby and on for this receiver.

2 MULTI CONTROL buttonsPress to select control of other components (see *Controlling the rest of your system* on page 60).

RECEIVER

Switches the remote to control the receiver (used to select the features such as **SLEEP**, **MCACC SETUP**, etc). Also use this button to set up surround sound (page 44, page 52).

3 RECEIVER CONTROL buttons

STANDARD

Press for Standard decoding and to switch between the various Pro Logic II and (*VSX-D714/D814 only*) Neo:6 options (page 36).

ADVANCED SURROUND

Use to switch between the various surround modes (page 37).

STEREO/DIRECT

Switches between direct and stereo playback. Direct playback bypasses the tone controls and channel levels for the most accurate reproduction of a source (page 38).

MIDNIGHT/LOUDNESS

Switches to Midnight or Loudness listening (page 41).

CH SELECT

Selects a speaker when setting up the surround sound of the receiver (page 53).

LEVEL +/-

Adjusts the levels of the surround sound of the receiver (page 53).

TEST TONE

Sounds the test tone when setting up the surround sound of the receiver (page 53).

MUTE

Mutes the sound (or restores the sound if it has been muted).

EFFECT +/-

Adds or subtracts the amount of effect with different advanced surround modes (page 37).

FL DIMMER

Dims or brightens the display.

4 MASTER VOLUME +/-

Use to set the listening volume.

5 Receiver and component control buttons *(Press the corresponding MULTI CONTROL button first to access).*

These controls function according to the component you've selected.

TOP MENU

Displays the disc 'top' menu of a DVD.

SR+

VSX-D714/D814 only

Switches the SR+ mode on/off (page 54).

DTV MENU

Displays menus on a digital TV.

AUDIO

Changes the audio language or channel with DVD discs.

MCACC SETUP

VSX-D714/D814 only

Use to setup your speaker system using the multichannel acoustic calibration system (page 52).

MENU

Displays the disc menu of DVD-Video discs. It also displays TV menus.

INPUT ATT

Attenuates (lowers) the level of an analog input signal to prevent distortion.

T.EDIT

Use to memorize and name a station for recall using the **STATION +/-** buttons (page 57).

GUIDE

Displays the guides on a digital TV.

SUBTITLE

Displays/changes the subtitles included in multilingual DVD-Video discs.

SLEEP

Use to put the receiver in sleep mode and select the amount of time before the receiver turns off.

- 6** ⇐⇒⇩⇧ (**TUNE +/-, ST +/-**) /**ENTER**
Use the arrow buttons when setting up your surround sound system (see page 44). Also used to control DVD menus/options and for deck 1 of a double cassette deck player. Use the **TUNE +/-** buttons to find radio frequencies and use **ST +/-** to find preset stations (page 58).

7 Component/Tuner control buttons

The main buttons (▶, ■, etc.) are used to control a component after you have selected it using the **MULTI CONTROL** buttons. The tuner/DTV controls above these buttons can be accessed after you have selected the corresponding **MULTI CONTROL** button (**TUNER** or **TV/SAT** (when connected to DTV)).

RETURN

Returns to the last screen selected when using a digital TV tuner.

BAND DTV ON/OFF

Switches between the tuner AM and FM bands (page 56). Also switches a digital TV on/off.

DTV INFO

Use to bring up information screens on a digital TV.

DISPLAY

Use to switch the display between the station preset name and the frequency for the tuner.

CLASS

Switches between the three banks (classes) of radio station presets (page 57).

MPX

Switches between stereo and mono reception of FM broadcasts. If the signal is weak then switching to mono will improve the sound quality (page 56).

D.ACCESS

After pressing, you can access a radio station directly using the number buttons (page 56).

8 Number buttons

Use the number buttons to directly select a radio frequency (page 56) or the tracks on a CD, DVD, etc.

9 CHANNEL +/-

Use to select channels when using a VCR, DVR, etc.

10 INPUT SELECT

Use to select the input source.

11 LED

This lights when a command is sent from the remote control.

12 SOURCE

Press to turn on/off other components connected to the receiver.

13 DISC (ENTER)

The button's use depends on the component selected. It can be used to enter commands for TV or DTV, and can also be used to select a disc in a multi-CD player.

14 TV CONTROL buttons

These buttons are dedicated to control the TV assigned to the **TV CONT** button. Thus if you only have one TV to hook up to this system assign it to the **TV CONT MULTI CONTROL** button. If you have two TVs, assign the main TV to the **TV CONT** button.



Use to turn on/off the power of the TV.

(TV CONTROL) INPUT SELECT

Use select the TV function.

CHANNEL +/-

Use to select channels.

VOLUME +/-

Use to adjust the volume on your TV.

Chapter 5:

Listening to your system

Listening in surround sound

Using this receiver, you can listen to any source in surround sound. However, the options available will depend on your speaker setup and the type of source you're listening to.

If you connected surround back speakers, see also *Using the Surround Back Channel (SB CH)* on page 39.

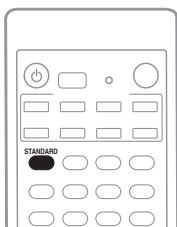

- While listening to a source, press **STANDARD**.

If the source is Dolby Digital, DTS, or Dolby Surround encoded, the proper decoding format will automatically be selected and shows in the display.

With two channel sources, press **STANDARD** repeatedly to select from:

VSX-D514 only:

- **Pro Logic II MOVIE** – Up to 5.1 channel sound, especially suited to movie sources
- **Pro Logic II MUSIC** – Up to 5.1 channel sound, especially suited to music sources
- **PRO LOGIC** – 5.1 channel surround sound

VSX-D714/D814 only:

- **Pro Logic IIx MOVIE** – Up to 6.1 channel sound, especially suited to movie sources
- **Pro Logic IIx MUSIC** – Up to 6.1 channel sound, especially suited to music sources
- **PRO LOGIC** – 5.1 channel surround sound
- **NEO:6 CINEMA** – 6.1 channel sound, especially suited to movie sources
- **NEO:6 MUSIC** – 6.1 channel sound, especially suited to music sources



Note

- You can't use the **STANDARD** mode with 96kHz PCM or (*VSX-D714/D814 only*) DTS 96kHz/24-bit stereo sources.
- *VSX-D714/D814 only* – During playback of a Dolby Digital multichannel source with the **SB CH MODE** switched **ON**, you will only be able to select **DOLBY EX** or **Pro Logic IIx MUSIC**. See *Using the Surround Back Channel (SB CH)* on page 39 for more on this.

Using the Advanced surround effects

The Advanced surround effects can be used for a variety of additional surround sound effects. Most Advanced Surround modes are designed to be used with film soundtracks, but some modes are also suited for music sources. Try different settings with various soundtracks to see which you like.

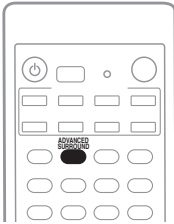

- **Press ADVANCED SURROUND repeatedly to select a listening mode.**
- **ADV. MOVIE** – Simulates the relaxed environment of a movie theater, and is suitable for watching movies.
- **ADV. MUSIC** – Simulates the acoustic environment of a large concert hall and is suitable for music or musical sources.
- **TV SURR.** – This mode produces surround sound for both mono and stereo TV sources. It is useful for older movies recorded with mono soundtracks.
- **SPORTS** – This is designed for sports programs with a lot of action, adding to the excitement by bringing background action to the forefront.
- **GAME** – Useful when playing video games. It works especially well with sound moving from left to right in game software with a lot of movement.
- **EXPANDED** – This mode is especially designed to give sound depth to stereo sources, and lets you hear two-channel (stereo) signals as simulated multi-channel surround sound. Use with Dolby

Pro Logic for a stereo surround effect. You can also use with Dolby Digital sources for a wider stereo field than the Standard modes.

- **5-STEREO (VSX-D514) / 6-STEREO (VSX-D714/D814)** – This can be selected to give multichannel sound to a stereo source, using all of the speakers in your setup.
- **PHONES SURROUND** – When listening through headphones, you can still get the effect of overall surround.



Note

- Depending on the source and the sound mode you have selected, you may not get sound from the surround back speakers in your setup. For more on this, refer to *Using the Surround Back Channel (SB CH)* on page 39.
- If you press **ADVANCED SURROUND** when the headphones are connected, the **PHONES SURROUND** mode will automatically be selected.
- You can't use the Advanced Surround listening modes with 96kHz PCM or (VSX-D714/D814 only) DTS 96kHz/24 bit sources.



Tip

- The Advanced Surround effects can be adjusted in the range of **10** to **90** by pressing **EFFECT +/-**. The effect level can be set for each Advanced Surround mode. The Standard mode cannot be changed.

Using the Surround Back Channel (SB CH)

(VSX-D714/D814 only)

- Default setting: **SB ON** (VSX-D814), **SB OFF** (VSX-D714)

You can use automatic 6.1 decoding for 6.1 encoded sources (for example, Dolby Digital EX or DTS-ES), or you can choose to always use 6.1 decoding with other sources (for example, 5.1 encoded material). With 5.1 encoded sources, a surround back channel will be generated, but the material may sound better in the 5.1 format for which it was originally encoded, in which case you can simply switch the surround back channel off. The table below indicates when you will hear the surround back channel.

- **Press SB CH MODE (front panel) to select a surround back channel option.**

Each press cycles through the options as follows:

- **SB CH AUTO** – Automatically switches to 6.1 decoding for 6.1 encoded sources (for example, Dolby Digital EX or DTS-ES)
- **SB CH ON** – 6.1 encoding is always used (for example, on 5.1 encoded material)
- **SB CH OFF** – Surround back channel is switched off



Note

- You can't use the surround back channel with headphones, the **STEREO / DIRECT** mode, or if the *Surround back speaker setting* on page 46 is set to **SB ✕** or (VSX-D814 only) **SB SW**.
- You can't hear the surround back channel with DTS 96kHz/24 bit sources.

Type of source	SB CH MODE	STANDARD			ADVANCED SURROUND
		STANDARD decoding	PRO LOGIC IIx MOVIE/MUSIC	NEO:6 CINEMA/ NEO:6 MUSIC	All modes
DTS-ES/Dolby Digital Matrix encoded multi-channel sources with 6.1 surround	ON	√			√
	AUTO	√			√
Dolby Digital/DTS encoded multi-channel sources	ON	√	√ (Dolby Digital)		√
	AUTO				√
Dolby Digital/DTS encoded stereo sources, Stereo sources	ON		√	√	√
	AUTO		√	√	√
Analog 2-channel (stereo) source	ON		√	√	√
	AUTO		√	√	√

Using the Virtual Surround Back mode (VSB)

Selecting this mode allows you to hear a virtual back channel through your surround speakers. For example, you can choose to listen to sources with no surround back channel information (for example, 5.1 encoded material) with emulated 6.1 encoding (**VSB ON**). Sometimes the material may sound better in the 5.1 format for which it was originally encoded. In this case you can simply switch it off (**VSB OFF**) or (*VSX-D714/D814 only*) have the receiver only apply this effect to 6.1 encoded sources like Dolby Digital EX or DTS-ES (**VSB AUTO**).

The table indicates when you will hear the virtual surround back channel.

- **Press SB CH MODE / VSB MODE (front panel) to select a virtual surround back channel option.**

Each press cycles through the options as follows:

- **VSB AUTO** (*VSX-D714/D814 only*)
- **VSB ON**
- **VSB OFF**



Note

- You can't use the Virtual Surround Back mode with headphones, the **STEREO / DIRECT** mode, or if the *Speaker setting* on page 46 is set to **S***.

VSX-D714/D814 only

- You can only use the Virtual Surround Back mode if the surround speakers are on and the *Surround back speaker setting* on page 46 is set to **SB *** or (*VSX-D814 only*) **SB SW**.
- You can't adjust the surround back channel level when you're listening to the virtual surround back channel.

Type of source	Virtual Surround Back mode	STANDARD			ADVANCED SURROUND
		STANDARD decoding	PRO LOGIC IIx MOVIE/MUSIC	NEO:6 CINEMA/ NEO:6 MUSIC	All modes
DTS-ES/Dolby Digital Matrix encoded multi-channel sources with 6.1 surround	ON	✓			✓
	AUTO	✓			✓
Dolby Digital/DTS encoded multi-channel sources	ON	✓			✓
	AUTO				✓
Dolby Digital/DTS encoded stereo sources, Stereo sources	ON		✓	✓	✓
	AUTO			✓	✓
Analog 2-channel (stereo) source	ON		✓	✓	✓
	AUTO			✓	✓

Using Midnight and Loudness listening

The Midnight listening feature allows you to hear effective surround sound of movies at low volume levels. The effect automatically adjusts according to the volume at which you're listening.

The Loudness listening feature can be used to get good bass and treble from music sources at low volume levels.

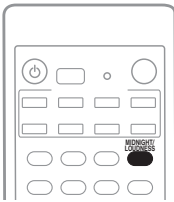

- Press **MIDNIGHT/LOUDNESS** to switch between **MIDNIGHT**, **LOUDNESS**, and **OFF**.

Note

- You can't use **MIDNIGHT/LOUDNESS** when **DVD 5.1 ch** has been selected, or when listening to a DTS 96kHz/24 bit source and 96 kHz PCM.

Using the tone controls

Depending on what you are listening to, you may want to adjust the bass or treble using the front panel tone control.

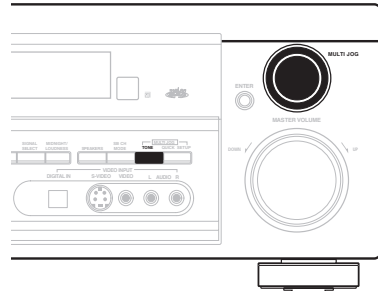

* Illustration shows the VSX-D814 model

1 Press **TONE** to select the frequency you want to adjust.

Press to switch between **BASS** and **TREBLE**.

2 Use the **MULTI JOG** dial to change the amount of bass or treble as necessary.

Wait about five seconds for your changes to be input automatically.

Note

- You can only use the tone controls when **STEREO/DIRECT** is selected. **DIRECT** will switch to **STEREO** when the tone controls are used.
- *VSX-D714/D814 only* – The tone controls affect **SPEAKER A** only. They can't be used when **SPEAKER A** is switched off.

Playing other sources

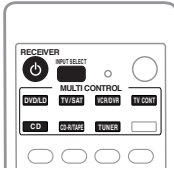

- 1 Turn on the power of the playback component.
- 2 Turn on the power of the receiver.
- 3 Select the source you want to playback.
Use the **MULTI CONTROL** buttons (or **INPUT SELECT**).
- 4 Start playback of the component you selected in step 1.

Selecting the multichannel analog inputs

If you have connected a decoder or a DVD player with multichannel analog outputs to this receiver (page 17), you must select the analog multichannel inputs for surround sound playback.

VSX-D514 model:

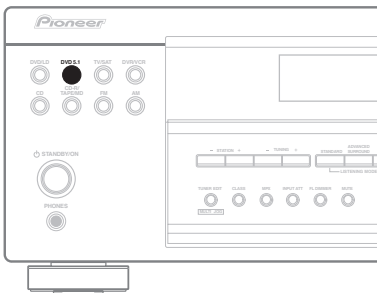

- Press **DVD 5.1** on the front panel to select the multichannel inputs.

VSX-D714/D814 model:

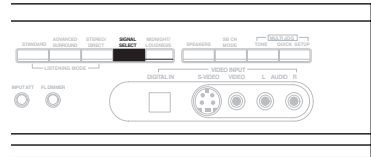

* Illustration shows the VSX-D814 model

- 1 Press **DVD/LD** on the remote control or the front panel.

- 2 Press **SIGNAL SELECT** (front panel) repeatedly to select **DVD 5.1ch**.

To cancel playback from the multichannel inputs, use the **SIGNAL SELECT** button to select a different input signal.

Note

- When playback from the multichannel inputs is selected, you can't use the **INPUT ATT**, **TONE**, and **MIDNIGHT/LOUDNESS** buttons, as well as the **STANDARD**, **ADVANCED SURROUND**, and **STEREO/DIRECT** sound modes.
- When playback from the multichannel inputs is selected, only the volume and channel levels can be set.

Using the sleep timer

The sleep timer switches the receiver into standby after a specified amount of time so you can fall asleep without worrying about the receiver being left on all night. Use the remote control to set the sleep timer.

- 1 Press **RECEIVER**.
- 2 Press **SLEEP** repeatedly to set the sleep time.

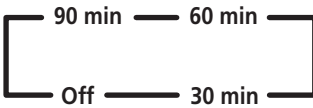

Tip

- You can check the remaining sleep time at any time by pressing **SLEEP** once. Pressing repeatedly will cycle through the sleep options again.
- You can also switch off the sleep timer simply by switching off the receiver.



Chapter 6:

Setting up the receiver

Choosing your receiver setup

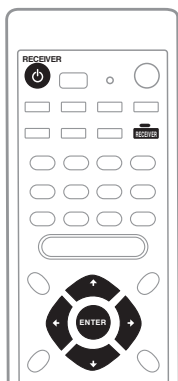
To ensure the best possible surround sound, be sure to complete the following set up operations. This is particularly important when using DTS and Dolby surround. You only need to make these settings once (unless you change the placement of your current speaker system or add new speakers, etc.). Refer to the following pages for details on each of the settings.



- 1 Press **RECEIVER**  to turn the power on.
- 2 Press **RECEIVER**.
- 3 Use  or  to choose the option you want to adjust.

It will be easiest to adjust each of the settings in turn, following the order below (and on the following pages). The current setting is shown for each option as you cycle through the display.

The VSX-D514 and VSXD714/D814 settings are separated below for easy reference.

VSX-D514 only:

- Speaker setting** (page 46)
Specify the number and type of speakers you have connected.
- Subwoofer setting** (page 47)
Specify how the subwoofer is used.
- Crossover frequency setting** (page 47)
Determine which frequencies will be sent to the subwoofer (or large speakers).
- LFE attenuator setting** (page 47)
Choose the attenuator level for the LFE channel.
- Front speaker distance setting** (page 48)
Specify the distance from your listening position to your front left speaker.
- Center speaker distance setting** (page 48)
Specify the distance from your listening position to your center speaker.
- Surround speaker distance setting** (page 48)
Specifies the distance from your listening position to your surround back speakers.
- Subwoofer distance setting** (page 49)
Specify the distance from your listening position to your subwoofer.
- Dynamic range control setting** (page 50)
Compress the dynamic range of the sound track.
- Dual mono setting** (page 50)
Isolate one channel when listening to discs with dual mono encoding.
- Digital input settings** (page 50)
Specify the components to be assigned to the digital inputs (below).

- Coaxial digital input 1 setting
- Coaxial digital input 2 setting
- Optical digital input 1 setting

VSX-D714/D814:

Speaker setting (page 46)

Specify the number and type of speakers you have connected.

Surround back speaker setting (page 46)

Specify your surround back speaker/ surround back subwoofer setup.

Subwoofer setting (page 47)

Specify how the subwoofer is used.

Crossover frequency setting (page 47)

Determine which frequencies will be sent to the subwoofer (or large speakers).

LFE attenuator setting (page 47)

Choose the attenuator level for the LFE channel.

Front left speaker distance setting

(page 48)

Specify the distance from your listening position to your front left speaker.

Center speaker distance setting (page 48)

Specify the distance from your listening position to your center speaker.

Front right speaker distance setting

(page 48)

Specify the distance from your listening position to your front right speaker.

Surround right speaker distance setting

(page 49)

Specify the distance from your listening position to your surround right speaker.

Surround back speaker distance setting

(page 49)

Specifies the distance from your listening position to your surround back speakers.

Surround left speaker distance setting

(page 49)

Specify the distance from your listening position to your surround left speaker.

Subwoofer distance setting (page 49)

Specify the distance from your listening position to your subwoofer.

Dynamic range control setting (page 50)

Compress the dynamic range of the sound track.

Dual mono setting (page 50)

Isolate one channel when listening to discs with dual mono encoding.

Component video input settings

(page 50)

Specify the components to be assigned to the component video inputs (below).

- Component video 1 input setting
- Component video 2 input setting

Digital input settings (page 50)

Specify the components to be assigned to the digital inputs (below).

- Coaxial digital input 1 setting
- Coaxial digital input 2 setting
- Optical digital input 1 setting
- Optical digital input 2 setting (*VSX-D814 only*)

SR+ control settings (page 51)

Specify how you want to control your Pioneer plasma display.

- Control mode setting
- Volume control setting
- Function setting for **DVD** input
- Function setting for **TV** input
- Function setting for **DVR** input
- Function setting for **VIDEO** input

4 Use ↑ or ↓ to adjust the setting.

The setting is entered automatically.

5 Repeat steps 3 and 4 to adjust other setup options.

6 When you're done, press ENTER to exit.



Note

- The setting display is automatically exited after 3 minutes of inactivity.

Speaker setting

- *VSX-D514* default setting: **S** (all speakers)
- *VSX-D714/D814* default setting: **FL-CS-SS** (If a subwoofer is detected when you turn the receiver on, the default is **FS-CS-SS**.)

You must let the receiver know how many speakers you have, and how big they are. The size you choose (large or small) determines how much bass is sent from the receiver to the speakers.

In the display, **F**, **C**, and **S** refer to front, center, and surround speakers respectively. Speaker size is denoted as **L** for large speakers, **S** for small speakers, and ***** (asterisk) if no speaker is connected.



Note

- If the cone size (diameter) of the speaker is larger than 15 cm, set the speaker size to **L**.
- If you're not using a subwoofer, we recommend setting the front speakers to **L**.
- **Cycle through the available choices using ↑ or ↓ and choose a configuration that matches your speaker setup.**

One of the following configurations should match your setup:

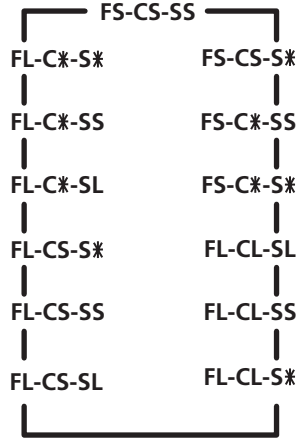

Surround back speaker setting

VSX-D714/D814 only

- Default setting: **S** (*VSX-D814*), ***** (*VSX-D714*)

You must let the receiver know if surround back speaker(s) have been connected, and how big they are. The size you choose (large or small) determines how much bass is sent from the receiver to the speakers. If you have connected a subwoofer to the surround back terminals (*VSX-D814* only), you should select the surround back subwoofer setting (**SB SW**) from the options. Choose ***** (asterisk) if no speaker is connected.

- Use ↑ or ↓ to select **SB S**, **SB ***, **SB SW** or **SB L**.

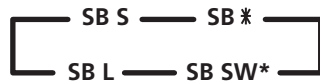

* *VSX-D814 only*

 **Note**

- To select **SB L**, you must have **SL** selected in the *Speaker setting*.

Subwoofer setting

You can choose whether the subwoofer is used or not. Use the plus (**PLUS**) setting for extra bass.

- Use **↑** or **↓** to select subwoofer **YES**, **PLUS** or **NO**.
 - **YES** – The LFE channel and bass frequencies from the small (**S**) speakers are sent to the subwoofer.
 - **PLUS** – The LFE channel and bass frequencies from all speakers are sent to the subwoofer (**L** speakers will also output bass).
 - **NO** – No bass frequencies are sent to the subwoofer.

 **Note**

- If you choose the small front speaker setting, **SW YES** is automatically set and locked.

Crossover frequency setting

- Default setting: **100 Hz**

Crossover frequency is the point where the receiver divides the high and low sounds (the frequencies) between the speakers. Since most smaller speakers can't handle deep bass tones, you can send these sounds to the subwoofer (or if you don't have a subwoofer, the large (**L**) speakers in your system) instead of the speakers set to small (**S**) in your setup. Choose the point at which you want the frequency routed to the subwoofer (or **L** speakers).

We recommend setting this to **200Hz** if your **S** speakers are smaller bookshelf-type speakers.

- Use **↑** or **↓** to specify the crossover frequency for your small speakers (**100 Hz**, **150 Hz** or **200 Hz**).
 - **100Hz** – Sends bass frequencies below 100 Hz to the subwoofer (or **L** speakers).
 - **150Hz** – Sends bass frequencies below 150 Hz to the subwoofer (or **L** speakers).
 - **200Hz** – Sends bass frequencies below 200 Hz to the subwoofer (or **L** speakers).

 **Note**

- If all speakers (front, center, and surround) are set to **L**, the crossover frequency can't be set because there are no **S** speakers (******* appears in the display).

LFE attenuator setting

- Default setting: **0 dB**

Dolby Digital and DTS audio sources include ultra-low bass tones. Set the LFE attenuator as necessary to prevent the ultra-low bass tones from distorting the sound from the speakers.

- Use **↑** or **↓** to set the attenuation level (**0 dB**, **10 dB** or **** dB(∞)**).

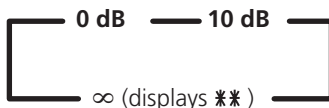

 **Note**

- When **∞** is selected (****** appears in the display), LFE cannot be heard.

Front speaker distance setting

VSX-D514 only

- Default setting: **3 m**

Sets the distance from the front left speaker to the listening position.

- Use **↑** or **↓** to set the distance of the front speakers from the main listening position (within the range of 0.1 m to 9.0 m).

Front left speaker distance setting

VSX-D714/D814 only

- Default setting: **3 m**

Sets the distance from the front left speaker to the listening position.

- Use **↑** or **↓** to set the distance of the front left speaker from the main listening position (within the range of 0.1 m to 9.0 m).

Center speaker distance setting

- Default setting: **3 m**

The center speaker is normally placed directly in the front of the listening room and closer to the listening position than the front speakers. This means that the sound from the center speaker will be heard before the front speakers. To prevent this, set the center speaker distance setting to delay the sound from the center speaker so that the sound from the front and center speakers will be heard at the same time.

- Use **↑** or **↓** to set the distance of the center speaker from the main listening position (within the range of 0.1 m to 9.0 m).



Note

- When **C*** is selected in the speaker setting, the center speaker distance can't be set.

Front right speaker distance setting

VSX-D714/D814 only

- Default setting: **3 m**

Sets the distance from the front right speaker to the listening position.

- Use **↑** or **↓** to set the distance of the front right speaker from the main listening position (within the range of 0.1 m to 9.0 m).

Surround speaker distance setting

VSX-D514 only

- Default setting: **3 m**

You should set the distance of the surround speakers accurately to hear sounds coming from all speakers at the same time.

- Use **↑** or **↓** to set the distance of the surround speaker from the main listening position (within the range of 0.1 m to 9.0 m).



Note

- When **S*** is selected in the speaker setting, the surround speaker distance can't be set.

Surround right speaker distance setting

VSX-D714/D814 only

- Default setting: **3 m**

You should set the distance of the surround speakers accurately to hear sounds coming from all speakers at the same time.

- Use **↑** or **↓** to set the distance of the surround right speaker from the main listening position (within the range of 0.1 m to 9.0 m).



Note

- When **S*** is selected in the speaker setting, the surround speaker distance can't be set.

Surround back speaker distance setting

VSX-D714/D814 only

- Default setting: **3 m**

You should set the distance of the surround back speakers accurately to hear sounds coming from all speakers at the same time.

- Use **↑** or **↓** to set the distance of the surround back speakers from the main listening position (within the range of 0.1 m to 9.0 m).



Note

- When **SB SW** (VSX-D814 only) or **SB*** is selected in the surround back speaker setting, the surround back speaker distance can't be set.

Surround left speaker distance setting

VSX-D714/D814 only

- Default setting: **3 m**

You should set the distance of the surround speakers accurately to hear sounds coming from all speakers at the same time.

- Use **↑** or **↓** to set the distance of the surround left speaker from the main listening position (within the range of 0.1 m to 9.0 m).



Note

- When **S*** is selected in the speaker setting, the surround speaker distance can't be set.

Subwoofer distance setting

- Default setting: **3 m**

Like your speakers, you should set the distance of the subwoofer accurately to hear sounds from all speakers at the same time.

- Use **↑** or **↓** to set the distance of the subwoofer from the main listening position (within the range of 0.1 m to 9.0 m).



Note

- When **SW NO** is selected in the subwoofer setting, the subwoofer distance can't be set.

Dynamic range control setting

- Default setting: **OFF**

Dynamic range is the difference between the loudest and softest sounds in any given signal. With this setting, you can compress the dynamic range, so that low level sounds can be heard more easily (sounding relatively louder) yet louder sounds won't be too overbearing.

- Use \uparrow or \downarrow to set the dynamic range control (**OFF**, **MAX**, or **MID**).



Note

- When listening at low volumes, set to **MAX** for maximum dynamic range compression.
- Dynamic range control is effective only when a Dolby Digital or DTS signal is being played back.

Dual mono setting

- Default setting: **ch1**

The dual mono setting can only be used when listening to Dolby Digital and DTS signals with dual mono encoding. It is sometimes used when it is necessary to have one language on one channel and a different language on the other. With this setting you can choose which channel in the dual mono setting you want to listen to.

If Dolby Digital mode is switched on, you will hear the channel you have selected (either **ch1** or **ch2**) through your center speaker. With Dolby Digital mode off, or if you don't have a center speaker, you will hear the channel you have selected through both front speakers. In the **Lch1.Rch2** setting, the left front speaker will play channel 1 and the right front speaker will play channel 2.

- Use \uparrow or \downarrow to cycle through the possible dual mono settings.

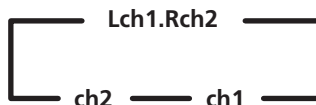

Component video input settings

VSX-D714/D814 only

Here you tell the receiver what components you have hooked up to the component video jacks on the back of the receiver.

Component video 1:

- Default setting: **DVD**

- 1 Use \uparrow or \downarrow to assign the component video 1 input (**DVD**, **TV**, **DVR** or **OFF**).

Component video 2:

- Default setting: **TV**

- 2 Use \uparrow or \downarrow to assign the component video 2 input (**DVD**, **TV**, **DVR** or **OFF**).

Digital input settings

Here you tell the receiver what components you have hooked up to the coaxial and optical **DIGITAL IN** jacks on the back of the receiver.

After you assign a component to a digital jack, whenever you select that component, (for example, a DVD player) the receiver automatically changes to the digital input setting and **DIGITAL** shows in the display.

Coaxial digital 1:

- Default setting: **DVD**

- Use \uparrow or \downarrow to assign the coaxial digital 1 input (**DVD**, **TV**, **CD**, **CDR**, **DVR** or **OFF**).

Coaxial digital 2:

- Default setting: CD
- Use **↑** or **↓** to assign the coaxial digital 2 input (DVD, TV, CD, CDR, DVR or OFF).

Optical digital 1:

- Default setting: TV
- Use **↑** or **↓** to assign the optical digital 1 input (DVD, TV, CD, CDR, DVR or OFF).

Optical digital 2

(VSX-D814 only)

- Default setting: DVD
- Use **↑** or **↓** to assign the optical digital 2 input (DVD, TV, CD, CDR, DVR or OFF).



Note

- You can't assign two inputs to the same function. For example, assigning input 1 to the default setting of input 2 automatically switches input 2 to **OFF**.

SR+ control for Pioneer plasma displays

VSX-D714/D814 only

Make the following settings if you have connected a Pioneer plasma display to this receiver using an SR+ cable. Note that the number of function settings available will depend on the plasma display you've connected.

See also *Using this receiver with a Pioneer plasma display* on page 26 and *Using the SR+ mode with a Pioneer plasma display* on page 54.

Control mode setting

This must be switched to **SR+ ON** to access the settings below (default is **SR+ OFF**).

- **SR+ OFF** – Switches SR+ off (the receiver and plasma display work independently)
- **SR+ ON** – Switches SR+ on (the receiver sends control signals to the plasma display)

Volume control setting

- **VOL C OFF** – The receiver does not control the volume of the plasma display
- **VOL C ON** – When the receiver is switched to one of the inputs that use the plasma display (**DVD/LD**, or another one of functions listed below), the volume on the plasma display is muted so only sound from the receiver is heard.

Function setting for DVD/LD input

- **DVD:1 – DVD:5** or **TV** – Matches the **DVD/LD** function of the receiver with a numbered video input on the plasma display. For example, **DVD:3** matches the **DVD/LD** input with video input 3 on the plasma display.

Function setting for TV/SAT input

- **TV:1 – TV:5** or **TV** – Matches the **TV/SAT** function of the receiver with a numbered video input on the plasma display. For example, **TV:1** matches the **TV/SAT** input with video input 1 on the plasma display.

Function setting for DVR/VCR input

- **DVR:1 – DVR:5** or **TV** – Matches the **DVR/VCR** function of the receiver with a numbered video input on the plasma display. For example, **DVR:2** matches the **DVR/VCR** input with video input 2 on the plasma display.

Function setting for VIDEO input

- **VIDEO:1 – VIDEO:5** or **TV** – Matches the **VIDEO** function of the receiver with a numbered video input on the plasma display. For example, **VIDEO:4** matches the **VIDEO** input with video input 4 on the plasma display.

Manually calibrating your listening area (MCACC)

V SX-D714/D814 only

You can use the Multichannel Acoustic Calibration (MCACC) system to fine tune your speaker levels and channel delay. These are calibrated according to the distance from your left front speaker to the listening position. You will hear a series of test tones that will allow you to set the speaker levels and channel delay to your liking. The advantage of doing this is that you can achieve an overall balance defined by the front speakers (the main speakers for home theater).



Caution

- These test tones can be loud, so take care that there is no one in the room who will be startled by the noise.



Important

- You must complete the *Speaker setting* on page 46 before using the MCACC setup.

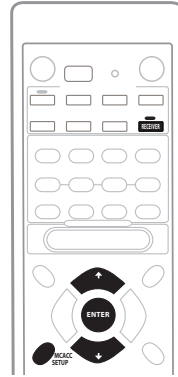

1 Press RECEIVER.

2 Press MCACC SETUP.

The MCACC system uses the left front speaker as a reference point to calibrate the speaker level and channel delay.

The front left speaker tone and the target speaker (the one that you're trying to adjust) tone will sound in turns, so you can judge which needs to be louder.

3 Use ↑ and ↓ to adjust each channel level in turn, pressing ENTER to go to the next channel when you're done.

The test tone is output in the following order (depending on the speaker setting):

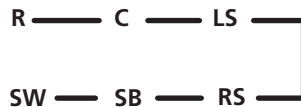

4 Specify the distance from the front left speaker to your listening position using ↑ and ↓ then press ENTER.

5 Use ↑ and ↓ to adjust the delay for each channel in turn, pressing ENTER to go to the next channel when you're done.

Listen to the reference channel and use it to measure the target channel. Stand facing the two speakers with your arms outstretched pointing at each speaker. Try to make the two tones sound as if they are arriving simultaneously at a position slightly in front of you and between your arm span.

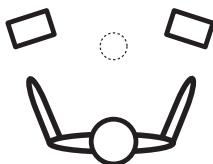

The test tone for channel delay is output in the same order as step 5:

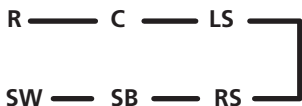

After you have completed all the channels in your speaker setup, the volume level returns to normal and **COMPLETE**, then **RESUME** shows in the display.

The MCACC indicator then lights to show that MCACC setup is complete.

Note

- Using the MCACC system to set up your speaker system will overwrite any previous settings you had for the **STANDARD** or **ADVANCED SURROUND** modes.

Setting separate channel levels for listening modes

- Default setting: **0 dB**

You can set relative channel levels from the listening position using the method below (this is similar to the VSX-D714/D814 MCACC setup). Using **CH SELECT** (see tip below), it is also possible to set separate channel levels for each of the listening modes.

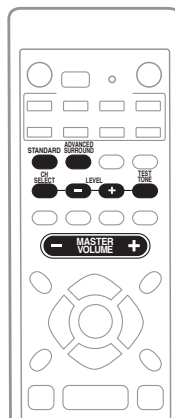

1 Press STANDARD or ADVANCED SURROUND.

2 Press TEST TONE to output the test tone.

The test tone is output in the following order (depending on the speaker setting):

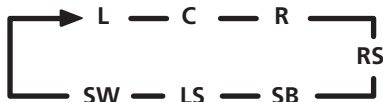

- If you don't hear a test tone from one of your speakers, please refer to *Speaker setting* on page 46 and (*VSX-D714/D814 only*) *Surround back speaker setting* on page 46 to make sure you have correctly specified your speaker setup.

3 Press MASTER VOLUME +/- to adjust the volume to an appropriate level.

4 Use LEVEL +/- to adjust the speaker levels in turn.

You should hear the test tone at the same volume from each speaker when seated in the main listening position. The channel level range is ± 10 dB.

5 When you're done, press TEST TONE to turn off the test tone.

The receiver returns to the Standard mode.



Tip

- The speaker volume can be adjusted without outputting the test tone by pressing **CH SELECT** and then using **LEVEL +/-**. However, you can only adjust the level of the speakers currently active in the mode you're listening to. You can set separate levels for the **STANDARD**, **STEREO** and **DVD 5.1 ch** modes, as well as for each **ADVANCED SURROUND** mode.



Note

- Test tone is only output in **STANDARD** or **ADVANCED SURROUND** mode.
- Since the subwoofer transmits an ultra-low frequency its sound may seem quieter than it actually is.
- Using test tones to set up your speaker system will overwrite any previous settings you had for the **STANDARD** or **ADVANCED SURROUND** modes.

Using the SR+ mode with a Pioneer plasma display

VSX-D714/D814 only

When connected using an SR+ cable, a number of features become available to make using this receiver with your Pioneer plasma display even easier. These features include:

- On-screen displays when making receiver settings, such as speaker setup, MCACC setup, and so on.
- On-screen volume display.
- On-screen display of listening mode.
- Automatic video input switching on the plasma display.
- Automatic volume muting on the plasma display.

See also *Using this receiver with a Pioneer plasma display* on page 26 for connecting up, and *SR+ control for Pioneer plasma displays* on page 51 for setting up the receiver.

1 Make sure that the plasma display and this receiver are switched on and that they are connected with the SR+ cable.

See *Using this receiver with a Pioneer plasma display* on page 26 for more on connecting these components.

2 To switch SR+ mode on/off, press RECEIVER, then the SR+ button.

The front panel display shows **SR+ CHECK**, then the new setting is displayed (**SR+ ON** or **SR+ OFF**).



Note

- The automatic volume muting feature is enabled separately; see *SR+ control for Pioneer plasma displays* on page 51. (You can also use the System Setup menu to switch the SR+ mode of the receiver.)

- If you disconnect the SR+ cable or switch the plasma display off while SR+ is on, the receiver will automatically revert to **SR+ OFF**.
- **SR+ ERR** shows in the display if no SR+ connection is detected (for example, the cable isn't connected).

Chapter 7: Using the tuner

Listening to the radio

The following steps show you how to tune in to FM and AM radio broadcasts using the automatic (search) and manual (step) tuning functions. If you already know the frequency of the station you want, see *Tuning directly to a station* below. Once you are tuned to a station you can memorize the frequency for recall later—see *Saving station presets* on page 57 for more on how to do this.

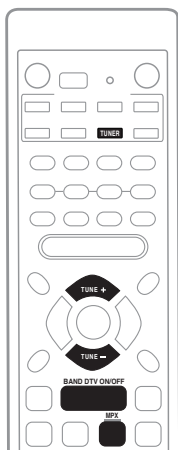

1 Press the TUNER button to select the tuner.

2 Use the BAND button to change the band (FM or AM), if necessary.

Each press switches the band between FM and AM.

3 Tune to a station.

There are three ways to do this:

Automatic tuning

To search for stations in the currently selected band, press and hold **TUNE +/-** for about a second. The receiver will start searching for the next station, stopping when it has found one. Repeat to search for other stations.

Manual tuning

To change the frequency one step at a time, press **TUNE +/-**.

High speed tuning

Press and hold **TUNE +/-** for high speed tuning. Release the button at the frequency you want.

Improving FM stereo sound

If the **TUNED** or **STEREO** indicators don't light when tuning to an FM station because the signal is weak, press the **MPX** button to switch the receiver into mono reception mode. This should improve the sound quality and allow you to enjoy the broadcast.

Tuning directly to a station

Sometimes, you'll already know the frequency of the station you want to listen to. In this case, you can simply enter the frequency directly using the number buttons on the remote control.

1 Press the TUNER button to select the tuner.

2 Use the BAND button to change the band (FM or AM), if necessary.

Each press switches the band between FM and AM.

3 Press D.ACCESS (Direct Access).

4 Use the number buttons to enter the frequency of the radio station.

For example, to tune to **106.00** (FM), press **1, 0, 6, 0, 0**.

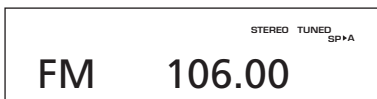

If you make a mistake halfway through, press **D.ACCESS** twice to cancel the frequency and start over.

Saving station presets

If you often listen to a particular radio station, it's convenient to have the receiver store the frequency for easy recall whenever you want to listen to that station. This saves the effort of manually tuning in each time. This unit can memorize up to 30 stations, stored in three banks, or classes, (A, B and C) of 10 stations each. When saving an FM frequency, the **MPX** setting (see page 56) is also stored. Use the front panel controls to store station presets.

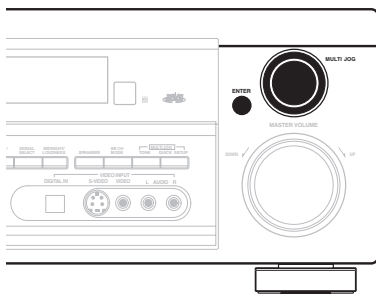

* Illustration shows the VSX-D814 model

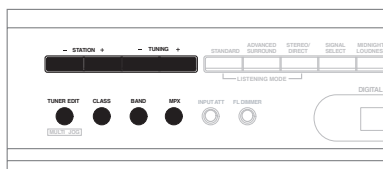

* Illustration shows the VSX-D814 model

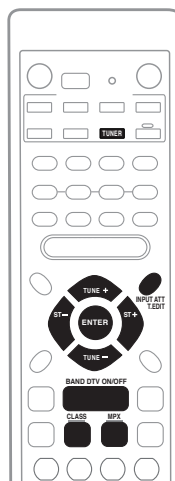

1 Tune to a station you want to memorize.

See *Listening to the radio* on page 56 for more on this.

2 Press T.EDIT (TUNER EDIT).

The display shows **ST. MEMORY**, then a blinking memory class.

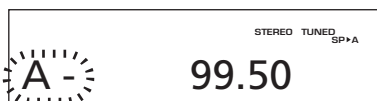

3 Press CLASS to select one of the three classes then press ST +/- (STATION +/-) to select the station preset you want.

You can also use the **MULTI JOG** dial (front panel) to select a station preset.

4 Press ENTER.

After pressing **ENTER**, the preset class and number stop blinking and the receiver stores the station.

Naming station presets

For easier identification, you can name your station presets.

1 Choose the station preset you want to name.

See *Listening to station presets* below for how to do this.

2 Press T.EDIT (TUNER EDIT).

The display shows **ST. NAME**, then a blinking cursor at the first character position.

3 Input the name you want.

Names can be up to four characters long.

- Use the **MULTI JOG** dial (front panel) or the **ST +/-** buttons (remote) to select characters.
- Press **ENTER** to confirm a character. If no character is input, a space is input.
- The name is stored when **ENTER** is pressed after choosing the fourth character.



Tip

- To erase a station name, simply repeat steps 1-3 and input four spaces instead of a name.
- Once you have named a station preset, you can press **DISPLAY** when listening to a station to switch the display between the name and the frequency.

Listening to station presets

You will need to have some presets stored to do this. See *Saving station presets* on page 57 if you haven't done this already.

1 Press TUNER to select the tuner.

2 Press CLASS to select the class in which the station is stored.

Press repeatedly to cycle through classes A, B and C.

3 Press ST +/- (STATION +/-) to select the station preset you want.



Note

- If the receiver is left disconnected from the AC power outlet for an extended period, the station memories will be lost and will have to be reprogrammed.

Changing the frequency step

If you find that you can't tune into stations successfully, the frequency step may not be suitable for your country/region. Here's how to switch the setting:

1 Switch the receiver into standby.

2 On the front panel, press \odot STANDBY/ON while you press and hold the BAND (VSX-D714/D814) / CLASS (VSX-D514) button.

The channel tuning step alternates between **FM 100 kHz/AM 10kHz** and **FM 50 kHz/AM 9 kHz** each time you do this.

Chapter 8: Making recordings

Making an audio or a video recording

You can make an audio or a video recording from the built-in tuner, or from an audio or video source connected to the receiver (such as a CD player or TV).

Keep in mind you can't make a digital recording from an analog source or vice-versa, so make sure the components you are recording to/from are hooked up in the same way (see *Connecting up* on page 14 for more on connections).

If you want to record a video source, you also need to use the same type of connection for the source as for the recorder. For example, you can't record a component hooked up to S-video jacks with a recorder hooked up to the component video outputs (see page 18 for more on video connections).

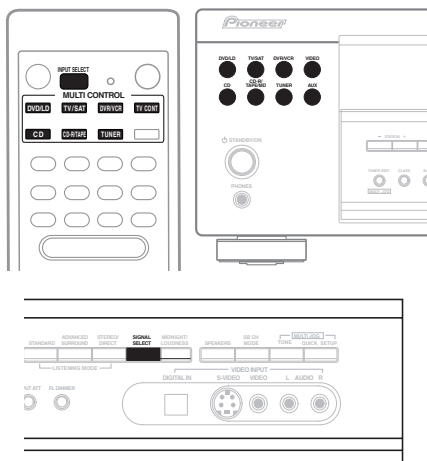

* Illustrations show the VSX-D814 model

1 Select the source you want to record.
Use the **MULTI CONTROL** buttons (or **INPUT SELECT**).

2 Select the input signal (if necessary).
Press **SIGNAL SELECT** (front panel) to select the input signal corresponding to the source component (see page 38 for more on this).

3 Prepare the source you want to record.
Tune to the radio station, load the CD, video, DVD etc.

4 Prepare the recorder.
Insert a blank tape, MD, video etc. into the recording device and set the recording levels. Refer to the instructions that came with the recorder if you are unsure how to do this. Most video recorders set the audio recording level automatically—check the component's instruction manual if you're unsure.

5 Start recording, then start playback of the source component.

Note

- The receiver's volume, balance, tone (bass, treble, loudness), and surround effects have no effect on the recorded signal.

Chapter 9:

Controlling the rest of your system

Setting the remote to control other components

There are several ways to set your remote to control the other components in your system. The easiest way to do this is to assign the component's manufacturer preset code (starting on page 66) to one of the **MULTI CONTROL** buttons on the remote control.

The buttons can be set to control the following components:

Button	Controllable Components
DVD/LD:	DVD or LD player
TV/SAT:	TV or Satellite tuner
DVR/VCR:	Digital Video Recorder or VCR
CD:	CD player
CD-R/TAPE:	CD Recorder, Tape deck or MD player
TV CONT:	TV or Cable TV tuner
TUNER:	FM/AM tuner

- *VSX-D814 only* – If you can't find a preset code that matches the component you want to control, you can still teach the remote individual commands from another remote control (page 61).



Note

- The remote control will exit an operation after 1 minute of inactivity.

Selecting preset codes directly

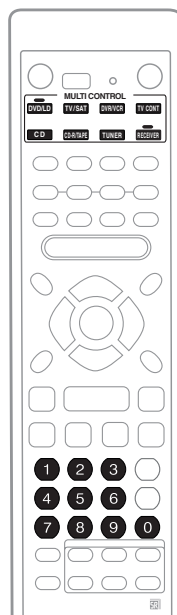

- 1 While pressing the RECEIVER button, press and hold the 1 button.**

The LED blinks.

- 2 Press the MULTI CONTROL button for the component you want to control.**

The LED lights.

3 Use the number buttons to enter the preset code.

You can find the preset codes on page 66 (VSX-D514/D714) and page 68 (VSX-D814).

The LED blinks again after you enter the code.

If the correct code has been input the power of the component being input will turn on or off.

The power of the component being input will only turn on or off if that component is able to be turned on directly by remote control.

- You can only input a code for the component type written on each **MULTI CONTROL** button (except **RECEIVER** and **TUNER**).
- Even if you don't input a preset code for the TV (**TV/SAT MULTI CONTROL** button) you will be able to control your TV using the dedicated **TV CONTROL** on the remote if you have assigned it to the **TV CONT** button.
- You may not be able to use a particular code even if it is listed on page 66.
- The remote control buttons will not be able operate other equipment unless preset with the method above.

4 Repeat steps 2 through 3 to try a different code, or to enter a code for another component you want to control.

5 When you're done, press RECEIVER.

Programming signals from other remote controls

VSX-D814 only

If the preset code for your component is not available, or the available preset codes do not operate correctly, you can program signals from the remote control of another compo-

nent (for example ▶, ■, or other operation buttons). This can also be used to program additional operations (buttons not covered in the presets) after assigning a preset code.

1 While pressing the RECEIVER button, press and hold the 2 button.

The LED blinks.

2 Press the MULTI CONTROL button for the component you want to control.

The LED lights.

- To exit or cancel press **RECEIVER**.

3 Point the two remote controls towards each other about 2–5 cm apart then press the button that will be doing the learning on this receiver's remote control.

The LED blinks rapidly.

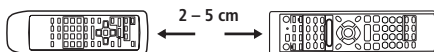

4 Press the corresponding button on the other remote control that is sending (teaching) the signal to this receiver's remote control.

If the operation has been learned successfully, the LED on this receiver's remote will blink once then light steadily.

If for some reason the operation hasn't been learned the LED will blink for three seconds and then light steadily. If this happens, keep pressing the (teaching) button as you vary the distance between the two remotes, until you see the LED light steadily.

If there is not enough memory for this button to be learned by the remote, the LED will blink twice and the operation will be canceled.

5 To program additional signals for the current component repeat steps 3 and 4.

To program operations for another component exit and repeat steps 1 through 5.

6 When you're done, press **RECEIVER** to store the operation(s).



Note

- Some commands from other remote controls cannot be learned, but in most cases the remotes just need to be moved closer together or farther apart.
- Certain buttons represent operations that cannot be learned from other remote controls. These include: **RECEIVER**, the **MULTI CONTROL** buttons, **RECEIVER CONTROL** and **MASTER VOLUME** buttons.

Erasing all of your programmed settings

VSX-D814 only

This erases all of the buttons you have programmed (in *Programming signals from other remote controls*, above) and restores the button to the factory default.

- **While pressing the RECEIVER button, press and hold the 9 button for three seconds.**

The LED blinks steadily for three seconds and then goes off.

Clearing all the remote control settings

You can clear all presets and restore the factory default settings.

- **While pressing the RECEIVER button, press and hold the 0 button for three seconds.**

The LED blinks three times indicating the settings have been restored to the factory presets.

Direct function

- Default setting: **ON**

You can use the direct function feature to control one component using the remote control while at the same time, using your receiver to playback a different component. This could let you, for example, use the remote control to set up and listen to a CD on the receiver and then use the remote control to rewind a tape in your VCR while you continue to listen to your CD player.

When direct function is on, any component you select (using the **MULTI CONTROL** buttons) will be selected by both the receiver and the remote control. When you turn direct function off, you can operate the remote control without affecting the receiver.

- 1** While pressing the **RECEIVER** button, press and hold the **4** button.

The LED blinks.

- 2** Press the **MULTI CONTROL** button for the component you want to control.

The LED lights.

- 3** Use the number buttons to enter either **1 (direct on)** or **2 (direct off)**.

The LED blinks again.

- 4** Repeat steps 2 through 3 for the other components you want to control.

- 5** When you're done, press **RECEIVER**.











Note

- You can't use direct function for **TUNER**.

Controls for TVs

This remote control can control components after entering the proper codes or teaching the receiver the commands (see *Setting the remote to control other components* on page 60 for more on this). Use the **MULTI CONTROL** buttons to select the component.

Button(s)	Function	Components
TV 	Switches the DTV on or off.	DTV
	Switches the TV or CATV between standby and on.	Cable TV/Satellite TV/TV
INPUT SELECT	Switches the TV input. (Not possible with all models.)	TV
CHANNEL +/-	Selects channels.	Cable TV/Satellite TV/TV/DTV
VOLUME +/-	Adjust the TV volume.	Cable TV/Satellite TV/TV/DTV
TOP MENU	Use as the TEXT ON button.	TV
MENU	Select different menus from the DTV functions.	DTV
	Select the menu screen.	Cable TV/Satellite TV/TV
AUDIO	Use as the AUDIO button.	Cable TV/Satellite TV/TV/DTV
GUIDE	Use as the GUIDE button for navigating.	Cable TV/Satellite TV/DTV
	Use as the TEXT OFF button.	TV
	Use to choose the BLUE commands on a DTV menu.	DTV
	Use to choose the GREEN commands on a DTV menu.	DTV
	Use to choose the RED commands on a DTV menu.	DTV
	Use to choose the YELLOW commands on a DTV menu.	DTV
	Press to get information on DTV programs.	DTV
	Switches DTV on or off.	DTV
	Use to select closed captioning with DTV.	DTV
Number Buttons	Use to select a specific TV channel.	Cable TV/Satellite TV/TV/DTV
+10 button	Use to add a decimal point when selecting a specific TV channel.	DTV

Button(s)	Function	Components
ENTER/DISC	Use to enter a channel.	Cable TV/Satellite TV/TV/DTV
ENTER	<p>↔⇨⇧⇩ & Select or adjust and navigate items on the menu screen. ENTER brings up the DTV menus.</p> <p>Press to select or adjust and navigate items on the menu screen.</p>	DTV Cable TV/Satellite TV/TV/DTV



Note

- The four **TV CONTROL** buttons on the remote control are dedicated to control the TV assigned to the **TV CONT** button. Thus if you only have one TV to hook up to this system assign it to the **TV CONT MULTI CONTROL** button. If you have two TVs, assign the main TV to the **TV CONT** button.

Controls for other components

This remote control can control these components after entering the proper codes or teaching the receiver the commands (see *Setting the remote to control other components* on page 60 for more on this). Use the **MULTI CONTROL** buttons to select the component.

Button (s)	Function	Components
SOURCE ↻	Press to switch the component between standby and on.	CD/MD/CD-R/VCR/DVD/LD/DVR player/Cassette deck
⏮	<p>Press to return to the start of the current track. Repeated presses skips to the start of previous tracks.</p> <p>Play the reverse side of the tape on a reversible deck.</p>	CD/MD/CD-R/DVD/LD player Cassette deck
⏭	<p>Press to advance to the start of the next track. Repeated presses skips to the start of following tracks.</p> <p>Play the forward side of the tape on a reversible deck.</p>	CD/MD/CD-R/DVD/LD player Cassette deck
⏸	Pause playback or recording.	CD/MD/CD-R/VCR/DVD/LD/DVR player/Cassette deck
▶	Start playback.	CD/MD/CD-R/VCR/DVD/LD/DVR player/Cassette deck
⏩	Hold down for fast forward playback.	CD/MD/CD-R/VCR/DVD/LD/DVR player/Cassette deck

Button (s)	Function	Components
◀◀	Hold down for fast reverse playback.	CD/MD/CD-R/VCR/DVD/LD/ DVR player/Cassette deck
■	Stops playback (on some models, pressing this when the disc is already stopped will cause the disc tray to open).	CD/MD/CD-R/VCR/DVD/LD/ DVR player/Cassette deck
Number buttons	Directly access tracks on a program source.	CD/MD/CD-R/VCR/LD player
	Use the number buttons to navigate the on-screen display.	DVD/DVR player
+10 button	Selects tracks higher than 10. (For example, press +10 then 3 to select track 13.)	CD/MD/CD-R/VCR/LD player
ENTER/ DISC	Changes the search mode.	DVD
	Chooses the disc.	Multiple CD player
	Use as the ENTER button.	VCR
	Displays the setup screen for DVR players.	DVR player
	Changes sides of the LD.	LD player
TOP MENU	Displays the disc 'top' menu of a DVD.	DVD/DVR player
MENU	Displays menus concerning the current DVD or DVR you are using.	DVD/DVR player
↑	Pauses the tape.	Cassette deck
↓	Stops the tape.	Cassette deck
ENTER	Starts playback.	Cassette deck
↔/⇒	Fast rewinds/fast forwards the tape.	Cassette deck
↔⇒↑↓ & ENTER	Navigates DVD menu/options.	DVD/DVR player
GUIDE	Displays/changes the subtitles on multilingual DVDs.	DVD/DVR player
CHANNEL +/-	Selects channels.	VCR/DVR player
AUDIO	Changes the audio language or channel.	DVD/DVR player

Preset Code List (VSX-D514/D714)

You should have no problem controlling a component if you find the manufacturer in this list, but please note that there are cases where codes for the manufacturer in the list will not work for the model that you are using. There are also cases where only certain functions may be controllable after assigning the proper preset code.



Note

- The TV, STB and DTV codes can only be set to the **TV/SAT** or **TV CONT** button.

DVD

Manufacturer Code

TOSHIBA 001
SONY 002
PANASONIC 003
JVC 004
SAMSUNG 005
SHARP 006
AKAI 007
RCA 009, 011
DENON 010
HITACHI 012
PHILIPS 013
ZENITH 014
THOMSON 015
SONY 016 (video game)
MICROSOFT
 017 (Videogame)
PIONEER 000, 008

LD

Manufacturer Code

SONY 101
PANASONIC 105, 106
PHILIPS 104
KENWOOD 103
RCA 107
PIONEER 100

TV TV/SAT TV CONT

Manufacturer Code

RCA 601, 615, 616, 617, 618
ZENITH 603, 620
MAGNAVOX 612, 629
GE 611, 628

PHILIPS 607

SONY 604
PANASONIC 608, 622
TOSHIBA 605, 626
SHARP 602, 619, 627
HITACHI 606, 624, 625
SANYO 621, 614
mitsubishi 609
GOLDSTAR 610, 623
JVC 613
FUNAI 658
AIWA 660
NEC 659
GRANDIENTE 630
PIONEER 600

STB (SATELLITE/ CATV) TV/SAT TV CONT

Manufacturer Code

JERROLD 701, 702, 703, 704, 711, 712, 713, 714, 715, 716
S.ATLANTA 705, 706, 708, 709
ZENITH 707, 717, 710
PIONEER 700, 718

On digital STB

TV/SAT TV CONT

Manufacturer Code

RCA 201, 203, 209
SONY 202
ECHOSTAR 205
PRIMESTAR 206
BELL 208
PIONEER 200

DTV TV/SAT TV CONT

Manufacturer Code

PIONEER 229, 207, 231, 232
PANASONIC 226, 230
VICTOR 227
TOSHIBA 228

TUNER

Manufacturer Code

PIONEER 500

VCR

Manufacturer Code

RCA 401, 413, 415
ZENITH 403
MAGNAVOX 414
FISHER 426, 412, 427
PANASONIC 408, 432, 433
TOSHIBA 405
JVC 428, 430, 429, 431, 407
HITACHI 406, 436, 434
SONY 416, 417, 404, 457, 458, 459
MITSUBISHI 409, 420, 421, 422, 423, 424
SANYO 410, 425, 435
SHARP 402, 418, 419
GOLDSTAR 411
GRADIENTE 441
PIONEER 400

DVD Recorder

Manufacturer Code

PIONEER 456

TAPE

Manufacturer Code

DENON 810
FISHER 813
JVC 802
PANASONIC 803
KENWOOD 804, 807
ONKYO 808, 809
SONY 801, 806
TEAC 805
YAMAHA 811, 812
PIONEER 800

CD

Manufacturer Code

DENON 309
JVC 303
PANASONIC 304, 326
KENWOOD 310, 311, 321
MARANTZ 323
ONKYO 320, 308, 307
PHILIPS 312, 322
RCA 302, 319
SANYO 313
SONY 301, 316, 317, 318
TEAC 305, 306, 327, 324, 325
YAMAHA 315, 314, 328
PIONEER 300

CD-R

Manufacturer Code

PHILIPS 346
PIONEER 345

MD

Manufacturer Code

SONY 901

KENWOOD 903

SHARP 902

TEAC 904

ONKYO 905

DENON 906

PIONEER 900, 907

Preset Code List (VSX-D814)

You should have no problem controlling a component if you find the manufacturer in this list, but please note that there are cases where codes for the manufacturer in the list will not work for the model that you are using. There are also cases where only certain functions may be controllable after assigning the proper preset code.



Note

- The **TV CONT** button will only accept preset codes for TV, STB andDTV.

DVD

Manufacturer Code

TOSHIBA 1010
SONY 1009
SAMSUNG 1008
JVC 1005
RCA 1007
DENON 1004
PHILIPS 1006
TOSHIBA 1010
YAMAHA 1011, 1012
PIONEER 1001, 1002, 1003

LD

Manufacturer Code

SONY 2008
PHILIPS 2006, 2007
PANASONIC 2005
KENWOOD 2004
DENON 2003
YAMAHA 2009
PIONEER 2001, 2002

TV

Manufacturer Code

PIONEER 5001, 5002, 5003,
 5004, 5005, 5006, 5007,
 5008, 5009, 5010
ADMIRAL 5011, 5012,
 5013
AIWA 5014, 5015
AKAI 5016
ALBA 5017
AOC 5018
BESTAR 5019
BLAUPUNKT 5020
BLUE SKY 5021
BRANDT 5022
BROCSONIC 5023
BUSH 5024

CLATRONIC 5025

CRAIG 5026, 5027, 5028,
 5029

CROSLEY 5030

CURTIS MATHIS
 5031, 5032, 5033

DAEWOO 5034, 5035,
 5036, 5037, 5038, 5039

DAYTRON 5040

DUAL 5041

EMERSON 5042,
 5043, 5044, 5045, 5046,
 5047, 5048

FERGUSON 5049, 5050

FIRST 5051

FISHER 5052

FUJITSU 5053

FUNAI 5054, 5055, 5056

GE 5057, 5058, 5059, 5060

GOLDSTAR 5061, 5062,
 5063, 5064

GOODMANS 5065, 5066

HITACHI 5067, 5068, 5069,
 5070, 5071

ICE 5072

IRRADIO 5073

ITT/NOKIA 5074, 5075

JC PENNY 5076, 5077,
 5078, 5079

JVC 5080, 5081

KENDO 5082

KTV 5083, 5084

LOEWE 5085

LXI 5086, 5087, 5088, 5089,
 5090

MAGNAVOX 5091

MARK 5092

MATSUI 5093, 5094

MATSUSHITA 5095, 5096

MEDION 5097

MITSUBISHI 5098, 5099

MIVAR 5100

NEC 5101, 5102

NOKIA OCEANIC 5103

NORDMENDE 5104, 5105

OKANO 5106

ONWA 5107

PANASONIC 5108, 5109,
 5110, 5111

PHILCO 5112, 5113, 5114

PHONOLA 5115

PORTLAND 5116, 5117

PROSCAN 5118

QUASAR 5119, 5120

RADIO 5121, 5122

RADIOSHACK 5123, 5124,
 5125

RADIOLA 5126

RCA/PROSCAN 5127,
 5128, 5129

SABA 5130

SAMSUNG 5131, 5132

SANYO 5133, 5134, 5135

SCHNEIDER 5136

SCOTT 5137, 5138

SHARP 5139, 5140

SIEMENS 5141

SIGNATURE 5142, 5143

SONY 5144, 5145

SYLVANIA 5146, 5147

SYMPHONIC 5148

TATUNG 5149

TELEFUNKEN 5150, 5151

THORN 5152

TOSHIBA 5153, 5154

UNIVERSUM 5155

VIDECH 5156, 5157

W. WHOUSE 5158

WARDS 5159, 5160, 5161

WATSON 5162

ZENITH 5163, 5164

VCR

Manufacturer Code

PIONEER 3001, 3002,
 3003, 3004, 3005
ADMIRAL 3006
AIWA 3007, 3008, 3009
AKAI 3010, 3011
ALBA 3012
AUDIO DYNAMIC 3013,
 3014
BELL&HOWELL 3015
BLAUPUNKT 3016, 3017
BROCSONIC 3018, 3019
BUSH 3020
CANON 3021
CGM 3022, 3023
CITIZEN 3024
CLATRONIC 3025
CRAIG 3026
CURTIS MATHIS 3027,
 3028, 3029
DAEWOO 3030, 3031,
 3032
DBX 3033, 3034
DIMENSIA 3035
EMERSON 3036,
 3037, 3038, 3039, 3040,
 3041
FERGUSON 3042
FISHER 3043, 3044, 3045,
 3046
FUNAI 3047, 3048
GE 3049, 3050, 3051
GOLDSTAR 3052
GOODMANS 3053, 3054
GRUNDIG 3055
HITACHI 3056, 3057, 3058,
 3059, 3060
INSTANT REPLAY 3061,
 3062
ITT/NOKIA 3063

JC PENNY 3064, 3065, 3066, 3067, 3068, 3069
JVC 3070, 3071, 3072
KENDO 3073
KENWOOD 3074, 3075, 3076
LOEWE 3077, 3078
LUXOR 3079
LXI 3080, 3081, 3082, 3083, 3084, 3085, 3088
MARANTZ 3087, 3088
MARTA 3089
MATSUI 3090
MEMOREX 3091, 3092
MINOLTA 3093, 3094
MITSUBISHI 3095, 3096, 3097, 3098, 3099
MULTITECH 3100, 3101, 3102
NEC 3103
NOKIA OCEANIC 3104
NOKIA 3105, 3106
NORDMENDE 3107
OKANO 3108
OLYMPIC 3109, 3110
ORION 3111
PANASONIC 3112, 3113, 3114, 3115, 3116, 3117
PENTAX 3118, 3119
PHILCO 3120, 3121
PHILIPS 3122
PHONOLA 3123
QUASAR 3124, 3125
RCA/PROSCAN 3126
REALISTIC 3127, 3128, 3129, 3130, 3131, 3132
SABA 3133
SAMSUNG 3134, 3135
SANSUI 3136
SANYO 3137, 3138
SCHNEIDER 3139, 3140

SCOTT 3141, 3142, 3143, 3144, 3145, 3146, 3147
SEG 3148
SELECO 3149
SHARP 3150, 3151, 3152
SIEMENS 3153, 3154, 3155
SIGNATURE 3156, 3157
SONY 3158, 3159, 3160, 3161, 3162, 3163
SYLVANIA 3164, 3165, 3166, 3167
SYMPHONIC 3168
TANDBERG 3169
TASHIRO 3170
TATUNG 3171, 3172
TEAC 3173, 3174, 3175
TECHNICS 3176, 3177
TELEFUNKEN 3178, 3179
THORN 3180, 3181
TOSHIBA 3182, 3183, 3184
UNIVERSUM 3185, 3186, 3187
W. WHOUSE 3188
WARDS 3189, 3190, 3191, 3192, 3193
YAMAHA 3194, 3195, 3196
ZENITH 3197

STB
Manufacturer Code
PIONEER 6001, 6002, 6003, 6004, 6005, 6006
BELL 6049
BLAUPUNKT 6007
ECHOSTAR 6047
GENERAL INSTRUMENT 6008
GOLDSTAR 6009
GRUNDIG 6010, 6011
HAMLIN 6012, 6013

HNS/HUGHES 6014
HITACHI 6015
ITT/NOKIA 6016
JERROLD 6017, 6018, 6019, 6020, 6021
NEC 6022, 6023
OAK 6024, 6025, 6026
PANASONIC 6027, 6028, 6029
PHILIPS 6030, 6031
PRIMESTAR 6048
RADIO SHACK 6032
RCA 6033
SAMSUNG 6034, 6035
SCIENTIFIC ATLANTA 6036, 6037, 6038
SIEMENS 6039, 6040
SONY 6041
TOSHIBA 6042, 6043
TOCOM 6044
ZENITH 6045, 6046

CD/CD-R

Manufacturer Code
PIONEER 7001, 7002
DENON 7003, 7004, 7005
FISHER 7006, 7007
JVC 7008, 7009, 7010, 7011
KENWOOD 7012, 7013, 7014, 7015, 7016
MAGNAVOX 7017, 7018
MARANTZ 7019
ONKYO 7020, 7021
PANASONIC 7022, 7023
PHILIPS 7024, 7025
RCA 7026, 7027
SANYO 7028
SHARP 7029
SONY 7030
TEAC 7031, 7032, 7033

TECHNICS 7034, 7035
YAMAHA 7036, 7037, 7038, 7039
DENON 7040, 7041
JVC 7042
KENWOOD 7043
PHILIPS 7044
SONY 7045

DVR

Manufacturer Code
PIONEER 4001

MD

Manufacturer Code
PIONEER 8001, 8002, 8003
DENON 8004
JVC 8005
KENWOOD 8006
SONY 8007
YAMAHA 8008, 8009

TAPE

Manufacturer Code
PIONEER 9001, 9002
DENON 9003, 9004
FISHER 9005, 9006
JVC 9007, 9008
KENWOOD 9009, 9010, 9011
NAKAMICHI 9012
ONKYO 9013, 9014, 9015
PHILIPS 9016, 9017
SONY 9018, 9019
TEAC 9020, 9021
TECHNICS 9022
YAMAHA 9023, 9024, 9025, 9026

Chapter 10: Additional information

Troubleshooting

Incorrect operations are often mistaken for trouble and malfunctions. If you think that there is something wrong with this component, check the points below. Sometimes the trouble may lie in another component. Investigate the other components and electrical appliances being used. If the trouble cannot be rectified even after exercising the checks listed below, ask your nearest Pioneer authorized service center or your dealer to carry out repair work.

Problem	Remedy
The power does not turn on.	<ul style="list-style-type: none"> • Connect the power plug to the wall outlet. • Disconnect the power plug from the outlet, and insert again. • Make sure there are no loose strands of speaker wire touching the rear panel. This could cause the receiver to shut off automatically. • If the power shuts off automatically, take the unit to your nearest Pioneer authorized service center or your dealer for servicing. • The unit may have been switched on using the wrong voltage setting. Make sure you switch the VOLTAGE SELECTOR on the rear panel to the right voltage for your country or region, then reset the unit (page 72) before switching on again.
No sound is output when a function is selected.	<ul style="list-style-type: none"> • Make sure the component is connected correctly (refer to <i>Connecting up</i> on page 14). • Press MUTE on the remote control to turn muting off. • Adjust the MASTER VOLUME.
No image is output when a function is selected.	<ul style="list-style-type: none"> • Make sure the component is connected correctly (refer to <i>Connecting up</i> on page 14). • Select the correct component (use the MULTI CONTROL buttons).

Problem	Remedy
Considerable noise in radio broadcasts.	<ul style="list-style-type: none"> • Tune in the correct frequency. • Connect the antenna (refer to page 19). • Route any loose cables away from the antenna terminals and wires. • Fully extend the FM wire antenna, position for best reception, and secure to a wall. • Connect an outdoor FM antenna (refer to page 19). • Adjust the direction and position for best reception. • Connect an additional internal or external AM antenna (refer to page 19). • Turn off the equipment causing the noise or move it away from the receiver. • Move antennas farther away from equipment causing the noise.
Broadcast stations cannot be selected automatically.	<ul style="list-style-type: none"> • Connect an outdoor antenna (refer to page 19).
No sound from surround or center speakers.	<ul style="list-style-type: none"> • Refer to <i>Speaker setting</i> on page 46 to check the speaker settings. • <i>VSX-D714/D814 only</i> – Refer to <i>Manually calibrating your listening area (MCACC)</i> on page 52 to check the speaker levels. • Connect the speakers properly (refer to page 20).
No sound from surround back speakers (<i>VSX-D714/D814 only</i>).	<ul style="list-style-type: none"> • Refer to <i>Surround back speaker setting</i> on page 46 to check the surround back speaker settings. • Refer to <i>Manually calibrating your listening area (MCACC)</i> on page 52 to check the speaker levels. • Refer to <i>Using the Surround Back Channel (SB CH)</i> on page 39 to make sure the SB CH MODE and the sound mode are set for surround back sound.
No sound from subwoofer.	<ul style="list-style-type: none"> • Make sure the subwoofer is switched on. • If the subwoofer has a volume knob, make sure it's turned up. • Switch the <i>Subwoofer setting</i> on page 47 to YES or PLUS. • Switch the <i>LFE attenuator setting</i> on page 47 to 0 dB or 10 dB. • The Dolby Digital or DTS source you are listening to does not have an LFE channel.
Noise during playback of a cassette deck.	<ul style="list-style-type: none"> • Move the cassette deck further from your receiver, until the noise disappears.
Sound is produced from other components, but not from LD or DVD player.	<ul style="list-style-type: none"> • Set the SIGNAL SELECT to AUTO, DIGITAL or ANALOG according to the type of connections made. (refer to page 38). • Set the digital input settings correctly (refer to page 50). • Make digital connections (refer to page 15) and set the SIGNAL SELECT to DIGITAL (refer to page 38). • Refer to the instruction manual supplied with the DVD player.

Problem	Remedy
No sound is output or a noise is output when software with DTS is played back.	<ul style="list-style-type: none"> Set the digital volume level of the player to full, or to the neutral position.
When a search is performed by a DTS compatible CD player during playback, noise is output.	<ul style="list-style-type: none"> This is not a malfunction, but be sure to turn the volume down to prevent the output of loud noise from your speakers.
Can't operate the remote control.	<ul style="list-style-type: none"> Replace the batteries (refer to page 5). Operate within 7 m, 30° of the remote sensor on the front panel (refer to page 6). Remove the obstacle or operate from another position. Avoid exposing the remote sensor on the front panel to direct light.
The display is dark or off.	<ul style="list-style-type: none"> Press FL DIMMER on the remote control repeatedly to return to the default.



Note

- If the unit does not operate normally due to external effects such as static electricity disconnect the power plug from the outlet and insert again to return to normal operating conditions.

Resetting the main unit

Use this procedure to reset all the receiver's settings to the factory default. Use the front panel controls to do this.

- Switch the receiver on.**
- While holding down the TONE button, press and hold the \odot STANDBY/ON button for about three seconds.**
- When you see RESET? appear in the display, press the TONE button.**
OK? shows in the display.
- Press TONE once more to confirm.**
OK appears in the display to indicate that the receiver has been reset to the factory default settings.

Switching the speaker impedance

We recommend using speakers of 8 Ω with this system, but it is possible to switch the impedance setting if you plan to use speakers with a 6 Ω impedance rating.

- With the receiver in standby, press \odot STANDBY/ON while holding down the SPEAKERS / SPEAKER IMPEDANCE button.** Each time you do this, you switch between the impedance settings:
 - SP 6 OHM** – Use this setting if your speakers are rated at 6 Ω .
 - SP 8 OHM** – Use this setting if your speakers are rated at 8 Ω or more.

Specifications

Amplifier section

Continuous power output (stereo)

Front 100 W (DIN 1kHz, THD 1.0%, 8 Ω)

Continuous power output (surround)

Front 100 W per channel (1kHz, 1.0%, 8 Ω)

Center 100 W (1kHz, 1.0%, 8 Ω)

Surround 100 W per channel
(1kHz, 1.0%, 8 Ω)

Surround Back. 100 W (1kHz, 1.0 %, 8 Ω)
(VSX-D814 only)

Audio section

Input (Sensitivity/Impedance)

CD, DVR/VCR, CD-R/TAPE/MD,
DVD/LD, TV/SAT. 200 mV/47 kΩ

Frequency response

CD, DVR/VCR, CD-R/TAPE/MD, DVD/LD,
TV/SAT 5 Hz to 100,000 Hz ± 3 dB

Output (Level/Impedance)

DVR/VCR REC, CD-R/TAPE/
MD REC 200 mV/2.2 kΩ

Tone control

Bass ± 6 dB (100 Hz)

Treble ± 6 dB (10 kHz)

Loudness +6.5 dB/+3 dB (100 Hz/10 kHz)
(at volume level -50 dB)

Signal-to-Noise Ratio

DIN (Continuous rated power output / 50mW)

CD, DVR/VCR, CD-R/TAPE/MD,
DVD/LD, TV/SAT.88/64 dB

Signal-to-Noise Ratio

(IHF, short circuited, A network)

CD, DVR/VCR, CD-R/TAPE/MD,
DVD/LD, TV/SAT96 dB

Signal-to Noise Ratio

[EIA, at 1 W (1 kHz)]

CD, DVR/VCR, CD-R/TAPE/MD,
DVD/LD, TV/SAT79 dB

Video Section

Input (Sensitivity/Impedance)

DVR/VCR, DVD/LD, TV/SAT1 Vp-p/75 Ω

Output (Level/Impedance)

DVR/VCR, MONITOR OUT1 Vp-p/75 Ω

Frequency response

DVR/VCR, DVD/LD,
TV/SAT \Rightarrow MONITOR5 Hz to 7 MHz ± 3 dB
Signal-to-Noise Ratio55 dB

Component video section

VSX-D714/D814 only

Input (Sensitivity)

DVD/LD, TV/SAT1 Vp-p/75 Ω

Output (Level/Impedance)

MONITOR OUT1 Vp-p/75 Ω

Frequency response

DVD/LD,
TV/SAT \Rightarrow MONITOR5 Hz to 40 MHz ± 3 dB
Signal-to-Noise Ratio55 dB

FM Tuner Section

Frequency Range	87.5 MHz to 108 MHz
Usable Sensitivity	Mono: 13.2 dBf, IHF (1.3 μ V/ 75 Ω)
50 dB Quieting Sensitivity	Mono: 20.2 dB Stereo: 38.6 dBf
Signal-to-Noise Ratio	Mono: 73 dB (at 85 dBf) Stereo: 70 dB (at 85 dBf)
Distortion	Stereo: 0.5 % (1 kHz)
Alternate Channel Selectivity	60 dB (400 kHz)
Stereo Separation	40 dB (1 kHz)
Frequency Response	30 Hz to 15 kHz (\pm 1 dB)
Antenna Input (DIN)	75 Ω unbalanced

AM Tuner Section

Frequency Range	9kHz step: 531 kHz to 1,602 kHz 10kHz step: 530 kHz to 1,700 kHz
Sensitivity (IHF, Loop antenna)	350 μ V/m
Selectivity	25 dB
Signal-to-Noise Ratio	50 dB
Antenna	Loop antenna

Miscellaneous

Power requirements	AC 110/120–127/220/ 240 V (switchable), 50/60Hz
Power consumption:	
VSX-D514/D714:	
Singapore/Malaysia models	250 W
All other models	500 W
VSX-D814	
Singapore/Malaysia models	280 W
All other models	600 W
In standby	0.9 W
Dimensions	420 (W) x 158 (H) x 401 (D) mm
Weight (without package)	
VSX-D514	10.0 kg
VSX-D714/D814	10.6 kg

Furnished Parts

AM loop antenna	1
FM wire antenna	1
Dry cell batteries (AA size IEC R6)	2
Remote control	1
Power cords:	
VSX-D514/D714/D814-K (black models)	2
(Round 2-pin type and Australian type)	
VSX-D514/D714-S (silver models – Except Australian model)	3
(Round 2-pin type, flat blade 2-pin type and UK 3-pin type)	
VSX-D814-S (silver model)	4
(Round 2-pin type, flat blade 2-pin type, UK 3-pin type and Australian type)	
Power plug adaptor (VSX-D514/D714/D814-K only)	1
J-shape plug (VSX-D514/D714/D814-K only)	1
These operating instructions	1



Note

- Specifications and the design are subject to possible modifications without notice, due to improvements.

Cleaning the unit

- Use a polishing cloth or dry cloth to wipe off dust and dirt.
- When the surface is dirty, wipe with a soft cloth dipped in some neutral cleanser diluted five or six times with water, and wrung out well, and then wipe again with a dry cloth. Do not use furniture wax or cleansers.
- Never use thinners, benzene, insecticide sprays or other chemicals on or near this unit, since these will corrode the surface.

Published by Pioneer Corporation
Copyright©2004 Pioneer Corporation
All rights reserved

PIONEER CORPORATION

4-1, Meguro 1-Chome, Meguro-ku, Tokyo 153-8654, Japan

PIONEER ELECTRONICS (USA) INC.

P.O. BOX 1540, Long Beach, California 90810-1540, U.S.A. TEL: (800) 421-1404

PIONEER ELECTRONICS OF CANADA, INC.

300 Allstate Parkway, Markham, Ontario L3R OP2, Canada TEL: (905) 479-4411

PIONEER EUROPE NV

Haven 1087, Keetberglaan 1, B-9120 Melsele, Belgium TEL: 03/570.05.11

PIONEER ELECTRONICS ASIACENTRE PTE. LTD.

253 Alexandra Road, #04-01, Singapore 159936 TEL: 65-6472-7555

PIONEER ELECTRONICS AUSTRALIA PTY. LTD.

178-184 Boundary Road, Braeside, Victoria 3195, Australia, TEL: (03) 9586-6300

PIONEER ELECTRONICS DE MEXICO S.A. DE C.V.

Bldv.Manuel Avila Camacho 138 10 piso Col.Lomas de Chapultepec, Mexico,D.F. 11000 TEL: 55-9178-4270

K002E

Free Manuals Download Website

<http://myh66.com>

<http://usermanuals.us>

<http://www.somanuals.com>

<http://www.4manuals.cc>

<http://www.manual-lib.com>

<http://www.404manual.com>

<http://www.luxmanual.com>

<http://aubethermostatmanual.com>

Golf course search by state

<http://golfingnear.com>

Email search by domain

<http://emailbydomain.com>

Auto manuals search

<http://auto.somanuals.com>

TV manuals search

<http://tv.somanuals.com>