

***Pioneer***

**AUDIO/VIDEO  
MULTI-CHANNEL RECEIVER**

**VSX-D909S**

**Operating Instructions**

Thank you for buying this Pioneer product. Please read through these operating instructions so you will know how to operate your model properly. After you have finished reading the instructions, put them away in a safe place for future reference.

## [For U.S. model] IMPORTANT NOTICE

The serial number for this equipment is located on the rear panel. Please write this serial number on your enclosed warranty card and keep it in a secure area. This is for your security.

**WARNING: TO PREVENT FIRE OR SHOCK HAZARD, DO NOT EXPOSE THIS APPLIANCE TO RAIN OR MOISTURE.**

THE STANDBY/ON BUTTON IS SECONDARY CONNECTED AND THEREFORE DOES NOT SEPARATE THE UNIT FROM MAINS POWER IN STANDBY POSITION.

## IMPORTANT



The lightning flash with arrowhead symbol, within an equilateral triangle, is intended to alert the user to the presence of uninsulated "dangerous voltage" within the product's enclosure that may be of sufficient magnitude to constitute a risk of electric shock to persons.

### CAUTION

**RISK OF ELECTRIC SHOCK  
DO NOT OPEN**

CAUTION: TO PREVENT THE RISK OF ELECTRIC SHOCK, DO NOT REMOVE COVER (OR BACK). NO USER-SERVICEABLE PARTS INSIDE. REFER SERVICING TO QUALIFIED SERVICE PERSONNEL.



The exclamation point within an equilateral triangle is intended to alert the user to the presence of important operating and maintenance (servicing) instructions in the literature accompanying the appliance.

**NOTE:** This equipment has been tested and found to comply with the limits for a Class B digital device, pursuant to Part 15 of the FCC Rules. These limits are designed to provide reasonable protection against harmful interference in a residential installation. This equipment generates, uses, and can radiate radio frequency energy and, if not installed and used in accordance with the instructions, may cause harmful interference to radio communications. However, there is no guarantee that interference will not occur in a particular installation. If this equipment does cause harmful interference to radio or television reception, which can be determined by turning the equipment off and on, the user is encouraged to try to correct the interference by one or more of the following measures:

- Reorient or relocate the receiving antenna.
- Increase the separation between the equipment and receiver.
- Connect the equipment into an outlet on a circuit different from that to which the receiver is connected.
- Consult the dealer or an experienced radio/TV technician for help.

### Information to User

Alteration or modifications carried out without appropriate authorization may invalidate the user's right to operate the equipment.

#### [For Canadian model]

This Class B digital apparatus complies with Canadian ICES-003.

#### [Pour le modèle Canadien]

Cet appareil numérique de la classe B est conforme à la norme NMB-003 du Canada.

### [For Canadian model]

**CAUTION: TO PREVENT ELECTRIC SHOCK, DO NOT USE THIS (POLARIZED) PLUG WITH AN EXTENSION CORD, RECEPTACLE OR OTHER OUTLET UNLESS THE BLADES CAN BE FULLY INSERTED TO PREVENT BLADE EXPOSURE.**

**ATTENTION: POUR PREVENIR LES CHOCs ELECTRIQUES NE PAS UTILISER CETTE FICHE POLARISEE AVEC UN PROLONGATEUR, UNE PRISE DE COURANT OU UNE AUTRE SORTIE DE COURANT, SAUF SI LES LAMES PEUVENT ETRE INSERES A FOND SANS EN LAISSER AUCUNE PARTIE A DECOUVERT.**

**ATTENTION: AFIN DE PREVENIR TOUS RISQUES DE CHOC ELECTRIQUE OU DE DEBUT D'ENCENDIE, NE PAS EXPOSER CET APPAREIL A L'HUMIDITE OU A LA PLUIE.**

LE BOUTON STANDBY/ON EST RACCORDE SECONDAIREMENT ET PAR CONSEQUENT NE SEPRE PAS L'APPAREIL DE L'ALIMENTATION SECTEUR SUR LA POSITION D'ATTENTE.

[For U.S. model]



As an ENERGY STAR® Partner, Pioneer Corporation has determined that this product meets the ENERGY STAR® guidelines for energy efficiency.

K001 En

# IMPORTANT SAFETY INSTRUCTIONS

**READ INSTRUCTIONS** — All the safety and operating instructions should be read before the product is operated.

**RETAIN INSTRUCTIONS** — The safety and operating instructions should be retained for future reference.

**HEED WARNINGS** — All warnings on the product and in the operating instructions should be adhered to.

**FOLLOW INSTRUCTIONS** — All operating and use instructions should be followed.

**CLEANING** — Unplug this product from the wall outlet before cleaning. The product should be cleaned only with a polishing cloth or a soft dry cloth. Never clean with furniture wax, benzene, insecticides or other volatile liquids since they may corrode the cabinet.

**ATTACHMENTS** — Do not use attachments not recommended by the product manufacturer as they may cause hazards.

**WATER AND MOISTURE** — Do not use this product near water — for example, near a bathtub, wash bowl, kitchen sink, or laundry tub; in a wet basement; or near a swimming pool; and the like.

**ACCESSORIES** — Do not place this product on an unstable cart, stand, tripod, bracket, or table. The product may fall, causing serious injury to a child or adult, and serious damage to the product. Use only with a cart, stand, tripod, bracket, or table recommended by the manufacturer, or sold with the product. Any mounting of the product should follow the manufacturer's instructions, and should use a mounting accessory recommended by the manufacturer.

**CART** — A product and cart combination should be moved with care. Quick stops, excessive force, and uneven surfaces may cause the product and cart combination to overturn.



**VENTILATION** — Slots and openings in the cabinet are provided for ventilation and to ensure reliable operation of the product and to protect it from overheating, and these openings must not be blocked or covered. The openings should never be blocked by placing the product on a bed, sofa, rug, or other similar surface. This product should not be placed in a built-in installation such as a bookcase or rack unless proper ventilation is provided or the manufacturer's instructions have been adhered to.

**POWER SOURCES** — This product should be operated only from the type of power source indicated on the marking label. If you are not sure of the type of power supply to your home, consult your product dealer or local power company.

**LOCATION** — The appliance should be installed in a stable location.

**NONUSE PERIODS** — The power cord of the appliance should be unplugged from the outlet when left un-used for a long period of time.

## GROUNDING OR POLARIZATION

- If this product is equipped with a polarized alternating current line plug (a plug having one blade wider than the other), it will fit into the outlet only one way. This is a safety feature. If you are unable to insert the plug fully into the outlet, try reversing the plug. If the plug should still fail to fit, contact your electrician to replace your obsolete outlet. Do not defeat the safety purpose of the polarized plug.

- If this product is equipped with a three-wire grounding type plug, a plug having a third (grounding) pin, it will only fit into a grounding type power outlet. This is a safety feature. If you are unable to insert the plug into the outlet, contact your electrician to replace your obsolete outlet. Do not defeat the safety purpose of the grounding type plug.

**POWER-CORD PROTECTION** — Power-supply cords should be routed so that they are not likely to be walked on or pinched by items placed upon or against them, paying particular attention to cords at plugs, convenience receptacles, and the point where they exit from the product.

**OUTDOOR ANTENNA GROUNDING** — If an outside antenna or cable system is connected to the product, be sure the antenna or cable system is grounded so as to provide some protection against voltage surges and built-up static charges. Article 810 of the National Electrical Code, ANSI/NFPA 70, provides information with regard to proper grounding of the mast and supporting structure, grounding of the lead-in wire to an antenna discharge unit, size of grounding conductors, location of antenna-discharge unit, connection to grounding electrodes, and requirements for the grounding electrode. See Figure A.

**LIGHTNING** — For added protection for this product during a lightning storm, or when it is left unattended and unused for long periods of time, unplug it from the wall outlet and disconnect the antenna or cable system. This will prevent damage to the product due to lightning and power-line surges.

**POWER LINES** — An outside antenna system should not be located in the vicinity of overhead power lines or other electric light or power circuits, or where it can fall into such power lines or circuits. When installing an outside antenna system, extreme care should be taken to keep from touching such power lines or circuits as contact with them might be fatal.

**OVERLOADING** — Do not overload wall outlets, extension cords, or integral convenience receptacles as this can result in a risk of fire or electric shock.

**OBJECT AND LIQUID ENTRY** — Never push objects of any kind into this product through openings as they may touch dangerous voltage points or short-out parts that could result in a fire or electric shock. Never spill liquid of any kind on the product.

**SERVICING** — Do not attempt to service this product yourself as opening or removing covers may expose you to dangerous voltage or other hazards. Refer all servicing to qualified service personnel.

**DAMAGE REQUIRING SERVICE** — Unplug this product from the wall outlet and refer servicing to qualified service personnel under the following conditions:

- When the power-supply cord or plug is damaged.
- If liquid has been spilled, or objects have fallen into the product.
- If the product has been exposed to rain or water.
- If the product does not operate normally by following the operating instructions. Adjust only those controls that are covered by the operating instructions as an improper adjustment of other controls may result in damage and will often require extensive work by a qualified technician to restore the product to its normal operation.
- If the product has been dropped or damaged in any way.
- When the product exhibits a distinct change in performance — this indicates a need for service.

**REPLACEMENT PARTS** — When replacement parts are required, be sure the service technician has used replacement parts specified by the manufacturer or have the same characteristics as the original part. Unauthorized substitutions may result in fire, electric shock, or other hazards.

**SAFETY CHECK** — Upon completion of any service or repairs to this product, ask the service technician to perform safety checks to determine that the product is in proper operating condition.

**WALL OR CEILING MOUNTING** — The product should not be mounted to a wall or ceiling.

**HEAT** — The product should be situated away from heat sources such as radiators, heat registers, stoves, or other products (including amplifiers) that produce heat.

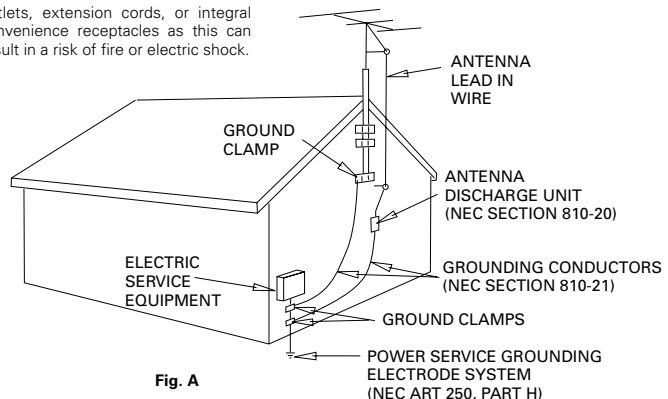

Fig. A

NEC — NATIONAL ELECTRICAL CODE



## 2 Speaker Connections

Home theater is designed to be setup with five, or seven speakers (front left & right; center; surround left & right; and, optimally, surround back left & right) and a subwoofer but you can use this receiver with fewer speakers. Hook up the speakers you have to the (A) speaker terminals on the back of the receiver. If you only have two speakers hook them up as "FRONT." If you have three hook up the single speaker as "CENTER." Follow the diagram on p.19 in order to hook up all your speakers. A center speaker is very important for watching films because the dialog comes from the center speaker in digital soundtracks. **If you do not have a CENTER speaker you must tell the receiver the CENTER channel is OFF or when you listen to digital soundtracks you won't hear any dialog.** Use the instructions on page 32-33 in order to do this.

Follow the diagram below to hook up an additional amplifier in order to use surround back speakers. These speakers are important to hear all the sound channels on new, eight channel home theater DVDs. The diagram below also explains how to hook up a subwoofer which provides realistic bass sounds.

Make sure you connect the speaker on the right to the right terminal and the speaker on the left to the left terminal. Also make sure the positive and negative (+/-) terminals on the amplifier match those on the speakers.

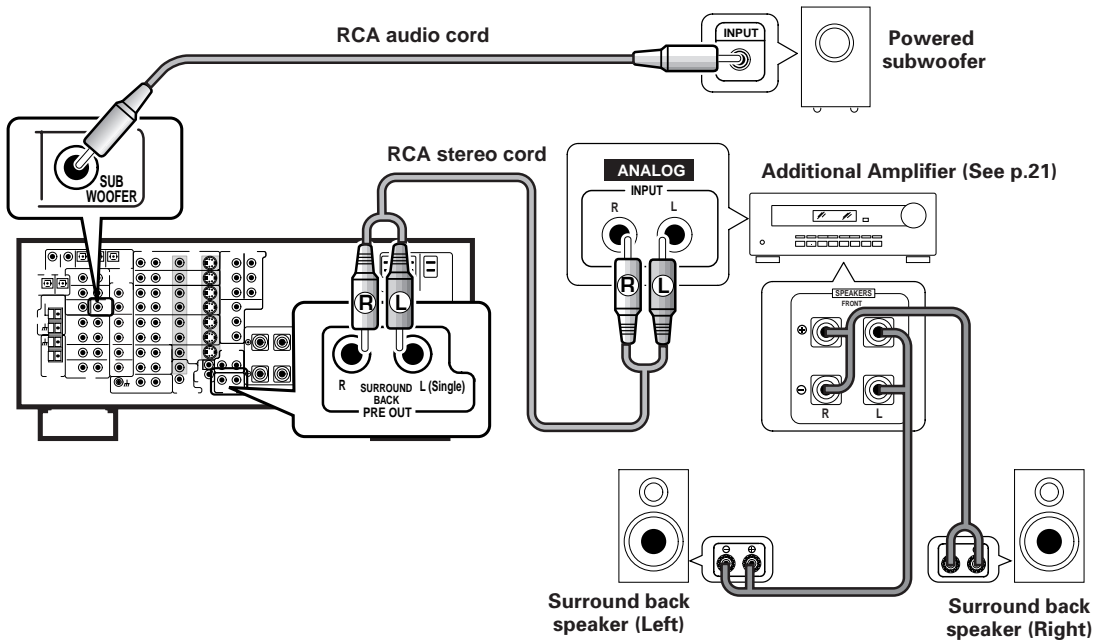

## 3 Setting up the Remote Control & Unit

- 1 Put the batteries in the REMOTE CONTROL.
- 2 Plug the main unit into a wall outlet.
- 3 Press the  STANDBY/ON button on the receiver to put the receiver in ON mode.

## 4 Digital Input Assignment

This is only necessary if you did not hook up your DVD to DIGITAL IN 1, as in the first diagram on p. IV

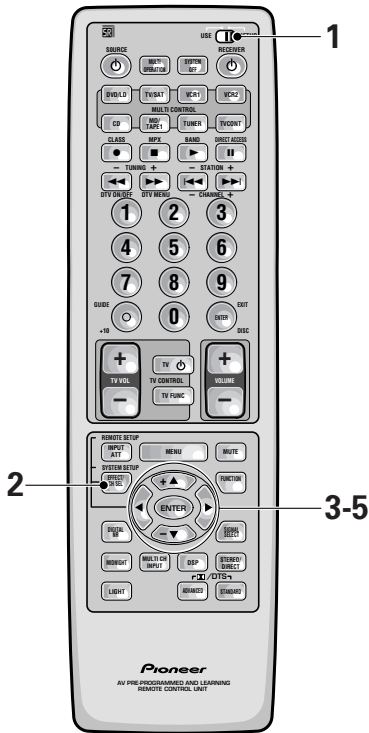

### 1 Set the remote control slide switch to **SETUP**.

Also make sure your TV is on and set to the receiver.

- When you're done setting up the receiver, remember to set the slide switch back to **USE**.

### 2 Press the **SYSTEM SETUP** button.

You should see the following display on your TV.

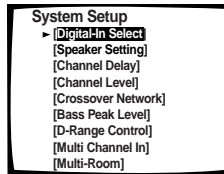

- You can escape from this screen at any time by pressing the **SYSTEM SETUP** button again. None of the settings you made will be entered in this case.
- If don't enter any settings the receiver will revert back to its previous state after three minutes.

### 3 Digital in Select should be selected (if it isn't use the **▲/▼** buttons to select it). Press **ENTER**.

You should see the following display on your TV.

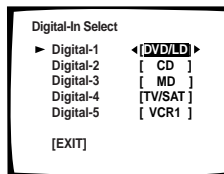

### 4 Choose the Digital-3 you hooked up your DVD player to and assign "DVD/LD" to it.

Use the **◀** or **▶** buttons to choose the DVD/LD setting.

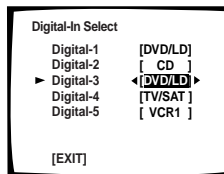

### 5 Select **EXIT** with **▲/▼** buttons and press **ENTER** to return to the **SYSTEM SETUP MENU**.

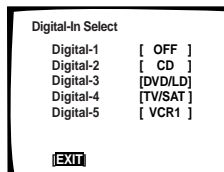

## 5 Playing a DVD with Surround Sound



- 1 Turn on the receiver, your TV, and the DVD player.
- 2 Set the remote control slide switch to **USE**. Press the **DVD/LD** button on the remote control. You should see "DVD/LD" in the display on the receiver.
- 3 Press the **STANDARD** button for the basic surround sound setting.
- 4 Play a DVD.

## 6 For Better Surround Sound

- 1 Go through the entire "system setup" procedures as outlined on pages 12-21 of this instruction manual.

If you don't hook up any other components with digital audio or do so following the default settings of the receiver (see page 14) you won't have to assign any more digital inputs, but many other adjustments will improve the sound tremendously.

- 2 Experiment with the different sound settings offered with the **DSP/DTS** and **DSP** buttons.

For more information see pages 41-45.

- 3 As mentioned above you should go through the "speaker setup" instructions on pages 28-40 to set up your speakers properly. If you don't do this you, at least, need to make sure the **CENTER** channel is turned off if you don't have a center speaker. Use the instructions on pages 29-33.

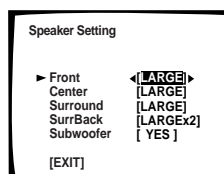

# Features

## Multi Channel Stereophonic Concept

The VSX-D909S receiver is constructed with Pioneer's industry-leading multi channel stereophonic concept. This well-developed approach to receiver circuitry takes the high level base technology that, up until now, has been only used for stereo equipment and applies it to multi-channel audio-visual receivers. The result is that the product, in addition to being expertly built, and gives you optimal sound reproduction of DVDs, other multi channel sources and stereo sources as well. This receiver is designed capture to a true reproduction of the intentions of a filmmaker or music producer at the time they were mastering the soundtrack in the studio. It incorporates 5 independent 100 watt built in power amplifiers, with high-performance Hex power Direct Power MOS FET output transistors. This construction provides improved linearity and accurate representation of each channel for true high fidelity reproduction from even the most demanding Dolby Digital and DTS program sources. All these elements consolidated in one receiver afford the listener a new surround sound experience in his or her home.

## Universal Player Compatibility

This receiver incorporates the latest technology and is able to handle cutting edge audio formats, like DVD Audio, which are just hitting the market. Its high compatibility offers a variety of inputs to decode all types of sources at the highest possible quality. The receiver's multi channel in connections lets you hook up eight discrete channels of audio. It also has multi channel direct inputs and the ability to decode the cutting edge formats.

## Decoding of Next Generation Digital Source Film Formats

This receiver has the ability to decode Dolby Digital, Dolby Pro Logic and DTS (Digital Theater Systems) sources, which are the standards of home theater today. It also offers component video terminals for the sharpest video transmission available to the consumer.

*Manufactured under license from Dolby Laboratories. "Dolby", "AC-3", "Pro Logic", and double-D symbol are trademarks of Dolby Laboratories. Confidential unpublished works. © 1992 - 1997 Dolby Laboratories. All rights reserved.*

*"DTS" and "DTS Digital Surround" are trademarks of Digital Theater Systems, Inc. Manufactured under licence from Digital Theater Systems, Inc.*

## Advanced Theater Modes & DSP Surround Modes

Advanced Theater modes enhance the sound of either film or music so a more dramatic effect can be achieved. The four modes are each designed to accentuate specific sound qualities, giving the listener a wide range of possibilities. DSP (Digital Signal Processing) surround modes give you the capability of transforming your living room into seven different sonic environments when listening to music.

## Midnight Mode, Digital Noise Reduction & 7 Channel Tone Control

The Midnight mode allows you to obtain excellent surround sound effects even when listening at low volumes, something that was previously impossible. Digital noise reduction filters out unwanted noise from recordings to give you a clearer sound and the 7 channel tone control allows you to adjust the treble and bass of each channel individually to suit your listening tastes.

## Remote Control with Illuminated Buttons

This new remote control is extremely convenient to use. Its buttons can be easily viewed as they illuminate when functions are preformed. In addition, one button can perform many tasks on this remote because of the Use and Setup switch, which allows different uses for the same button in the different settings. This remote can be used to operate a variety of other components simply by recalling the appropriate setup codes or by using the learning function to teach the remote control new commands. In addition, the multi-operation functions allow you to perform a variety of operations automatically.

## The Energy-saving Design

This unit is designed to use less than 1 W of energy when the receiver is in standby mode.



# Table of Contents

<b>Before You Start .....</b>	<b>10</b>	<b>Remote Control of Other Components ..</b>	<b>58</b>
Checking the Supplied Accessories .....	10	Setting Up the Remote Control to Control Other	
How to Use This Manual .....	10	Components .....	58
Preparing the Remote Control .....	10	Using the Remote Control with Other Components ..	
Installing the Receiver .....	11	.....	62
Opening the Front Panel .....	11		
<b>Connecting Your Equipment .....</b>	<b>12</b>	<b>Using Other Functions .....</b>	<b>69</b>
Audio Components .....	12	Recording from Audio Components .....	69
Digital Connections .....	13	Recording from Digital Audio Components .....	70
Example Connection for a DVD/LD or LD player ....	14	Recording from Video Components .....	70
Video Components .....	15	Multi Operations .....	71
Satellite TV Components .....	16	System Off.....	73
TV .....	17	Setting Up the Direct Function .....	74
Multi Channel Input (External Decoder) .....	17	Remote Back Light .....	75
Connecting the Radio Antennas .....	18	Resetting the Remote Control .....	75
Speakers .....	19	Erasing Learned Remote Control Commands .....	76
Placing Your Speakers .....	20	Erasing All Learned Commands and Preset Codes ...	76
Connecting Additional Amplifiers .....	21	Video Select .....	77
Plugging In .....	21	Multi-Room .....	78
<b>Displays &amp; Controls .....</b>	<b>22</b>	<b>Techno Tidbits &amp; Problem-solving ...</b>	<b>83</b>
Front Panel .....	22	Dolby Digital .....	83
Display .....	25	DTS .....	84
Remote Control .....	26	Preset Code List .....	84
<b>Initial Set Up .....</b>	<b>28</b>	Troubleshooting .....	85
On Screen Display .....	28	Specifications .....	89
Setting Up for Surround Sound .....	29		
<b>Basic Playback .....</b>	<b>41</b>		
Sound Modes .....	41		
Selecting a Sound Mode .....	44		
Playing Sources with			
Dolby Digital or DTS Sound .....	45		
Playing Stereo Sources .....	46		
Switching Analog and Digital Signal Input .....	47		
Reducing Noise During Playback .....	48		
Listening in Midnight Mode .....	49		
Listening the Loudness Mode .....	49		
Adjusting Bass and Treble .....	50		
MULTI CHANNEL IN Playback .....	51		
96kHz 24bit Performance .....	51		
Direct Playback .....	52		
Adjusting the Brightness of the Display .....	52		
DUAL MONO Setting .....	53		
<b>Using the Tuner .....</b>	<b>54</b>		
Automatic and Manual Tuning .....	54		
Direct Access Tuning .....	55		
Memorizing Frequently Used Stations .....	56		
Recalling Memorized Stations .....	57		

# Before You Start

## Checking the Supplied Accessories

Please check that you have received all of the following supplied accessories.



FM wire Antenna



AM loop Antenna

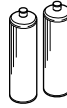

"AA" IEC LR6  
batteries x 2

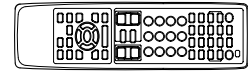

Remote Control Unit  
• Operating Instructions

## How to Use This Manual

This manual is for the VSX-D909S Audio/Video Multi-Channel Receiver.

This manual is divided into three main sections which will tell you how to setup and use the unit :

### PREPARATION

First carry out the tasks below in this "Before You Start" section to prepare the remote control, then connect the receiver to your other components as described in "Connecting Your Equipment" (p.12). Take special care to connect your digital equipment like DVDs and LDs properly to be able to take advantage of the receiver's surround sound systems (p.13-14). To learn about a specific button, control, or indicator, see "Displays & Controls" starting on p.22.

### SET UP

Performing the tasks in "Initial Set Up" (from p.28) is essential to get proper surround sound.

### OPERATION

To play some music or soundtrack refer to "Basic Playback" on p.41. "Using the Tuner" (p.54) explains how to use the radio of this unit. Doing the operations in "Remote Control of Other Components" (p.58) is highly recommended so you can use this unit's remote control for all your components. "Using Other Functions" (p.69) explain the other possibilities of the receiver.

"Techno Tidbits & Problem-solving" (p.83) provide detailed technical information and a troubleshooting guide.

The following marks and symbols are used throughout the manual:



Provides additional information, precautions, and advice.



Indicates a blinking button, indicator, or display.



Indicates a steadily lit button, indicator, or display.

## Preparing the Remote Control

### Loading the batteries

Load the batteries into the remote control as shown below. Please use alkaline batteries. When you notice a decrease in the operating range of the remote control, replace all batteries with new ones.

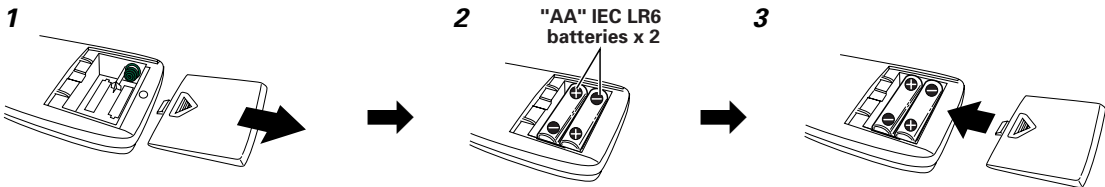

### CAUTION!

Incorrect use of batteries may result in such hazards as leakage and bursting. Observe the following precautions.

- Never use new and old batteries together.
- Insert the plus and minus sides of the batteries properly according to the marks in the battery case.
- Batteries with the same shape may have different voltages. Do not use different batteries together.
- When disposing of used batteries, please comply with governmental regulations or environmental public institution's rules that apply in your country / area.

## Operating range of remote control unit

The area in which you can use the remote control to operate the VSX-D909S is fairly large. To use, point the remote control toward the remote sensor on the front panel of this unit while within the range shown right.

Remote control may not function properly if:

- There are obstacles between the remote control and the remote sensor.
- Direct sunlight or fluorescent light is shining onto the remote sensor.
- The receiver located near a device emitting infrared rays.
- Operated simultaneously with another remote control which uses infrared rays.

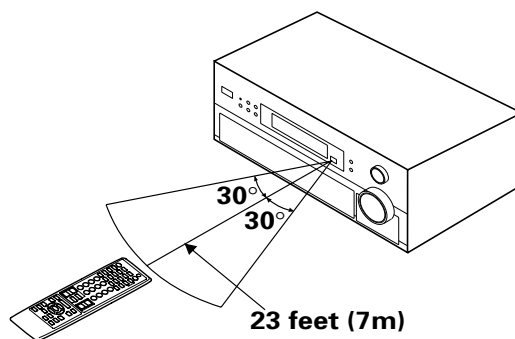

## Installing the Receiver

Please note:

- Do not place objects directly on top of this unit. This would prevent proper heat dispersal.
- When installing in a rack, shelf, etc., be sure to leave more than 8 inches of space above the receiver.

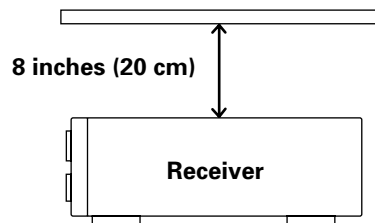

## Opening the Front Panel

To open the front panel push gently on the lower third of the panel with your finger.

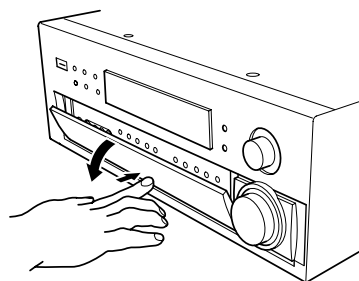

# Connecting Your Equipment

## Audio Components

To begin set up connect your audio components to the jacks as shown below. These are all analog connections and your analog audio components (turntable, cassette deck) use these jacks. Remember that for components you want to record with you need to hook up four plugs (a set of stereo ins and a set of stereo outs), but for components that only play (like a turntable) you only need to hook up one set of stereo plugs (two plugs). To use DTS or Dolby Digital surround sound features you must hook up your digital components to the digital inputs (see p.13). We also recommend hooking up your digital components to analog audio jacks. If you want to record to/from digital components (like an MD) to/from analog components you must hook up your digital equipment with these analog connections. See p.13 & 14 for more on digital connections.

Before making or changing the connections, switch off the power and disconnect the power cord from the AC wall outlet.

\*The arrows indicate the direction of the audio signal.

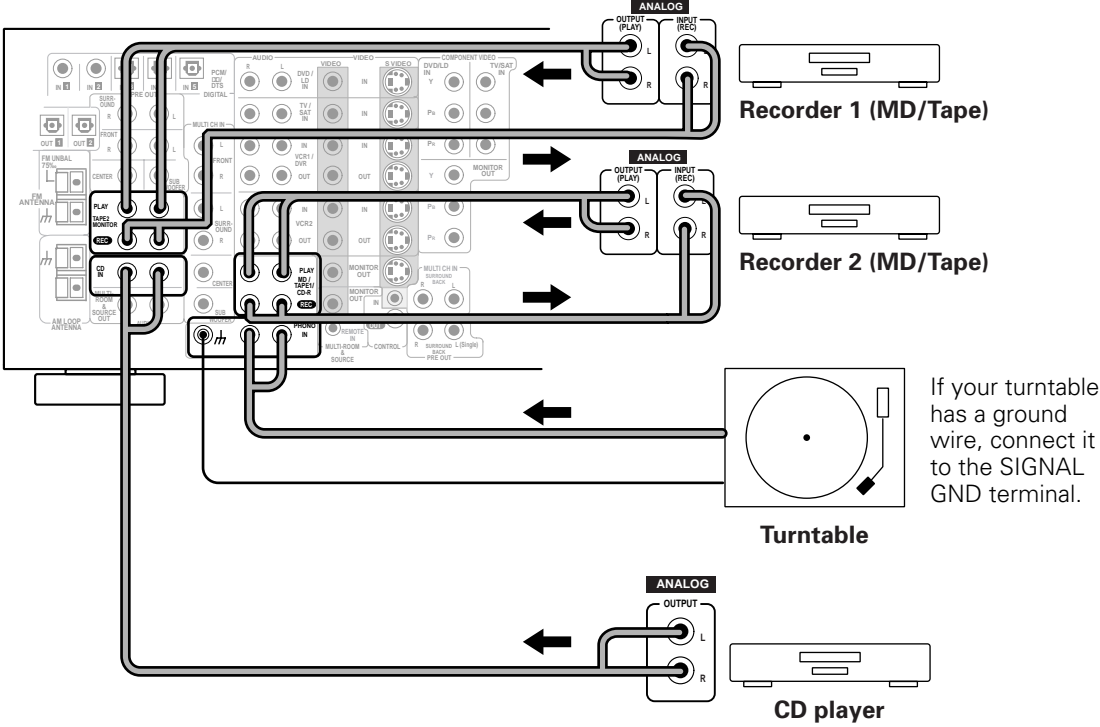

Please don't hook up any other component to the phono jacks other than a turntable. It could damage the equipment. If your turntable has a built-in amplifier please hook it up to an input other than PHONO.

**■ Analog audio/video cords**  
Use audio/video cords (not supplied) to make analog audio and video connections.

Connect red plugs to R (right) and white plugs to L (left).  
Be sure to insert completely.

### Cassette deck placement

Depending on where the cassette deck is placed, noise may occur during playback of your cassette deck which is caused by leakage flux from the transformer in the receiver. If you experience noise, move the cassette deck farther away from the receiver.

## Digital Connections

In order to use Dolby Digital/DTS soundtracks which are at the heart of home theater you need to make digital audio connections. You can do this by either a coaxial or an optical connection (you don't need to do both). The quality of these two types of connections is the same but since some digital components only have one type of digital terminal, it is a matter of matching like with like (for example, the coaxial out from the component to coaxial in on the receiver). The VSX-D909S has two coaxial and three optical inputs for a total of five digital inputs. If possible hook up your digital equipment in accordance with this receiver's default settings, see "Digital Input Assignment" (see.p.14) below left in order to do this. We also recommend hooking up your digital components to analog audio jacks in order to make recording from some digital sources which may be copy protected.

Connect your digital components as shown below.

There are two optical digital out jacks (the MD recorder is connected to one in the diagram below). If you connect this to the optical input on a digital recorder (currently these include MD, DAT and CD-R) you can make direct digital recordings with this unit.

Before making or changing the connections, switch off the power and disconnect the power cord from the AC wall outlet.

\*The arrows indicate the direction of the audio signal.

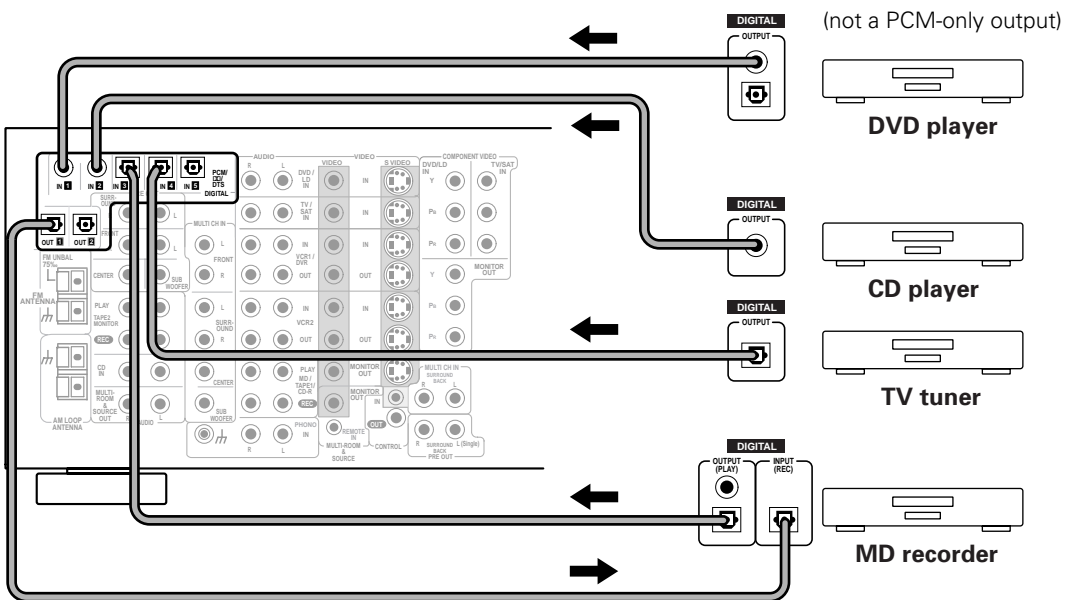

### ■ Coaxial cords/Optical cables

Commercially available digital audio coaxial cords (standard video cords can also be used) or optical cables (not supplied) are used to connect digital components to this receiver.

When you use optical digital input or output terminals, pull off the caps and insert the plugs. Be sure to insert completely.

Coaxial cord  
(or standard video cord)

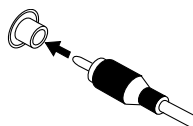

Optical cable

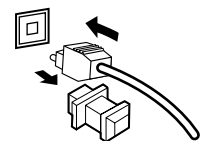

## Connecting Your Equipment

### Example Connection for a DVD/LD or LD player

To connect a DVD/LD player or LD player with its RF output, a commercially available RF demodulator (RFD-1) is required. The RF demodulator changes the RF signal to a digital signal which is then processed by the VSX-D909S model through their digital input jacks. For more details, refer to the instruction manual supplied with the RFD-1.

We also recommend hooking up your digital components to analog audio jacks.

Before making or changing the connections, switch off the power and disconnect the power cord from the AC wall outlet.

\*The arrows indicate the direction of the audio signal.

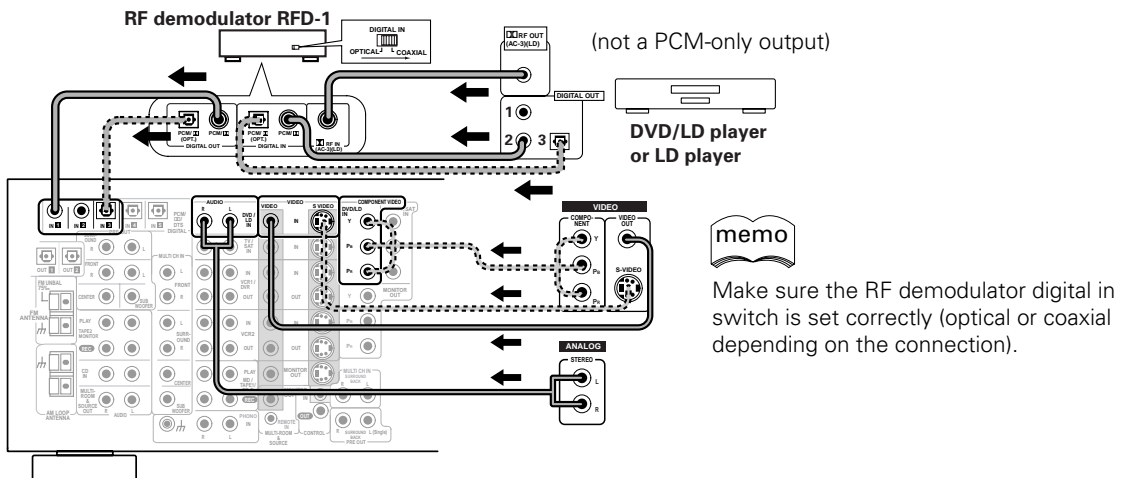

### Digital Input Assignment

Unlike analog connections, the jacks for digital connections are not dedicated to one type of component, they can be used freely. Thus you must tell the receiver what digital component in which jack so your components will be in sync with the names on the remote control buttons and the like. To avoid having to assign the digital inputs you can hook up your equipment in accordance with the receiver's default settings.

The default settings are:

DIGITAL IN 1: DVD/LD

DIGITAL IN 2: CD

DIGITAL IN 3: MD

DIGITAL IN 4: TV/SAT

DIGITAL IN 5: VCR1

You will notice that Digital IN 1, for example, is a coaxial jack. If your DVD/LD player only has an optical out jack on it then you won't be able to hook up your components in accordance with the VSX-D909S default setting. In this case you will need to assign the digital inputs. See Digital-In Select on p.31 in order to do this.

## Video Components

Connect your video components to the jacks as shown below. Regarding a DVD there are two types of connections to make. Hook up your video signal with either component video, S-video, or composite video cords (the quality descends in this order) but remember, the video component you are watching and your TV must be hooked up with same type of video cord or you won't be able to see the picture. For the audio signal, order to use Dolby Digital/DTS you must hook up a digital input. It is also a good idea to hook up your DVD components with analog audio connections as well, since some DVDs may not have a digital audio track. To cover all possible laser discs a DVD/LD player or LD player requires an analog connection and a digital connection (a coaxial or optical shown at the very top of the first diagram below). Before making or changing the connections, switch off the power and disconnect the power cord from the AC wall outlet.

\*The arrows indicate the direction of the video signal.

### Connecting DVD/LD players

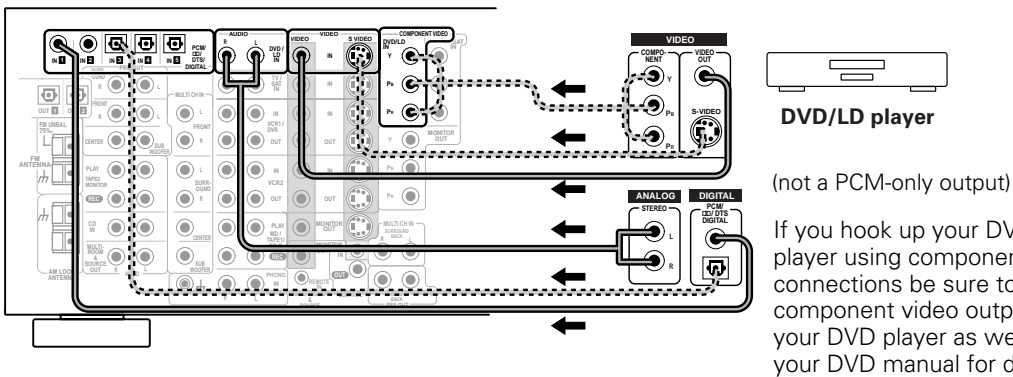

### Connecting VCRs or DVRs

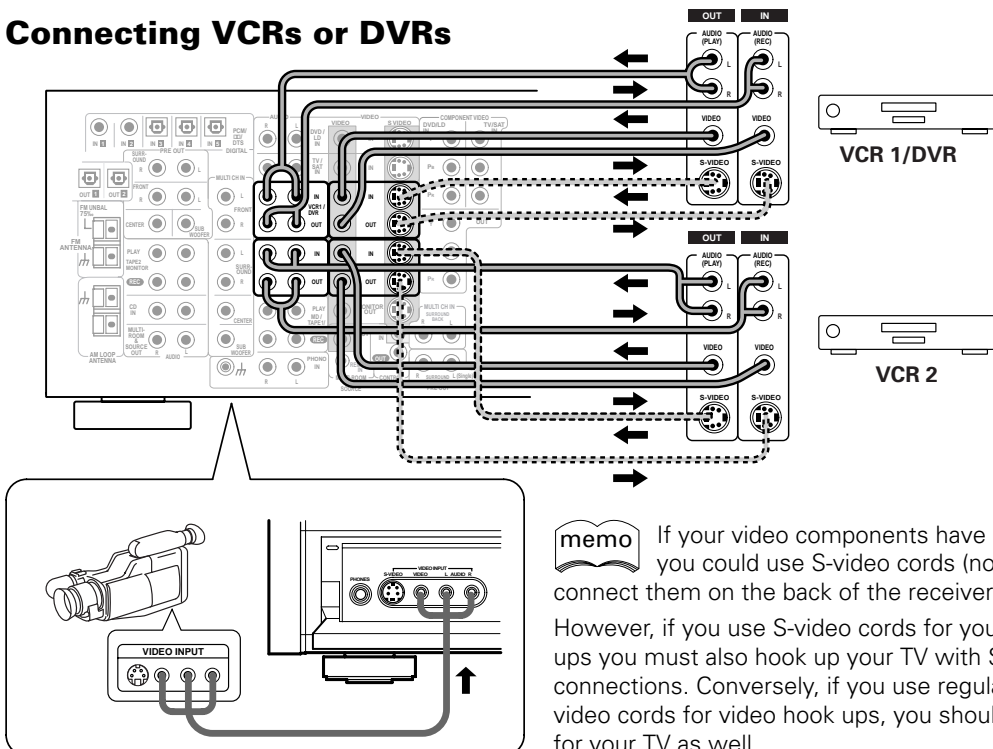

Front video connections are accessed via the front panel input selector as "VIDEO."

# Satellite TV Components

Connect your satellite TV components to the jacks as shown below. Hook up the video signal with either component video, S-video, or composite video cords (the quality descends in this order) but remember, the video component you are watching and your TV must be hooked up with same type of video cord or you won't be able to see the picture. For the audio signal, order to use digital soundtracks (sometimes broadcast over digital satellite TV) you must hook up a digital input. Use either a coaxial or optical cables, it doesn't matter which (you don't need to use both). It's also a good idea to hook up your audio with analog cables (see below). This connection is called STEREO AUDIO OUT in the diagram. Before making or changing the connections, switch off the power and disconnect the power cord from the AC wall outlet.

\*The arrows indicate the direction of the TV signal.

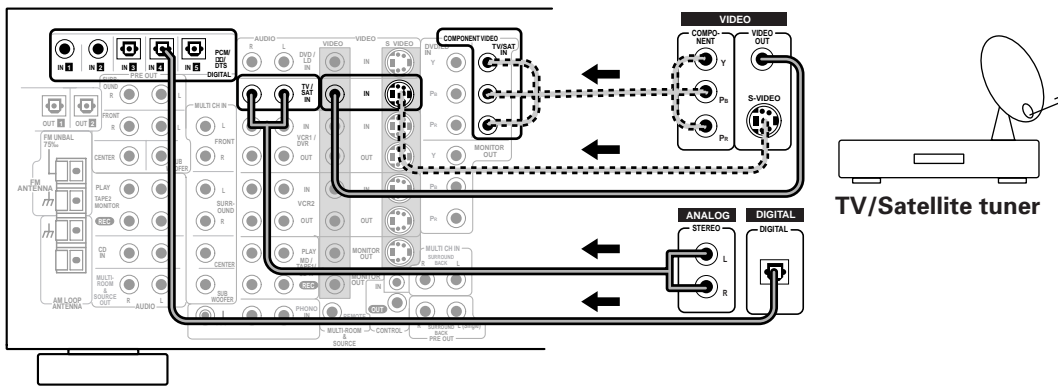

### ■ Analog audio/video cords

Use audio/video cords (not supplied) to connect the video components and a video cord to connect the monitor TV.

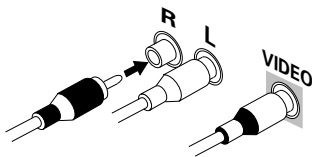

Connect red plugs to R (right), white plugs to L (left), and the yellow plugs to VIDEO.

Be sure to insert completely.

### ■ Digital audio coaxial cords/ Optical cables

Commercially available digital audio coaxial cords (standard video cords can also be used) or optical cables (not supplied) are used to connect digital components to this receiver.

When you use optical digital input or output terminals, pull off the caps and insert the plugs. Be sure to insert completely.

**Digital audio coaxial cord  
(or standard video cord)**

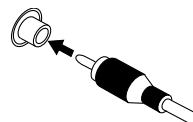

**Optical cable**

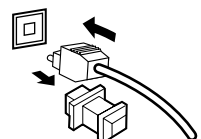



## TV

Connect your TV to the jacks as shown below. Hook up the signal with either component video, S-video, or composite video cords (the quality descends in this order) but remember, the video component you are watching and your TV must be hooked up with same type of video cord or you won't be able to see the picture. Before making or changing the connections, switch off the power and disconnect the power cord from the AC wall outlet.

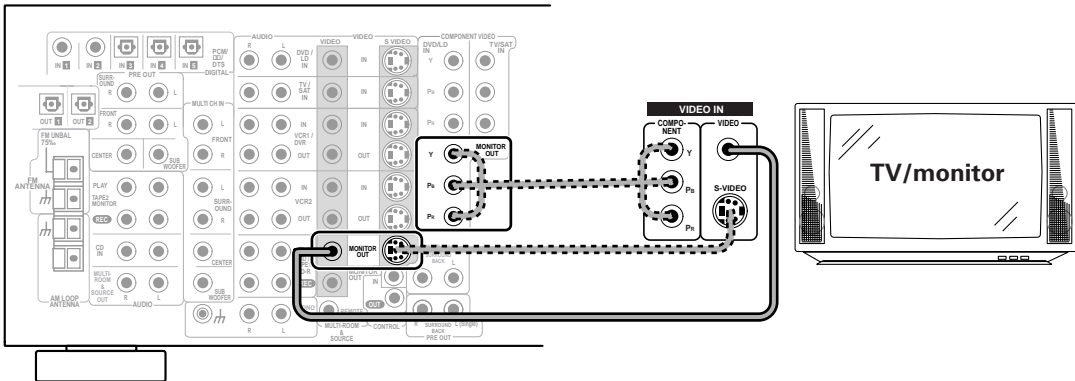

The COMPONENT VIDEO OUT jack can be used to get a TV picture but it doesn't show this receiver's on screen display (OSD).  
If you use S video cords to hook up a component the OSDs from the receiver will only be able to be seen on the S video out terminals.

## Multi Channel Input (External Decoder)

In some cases you may want to have your source material (DVD, etc) decoded externally. If you find you need a multi channel external decoder hook one up as shown below, but for most people this component is unnecessary (For more on this see p.51).

Before making or changing the connections, switch off the power and disconnect the power cord from the AC wall outlet.

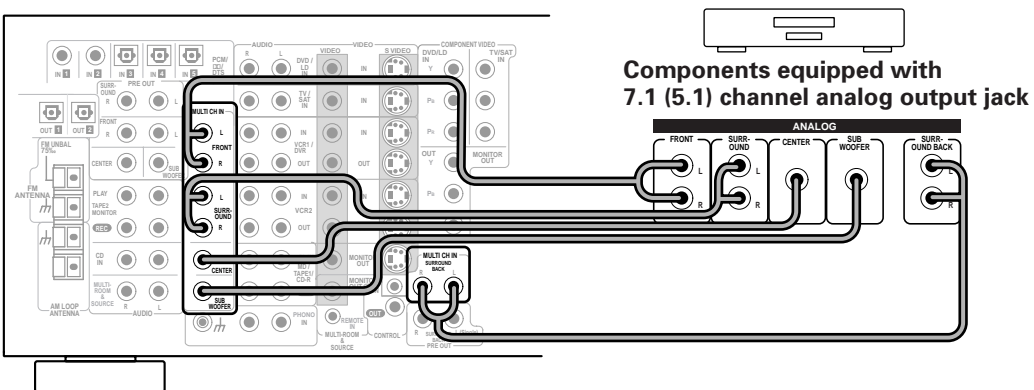

## Connecting the Radio Antennas

Connect the supplied FM wire antenna and the AM loop antenna to the antenna terminals as shown below. These antennas should provide adequate reception quality in most cases, but connecting outdoor antennas should noticeably improve sound quality.

Before making or changing the connections, switch off the power and disconnect the power cord from the AC wall outlet.

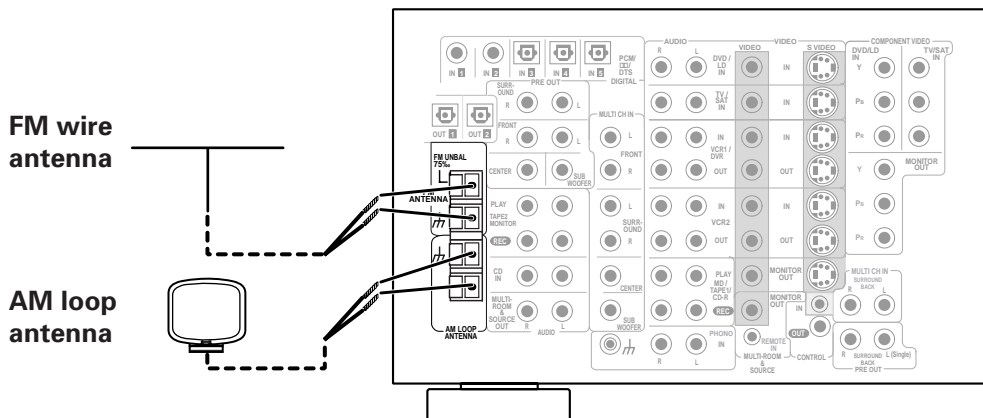

### ■ AM loop antenna

- ① Assemble the antenna.
- ② Twist exposed wire strands together and insert.
- ③ Attach to a wall, etc. (if desired) and face toward the direction providing the best reception.

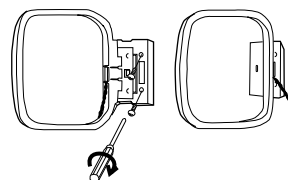
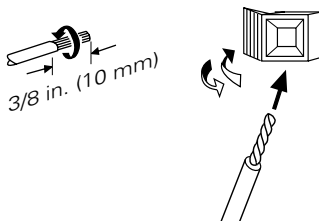
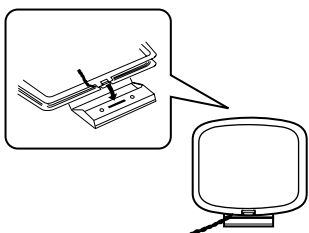

### Using external antennas

#### ■ To improve FM reception

Connect an external FM antenna.

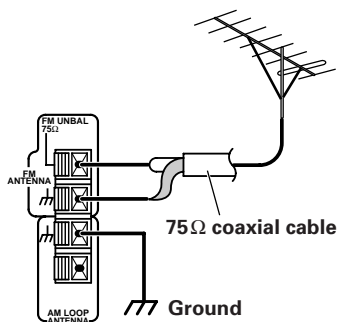

#### ■ To improve AM reception

Connect a 15-18 feet (5-6 meter) length of vinyl-coated wire to the AM antenna terminal in addition to the supplied AM loop antenna.

For best possible reception, suspend horizontally outdoors.

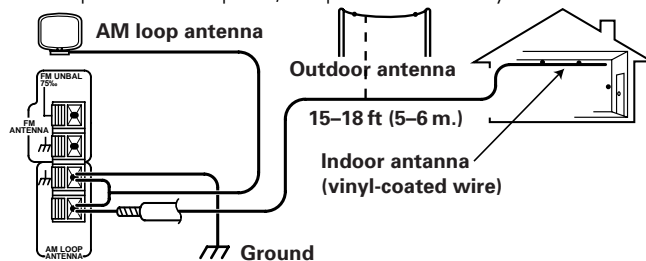

# Speakers

A full complement of eight speakers is shown here but, naturally, everyone's home set up will vary. Simply connect the speakers you have in the manner described below. The receiver will work with just two stereo speakers (called "front" speakers in the diagram) but the receiver is designed to be used with at least three speakers.

One of the latest features of home theater is the use of SURROUND BACK speakers. These speakers add even greater realism in movie sound effects and new discs with soundtracks in Dolby Digital or DTS incorporates these channels. In order to be able to use these channels you must hook your SURROUND BACK speakers up to an external amplifier and then connect that to the VSX-D909S, as shown in the diagram below. If you only have one SURROUND BACK speaker hook it up to the SURROUND BACK L (SINGLE) terminal on the back of the receiver.

In general, make sure you connect the speaker on the right to the right terminal and the speaker on the left to the left terminal. Also make sure the positive and negative (+/-) terminals on the receiver match those on the speakers. Before making or changing the connections, switch off the power and disconnect the power cord from the AC wall outlet.



The receiver has two speaker systems, A & B. A is the main system supporting the full complement of surround sound speakers. If you switch on both A & B speaker systems, only front speakers and the subwoofer will be audible. No sound will come from the center or surround speakers but multi channel sources will be down-mixed to the active speakers so no sound will be lost. Similarly, if you choose just the B system you'll only hear the front speakers connected to the B system and multi channel sources will be down-mixed to these two speakers. About speaker impedance, see the following page.

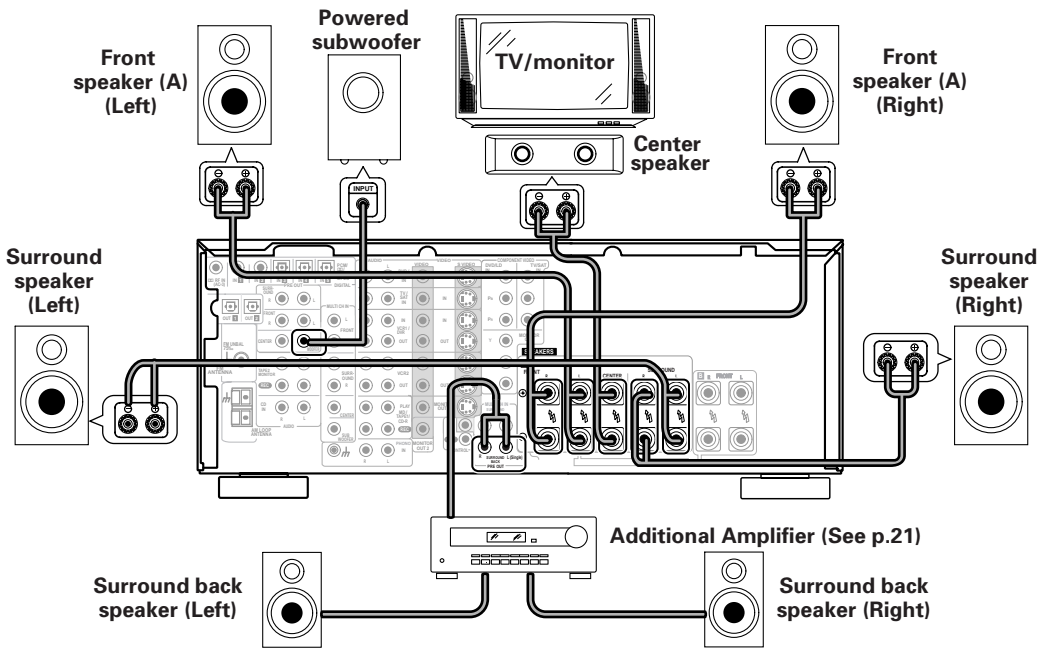

## ■ Speaker terminals

- ① Twist exposed wire strands together.
- ② Loosen speaker terminal and insert exposed wire.
- ③ Tighten terminal.

3/8 in. (10 mm)

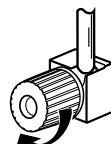
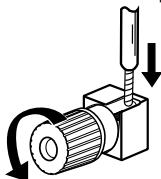
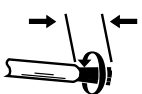

The speaker terminals also accept single banana plugs. (Refer to speaker manual for details.)

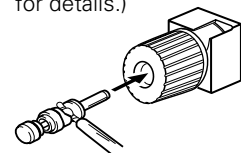

## Connecting Your Equipment

### Speaker impedance

You can change the speaker impedance but we recommend using speakers with an impedance of 8Ω-16Ω (the default setting). If you are using 6Ω- less than 8Ω impedance speakers, you need to change the impedance setting.

⏻ STANDBY/ON

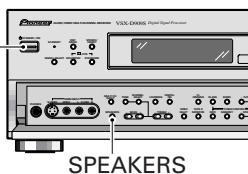

To check which impedance setting to hold down the SPEAKERS button for 2-3 seconds. You'll get a display like these telling you the speaker impedance setting.

**First turn the receiver off, then press the ⏻STANDBY/ON button while holding down the SPEAKERS button.**

Choose the impedance setting by pressing the SPEAKERS button again. You can choose the 8Ω-16Ω setting or the 6Ω-8Ω setting.

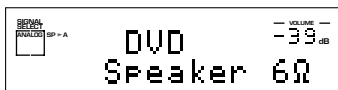

(This display indicates a 6Ω-less than 8Ω impedance setting.)

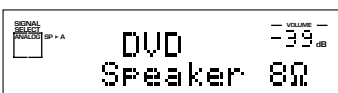

(This display indicates an 8Ω-16Ω impedance setting.)

## Placing Your Speakers

Proper speaker placement is essential to realize the best sound from your system. The diagram and tips given here are just a rough guide; be sure to read the instructions that come with your speakers.

### Speaker placement

If you have a multiple speaker arrangement the placement of the speakers is extremely important. To achieve the best possible surround sound, install your speakers as shown below. Make sure all speakers are installed securely to prevent accidents and improve sound quality. Be sure to consult your speaker manuals for the best placement of the speakers. Some speakers are designed to be floor-standing but others benefit greatly from speakers stands which raise them off the floor.

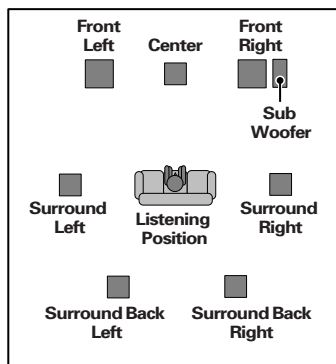

- Install the left and right front speakers at equal distances from the TV.
- When installing speakers near the TV, we recommend using magnetically shielded speakers to prevent possible interference such as distortion in the color of the TV screen. If you do not have magnetically shielded speakers and notice discoloration of the TV screen, place the speakers farther away from the TV.
- Install the center speaker above or below the TV so that the sound of the center channel is localized at the TV screen.

#### CAUTION:

When installing the center speaker on top of the TV, be sure to secure it with tape or some other suitable means. Otherwise, the speaker may fall from the TV due to external shocks such as earthquakes, and it may lead to endangering those nearby or damaging the speaker

- If possible, install the surround speakers slightly above ear level.
- It may be difficult to obtain a cohesive surround effect if the surround speakers are installed farther away from the listening position than the front and center speakers.

## Connecting Additional Amplifiers

To hook up surround back speakers you need to use an additional amplifier. Other than for that purpose this receiver has more than sufficient power for any home use, but it is possible to add additional amplifiers to every channel of your system. Make the connections shown below to add amplifiers to power your speakers. Before making or changing the connections, switch off the power and disconnect the power cord from the AC wall outlet.

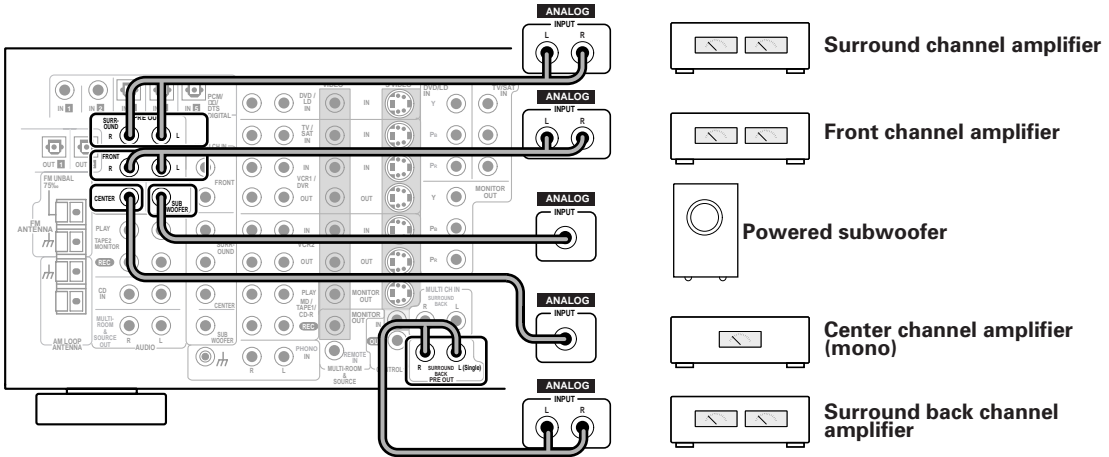

You can use the additional amplifier on the surround back channels for a single speaker as well. In this case plug the amplifier into the L (SINGLE) terminal only.

## Plugging In

Up to three components can be powered from this receiver. Two of the outlets are switched, which means that power is switched on and off with the receiver. The third is unswitched, which means that power is delivered so long as the receiver is plugged in.

Before making or changing the connections, switch off the power and disconnect the power cord from the AC wall outlet.

After connecting all your components, plug the receiver's power cord into a standard wall power outlet.

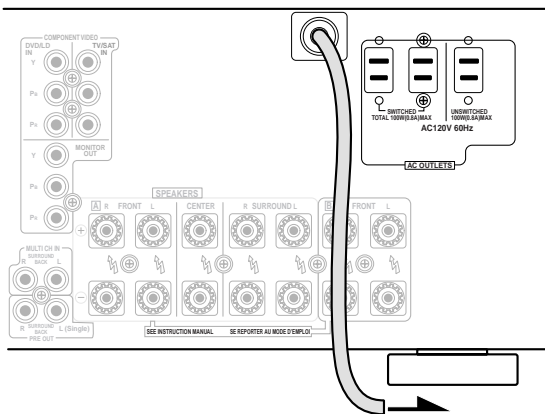

**Caution!**  
Do not connect a monitor or TV to this unit's AC OUTLETS.

### Caution!

Power consumption of any equipment connected to the **switched** power outlets should not exceed **100W (0.8 A)**.

Power consumption of any equipment connected to the **unswitched** power outlet should not exceed **100W (0.8 A)**.

To avoid overheating, fire risk and possible malfunction, do not connect high-wattage appliances such as heaters, irons, monitors or TV sets to this units AC outlets.

Disconnect the receiver from the power outlet when it's not in regular use, for example, when on vacation.

# Displays & Controls

## Front Panel

All the controls on the front panel are explained and/or referenced here. To open the front panel push gently on the lower third of the panel.

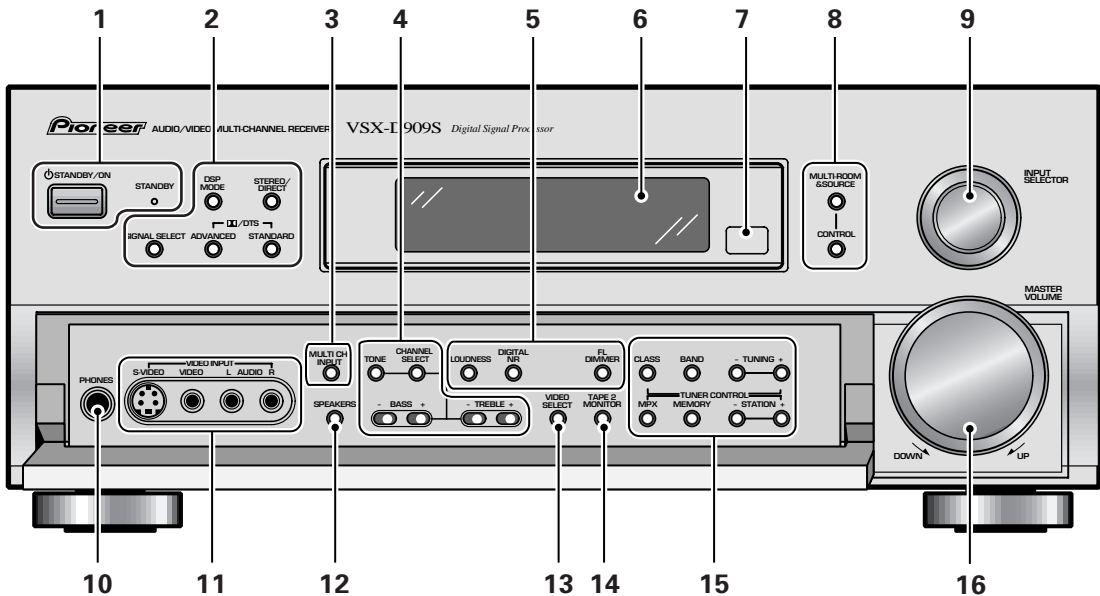

### 1 STANDBY/ON button

Press to switch the receiver ON or into STANDBY mode.

#### STANDBY indicator

Lights when the receiver is in STANDBY mode. (Please note that this receiver consumes a small amount of power [1.0 W] in the standby mode.)

### 2 **DSP MODE button (See p.43 & 44)**

Press repeatedly to select a DSP sound mode. (HALL 1, HALL 2, JAZZ, DANCE, THEATER 1, or THEATER 2, 5/7CH STEREO). Use these modes to produce surround sound from standard (two channel) stereo sources and create different listening environments.

#### STEREO/DIRECT button (See p.43 & 52)

Switches the receiver into STEREO mode if it was in a different sound mode (like DSP mode) or toggles between DIRECT and STEREO mode. For more on STEREO mode see p.52

DIRECT playback bypasses the tone controls, DIGITAL NR, LOUDNESS, MIDNIGHT and channel level for the most accurate reproduction of a program source.

### SIGNAL SELECT button (See p.47)

Use to select the type of signal being input into the receiver. Press SIGNAL SELECT repeatedly to select one of the following:

**ANALOG** – To select an analog signal.

**DIGITAL** – To select a optical or coaxial digital signal.

**AUTO** – This is the default. If there are analog and digital signals input, the receiver automatically selects the digital signal.

#### / DTS buttons (See p.41-45, 83, 84)

**ADVANCED** – Use to select one of the four Advanced Theater modes. Use to create certain types of sound environments when listening to Dolby Digital, Dolby Pro Logic or DTS sources.

**STANDARD** – Use for pure decoding of multi channel sources, especially Dolby Digital, Dolby Pro Logic or DTS sources. Each press toggles between STANDARD and STANDARD 7.1 mode (for use with SURROUND BACK speakers). Those with surround back speakers can use two STANDARD modes, those without can only use the STANDARD mode.

**3 MULTI CH INPUT (See p.40, 51)**

Use to hook up an external component that can decode other types of signals and input them into the VSX-D909S.

**4 TONE control buttons**

**TONE button**

This button has two functions. Firstly, it switches between TONE ON and TONE BYPASS, which bypasses the tone circuitry. Secondly, you need to press the button before using the CHANNEL SELECT buttons to adjust the BASS & TREBLE (cannot be used in MULTI CH IN mode).

**CHANNEL SELECT button**

Switches the tone adjust controls between the FRONT, CENTER, SURROUND and SURROUND BACK speakers. You can then use the BASS and TREBLE controls to adjust the sound.

**BASS (-/+ ) button (See p.50)**

Use to adjust low frequencies.

**TREBLE (-/+ ) button (See p.50)**

Use to adjust the high frequencies.

**5 LOUDNESS button (See p.49)**

Switches the LOUDNESS mode on or off (cannot be used in DIRECT or MULTI CH IN mode).

**DIGITAL NR button (See p.48)**

Switches the DIGITAL NR on or off (cannot be used in DIRECT or MULTI CH IN mode).

**FL DIMMER button (See p.52)**

Use to adjust the brightness of the main display.

**6 Display (See p.25)**

**7 Remote sensor**

Point the remote control toward the remote sensor to operate the receiver.

**8 MULTI-ROOM & SOURCE button (See p.78-82)**

Press to use the multi room feature(requires an optional PIONEER Multi-Room Remote Sensor Unit MR-100 or another IR receiver).

**CONTROL button (See p.78-82):** Used together with the INPUT SELECTOR to select the function or use with the MASTER VOLUME to select the volume of the MULTI ROOM system.

**9 INPUT SELECTOR dial**

Turn to select a source component. (You can also use to select a function in the MULTI-ROOM & SOURCE mode). The source indicators show the current component:

**DVD/LD** – DVD player or Laser Disc player.

**TV/SAT**– TV or satellite tuner.

**CD** – Compact Disc player.

**MD/TAPE1/CD-R** – Tape deck, Mini Disc recorder or CD recorder connected to MD/TAPE 1/CD-R inputs/outputs.

**TUNER** – The built-in tuner.

**PHONO** – Turntable.

**VIDEO** – Video camera (etc.) connected to the VIDEO INPUT on the front panel.

**VCR1/DVR** – Video cassette recorder connected to VCR1/DVR inputs.

**VCR 2** – Video cassette recorder or other component connected to VCR 2 inputs.

**10 PHONES jack**

Connect headphones for private listening (no sound will be heard through the speakers).

**11 VIDEO INPUT jacks (See p.15)**

**S-VIDEO:** Video input for connecting a video camera (etc.), that has an S-Video out.

**VIDEO / AUDIO (L/R):** Video input for connecting a video camera, etc. that has standard video/audio outputs.

**12 SPEAKERS (A/B) button**

Use to select the speaker system. A is the primary setting. It plays all speakers hooked up to the A system. A & B setting only plays the front speakers of both the A & B systems and the subwoofer. Multi channel sources will be down-mixed to these speakers so no sound will be lost. B setting only plays the front speakers connected to the B system and multi channel sources will be down-mixed to these two speakers. The button cycles through the speaker systems as follows: A⇒B⇒A&B⇒off.

**13 VIDEO SELECT button**

Switches the receiver between the various types of video input.

**14 TAPE 2 MONITOR button**

Selects the tape deck (MD recorder, etc.) connected to the TAPE 2 MONITOR inputs/ outputs. Allows monitoring of a recording as it's being made.

### 15 TUNER CONTROL buttons (See p.54-57)

**CLASS** – Press repeatedly to switch the preset station classes.

**BAND** – Press to select the AM or FM band.

**TUNING -/+** – Use to manually tune to radio stations.

**MPX** – Press to switch between auto stereo and MONO reception of FM broadcasts. When the broadcast signal is weak, selecting MONO will improve the sound quality.

**MEMORY** – Press to start the memorization of a preset station.

**STATION -/+** – Use to choose programmed radio stations.

### 16 MASTER VOLUME

Adjusts the overall receiver volume.



# Display

All the display information is explained and/or referenced here.

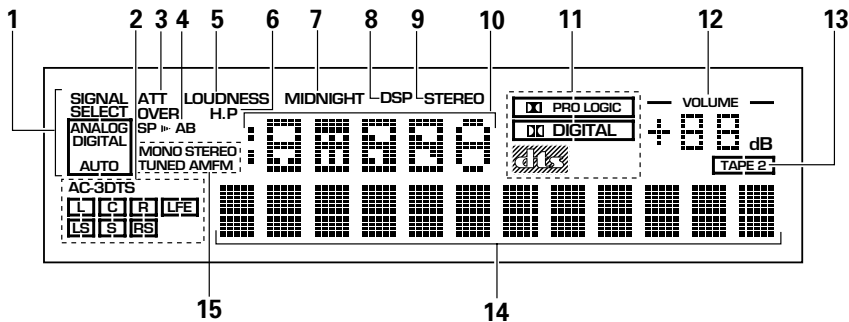

## 1 SIGNAL SELECT indicators

Light to indicate the input signal you selected.

**ANALOG** : Lights when analog signals are assigned.

**DIGITAL**: Lights when digital audio signals are selected.

**AUTO**: Lights when the receiver is set to select the input signal automatically.

## 2 Program Format indicators

**AC-3**: Lights when a source with Dolby Digital signals is played.

**DTS**: Lights when a source with DTS audio signals is played.

**For Dolby Digital or DTS sources**: These indicators change according to which channels are active in the source.

**L** – Left front channel.

**C** – Center channel.

**R** – Right front channel.

**LS** – Left surround channel.

**S** – Surround channel (mono).

**RS** – Right surround channel.

**LFE** – Low Frequency Effects channel.

## 3 Analog level indicators

**OVER** – When the source signal is analog, this lights if the signal is in danger of distorting. Press INPUT ATT on the remote control to lower the signal level.

**ATT** – Lights when INPUT ATT is used to reduce the level of the analog source signal.

## 4 Speaker indicators

Light to indicate the current speaker system, A and/or B.

## 5 LOUDNESS indicator (See p.49)

Lights when the LOUDNESS mode is on.

## 6 H.P (headphones)

Lights when headphones are connected to the PHONES jack (speakers systems A and B both turn off automatically).

## 7 MIDNIGHT indicator (See p.49)

Lights when the MIDNIGHT LISTENING mode is on.

## 8 DSP indicator (See p.41-45, 47)

Light when a DSP or Advanced Theater mode is selected.

## 9 STEREO indicator

Lights when a STEREO mode is selected.

## 10 Radio Frequency/Function indicator

Displays the function or the frequency of the current radio station.

## 11 /dts mode indicators

**DIGITAL** : When the /dts mode on the receiver is on, this indicator lights to indicate playback of a Dolby Digital signal. However, PRO LOGIC lights during 2 channel playback of Dolby Digital.

**PRO LOGIC**: When the /dts mode on the receiver is on, this indicator lights during 2 channel playback.

**DTS** : When the /dts mode on the receiver is on, this indicator lights to indicate playback of a DTS signal.

## 12 MASTER VOLUME indication

Displays current volume level.

## 13 TAPE 2 indicator

Lights when the TAPE 2 monitor is on.

## 14 Character display

Shows current mode, status, etc.

## 15 Tuner indicators

**MONO**: Lights when the tuner is set to receive FM broadcasts and when selected MPX mode.

**STEREO**: Lights when a FM stereo broadcast is received in the auto stereo mode.

**TUNED**: Lights when a broadcast is received.

**AM/FM**: Light to indicate the current band (FM or AM).

# Remote Control

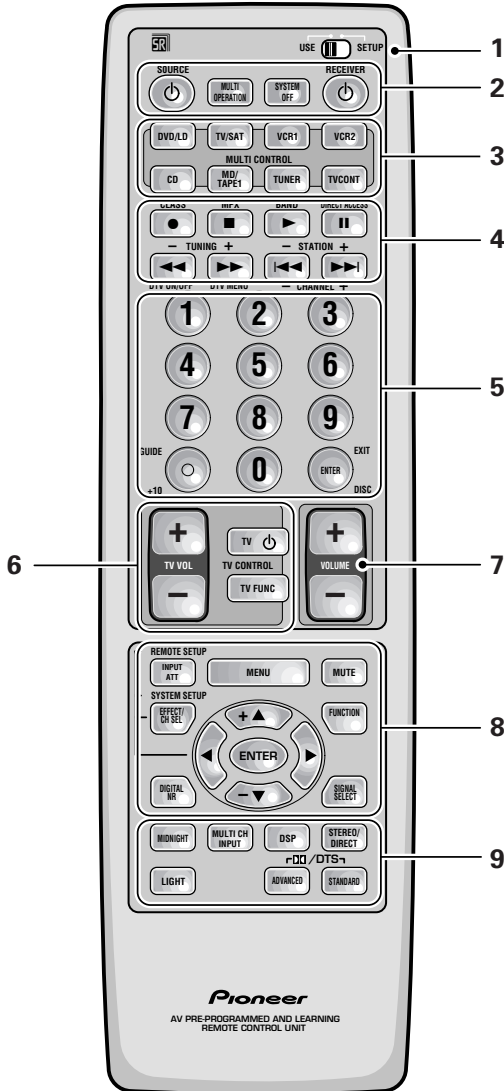

## 1 USE/SETUP slide switch

Use to put the remote into receiver SETUP, or receiver USE mode.

## 2 SOURCE button

Use to turn on the power of your other components after you have recalled or taught the signals to this remote control.

## MULTI OPERATION button

Use this button to start the MULTI OPERATION mode. See page 71-72 for how to program and use the MULTI OPERATION mode.

## SYSTEM OFF button

This button turns off components in two ways. First, when pressed it will turn off all PIONEER components. Secondly, any component that has programmed into the SYSTEM OFF settings will also be turned off (see p.73).

For example : If you programmed power on for your TV and VCR, pressing the SYSTEM OFF button will turn off these components even if they are not PIONEER products.

## RECEIVER button

Press to turn power of the receiver on or to STANDBY (off).

## 3 MULTI CONTROL buttons

Use these to select a source and the corresponding remote operation mode.

For example, pressing TUNER selects the built in tuner and sets the remote operation to the tuner functions.

## 4 Component Control buttons

Use to control specific components, like a CD player or DVD player, after you have programmed the remote control to do these operations (see pages 58-61) and the remote is put in that operation mode.

## 5 Number buttons

These buttons can perform a variety of different functions depending on the remote operation mode. They are most useful for CD and tuner operations.

## 6 TV CONTROL buttons

The following buttons are used to control the TV only and can be used no matter what function the remote control is set to.

**TV SOURCE button** – Press to turn the power of the TV on/off.

**TV FUNC button** – Press TV FUNC to select the TV for remote control operation.

**TV VOL +/- button** – Use to adjust the TV volume.

**7 MASTER VOLUME buttons**

Use to raise or lower the volume of the receiver.

**8 INPUT ATT button (when USE mode is selected)**

Use to lower the input level of an analog signal that is too powerful, thus causing the sound to distort (the OVER indicator will light).

**REMOTE SETUP button (when SETUP mode is selected)**

Use to customize the remote control functions and the remote control itself. (See "Setting Up the Remote Control to Control Other Components" starting on p.58, "Multi Operations" starting on p.71)

**MENU button**

Use to get the various menus for your TV or DTV.

**MUTE button**

Press to mute or restore the volume.

**EFFECT/CH SEL (when USE mode is selected) button (see memo on p.44)**

**EFFECT** – Use these buttons to increase or decrease the amount of effect applied in a DSP or Advanced Theater mode. When the amount of effect is increased in a DSP/Advanced Theater mode the characteristics of that mode become stronger and more noticeable. The scale ranges from 10-90 with 70 as the default setting. First turn on the DSP/Advanced Theater you want (by pressing the DSP/Advanced Theater button until you get the mode) and then increase or decrease the amount of effect.

**CH SEL** – You may want to adjust the channels when listening to some sound sources. Use this button to select the channel you want to adjust.

**SYSTEM SET UP button (when SETUP mode is selected)**

Use to set up the speaker and sound systems. For more information see "Setting up for Surround Sound" starting on p.29.

**FUNCTION button**

Press to select a source. The button will cycle through all the possible sources.

**▲(+)/▼(-)/◀/▶/ENTER buttons**

Use to operate the on-screen menu on your TV screen and enter commands when setting up surround sound, speakers levels & settings, and other set up features see p.28-40. Specific use of these buttons is described in conjunction with the operations they perform. For more information see each individual section.

**DIGITAL NR button**

Press to switch Digital NR on or off. (See page 48)

**SIGNAL SELECT button**

Press SIGNAL SELECT repeatedly to select one of the following:

**ANALOG** – Analog signal.

**DIGITAL** – Digital signal (DVD/LD, TV/SAT, CD, MD/TAPE 1/CD-R, VCR 1/DVR, VCR 2).

**AUTO** – This is the default. If there are both analog, digital input signals, the receiver automatically selects the best possible signal.

**9 MIDNIGHT button (See p.49)**

Switches the MIDNIGHT mode on or off.

**MULTI CH INPUT button (See p.40, 51)**

Press to switch to MULTI CH IN mode.

**DSP button (See p.41-45)**

Press repeatedly to select a DSP sound mode.

**STEREO/DIRECT button (See p.44 & 46)**

Switches the receiver into STEREO mode if it was in a different sound mode (like ADVANCED THEATER) or toggles between DIRECT and STEREO mode. For more on STEREO mode see p.43.

DIRECT playback bypasses the tone controls and channel level for the most accurate reproduction of a program source.

**LIGHT button**

Press to light the remote control buttons.

**◻ /DTS buttons (See p.41-45)**

Press these buttons to put the receiver in the selected sound mode. For more information on the sound modes see p.83.

# Initial Set Up

## On Screen Display

There are a number of possible ways to hook up the receiver to your video components, like a DVD player, and hook up to your receiver to your TV, but some of them will not allow you to use the on-screen display of this unit. To avoid this, you simply need to keep the following rules:

- ① Always use the same type of video cords to hook up your video components to the receiver as you use to hook up the receiver to your TV. For example, if you use composite video cords to hook up your DVD player to the receiver, use composite video cords to hook up the receiver to your TV. If you use S video cords to hook up your DVD player and the receiver, use S video cords to hook up the receiver to your TV.
- ② Always make sure your TV is set to the appropriate input channel (for example, video 1). Your TV may have a number of input channels and if you do not select the proper one, you will not be able to use this receiver's on-screen display, or, in fact see any picture from this receiver at all. If you are unsure how to choose an input channel for your TV, refer to the manual which came with your TV.

You might, for example, use both composite and S video cords to hook up your video components with this receiver and then use composite video cords to hook up this receiver to your TV. This arrangement would still NOT let you see the on-screen displays from this receiver on your TV. The best idea is just to use one type of video cords for all your video component and TV hook ups.

## Switching video system between PAL and NTSC (if necessary)

This receiver is able to use two types of video systems for its OSD (on screen display) either PAL or NTSC. If you don't match the system on the amplifier with your home system no OSD will appear on your TV. **The default setting is NTSC, which is the standard in North America. If you use this system you don't need to make any settings here.** People with multi-system TVs don't need to worry about changing the setting either. If necessary, follow the instructions below to switch the type of video system.

⏻ STANDBY/ON

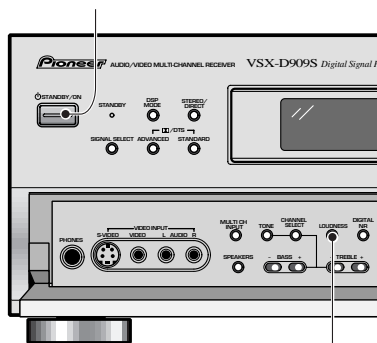

### 1 Put the receiver in the STANDBY mode.

### 2 While holding down the LOUDNESS button press the ⏻ STANDBY/ON button.

The video system type will change depending on the state the receiver was previously in. The new type, either PAL or NTSC, will appear in the display. It will be shown for about seven seconds and then the receiver returns to normal operating mode.

To change the video system type again repeat steps 1 and 2.

Make sure you press the LOUDNESS button, using others buttons may change this receiver's settings.



When a PAL system is selected

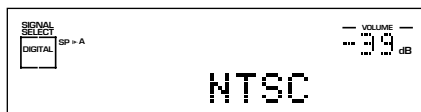

When a NTSC system is selected



When using the PAL setting the OSD does not get displayed in color.

## Setting Up for Surround Sound

To ensure the best possible surround sound, be sure to complete the following setup operations. You only need to make these settings once (unless you change the placement of your current speaker system or add new speakers, etc.).

This receiver uses on-screen displays to make setting up your home cinema system easier. Switch on the receiver and your TV, and make sure that the receiver is selected as your TV's video input.

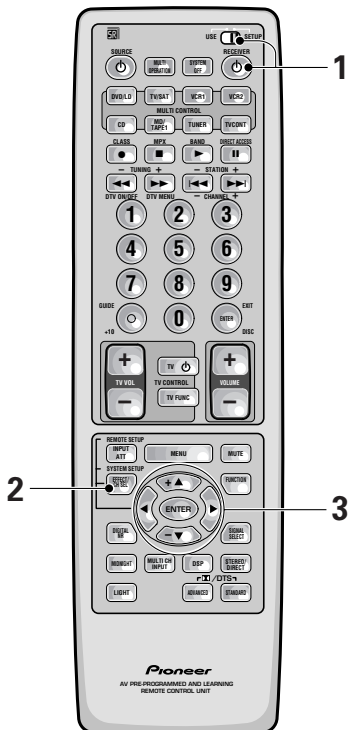

### 1 Set the slide switch to SETUP.

Also make sure your TV is on and set to the receiver.

- When you're done setting up the receiver, remember to set the slide switch back to USE.

### 2 Press the SYSTEM SETUP button.

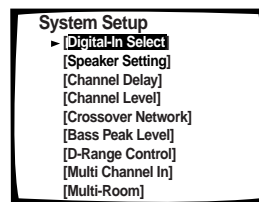

This SYSTEM SETUP MENU appears on your TV screen.



This display appears on the receiver.

- You can escape from this screen at any time by pressing the SYSTEM SETUP button again. None of the settings you made will be entered in this case.
- If you don't enter any settings the receiver will revert back to its previous state after three minutes.

### 3 Press the ▲ or ▼ arrow buttons to move the hand to the mode you want. Then press the ENTER button.

In each mode, the current settings are displayed automatically. We suggest you adjust all these settings when you first hook up the receiver. That gets them out of the way and you won't need to return to this setting mode unless you change your home set up by adding new speakers (etc.). The sound set up modes explained here are:

#### Digital In Select (See p.31)

In order to use your digital components you must match the numbered digital input settings with the numbered digital jacks used by your digital components.

#### Speaker Setting (See p.32-33)

Use to specify the type and number of speakers you connected.

## Initial Set Up

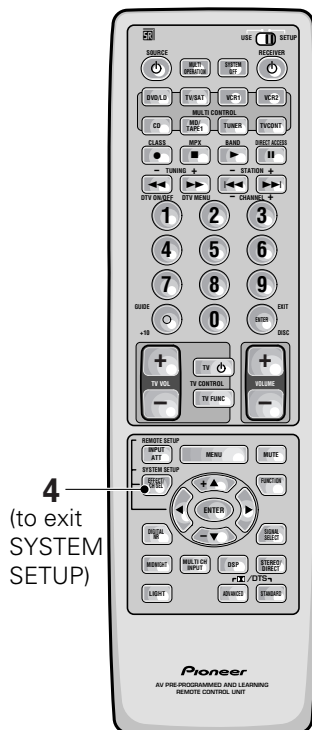

### Channel Delay (See p.34)

Set up all your speakers for the most realistic surround sound. Adding a slight delay to some speakers enhances sound separation and is particularly important for achieving a surround sound effect. You need to figure out the distance from your listening position to your speakers to add the proper delay.

### Channel Level (See p.35-36)

Use to balance the volumes of your different speakers.

### Crossover Network (See p.37)

This feature lets you select which bass frequencies will be sent to the subwoofer or front speakers.

### Bass Peak Level (See p.38)

Dolby Digital and DTS audio sources include ultra-low bass tones. Set the bass peak level as needed to prevent the ultra-low bass tones from distorting the sound from the speakers.

### Dynamic Range Control (See p.39)

This feature makes possible excellent surround sound effects when listening to Dolby Digital sources at low volumes.

### Multi Channel In Setting (See p.40)

This feature lets you hook up a multi channel external decoder that may give you higher quality when decoding discs.

### Multi-Room (See p.78-82)

You can set up this unit to power systems in different rooms.

## 4 Go on to the next page to continue set up.

If you don't want to make any settings you can exit this setup. To exit the SYSTEM SETUP MENU and on-screen display press SYSTEM SETUP button again.



After you complete one of the SYSTEM SETUP menus and return to the basic SYSTEM SETUP screen the receiver automatically moves the cursor to the next SYSTEM SETUP menu. For example, if you've completed SPEAKER SETTINGS and returned to the basic SYSTEM SETUP screen, CHANNEL DELAY will be selected automatically. You can notice this on your TV screen.

## Digital-In Select

In order to be able to use your digital equipment properly you need to assign digital inputs for each of the digital components you connected. Match the Digital 1-5 settings with the digital jacks 1-5 in accordance with what is connected to each digital jack. Check the digital jack numbers on the back of the receiver to make certain what component is in which jack (if necessary, see page 13 for more on digital connections). If continuing from the last page go to step 1. If starting fresh, complete steps 1-3 in "Setting Up for Surround Sound" (p.29) first.



### 1 DIGITAL IN SELECT should be selected (if it isn't use the ▲/▼ buttons to select it).

See "Setting Up for Surround Sound" on page 29 if you need more information.

Press the ENTER button.

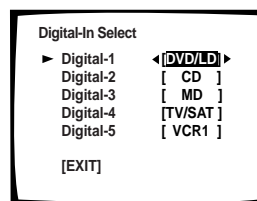

### 2 Choose a DIGITAL IN and assign it an input function.

Use ◀ or ▶ to choose the input function that matches the component hooked up to that digital terminal.

The possible choices include: DVD/LD, TV/SAT, CD, MD/TAPE 1/CD-R, VCR 1/DVR, VCR 2. You cannot assign digital inputs to the TUNER, VIDEO, PHONO, and TAPE 2 MONITOR functions.

If you assign a function (for example DVD/LD) that was previously assigned to a different Digital In the second Digital In will automatically revert to an OFF setting. This is because one function cannot be assigned twice.

### 3 Select EXIT and press ENTER button to return to the SYSTEM SETUP MENU.

If you want to change a setting before proceeding simply use the arrow buttons to go back.

- For the Digital 1-5 setting you can choose between DVD/LD, CD, TV/SAT, MD/TAPE 1/CD-R, VCR 1/DVR and VCR 2 functions.

## Initial Set Up

### Speaker Setting

The following steps show you how to specify the type of speakers you connected. Use the ▲/▼ and ◀/▶ buttons to make a selection from the on-screen menus, and use the ENTER button to register the information. If continuing from the previous page go to step 1. If starting fresh, complete steps 1-3 on p.29 first.



#### 1 Select **SPEAKER SETTING** (if continuing from last set up, it will already be selected) with the ▲/▼ buttons then press the **ENTER** button.

See "Setting Up for Surround Sound" on page 29 if you are unsure how to do this.

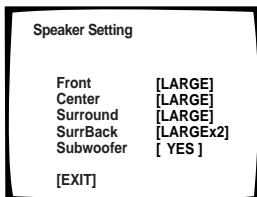

#### 2 Select a speaker setting mode with the ◀/▶ buttons then press the ▼ button.

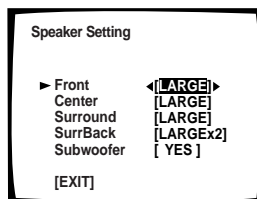

#### 3 Specify the type of speakers you connected. See the explanations below for the meaning of each size.

- ① Press ◀ or ▶ to move the hand to LARGE (or LARGE X2), SMALL (or SMALL X2), or NO (you can't select NO for the FRONT speakers). For the subwoofer you can select YES, NO, or PLUS. See below for a detailed explanation of every speaker choice.
- ② Press ▼.
- ③ Repeat ① and ② for each speaker.

**Depending on your choices the sound will be routed differently, as explained here.**

##### **FRONT (default setting is LARGE)**

- Select SMALL to send bass frequencies to the subwoofer.
- Select LARGE if your speakers will reproduce bass frequencies effectively or if you did not connect a subwoofer.

(If you select SMALL for the front speakers the subwoofer will automatically be set to YES. Also, the center, surround, and surround back speakers cannot be set to LARGE if the front speakers are set to SMALL. In this case, all bass frequencies are sent to the subwoofer.)





If you have a subwoofer and like lots of bass, it may seem logical to select LARGE for your FRONT speakers and leave the subwoofer selected. This may not, however, yield the best bass results. Depending on the size and shape of your room you may actually experience a decrease in the amount of bass due to what is called "low frequency cancellations." If you have a subwoofer, listen to the bass response with the FRONT speakers set to LARGE and SMALL alternatively and let your ears judge which sounds best.

The safest option in this case is to route all the bass sounds to the subwoofer by selecting SMALL for the FRONT speakers.

#### CENTER (default setting is LARGE)

- Select LARGE if your speaker will reproduce bass frequencies effectively.
- Select SMALL to send bass frequencies to the other speakers or the subwoofer.
- If you did not connect a center speaker, select NO. In this case, the center channel is output from the front speakers.

#### SURROUND (default setting is LARGE)

- Select LARGE if your speakers will reproduce bass frequencies effectively.
- Select SMALL to send bass frequencies to the other speakers or subwoofer.
- If you did not connect surround speakers select NO. In this case, the sound of the surround channels is output from the front and center speakers.
- If the SURROUND speakers are set to SMALL, the SURROUND BACK speakers will automatically be set to SMALL.

#### SUBWOOFER (default setting is YES)

- Select YES if you connected a subwoofer.
- If you did not connect a subwoofer select NO. In this case, the bass frequencies are output from the front or surround speakers.
- Choose the PLUS setting if you want stronger reproduction of deep bass sounds.
- If you select PLUS the bass frequencies that would normally come out the front and center speakers are all routed to the subwoofer.

#### SURROUND BACK (default setting is LARGE X2)

**NOTE: In order to use SURROUND BACK speakers you need to hook them up through an external amplifier (see p. 19 & 21) for more on this.**

- Select the number and size of SURROUND BACK speakers you have. You can choose one speaker, two or none.
- If the FRONT speakers or the SURROUND speakers are set to SMALL, the SURROUND BACK speakers will automatically be set to SMALL.
- Select LARGE if your speakers will reproduce bass frequencies effectively.
- Select SMALL to send bass frequencies to the other speakers or subwoofer.
- If you did not connect surround back speakers select NO.

### 4 Select EXIT with the ▲/▼ buttons and press ENTER to return to the SYSTEM SETUP MENU.

Next, proceed to CHANNEL DELAY on the next page.

## Initial Set Up

### Channel Delay

Adding a slight delay to some speakers is necessary to achieve a surround sound effect. You need to figure out the distance from your listening position to your speakers to add the proper delay. The following steps show you how to set the delay time for each channel by specifying the distances from your listening position to each speaker. Once you specify the speaker distances, the receiver calculates the correct delay times automatically. If continuing from Speaker Setting go to step 1. If starting fresh, complete steps 1-3 in "Setting Up for Surround Sound" (p.29) first.



#### 1 Select CHANNEL DELAY (if continuing from last set up, it will already be selected).

See "Setting Up for Surround Sound" on page 29 if you are unsure how to do this.

Press the ENTER button.

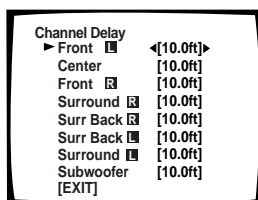

- The default setting is 10 ft.

#### 2 Use the ▲/▼ buttons to select a speaker. Specify the distance from your listening position to each speaker using the commands below.

- ① Press ◀ or ▶ to adjust the speaker distance in half foot increments from 0.5 to 45 feet.

The default setting is 10 feet.

- ② Use the ▲/▼ buttons to move to the next set of speakers.
- ③ Repeat for each speaker.

- Sound takes about 1 millisecond to travel 1 foot.

#### 3 Select EXIT with the ▲/▼ buttons and press ENTER button to return to the SYSTEM SETUP MENU.

Next, proceed to CHANNEL LEVEL on the next page.

If you want to change a setting before proceeding simply use the arrow buttons to go back.

## Channel Level

The following steps show you how to balance the sound output level of your speakers. Proper speaker balance is essential for obtaining high quality surround sound. If continuing from Channel Delay go to step 1. If starting fresh, complete steps 1-3 in "Setting Up for Surround Sound" (p.29) first.



### 1 Select CHANNEL LEVEL (if continuing from CHANNEL DELAY, it will already be selected).

See "Setting Up for Surround Sound" on page 29 if you are unsure how to do this.

Press the ENTER button.

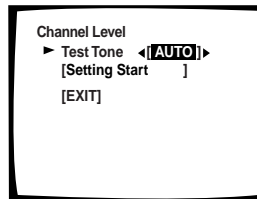

**NOTE : Be prepared! The test tone is output at a high volume level.**

### 2 Select a TEST TONE mode.

- ① Press ◀ or ▶ to move the hand to AUTO or MANUAL.
- ② Press ▼ button to select SETTING START.

#### AUTO (automatic TEST TONE)

This mode switches the test tone between each speaker automatically. Use this mode when balancing the speaker levels by ear.

The automatic test tone is output in the following order:

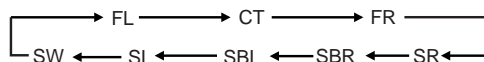

#### MANUAL (manual TEST TONE)

This mode lets you switch the test tone between each speaker manually. You can use this mode when you want to balance the speaker levels by ear at a more leisurely pace.

### 3 After selecting SETTING START with the ▼ button press ENTER button. The TEST TONE will be output.

These settings will be displayed on your TV.

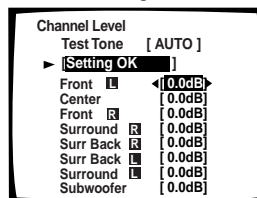

It takes a moment for the machine to set itself. MASTER VOLUME rotates to the reference position (0 dB), and the test tone is output.

#### To exit before outputting the TEST TONE

Press the ENTER button.

#### To exit while outputting the TEST TONE

Press the ENTER button.



A test tone will be output from the SURROUND BACK speakers but your external amplifier must be turned up at least a little in order to hear it. Be careful that it is not turned up too much because the test tone volume is quite loud.



4-6



Note that it is also possible to set channel levels temporarily. Then follow the same procedure as explained on this page. This function is designed to be used when you want to change the levels temporarily to raise the level of one channel. Using this method you can set speaker levels in different modes, such as, STEREO, and each DSP mode, independently. You should return the settings to their original state when done. Doing the set up procedures on this page will erase any temporary/independent level settings that have been made.

## 4 Adjust speaker levels so that you hear the test tone at the same volume from each speaker when seated in your main listening position.

Note: The volume of the subwoofer tends to sound lower than it actually is, you may need to raise its level after testing the sound with actual soundtracks.

### In AUTO mode

- 1 Press the ◀ or ▶ button to adjust the level of the speaker outputting the TEST TONE.

### In MANUAL mode

- 1 Press the ◀ or ▶ button to adjust the level of the first speaker.
- 2 Press the ▲/▼ button to switch the TEST TONE to the next speaker.
- 3 Repeat 1 and 2 for each speaker.

### If you are using a Sound Pressure Level (SPL) meter

Take the readings from your main listening position and adjust the level of each speaker to 75 dB SPL (C-weighted/slow mode).

## 5 When you have adjusted each speaker level, press ENTER button to return to the previous screen.

The MASTER VOLUME will return to its original position.

## 6 Select EXIT with the ▲/▼ buttons and press ENTER button to return to the SYSTEM SETUP MENU.

Next, proceed to CROSSOVER NETWORK on the next page.

**If you want to change a setting before proceeding** simply use the arrow buttons to go back.

## Crossover Network

The following steps show you how to adjust the crossover network. The crossover network is the frequency at which the system divides the signal and sends the different parts (high, mid, low) to different speakers. Speaking precisely, this setting sets the cutoff point for the bass frequencies rerouted from your SMALL speakers to your subwoofer or speaker set to LARGE.

If continuing from Channel Level go to step 1. If starting fresh, complete steps 1-3 in "Setting Up for Surround Sound" (p.29) first.



1-3

### 1 Select CROSSOVER NETWORK (if continuing from CHANNEL LEVEL, it will already be selected).

See "Setting Up for Surround Sound" on page 29 if you are unsure how to do this.

Press the ENTER button.

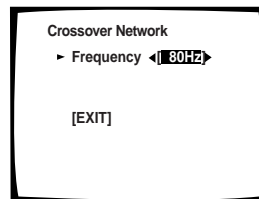

- The default setting is 80 Hz.

### 2 Specify the crossover frequency for your small speakers.

Setting speakers to SMALL in "SPEAKER SETTING" sends the respective channel's bass frequencies to the subwoofer (or LARGE speakers). The present function lets you determine which frequencies will be sent to the subwoofer or LARGE speakers.

- ① Use the ◀ or ▶ button to select 80 Hz, 100 Hz, or 150 Hz.
- ② Press the ▼ button.

#### 80 Hz

Sends bass frequencies below 80 Hz to the subwoofer (or LARGE speakers).

#### 100 Hz

Sends bass frequencies below 100 Hz to the subwoofer (or LARGE speakers).

#### 150 Hz

Sends bass frequencies below 150 Hz to the subwoofer (or LARGE speakers).

Experiment with the different settings to see which sounds best to you.

### 3 Select EXIT to return to the SYSTEM SETUP MENU.

Next, proceed to BASS PEAK LEVEL on the next page.

**If you want to change a setting before proceeding** select a new crossover frequency.

## Initial Set Up

### Bass Peak Level

The LFE (Low Frequency Effect) channel in Dolby Digital or DTS program sources can produce heavy ultra-low bass tones that may exceed the capabilities of your speaker system. The following steps show you how to set a maximum output level for the LFE channel. If continuing from Crossover Network go to step 1. If starting fresh, complete steps 1-3 in "Setting Up for Surround Sound" (p.29) first.



#### 1 Select BASS PEAK LEVEL (if continuing from CROSSOVER NETWORK it will already be selected).

See "Setting Up for Surround Sound" on page 29 if you are unsure how to do this.

Press the ENTER button.

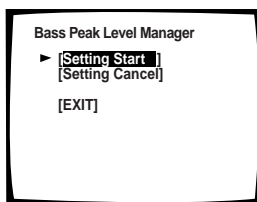

#### 2 Output the test tone for the LFE channel and specify the peak level.

- ① If your subwoofer has a volume control, set it to the middle position before proceeding.
- ② Select SETTING START.
- ③ Press the ENTER button.

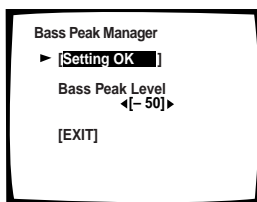

MASTER VOLUME rotates to MIN (—dB). Then the test tone is output to the subwoofer or front or surround speakers.

- ④ Use the ◀ or ▶ button arrows to gradually increase the level of the LFE channel until the test tone begins to distort. Then go back and leave the level setting at a point just before that. Press the ENTER button and the receiver will remember this bass output level.

To exit before outputting the TEST TONE select EXIT and press the ENTER button.

To exit while outputting the TEST TONE press the ENTER button.

#### 3 Select EXIT and press the ENTER button to return to the SYSTEM SETUP MENU.

This completes the speaker setup.

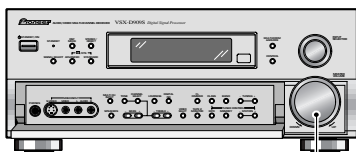

MASTER VOLUME



If you select SETTING CANCEL no settings are input to the receiver but the screen remains on the TV. To escape the screen you must Select EXIT and press the ENTER button.

## Dynamic Range Control

This feature makes it possible to enjoy full surround sound effects on Dolby Digital sources even at low volumes. It does this by compressing the dynamic range. Dynamic range is the difference between the loudest and the softest sounds in any given signal. Compressing the range plays sounds so the quieter ones are audible and the louder ones don't get distorted or become overpowering. This feature only applies to Dolby Digital sources but the MIDNIGHT LISTENING mode accomplishes the same end for a variety of sources (see page 49). If continuing from Bass Peak Level go to step 1. If starting fresh, complete steps 1-3 in "Setting Up for Surround Sound" (p.29) first.



1-3

### 1 Select D-RANGE CONTROL (if continuing from BASS PEAK LEVEL, it will already be selected).

See "Setting Up for Surround Sound" on page 29 if you are unsure how to do this.

Press the ENTER button.

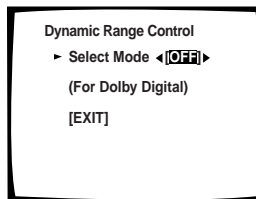

- The default setting is OFF.
- If listening at loud volumes we recommend turning the Dynamic Range Control OFF.

### 2 Use the ◀ or ▶ arrows to choose OFF, MID or MAX.

### 3 Select EXIT and press ENTER button to return to the SYSTEM SETUP MENU.

If you want to change a setting before proceeding choose a new DYNAMIC RANGE CONTROL setting.

You may need to experiment with different Dolby Digital sources before you can use the DYNAMIC RANGE CONTROL setting to suit your low volume listening needs.

## Initial Set Up

### Multi Channel In Setting

If you have a Multi Channel external decoder you can choose whether to have the sound level set to BYPASS, in which case only the main volume can be controlled, or to ADJUST, which means the levels can be reduced in volume. If continuing from Dynamic Range Control go to step 1. If starting fresh, complete steps 1-3 in "Setting Up for Surround Sound" (p.29) first.



#### 1 Use the ▲/▼ buttons to select MULTI CHANNEL IN.

See "Setting Up for Surround Sound" on page 29 if you need more information.

**Press the ENTER button.**

This information will be displayed on your TV.

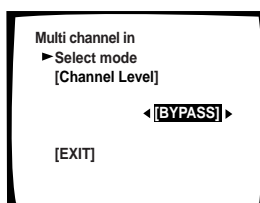

#### 2 Use the ◀/▶ buttons to select the setting you want, BYPASS or ADJUST.

**ADJUST:** Use the ADJUST setting when you want to be able to control each channel level individually.

**BYPASS:** This setting is good for getting the cleanest possible signal. In this setting you won't be able to change each channel individually.

We recommend using BYPASS and the default setting is BYPASS.

#### 3 Use the ▲/▼ buttons to select EXIT.

**Press the ENTER button.**

You will return to the SYSTEM SETUP mode.

### Multi Channel In Setting Using the Main Unit

You can also use the main unit to change the sound level of the MULTI CH IN. Follow the steps below.

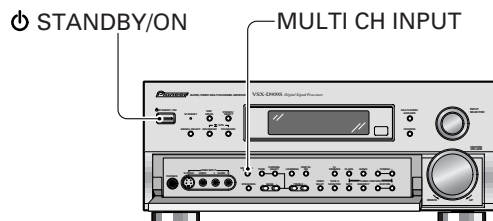

#### 1 Put receiver in the STANDBY mode.

#### 2 While holding down the MULTI CH INPUT button press the STANDBY/ON button.

The setting will change depending on what state the receiver was previously in. For a few seconds the display will show you which MULTI CH setting you are now in.





# Basic Playback

## Sound Modes

The four sound modes on the receiver are explained here. These can be turned on from the front panel or from the remote control.

There are two cinema modes: STANDARD, and ADVANCED THEATER. These are designed to be used with multi channel surround sound audio/visual sources (like DVDs and LDs). Intrinsic to home theater, these modes can deliver realistic and powerful surround sound that recreates the movie theater experience. You may need to experiment with them to see which settings suit your home system and personal tastes.

The DSP and STEREO modes are designed to be used with music sources but some DSP modes are also suited for film soundtracks. Again, try different settings with various soundtracks to see which you like.

You must choose one of the three cinema modes or the DSP mode in order to get surround sound. In STEREO mode only the front two speakers, and sometimes the subwoofer (if you have one), are used.

### STANDARD modes

STANDARD mode decodes Dolby Digital, DTS and Dolby Pro Logic sources (see page 83 for more detailed information), and plays them without any further processing. You can think of this as the basic surround sound mode of the receiver.

Using STANDARD 7.1 you can enjoy surround sound from additional surround back speaker(s). You will only be able to access STANDARD 7.1 if you have hooked up SURROUND BACK speaker(s). For more detailed information see p.19, 32-33.

#### STANDARD

This mode decodes Dolby Digital, DTS or Dolby Pro Logic sources with no additional effects. If you don't have SURROUND BACK speaker(s) switched on (see p.32-33) this is the only STANDARD mode you will be able to select on the receiver.

#### STANDARD 7.1

STANDARD 7.1 is a Pioneer technology that generates realistic 7 channel surround sound without destroying the original sound staging. You will only be able to access this mode if you have set the SURROUND BACK speakers in the SPEAKER SETUP procedure (see p.32-33). Also, this mode will play 5.1 channels sources and other sources through all the speakers you have hooked up, routing some of the sound into your SURROUND BACK channel or channels. STANDARD 7.1 will appear in the display even if you only have one SURROUND BACK speaker hooked up.

### ADVANCED THEATER modes

The Advanced Theater mode is a newly designed system for enhancing movie soundtracks and other audio-visual sources. It incorporates the use of DTS as well as Dolby Digital into its sound processing. These functions switch on automatically when the source you are playing is encoded with DTS or Dolby Digital. There are four Advanced Theater settings that use DSP (Digital Signal Processing) to create different types of sound environments. If you have SURROUND BACK speakers or (even just one) speaker switched on (see p.32-33) then 7.1 will appear after the name of all of these modes in the display on the receiver. The display will show you what kind of source (Dolby Digital, DTS, etc.) is being played.

#### MUSICAL

This mode is primarily for music and adds a spacious feeling to the sound. A long delay time of reflected sounds, provides resonant tones which emulate a concert hall.

#### DRAMA

This mode is designed for movies with a lot of dialog. The elements of dialog are enhanced, making the characters seem more real. The mode also compresses the dynamic range somewhat so loud sounds do not overpower softer ones (compare this with the MIDNIGHT LISTENING mode explained on p.49).

#### ACTION

This mode is designed for action movies, which generally use lots of sound effects. The mode enriches the sound to make it more realistic and extends the parameters to pick up high and low sound effects.

#### 5/7-D THEATER

This mode is especially designed to give sound depth to stereo sources. The overall effect builds a dynamic and broad sound space, allowing two-channel (stereo) signals to faithfully imitate a five speaker sound. The mode should be used in conjunction with Dolby Pro Logic for sources bearing the

 mark.



When a Dolby Digital soundtrack is played back the Dialog Normalization function of the receiver activates automatically. Dialog Normalization is a Dolby Digital function that establishes the average dialog level for the program source being played. If the receiver's level does not match the average dialog level, first you see "DIAL NORM" flash in the receiver's display and next "OFFSET +4 dB" (as an example) will appear. In this example, the number +4 dB is the difference between the receiver's gain structure and the Dolby Digital average dialog level. To match the average dialog level, subtract or add the OFFSET level. For example, if the OFFSET level is +4 dB, the amplifier's output is 4 dB over the average recorded level.

## DSP modes

The DSP (Digital Signal Processing) modes allow you to transform your living room into a variety of different sonic environments when playing either two-channel or multi-channel sources. If you have SURROUND BACK speaker(s) switched on (see p.32-33) then 7.1 will appear after the name of all of these modes in the display on the receiver.

### HALL 1

Simulates the acoustic effects of a large concert hall. Suitable for classical music. A long delay time of reflected sounds, coupled with reverb effects, let the listener enjoy the dynamic and rich sounds characteristic of concert halls and powerful orchestral performances.

### HALL 2

Simulates the acoustic environment of a very resonant concert hall. Rich reverberation and a full sound create the impression of a lively performance space.

### JAZZ

Simulates the acoustic effects of a jazz club. Reflected sound is virtually below 100 msec so that the listener can enjoy a live band effect.

### DANCE

Simulates the acoustic effects of a dance club. Features a strong bass sound. Reflected sound delay time is virtually below 50 msec, for the listener to enjoy the visceral power of dance music.

### THEATER 1

Reproduces theater sound field effects without losing the localization of each channel. Theater effects can be enjoyed without losing Dolby Digital/ Pro Logic effects when used in combination those formats (with movies bearing the  DOLBY SURROUND trademark).

### THEATER 2

Simulates the acoustic environment of a theater while maintaining proper localization of each channel.

### 5/7CH STEREO

Simulates the acoustic environment of a regular stereo while using all the speakers in the system to induce a rich, all-around sound. If you have SURROUND BACK speaker(s) switched on (see p.32-33) then the name of this mode will be 7CH STEREO in the display on the receiver. If the SURROUND BACK speakers are switched off, then the mode will appear as 5CH STEREO.

## STEREO mode

Use the STEREO mode to enjoy standard (two-channel) stereo sound from the front left and right speakers. This mode is most like the sound reproduction you would get from a regular stereo receiver or amplifier that is not equipped to handle A/V formats as this one is. You might want to use this mode for listening to regular music sources (like CDs) but remember, you will only get sound from your front two speakers (and possibly subwoofer).

## Selecting a Sound Mode

To ensure the best possible surround sound, be sure to complete the set up procedures described in "Setting Up for Surround Sound" (starting on page 29) before using the sound modes. This is particularly important when using the **DD** (Dolby) Digital or DTS sources. When using the sound modes, using SPEAKERS A will give the best results. If you use SPEAKERS B the sound will be down mixed to the two front B speakers and the surround sound effect will be lost.

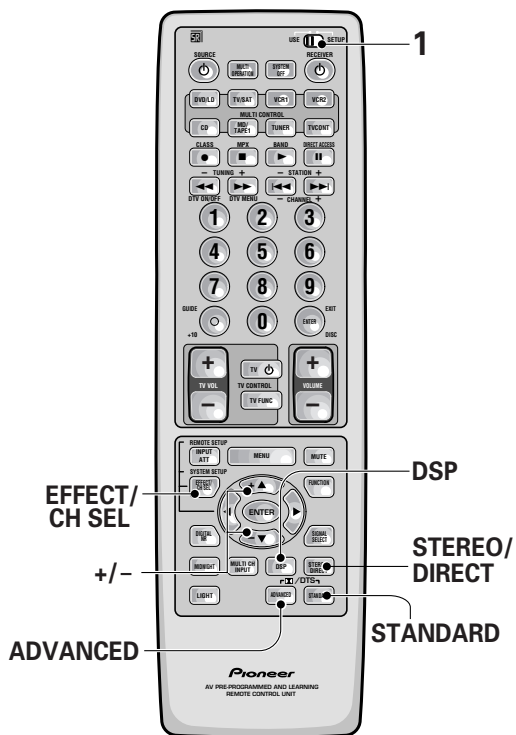

### 1 Put the remote control side switch in USE.

### 2 Select the sound mode.

- For STANDARD → Press STANDARD  
Each press changes the STANDARD mode as follows:

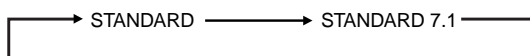

- For ADVANCED THEATER → Press ADVANCED  
Each press changes the ADVANCED THEATER mode as follows:

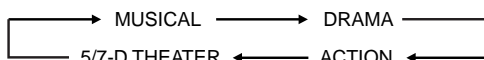

- For DSP modes → Press DSP(DSP MODE) repeatedly  
Each press changes the DSP mode as follows:

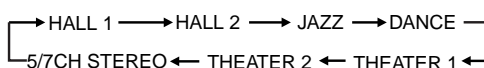

- For STEREO → Press STEREO/DIRECT  
Each press changes the STEREO mode as follows:

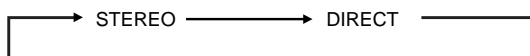

- If you have SURROUND BACK speakers switched on (see p.32-33) then 7-D THEATER and 7CH STEREO will appear as such in the display on the receiver. If these speakers are not switched on the above two modes will appear as 5-D THEATER and 5CH STEREO.
- The effects of ADVANCED THEATER mode can be adjusted in the range of 10 to 90 by pressing EFFECT +/- (The default setting is 70). Also, the effect level can be set in each ADVANCED THEATER mode by pressing the EFFECT(+/-) button.
- The amount of effect of each DSP mode can be adjusted in the range of 10 to 90 (the default setting value is 70) by pressing EFFECT +/-.
- 5/7CH STEREO modes cannot be changed.

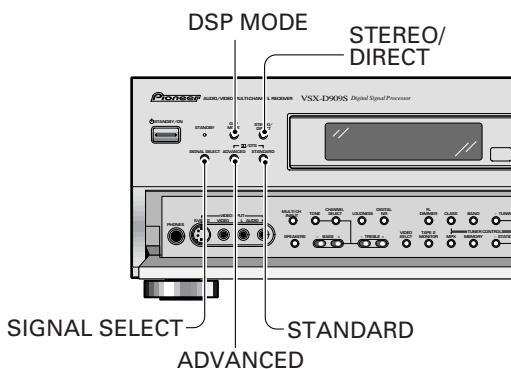

## Playing Sources with Dolby Digital or DTS Sound

The following instructions show you how to play Dolby Digital or DTS sound sources with the VSX-D909S.

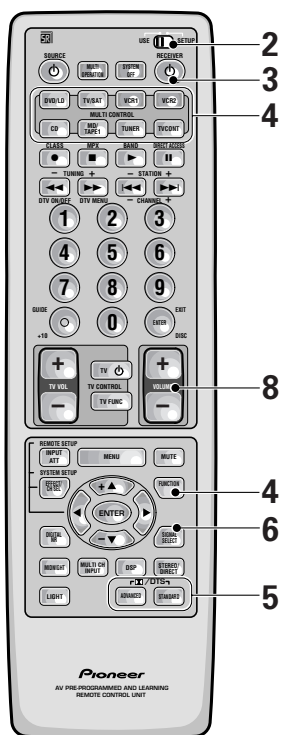

- 1 Turn on the power of the playback component.
- 2 Put the remote control slide switch in USE.
- 3 Press the **RECEIVER** button to turn on the receiver.

Be sure that the standby indicator turns off on the front panel.

- 4 Press the **MULTI CONTROL** buttons or the **FUNCTION** button to select the source you want to playback.

The **FUNCTION** button cycles through the sources in the following order:

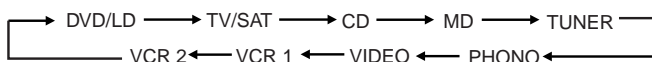

- 5 Choose a sound mode by pressing, **ADVANCED** or **STANDARD**.

The default setting is STEREO.

(For more see "Sound Modes" and "Selecting a Sound Mode" on pages 41-44.)

- 6 Press the **SIGNAL SELECT** button to select the input signal. Set to **AUTO**.

(See "Switching Analog and Digital Signal Input" on page 47.)

- 7 Start playback of the component you selected in step 1.

- 8 Adjust the volume by using the volume buttons on the remote control or the **MASTER VOLUME** on the front panel.

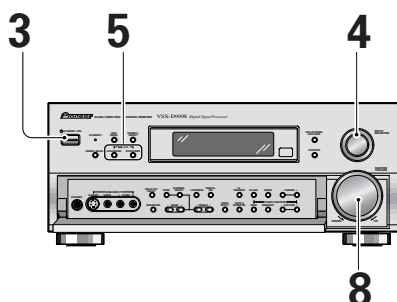

We recommend using different modes for different types of DTS material. For watching movies, the **STANDARD** or **ADVANCED THEATER** setting should provide the best results. For listening to music, the **STANDARD**, **DIRECT**, **STEREO**, or **DSP** modes should serve the listener best.

## Playing Stereo Sources

The following instructions show you how to use the receiver for stereo audio or audio-visual.



If the TAPE 2 indicator is visible in the display, it means the TAPE 2 MONITOR is on. Press TAPE 2 MONITOR on the front panel to turn it off unless you want to listen to TAPE 2.

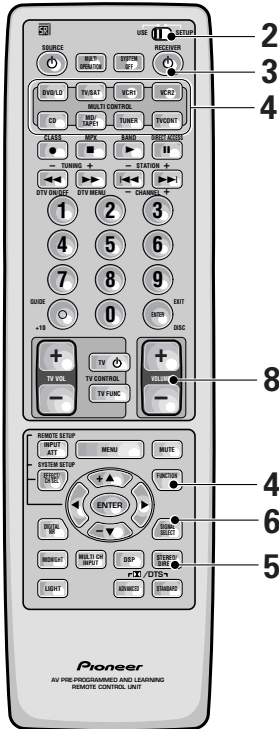

**1 Turn on the power of the playback component.**

**2 Put the remote control slide switch in USE.**

**3 Press the RECEIVER button to turn on the receiver.**

Be sure that the standby indicator turns off on the front panel.

**4 Press the MULTI CONTROL buttons or the FUNCTION button to select the source you want to playback.**

The FUNCTION button cycles through the sources in the following order:

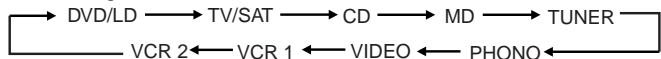

**5 Press the STEREO/DIRECT button to select the stereo mode.**

The STEREO indicator lights on the display.

**6 Press the SIGNAL SELECT button to select the input signal corresponding to the source component.**

(See "Switching Analog and Digital Signal Input" on page 47.)

**7 Start playback of the component you selected in step 1.**

**8 Adjust the volume by using the VOLUME buttons on the remote control or the MASTER VOLUME on the front panel.**

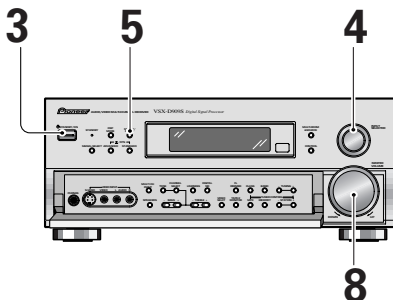

You need to make sure the input is set to the appropriate ANALOG or DIGITAL setting. Refer to page 47 for more on this.

## Switching Analog and Digital Signal Input

This switch moves the input fed to the receiver between analog and digital sources. You need to take special care to switch to the appropriate input, when necessary. For example, the switch would have to be on DIGITAL to use DOLBY DIGITAL or DTS surround sound but it would have to be on ANALOG to record to the analog out jacks on the receiver. The default setting is AUTO (priority is given to a digital signal, if there is one).



### 1 Put the remote control slide switch in USE.

### 2 Press the SIGNAL SELECT button to select the input signal corresponding to the source component.

Each press switches the signal in the order below:



### 3 While SIGNAL SELECT is set to DIGITAL, AC-3 lights when a Dolby Digital signal is input, DTS lights when a DTS signal is input.

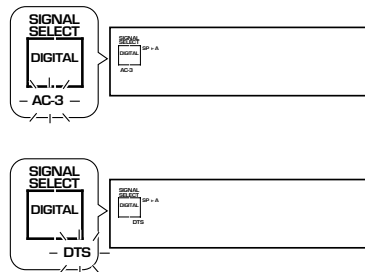

When a Dolby Digital signal is input.

When a DTS signal is input.

2

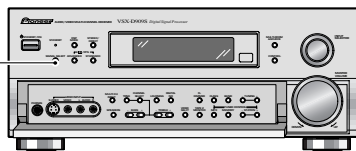

- In the AUTO setting, SIGNAL SELECT chooses the signal in the following order: DIGITAL, ANALOG.
- If the Digital-In Select (see page 31) choices are set to OFF, the SIGNAL SELECT will default to ANALOG.
- Because the audio from a karaoke microphone and LD recorded with analog audio only is not output from the digital output, set SIGNAL SELECT to ANALOG.
- This receiver can only playback Dolby Digital, PCM (32kHz, 44kHz, 48kHz, and 96kHz), and DTS digital signal formats. If you have some equipment that outputs digital audio in a format other than these you'll have to connect and playback via the receiver's analog inputs (make sure that SIGNAL SELECT is set to ANALOG).
- When an LD or CD with DTS is played back with the SIGNAL SELECT set in ANALOG, digital noise caused by playing back the DTS directly (with no decoding) is output. To prevent noise, you need to make digital connections (See pages 13 and 14) and set SIGNAL SELECT to DIGITAL or AUTO.
- Some DVD players don't output DTS signals. For more details, refer to the instruction manual supplied with your DVD player.

## Reducing Noise During Playback

To reduce extraneous noise switch on DIGITAL NR. This noise reduction can be used with every mode except DIRECT and MULTI CH IN.



**1 Put the remote control slide switch in USE.**

**2 Press the DIGITAL NR button on the remote control or on the front panel.**

Each press switches DIGITAL NR on or off.

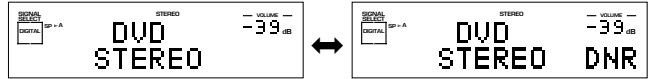

- In cases described below, noises may not be reduced even if DIGITAL NR is on.
  - Sudden noise
  - Extremely loud noise
  - Signals that do not contain many high frequencies
- DIGITAL NR is effective at and above levels shown below for each source.
- DIGITAL NR is effective at and above levels shown below for each source.
  - STEREO (excluding 96 kHz)
  - analog input ..... 10 -18 dB
  - digital input..... 10 -15 dB
  - AM/FM tuner ..... 10 -15 dB
  - DSP/ADVANCED/STANDARD/96 kHz stereo .... 6 -10 dB
- Depending on the condition of the source, there may not be a noticeable improvement in the quality of the sound.



- You can't use the DIGITAL NR mode with the MULTI CH IN mode.
- If you press DIGITAL NR when in DIRECT mode the receiver switches to STEREO mode.

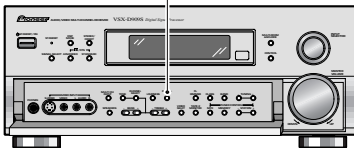



## Listening in Midnight Mode

This feature makes it possible to get excellent surround sound effects even when listening at low volumes. It can be used with a variety of surround sound sources and plays soundtracks so that the quieter sounds are audible while the noisier sounds don't become overly loud or distorted. It does this by bringing all the sounds in a given soundtrack closer together in volume. Compare this feature with the D-Range Control (only for Dolby Digital sources) on page 39.



**1 Put the remote control slide switch in USE.**

**2 Press the MIDNIGHT button.**

Each press switches MIDNIGHT LISTENING mode on or off.



- The effect adjusts itself automatically in accordance with the volume level.
- You can't use the MIDNIGHT LISTENING mode with the MULTI CH IN mode.
- If you press MIDNIGHT when in DIRECT mode the receiver switches to STEREO mode.

## Listening the Loudness Mode

The LOUDNESS mode allows you to boost the bass in a signal. It is useful for listening to music at low volumes.

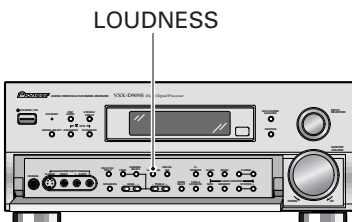

**Press the LOUDNESS button.**

Each press switches LOUDNESS mode between on and off.



- You can't use the LOUDNESS mode with the MULTI CH IN mode.
- If you press LOUDNESS in DIRECT mode the receiver will switch to STEREO mode.

# Adjusting Bass and Treble

You can use BASS +/- or TREBLE +/- buttons to adjust the low and high frequencies for each individual set of speakers. If the receiver is in STEREO mode you can only adjust the FRONT speakers. In a surround mode (STANDARD, ADVANCED THEATER, etc.) you can adjust the FRONT, CENTER, SURROUND and SURROUND BACK speakers. The TONE button can also be used to bypass the tone circuitry (see p.22).

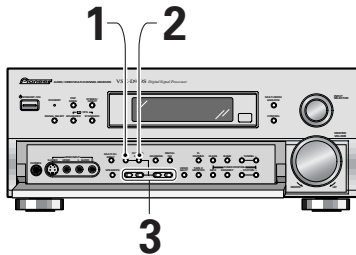

**1 Press the TONE button on the front panel to put the receiver in tone on mode.**

**2 Press the CHANNEL SELECT button on the front panel to cycle through the different tone adjust modes.**

The button cycles through the possibilities in the following order:

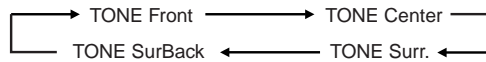

**3 Use the BASS or TREBLE (+/-) buttons to adjust the low or high frequencies of each channel.**

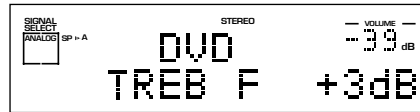

A few seconds after you finish adjusting the tone the receiver will revert to the sound mode it was in at the beginning of the process.



- The tone control can be adjusted in a range of  $\pm 6$  dB.
- The tone control cannot be adjusted in MULTI CH IN mode.
- If the receiver is in DIRECT mode and you press the TONE button, TONE BYPASS will appear in the display, letting you know that you can't change the tone in DIRECT mode. Another press cancels DIRECT mode.

## MULTI CHANNEL IN Playback

MULTI CH IN allows you to connect an external decoder to enjoy certain types of specialized discs. To use MULTI CH IN playback follow the instructions below.



**1 Put the remote control slide switch in USE.**

**2 Press the MULTI CH INPUT button on the remote control or the front panel.**

Each press switches the input between the previous mode and MULTI CH IN.

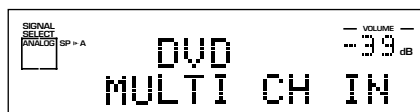

When MULTI CH IN is used in BYPASS mode only the volume level can be set. All of this unit's other features (DIGITAL NR etc.) cannot be used. Also, all speaker settings and other setup settings have no effect.

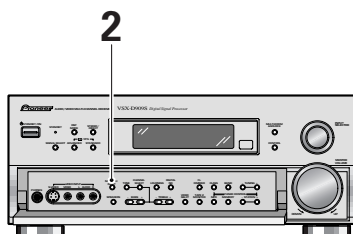

## 96 kHz 24 bit Performance

This receiver is capable of playing back advanced DVD discs which are recorded in 96 kHz/24 bit format (these are all stereo discs), and any source recorded in 96 kHz and up to 24 bit. The receiver will automatically read the format of the disc and play accordingly (of course the SIGNAL SELECT will have to set to AUTO or DIGITAL to read the DVD soundtrack). When the receiver plays a 96 kHz/24 bit disc "96 kHz" and whatever mode you're using (for example "STEREO," "DIRECT" or "DNR") will appear in the display.

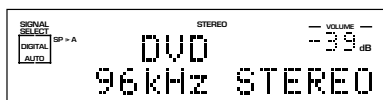

- When a 96 kHz/24 bit disc is played back the volume may be louder than that of a normal disc.
- Some DVD players cannot play 96 kHz/24 bit discs. Check the manual of your DVD player to make sure.
- During this playback the player enters the STEREO mode and you can use the controls available in STEREO mode (LOUDNESS, MIDNIGHT, TONE controls, etc., see p.49-50).
- With 96 kHz/24 bit discs you are able to use MULTI CH IN playback and the TAPE 2 MONITOR.
- In 96 kHz/24 bit mode you can't use the STANDARD, ADVANCED THEATER or DSP mode.

## Direct Playback

This mode is for playing back a sound source in its purest form, no tone adjustments or other sound modes can be used.

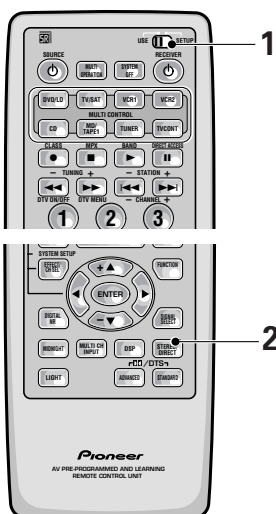

**1 Put the remote control slide switch in USE.**

**2 Use the STEREO/DIRECT button to alternate between STEREO or DIRECT mode (you can also use the STEREO/DIRECT button on the front panel).**

The DIRECT mode will give you the most accurate reproduction of two channel (stereo) sources but won't let you add any effects to the sound.



- None of the tone controls or other sound modes can be used with DIRECT playback.
- If the receiver is in a different mode than STEREO to start with the first push of the STEREO button will put it in STEREO mode. After that the button will toggle the receiver between STEREO and DIRECT mode.
- For more on this button see the explanation of STEREO mode on p.43, 44, 46.

STEREO/  
DIRECT

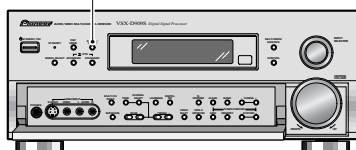

## Adjusting the Brightness of the Display

Use the FL DIMMER button to adjust the brightness of the fluorescent display (FL=fluorescent display).

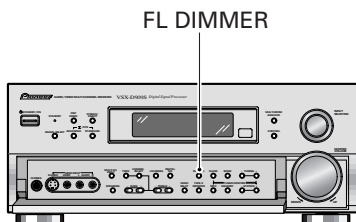

**Press the FL DIMMER button.**

Four levels of brightness ranging from very dim to very bright can be selected. Each press changes the brightness of the display. When rotating through the options, the default brightness can also be selected.



Please note: it is a feature of this unit that the fluorescent display will be brighter for a few seconds after you choose a function (like DVD/LD, CD, etc.) and then get softer. This will still happen when you adjust the brightness but the new setting will be the one the display softens to.

## DUAL MONO Setting

The dual mono setting can only be used when listening to Dolby Digital discs that have dual mono software encoded in them. Dual mono software usually is used to put two different soundtracks on one DVD. With this setting you can choose which channel in the dual mono setting you want to listen to. Thus, it is useful for soundtracks that have one language on one channel and a different language on the other. Remember this setting is only applicable if you are using Dolby Digital software with dual mono and want to isolate one of the channels therein. Otherwise, just ignore this function.

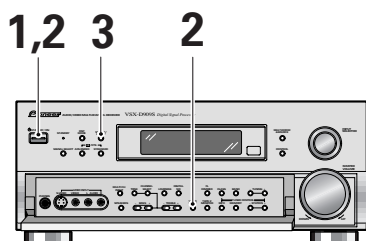

- 1 Put the receiver in **STANDBY** mode.
- 2 While holding down the **VIDEO SELECT** button press the **STANDBY/ON** button on the front panel.
- 3 You will see **DUAL** in the display for about five seconds. During this time use the **STEREO/DIRECT** button to cycle through the different **DUAL MONO** settings to find the one you want.



DUAL ch1 setting



DUAL ch2 setting

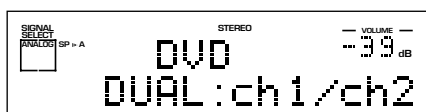

DUAL ch1/ch2 setting



When DUAL MONO is playing with ch 1 selected the L will light. When playing with ch 2 selected the R will light. When playing with ch 1/2 selected the L and R will light.

The different settings are: DUAL ch1, where you only hear channel 1; DUAL ch2, where you only hear channel 2; and DUAL ch1/ch2, where you hear both channels, but independently from different speakers.

The default setting is DUAL ch1.

# Using the Tuner

## Automatic and Manual Tuning

The following steps show you how to tune in FM and AM radio broadcasts using the automatic (search) and manual (step) tuning functions. If you already know the exact frequency of the station you desire, see "Direct Access Tuning" on the following page.

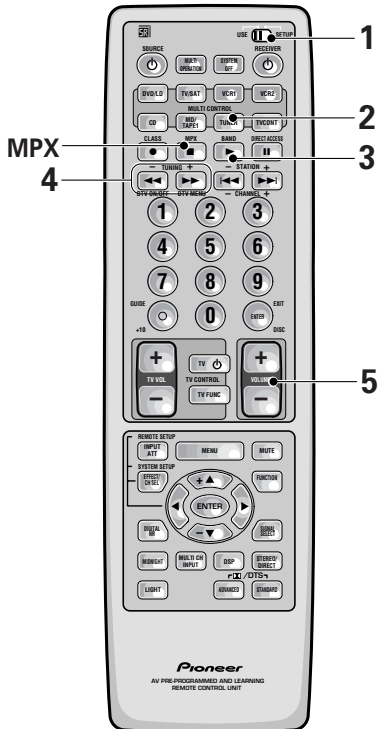

### 1 Put the remote control slide switch in USE.

### 2 Press the TUNER button.

On the remote, this selects the TUNER function on the receiver and sets the remote to the TUNER operation mode.

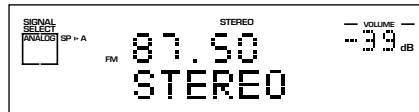

### 3 Press BAND button on the remote control or the front panel to select the band (FM or AM).

Each press switches the band: FM ↔ AM

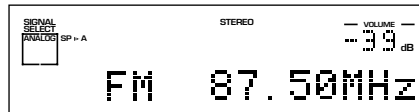

### 4 Tune in the station.

#### For Automatic Tuning

Press and hold TUNING  $-/+$  buttons for about one second, then release.

The tuner starts searching the selected band and stop automatically at the first station it locates. Repeat to locate other stations.

#### For Manual Tuning

- To change frequencies one step at a time, press TUNING  $-/+$  buttons repeatedly.
- To change frequencies quickly, hold down TUNING  $-/+$  buttons and release when you reach the frequency you desire.

### 5 Adjust the MASTER VOLUME buttons on the remote control or the MASTER VOLUME on the front panel.

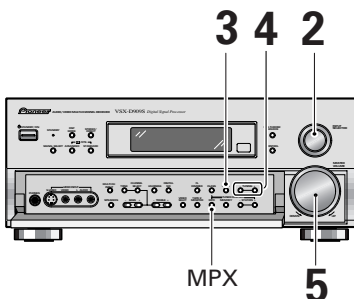

## MPX Mode

If the TUNED or STEREO indicators do not light when tuning an FM station, because the station is too far away or the broadcast signal is weak, press MPX button on the remote control or front panel to switch to MONO reception. This should improve reception enough for you to enjoy the broadcast.

## Direct Access Tuning

The following steps show you how to tune directly to a specific frequency using the remote control.

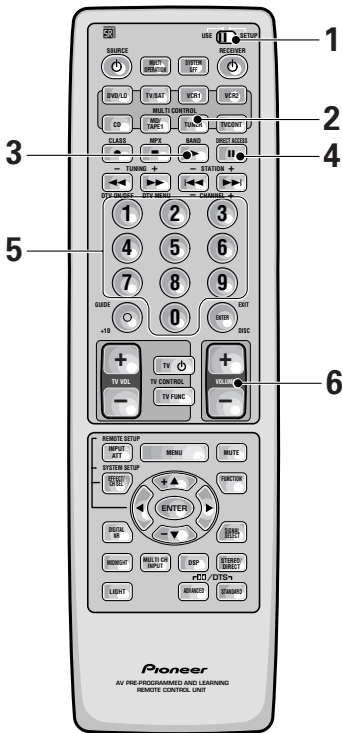

**1 Put the remote control slide switch in USE.**

**2 Press the TUNER button.**

This selects the TUNER function on the receiver and sets the remote to the TUNER operation mode.

**3 Press the BAND button on the remote control or the front panel to select the band (FM or AM).**

Each press switches the band : FM ↔ AM

**4 Press DIRECT ACCESS button to activate the direct Access tuning mode.**

The cursor blinks in the display on the front panel.

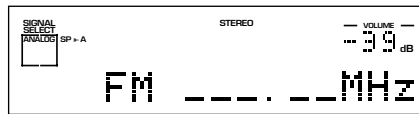

**5 Use the NUMBER buttons to enter the frequency of the station you want.**

**Example:**

To tune station 106.00 (FM), press:

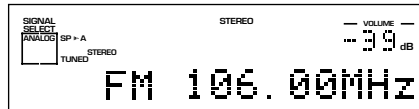
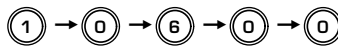

**To cancel before inputting the frequency**

Press DIRECT ACCESS button, and enter the frequency again.

**6 Adjust the MASTER VOLUME buttons on the remote control or the MASTER VOLUME on the front panel.**

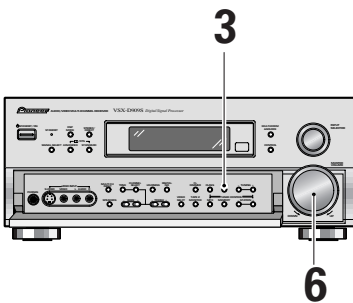

# Memorizing Frequently Used Stations

The following steps show you how to memorize up to 30 radio stations in 3 classes (each holding 10 channels). When memorizing FM frequencies, the receiver also memorizes the MPX mode (STEREO or MONO).

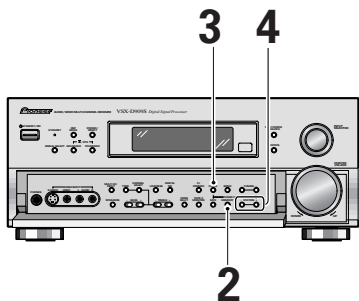

### 1 Tune in the desired station.

See "Automatic and Manual Tuning" or "Direct Access Tuning" on p.54 and 55.

### 2 Press the MEMORY button to activate the memory function.

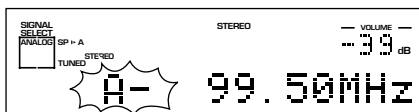

### 3 Press the CLASS button repeatedly to select a class number.

Each press switches the display:

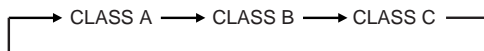

### 4 Press the STATION +/- buttons repeatedly to select a channel (0-9) within the respective class.

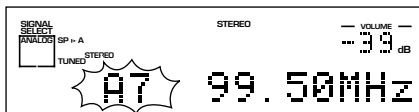

The station is memorized automatically after 5 seconds.

#### If you want to escape from MEMORY mode

Press the MEMORY button again.

**Repeat steps 1 through 4 to memorize up to 30 stations.**



## Recalling Memorized Stations

### Using the remote control

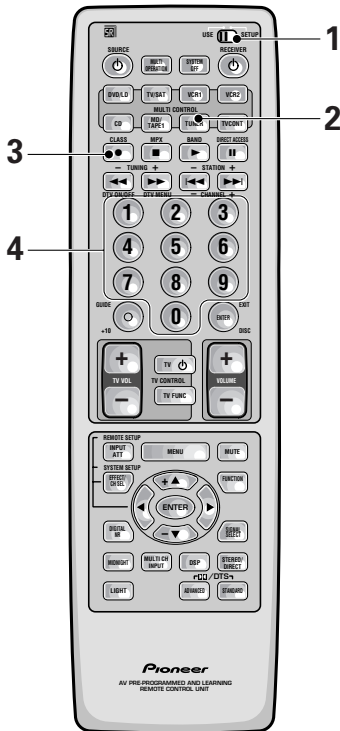

**1 Put the remote control slide switch in USE.**

**2 Press the TUNER button.**

This selects the TUNER function on the receiver and sets the remote to the TUNER operation mode.



**3 Press the CLASS button repeatedly to select a class number.**

Each press switches the display:

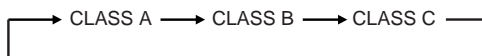

**4 Use the NUMBER buttons to select the channel you want.**

To select channel 7, press **7**.

To select channel 0, press **0**.

For example : If 99.50 MHz (FM) was memorized in class A at channel 7.

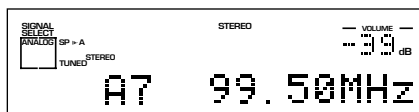

**To skip through each channel in order**

Press STATION -/+ repeatedly.

### Using the front panel

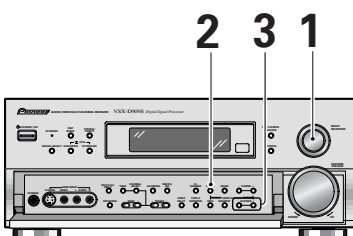

**1 Select the TUNER function.**

**2 Press the CLASS button repeatedly to select a class number.**

**3 Press the STATION -/+ buttons repeatedly to select the channel you want.**

# Remote Control of Other Components

## Setting Up the Remote Control to Control Other Components

In addition to controlling the receiver, the supplied remote control can operate your other components (VCR, TV, LD, CD, etc.) after you program it to do so. In this way, instead of fumbling with many different controls and buttons, you only need to use one remote control. If your component(s) are listed in the remote control's memory, simply follow the steps below. If your component(s) are not listed, or if you want the remote to learn additional operations, you can use the learning mode to input the information from the remote controls supplied with your other components.

### Recalling Preset Codes

The following steps show you how to recall preset codes stored in the remote control. Once a preset code is recalled and the component assigned, you can use this remote to easily operate the component. See "Preset Code List" on page 85 for the components and manufacturers available.

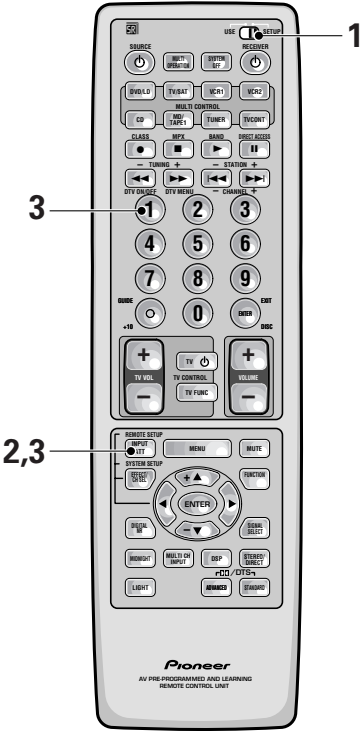

### 1 Set the remote control slide switch to **SETUP**.

Also make sure that your TV is on and set to the receiver.

### 2 Press the **REMOTE SETUP (INPUT ATT)** button.

The REMOTE SET UP menu appears on your TV screen.

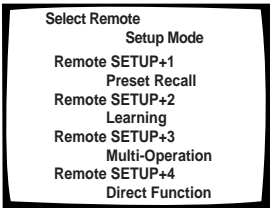

You have four setup options:

- ① Preset Recall
- ② Learning
- ③ Multi Operation (See p.71)
- ④ Direct Function (See p.74)

Preset Recall and Learning are the two modes that teach the remote control to operate your other components. It's easiest to start with Preset Recall and, if setup isn't possible for certain components, move on to the Learning mode.

### 3 Press the **REMOTE SETUP** button and ① at the same time to select the preset recall setup mode.

All the MULTI CONTROL buttons (except the TUNER button) start to blink.

**To cancel the preset recall setup mode press REMOTE SET UP.**

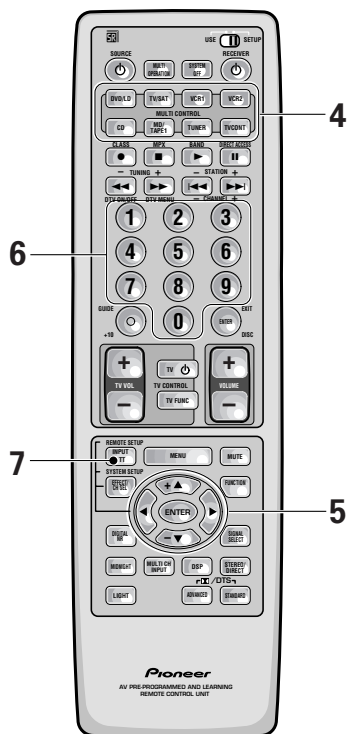

### 4 Press the **MULTI CONTROL** button for the component you want to control.

The selected button lights steadily and the first manufacturer (and preset code(s)) appear on your TV screen.

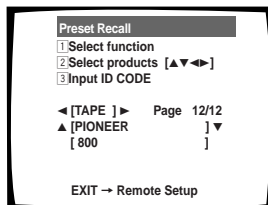

### 5 Press the **◀/▶** buttons to choose the function and then press the **▲/▼** buttons repeatedly to display the name of the component's manufacturer.

Most manufacturers have been programmed into the receiver, but if your component is made by a small or relatively unknown manufacturer you may not be able to find it.

### 6 Point the remote toward the component to be controlled, enter the 3 digit code.

If the component you are trying to control turns on/off, the set up for this component is complete, but components that don't have a standby mode can't respond in this way. To test if you've set it up properly work through step 7. Then try using selecting the function you just set up (for example a CD player) and using the controls on this remote control. If the component does not respond, try working through the procedure again and pressing number 2 instead this time. Continue this procedure until one of the commands works.

### 7 Press the **REMOTE SETUP** button to exit the preset recall setup mode.

The remote control and TV return to their previous operation modes.

- When you're done setting up, remember to set the slide switch back to USE.

## Remote Control of Other Components

### Learning Commands from Other Remote Controls

If preset codes are not available for your component(s), or the available preset codes do not operate correctly, you can use this function to program in signals from the remote control(s) of your other component(s). This operation can also be used after recalling a preset code to program additional operations not covered in the preset codes.

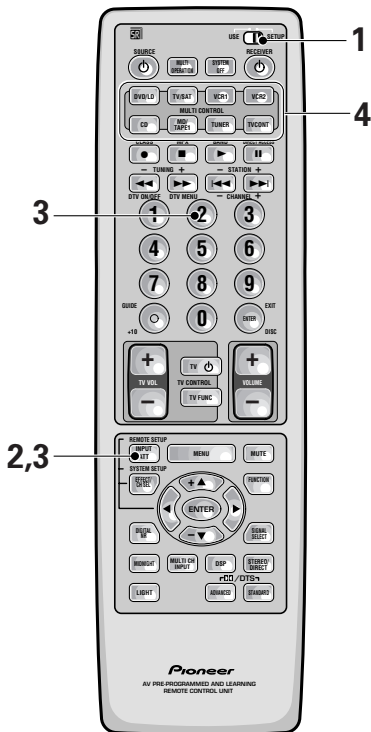

#### 1 Set the remote control slide switch to **SETUP**.

Also make sure that your TV is on and set to the receiver.

#### 2 Press the **REMOTE SETUP** button.

The REMOTE SET UP menu appears on your TV screen.

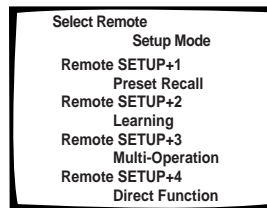

#### 3 Press the **REMOTE SETUP** button and **2** at the same time to select the **Learning setup mode**.

All the MULTI CONTROL buttons (except the TUNER button) start to blink.

To cancel Learning setup mode, press the **REMOTE SET UP** button.

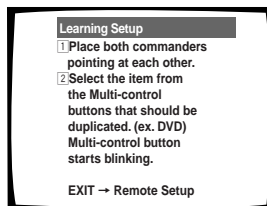

#### 4 Press the **MULTI CONTROL** button for the component you want to control.

Each button can be set to control one of the following components.

The selected button continues to blink.

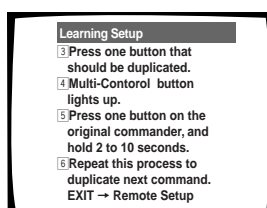

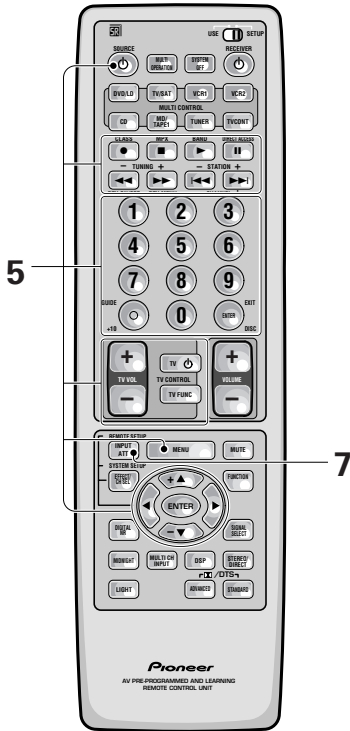

### 5 Press the button to be programmed.

The MULTI CONTROL button lights steadily.

- The TV POWER, TV FUNC and TV VOL +/- buttons are only available for learning when programming TV CONTROL operations.

### 6 Point the remote controls at each other and press the button on the other remote control for the operation you wish to program.

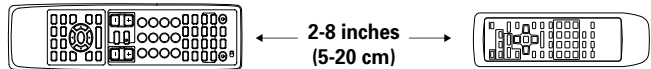

- ① Point the remote controls toward each other.
- ② Hold down the button on the other remote control corresponding to the operation you wish to program. Release when the MULTI CONTROL button on the receiver's remote control starts blinking.

(The MULTI CONTROL button blinks to indicate that the operation has been learned.)

**To program additional operations for the current component, repeat steps 5 and 6.**

**To program operations for another component, repeat steps 4 through 6.**

### 7 Press the REMOTE SETUP button to exit the learning setup mode.

The remote control and TV return to their previous operation modes.

- When you're done setting up, remember to set the slide switch back to USE.

# Using the Remote Control with Other Components

## DVD or LD Player Operations

- The following operations are available from the receiver's remote control after you program your DVD or LD player's preset code, but some operations may need to be learned by the receiver (see "Setting Up the Remote Control to Control Other Components," on pages 58-61).
- To perform these operations, press the **DVD/LD** button to set the remote to the DVD or LD operation mode.
- For more information on individual commands consult the manual that came with the component.

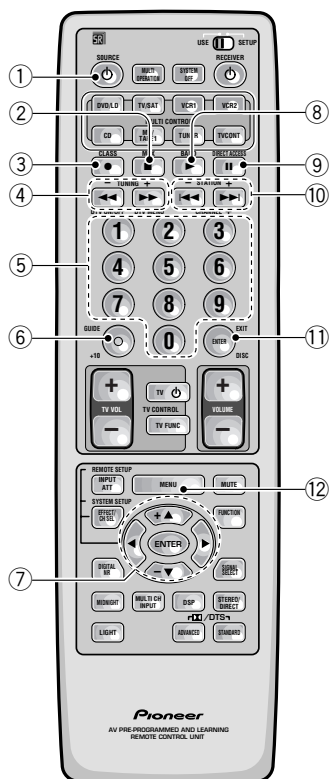

### ① **SOURCE**

Press to switch the DVD or LD player on or off (not possible with all models, especially those without a standby mode).

### ② **■**

Press to stop playback.

### ③ **● (TOP MENU)**

Press to call up the menu programmed on the DVD (for DVD only).

### ④ **◀◀/▶▶**

◀◀ : Hold down for fast reverse playback.  
▶▶ : Hold down for fast forward playback.

### ⑤ **Number buttons**

Use to select chapters (tracks).

### ⑥ **+10**

Use when selecting chapter (track) numbers higher than 10.

### ⑦ **▲/▼/◀/▶/ENTER**

▲/▼/◀/▶ : Use to navigate through options on menu screens and to change settings.

**ENTER** : Use to implement settings selected with the cursor buttons or to set items highlighted in a menu (for DVD only).

### ⑧ **▶**

Press to start playback.

### ⑨ **||**

Press to pause playback.

### ⑩ **◀◀/▶▶**

◀◀ : Press to return to the beginning of the current chapter (track). Press repeatedly to return to the beginning of previous chapters (tracks).

▶▶ : Press to advance to the beginning of the next chapter (track). Press repeatedly to advance to the beginning of following chapters (tracks).

### ⑪ **ENTER (SIDE A/B)**

Use to change the LD between sides A and B (for LD only).

### ⑫ **MENU**

Press to access a disc's menu.

### VCR & DVD Recorder Operations

- The following operations are available from the receiver's remote control after you program your VCR or DVD video recorder's preset code, but some operations may need to be learned by the receiver (see "Setting Up the Remote Control to Control Other Components," on pages 58-61).
- To perform these operations, press the **VCR 1** or **VCR 2** button to set the remote to the VCR, DVD video recorder operation mode.
- For more information on individual commands consult the manual that came with the component.

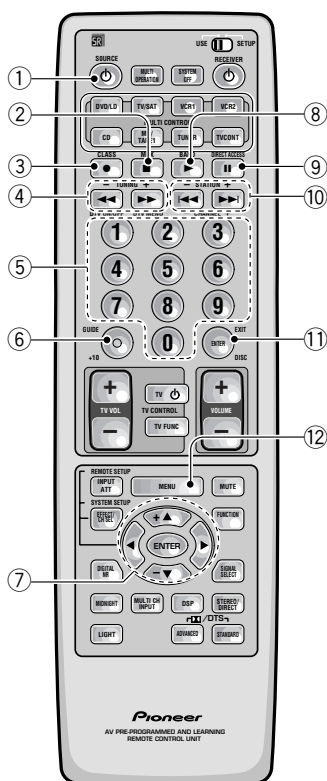

#### ① **SOURCE**

Press to switch the VCR or DVD video recorder on or off (not possible with all models, especially those without a standby mode).

#### ② **STOP**

Press to stop playback.

#### ③ **RECORD**

Press to start recording.

#### ④ **F.F./F.R.**

◀◀ : Hold down for fast reverse playback.

▶▶ : Hold down for fast forward playback.

#### ⑤ **Number buttons**

Use to select channels.

#### ⑥ **+10**

Use when selecting chapter (track) numbers higher than 10 (for DVD video recorder only).

#### ⑦ **▲/▼/◀/▶/ENTER**

▲/▼/◀/▶ : Use to navigate through options on menu screens and to change settings.

**ENTER** : Use to implement settings selected with the cursor buttons or to set items highlighted in a menu (for DVD video recorder only).

#### ⑧ **▶**

Press to start playback.

#### ⑨ **||**

Press to pause playback.

#### ⑩ **CHANNEL +/-**

Use to change channels on the VCR's tuner.

#### ⑪ **ENTER (TV/VCR)**

Use this button to switch the VCR between its tuner (for watching videos) and the TV.

Press to stop recording (for DVD video recorder only).

#### ⑫ **MENU**

Use to display or close the title menu screen (for DVD video recorder only).

## Remote Control of Other Components

### CD & CD-R Player Operations

- The following operations are available from the receiver's remote control after you program your CD player or CD-R's preset code, but some operations may need to be learned by the receiver (see "Setting Up the Remote Control to Control Other Components," on pages 58-61).
- To perform these operations, press the **CD** button to set the remote to the CD operation mode.
- For more information on individual commands consult the manual that came with the component.

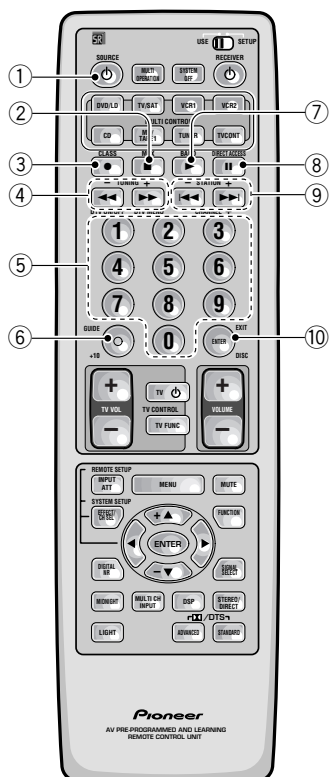

#### ① **POWER**

Press to switch the CD player/recorder on or off (not possible with all models, especially those without a standby mode).

#### ② **STOP**

Press to stop playback.

#### ③ **RECORD**

Press to start recording (CD-R only).

#### ④ **FAST REVERSE / FAST FORWARD**

◀◀ : Hold down for fast reverse playback.

▶▶ : Hold down for fast forward playback.

#### ⑤ **Number buttons**

Use to select channels.

#### ⑥ **+10**

Use when selecting chapter (track) numbers higher than 10.

#### ⑦ **PLAY**

Press to start playback.

#### ⑧ **PAUSE**

Press to pause playback.

#### ⑨ **TRACK**

◀◀ : Press to return to the beginning of the current track.

Press repeatedly to return to the beginning of previous tracks.

▶▶ : Press to advance to the beginning of the next track. Press repeatedly to advance to the beginning of following tracks.

#### ⑩ **DISC**

Use to switch between discs in file type disc play.



### MD Operations

- The following operations are available from the receiver's remote control after you program your MD recorder's preset code, but some operations may need to be learned by the receiver (see "Setting up the Remote Control to Control Other Components," on pages 58-61).
- To perform these operations, press the **MD/TAPE 1** button to set the remote to the MD operation mode.
- For more information on individual commands consult the manual that came with the component.

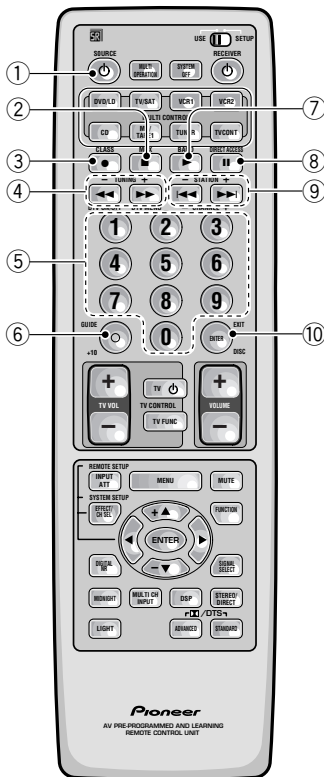

#### ① **SOURCE**

Press to switch the MD player on or off (not possible with all models, especially those without a standby mode).

#### ② **■**

Press to stop playback or recording.

#### ③ **●**

Press to start recording (may put some decks in REC PAUSE mode).

#### ④ **◀▶/▶▶**

◀◀ : Hold down for fast reverse playback.

▶▶ : Hold down for fast forward playback.

#### ⑤ **Number buttons**

Use to select tracks.

#### ⑥ **+10**

You can also use this button when selecting track numbers higher than 10. It's especially use for track numbers 11-19.

#### ⑦ **▶**

Press to start playback.

#### ⑧ **||**

Press to pause playback.

#### ⑨ **◀◀/▶▶**

◀◀ : Press to return to the beginning of the current track.

Press repeatedly to return to the beginning of previous tracks.

▶▶ : Press to advance to the beginning of the next track. Press repeatedly to advance to the beginning of following tracks.

#### ⑩ **DISC (DISP/CHARA)**

Allows you to change the display mode of the MD.

## Remote Control of Other Components

### STB (satellite tuner) Operations

- The following operations are available from the receiver's remote control after you program your satellite tuner's (or cable TV's) preset code, but some operations may need to be learned by the receiver (see "Setting Up the Remote Control to Control Other Components," on pages 58-61).
- To perform these operations, press the **TV/SAT** button to set the remote to the SAT operation mode.
- For more information on individual commands consult the manual that came with the component.

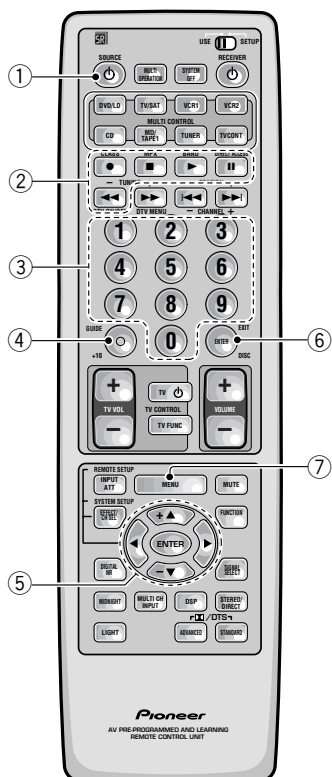

#### ① **SOURCE**

Press to switch the satellite tuner on or off (not possible with all models, especially those without a standby mode).

#### ② **●/■/▶/⏸/◀◀ (A/B/C/D/E)**

Use to make selections from Satellite functions.

#### ③ **Number buttons**

Use to select satellite channels.

#### ④ **GUIDE**

Use to turn the program information screen on or off.

#### ⑤ **▲/▼/◀/▶/ENTER**

**▲/▼/◀/▶** : Press the button to select items on the SAT GUIDE screen or SAT MENU screen.

**ENTER** : Press to activate the selected function.

#### ⑥ **EXIT**

Press to exit the current setting of the SAT.

#### ⑦ **MENU**

Use to turn the main menu on or off.

### TV Operations

- The following operations are available from the receiver's remote control after you program your TV's preset code, but some operations may need to be learned by the receiver (see "Setting Up the Remote Control to Control Other Components," on pages 58-61).
- To perform these operations, press the **TV/SAT** and **TV CONT** button to set the remote to the TV operation mode.
- For more information on individual commands consult the manual that came with the your TV.

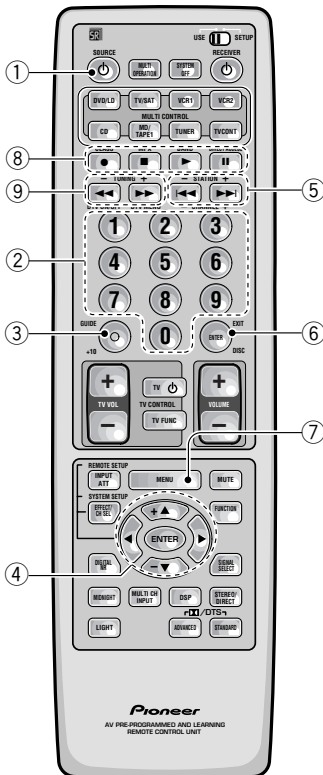

① **POWER SOURCE**

Press to switch the TV on or off (not possible with all models, especially those without a standby mode).

② **Number buttons**

Use to select a specific TV channel.

③ **Left Arrow**

Use to select a specific TV channel.

④ **▲/▼/◀/▶/ENTER**

▲/▼/◀/▶/ : Press to select or adjust items on the menu screen.

**ENTER** : Press to activate the selected function.

⑤ **CHANNEL +/-**

Use to select a TV channel.

⑥ **DISC (CH ENTER)**

Use to select the channel specified with the number buttons (not all models require this step).

⑦ **MENU**

Press to select the TV menu.

### For Digital TVs:

⑧ **◀/▶/◀◀/▶▶/◀◀◀/▶▶▶ (BLUE/GREEN/RED/YELLOW)**

Use to mark selections from the DTV menu.

⑨ **◀◀/▶▶ (DTV ON/OFF/DTV MENU)**

◀◀ : Press to DTV mode on or off.

▶▶ : Press to select the DTV menu.

## Remote Control of Other Components

### Cassette Deck Operations

You can use this remote control to control most cassette decks, though with some models the functions may differ.

- The following operations are available from the receiver's remote control after you recall a cassette deck's preset code, but some operations may need to be learned by the receiver (see "Setting Up the Remote Control to Control Other Components," on pages 58-61).
- To perform these operations, press the **MD/TAPE 1** button to set the remote to the TAPE operation mode.
- For more information on individual commands consult the manual that came with the component.

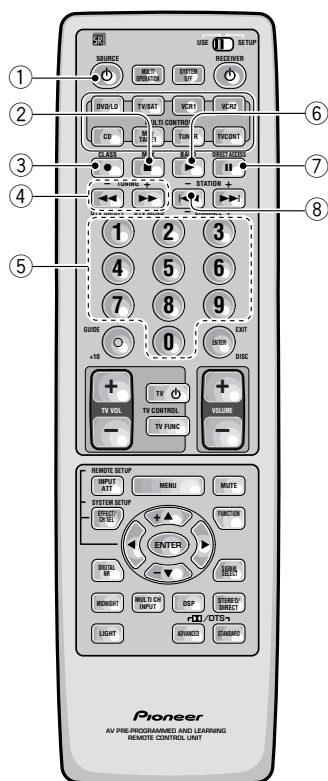

#### ① **POWER**

Press to switch the cassette deck on or off (not possible with all models, especially those without a standby mode).

#### ② **STOP**

Press to stop playback or recording.

#### ③ **RECORD**

Press to start recording.

#### ④ **REWIND / FAST FORWARD**

◀◀ : Press to rewind the tape.

▶▶ : Press to fast forward the tape.

#### ⑤ **Number buttons (1-6)**

**1** : ■ (Press to stop playback or recording.)

**2** : ▶ (Press to start playback of the side of the cassette which has been loaded as the front.)

**3** : || (Press to pause playback or recording.)

**4** : ◀◀ (Press to rewind the tape.)

**5** : ◀ (Press to start reverse playback.)

**6** : ▶▶ (Press to fast forward the tape.)

#### ⑥ **PLAY**

Press to start playback of the side of the cassette which has been loaded as the front.

#### ⑦ **PAUSE**

Press to pause playback or recording.

#### ⑧ **REVERSE**

Press to start reverse playback (for auto reverse decks).

# Using Other Functions

## Recording from Audio Components

The following explanations show you how to record an analog or digital audio signal. Note that your analog components cannot record a player that is only connected digitally (and vice-versa). If you want to record from a digital component to an analog one (for example, a tape deck), or vice-versa, the digital component it must be connected via analog jacks and you need to set the SIGNAL SELECT switch to ANALOG. To make exact digital copies (of digital sources like CDs) both the source component and the recorder must be connected with digital connections. See p.12 for more on analog audio connections and p.13 for digital audio connections.



The receiver's volume, channel level, balance, TONE, DIGITAL NR, MIDNIGHT, LOUDNESS and surround effects have no effect on the recorded signal and the MULTI CH IN cannot be recorded. In some cases, digital recordings have copy guard protections and making a digital copy is not possible. In this case you can only copy them in an analog manner.



### 1 Select the source component. Set SIGNAL SELECT according to the source component's signal (ANALOG or DIGITAL).

Press the SIGNAL SELECT button on the remote control (or use the button on the front panel) and choose ANALOG.

### 2 Start recording with a recorder.

### 3 Playback the source to be recorded.

### Record monitor (TAPE 2 MONITOR)

If you connect a cassette deck with a record monitor function to the TAPE 2 MONITOR jacks, you can listen to the sound of an analog recording as it is being recorded.

Press TAPE 2 MONITOR to switch between the sound of the recording (TAPE 2 indicator on) and the sound of the source component (TAPE 2 indicator off).

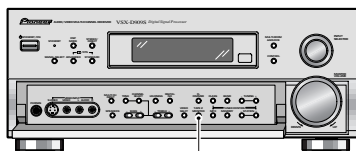

TAPE 2 MONITOR

# Recording from Digital Audio Components

The following explanations show you how to record digital audio. Using this method you can make exact digital copies of sources like CDs or MDs. The only drawback is that you cannot switch between various recorders at the touch of a button like you can with analog recordings (see the previous page). If you look on the back of the receiver you will find 2 digital out jacks which are marked PCM/DD/DTS/ (these are to the right of the digital in jacks in the upper left-hand corner). If you connect one of these to the optical input on a digital recorder (currently these include MD, DAT, and CD-R), you can make direct digital recordings with this unit. Of course, the digital components you want to record, all need to be connected to the receiver with digital inputs as well. See p.13 if you have not made these connections.



The receiver's volume, channel level, tone (BASS, TREBLE, and LOUDNESS), and surround effects have no effect on the recorded signal.

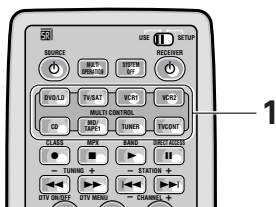

- 1 Prepare the source you want to record and put the receiver in that function. Set SIGNAL SELECT to DIGITAL.**

Press the SIGNAL SELECT button on the remote control (or use the button on the front panel) and choose DIGITAL.

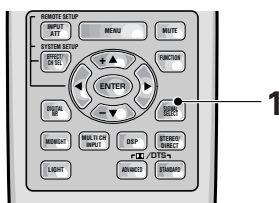

- 2 Start recording with a CD-R or MD (etc.).**

- 3 Play back the source to be recorded.**



In some cases, digital recordings have copy guard protections on them and making a digital copy is not possible. It is still possible to copy these digital sources if you have hooked the components up with analog connections (in this case, the copies will not be exact digital reproductions). Refer to the previous page in this case.

# Recording from Video Components

The following operations show you how to record audio and video to the video tape recorder connected to the VCR 1, VCR 2 or DVR jacks. Note that all signals coming out of these jacks will be analog and it is not possible to record Dolby Digital/DTS soundtracks.



The receiver's volume, channel level, balance, TONE, DIGITAL NR, MIDNIGHT, LOUDNESS and surround effects have no effect on the recorded signal.

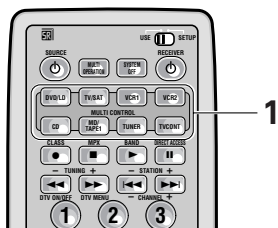

- 1 First, decide the component you'd like to record and put the receiver in that function. Set the SIGNAL SELECT to analog.**

Press the SIGNAL SELECT button on the remote control (or use the button on the front panel) and choose analog. Recording DIGITAL signals is not possible.

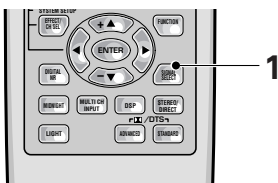

- 2 Start recording with VCR 1 or VCR 2 (etc.).**

- 3 Playback the source to be recorded.**

## Multi Operations

A Multi Operation is a sequence of commands programmed into a single button to save you a lot of repetitive button pressing. Once setup, pressing the MULTI OPERATION button followed by one of the MULTI CONTROL buttons will switch on that component, the receiver and your TV, and switch the function of the receiver to that component. Up to five more commands can be programmed into a Multi Operation, such as changing the sound mode of the receiver and starting playback of the source.

Important: For Multi Operations to work with other non-Pioneer components, you must first setup the remote to control those other components—see pages 58-61 for more on this.

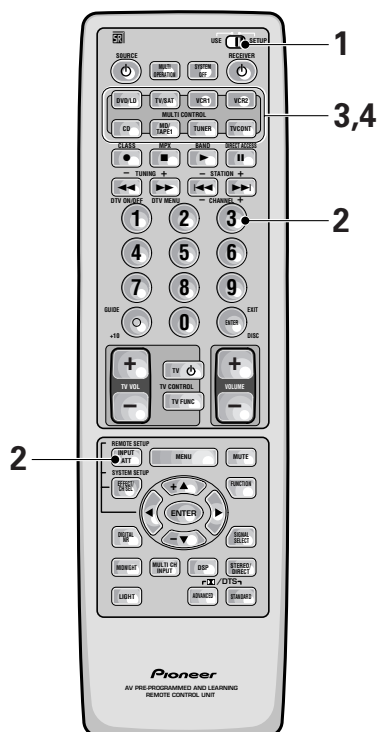

### 1 Set the remote control slide switch to **SETUP**.

Also make sure that your TV is on and set to the receiver.

### 2 Press the **REMOTE SETUP** button (**INPUT ATT**) and **3** at the same time to select the **MULTI OPERATION SETUP** mode.

The REMOTE SETUP menu appears on your TV screen. The MULTI CONTROL and the SYSTEM OFF buttons start to blink (see the following page for more on the SYSTEM OFF button).

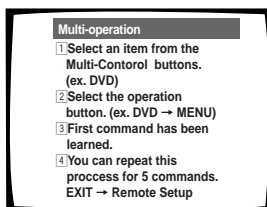

- To cancel here, press REMOTE SETUP.

### 3 Select a **MULTI CONTROL** button for this **MULTI OPERATION**.

Each MULTI CONTROL button can be used for one Multi Operation. If a Multi Operation relates to using a DVD player, for example, it makes sense to select the DVD/LD button.

After pressing a MULTI CONTROL button, just that button will remain blinking.

### 4 Select the **MULTI CONTROL** button for a **source component**.

For example, if you want this Multi Operation to switch on your DVD player and press the DVD/LD.

After pressing a MULTI CONTROL button, that button stays lit.

## Using Other Functions

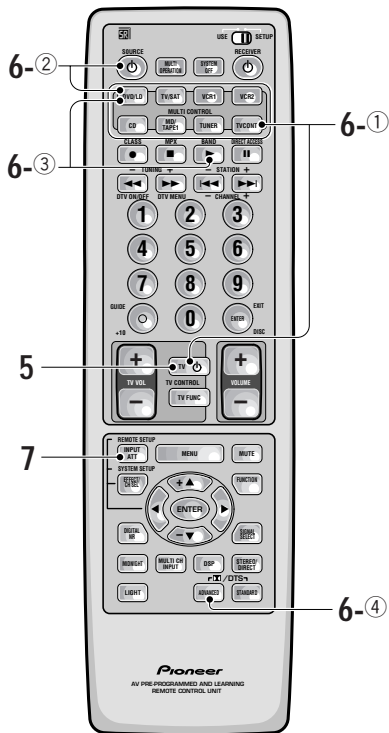

**5 Press the operation button, for example TV  $\phi$  (POWER), you want to input.**

**6 Repeat steps 4 and 5 to input MULTI OPERATIONS to the MULTI CONTROL button you pressed in step 3. You can also tell the receiver to go into a specific sound mode (ADVANCED, STANDARD, MULTI CH IN, MIDNIGHT, DSP, DNR or STEREO) by inputting that command (for example, see operation 4 below).**

**You can repeat this process for up to five commands.**

**For example :** you could enter the following four operations using the preceding steps 4 and 5.

- ① Press the TV CONTROL button and TV  $\phi$  (POWER) to turn on your TV (as explained above).
- ② Press the DVD/LD button then  $\phi$  (POWER) to turn on your DVD player (if it is not a PIONEER product).
- ③ Press the DVD/LD button then ► (play) to start playing the DVD player.
- ④ Press the ADVANCED button to put the receiver in that sound mode.

When you employ MULTI OPERATIONS (see below), these four tasks will be performed in the same order.

**7 Press the REMOTE SETUP button to exit the Multi-operation setup mode.**

The remote control and TV return to their previous operation modes.

## Performing Multi Operations

Once you've programmed a Multi Operation, here's how to use it.

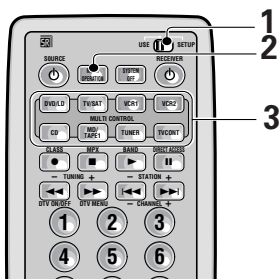

**1 Set the remote control slide switch to USE.**

**2 Press the MULTI OPERATION button on the remote control.**

The MULTI CONTROL buttons start to blink.

**3 Press the MULTI CONTROL button to activate that Multi Operation.**

The remote sends the Multi Operation commands you programmed.



## System Off

The SYSTEM OFF feature allows you to tell the receiver and your other components to stop and turn off with the push of only one button on the remote control (**this feature will only work with components that have a standby mode**). For example, you can program the unit to stop your DVD, turn off your TV, turn off your DVD player and turn off the receiver itself. You don't need to program in other the power for PIONEER components, they will go off automatically in this mode. The receiver itself will go off automatically as well. The steps below show you how to program a string of up to 5 different SYSTEM OFF operations based on eight possible components.



Be sure to recall or teach the remote control commands for each component before attempting MULTI OPERATIONS (see "Setting Up the Remote Control to Control Other Components," page 58-61).

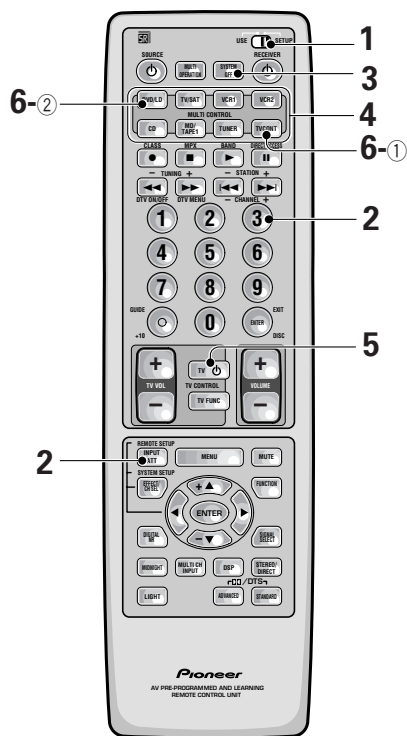

### 1 Set the remote control slide switch to SETUP.

Also make sure that your TV is on and set to the receiver.

### 2 Press the REMOTE SETUP (INPUT ATT) button and ③ at the same time to select the MULTI OPERATION SETUP mode.

The REMOTE SETUP menu appears on your TV screen. The MULTI CONTROL and the SYSTEM OFF buttons start to blink.

To cancel MULTI OPERATION SETUP mode, press REMOTE SETUP.

### 3 Press the SYSTEM OFF button.

The SYSTEM OFF button will blink.

### 4 Press the MULTI CONTROL button for the component whose operation you want to start SYSTEM OFF with (for example, TV CONT button).

The selected button will light steadily.

### 5 Press the operation, for example TV ⏻ (POWER), you want to input.

### 6 Repeat steps 3 and 4 to program a sequence of up to five stop or power off commands you want to input. You can repeat this process for up to five commands.

For example : you could enter the following two operations using the proceeding steps 3 and 4.

- ① Press TV CONT button & TV ⏻ (POWER) to turn off your TV (as explained above).
- ② Press DVD/LD then ⏻ (POWER) to turn off your DVD player (if it is not a PIONEER product).

When you employ SYSTEM OFF (see below), these two tasks will be performed in the same order.

- To exit SYSTEM OFF SETUP mode, press REMOTE SETUP.
- When you're done setting up, remember to set the slide switch back to USE.

## Using Other Functions

### Using the System Off Button

This button will turn off the receiver and any component that has programmed into the SYSTEM OFF settings (see above) as well as turn off all PIONEER components regardless of whether they have been programmed into SYSTEM OFF. If you use this feature when a DVD is playing, the player will stop the play mode before switching off.



**1 Set the remote control slide switch to USE.**

**2 Press the SYSTEM OFF button on the remote control.**

## Setting Up the Direct Function

The DIRECT FUNCTION is designed in case you have an external video source connected to your TV (a video source that is not going through the receiver). For this explanation we'll call this the "external video deck." You'd like to control the external video deck with this unit's remote control so you've assigned it a function button (for example purposes, the VCR 2 button). Yet, if you put the receiver in VCR 2 mode you'll get no picture on your TV because the external video deck signal is not going through the receiver. To get around this problem you set the DIRECT FUNCTION for VCR 2 to OFF. Now when you press VCR 2 function button you can control the external video deck with the remote but the receiver does not go into VCR 2 mode.

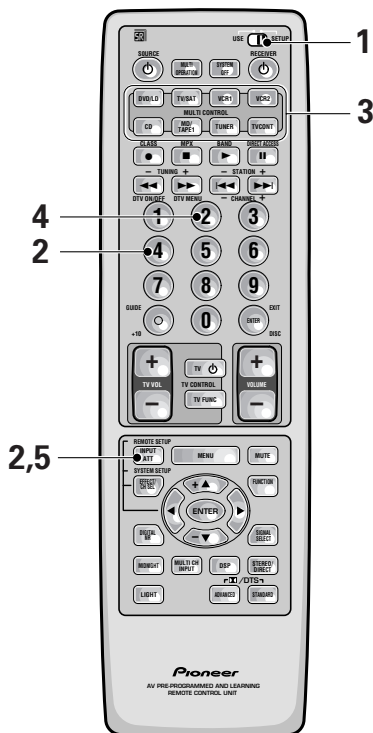

**1 Set the remote control slide switch to SETUP.**

Also make sure that your TV is on and set to the receiver.

**2 Press the REMOTE SETUP (INPUT ATT) button and 4 at the same time to select the DIRECT FUNCTION mode.**

The MULTI CONTROL buttons DVD/LD, TV/SAT, VCR 1, VCR 2, CD, and MD/TAPE 1 start to blink.

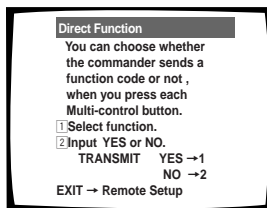

**3 Select a component by pressing its MULTI CONTROL button.**

**4 Set the DIRECT FUNCTION of each external source to NO by pressing 2.**

**5 Press the REMOTE SETUP button to exit the DIRECT FUNCTION mode.**

- When you're done setting up, remember to set the slide switch back to USE.



The default setting is all YES. If you have turned a DIRECT FUNCTION to NO and want to turn it back to YES, follow the directions above and press 1 in step 3.

## Remote Back Light

When you press any button on the remote all the buttons light for a few seconds. You can change the strength of this light here. The default backlighting mode is MID, MAX is the strongest. MID is slightly weaker. There's also the option to switch off backlighting altogether. This extends battery life considerably.

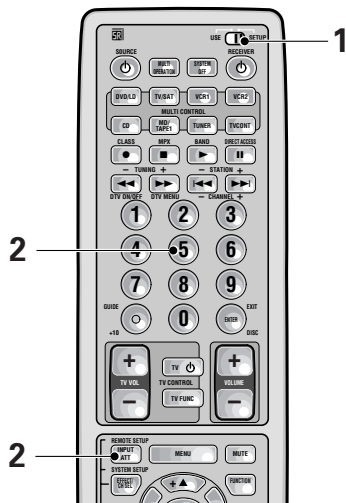

**1 Set the remote control slide switch to SETUP.**

**2 Press and hold both the REMOTE SETUP (INPUT ATT) button and 5.**

The remote back light options cycle in the following order:



The default setting is MID.

- When you're done setting up, remember to set the slide switch back to USE.

## Resetting the Remote Control

The following operations allow you to erase the settings stored in the remote control.

### Erasing Multi Operations

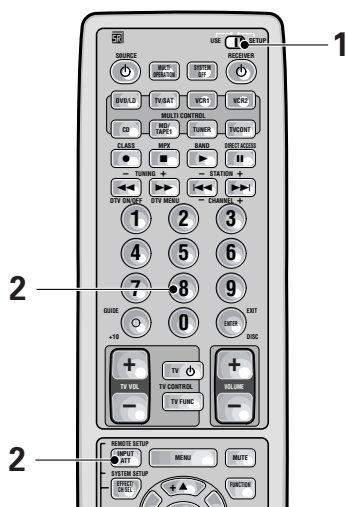

**1 Set the remote control slide switch to SETUP.**

**2 Press and hold both the REMOTE SETUP (INPUT ATT) button and 8 for more than 3 seconds.**

The MULTI CONTROL buttons will blink 3 times and all multi operation settings will be erased.

- When you're done setting up, remember to set the slide switch back to USE.

## Erasing Learned Remote Control Commands

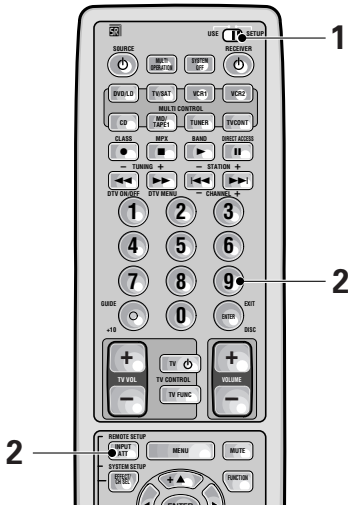

**1 Set the remote control slide switch to SETUP.**

**2 Press and hold both the REMOTE SETUP (INPUT ATT) button and 9 for more than 3 seconds.**

The MULTI CONTROL buttons will blink 3 times and all signals which have been learned from other remote controls will be erased.

- When you're done setting up, remember to set the slide switch back to USE.

## Erasing All Learned Commands and Preset Codes

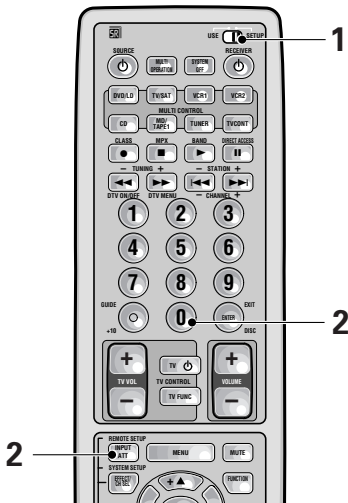

**1 Set the remote control slide switch to SETUP.**

**2 Press and hold both the REMOTE SETUP (INPUT ATT) button and 0 for more than 3 seconds.**

The MULTI CONTROL buttons, SYSTEM OFF button, and MULTI OPERATION button will blink 3 times and all preset and learned codes will be erased.

- When you're done setting up, remember to set the slide switch back to USE.

## Video Select

This function allows you to listen to one sound source while you watch a different video source on your TV. The sound source is set in the normal fashion as is explained on p.45. You then alter the video input with the VIDEO SELECT button.

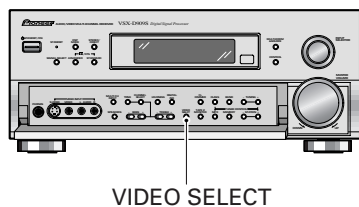

### Press the VIDEO SELECT button on the front panel to cycle through the different possible video inputs.

The first press shows the video input you are currently using. After that pressing VIDEO SELECT cycles through the possibilities in the following order:

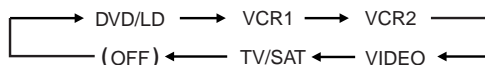

The OFF setting means the AUDIO and VIDEO source are the same. (Also, if one of the MD/TAPE 1, CD, TUNER, or PHONO functions are selected the VIDEO SELECT will be set to OFF.)

After choosing a video input the display on the receiver will show that input for about 5 seconds and then revert to showing the sound mode the receiver is in.

### The VIDEO SELECT remains set to the input you chose until you change the audio input.

If you change audio functions the receiver will reset itself to make the video and audio inputs correspond.

Also, if you switch the power of the receiver OFF when you turn it back on the video and audio inputs will reset so that they correspond.

## Multi-Room

When used together with an optional IR receiver, this receiver is capable of outputting two different sources at the same time. One to the (main) MONITOR OUT jack and SPEAKERS terminals and another to the MULTI ROOM & SOURCE AUDIO and MONITOR OUT jacks. Thus the VSX-D909S can power two independent systems, in separate rooms, listening to or watching different sources. With this system the two rooms can have completely independent power (the main room power can be off while the sub room is on) and the sub room can be controlled by this unit's remote control. If you go into the main room to change the source but forget the remote control it's not a problem. While in MULTI ROOM mode the input selector on the front panel of the VSX-D909S is able to change the input even though the receiver is off.

### MULTI-ROOM connections

On the VSX-D909S, connect the IR receiver sensor to the MULTI-ROOM & SOURCE REMOTE IN jack, then connect a separate amplifier (and speakers) and TV monitor to the MULTI-ROOM & SOURCE OUT and MONITOR OUT jacks. All of this equipment should be placed in your sub-room as shown below.



- When connecting the IR receiver, be sure to connect it to the green MULTI-ROOM & SOURCE REMOTE IN jack, not the black CONTROL IN or OUT jacks.
- It is not possible to input digital signals into the SUB room, you must use analog signals.
- You can't use tone controls (etc.) or any surround modes in the SUB room.

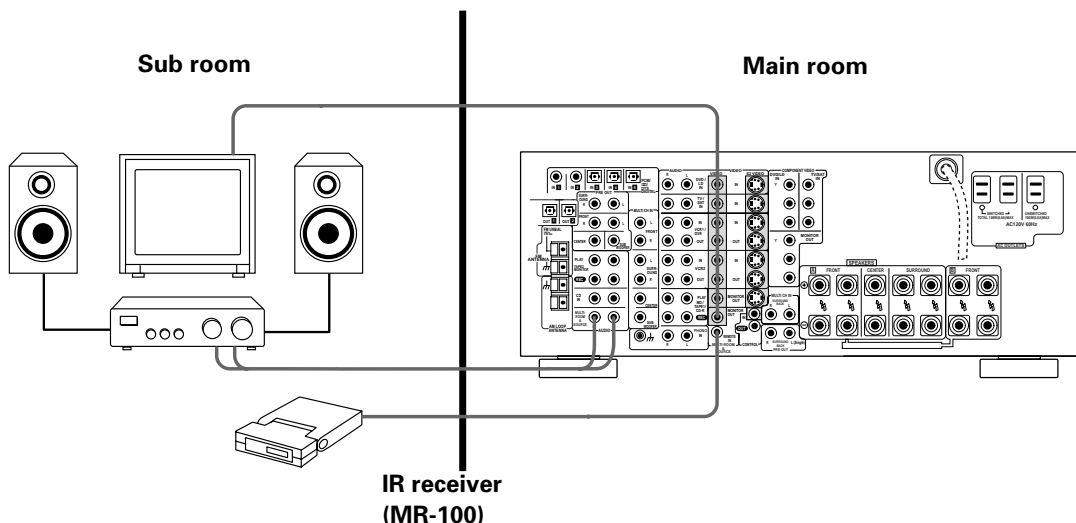

### Set up example

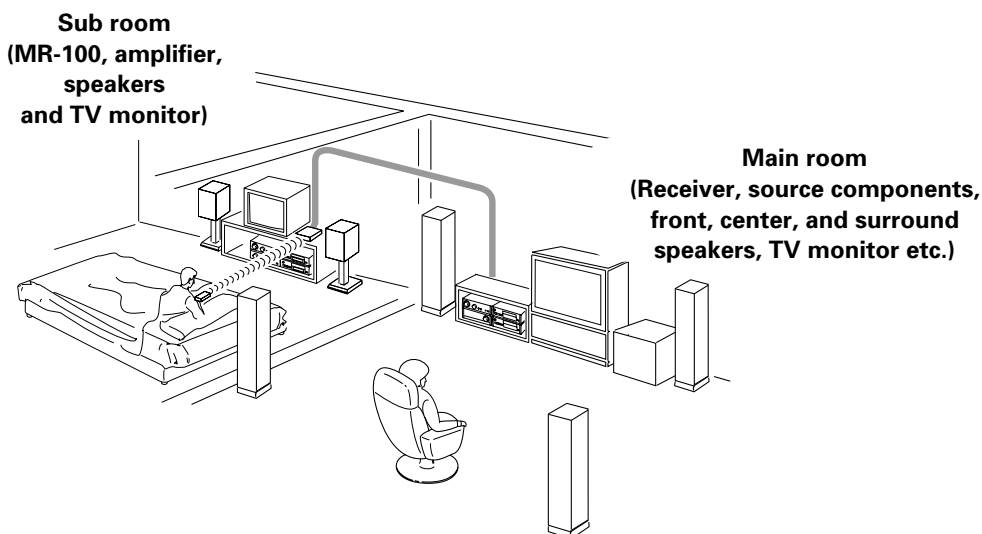

## MULTI-ROOM set up

After you have completed the necessary connections for MULTI-ROOM operation you need to set up the receiver for such operation. Follow the instructions below. The page after this one explains how to use the MULTI-ROOM function once it's been set up.

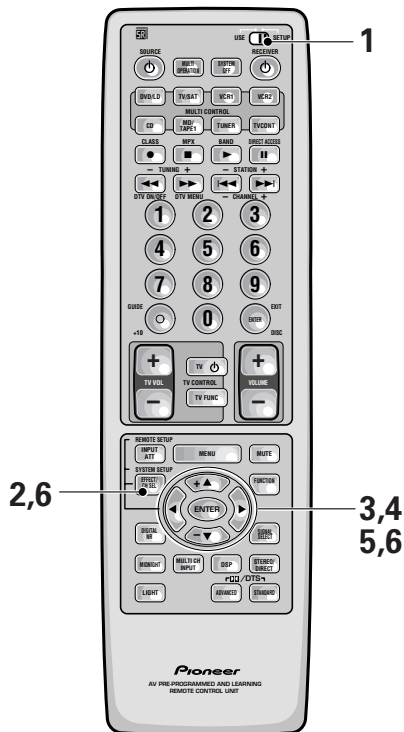

### 1 Set the slide switch to SETUP.

Also make sure that the TV is on and set to the receiver.

### 2 Press SYSTEM SETUP on the remote control.

The REMOTE SETUP MENU appears on your TV screen. You can escape from this screen at any time by pressing SYSTEM SETUP again.

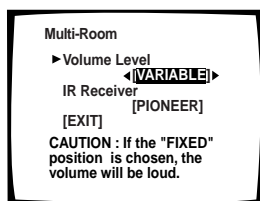

### 3 Use the ▲/▼ buttons to select the MULTI-ROOM set up mode and press ENTER.

### 4 Select the VOLUME LEVEL by using the ◀/▶ buttons.

If you hook up a just a power amplifier in the sub room the receiver will act as a pre-amp. In this case choose VARIABLE for the VOLUME LEVEL setting. If you hook up a full integrated amplifier in the sub room (such as another Pioneer VSX receiver) choose FIXED for the VOLUME LEVEL setting.

### 5 Select the IR RECEIVER type with the ▲/▼ buttons and select the type by using the ◀/▶ buttons.

If you have the Pioneer-made MR-100 select PIONEER. If you have an IR RECEIVER from a different company, select OTHERS.

### 6 Move to the EXIT setting and press ENTER to exit MULTI-ROOM set up and return to the SYSTEM SETUP MENU operations.

You can leave the MULTI ROOM set up mode any time by pressing the SYSTEM SETUP button.

- When you're done setting up, remember to set the slide switch back to USE.

#### CAUTION!

If the MULTI ROOM is set to FIXED the volume on the main unit will be set to maximum. Thus, when output, it will be extremely loud. Please set the master volume controls of the integrated amplifier in the sub room very low at first and experiment to find a suitable volume.



Some IR RECEIVERS may not work with this system, check with a Pioneer representative to be sure.

## Using Other Functions

### Using the front panel with the MULTI-ROOM system

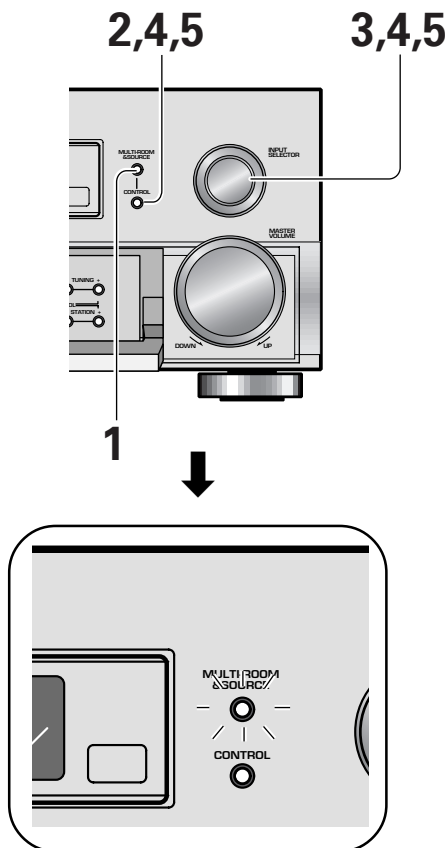

If you don't turn the multi room function off you won't be able to turn the entire main room system off.

#### 1 Press the **MULTI-ROOM & SOURCE** button.

The display shown below will illuminate when the receiver is in STANDBY mode. Also, the MR&S button will light.

MR&S ON

#### 2 Press the **CONTROL** button.

The light will start to blink.

#### 3 Within ten seconds of step 2, select the **FUNCTION** with the **INPUT SELECTOR**.

For this example we'll use the TUNER function. The display shown below will illuminate.

MR : TUNER

The INPUT SELECTOR steps through the functions in the following order:

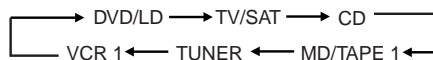

#### 4 Press the **CONTROL** button again and use the **INPUT SELECTOR** to adjust the **VOLUME**. The volume can be adjusted in a range of **-82dB to 0dB**.

The display will appear as shown below.

MR : Vol. -88dB

#### 5 When in TUNER function, press the **CONTROL** button and use the **INPUT SELECTOR** to tune in the station.

The display will appear as shown below.

MR : FM 87.50



Turn the input selector until you get:

MR : A2 87.50



Using the remote control with the MULTI-ROOM system

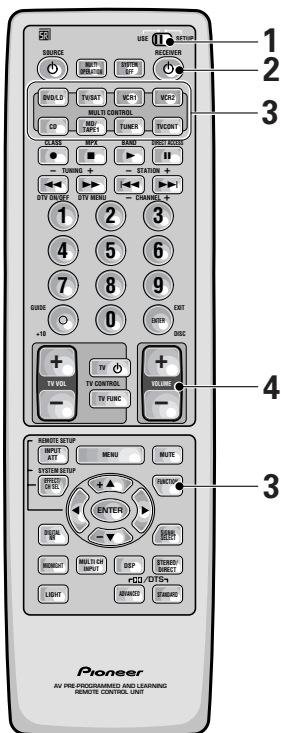

**1 Set the slide switch to USE.**

**2 From the sub room, point the remote control at the MULTI ROOM sensor and press the  RECEIVER button.**

The MULTI ROOM & SOURCE button will light on the front panel in the main room.

**3 Press a FUNCTION button to select the sub function.**

You can also use the MULTI OPERATION buttons to select the feature.

**4 Press VOLUME +/- to adjust the volume.**

The following remote control buttons can be used to operate the receiver from the sub room.

-  RECEIVER button
- FUNCTION button (will not select PHONO, VCR 2 or VIDEO)
- VOLUME +/- buttons (for adjusting the sub-room's volume level, but can't be used when set to FIXED)
- CLASS button (for selecting the desired class)
- STATION -/+ button (for recalling memorized radio stations (the tuner is selected automatically))
- Number button (0-9)

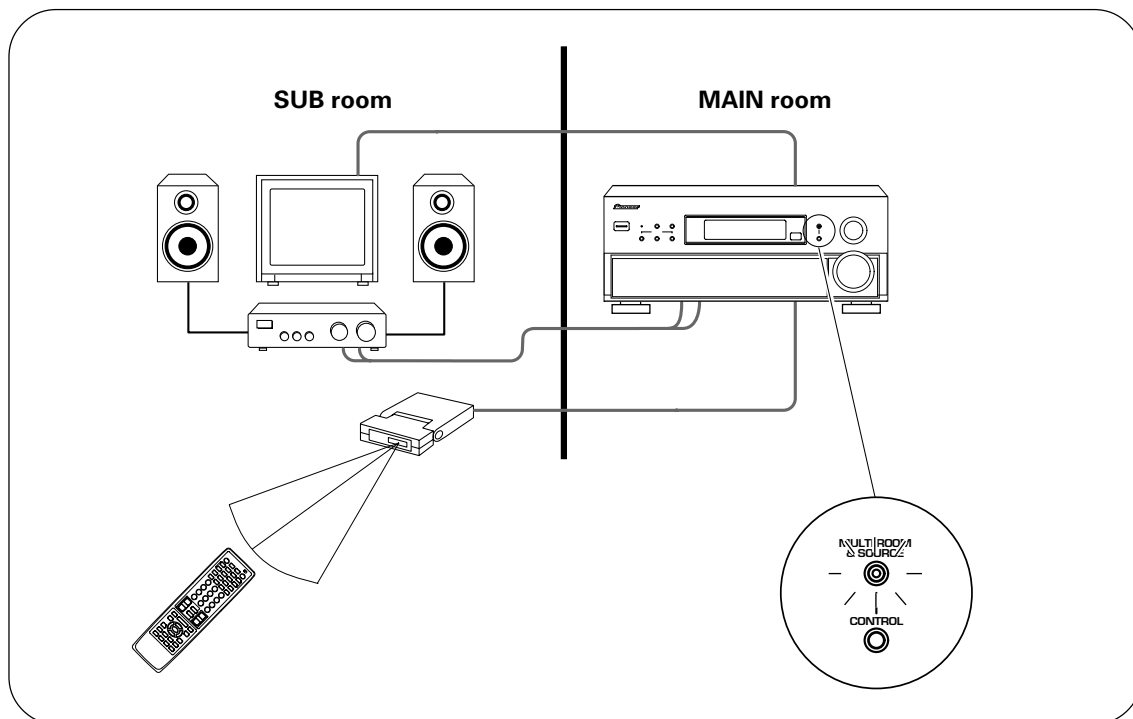

OPERATION

## Using Other Functions



- Remote operation may not be possible if direct light from a strong fluorescent lamp is shining on the IR receiver remote sensor window.
- The tuner cannot be tuned to more than one station at a time. Therefore, changing the station in one room also changes the station in the other room. Please be careful not to change stations when recording a radio broadcast.
- The volume levels of the main and sub rooms are independent.
- When more than one remote control signal is transmitted at the same time, the receiver does not operate.
- When operating MULTI-ROOM & SOURCE with the MULTI-ROOM PRE OUT jacks connected to a SUB room amplifier which bears the PIONEER SR mark and has a remote sensor, both the IR receiver and the amplifier may receive remote control commands (making correct operation impossible). In this case, place the IR receiver and amplifier apart from each other, and point the remote control directly at the IR receiver during operation.
- If you plan to leave the MULTI ROOM feature off for a lengthy period please turn off the power in both the SUB and MAIN rooms. Make sure the STANDBY indicator turns red and the MR&S indicator goes off.
- If you send the SYSTEM OFF command from the SUB room by remote control, the power of both rooms will go off. Please be careful when making a recording in the MAIN room.

## The PIONEER SR System: Operating other PIONEER components

Connecting an optional control cord allows you to operate other PIONEER components simply by pointing the receiver's remote control at the remote sensor on the front panel of the receiver. The receiver then sends the remote control signals to the other devices via the CONTROL OUT terminal.

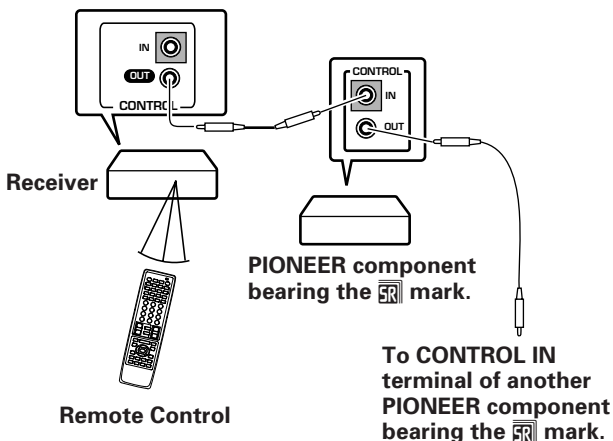

- You can also control PIONEER components (and those made by other manufacturers) by pointing the receiver's remote control directly at the respective component. This type of operation does not require control cords. All you have to do is recall the appropriate the stored settings (see p.58-59).
- If you use a remote control hooked up via the CONTROL IN jack with a control cord, you won't be able to use this unit's remote control.

# Techno Tidbits & Problem-solving

## Dolby Digital



Dolby Digital is a compression format which records the sound of 6 channels of the theater surround system (Dolby Digital) on the movie film digital track. Of the 6 channels, the sub woofer channel is intended for bass only, and because the frequency range is smaller than the main channel, it is expressed as 5.1 channel.

Dolby Digital is the name of the Dolby surround multi-channel digital system that was developed after the Dolby Surround System and Dolby Pro Logic Surround System.

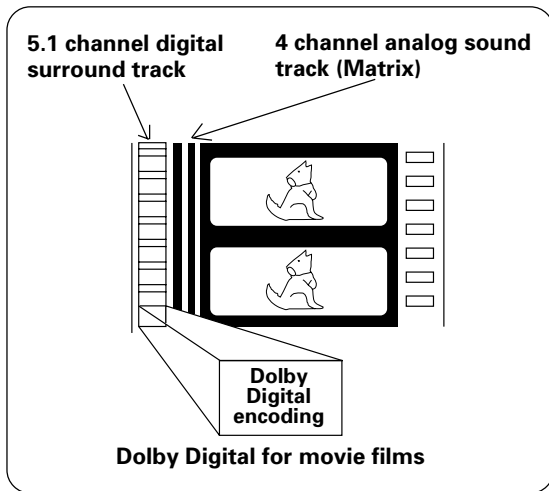

The number of movies made using Dolby Digital since 1992 has exceeded 300 and continues to increase. For compact disc players and laser disc digital sounds, 16 bits are used to sample the original analog audio waveform and sampling is carried out 44,100 times every second. However because an enormous amount of recording signal data is required for the multi channel system with this method, Dolby Digital is used to compress the data.

In reproducing audio signals, the smaller the bit number used, the lower the sound quality. With Dolby Digital, drop in auditory sound quality is prevented by using masking technology and digital filtering technology based on the human auditory characteristics.

## Laser disc format

Laser discs are now available on the market in large numbers. This means that the recording of different format audio signals on the laser disc raises the important question of compatibility with existing laser discs. Dolby Digital tracks on laser discs record signals using the space of one analog audio channel so it will maintain compatibility with existing discs and players.

As shown in the following figure, the digital audio sounds of Dolby Digital discs can be played back as currently done. Analog sounds are played back by using the other channel without the Dolby Digital signals for monaural audio signals.

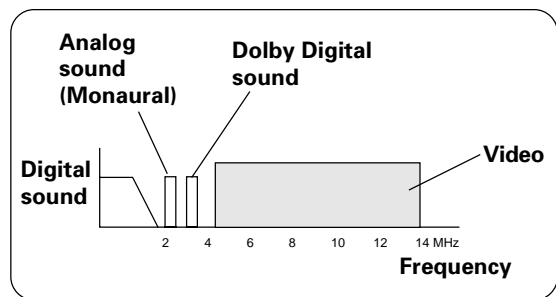

## Comparison with Dolby Pro Logic Surround

Dolby Digital is also known as the 5.1 channel system. It is equipped with 5 channels (front left, front right, center, surround left, surround right) in the frequency range from 20 Hz to 20 kHz and an independent Low Frequency Effect (LFE) channel. The subwoofer channel is also called Low Frequency Effect (LFE).

The subwoofer channel can be used as desired to enjoy strong bass sounds.

## DTS



DTS has been adopted as a sound recording format in the latest movie theaters since the release of "JURASSIC PARK" in 1993, and has a good reputation for high quality sound and dynamic surround effects.

In this system, 6 channels of digital sound are recorded on CD-ROM, rather than on the film. DTS adopts a simultaneous playback format. With a low rate of compression of sound signals and a high rate of transmittance, a higher sound quality format is produced. Also, unlike the process of recording digital sounds on film directly, the only components required are a CD-ROM player as might be used with a personal computer and a DTS processor, and therefore less investment is required than with other formats. For this reason, the format is being introduced in more and more movie theaters, and is being adopted in home movie software (DVD, LD) and music software (5.1 channel CD).

## Preset Code List

Device	Manufacturer	Code	Device	Manufacturer	Code	
DVD	TOSHIBA	001	CD	SONY	301, 316, 317, 318	
	SONY	002		TECHNICS	304, 326	
	PANASONIC	003		KENWOOD	310, 321, 311	
	JVC	004		DENON	309	
	SAMSUNG	005		RCA	302, 319, 313	
	SHARP	006		PHILIPS	312, 322, 346(CD-R)	
	AKAI	007		YAMAHA	315, 314, 328	
RCA	009	JVC		303		
PIONEER	000, 008	TEAC		305, 306, 327, 324, 325		
LD	SONY	101		ONKYO	320, 308, 307	
	PANASONIC	105, 106		MARANTZ	323, 312, 324	
	KENWOOD	103		SANYO	313	
	PHILIPS	104		OPTIMUS	300	
	MITSUBISHI	100		PIONEER	300, 345(CD-R)	
	RCA	107	MD	SONY	901	
	PIONEER	100, 111		KENWOOD	903	
STB	RCA	201(SAT), 203(SAT)		SHARP	902	
	SONY	202(SAT)		TEAC	904	
	ECHOSTAR	205(SAT)		ONKYO	905	
	PIONEER	200(SAT), 207(DTV)		DENON	906	
VCR	ORION	445, 446, 424		TV	RCA	601, 610, 615, 616, 617, 618
	FUNAI	441	ZENITH		603, 620	
	RCA	401, 406, 408, 414, 405, 413, 411, 415	MAGNAVOX		607, 610, 603, 612, 629	
	ZENITH	403, 404, 417	GE		601, 608, 607, 610, 617, 602, 628	
	MAGNAVOX	414, 408, 426, 403			618	
	FISHER	410, 426, 412, 427, 425, 420	PANASONIC		608, 622, 607	
	PANASONIC	408, 432, 433	SONY		604	
	TOSHIBA	405, 409, 426	TOSHIBA		605, 602, 626, 621	
	JVC	428, 430, 429, 408, 414, 431, 407	MITSUBISHI		609, 610, 602, 621	
	HITACHI	408, 401, 406, 436, 434	HITACHI		606, 610, 624, 625, 618	
	SONY	416, 417, 404, 408, 457, 458, 459	JVC		613, 623	
	MITSUBISHI	409, 420, 421, 422, 423, 424, 408, 407	SHARP		602, 619, 627	
	SANYO	410, 412, 425, 435	SANYO		621, 614	
	SHARP	402, 418, 419	PHILIPS		607	
	GOLDSTAR	411, 409	GOLDSTAR	610, 623, 621, 602		
	OPTIMUS	408, 432, 433, 402, 418, 419	RADIO SHACK	610, 623, 621, 602		
	GRANDIENTE	441	GRANDIENTE	630		
	PIONEER	400, 456(DVR)	FUNAI	658		
	TAPE	MARANTZ	821	CATV	JERROLD	219, 209, 210, 220, 212, 221, 211, 222, 224, 223
		SONY	801, 806		S.ATLANTA	213, 214, 216, 217
TECHNICS		803	ZENITH		215, 225, 218	
KENWOOD		804, 807	TUNER	PIONEER	208	
TEAC		805		PIONEER	500	
DENON		810				
ONKYO		809, 808				
YAMAHA		811, 812				
JVC		802				
FISHER		813				
OPTIMUS		800				
PIONEER		800				

## Troubleshooting

Incorrect operations are often mistaken for trouble and malfunctions. If you think that there is something wrong with this component, check the points below. Sometimes the trouble may lie in another component. Investigate the other components and electrical appliances being used. If the trouble cannot be rectified even after exercising the checks listed below, ask your nearest PIONEER authorized service center or your dealer to carry out repair work.

<b>Symptom</b>	<b>Cause</b>	<b>Remedy</b>
The power does not turn ON.	<ul style="list-style-type: none"> <li>• The power plug is disconnected.</li> <li>• The protection circuit may have been activated.</li> </ul>	<ul style="list-style-type: none"> <li>• Connect the power plug to the wall outlet.</li> <li>• Disconnect the power plug from the outlet, and insert again.</li> </ul>
The unit does not respond when the buttons are pressed.	<ul style="list-style-type: none"> <li>• Static electricity caused by dry air.</li> </ul>	<ul style="list-style-type: none"> <li>• Disconnect the power plug from the outlet, and insert again.</li> </ul>
No sound is output when a function is selected.	<ul style="list-style-type: none"> <li>• Improper connections.</li> <li>• Sound is muted.</li> <li>• The volume is turned down.</li> <li>• The TAPE 2 MONITOR is ON.</li> <li>• Speakers are turned OFF.</li> <li>• DIGITAL/ANALOG switch is set incorrectly.</li> </ul>	<ul style="list-style-type: none"> <li>• Make sure the component is connected correctly (see p.12-21).</li> <li>• Press MUTE on the remote control.</li> <li>• Adjust MASTER VOLUME.</li> <li>• Press the TAPE 2 MONITOR button.</li> <li>• Press SPEAKERS (A/B) to select the speakers you connected.</li> <li>• Set SIGNAL SELECT (see p.47).</li> </ul>
No image is output when a function is selected.	<ul style="list-style-type: none"> <li>• Improper connections.</li> <li>• The input source is not properly selected.</li> </ul>	<ul style="list-style-type: none"> <li>• Make sure the component is connected correctly (see p.15-18).</li> <li>• Press the correct function button.</li> </ul>
Considerable noise in radio broadcasts.	<ul style="list-style-type: none"> <li>• Incorrect frequency.</li> <li>• The antenna is not connected.</li> <li>• Digital cable is near the antenna terminals and wires.</li> </ul>	<ul style="list-style-type: none"> <li>• Tune in the correct frequency.</li> <li>• Connect the antenna (see p.18).</li> <li>• Route digital cable away from the antenna terminals and wires.</li> </ul>
	<p><b>FM broadcasts</b></p> <ul style="list-style-type: none"> <li>• The FM antenna is not fully extended or is poorly positioned.</li> <li>• Weak radio signals.</li> </ul>	<ul style="list-style-type: none"> <li>• Fully extend the FM wire antenna, position for best reception, and secure to a wall.</li> <li>• Connect an outdoor FM antenna (see p.18).</li> </ul>
	<p><b>AM broadcasts</b></p> <ul style="list-style-type: none"> <li>• The AM antenna is poorly positioned.</li> <li>• Weak radio signals.</li> <li>• Interference caused by other equipment (fluorescent lamp, motor, etc.).</li> </ul>	<ul style="list-style-type: none"> <li>• Adjust the direction and position for best reception.</li> <li>• Connect an additional internal or external AM antenna (see p.18).</li> <li>• Turn off the equipment causing the noise or move it away from the receiver.</li> <li>• Place the antenna farther away from the equipment causing the noise.</li> </ul>
Broadcast stations cannot be selected automatically.	<ul style="list-style-type: none"> <li>• Weak radio signals.</li> </ul>	<ul style="list-style-type: none"> <li>• Connect an outdoor antenna (see p.18).</li> </ul>
Subwoofer output is very low.	<ul style="list-style-type: none"> <li>• Settings route signal away from subwoofer.</li> </ul>	<ul style="list-style-type: none"> <li>• To get more signal to the subwoofer set it to PLUS or choose SMALL for the FRONT speakers (see p.32-33).</li> </ul>
When playing a Dolby Digital / DTS source the 5.1 Channel indicator doesn't light.	<ul style="list-style-type: none"> <li>• The Dolby Digital / DTS source is not 5 channels.</li> </ul>	<ul style="list-style-type: none"> <li>• There is no problem with the receiver but if you want 5 channel sound you must play a 5 channel source.</li> </ul>

## Techno Tidbits & Problem-solving

Symptom	Cause	Remedy
No sound from surround or center speakers.	<ul style="list-style-type: none"> <li>• Speaker settings are incorrect.</li> <li>• The rear and/or center levels are turned down.</li> <li>• The surround and/or center speakers are disconnected.</li> </ul>	<ul style="list-style-type: none"> <li>• See "SPEAKER SETTING" on p.32-33 to check the speaker settings.</li> <li>• See "CHANNEL LEVEL" p.35-36 to check the speaker levels.</li> <li>• Connect the speakers (see p.19).</li> </ul>
Sound is produced from some components, but not from digital components.	<ul style="list-style-type: none"> <li>• SIGNAL SELECT is set incorrectly.</li> <li>• The digital inputs are assigned incorrectly, or not at all.</li> </ul>	<ul style="list-style-type: none"> <li>• Set SIGNAL SELECT to "AUTO" or according to the type of connections made (see p.47).</li> <li>• Set the digital input settings correctly (see p.31).</li> </ul>
No sound is output or a noise is output when software with DTS is played back.	<ul style="list-style-type: none"> <li>• SIGNAL SELECT is set to "ANALOG".</li> <li>• A DVD player not compatible with DTS is used, or the setting of the DVD player is incorrect.</li> <li>• The digital output level has been turned down on a CD player or other component equipped with digital output level adjustment capability. (The DTS signal has been altered by the player, and cannot be read.)</li> <li>• The speakers are turned OFF.</li> </ul>	<ul style="list-style-type: none"> <li>• Make digital connections (see p.13) and set SIGNAL SELECT to "AUTO" (see p.47).</li> <li>• Refer to the instruction manual supplied with the DVD player.</li> <li>• Set the digital volume level of the player to full, or to the neutral position.</li> <li>• Turn the speakers ON.</li> </ul>
The sound is output intermittently when software with DTS is played back.	<ul style="list-style-type: none"> <li>• Disc being played back has a huge amount of information on it.</li> </ul>	<ul style="list-style-type: none"> <li>• Use the STANDARD mode to get the best results (see p.44).</li> </ul>
When a search is performed by a DTS compatible CD player during playback, noise is output.	<ul style="list-style-type: none"> <li>• The search function performed by the player interferes with the reading of digital information.</li> </ul>	<ul style="list-style-type: none"> <li>• This is not a malfunction, but be sure to turn the volume down to prevent the output of loud noise from your speakers.</li> </ul>
Cannot be remote controlled.	<ul style="list-style-type: none"> <li>• The remote control batteries have worn out.</li> <li>• Too far away or bad angle of operation.</li> <li>• There is an obstacle between the receiver and the remote control.</li> <li>• Strong light such as fluorescent light is shining onto the unit's remote control signal light-receiving window.</li> <li>• A cord is connected to the CONTROL IN terminal on this unit.</li> <li>• The IR -Receiver type is mismatched with the setting.</li> </ul>	<ul style="list-style-type: none"> <li>• Replace the batteries (see p.10).</li> <li>• Operate within 7 m, 30° of the remote sensor on the front panel (see p.11).</li> <li>• Remove the obstacle or operate from another position.</li> <li>• Avoid exposing the remote sensor on the front panel to direct light.</li> <li>• Connect cord to the correct jack.</li> <li>• Disconnect the IR Receiver from the rear panel, and set to the other IR Receiver type using the remote control.</li> </ul>
The display is dark.	<ul style="list-style-type: none"> <li>• The FL DIMMER button is pushed.</li> </ul>	<ul style="list-style-type: none"> <li>• Press FL DIMMER on the front panel repeatedly to return to the default setting (see p.52).</li> </ul>
The OVER indicator is constantly lit.	<ul style="list-style-type: none"> <li>• If you are using an analog source, the signal is too strong.</li> </ul>	<ul style="list-style-type: none"> <li>• Press the INPUT ATT button (see p.27).</li> </ul>
When playing a Dolby Digital / DTS format LD there is noise audible on the soundtrack.	<ul style="list-style-type: none"> <li>• If you are using a digital source, there is too much information for the receiver to handle.</li> <li>• The SIGNAL SELECT is on ANALOG.</li> </ul>	<ul style="list-style-type: none"> <li>• For DD/DTS sources put the receiver in STANDARD mode (see p.44).</li> <li>• Set the SIGNAL SELECT to DIGITAL.</li> </ul>

## Techno Tidbits & Problem-solving

<b>Symptom</b>	<b>Cause</b>	<b>Remedy</b>
You can't get DIGITAL to come up when using the SIGNAL SELECT button.	<ul style="list-style-type: none"> <li>• Either the digital connections or the DIGITAL IN SELECT choices are incorrect.</li> <li>• The TAPE2 MONITOR mode is ON.</li> </ul>	<ul style="list-style-type: none"> <li>• Make sure the digital connections and the DIGITAL IN SELECT choices are done correctly.</li> <li>• Press the TAPE2 MONITOR button so it goes into the OFF setting.</li> </ul>
The Dolby Digital / DTS indicator doesn't light up even when playing a Dolby Digital / DTS source.	<ul style="list-style-type: none"> <li>• The player is paused or stopped.</li> <li>• There is a mistake in the player settings for audio output.</li> <li>• Although it's a Dolby Digital / DTS source there is a possibility the present track is not Dolby Digital / DTS.</li> </ul>	<ul style="list-style-type: none"> <li>• Play the source.</li> <li>• Fix the audio settings (check the manual that came with your DVD player).</li> <li>• There is no problem. The indicator won't light when the track is not a Dolby Digital / DTS track.</li> </ul>

**If the unit does not operate normally due to external effects such as static electricity**

Disconnect the power plug from the outlet and insert again to return to normal operating conditions.



### *Dear Customer:*

Selecting fine audio equipment such as the unit you've just purchased is only the start of your musical enjoyment. Now it's time to consider how you can maximize the fun and excitement your equipment offers. This manufacturer and the Electronic Industries Association's Consumer Electronics Group want you to get the most out of your equipment by playing it at a safe level. One that lets the sound come through loud and clear without annoying blaring or distortion-and, most importantly, without affecting your sensitive hearing.

Sound can be deceiving. Over time your hearing "comfort level" adapts to higher volumes of sound. So what sounds "normal" can actually be loud and harmful to your hearing. Guard against this by setting your equipment at a safe level BEFORE your hearing adapts.

#### **To establish a safe level:**

- Start your volume control at a low setting.
- Slowly increase the sound until you can hear it comfortably and clearly, and without distortion.

#### **Once you have established a comfortable sound level:**

- Set the dial and leave it there.

Taking a minute to do this now will help to prevent hearing damage or loss in the future. After all, we want you listening for a lifetime.

## We Want You Listening For A Lifetime

Used wisely, your new sound equipment will provide a lifetime of fun and enjoyment. Since hearing damage from loud noise is often undetectable until it is too late, this manufacturer and the Electronic Industries Association's Consumer Electronics Group recommend you avoid prolonged exposure to excessive noise. This list of sound levels is included for your protection.

#### **Decibel**

<u>Level</u>	<u>Example</u>
30	Quiet library, soft whispers
40	Living room, refrigerator, bedroom away from traffic
50	Light traffic, normal conversation, quiet office
60	Air conditioner at 20 feet, sewing machine
70	Vacuum cleaner, hair dryer, noisy restaurant
80	Average city traffic, garbage disposals, alarm clock at two feet.

#### **THE FOLLOWING NOISES CAN BE DANGEROUS UNDER CONSTANT EXPOSURE**

90	Subway, motorcycle, truck traffic, lawn mower
100	Garbage truck, chain saw, pneumatic drill
120	Rock band concert in front of speakers, thunderclap
140	Gunshot blast, jet plane
180	Rocket launching pad

Information courtesy of the Deafness Research Foundation.



### **Power cord CAUTION!**

Handle the power cord by the plug. Do not pull out the plug by tugging the cord and never touch the power cord when your hands are wet as this could cause a short circuit or electric shock. Do not place the unit, a piece of furniture, etc., on the power cord, or pinch the cord. Never make a knot in the cord or tie it with other cords. The power cords should be routed such that they are not likely to be stepped on. A damaged power cord can cause a fire or give you an electrical shock. Check the power cord once in a while. When you find it damaged, ask your nearest PIONEER authorized service center or your dealer for a replacement.

### **Maintenance of External Surfaces**

- Use a polishing cloth or dry cloth to wipe off dust and dirt.
- When the surfaces are dirty, wipe with a soft cloth dipped in some neutral cleanser diluted five or six times with water, and wrung out well, and then wipe again with a dry cloth. Do not use furniture wax or cleaners.
- Never use thinners, benzene, insecticide sprays or other chemicals on or near this unit, since these will corrode the surfaces.



## Specifications

### Amplifier Section

**Continuous average power output of 100 watts\* per channel, min., at 8 ohms, from 20 Hz to 20,000 Hz with no more than 0.09 %\*\* total harmonic distortion (front).**

#### Continuous Power Output

Front	.....	100 W + 100 W (20 Hz-20 kHz, 0.09 %, 8 Ω)
Center	.....	100 W (20 Hz-20 kHz, 0.09 %, 8 Ω)
Rear	.....	100 W + 100 W (20 Hz-20 kHz, 0.09 %, 8 Ω)

### Audio Section

Input (Sensitivity/Impedance)	
PHONO MM	..... 4.7 mV/47 kΩ
VCR 1/DVR, VCR 2, DVD/LD, TV/SAT, VIDEO, CD	
MD/TAPE 1/CD-R, TAPE 2	..... 335 mV/47 kΩ
Phono Overload level (T.H.D.0.1 %, 1kHz)	
PHONO MM	..... 120 mV
Frequency Response	
PHONO MM	..... 20 Hz to 20,000 Hz ± 0.3 dB
VCR 1/DVR, VCR 2, DVD/LD, TV/SAT, VIDEO, CD	
MD/TAPE 1/CD-R, TAPE 2	..... 5 Hz to 100,000 Hz $\pm$ 0.3 dB
Output (Level/Impedance)	
VCR 1/DVR REC, VCR 2 REC, MD/TAPE 1/CD-R REC	
TAPE 2 REC	..... 335 mV/2.2 kΩ
Tone Control	
BASS	..... ± 6 dB (100 Hz)
TREBLE	..... ± 6 dB (10 kHz)
LOUDNESS	..... +10 dB (100 Hz/10 kHz)
Signal-to-Noise Ratio (IHF, short circuited, A network)	
PHONO MM	..... 80 dB
VCR 1/DVR, VCR 2, DVD/LD, TV/SAT, VIDEO, CD	
MD/TAPE 1/CD-R, TAPE 2	..... 97 dB
MULTI CHANNEL IN	..... 97 dB
Signal-to-Noise Ratio [EIA, at 1 W (1 kHz)]	
PHONO MM	..... 80 dB
VCR 1/DVR, VCR 2, DVD/LD, TV/SAT, VIDEO, CD	
MD/TAPE 1/CD-R, TAPE 2	..... 83 dB

\* Measured pursuant to the Federal Trade Commission's Trade Regulation rule on Power Output Claims for Amplifiers.

\*\* Measured by Audio Spectrum Analyzer.

### Video Section

Input (Sensitivity)	..... 1 V <sub>p-p</sub> /75 Ω
Output (Level/Impedance)	..... 1 V <sub>p-p</sub> /75 Ω
Signal-to-Noise Ratio	..... 55 dB
Frequency Response	..... 5 Hz to 10 MHz $\pm$ 0.3 dB

### Component Video Section

Input (Sensitivity)	..... 1 V <sub>p-p</sub> /75 Ω
Output (Level/Impedance)	..... 1 V <sub>p-p</sub> /75 Ω
Signal-to-Noise Ratio	..... 55 dB

### FM Tuner Section

Frequency Range	..... 87.5 MHz to 108 MHz
Usable Sensitivity	..... Mono: 13.2 dBf, IHF (1.3 μV/75 Ω)
50 dB Quieting Sensitivity	..... Mono: 20.2 dBf
Stereo: 38.6 dBf	
Signal-to-Noise Ratio	..... Mono: 73 dB (at 85 dBf)
Stereo: 70 dB (at 85 dBf)	
Distortion	..... Stereo: 0.5 % (1 kHz)
Alternate Channel Selectivity	..... 60 dB (400 kHz)
Stereo Separation	..... 40 dB (1 kHz)
Frequency Response	..... 30 Hz to 15 kHz (± 1) dB
Antenna Input	..... 75 Ω unbalanced

### AM Tuner Section

Frequency Range	..... 530 kHz to 1,700 kHz
Sensitivity (IHF, Loop antenna)	..... 350 μV/m
Selectivity	..... 25 dB
Signal-to-Noise Ratio	..... 50 dB
Antenna	..... Loop antenna

### Miscellaneous

Power Requirements	..... AC 120 V, 60 Hz
Power Consumption	..... 400 W, 550 VA
Power Consumption in Standby mode	..... 1.0 W
AC Outlet	
SWITCHED (x2)	..... Total 100 W (0.8 A) MAX
UNSWITCHED	..... 100 W (0.8 A) MAX
Dimensions	..... 420 (W) × 173 (H) × 470 (D) mm (16-9/16 (W) × 6-13/16 (H) × 18-1/2 (D) in.)
Weight (without package)	..... 14.4 kg (31 lb 13 oz)

### Furnished Parts

FM wire Antenna	..... 1
AM loop Antenna	..... 1
"AA" IEC LR6 batteries	..... 2
Remote Control Unit	..... 1
Operating Instructions	..... 1

#### NOTE:

Specifications and the design are subject to possible modifications without notice, due to improvements.





Should this product require service in the U.S.A. and you wish to locate the nearest Pioneer Authorized Independent Service Company, or if you wish to purchase replacement parts, operating instructions, service manuals, or accessories, please call the number shown below.

**8 0 0 – 4 2 1 – 1 4 0 4**

Please do not ship your product to Pioneer without first calling the Customer Service Department at the above listed number for assistance.

PIONEER ELECTRONICS SERVICE, INC.  
CUSTOMER SERVICE DEPARTMENT  
P.O. BOX 1760, LONG BEACH,  
CA 90801-1760, U.S.A.

For warranty information please see the Limited Warranty sheet included with your product.

Should this product require service in Canada, please contact a Pioneer Canadian Authorized Dealer to locate the nearest Pioneer Authorized Service Company in Canada. Alternatively, please contact the Customer Service Department at the following address:

Pioneer Electronics of Canada, Inc.  
Customer Service Department  
300 Allstate Parkway, Markham, Ontario L3R  
OP2  
(905) 479-4411  
1-877-283-5901

For warranty information please see the Limited Warranty sheet included with your product.

Si ce produit doit être réparé au Canada, veuillez vous adresser à un distributeur autorisée Pioneer au Canada pour obtenir le nom de la Société de Service Autorisée Pioneer le plus près de chez vous. Ou encore, veuillez vous communiquer avec le Service de Clientèle de Pioneer:

Pioneer électroniques du Canada, Inc.  
Département de service au consommateurs  
300 Allstate Parkway, Markham, Ontario L3R  
OP2  
(905) 479-4411  
1-877-283-5901

Pour obtenir des renseignements sur la garantie, veuillez vous reporter au feuillet sur la Garantie Limitée qui accompagne le produit.

Published by Pioneer Corporation.  
Copyright © 2000 Pioneer Corporation.  
All rights reserved.

**PIONEER CORPORATION** 4-1, Meguro 1-Chome, Meguro-ku, Tokyo 153-8654, Japan  
**PIONEER ELECTRONICS [USA] INC.** P.O. BOX 1540, Long Beach, California 90801-1540, U.S.A.  
**PIONEER ELECTRONICS OF CANADA, INC.** 300 Allstate Parkway, Markham, Ontario L3R OP2, Canada  
**PIONEER EUROPE NV** Haven 1087, Keetberglaan 1, B-9120 Melsele, Belgium TEL: 03/570.05.11  
**PIONEER ELECTRONICS AUSTRALIA PTY. LTD.** 178-184 Boundary Road, Braeside, Victoria 3195, Australia, TEL: [03] 9586-6300  
**PIONEER ELECTRONICS DE MEXICO S.A. DE C.V.** San Lorenzo 1009 3er Piso Desp. 302 Col. Del Valle Mexico D.F. C.P. 03100  
TEL: 5-688-52-90

## Free Manuals Download Website

<http://myh66.com>

<http://usermanuals.us>

<http://www.somanuals.com>

<http://www.4manuals.cc>

<http://www.manual-lib.com>

<http://www.404manual.com>

<http://www.luxmanual.com>

<http://aubethermostatmanual.com>

Golf course search by state

<http://golfingnear.com>

Email search by domain

<http://emailbydomain.com>

Auto manuals search

<http://auto.somanuals.com>

TV manuals search

<http://tv.somanuals.com>