

Pioneer

**AUDIO/VIDEO
MULTI-CHANNEL RECEIVER**

VSX-D938TX

VSX-D908TX

VSX-D908TX-G

Operating Instructions

Thank you for buying this Pioneer product. Please read through these operating instructions so you will know how to operate your model properly. After you have finished reading the instructions, put them away in a safe place for future reference. In some countries or regions, the shape of the power plug and power outlet may sometimes differ from that shown in the explanatory drawings. However the method of connecting and operating the unit is the same.

WARNING: TO PREVENT FIRE OR SHOCK HAZARD, DO NOT EXPOSE THIS APPLIANCE TO RAIN OR MOISTURE.

VENTILATION

- When installing this unit, make sure to leave space around the unit for ventilation to improve heat radiation (at least 60 cm at top, 10 cm at rear, and 30 cm at each side). If not enough space is provided between the unit and walls or other equipment, heat will build up inside, interfering with performance or causing malfunctions.
- Do not place on a thick carpet, bed, sofa or fabric having a thick pile. Do not cover with fabric or other covering. Anything that blocks ventilation will cause internal temperature to rise, which may lead to breakdown or the hazard.

THE POWER SWITCH IS SECONDARY CONNECTED AND THEREFORE DOES NOT SEPARATE THE UNIT FROM MAINS POWER IN THE STANDBY POSITION.

If the socket outlets on the associated equipment are not suitable for the plug supplied with the product the plug must be removed and appropriate one fitted. The cut-off plug must be disposed of as an electrical shock hazard could exist if connected to a socket outlet.

IMPORTANT



The lightning flash with arrowhead symbol, within an equilateral triangle, is intended to alert the user to the presence of uninsulated "dangerous voltage" within the product's enclosure that may be of sufficient magnitude to constitute a risk of electric shock to persons.

CAUTION

RISK OF ELECTRIC SHOCK
DO NOT OPEN

CAUTION:
TO PREVENT THE RISK OF ELECTRIC SHOCK, DO NOT REMOVE COVER (OR BACK). NO USER-SERVICEABLE PARTS INSIDE. REFER SERVICING TO QUALIFIED SERVICE PERSONNEL.



The exclamation point within an equilateral triangle is intended to alert the user to the presence of important operating and maintenance (servicing) instructions in the literature accompanying the appliance.

This equipment has been tested and found to comply with the limits for a Class B digital device, pursuant to Part 15 of the FCC Rules. These limits are designed to provide reasonable protection against harmful interference in a residential installation. This equipment generates, uses, and can radiate radio frequency energy and, if not installed and used in accordance with the instructions, may cause harmful interference to radio communications. However, there is no guarantee that interference will not occur in a particular installation. If this equipment does cause harmful interference to radio or television reception, which can be determined by turning the equipment off and on, the user is encouraged to try to correct the interference by one or more of the following measures:

- Reorient or relocate the receiving antenna.
- Increase the separation between the equipment and receiver.
- Connect the equipment into an outlet on a circuit different from that to which the receiver is connected.
- Consult the dealer or an experienced radio/TV technician for help.

Information to User

Alteration or modifications carried out without appropriate authorization may invalidate the user's right to operate the equipment.

CHANNEL STEP SETTING (VSX-D908TX/D908TX-G only)

The unit has been factory preset to the channel allocation value for the area in which it is to be sold. If this value is set incorrectly, the tunes in frequency may be wrong, or sound may be distorted, resulting in an inability to reproduce reception signals at their proper sound quality. For this reason, be sure to confirm that the values are set correctly before first using the unit.

FM 100 kHz, AM 10 kHz:

Set to this position for areas with an FM reception step of 100 kHz and AM 10 kHz.

FM 50 kHz, AM 9 kHz:

Set to this position, for areas with an FM reception step of 50 kHz and AM 9 kHz.

NOTE:

When unsure about the channel allocation for your area, consult your dealer for correct information.

To Change Channel Steps

With the power turned OFF, hold the STANDBY/ON button depressed while pressing the FM/AM function button to turn the power ON.

- Each time the above operation is performed, the channel tuning step will alternate between FM 100 kHz/AM 10 kHz, and FM 50 kHz/AM 9 kHz.

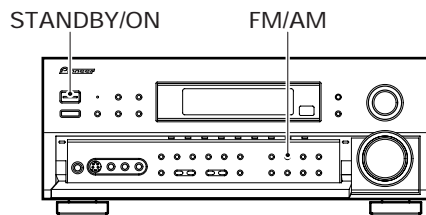

TWO VOLTAGE SELECTOR SWITCHES (VSX-D908TX/D908TX-G only)

Mains voltages in Saudi Arabia are 127 V and 220 V only.

Never use this model with the 110 V setting in Saudi Arabia.

The line voltage selector switches are on the rear panel. Check that they are set properly before plugging the power cord into the household wall socket. If the voltage is not properly set or if you move to an area where the voltage requirements differ, adjust the selector switches as follows.

1. Use a medium-size screwdriver.
2. First, insert the screwdriver in the groove of the voltage selector upper, and adjust so that the tip of the groove points to the voltage value of your area.
3. Next, insert the screwdriver in the groove of the voltage selector lower and adjust until the voltage is the same as at the right.

Medium-size screwdriver

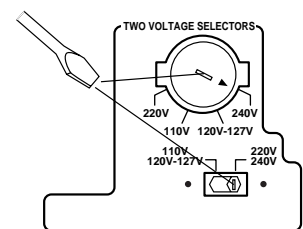

Features

MPEG (Moving Picture Experts Group) decoder equipped (Multichannel VSX-D938TX only)

Playback of DVD and other media recorded in MPEG audio is possible.

The MPEG logo is a registered trademark of Royal Philips Electronics.

Decoding of Dolby Digital, Dolby Pro Logic and DTS (Digital Theater Systems)

DTS is the latest and most widely used digital theater system for cinemas throughout the world. The decoder has been incorporated into this receiver and is able to achieve high sound quality as well as produce dynamic surround sound effects. Also, there is no need to worry about program formats. When playing Dolby Digital, Dolby Pro Logic or Dolby Surround software in the  (Dolby) Surround and HOME THX CINEMA modes, decoding switches automatically according to the input signal, all you have to do is enjoy!

"DTS" and "DTS Digital Surround" are trademarks of Digital Theater Systems, Inc. Manufactured under licence from Digital Theater Systems, Inc.

Manufactured under license from Dolby Laboratories. "Dolby", "AC-3", "Pro Logic", and double-D symbol are trademarks of Dolby Laboratories. Confidential Unpublished Works. © 1992 - 1997 Dolby Laboratories, Inc. All rights reserved.

Direct Energy MOS Amplifier

This receiver incorporates 5 independent 110 watt (DIN) built in power amplifiers with high-performance Hex power MOS FET output transistors. This construction provides improved linearity and accurate reproduction of each channel for true high fidelity reproduction from even the most demanding Dolby Digital and DTS program sources.

True Home Cinema with THX® Certification

The HOME THX CINEMA surround mode employs special processing to allow you to enjoy movie soundtracks with the same level of power and realism you experience in well designed movie theaters. You can enjoy this effect with both Dolby Digital, Dolby Surround and DTS sources.

Manufactured under license from Lucasfilm Ltd. Lucasfilm and THX are trademarks of Lucasfilm Ltd.

Advanced Theater Modes

This mode enhances the sound of either film or music so a more dramatic effect can be achieved. The four modes are each designed to accentuate specific sound qualities, giving the listener a wide range of possibilities.

DSP Surround Modes

DSP (Digital Signal Processing) surround mode gives you the capability of transforming your living room into six different sonic environments when listening to music.

Midnight Listening Mode

Midnight Listening mode allows you to obtain excellent surround sound effects even when listening at low volumes, something that was previously impossible.

Digital Noise Reduction

Digital Noise Reduction is the latest technology for filtering out unwanted noise. It produces clear, resonant tones.

Illuminated Remote Control of Other Components

The supplied remote control can be used to operate a variety of other components simply by recalling the appropriate preset codes or by using the learning function to teach the remote control new commands. In addition, the multi-operation functions allow you to perform a variety of operations automatically.

The Energy-saving Design

This unit is designed to use minimal electricity when power is switched OFF (in Standby mode). Regarding the value of the power consumption in standby mode, refer to "Specifications" on pages 86-87.

Table of Contents

Before You Start	6
Checking the Supplied Accessories	6
How to Use This Manual	6
Opening the Front Panel	6
Preparing the Remote Control	7
Connecting Your Equipment	8
Audio Components	8
Video Components	9
Digital Connections	10
External Decoder Input	12
Antennas	13
Speakers	14
Connecting Additional Amplifiers	17
Power Connections (AC OUTLETS)	17
Displays and Controls	18
Display	18
Front Panel (VSX-D938TX)	20
Front Panel (VSX-D908TX/D908TX-G)	22
Remote Control	24
Surround Sound Set Up	26
On Screen Display	26
Setting Up for Surround Sound	27
Basic Playback	38
Playing Sources with Stereo Sound	38
Sound Modes	39
Selecting a Sound Mode	41
Playing Sources with Dolby Digital or DTS Sound	42
Using MPEG audio discs (VSX-D938TX only)	43
Switching ANALOG/DIGITAL signal input	44
Reducing noise during playback (DIGITAL NR function)	45
Listening in MIDNIGHT LISTENING mode	46
External decoder playback (front panel only)	47
96kHz/24bit performance	47
Listening in LOUDNESS mode (front panel only)	48
Adjusting bass and treble (tone control) (front panel only)	48
Direct playback (front panel only)	48
Adjusting the brightness of the display (front panel only)	49
Using the Tuner	50
Automatic and Manual Tuning	50
Direct Access Tuning	51
Memorizing Frequently Used Stations	52
Recalling Memorized Stations	53
Remote Control of Other Components	54
Setting Up the Remote Control to Control Other Components	54
Remote Controlling Other Components	58
Using Other Functions	66
Recording from Audio Components	66
Recording from Digital Audio Components	67
Recording from Video Components	68
Multi Operations	69
System OFF	71
Setting Up the Direct Function	72
Resetting the Remote Control	74
Techno Tidbits and Problem-solving	76
Dolby Digital	76
DTS	77
THX	78
MPEG Audio	78
Preset Code List	79
Troubleshooting	84
Specifications	86

Before You Start

Checking the Supplied Accessories

Please check that you have received all of the following supplied accessories.



FM wire antenna



AM loop antenna

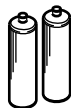

"AA" IEC LR6 batteries × 2

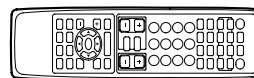

Remote control unit

How to Use This Manual

This manual is for the VSX-D938TX/D908TX/D908TX-G Audio/Video Multi-Channel Receiver.

This manual is divided into two main sections which will tell you how to setup and use the unit :

PREPARATION

First carry out the tasks below in this "Before You Start" section to prepare the remote control, then connect the receiver to your other components as described in "Connecting Your Equipment" (p.8). Take special care to connect your digital equipment like DVDs and LDs players properly to be able to take advantage of the receiver's surround sound systems.

To learn about a specific button, control, or indicator, see "Displays and Controls" starting on p.18.

SET UP

Performing the tasks in "Surround Sound Set Up" (p.27) is essential to get proper surround sound.

OPERATION

To play some music or soundtrack refer to "Basic Playback" on p.38. "Using the Tuner" (p.50) explains how to use the radio of this unit. Doing the operations in "Remote Control of Other Components" (p.54) is highly recommended so you can use this unit's remote control for all your components. "Using Other Functions" (p.66) explains the other possibilities of the receiver.

"Techno Tidbits & Problem-solving" (p.76) provides detailed technical information and a troubleshooting guide.

The following marks and symbols are used throughout the manual:



Provides additional information, precautions, and advice.



Indicates a blinking button, indicator, or display.



Indicates a steadily lit button, indicator, or display.

Opening the Front Panel

To open the front panel, push gently on the lower third of the panel with your finger.

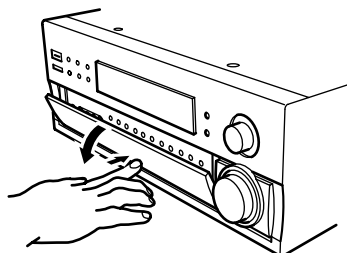

Preparing the Remote Control

Loading the batteries

Load the batteries into the remote control as shown below. Please use alkaline batteries.

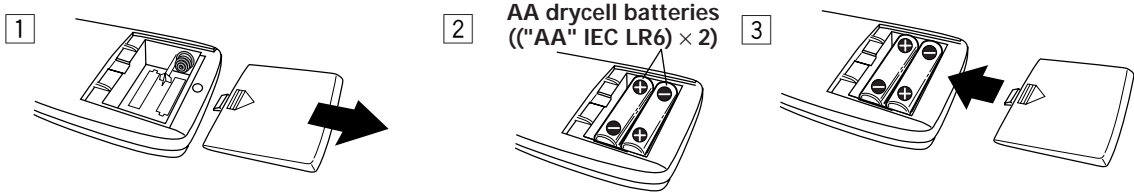

When you notice a decrease in the operating range of the remote control, replace all batteries with new ones.

CAUTION!

Incorrect use of batteries may result in such hazards as leakage and bursting. Observe the following precautions.

- Never use new and old batteries together.
- Insert the plus and minus sides of the batteries properly according to the marks in the battery case.
- Batteries with the same shape may have different voltages. Do not use different batteries together.

Operating other PIONEER components

Connecting an optional control cord allows you to operate other PIONEER components simply by pointing the receiver's remote control at the remote sensor on the front panel of the receiver. The receiver then sends the remote control signals to the other devices via the CONTROL OUT terminal.



- You can also control PIONEER components (and those made by other manufactures) by pointing the receiver's remote control directly at the respective component. This type of operation does not require control cords. All you have to do is recall the appropriate preset code (see P.79 (VSX-D938TX), P.83 (VSX-D908TX/D908TX-G)).
- If you use a remote control hooked up via the CONTROL IN jack with a control cord, you will not be able to use this unit's remote control.

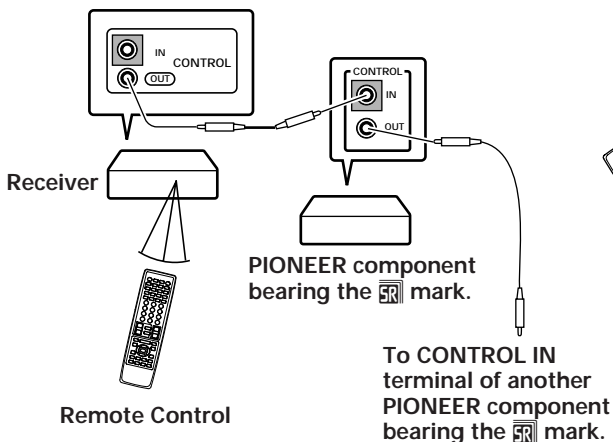

Operating range of remote control unit

The area in which you can use the remote control to operate the VSX-D938TX/D908TX/D908TX-G is fairly large. To use, point the remote control toward the remote sensor on the front panel of this unit while within the range shown below.



Remote control may not function properly if:

- There are obstacles between the remote control and the remote sensor.
- Direct sunlight or fluorescent light is shining onto the remote sensor.
- The receiver located near a device emitting infrared rays.
- Operated simultaneously with another remote control which uses infrared rays.

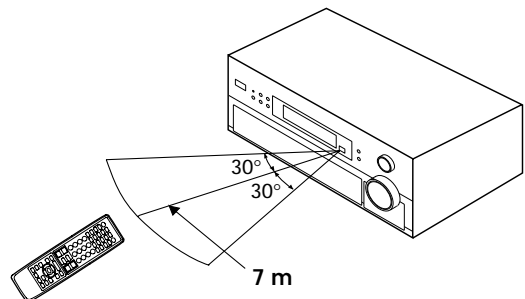

Connecting Your Equipment

Audio Components

To begin set up, connect your audio components to the jacks as shown below. These are all analog connections and your analog audio components (turntable, cassette deck) use these jacks. Remember that for components you want to record with you need to hook up four plugs (a set of stereo ins and a set of stereo outs), but for components that only play (like a turntable) you only need to hook up one set of stereo plugs (two plugs). To use DTS surround sound features you must hook up your digital components to the digital inputs but it is also a good idea to hook up your digital components to analog audio jacks. If you want to record to/from digital components (like an MD) to/from analog components, you must hook up your digital equipment with these analog connections. See p.10-11 for more on digital connections.

When connecting your equipment, always make sure the power is turned off and the power cord is disconnected from the wall outlet.

NOTE

- Only the VSX-D938TX has a RF IN jack.
- The arrows indicate the direction of the audio signal.

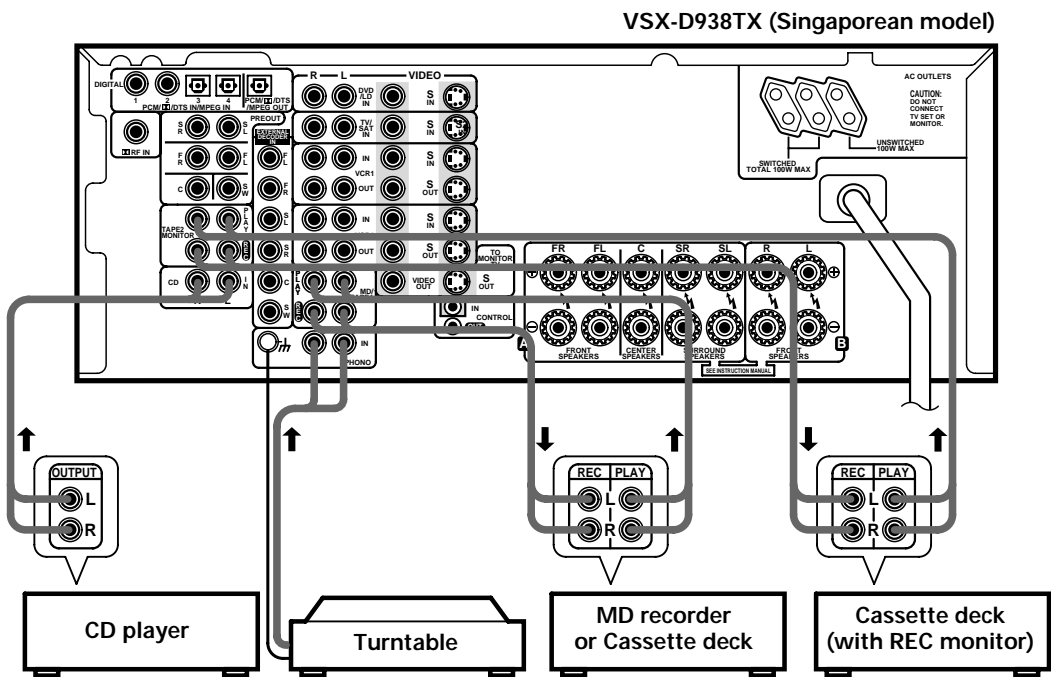

If your turntable has a ground wire, connect it to the SIGNAL GND terminal.

■ Audio cords

Use audio cords (not supplied) to connect the audio components.

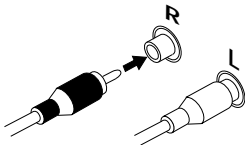

Connect red plugs to R (right) and white plugs to L (left). Be sure to insert completely.

Cassette deck placement

Depending on where the cassette deck is placed, noise may occur during playback of your cassette deck which is caused by leakage flux from the transformer in the receiver. If you experience noise, move the cassette deck farther away from the receiver.

Video Components

Connect your video components to the jacks as shown below. Regarding digital video components (like a DVD), you must use the analog connections pictured on this page for the video signal but in order to use Dolby Digital you should hook up their audio to a digital input (see the next page). It is also a good idea to hook up your digital components with analog audio connections as well (see the previous page). To cover all possible laser discs a DVD/LD player or LD player requires an analog connection (as shown here) and two digital connections (see the next page).

When connecting your equipment always make sure the power is turned off and the power cord is disconnected from the wall outlet.

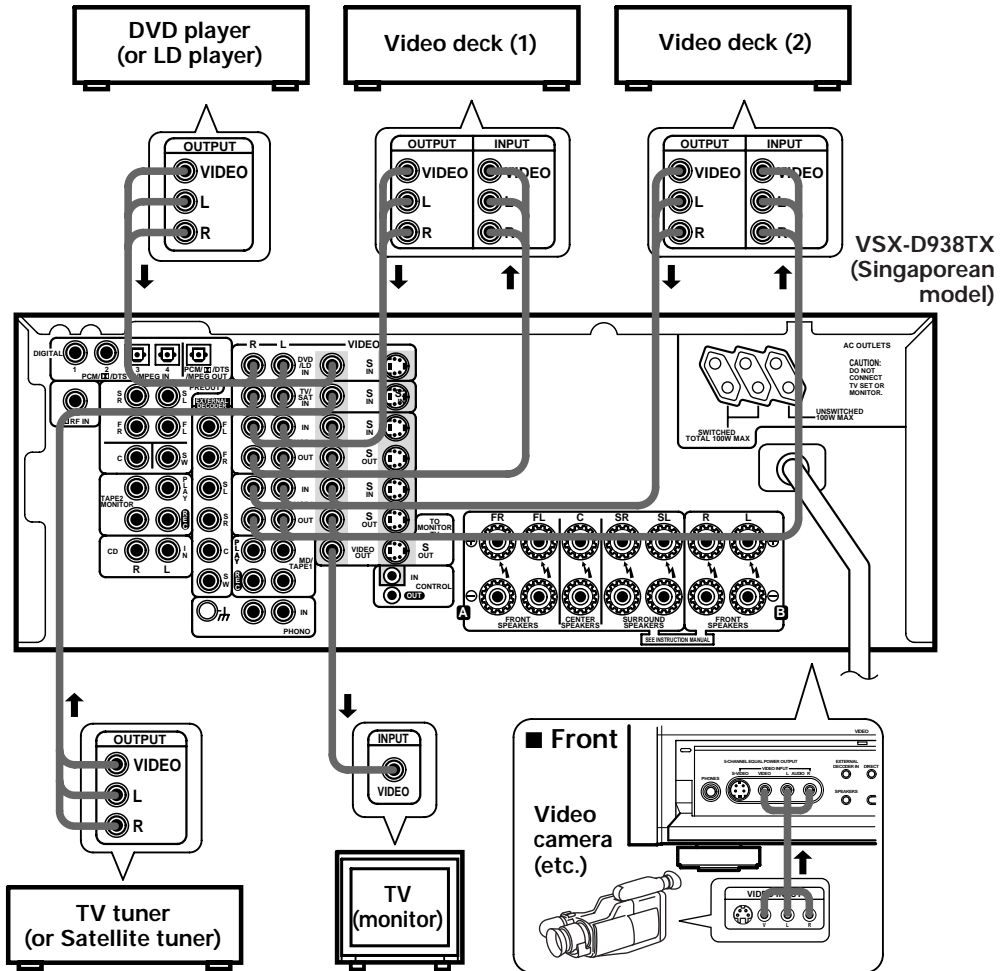

■ Audio/Video cords
 Use audio/video cords (not supplied) to connect the video components and a video cord to connect the monitor TV.

Connect red plugs to R (right), white plugs to L (left), and the yellow plugs to VIDEO. Be sure to insert completely.

Front video connections are accessed via the front panel input selector as "VIDEO."

Memo If your video components have S-video jacks, you could use S-video cords (not supplied) to connect them on the back of the receiver. These jacks are labeled by the Japanese designation "S2" on the VSX-D938TX/D908TX/D908TX-G but they are simply S-video jacks. However, if you use S-video cords for your video hook ups you must also hook up your TV with S-video connections. Conversely, if you use regular composite video cords for video hook ups, you should use them for your TV as well.

Digital Connections

In order to use Dolby Digital/DTS soundtracks and MPEG audio, you need to make digital audio connections. You can do this by either coaxial or optical connections (you do not need to do both). The quality of these two types of connections is the same but since some digital components only have one type of digital terminal, it is a matter of matching like with like (for example, the coaxial out from the component to coaxial in on the receiver). The VSX-D938TX/D908TX/D908TX-G has two coaxial and two optical inputs for a total of four digital inputs. For the VSX-D938TX, a DVD/LD player or LD player should be connected to a digital jack and the special AC-3 RF jack (if the LD has one) as well as a pair of analog jacks (see the previous page). Connect your digital components as shown below. There is one digital out jack which is marked PCM/Dolby Digital/DTS/MPEG(VSX-D938TX only) OUT. If you connect this to the optical input on a digital recorder (currently these include MD, DAT and CD-R) you can make direct digital recordings with this unit. When connecting your equipment, always make sure the power is turned off and the power cord is disconnected from the wall outlet.

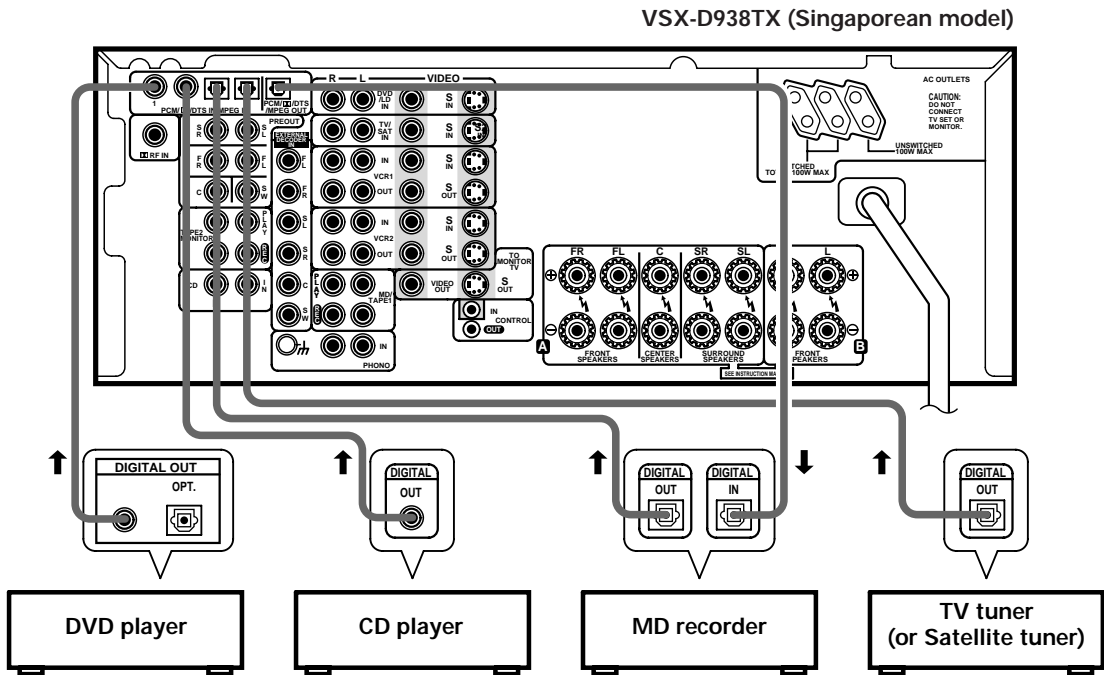

■ Digital audio cords/Optical cables

Commercially available digital audio coaxial cords (standard video cords can also be used) or optical cables (not supplied) are used to connect digital components to this receiver.

When you use optical digital input or output terminals, pull off the caps and insert the plugs. Be sure to insert completely.

**Digital audio cord
(or standard video cord)**

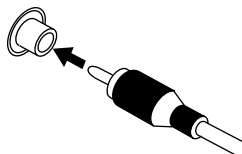

Optical cable

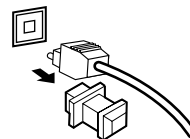

Example of connection using a DVD/LD or LD player

VSX-D938TX model:

Make sure you connect your DVD/LD or LD players using the AC-3 RF jack. If your player has an AC-3 RF output, this will ensure you can use all types of laser discs. See p. 37.

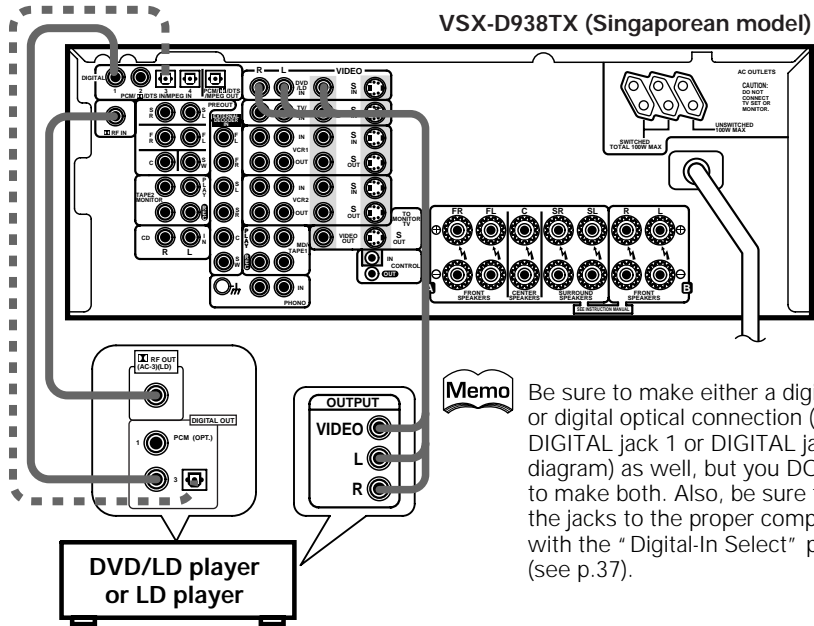

Memo Be sure to make either a digital coaxial or digital optical connection (pictured as DIGITAL jack 1 or DIGITAL jack 3 in this diagram) as well, but you DO NOT need to make both. Also, be sure to assign the jacks to the proper component(s) with the "Digital-In Select" procedure (see p.37).

VSX-D908TX/D908TX-G models:

When playing LD recorded in Dolby Digital

To connect a DVD/LD or LD player with its AC-3 RF output, a commercially available RF demodulator (RFD-1) is required. The RF demodulator changes the RF signal to a digital signal which is then processed by the VSX-D908TX/D908TX-G models through their digital input jacks. For more details, refer to the instruction manual supplied with the RFD-1.

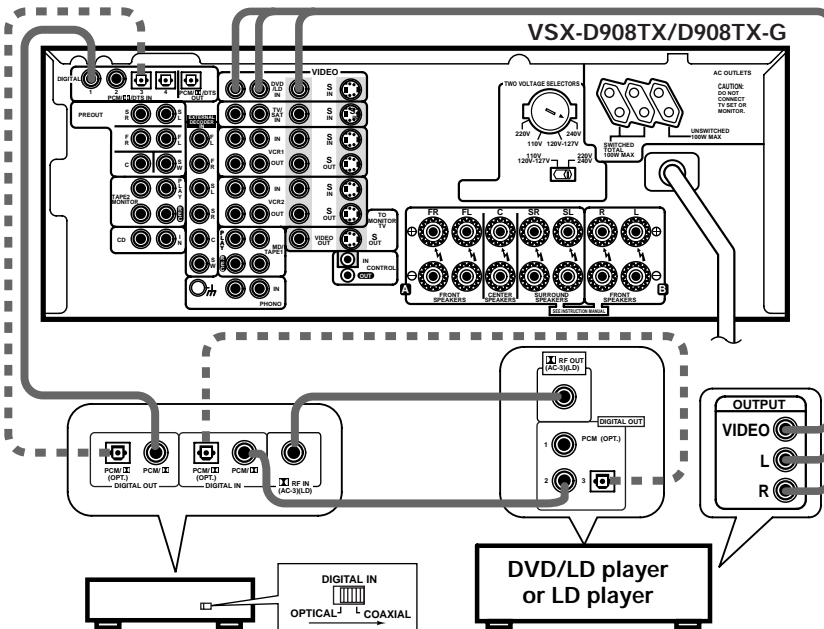

Memo Make sure the RF demodulator digital in switch is set correctly (optical or coaxial depending on the connection).

RF demodulator RFD-1

Antennas

Hook up the supplied radio antennas as shown below. When connecting your equipment, always make sure the power is turned off and the power cord is disconnected from the wall outlet.

AM loop antenna FM wire antenna

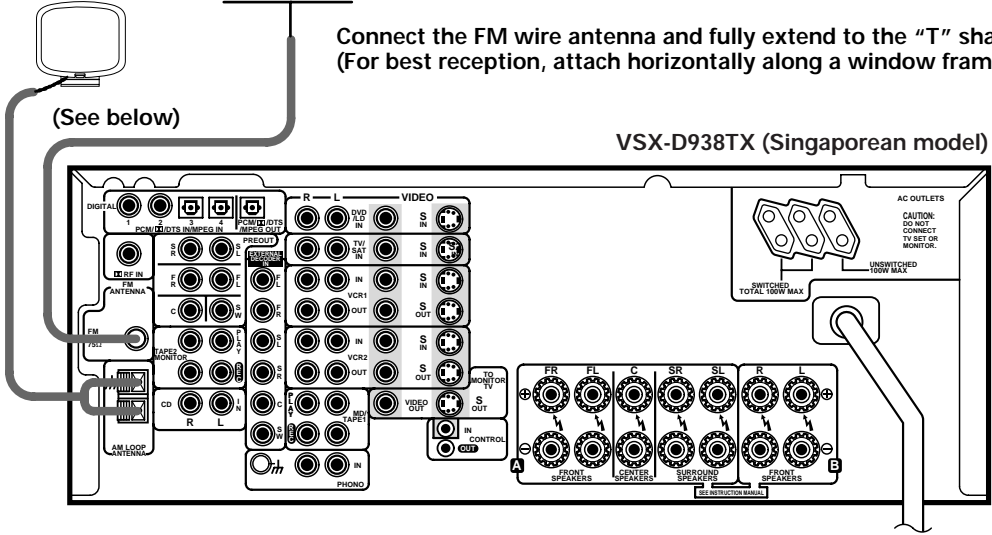

AM loop antenna

- ① Assemble the antenna.
- ② Twist exposed wire strands together and insert.
- ③ Attach to a wall, etc. (if desired) and face toward the direction providing the best reception.

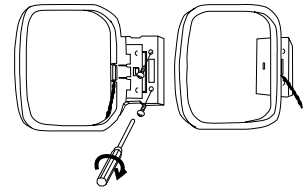
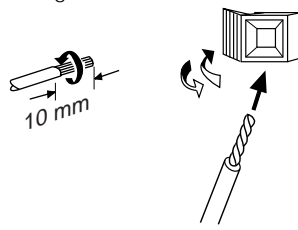
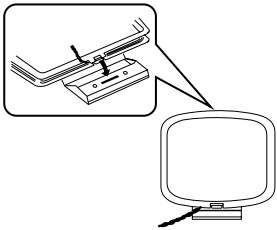

Using external antennas

To improve FM reception

Connect an external FM antenna.

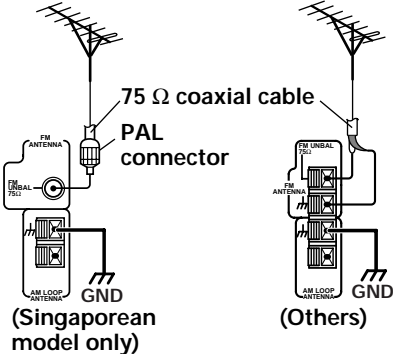

To improve AM reception

Connect a 5-6 meter length of vinyl-coated wire to the AM antenna terminal in addition to the supplied AM loop antenna.

For the best possible reception, suspend horizontally outdoors.

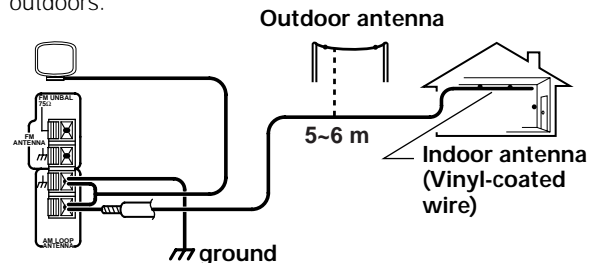

Speakers

A full complement of six speakers is shown here but, naturally, everyone's home set up will vary. Simply connect the speakers you have in the manner described below. The VSX-D938TX/D908TX/D908TX-G will work with just two stereo speakers (called "front" speakers in the diagram) but the receiver is designed to be used with at least three speakers.

Make sure you connect the speaker on the right to the right terminal and the speaker on the left to the left terminal. Also make sure the positive and negative (+/-) terminals on the receiver match those on the speakers. When connecting your equipment, always make sure the power is turned off and the power cord is disconnected from the wall outlet.



The VSX-D938TX/D908TX/D908TX-G has two speaker systems, A & B. A is the main system supporting the full complement of surround sound speakers. If you switch on both A & B speaker systems, only front speakers and the sub-woofer will be audible. No sound will come from the center or surround speakers but multi channel sources will be down-mixed to the active speakers so no sound will be lost. Similarly, if you choose just the B system, you will only hear the front speakers connected to the B system and multi channel sources will be down-mixed to these two speakers.

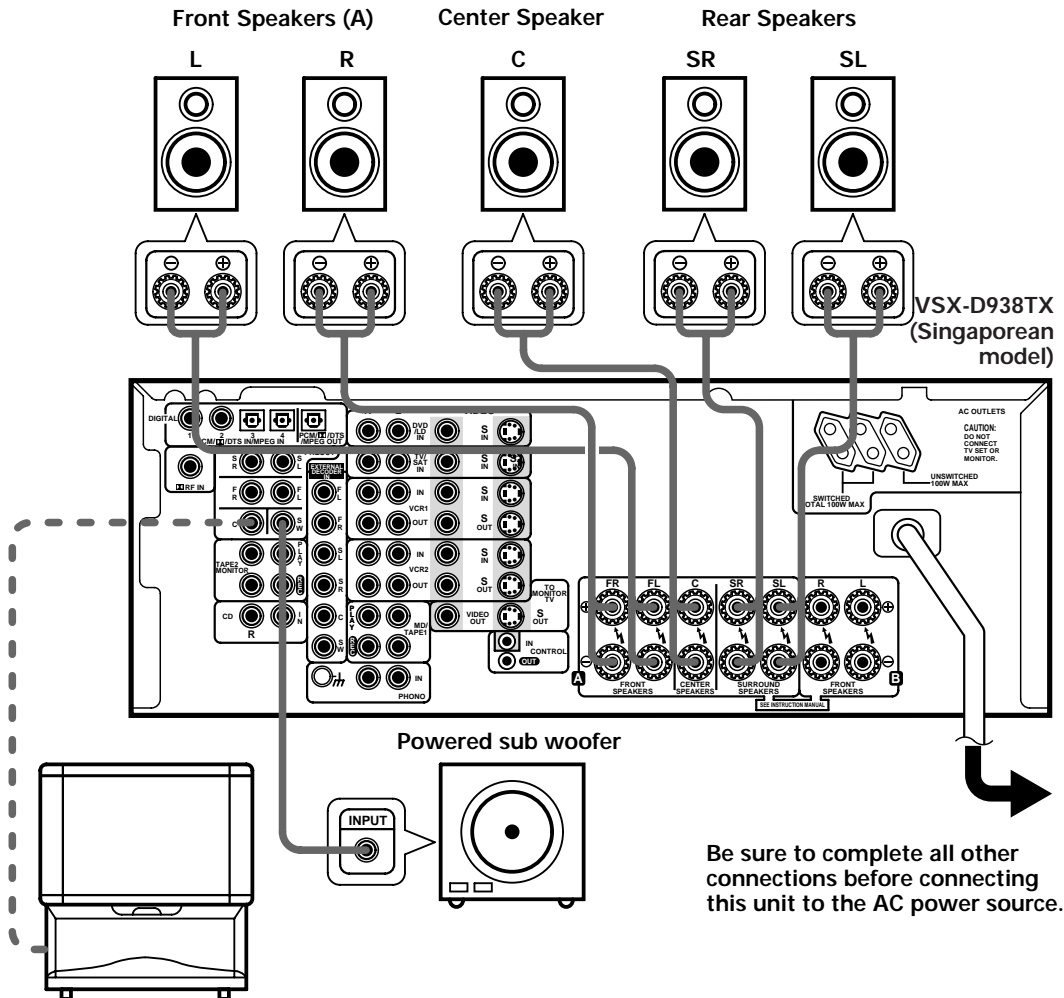

When using the speaker on your TV as the center speaker, connect the CENTER PREOUT jack on this unit to the audio input jack on your TV. In this case, the center speaker shown is unnecessary.

■ **Speaker terminals**

① Twist exposed wire strands together.



10 mm

② Loosen speaker terminal and insert exposed wire.

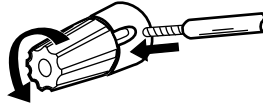

③ Tighten terminal.

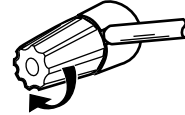

Speaker impedance

You can change the speaker impedance to suit the kind of speakers you have in your home system but we recommend using speakers with an impedance of 8 Ω-16 Ω (the default setting). If you are using 6 Ω-less than 8 Ω impedance speakers, you need to change the impedance setting.

w STANDBY/ON

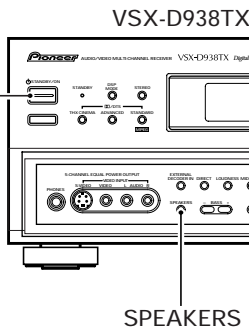

First turn the receiver off, then press the power button while holding down the SPEAKERS button.

Choose the impedance setting by pressing the SPEAKERS button again. You can choose the 8 Ω-16 Ω setting or the 6 Ω-less than 8 Ω setting.



(This display indicates an 6 Ω-less than 8 Ω impedance setting)



Memo To check which impedance the amplifier is set to hold down the SPEAKERS button for 2-3 seconds. You will get a display like the one shown below right telling you the speaker impedance setting.

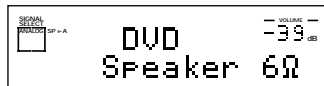

(This display indicates a 6 Ω-less than 8 Ω impedance setting)

or

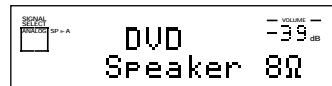

(This display indicates an 8 Ω-16 Ω impedance setting)

Speaker placement

If you have a multiple speaker arrangement the placement of the speakers is extremely important. To achieve the best possible surround sound, install your speakers as shown below. Make sure all speakers are installed securely to prevent accidents and improve sound quality. Be sure to consult your speaker manuals for the best placement of the speakers. Some speakers are designed to be floor-standing but others benefit greatly from speakers stands which raise them off the floor.

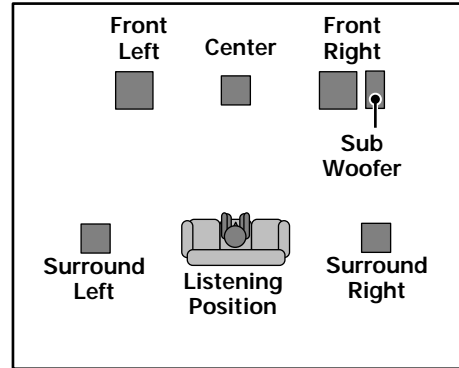
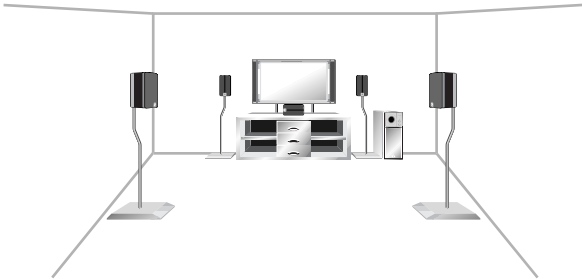

- Install the left and right front speakers at equal distances from the TV.
- When installing speakers near the TV, we recommend using magnetically shielded speakers to prevent possible interference such as distortion in the color of the TV screen. If you do not have magnetically shielded speakers and notice discoloration of the TV screen, place the speakers farther away from the TV.
- Install the center speaker above or below the TV so that the sound of the center channel is localized at the TV screen.

CAUTION:

When installing the center speaker on top of the TV, be sure to secure it with tape or some other suitable means. Otherwise, the speaker may fall from the TV due to external shocks such as earthquakes, and it may lead to endangering those nearby or damaging the speaker.

- If possible, install the surround speakers slightly above ear level.
- It may be difficult to obtain a cohesive surround effect if the surround speakers are installed farther away from the listening position than the front and center speakers.

Connecting Additional Amplifiers

Although the VSX-D938TX/D908TX/D908TX-G has more than sufficient power for any home use, it is possible to add additional amplifiers to your system. If you want to use separate amplifiers to power your speakers, make the connections shown below.

When connecting your equipment always make sure the power is turned off and the power cord is disconnected from the wall outlet for all the equipment.

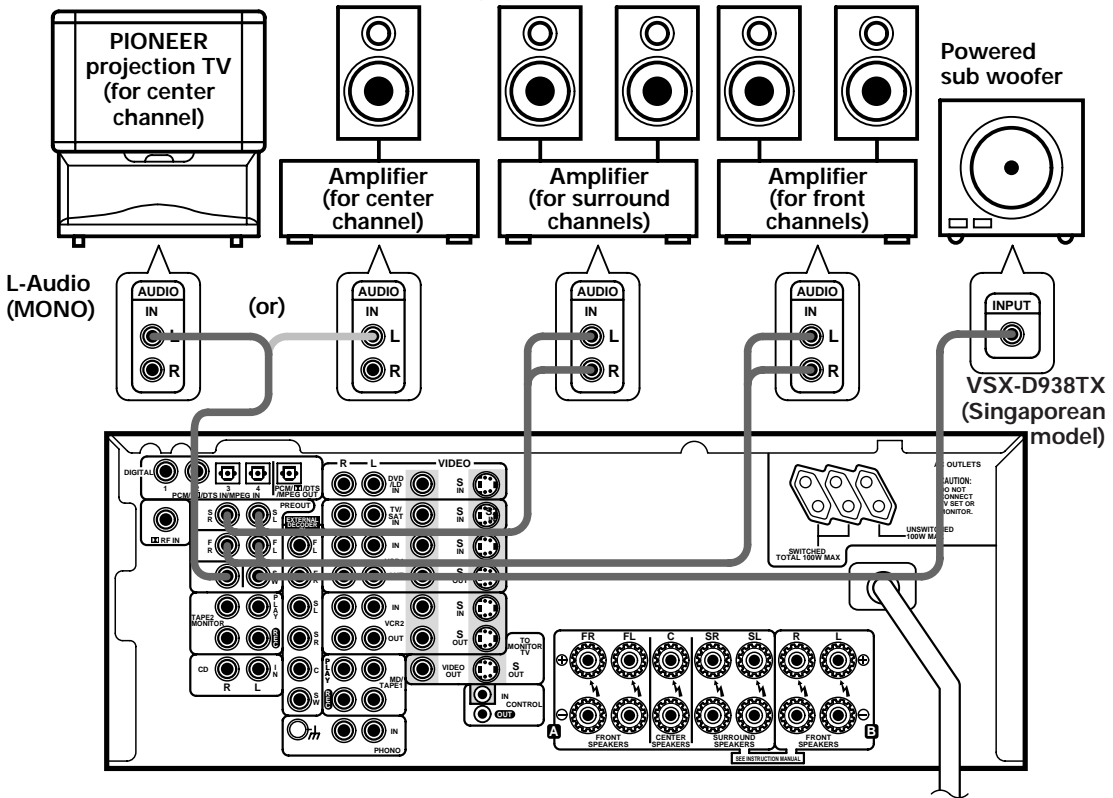

Power Connections (AC OUTLETS)

[SWITCHED TOTAL 100 W MAX]

Power supplied through these outlets is turned on and off by the receiver's POWER switch. Total electrical power consumption of connected equipment should not exceed 100 W.

[UNSWITCHED 100 W MAX]

Power flows continually to this outlet, regardless of whether the receiver is switched ON or OFF. Electrical power consumption of the connected equipment should not exceed 100 W.

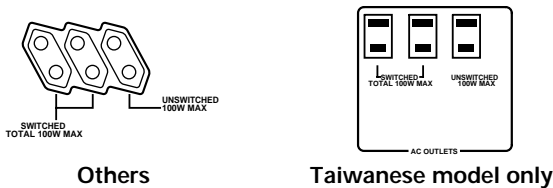

CAUTION!

- To avoid overheating, fire risk, and possible malfunction do not connect high-wattage appliances such as heaters, irons, monitors, or TV sets to the AC OUTLETS.
- Remove the power plug from the wall socket to disconnect this unit from the AC power source when not in regular use, for example, when on vacation.

Display

All the display information is explained and/or referenced here.

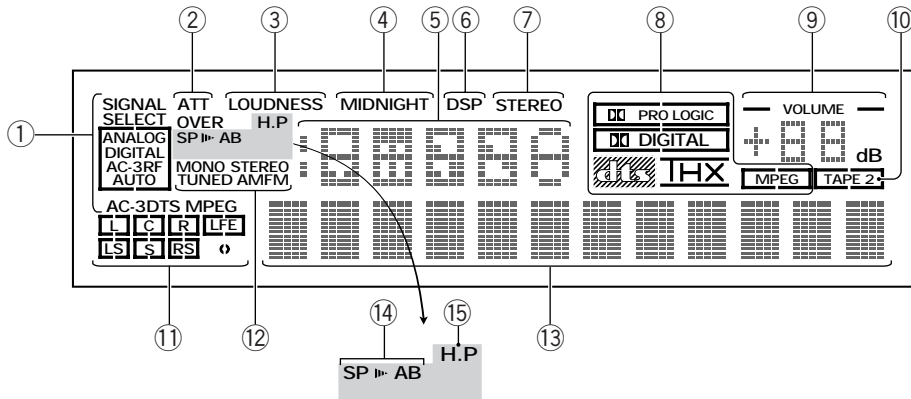

① SIGNAL SELECT indicators

Light to indicate the type of input signal assigned for the current component (see "Front Panel", ⑩ (VSX-D938TX), ⑰ (VSX-D908TX/D908TX-G), SIGNAL SELECT).

ANALOG : Lights when an analog signal is selected.

DIGITAL : Lights when a digital audio signal is selected (DVD/LD, CD, MD/TAPE1, TV/SAT, VCR 1, VCR 2).

AC-3 RF: Lights when an AC-3 RF signal is selected (DVD/LD, TV/SAT, VCR 1, VCR 2). (VSX-D938TX only)

AUTO: Lights when the receiver is set to select the input signal automatically. (DVD/LD, CD, MD/TAPE 1, TV/SAT, VCR 1, VCR 2). (VSX-D938TX only)

AC-3 : Lights when a source with Dolby Digital signals is played.

DTS : Lights when a source with DTS audio signals is played.

MPEGA: Blinks when the MPEG mode is selected, and lights when a source with MPEG audio signals is played. (VSX-D938TX only)

② Analog level indicators

OVER : If "ANALOG" is selected in SIGNAL SELECT, this indicator lights to show that an excessively strong signal is being processed. When this occurs, press INPUT ATT on the front panel to attenuate (lower) the signal. Also, when "DIGITAL" is selected in SIGNAL SELECT, this indicator lights to show that a source containing an excessive amount of information is being processed. If this occurs, see p. 41.

ATT : Lights when INPUT ATT is used to reduce the level of the input signal (available in ANALOG mode only).

③ LOUDNESS indicator (See p.48)

Lights when the LOUDNESS mode is on.

④ MIDNIGHT indicator (See p.46)

Lights when the MIDNIGHT LISTENING mode is on.

⑤ Radio Frequency/Function indicator

Displays the function or the frequency of the current radio station.

⑥ DSP indicator (See p.40-41)

Light when a DSP or Advanced Theater mode is selected.

⑦ STEREO indicator (See p.40-41)

Lights when a STEREO mode is selected.

⑧ Surround/dts mode indicators

DIGITAL : When the Surround/dts mode on the receiver is on, this indicator lights to indicate playback of a Dolby Digital signal. However, PRO LOGIC lights during 2 channel playback of Dolby Digital.

PRO LOGIC : When the Surround/dts mode on the receiver is on, this indicator lights during 2 channel playback. (Both B or A+B speaker systems turn off automatically when headphones are plugged in.)

DTS : Lights when DTS signals are input.

MPEGA: Lights when MPEG signals are input. (Dolby/DTS/MPEGA mode is ON). (VSX-D938TX only)

⑨ MASTER VOLUME indication

Displays current level of master volume.

⑩ TAPE 2 indicator

Lights when the TAPE 2 monitor is on.

⑪ Program Format indicator

When a Dolby Digital or DTS signal is input, the following indicators light to show the channels being played back.

L : Left front*¹*², **C** : Center*¹, **R** : Right front*¹*²,
LS : Left surround*¹, **S** : Surround (mono)*²,
RS : Right surround*¹

*1: Indicates 5.1ch Dolby Digital or DTS playback.

*2: Indicates Dolby Pro Logic playback.

⑫ Tuner indicators

MONO : Lights when the tuner is set to receive FM broadcasts and when selected MPX mode.

STEREO : Lights when a FM stereo broadcast is received in the auto stereo mode.

TUNED : Lights when a broadcast is received.

AM/FM : Light to indicate the current band (FM or AM).

⑬ Character display

Displays sound modes, general information, etc.

⑭ Speaker indicators

Light to indicate the current speaker system (see "Front Panel", ㉔ (VSX-D938TX), ㉕ (VSX-D908TX/D908TX-G), SPEAKERS (A/B)).

SP ▷ A : Lights when speaker system A is selected.

SP ▷ B : Lights when speaker system B is selected.

SP ▷ AB : Lights when speaker systems A and B are both selected.

⑮ H.P (headphones) indicator

Lights when headphones are connected to the PHONES jack (speakers A and B turn off automatically).

⑯ LFE indicator

LFE (Low Frequency Effects) indicator lights to indicate that the program source contains an LFE channel. The indicator under the LFE lights during actual playback of the LFE signals (LFE signals are not present in all parts of the soundtrack).

Front Panel (VSX-D938TX)

All the controls on the front panel are explained and/or referenced here. To open the front panel, push gently on the lower third of the panel.

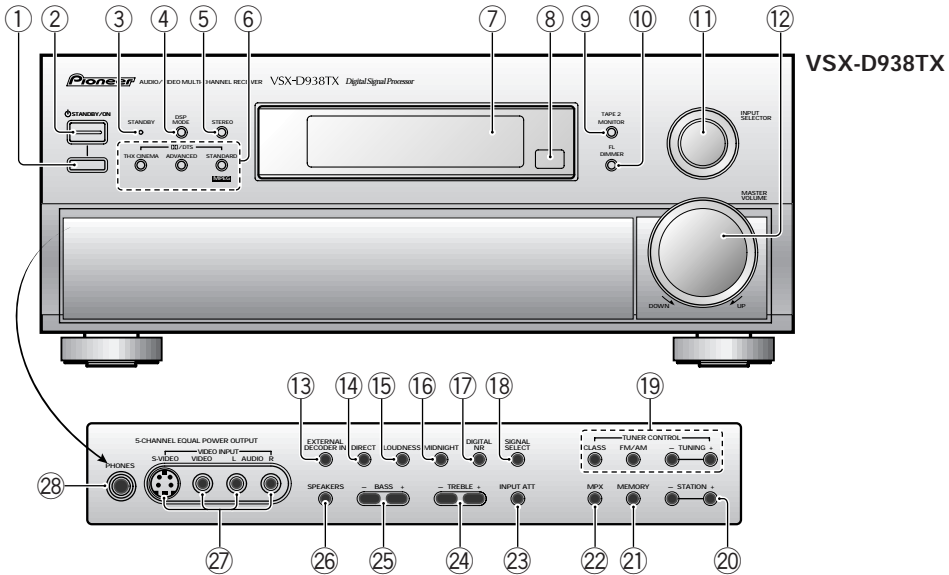

- ① **Main Power Switch** (■ OFF, ▬ ON)
- ② **STANDBY/ON button**
Press to switch the receiver ON or into STANDBY mode.
- ③ **STANDBY indicator**
Lights when the receiver is in STANDBY mode. (Please note that this receiver consumes a small amount of power (1.0 W) during the standby mode.)
- ④ **DSP MODE button** (See p.40-41)
Press repeatedly to select a DSP sound mode. (HALL 1, HALL 2, JAZZ, DANCE, THEATER 1, or THEATER 2). Use these modes to produce surround sound from standard (two channel) stereo sources and create different listening environments.
- ⑤ **STEREO button** (See p.40-41)
Press to select the STEREO sound mode. In this mode, sound comes from the front (left and right) speakers only.
- ⑥ **THX/DTS buttons** (See p. 39, 41 and 76-78)
THX CINEMA: Press to select the HOME THX CINEMA sound mode when listening to Dolby Digital, Dolby Pro Logic or DTS a variety of other sources.
ADVANCED THEATER : Press to select one of the four Advanced Theater modes.
STANDARD (MPEG) : Press to select the STANDARD/MPEG mode.
- ⑦ **Display** (See page 18)
- ⑧ **Remote sensor**
Point the remote control toward the remote sensor to operate the receiver.
- ⑨ **TAPE 2 MONITOR button** (See p.66)
Selects the tape deck (MD recorder, etc.) connected to the TAPE 2 MOINTOR inputs/ outputs. Allows monitoring of a recording as it is being made.
- ⑩ **FL DIMMER button** (See p.49)
Use to adjust the brightness of the main display.
- ⑪ **INPUT SELECTOR dial**
Turn to select a source component. The source indicators show the current component:
DVD/LD : DVD player or Laser Disc player.
TV/SAT : TV tuner or satellite tuner.
CD : Compact Disc player.
MD/TAPE 1 : Tape deck or Mini Disc recorder connected to MD/TAPE 1 inputs/outputs.
TUNER : The built-in tuner.
PHONO : Turntable.
VIDEO : Video camera (etc.) connected to the VIDEO INPUT on the front panel.
VCR 1 : Video cassette recorder connected to VCR 1 inputs.
VCR 2 : Video cassette recorder or other component connected to VCR 2 inputs.

- ⑫ **MASTER VOLUME**
Adjusts the overall receiver volume.
- ⑬ **EXTERNAL DECODER IN (See p.47)**
Use to hook up an external component that can decode other types of signals and input them into the VSX-D938TX.
- ⑭ **DIRECT button**
Switches DIRECT playback on or off. Use to bypass the tone controls and channel level for the most accurate reproduction of a program source. It will automatically put the receiver in STEREO mode for the function being used for DIRECT playback.
- ⑮ **LOUDNESS button (See p.48)**
Switches the LOUDNESS mode on or off.
- ⑯ **MIDNIGHT button (See p.46)**
Switches the MIDNIGHT LISTENING mode on or off.
- ⑰ **DIGITAL NR button (See p.45)**
Switches the DIGITAL NR on or off (STEREO mode only).
- ⑱ **SIGNAL SELECT button (See p.42)**
Use to select the signal from the digital components.
SIGNAL SELECT repeatedly to select one of the following:
ANALOG : To select an analog signal.
DIGITAL : To select a optical or electrical digital signal.
AC-3 RF: To select an AC-3 RF signal.
AUTO: This is the default. If there are both analog and digital input signals, the receiver automatically selects the digital signal.
- ⑲ **TUNER CONTROL button (See p.50-53)**
CLASS : Press repeatedly to switch the preset station classes.
FM/AM : Press to select the AM or FM band.
TUNING -/+ : Use to manually tune to radio stations.
- ⑳ **STATION -/+ buttons (See p.52-53)**
Use to choose programmed radio stations.
- ㉑ **MEMORY button (See p.52)**
Press to start the memorization of a preset station.
- ㉒ **MPX button (See p.50)**
Press to switch between auto stereo and MONO reception of FM broadcasts. When the broadcast signal is weak, selecting MONO will improve the sound quality.

- ㉓ **INPUT ATT button**
Use to lower the input level of an analog signal that is too powerful, thus causing the receiver to distort (the overload indicator will light furiously).
- ㉔ **TREBLE (-/+) buttons (See p.48)**
Use to adjust the high frequencies.
- ㉕ **BASS (-/+) buttons (See p.48)**
Use to adjust low frequencies.
- ㉖ **SPEAKERS (A/B) buttons**
A is the primary setting. It plays all speakers hooked up to the A system. A and B setting only plays the front speakers of both the A and B systems and the sub-woofer, multi channel sources will be down-mixed to these speakers so no sound will be lost. B setting only plays the front speakers connected to the B system and multi channel sources will be down-mixed to these two speakers.

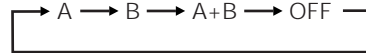

- ㉗ **VIDEO INPUT jacks (See p.9)**
S-VIDEO : Video input for connecting a video camera (etc.), that has an S-Video out.
VIDEO / AUDIO (L/R) : Video input for connecting a video camera, etc. that has standard video/audio outputs.
- ㉘ **PHONES jack**
Connect headphones for private listening (no sound will be heard through the speakers).

Front Panel (VSX-D908TX/D908TX-G)

All the controls on the front panel are explained and/or referenced here. To open the front panel, push gently on the lower third of the panel.

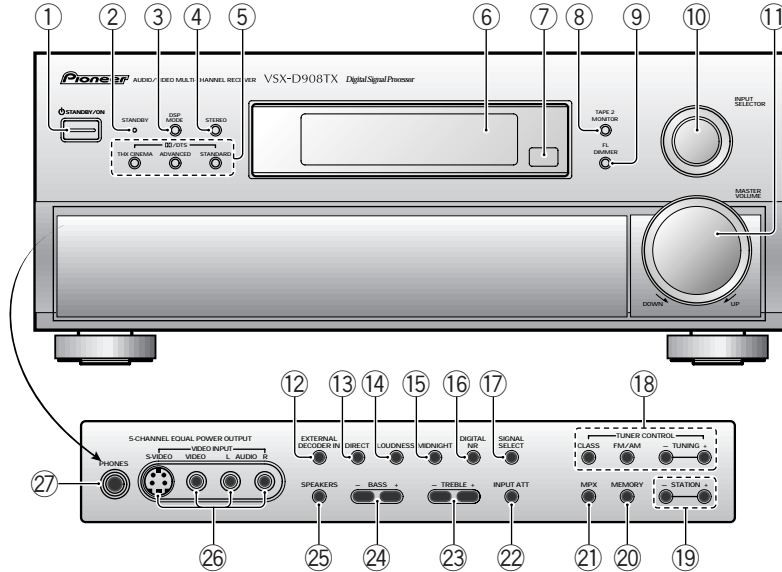

① **STANDBY/ON button**

Press to switch the receiver ON or into STANDBY mode.

② **STANDBY indicator**

Lights when the receiver is in STANDBY mode. (Please note that this receiver consumes a small amount of power (1.0 W) during the standby mode.)

③ **DSP MODE button (See p.40-41)**

Press repeatedly to select a DSP sound mode. (HALL 1, HALL 2, JAZZ, DANCE, THEATER 1, or THEATER 2). Use these modes to produce surround sound from standard (two channel) stereo sources and create different listening environments.

④ **STEREO button (See p.40-41)**

Press to select the STEREO sound mode. In this mode, sound comes from the front (left and right) speakers only.

⑤ **THX CINEMA/DTS buttons (See p. 39, 41 and 76-78)**

THX CINEMA: Press to select the HOME THX CINEMA sound mode when listening to Dolby Digital, Dolby Pro Logic or DTS a variety of other sources.

ADVANCED THEATER : Press to select one of the four Advanced Theater modes.

STANDARD : Press for pure decoding of multi channel sources.

⑥ **Display (See p.18)**

⑦ **Remote sensor**

Point the remote control toward the remote sensor to operate the receiver.

⑧ **TAPE 2 MONITOR button (See p.66)**

Selects the tape deck (MD recorder, etc.) connected to the TAPE 2 MONITOR inputs/ outputs. Allows monitoring of a recording as it is being made.

⑨ **FL DIMMER button (See p.49)**

Use to adjust the brightness of the main display.

⑩ **INPUT SELECTOR dial**

Turn to select a source component. The source indicators show the current component:

DVD/LD : DVD player or Laser Disc player.

TV/SAT : TV tuner or satellite tuner.

CD : Compact Disc player.

MD/TAPE 1 : Tape deck or Mini Disc recorder connected to MD/TAPE 1 inputs/outputs.

TUNER : The built-in tuner.

PHONO : Turntable.

VIDEO : Video camera (etc.) connected to the VIDEO INPUT on the front panel.

VCR 1 : Video cassette recorder connected to VCR 1 inputs.

VCR 2 : Video cassette recorder or other component connected to VCR 2 inputs.

⑪ **MASTER VOLUME**

Adjusts the overall receiver volume.

- ⑫ **EXTERNAL DECODER IN button (See p.47)**
Use to hook up an external component that can decode other types of signals and input them into the VSX-D908TX/D908TX-G.
- ⑬ **DIRECT button**
Switches direct playback on or off. Use to bypass the tone controls and channel level for the most accurate reproduction of a program source. It will automatically put the receiver in STEREO mode for that function being used for DIRECT playback.
- ⑭ **LOUDNESS button (See p.48)**
Switches the LOUDNESS mode on or off.
- ⑮ **MIDNIGHT MODE button (See p.46)**
Switches the MIDNIGHT LISTENING mode on or off.
- ⑯ **DIGITAL NR button (See p.45)**
Switches the DIGITAL NR on or off (STEREO mode only).
- ⑰ **SIGNAL SELECT button (See p.42)**
Use to select the signal from the digital components.
SIGNAL SELECT repeatedly to select one of the following:
ANALOG : To select an analog signal.
DIGITAL : To select a optical or electrical digital signal.
- ⑱ **TUNER CONTROL button (See p.50-53)**
CLASS : Press repeatedly to switch the preset station classes.
FM/AM : Press to select the AM or FM band.
TUNING -/+ : Use to manually tune to radio stations.
- ⑲ **STATION -/+ buttons (See p.52-53)**
Use to choose programmed radio stations.
- ⑳ **MEMORY button (See p.52)**
Press to start the memorization of a preset station.
- ㉑ **MPX button (See p.50)**
Press to switch between auto stereo and MONO reception of FM broadcasts. When the broadcast signal is weak, selecting MONO will improve the sound quality.
- ㉒ **INPUT ATT button**
Use to lower the input level of an analog signal that is too powerful, thus causing the receiver to distort (the overload indicator will light furiously).
- ㉓ **TREBLE (-/+) buttons (See p.48)**
Use to adjust the high frequencies.

㉔ **BASS (-/+) buttons (See p.48)**

Use to adjust low frequencies.

㉕ **SPEAKERS (A/B) buttons**

A is the primary setting. It plays all speakers hooked up to the A system. A and B setting only plays the front speakers of both the A and B systems and the sub-woofer, multi channel sources will be down-mixed to these speakers so no sound will be lost. B setting only plays the front speakers connected to the B system and multi channel sources will be down-mixed to these two speakers.

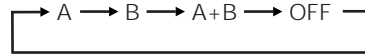

㉖ **VIDEO INPUT jacks (See p.9)**

S-VIDEO : Video input for connecting a video camera (etc.), that has an S-Video out.

VIDEO / AUDIO (L/R) : Video input for connecting a video camera, etc. that has standard video/audio outputs.

㉗ **PHONES jack**

Connect headphones for private listening (no sound will be heard through the speakers)

Remote Control

These pages describe the buttons on the remote control used to operate the receiver.

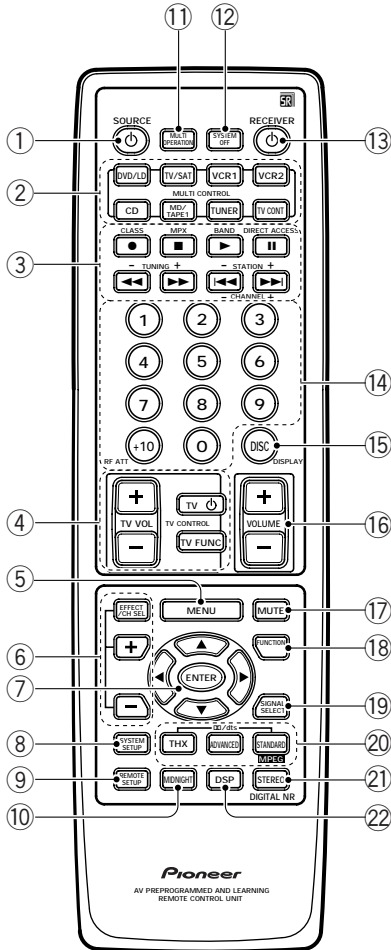

VSX-D938TX

① **SOURCE button (See p.58-65)**

Use to turn on the power of your other components after you have recalled or taught the signals to this remote control.

② **MULTI CONTROL buttons**

Use these to select a source and the corresponding remote operation mode. For example, pressing TUNER selects the built in tuner and sets the remote operation to the tuner functions.

③ **Component Control buttons**

Use to control specific components, like a CD player or DVD player, after you have programmed the remote control to do these operations (see p.58-65) and the remote is put in that operation mode.

④ **TV CONTROL buttons**

The following buttons are used to control the TV only and can be used no matter what function the remote control is set to.

TV ⏻ : Press to turn the power of the TV on/off.

TV FUNC : Press TV FUNC to select the TV for remote control operation.

TV VOL +/- : Press to control the volume of the TV.

⑤ **MENU button**

Use to get the various menus for this unit onto your TV or DTV screen.

⑥ **EFFECT/CH SEL +/- buttons (See p.41)**

EFFECT : Use these buttons to increase or decrease the amount of effect applied in a DSP or Advanced Theater mode. When the amount of effect is increased in a DSP/Advanced Theater mode the characteristics of that mode become stronger and more noticeable. The scale ranges from 10-90 with 70 as the default setting. First turn on the DSP/Advanced Theater you want (by pressing the DSP/Advanced Theater button until you get the mode) and then increase or decrease the amount of effect.

CH SEL : You may want to adjust the channels when listening to some sound sources. Use this button to select the channel you want to adjust.

+/- : Use these buttons to select the amount of effect in a sound mode and to adjust the channel level when making surround sound settings.

⑦ **▲/▼/◀/▶/ENTER buttons**

Use to operate the on-screen menu on your TV screen and enter commands when setting up surround sound, speakers levels & settings, and other set up features (see p.27-37). Specific use of these buttons is described in conjunction with the operations they perform. For more information, see each individual section.

⑧ SYSTEM SETUP button

Use to set up the speaker and sound systems. For more information, see "Surround Sound Setup" on p. 26.

⑨ REMOTE SETUP button.

Use to customize the remote control functions and the remote control itself. (See "Setting Up the Remote Control to Control Other Components" on p.54, "Multi Operation" on p. 69.)

To access the EXTERNAL DECODER option, press the REMOTE SETUP button and the SIGNAL SELECT button simultaneously.

⑩ MIDNIGHT button (See p. 46)

Switches the MIDNIGHT LISTENING mode on or off.

⑪ MULTI OPERATION button

Use this button to start the MULTI OPERATION mode. See p. 69 for how to program and use the MULTI OPERATION mode.

⑫ SYSTEM OFF button

This button turns off components in two ways. First, when pressed it will turn off all PIONEER components. Secondly, any component that has programmed into the MULTI OPERATIONS settings will also be turned off. (see p.69).

For example : If you programmed power off in the SYSTEM OFF settings for your TV and VCR, pressing the SYSTEM OFF button will turn off these components even if they are not PIONEER products.

⑬  RECEIVER button

Press to turn power of the receiver on or to STANDBY (off).

⑭ Number buttons

These buttons can perform a variety of different functions depending on the remote operation mode. They are most useful for CD and tuner operations.

⑮ DISC/DISPLAY button

These buttons can perform a variety of different functions depending on the remote operation mode.

⑯ MASTER VOLUME button

Use to raise or lower the volume of the receiver.

⑰ MUTE button

Press to mute or restore the volume.

⑱ FUNCTION button

Press to select a source. The button will cycle through all the possible sources.

⑲ SIGNAL SELECT button

Press SIGNAL SELECT repeatedly to select one of the following:

ANALOG : To select an analog signal.

DIGITAL : To select a digital signal (DVD/LD, TV/SAT, CD, MD/TAPE 1, VCR 1, VCR 2).

AC-3 RF: To select an AC-3 RF signal (DVD/LD, TV/SAT, VCR 1, VCR 2). (VSX-D938TX only)

AUTO: This is the default. If there are both analog and digital input signal, the receiver automatically selects the best possible signal. Press the SIGNAL SELECT and REMOTE SETUP buttons simultaneously to switch from the SIGNAL SELECT operation to EXTERNAL DECODER operation.

Then press the button to get the EXTERNAL DECODER function. To get back to the SIGNAL SELECT control, press the REMOTE SETUP button and the SIGNAL SELECT button simultaneously once again. (VSX-D938TX only)

⑳ /dts/MPEG (VSX-D938TX only) buttons (See p.41)

Press these buttons to put the receiver in the selected sound mode. For more information on the modes .

㉑ STEREO/DIGITAL NR button

STEREO : Press this button to put the receiver into stereo mode when it is in a different sound mode. For more information on the sound modes, see p.41.

DIGITAL NR : Switches the DIGITAL NR on or off (see p.44).

㉒ DSP button (See p.41)

Press repeatedly to select a DSP sound mode.

Surround Sound Set Up

On Screen Display

There are a number of possible ways to hook up the receiver to your video components like a DVD player and hook up to your receiver to your TV, but some of them will not allow you to use the on-screen display of this unit. To avoid this one simply needs to follow two rules.

- ① Always use the same type of video cords to hook up your video components to the receiver as you use to hook up the receiver and your TV. For example, if you use composite video cords to hook up your DVD and the receiver, use composite video cords to hook up the receiver to your TV. If you use S video cords to hook up your DVD and the receiver, use S video cords to hook up the receiver to your TV.
- ② Always make sure your TV is set to the appropriate input channel on your TV (for example, video 1). Your TV may have a number of input channels and if you do not select the proper one you will not be able to use this receiver's on-screen display. If you are unsure how to choose an input channel for your TV, refer to the manual which came with your TV.

You might, for example, use both composite and S video cords to hook up your video component with this receiver and then use composite video cords to hook up this receiver to your TV. This arrangement would still NOT let you see the on screen displays from this receiver on your TV. The best idea is just to use one type of video cord for all your video component and TV hook ups.

Switching video system between PAL and NTSC

This receiver is able to use two types of video systems for its OSD (on screen display) and you need to set the receiver to the type of video system you have, either PAL or NTSC. If you do not match the system on the receiver with your home system no OSD will appear on your TV. People with multi-system TVs, don't need to worry about changing the setting. If necessary, follow the instructions below to switch the type of video system.

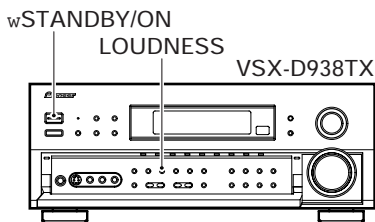

1 Put the receiver in STANDBY mode.

2 While holding down the LOUDNESS button press the STANDBY/ON button. The video system type, either "PAL" or "NTSC," appears in the display. It will be shown for about seven seconds and then the receiver reverts to normal operating mode.

Be careful to press the LOUDNESS button and NOT the DIRECT button, which will accidentally clear all your speaker settings (see warning p.29-30).

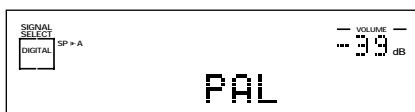

when a PAL system is selected



when a NTSC system is selected



When using the PAL setting the OSD does not get displayed in color.

Setting Up for Surround Sound

To ensure the best possible surround sound, be sure to complete the following set up operations. This is particularly important when using the DTS, **DD** (Dolby) Surround sound and MPEG (VSX-D938TX only) modes. You only need to make these settings once (unless you change the placement of your current speaker system or add new speakers, etc.). These set up operations use your TV to display the settings and choices so be sure your TV and receiver are properly hooked up.

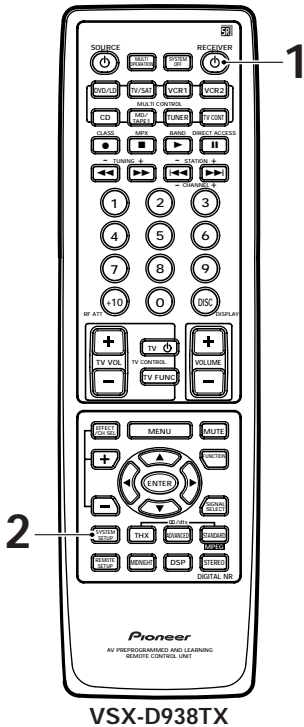

1 Turn on the receiver and your TV.

Make sure your TV is set to the receiver.

2 Press SYSTEM SETUP button.

The SYSTEM SETUP MENU appears on your TV screen.

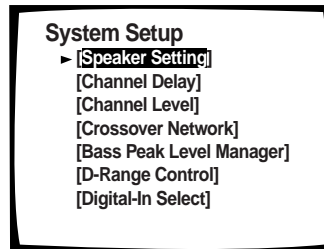

* You can escape from this screen at any time by pressing the SYSTEM SETUP button again. None of the settings you made will be entered in this case.

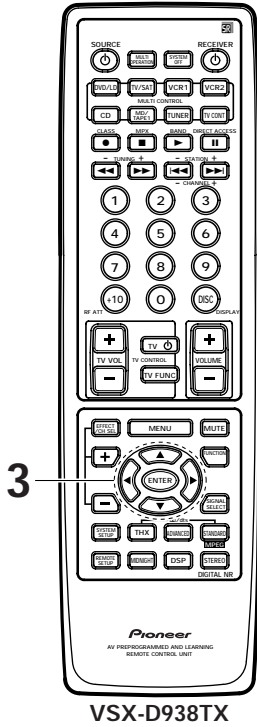

3 Press the ▲ or ▼ arrow buttons to move the cursor to the mode you want. Then press ENTER.

In each mode, the current settings are displayed automatically. We suggest you adjust all these settings when you first hook up the receiver. That gets them out of the way and you will not need to return to this setting mode unless you change your home set up by adding new speakers (etc.). The sound set up modes explained here are:

Speaker Setting (See p.29-30)

Use to specify the type and number of speakers you connected.

Channel Delay (See p.31)

Set up all your speakers for the most realistic surround sound. Adding a slight delay to some speakers enhances sound separation and is particularly important for achieving a surround sound effect. You need to figure out the distance from your listening position to your speakers to add the proper delay.

Channel Level (See p.32-33)

Use to balance the volumes of your different speakers.

Crossover Network (See p.34)

This feature lets you select which bass frequencies will be sent to the sub woofer or front speakers.

Bass Peak Level Manager (See p.35)

Dolby Digital and DTS audio sources include ultra-low bass tones. Set the bass peak level as needed to prevent the ultra-low bass tones from distorting the sound from the speakers.

D-Range Control (See p.36)

This feature makes possible excellent surround sound effects when listening to Dolby Digital sources at low volumes.

Digital-In Select (See p.37)

In order to use your digital components, you must match the numbered digital input buttons with the numbered digital jacks used by your digital components.

4 Go on to the next page to continue set up.

To exit the SYSTEM SETUP MENU and on-screen display press SYSTEM SETUP button again.



After you complete one of the SYSTEM SETUP menus and return to the basic SYSTEM SETUP screen (shown in the diagram directly above labeled 4), the receiver automatically moves the cursor to the next SYSTEM SETUP menu. For example, if you've completed SPEAKER SETTING and returned to the basic SYSTEM SETUP screen, CHANNEL DELAY will be selected automatically. You can notice this on your TV screen.

Speaker setting

The following steps show you how to specify the type of speakers you connected. Use the ▲/▼ and ◀/▶ arrow buttons to make a selection within the on-screen menus, and use the ENTER to register the information.

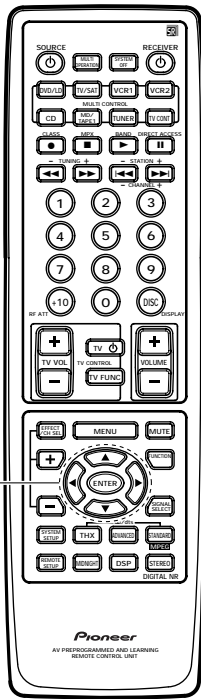

VSX-D938TX

1 Select SPEAKER SETTING with the ▲/▼ buttons.

See "Setting Up for Surround Sound" on page 27 if you are unsure how to do this.

Press ENTER.

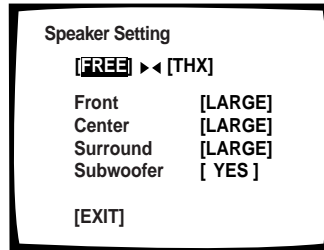

2 Select a speaker setting mode with the ◀/▶ buttons.

Press the ▼ button.

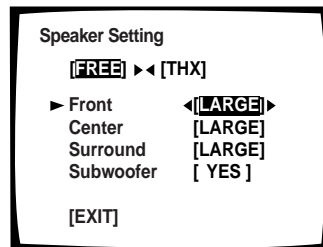

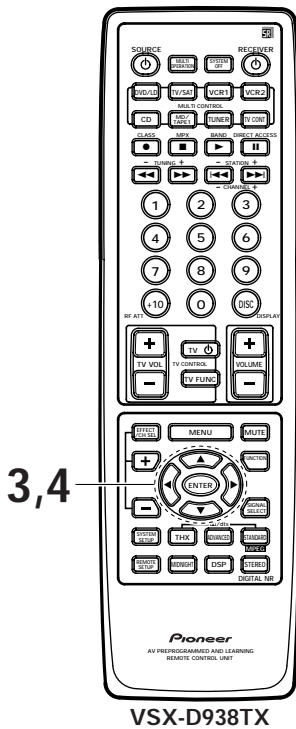

3 Specify the type of speakers you connected. See the explanations below for the meaning of each size.

- ① Press ◀ or ▶ to move the cursor to LARGE, SMALL, or NO (you cannot select NO for the FRONT speakers).
- ② Press ▼.
- ③ Repeat ① and ② for each speaker.

Depending on your choices the sound will be routed differently, as explained here.

FRONT (default setting is LARGE)

- Select small to send bass frequencies to the sub woofer.
- Select large if your speakers will reproduce bass frequencies effectively or if you did not connect a sub woofer. (If you select small for the front speakers the sub woofer will automatically be switched YES. Also, the center and surround speakers cannot be set to large if the front speakers are set to small. In this case, all bass frequencies are sent to the sub woofer.)

CENTER (default setting is LARGE)

- Select large if your speaker will reproduce bass frequencies effectively.
- Select small to send bass frequencies to the other speakers or sub woofer.
- If you did not connect a center speaker, deselect it. In this case, the center channel is output from the front speakers.

SURROUND (default setting is LARGE)

- Select large if your speakers will reproduce bass frequencies effectively.
- Select small to send bass frequencies to the other speakers or sub woofer.
- If you did not connect surround speakers, deselect them. In this case, the sound of the surround channels is output from the front and center speakers.

SUB WOOFER (default setting is YES)

- Leave it selected if you connected a sub woofer.
- If you did not connect a sub woofer, deselect it. In this case, the bass frequencies are output from the front or surround speakers.
- Choose the PLUS setting if you want stronger reproduction of deep bass sounds.
- If you select PLUS the bass frequencies that would normally come out the front and center speakers are all routed to the sub woofer.

4 Select EXIT with the ▲/▼ buttons and press ENTER to return to the SYSTEM SETUP MENU.

Next, proceed to CHANNEL DELAY below.

If you want to change a setting before proceeding

Simply use the arrow buttons to go back.



If you have a sub woofer and like lots of bass, it may seem logical to select LARGE for your FRONT speakers and leave the sub woofer selected. This may not, however, yield the best bass results. Depending on the size and shape of your room, you may actually experience a decrease in the amount of bass due to what is called "low frequency cancellations." If you have a sub woofer, listen to the bass response with the FRONT speakers set to LARGE and SMALL alternatively and let your ears judge which sounds best.

The safest option in this case is to route all the bass sounds to the sub woofer by selecting SMALL for the FRONT speakers.

Channel delay

Adding a slight delay to some speakers is necessary to achieve a surround sound effect. You need to figure out the distance from your listening position to your speakers to add the proper delay. The following steps show you how to set the delay time for each channel by specifying the distances from your listening position to each speaker. Once you specify the speaker distances, the receiver calculates the correct delay times automatically. If continuing from SPEAKER SETTING, go to step 1. If starting fresh, complete steps 1-3 in "Setting Up for Surround Sound" (p.27) first.

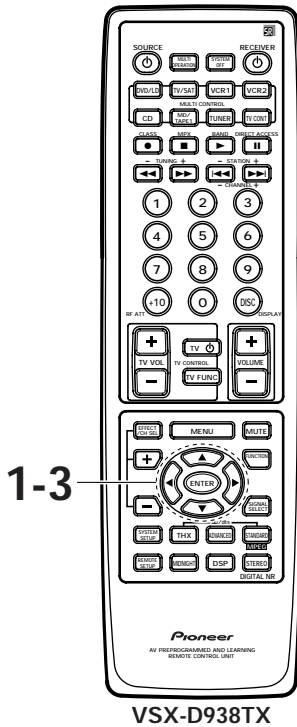

1 Select CHANNEL DELAY (if continuing from last set up, it will already be selected).

See "Setting Up for Surround Sound" on page 27 if you are unsure how to do this.

Press ENTER.

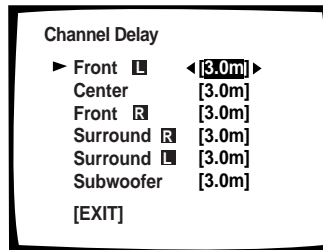

Memo The default setting is 3.0 m.

2 Use the ▲/▼ buttons to select a speaker. Specify the distance from your listening position to each speaker using the commands below.

① Press ◀ or ▶ to adjust the speaker distance in 0.3 m increments from 0.3 to 9.0 m.

② Use the ▲/▼ buttons to move to the next set of speakers

③ Repeat for each speaker.

NOTE : Sound takes about 1 ms (millisecond) to travel 0.3 m.

3 Select EXIT with the ▲/▼ buttons and press ENTER to return to the SYSTEM SETUP MENU.

Next, proceed to CHANNEL LEVEL below.

If you want to change a setting before proceeding

Simply use the arrow buttons to go back.

Channel level

The following steps show you how to balance the sound output level of your speakers. Proper speaker balance is essential for obtaining high quality surround sound. If continuing from CHANNEL DELAY, go to step 1. If starting fresh, complete steps 1-3 in "Setting Up for Surround Sound" (p.27) first.

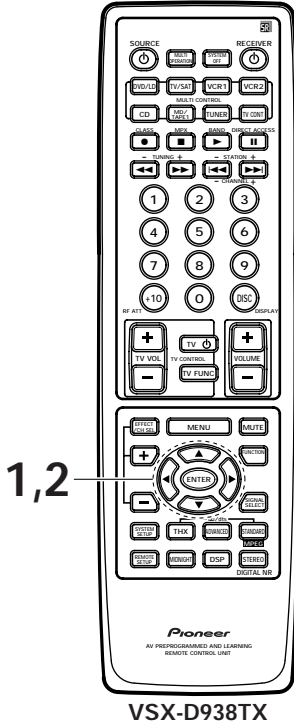

1 Select CHANNEL LEVEL (if continuing from CHANNEL DELAY, it will already be selected).

See "Setting Up for Surround Sound" on page 27 if you are unsure how to do this.

Press ENTER.

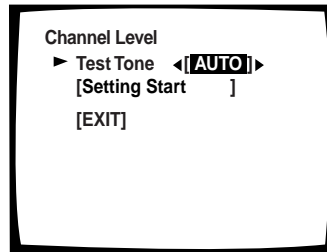

2 Select a TEST TONE mode.

- ① Press ◀ or ▶ to move the cursor to AUTO or MANU.
- ② Press ▼ button to select SETTING START.

AUTO (automatic TEST TONE)

This mode switches the test tone between each speaker automatically. Use this mode when balancing the speaker levels by ear.

The automatic test tone is output in the following order:

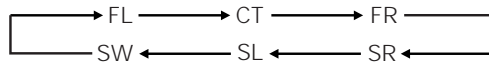

MANUAL (manual TEST TONE)

This mode switches the test tone between each speaker manually. You can use this mode when you want to balance the speaker levels by ear at a more leisurely pace.



If your sub woofer has a volume control, set it to the middle position before proceeding.

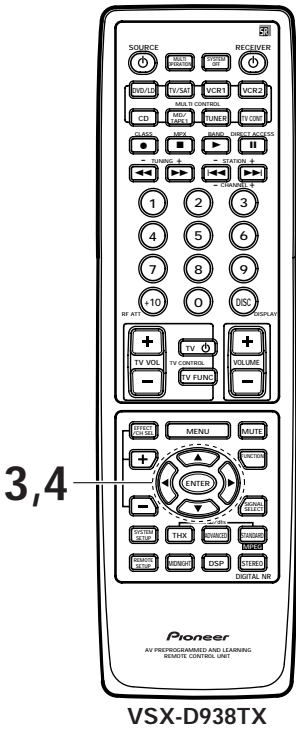

3 After selecting SETTING START with the button press ENTER. The TEST TONE will be output.

These settings will be displayed on your TV.

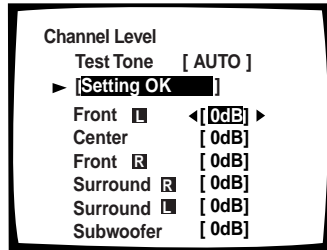

It takes a moment for the machine to set itself. MASTER VOLUME rotates to the reference position (0 dB), and the test tone is output.

To exit before outputting the TEST TONE

Press ENTER.

To exit while outputting the TEST TONE

Press ENTER.

SET
Up



It is possible to set channels levels independently for **DD** Surround/dts, STEREO, EXTERNAL DECODER and each DSP mode for listening once purposes (see p.24 ⑥).

This function is designed to be used when you want to change the levels temporarily to hear one speaker louder. You could return the settings to their original state when done.

4 Adjust speaker levels so that you hear the test tone at the same volume from each speaker when seated in your main listening position.

NOTE : The volume of the sub woofer tends to sound lower than it actually is, you may need to raise its level after testing the sound with actual soundtracks.

In AUTO mode

① Press ◀ or ▶ to adjust the level of the speaker outputting the TEST TONE.

In MANU mode

- ① Press ◀ or ▶ to adjust the level of the first speaker.
- ② Press ▲/▼ to switch the TEST TONE to the next speaker.
- ③ Repeat ① and ② for each speaker.

If you are using a Sound Pressure Level (SPL) meter

Take the readings from your main listening position and adjust the level of each speaker to 75 dB SPL (C-weighted/slow model).

5 When you have adjusted each speaker level, select SETTING OK and press ENTER to return to the previous screen.

The MASTER VOLUME will return to its original position. Next, proceed to CROSSOVER NETWORK below.

If you want to change a setting before proceeding.

Simply use the arrow buttons to go back.

6 Select EXIT with the ▲/▼ buttons and press ENTER to return to the SYSTEM SETUP MENU.

Crossover network

The following steps show you how to adjust the crossover network. The crossover network is the frequency at which the system divides the signal and sends the different parts (high, mid, low) to different speakers. Speaking precisely, this setting sets the cutoff point for the bass frequencies rerouted from your SMALL speakers to your sub woofer or speakers set to LARGE. If continuing from CHANNEL LEVEL go to step 1. If starting fresh, complete steps 1-3 in "Setting Up for Surround Sound" (p.27) first.

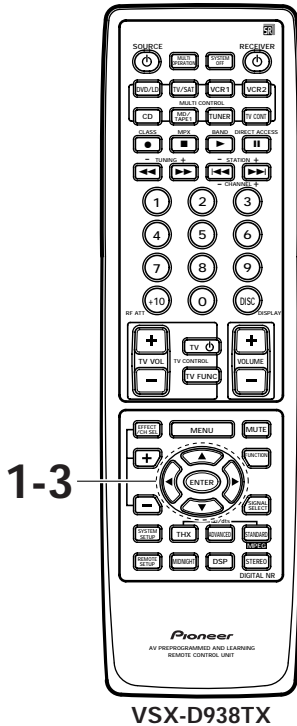

1 Select Crossover NETWORK (if continuing from CHANNEL LEVEL, it will already be selected).

See "Setting Up for Surround Sound" on page 27 if you are unsure how to do this.

Press **ENTER**.

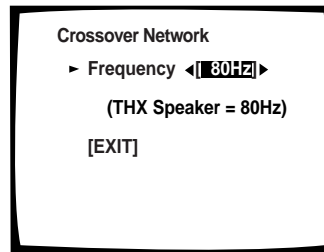

The default setting is 80 Hz.

2 Specify the crossover frequency for your small speakers.

Setting speakers to SMALL in "SPEAKER SETTING" sends the respective channel's bass frequencies to the sub woofer (or LARGE speakers). The present function lets you determine which frequencies will be sent to the sub woofer or LARGE speakers.

① Press ◀ or ▶ to move the cursor to 80 Hz, 100 Hz, or 150 Hz.

② Press ▼.

80 Hz

Sends bass frequencies below 80 Hz to the sub woofer (or LARGE speakers).

100 Hz

Sends bass frequencies below 100 Hz to the sub woofer (or LARGE speakers).

150 Hz

Sends bass frequencies below 150 Hz to the sub woofer (or LARGE speakers).

As noted on your TV screen the THX setting is 80 Hz. Select this setting if you have THX approved SMALL speakers.

Experiment with the different settings to see which sounds best to you.

3 Select EXIT to return to the SYSTEM SETUP MENU.

Next, proceed to BASS PEAK LEVEL MANAGER below.

If you want to change a setting before proceeding

Select a new crossover frequency.

Bass peak level manager

The LFE (Low Frequency Effect) channel in Dolby Digital, DTS and MPEG audio (VSX-D938TX only) program sources can produce heavily concentrated ultra-low bass tones that may exceed the capabilities of your speaker system. The following steps show you how to set the peak level for the ultra-low bass (LFE) channel. If continuing from CROSSOVER NETWORK go to step 1. If starting fresh, complete steps 1-3 in "Setting Up for Surround Sound" (p.27) first.

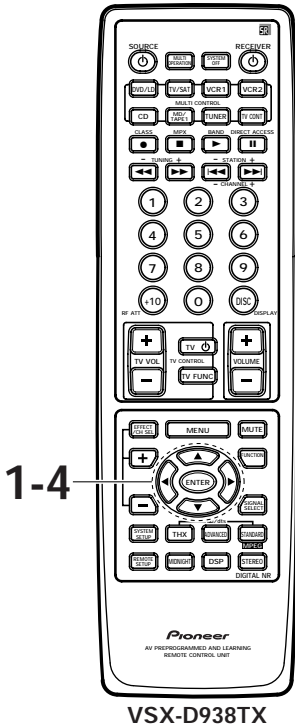

- 1 Select BASS PEAK LEVEL MANAGER (if continuing from CROSSOVER NETWORK it will already be selected).**

See "Setting Up for Surround Sound" on page 27 if you are unsure how to do this.

Press ENTER.

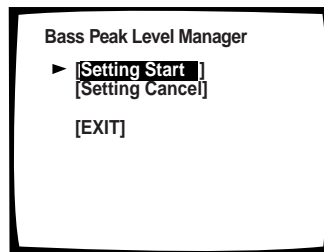

- 2 Select SETTING START and press ENTER.**

MASTER VOLUME rotates to MIN (---dB). Then the test tone is output to the sub woofer or front or surround speakers.

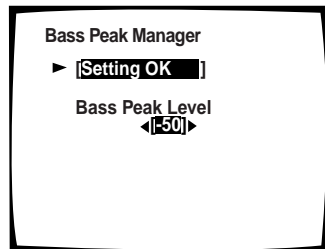

- 3 Press and hold the ▶ until you hear the test tone from the sub woofer and specify the peak LFE level.**

Use the ◀ or ▶ arrows to gradually increase the level of the LFE channel until the test tone begins to distort. Then go back and leave the level setting at a point just before that. Press ENTER and the receiver will remember this bass output level.

To exit before outputting the TEST TONE

Press ENTER.

To exit while outputting the TEST TONE

Press ENTER.

- 4 Press ENTER to return to the previous screen.**

This completes the speaker setup.



If you select SETTING CANCEL and press ENTER, no settings are input to the receiver but the screen remains on the TV. To escape the screen, you must press EXIT.

D-range control

This feature makes it possible to enjoy full surround sound effects on Dolby Digital sources even at low volumes. It does this by compressing the dynamic range. Dynamic range is the difference between the loudest and the softest sounds in any given signal. Compressing the range plays sounds so the quieter ones are audible and the louder ones don't get distorted or become overpowering. This feature only applies to Dolby Digital sources but the MIDNIGHT LISTENING mode accomplishes the same end for a variety of sources (see p.46). If continuing from BASS PEAK LEVEL MANAGER, go to step 1. If starting fresh, complete steps 1-3 in "Setting Up for Surround Sound" (p.27) first.

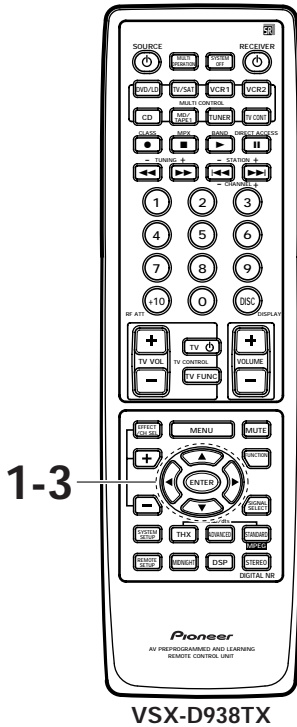

1 Select D-RANGE CONTROL (if continuing from BASS PEAK LEVEL MANAGER, it will already be selected).

See "Setting Up for Surround Sound" on page 27 if you are unsure how to do this.

Press ENTER.

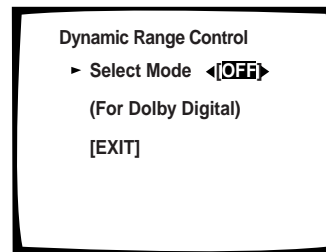

- The default setting is OFF.
- If listening at loud volumes, we recommend turning the Dynamic Range Control OFF.

2 Use the ◀ or ▶ to choose OFF, MID or MAX.

3 Select EXIT and press ENTER to return to the SYSTEM SETUP MENU.

If you want to change a setting before proceeding

Choose a new DYNAMIC RANGE CONTROL setting. You may need to experiment with different Dolby Digital sources before you can use the DYNAMIC RANGE CONTROL setting to suit your low volume listening needs.

Digital-in select

In order to be able to use your digital equipment properly, you need to assign digital inputs for each of the digital components you connected. Match the Digital 1-4 setting with the digital jacks 1-4 in accordance with what component is hooked up to each digital jack. Check the digital terminal numbers on the back of the receiver to make certain what component is in which jack (if necessary, see p.10 for more on digital connections). The last setting, the AC-3 RF button, is specifically for a DVD/LD or LD player with an AC-3 RF output. If you connected one of these components match this button to the component. If continuing from BASS PEAK LEVEL MANAGER, go to step 1. If starting fresh, complete steps 1-3 in "Setting Up for Surround Sound" (p.27) first.

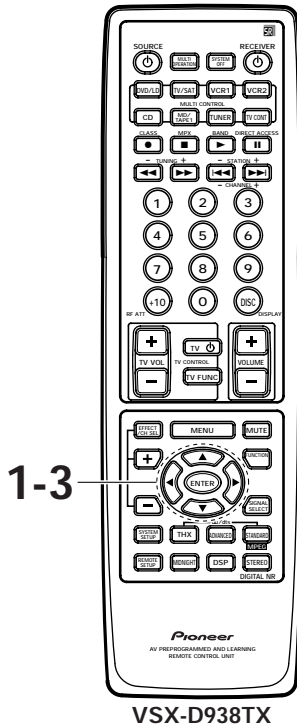

1 Select DIGITAL IN SELELCT (If continuing from last set up, it will already be selected).

See "Setting Up for Surround Sound" on page 27 if you are unsure how to do this.

Press ENTER.

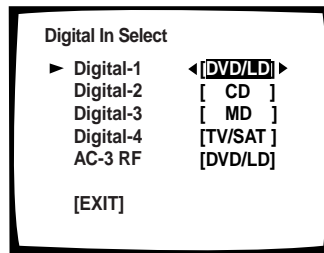

Memo Only the VSX-D938TX has an AC-3 RF terminal. See the note on p.11 for other models' AC-3 RF hook up.

2 Choose a DIGITAL IN and assign it an input function.

Use the ◀ or ▶ to choose the input function that matches the component hooked up to that digital terminal.

The possible choices include: DVD/LD, TV/SAT, CD, MD/TAPE 1, VCR 1, VCR 2. You cannot assign digital inputs to the TUNER, VIDEO, PHONO, and TAPE 2/MONITOR functions.

3 Select EXIT and press ENTER to return to the SYSTEM SETUP MENU.

If you want to change a setting before proceeding

Simply use the arrow buttons to go back.

- Memo**
- For the Digital 1-4 setting, you can choose between DVD/LD, CD, TV/SAT, MD/TAPE 1, VCR 1 and VCR 2 functions.
 - For the AC-3 RF setting, you can choose between DVD/LD, TV/SAT, VCR 1 and VCR 2 functions. Remember, if you have a DVD/LD or LD player you should hook it up to the analog and digital jacks in addition to the AC-3 RF connection described here.
 - Once one function (for example DVD/LD) has been assigned its name disappears from the possibilities on the remaining buttons because one function cannot be assigned twice.

Playing Sources with Stereo Sound

The following instructions show you how to play audio or audio-visual stereo sources with the VSX-D938TX/D908TX/D908TX-G.

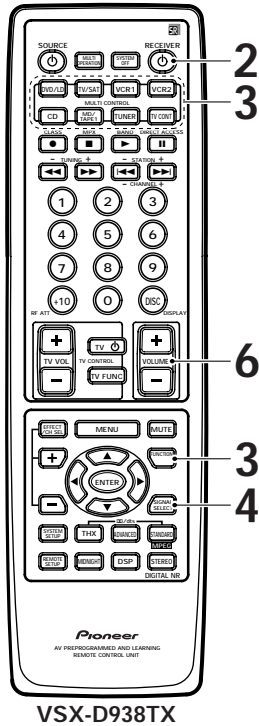

VSX-D938TX

1 Turn on the power of the playback component.

2 Press the RECEIVER button to turn on the receiver.

Be sure that the standby indicator turns off on the front panel.

STANDBY indicator

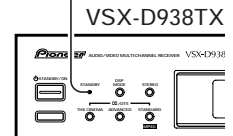

3 Press MULTI CONTROL buttons or the FUNCTION button on the remote control or turn the INPUT SELECTOR dial on the front panel to select the source you want to playback.

The FUNCTION button cycles through the sources in the following order:

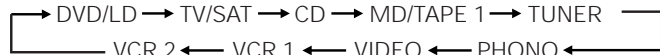

4 Press SIGNAL SELECT on the remote control or on the front panel to select the input signal corresponding to the source component.

(See "Switching ANALOG/DIGITAL signal input" on p. 40.)

5 Start playback of the component you selected in step 1.

6 Adjust the volume by using the MASTER VOLUME buttons on the remote control or the MASTER VOLUME on the front panel.

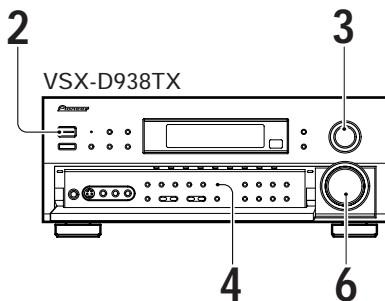

VSX-D938TX



If you are not able to get sound from the receiver, the problem may well lie with the SIGNAL SELECT switch. You need to make sure the input is set to the appropriate ANALOG or DIGITAL setting. Refer to page 44 for more on this.

Sound Modes

The six sound modes on the VSX-D938TX (The five sound modes on the VSX-D908TX/D908TX-G) are explained here. These can be turned on from the front panel or from the remote control.

There are four (VSX-D938TX) or three (VSX-D908TX/D908TX-G) cinema modes: STANDARD, MPEG (VSX-D938TX only), HOME THX CINEMA, and ADVANCED THEATER. These are designed to be used with multi channel surround sound audio/visual sources (like DVDs and LDs). Intrinsic to home theater, these modes can deliver realistic and powerful surround sound that recreates the movie theater experience. You may need to experiment with them to see which settings suit your home system and personal tastes.

The DSP and STEREO modes are designed to be used with music sources but some DSP modes are also suited for film soundtracks. Again, try different settings with various soundtracks to see which you like.

You must choose one of the three cinema modes or the DSP mode in order to get surround sound. In STEREO mode, only the front two speakers are used.

STANDARD mode

This mode is for pure decoding of Dolby Digital, DTS and Dolby Pro Logic. No special effects are added. It is good for enjoying movies that have been recorded in Dolby Digital, DTS or Surround.

HOME THX CINEMA mode

THX is a set of technical standards created by Lucasfilm, Ltd. These standards were designed to emulate a film sound stage and thus reproduce, with the greatest possible accuracy, the soundtrack intended by the filmmakers.

For more detailed information, see P.78.

MPEG mode (VSX-D938TX only)

Use this mode to enjoy playback of software recorded in MPEG audio.

ADVANCED THEATER modes

The Advanced Theater mode is a newly designed system for enhancing movie soundtracks and other audio-visual sources. It incorporates the use of DTS (Digital Theater System) as well as Dolby Digital into its sound processing. These functions switch on automatically when the source you are playing is encoded with DTS, Dolby Pro Logic or Dolby Digital (bearing the  logo). There are four Advanced Theater settings that use DSP (Digital Signal Processing) to create different types of sound environments.

MUSICAL

This mode is primarily for music and adds a spacious feeling to the sound. A long delay time of reflected sounds, provides resonant tones which emulate a concert hall.

DRAMA (CINEMA)

This mode is designed for movies with a lot of dialog. The elements of dialog are enhanced, making the characters seem more real. The mode also compresses the dynamic range somewhat so loud sounds do not overpower softer ones (compare this with the MIDNIGHT LISTENING mode explained on p.46).

ACTION

This mode is designed for action movies, which generally use lots of sound effects. The mode enriches the sound to make it more realistic and extends the parameters to pick up high and low sound effects.

5-D THEATER

This mode is especially designed to give sound depth to stereo sources. The overall effect builds a dynamic and broad sound space, allowing two-channel (stereo) signals to faithfully imitate a five speaker sound. The mode should be used in conjunction with Dolby Pro Logic for sources bearing the  mark.



When a Dolby Digital soundtrack is played back, the Dialog Normalization function of the receiver activates automatically. Dialog Normalization is a Dolby Digital function that establishes the average dialog level for the program source being played. If the receiver's level does not match the average dialog level, first you see "DIAL. NORM" flash in the receiver's display and next OFFSET + 4 dB (as an example) will appear. The number +4 dB is the difference between the receiver's gain structure and the Dolby Digital average dialog level. To match the average dialog level, subtract or add the OFFSET level. For example, if the OFFSET level is +4 dB, the amplifier's output is 4 dB over the average recorded level.

DSP modes

The DSP (Digital Signal Processing) modes allow you to transform your living room into a variety of different sonic environments when playing either two-channel or multi-channel sources.

HALL 1

Simulates the acoustic effects of a large concert hall. Suitable for classical music. A long delay time of reflected sounds, coupled with reverb effects, let the listener enjoy the dynamic and rich sounds characteristic of concert halls and powerful orchestral performances.

HALL 2

Simulates the acoustic environment of a very resonant concert hall. Rich reverberation and a full sound create the impression of a lively performance space.

JAZZ

Simulates the acoustic effects of a jazz club. Reflected sound is virtually below 100 msec so that the listener can enjoy a live band effect.

DANCE

Simulates the acoustic effects of a dance club. Features a strong bass sound. Reflected sound delay time is virtually below 50 msec, for the listener to enjoy the visceral power of dance music.

THEATER 1

Reproduces theater sound field effects without losing the localization of each channel. Theater effects can be enjoyed without losing Dolby Digital/ Pro Logic effects when used in combination those formats (with movies bearing the  trademark).

THEATER 2

Simulates the acoustic environment of a theater while maintaining proper localization of each channel.

Stereo mode

Use the STEREO mode to enjoy standard (two-channel) stereo sound from the front left and right speakers.

This mode also allows you to :

- Use the BASS and TREBLE tone controls
- Use DIRECT for truer reproduction of the original recording.
- Use DIGITAL NR.

See display explanations on p.18-19 and front panel explanations on p.20-23 for details on SPEAKERS (A/B), BASS (-/+) and TREBLE (-/+). See P.45 for DIGITAL NR explanation.



When listening to Dolby Digital or DTS sources, DIGITAL NR do not function even if you select STEREO.

Selecting a Sound Mode

To ensure the best possible surround sound, be sure to complete the set up procedures described in "Setting Up for Surround Sound" (starting on page 27) before using the sound modes. This is particularly important when using the **DD** (Dolby) Digital or DTS sources. When using the sound modes, using SPEAKERS A will give the best results. If you use SPEAKERS B, the sound will be down mixed to the two front B speakers and the surround sound effect will be lost.

Surround operation

1 Select the sound mode.

- For HOME THX CINEMA → Press THX
 - For ADVANCED THEATER → Press ADVANCED THEATER
- Each press changes the ADVANCED THEATER mode as follows:



- For STANDARD or MPEG (VSX-D938TX only) → Press STANDARD (MPEG (VSX-D938TX only))
- Each press changes the STANDARD and MPEG (VSX-D938TX only) modes as follows:

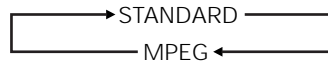

- For DSP modes → Press DSP repeatedly
- Each press changes the DSP mode as follows:

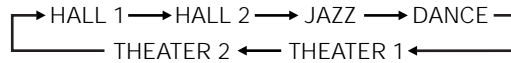

- For STEREO → Press STEREO

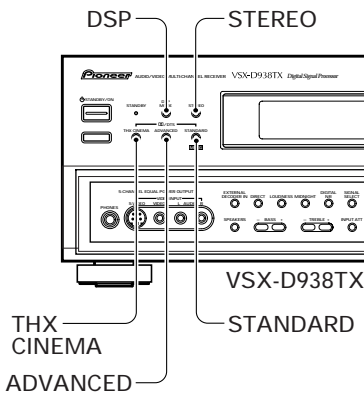
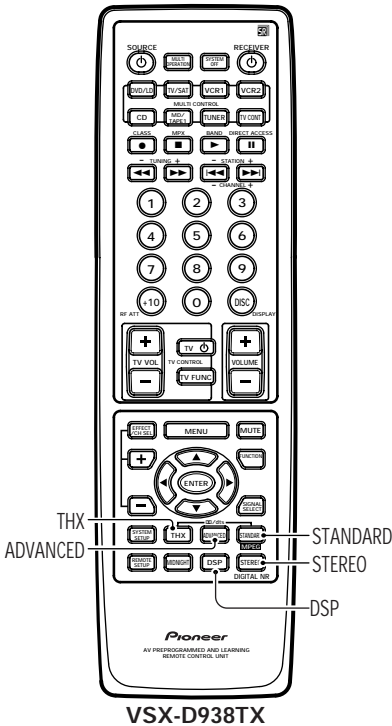

- The effects of ADVANCED THEATER mode can be adjusted in the range of 10 to 90 by pressing EFFECT -/+ . (The default setting is 70). Also, the effect level can be set in each ADVANCED THEATER mode by pressing the EFFECT -/+ button. 5-D THEATER modes cannot be changed.
- The amount of effect of each DSP mode can be adjusted in the range of 10 to 90 (the default setting value is 70) by pressing EFFECT -/+ .
- When a digital input is selected, using some discs with a huge amount of information may cause the overload indicator to light up. If the overload indicator is lit in the THX, ADVANCED THEATER and DSP modes, the signal may be distorting. To ensure there is no distortion you can switch to the STANDARD mode.

Playing Sources with Dolby Digital or DTS Sound

The following instructions show you how to play Dolby Digital, DTS sound MPEG Audio (VSX-D938TX only) sources with the VSX-D938TX/D908TX/D908TX-G.

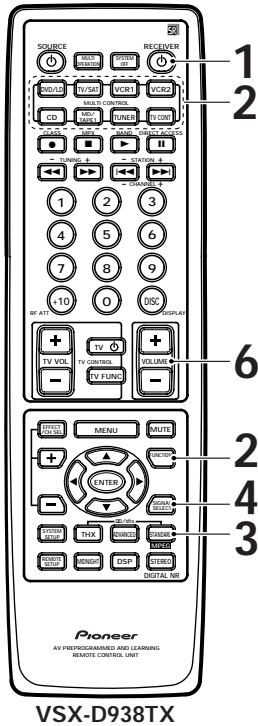

1 Turn on the receiver.

2 Use the **MULTI CONTROL** buttons or the **FUNCTION** button on the remote control, or the **INPUT SELECTOR** dial on the front panel to select the component (DVD/LD etc.) you want to listen to/watch.

You can only use this remote to control the component if it's made by POINEER. For all other makers you need to setup the remote specifically to control your component (See p. 54).

3 Choose a  surround/dts mode by pressing **ADVANCED THEATER** or **STANDARD**.

(For more details, see "Sound Modes" p. 39-40.)

4 Press **SIGNAL SELECT** on the remote control or **SIGNAL SELECT** on the front panel to select the input signal corresponding to the source component (VSX-D938TX can be set to **AUTO**, while the VSX-D908TX/D908TX-G should be set to **DIGITAL**).

(See "Switching ANALOG/DIGITAL signal input" on p. 44.)

5 Play a source (for example, a DVD player).

6 Adjust the volume by using the **MASTER VOLUME** buttons on the remote control or the **MASTER VOLUME** on the front panel.

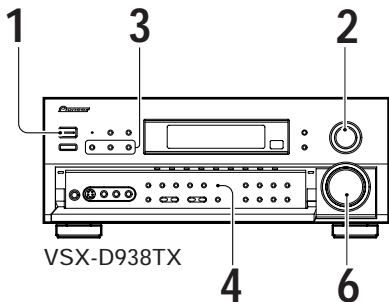

We recommend using different modes for different types of DTS material. For watching movies, the THX or ADVANCED THEATER setting should provide the best results. For listening to music, the STANDARD, DIRECT, STEREO, or DSP modes should serve the listener best.



VSX-908TX and VSX-D908TX-G models:

When playing LD recorded in Dolby Digital

When connecting a DVD/LD or LD player using the AC-3 RF output, a commercially available RF demodulator (RFD-1) is required. The RF demodulator changes the RF signal to a digital signal which is then processed by the receiver at the digital input jacks. For more details, refer to the instruction manual supplied with the RFD-1 (see p.11).

Refer to pages 76-78 for explanations of Dolby Digital, Dolby Pro Logic, DTS, and MPEG (VSX-D938TX only).

VSX-D938TX model:

Make sure you connect your DVD/LD or LD players using the AC-3 RF jack. If your player has an AC-3 RF output, this will ensure you can use all LD players. Refer to page 10, 11 and 37.

Using MPEG audio discs (VSX-D938TX only)

The VSX-D938TX can decode a variety of different types of audio formats for DVDs and these include MPEG. MPEG is a highly sophisticated audio encoding system which some discs use. If the disc you are using has MPEG audio (it will be marked on the disc) switch the receiver to MPEG using the procedure below. If you try to play an MPEG audio disc in any mode other than MPEG no sound will be heard.

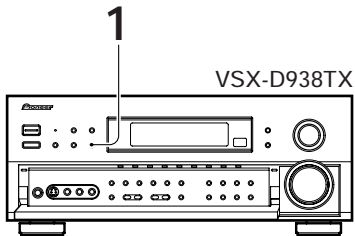

1 If the receiver is not in STANDARD mode, put it in that mode by pressing the STANDARD (MPEG) button.

2 Press the STANDARD (MPEG) button to switch into MPEG mode. Each press switches between regular STANDARD mode and MPEG mode.

"MPEG" will light up in the main display to confirm you are in MPEG mode. After that a small "MPEG" will appear in the bottom left of the display window where "AC-3" or "DTS" would appear if you were in one of those modes. If this "MPEG" display is flashing it means the MPEG signal is not being received.

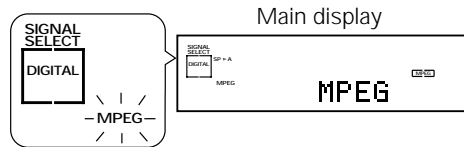

- If the disc you are using is not an MPEG disc or there is some other problem, the small "MPEG" display will flash. This will also happen when the disc is paused.
- You can't use any other sound mode (ADVANCED, STANDARD, etc.), when using the MPEG mode.
- If you use a disc that is not MPEG when the receiver is in MPEG mode, no sound will be heard.

Switching ANALOG/DIGITAL signal input

This switch moves the input fed to the receiver between analog, digital and AC-3 RF sources. You need to take special care to switch to the appropriate input, when necessary. For example, the switch would have to be on digital to use DOLBY DIGITAL, DTS surround sound and MPEG audio (VSX-D938TX only) but it would have to be on analog to record from the analog out jacks on the receiver. On the VSX-D938TX, the default setting is AUTO (which chooses digital when all three are available but goes with whatever is available if it is the only choice), on the VSX-D908TX/D908TX-G is ANALOG.

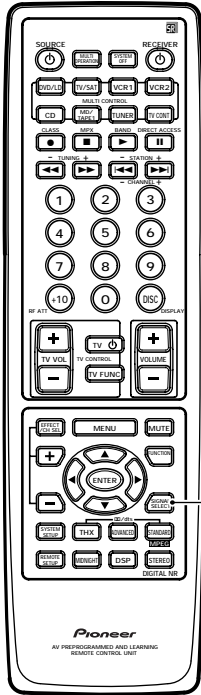

VSX-D938TX

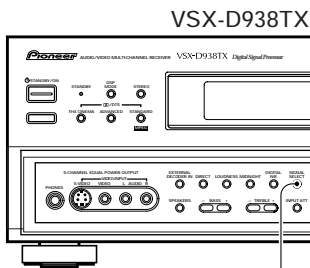

SIGNAL SELECT

1 Press SIGNAL SELECT on the remote control or on the front panel to select the input signal corresponding to the source component.

Each press switches the signal in the order below:
VSX-D938TX model

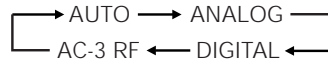

VSX-D908TX/D908TX-G models



2 While SIGNAL SELECT is set to DIGITAL, AC-3 lights when a Dolby Digital signal is input, and DTS lights when a DTS signal is input

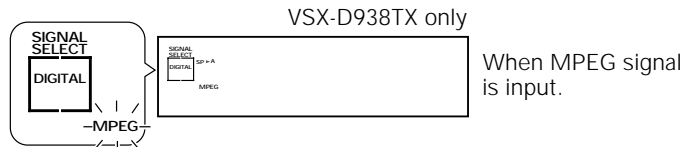
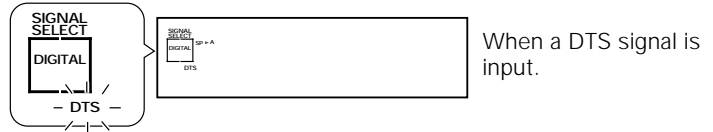
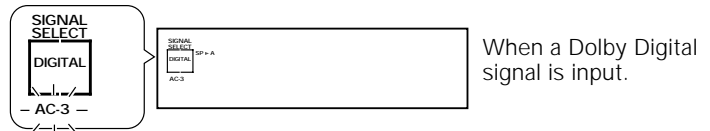

- In the AUTO setting (VSX-D938TX only), SIGNAL SELECT chooses the signal in the following order: AC-3 RF, DIGITAL, ANALOG.
- If the Digital-In Select (see p.37) choices are set to OFF, the SIGNAL SELECT will default to ANALOG.
- Because the audio from a karaoke microphone and LD recorded with analog audio only is not output from the digital output, set SIGNAL SELECT to "ANALOG".
- This receiver can only play back Dolby Digital, PCM (32kHz, 44kHz, 48kHz, and 96kHz), DTS, or MPEG digital signal formats. It cannot play back digital signals other than these so for those formats you will have to play them back in an analog manner (making sure your equipment is hooked up with analog connections and setting the SIGNAL SELECT to "ANALOG."
- When an LD or CD with DTS is played back with the SIGNAL SELECT set in "ANALOG," digital noise caused by playing back the DTS directly (with no decoding) is output. To prevent noise, you need to make digital connections (See p. 10, 11) and set SIGNAL SELECT to "DIGITAL" (VSX-D938TX could also be set to "AUTO").
- Some DVD players do not output DTS signals. For more details, refer to the instruction manual supplied with your DVD player.

Reducing noise during playback (DIGITAL NR function)

To reduce extraneous noise switch on DIGITAL NR. This noise reduction can only be used in the STEREO mode.

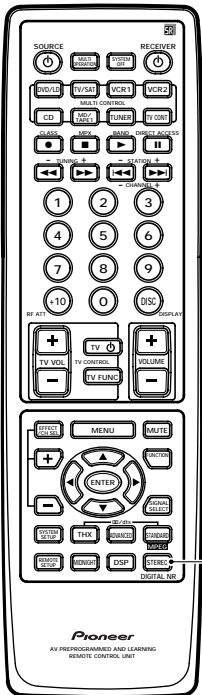

VSX-D938TX

1 Press STEREO on the remote control or on the front panel.

2 Press DIGITAL NR on the remote control or on the front panel.

Each press switches DIGITAL NR on or off.



- When DIGITAL NR is on and Dolby Digital, DTS or MPEG (VSX-D938TX only) signals are input, DIGITAL NR is automatically switched off.
- In cases described below, noises may not be reduced even if DIGITAL NR is on.
 - Sudden noise
 - Extremely loud noise
 - Signals that do not contain many high frequencies
- For each source, DIGITAL NR is effective at and above levels shown below.
 - Cassette tape 20 dB
 - Video tape 15 dB
 - AM tuner 10 to 15 dB
 - FM tuner 15 to 16 dB
- * Depending on the condition of the source, there may not be a noticeable improvement in the quality of the sound.

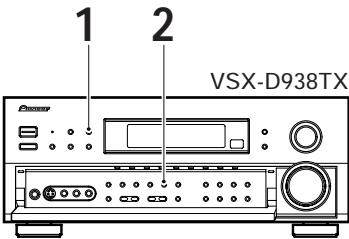

VSX-D938TX

Listening in MIDNIGHT LISTENING mode

This feature makes it possible to get excellent surround sound effects even when listening at low volumes. It can be used with a variety of surround sound sources and plays soundtracks so that the quieter sounds are audible while the noisier sounds do not become overly loud or distorted. It does this by bringing all the sounds in a given soundtrack closer together in volume. Compare this feature with the D-Range Control (only for Dolby Digital sources) on p. 36.

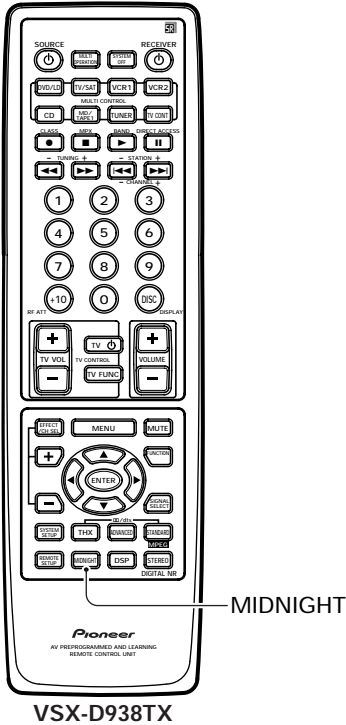

Press MIDNIGHT.

Each press switches MIDNIGHT LISTENING mode on or off.



- The effect adjusts itself automatically in accordance with the volume level.
- You cannot use the MIDNIGHT LISTENING mode with the DIRECT or EXTERNAL DECODER modes.

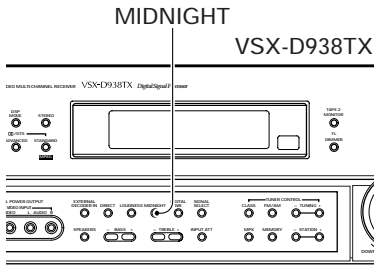

External decoder playback (front panel only)

This feature allows you to connect an external decoder to enjoy certain types of specialized discs.

EXTERNAL DECORDER IN VSX-D938TX

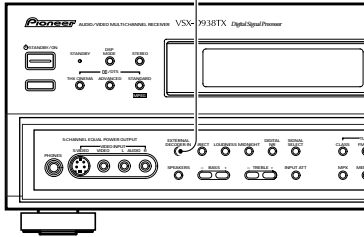

Press EXTERNAL DECORDER IN.

Each press switches the input between the previous mode and EXTERNAL DECORDER.



When EXTERNAL DECORDER is selected only the volume level and channel levels can be set. All of this unit's other features (DSP modes, ADVANCED THEATER modes, DIRECT mode, TONE controls, etc.), as well as the TUNER and PHONO modes, cannot be used. Also, all speaker settings and other setup settings have no effect.

96kHz/24bit performance

This receiver is capable of playing back advanced DVD discs which are recorded in 96 kHz/24 bit format (these are all stereo discs). The receiver will automatically read the format of the disc and play accordingly (of course the SIGNAL SELECT will have to set to AUTO (VSX-D938TX only) or DIGITAL to read the DVD soundtrack). When the receiver plays a 96 kHz/24 bit disc "96kHz" appears in the display. If you try to use one of the functions or modes mentioned below "96kHz" will light on the display, as shown below, indicating the procedure is not possible.



- When a 96 kHz/24 bit disc is played back, the volume may be louder than that of a normal disc.
- Some DVD players cannot play 96 kHz/24 bit discs. Check the manual of your DVD player to make sure.
- During this playback, you cannot use the tone controls, the DIRECT function, the LOUDNESS function, any of the sound modes, or any of the effect modes.
- With 96 kHz/24 bit discs, you are able to use 5.1 ch playback and the TAPE 2 MONITOR.

Listening in LOUDNESS mode (front panel only)

The LOUDNESS mode allows you to boost the bass in a signal. It is useful for listening to music at low volumes.

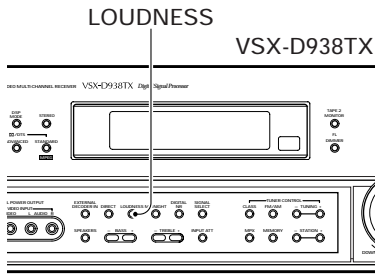

Press LOUDNESS.

Each press switches LOUDNESS mode on or off.



You cannot use the LOUDNESS mode with the DIRECT or EXTERNAL DECODER modes.

Adjusting bass and treble (tone control) (front panel only)

Use BASS (-/+) or TREBLE (-/+) to adjust the low and high frequencies (the receiver must be in STEREO mode).

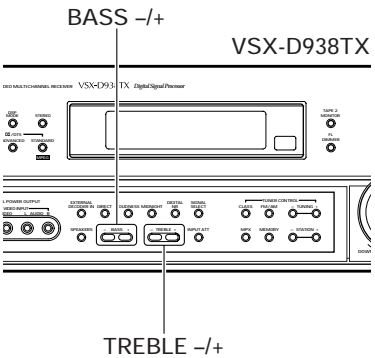

Press BASS (-/+) to adjust the low frequencies.



Press TREBLE (-/+) to adjust the high frequencies.



- The tone control can be adjusted in a range of ± 6 dB.
- The tone control cannot be adjusted in STANDARD, ADVANCED THEATER modes as well as DSP, EXTERNAL DECODER, DIRECT, and 96kHz settings.

Direct playback (front panel only)

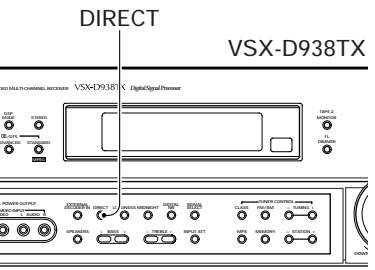

Press DIRECT to put the receiver in DIRECT mode.

This mode will give you the most accurate reproduction of two channels sources.



None of the tone controls, channel level or other sound modes can be used.

Adjusting the brightness of the display (front panel only)

Use the FL DIMMER button to adjust the brightness of the fluorescent display (FL=fluorescent display).

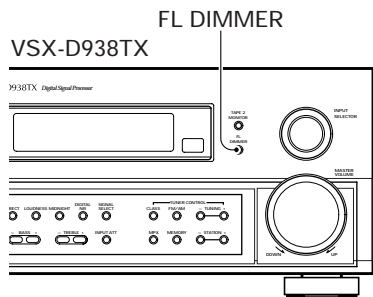

Press FL DIMMER.

Four levels of brightness ranging from very dim to very bright can be selected. Each press changes the brightness of the display. When rotating through the options, the default brightness can also be selected.



Please note: it is a feature of this unit that the fluorescent display will be brighter for a few seconds after you choose a function (like DVD/LD, CD, etc.) and then get softer. This will still happen when you adjust the brightness but the new setting will be the one the display softens to.

Automatic and Manual Tuning

The following steps show you how to tune in FM and AM radio broadcasts using the automatic (search) and manual (step) tuning functions. If you already know the exact frequency of the station you desire, see "Direct Access Tuning" on the following page.

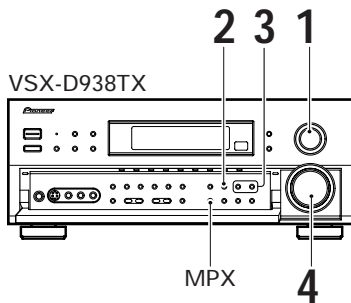
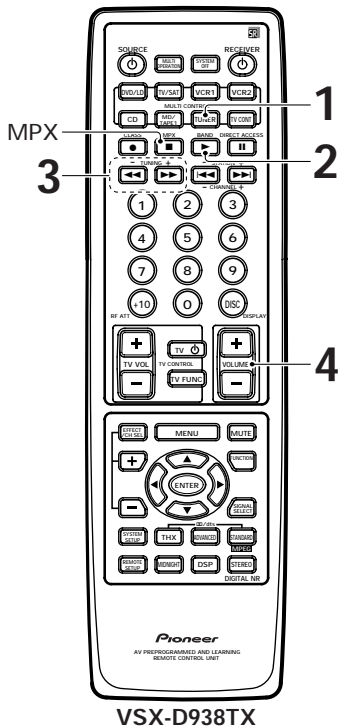

1 Press TUNER on the remote control or turn the INPUT SELECTOR on the front panel.

On the remote, this selects the TUNER function on the receiver and sets the remote to the TUNER operation mode.

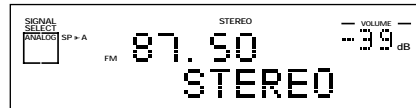

2 Press BAND on the remote control or FM/AM on the front panel to select the band (FM or AM).

Each press switches the band: FM ↔ AM

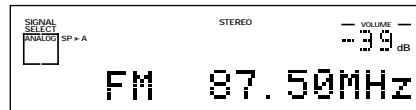

3 Tune in the station.

For Automatic Tuning

Press and hold TUNING +/- for about one second, then release. The tuner starts searching the selected band and stop automatically at the first station it locates. Repeat to locate other stations.

For Manual Tuning

- To change frequencies one step at a time, press TUNING +/- repeatedly.
- To change frequencies quickly, hold down TUNING +/- and release when you reach the frequency you desire.

4 Adjust the volume.

MPX mode

If the TUNED or STEREO indicators do not light when tuning an FM station, because the station is too far away or the broadcast signal is weak, press MPX on the remote control or front panel to switch to MONO reception. This should improve reception enough for you to enjoy the broadcast.

Direct Access Tuning

The following steps show you how to tune directly to a specific frequency using the remote control.

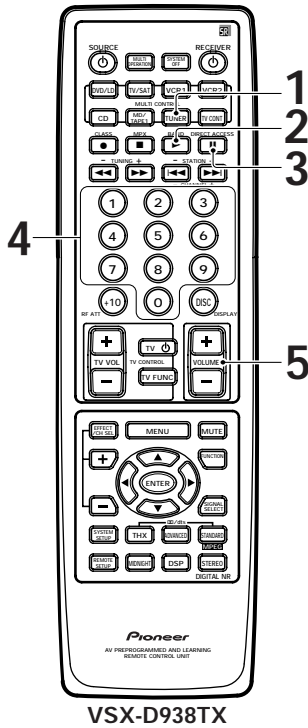

1 Press TUNER.

This selects the TUNER function on the receiver and sets the remote control to the TUNER operation mode.

2 Press BAND on the remote control or FM/AM on the front panel to select the band (FM or AM).

Each press switches the band : FM ↔ AM

3 Press DIRECT ACCESS to activate the Direct Access Tuning mode.

The cursor blinks in the display on the front panel.

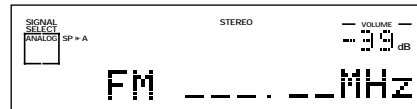

4 Use the number buttons to enter the frequency of the station you desire.

Example:

To tune station 106.00 (FM), press:

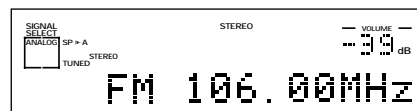
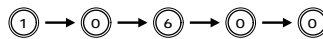

To cancel before inputting the frequency

Press DIRECT ACCESS, and enter the frequency again.

5 Adjust the volume.

Memorizing Frequently Used Stations

The following steps show you how to memorize up to 30 radio stations in 3 classes (each holding 10 channels). When memorizing FM frequencies, the receiver also memorizes the MPX mode (STEREO or MONO).

Using the front panel

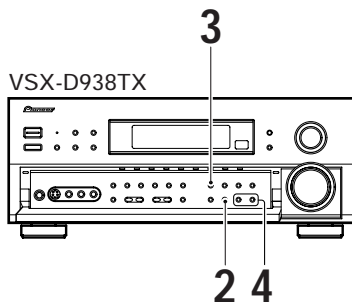

1 Tune in the desired station.

See "Automatic and Manual Tuning" or "Direct Access Tuning" on pages 50 and 51.

2 Press MEMORY to activate the memory function.

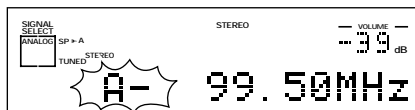

3 Press CLASS repeatedly to select a class number.

Each press switches the display:

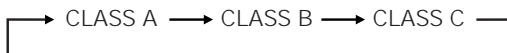

4 Press STATION +/- repeatedly to select a channel (0-9) within the respective class.

The station is memorized automatically after 5 seconds.



Repeat steps 1 through 4 to memorize up to 30 stations.

If you want to escape from MEMORY mode

Press MEMORY again.

Recalling Memorized Stations

Using the remote control

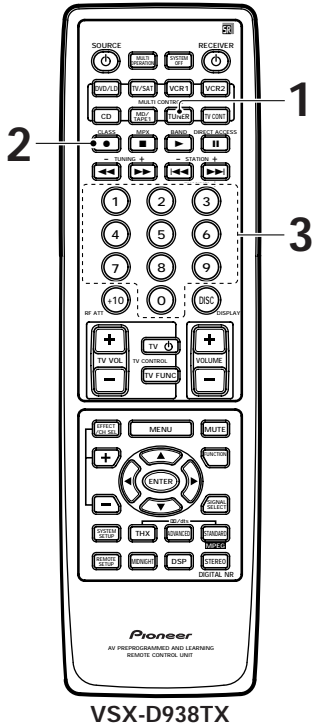

1 Press TUNER.

This selects the TUNER function on the receiver and sets the remote control to the TUNER operation mode.

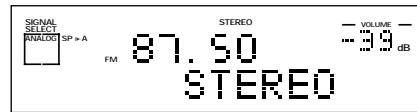

2 Press CLASS repeatedly to select a class number.

Each press switches the display:

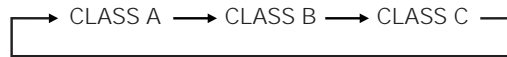

3 Use the number buttons to select the channel you want.

To select channel 7, press **7**.

To select channel 0, press **0**.

For example : If 99.50 MHz (FM) was memorized in class A at channel 7.

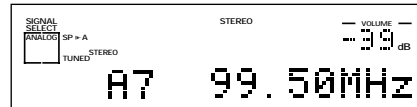

To skip through each channel in order

Press STATION -/+ repeatedly.

Using the front panel

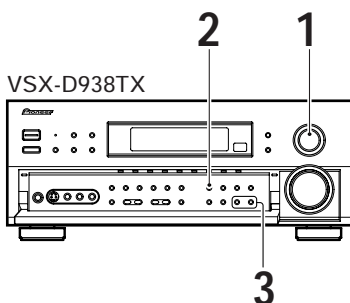

1 Select the TUNER function by using INPUT SELECTOR.

2 Press CLASS repeatedly to select a class number.

3 Press STATION -/+ repeatedly to select the channel you want.

Remote Control of Other Components

Setting Up the Remote Control to Control Other Components

In addition to controlling the receiver, the supplied remote control can operate your other components (VCR, TV, LD, CD, etc.) after you program it to do so. In this way, instead of fumbling with many different controls and buttons, you only need to use one remote control. If your component(s) are listed in the remote control's memory, simply follow the steps below. If your component(s) are not listed, or if you want the remote control to learn additional operations, you can use the learning mode to input the information from the remote controls supplied with your other components.

Recalling preset codes

The following steps show you how to recall preset codes stored in the remote control. Once a preset code is recalled and the component assigned, you can use this remote control to easily operate the component.



See "Preset Code List" on p.79-82 (VSX-D938TX), 83 (VSX-D908TX/D908TX-G) for the components and manufacturers available.

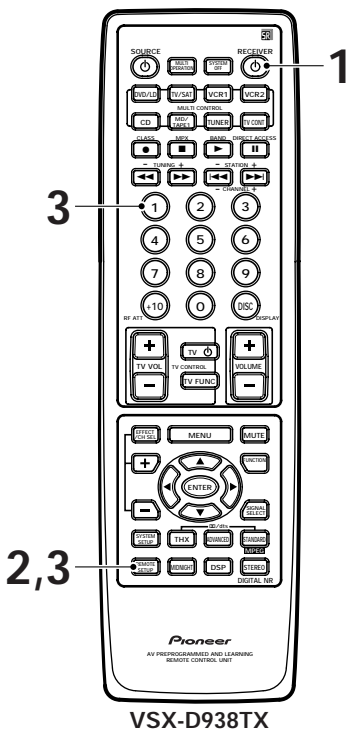

1 Turn on your TV and the receiver.

Make sure your TV is set to the appropriate video input (e.g. VIDEO 1).

2 Press REMOTE SETUP.

The REMOTE SETUP menu appears on your TV screen.

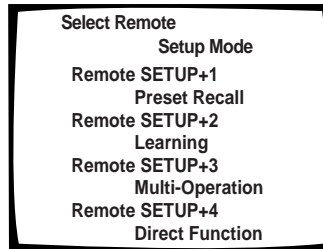

You have four set up options:

- ① PRESET RECALL
- ② LEARNING
- ③ MULTI OPERATION (See p.69)
- ④ DIRECT FUNCTION (See p.72)

PRESET RECALL and LEARNING are the two modes that teach the remote control to operate your other components. It is easiest to start with PRESET RECALL and, if set up is not possible, move on to the LEARNING mode.

3 Press REMOTE SETUP and ① at the same time to select the PRESET RECALL SETUP mode.

All the MULTI CONTROL buttons (except the TUNER button) start to blink.

To cancel the PRESET RECALL SETUP mode
Press REMOTE SETUP.

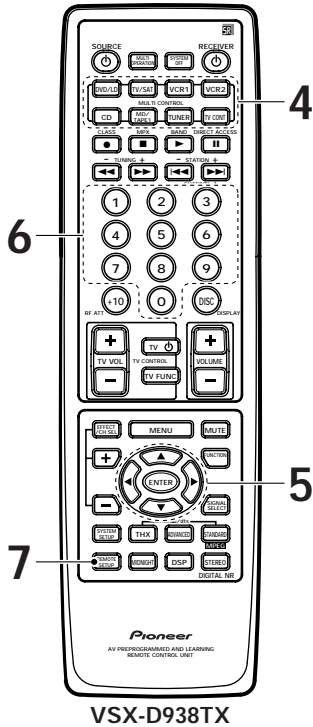

4 Press MULTI CONTROL for the component you want to control.

The selected button lights steadily and the first manufacturer (and preset code(s)) appear on your TV screen.

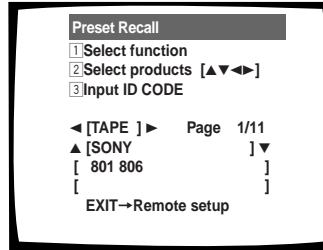

5 Press ▲/▼ repeatedly to display the name of the component's manufacturer.

Most manufacturers have been programmed into the receiver, but if your component is made by a small or relatively unknown manufacturer you may not be able to find it.

6 Point the remote toward the component to be controlled, enter the 3 digit setup code.

When you enter the setup code, the remote emits a power ON/OFF signal. If the component turns ON or OFF, you have entered the proper code.

If the component does not turn ON or OFF and there is more than one setup code, try inputting another code (starting again from step 4). Some manufacturers use several sets of remote control signals and the first code may not correspond to your component.

Repeat steps 4 through 6 to assign preset codes for as many components as necessary.

If you cannot get your component to respond to any of the codes you can still program the component into the remote control using the procedure in the next section.

7 Press REMOTE SETUP to exit the PRESET RECALL SETUP mode.

The remote control and TV return to their previous operation modes.

Learning mode: Programming signals from other remote controls

If preset codes are not available for your component(s), or the available preset codes do not operate correctly, you can use this function to program in signals from the remote control(s) of your other component(s). This operation can also be used after recalling a preset code to program additional operations not covered in the preset codes.

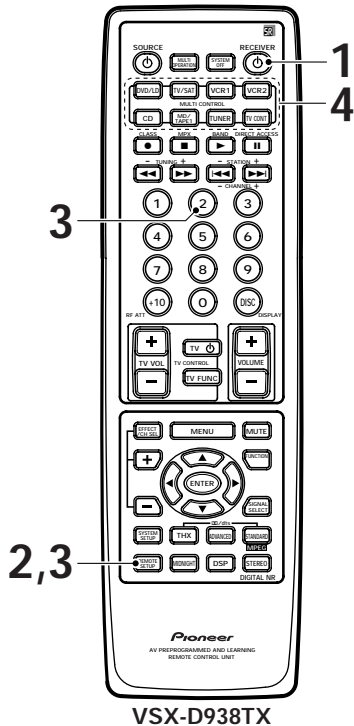

1 Turn on your TV and the receiver.

Make sure your TV is set to the appropriate video input (e.g. VIDEO 1).

2 Press REMOTE SETUP.

The REMOTE SETUP menu appears on your TV screen.

```

Select Remote
  Setup Mode
Remote SETUP+1
  Preset Recall
Remote SETUP+2
  Learning
Remote SETUP+3
  Multi-Operation
Remote SETUP+4
  Direct Function
    
```

3 Press REMOTE SETUP and 2 at the same time to select the LEARNING SETUP mode.

All the MULTI CONTROL buttons (except the TUNER button) start to blink.

To cancel LEARNING SETUP mode

Press REMOTE SETUP.

```

Learning Setup
1 Place both commanders
  pointing at each other.
2 Select the item from
  the Multi-control
  buttons that should be
  duplicated. (ex. DVD)
Multi-control button
  starts blinking.

EXIT→Remote setup
    
```

4 Press MULTI CONTROL for the component you want to control.

Each button can be set to control one of the following components.

The selected button continues to blink.

```

Learning Setup
3 Press one button that
  should be duplicated.
4 Multi-Control button
  lights up.
5 Press one button on the
  original commander, and
  hold 2 to 10 seconds.
6 Repeat this process to
  duplicate next command.
EXIT→Remote setup
    
```

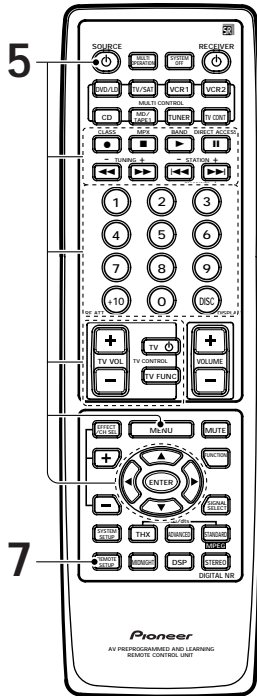
VSX-D938TX

5 Press the button to be programmed.

The MULTI CONTROL button lights steadily.

- The TV POWER, TV FUNC and TV VOL +/- buttons are only available for learning when programming TV CONTROL operations.

6 Point the remote controls at each other and press the button on the other remote control for the operation you wish to program .

- ① Point the remote controls toward each other.

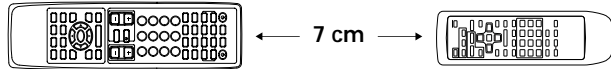

- ② Hold down the button on the other remote control corresponding to the operation you wish to program. Release when the MULTI CONTROL button on the receiver's remote control starts blinking. (The MULTI CONTROL button blinks to indicate that the operation has been learned.)

To program additional operations for the current component
Repeat steps 5 and 6.

To program operations for another component
Repeat steps 4 through 6.

7 Press REMOTE SETUP to exit the LEARNING SETUP mode.

The remote control and TV return to their previous operation modes.

Remote Controlling Other Components

DVD or LD player operations



- The following operations are available from the receiver's remote control after you program your DVD or LD player's preset code, but some operations may need to be learned by the receiver (see "Setting Up the Remote Control Other Components," p.54-57).
- To perform these operations, press the DVD/LD button to set the remote to the DVD or LD operation mode.
- For more information on individual commands, consult the manual that came with the component.

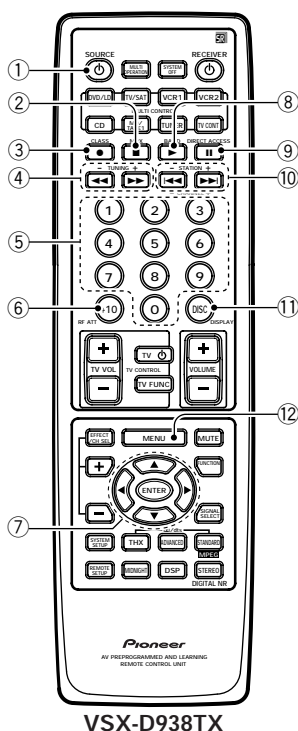

- ① **SOURCE**
Press to switch the DVD or LD player on or off.
- ② **■**
Press to stop playback.
- ③ **● (TOP MENU)**
Use to display or close the top menu screen (for DVD only).
- ④ **◀◀/▶▶**
◀◀ : Hold down for fast reverse playback.
▶▶ : Hold down for fast forward playback.
- ⑤ **Number buttons**
Use to select chapters (tracks).
- ⑥ **+10**
Use when selecting chapter (track) numbers higher than 10.
- ⑦ **▲/▼/◀/▶/ENTER**
▲/▼/◀/▶ : Use to navigate through options on menu screens and to change settings.
ENTER : Use to implement settings selected with the cursor buttons or to set items highlighted in a menu (for DVD only).
- ⑧ **▶**
Press to start playback.
- ⑨ **||**
Press to pause playback.
- ⑩ **◀◀/▶▶**
◀◀ : Press to return to the beginning of the current chapter (track). Press repeatedly to return to the beginning of previous chapters (tracks).
▶▶ : Press to advance to the beginning of the next chapter (track). Press repeatedly to advance to the beginning of following chapters (tracks).
- ⑪ **ENTER (SIDE A/B)**
Use to change the LD between sides A and B (for LD only).
- ⑫ **MENU**
Press to call up the menu screen on the DVD.

VCR and DVD video recorder operations



- The following operations are available from the receiver's remote control after you program your VCR or DVD video recorder's preset code, but some operations may need to be learned by the receiver (see "Setting Up the Remote Control to Control Components," p.54-57).
- To perform these operations, press the VCR 1 or VCR 2 button to set the remote to the VCR, DVD video recorder 2 operation mode.
- For more information on individual commands, consult the manual that came with the component.

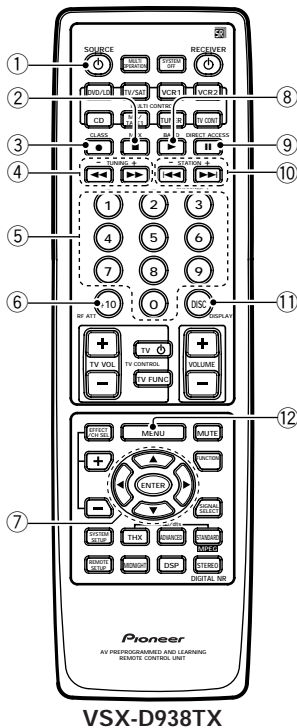

VSX-D938TX

- ① **SOURCE**
Press to switch the VCR or DVD video recorder on or off.
- ② **■**
Press to stop playback.
- ③ **●**
Press to start recording.
- ④ **◀◀/▶▶**
◀◀ : Hold down for fast reverse playback.
▶▶ : Hold down for fast forward playback.
- ⑤ **Number buttons**
Use to select channels.
- ⑥ **+10**
Use when selecting chapter (track) numbers higher than 10 (for DVD video recorder only).
- ⑦ **▲/▼/◀/▶/ENTER**
▲/▼/◀/▶ : Use to navigate through options on menu screens and to change settings.
ENTER: Use to implement settings selected with the cursor buttons or to set items highlighted in a menu (for DVD video recorder only).
- ⑧ **▶**
Press to start playback.
- ⑨ **||**
Press to pause playback.
- ⑩ **CHANNEL -/+**
Use to change channels on the VCR's tuner.
- ⑪ **ENTER(TV/VCR)**
Use this button to switch the VCR between its tuner (for watching videos) and the TV.
Press to stop recording (for DVD video recorder only).
- ⑫ **MENU**
Press to call up the menu screen on the DVD (for DVD video recorder only).

CD player operations



- The following operations are available from the receiver's remote control after you program your CD player's preset code, but some operations may need to be learned by the receiver (see "Setting Up the Remote Control to Control Other Components," p.54-57).
- To perform these operations, press the CD button to set the remote control to the CD operation mode.
- For more information on individual commands, consult the manual that came with the component.

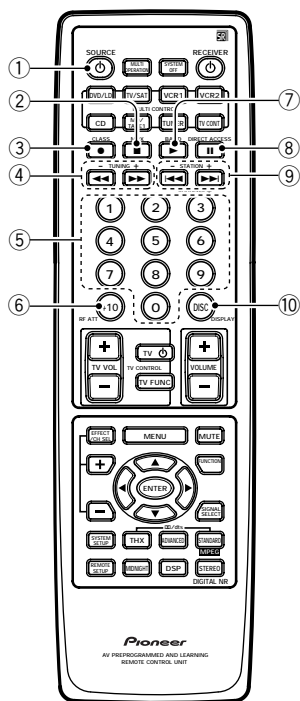

VSX-D938TX

- ① **SOURCE**
Press to switch the CD player on or off.
- ② **■**
Press to stop playback.
- ③ **●**
Press to start recording (for CD-R only).
- ④ **◀◀/▶▶**
◀◀ : Hold down for fast reverse playback.
▶▶ : Hold down for fast forward playback.
- ⑤ **Number buttons**
Use to select tracks.
- ⑥ **+10**
You can also use this button when selecting track numbers higher than 10.
- ⑦ **▶**
Press to start playback.
- ⑧ **||**
Press to pause playback.
- ⑨ **◀◀/▶▶**
◀◀ : Press to return to the beginning of the current track. Press repeatedly to return to the beginning of previous tracks.
▶▶ : Press to advance to the beginning of the next track. Press repeatedly to advance to the beginning of following tracks.
- ⑩ **DISC**
Use to switch between discs with multi disc play.

MD operations



- The following operations are available from the receiver's remote control after you program your MD recorder's preset code, but some operations may need to be learned by the receiver (see "Setting up the Remote Control to Control Other Components," p.54-57).
- To perform these operations, press the MD/TAPE 1 button to set the remote control to the MD operation mode.
- For more information on individual commands, consult the manual that came with the component.

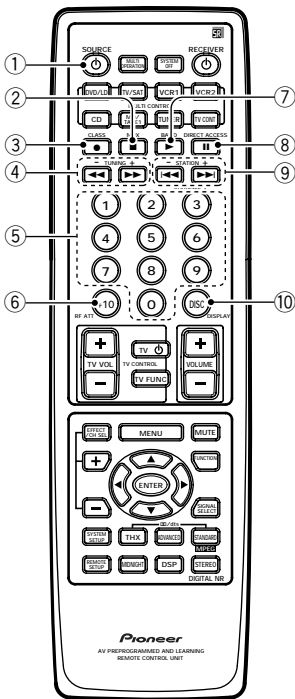

VSX-D938TX

- ① **SOURCE**
Press to switch the MD player on or off.
- ② **■**
Press to stop playback or recording.
- ③ **●**
Press to start recording (may put some decks in REC PAUSE mode).
- ④ **◀◀/▶▶**
◀◀ : Hold down for fast reverse playback.
▶▶ : Hold down for fast forward playback.
- ⑤ **Number buttons**
Use to select tracks.
- ⑥ **+10**
You can also use this button when selecting track numbers higher than 10.
- ⑦ **▶**
Press to start playback.
- ⑧ **||**
Press to pause playback.
- ⑨ **◀◀/▶▶**
◀◀ : Press to return to the beginning of the current track. Press repeatedly to return to the beginning of previous tracks.
▶▶ : Press to advance to the beginning of the next track. Press repeatedly to advance to the beginning of following tracks.
- ⑩ **DISC (DISP/CHARA)**
Allows you to change the display mode of the MD.

STB (Satellite Tuner) operations



- The following operations are available from the receiver's remote control after you program your satellite tuner's (or Cable TV's) preset code, but some operations may need to be learned by the receiver (see "Setting Up the Remote Control to Control Other Components," p.54-57).
- To perform these operations, press the TV/SAT button to set the remote control to the SAT operation mode.
- For more information on individual commands, consult the manual that came with the component.

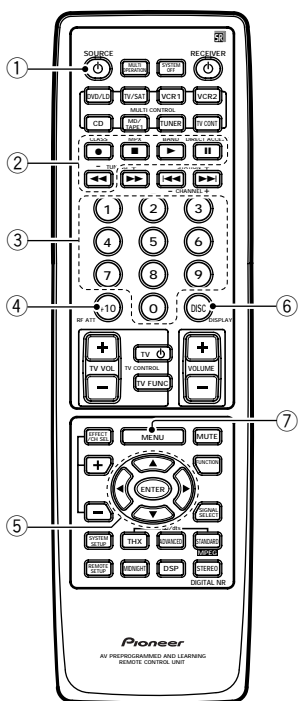

VSX-D938TX

- ① **SOURCE**
Press to switch the satellite tuner on or off.
- ② **●/■/▶/■/◀ (A/B/C/D/E)**
Use to make selections from satellite functions.
- ③ **Number buttons**
Use to select satellite channels.
- ④ **GUIDE**
Use to turn the program information screen on or off.
- ⑤ **▲/▼/◀/▶/ENTER**
▲/▼/◀/▶ : Press the button to select items on the SAT GUIDE screen or SAT MENU screen.
ENTER: Press to activate the selected function.
- ⑥ **EXIT**
Press to exit the current setting of the SAT.
- ⑦ **MENU**
Use to turn the main menu on or off.

STB (DTV) operations



- The following operations are available from the receiver's remote control after you program your digital tuner's preset code, but some operations may need to be learned by the receiver (see "Setting Up the Remote Control to Control Other Components," p.54-57).
- To perform these operations, press the TV/SAT button to set the remote control to the SAT operation mode.
- For more information on individual commands consult the manual that came with the component.

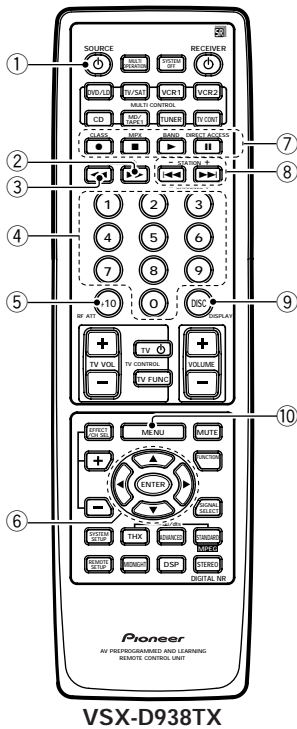

Pioneer
VSX-D938TX
ALL PREPROGRAMMED AND LEARNING
REMOTE CONTROL UNIT

- ① **SOURCE**
Press to switch the satellite tuner on or off.
- ② **DTV MENU**
Press to select the DTV menu.
- ③ **DTV ON/OFF**
Press to switch the DTV mode on or off.
- ④ **Number buttons**
Use to select satellite channels.
- ⑤ **+10**
Use to select a specific TV channel.
- ⑥ **▲/▼/◀/▶/ENTER**
▲/▼/◀/▶ : Press to select or adjust items on the menu screen.
ENTER : Press to activate the selected function.
- ⑦ **●/■/▶/|| (BLUE/GREEN/RED/YELLOW)**
Use to make selections from the DTV menu.
- ⑧ **CHANNEL +/-**
Use to select a TV channel.
- ⑨ **ENTER**
Use to select the channel specified with the number buttons (not all models require this step).
- ⑩ **MENU**
Use to select different menus on a DTV screen.

TV operations



- The following operations are available from the receiver's remote control after you program your TV's preset code, but some operations may need to be learned by the receiver (see "Setting Up the Remote Control to Control Other Components," p.54-57).
- To perform these operations, press the TV/SAT and TV CONT button to set the remote control to the TV operation mode.
- For more information on individual commands consult the manual that came with the your TV.

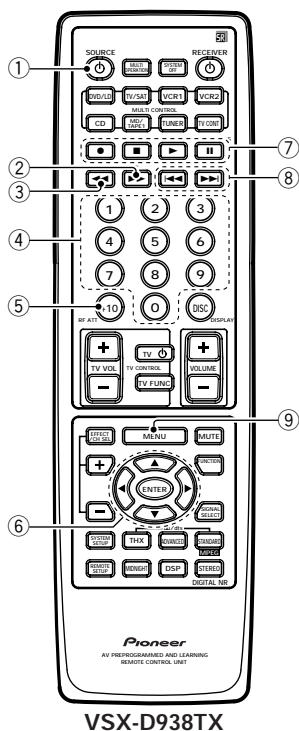

- ① **SOURCE**
Press to switch the TV on or off.
- ② **DTV MENU**
Press to select the DTV menu.
- ③ **DTV ON/OFF**
Press to switch the DTV mode on or off.
- ④ **Number buttons**
Use to select a specific TV channel.
- ⑤ **+10**
Use to select a specific TV channel.
- ⑥ **▲/▼/◀/▶/ENTER**
▲/▼/◀/▶ : Press to select or adjust items on the menu screen.
ENTER : Press to activate the selected function.
- ⑦ **●/■/▶/■/◀◀ (BLUE/GREEN/RED/YELLOW)**
Use to make selections from the DTV menu.
- ⑧ **CHANNEL -/+**
Use to select a TV channel.
- ⑨ **MENU**
Use to select different menus on a DTV screen.

Cassette deck operations

You can use this remote control to control most cassette decks, though with some models the functions may differ.



- The following operations are available from the receiver's remote control after you recall a cassette deck's preset code, but some operations may need to be learned by the receiver (see "Setting Up the Remote Control to Controls Other Components," p.54-57).
- To perform these operations, press the MD/TAPE 1 button to set the remote control to the TAPE operation mode.
- For more information on individual commands consult the manual that came with the component.

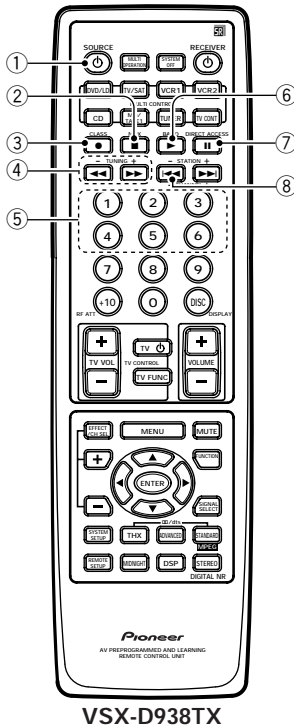

VSX-D938TX

① **SOURCE**

Press to switch the cassette deck on or off (not possible with all models).

② **■**

Press to stop playback or recording.

③ **●**

Press to start recording.

④ **◀▶**

◀◀: Press to rewind the tape.

▶▶: Press to fast forward the tape.

⑤ **Number buttons (1-6)**

1: **■** (Press to stop playback or recording.)

2: **▶** (Press to start playback of the side of the cassette which has been loaded as the front.)

3: **||** (Press to pause playback or recording.)

4: **◀◀** (Press to rewind the tape.)

5: **◀** (Press to start reverse playback.)

6: **▶▶** (Press to fast forward the tape.)

⑥ **▶**

Press to start playback of the side of the cassette which has been loaded as the front.

⑦ **||**

Press to pause playback or recording.

⑧ **◀◀**

Press to start reverse playback (for auto reverse decks).

Recording from Audio Components

The following explanations show you how to record an analog audio signal with the component you connected to the MD/TAPE 1 or TAPE 2 MONITOR jacks. Note that you cannot record an component that is only connected digitally. If you want to record from a digital component, it must be connected in an analog manner as well. If you want to record a digital signal, see the next page.



The receiver's volume, channel level, tone (BASS, TREBLE, and LOUDNESS), and surround effects have no effect on the recorded signal and the EXTERNAL DECODER input cannot be recorded.

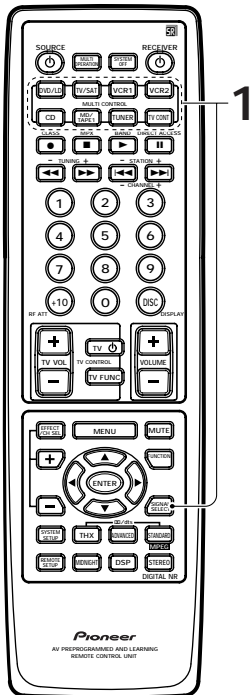

VSX-D938TX

1 Select the source component and put the receiver in that function. Remember, SIGNAL SELECT must be set to analog.

Press the SIGNAL SELECT button on the remote control (or use the button on the front panel) and choose ANALOG. Recording DIGITAL or AC-3 RF (VSX-D938TX only) signals is not possible.

2 Start recording with a TAPE or MD (etc.).

3 Playback the source to be recorded.

Record monitor (TAPE 2 MONITOR)

If you connect a cassette deck (etc.) with a record monitor function to the TAPE 2 MONITOR jacks, you can listen to the sound of the recording as it is recorded.

Press TAPE 2 MONITOR to switch between the sound of the recording (TAPE 2 indicator on) and the sound of the source component (TAPE 2 indicator off).

Recording from Digital Audio Components

The following explanations show you how to record digital audio. Using this method you can make exact digital copies of sources like CDs or MDs. The only drawback is that you cannot switch between various recorders at the touch of a button like you can with analog recordings (see the previous page). If you look on the back of the VSX-D938TX/D908TX/D908TX-G, you will find a digital out jack which is marked PCM/DIG/DTS/MPEG (VSX-D938TX only) OUT (it is to the right of the digital in jacks in the upper left-hand corner). If you connect this to the optical input on a digital recorder (currently these include MD, DAT, CD-R, and DVD video recorder), you can make direct digital recordings with this unit. Of course, the digital components you want to record all need to be connected to the VSX-D938TX/D908TX/D908TX-G with digital inputs as well. See p.10 if you have not made these connections.



The receiver's volume, channel level, tone (BASS, TREBLE, and LOUDNESS), and surround effects have no effect on the recorded signal.

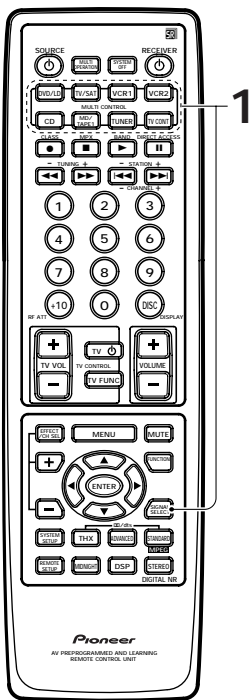

VSX-D938TX

1 Prepare the source you want to record and set the SIGNAL SELECT to digital.

Press the SIGNAL SELECT button on the remote control (or use the button on the front panel) and choose DIGITAL.

2 Start recording with a CD-R or MD (etc.).

3 Playback the source to be recorded.



In some cases, digital recordings have copy guard protections on them and making a digital copy is not possible. It is still possible to copy these digital sources if you have hooked them up with analog connections (in this case, the copies will not be exact digital reproductions). Refer to the previous page in this case.

Recording from Video Components

The following operations show you how to record audio and video to the video tape recorder connected to the VCR 1 or VCR 2 jacks. Note that all signals coming out of these jacks will be analog and it is not possible to record DTS soundtracks.



The receiver's volume, channel level tone (BASS, TREBLE, and LOUDNESS), and surround effects have no effect on the recorded signal.

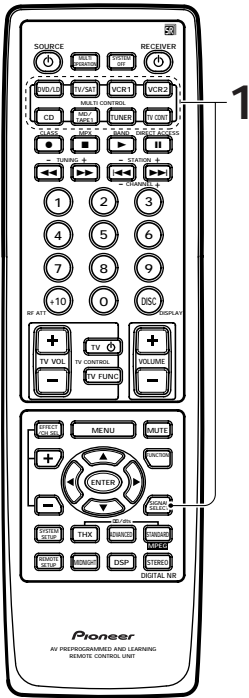

VSX-D938TX

1 First, decide the component you would like to record and put the receiver in that function. Set the SIGNAL SELECT to analog.

Press the SIGNAL SELECT button on the remote control (or use the button on the front panel) and choose analog. Recording DIGITAL or AC-3 RF (VSX-D938TX only) signals is not possible.

2 Start recording with VCR 1 or VCR 2(etc.).

3 Playback the source to recorded.

Multi Operations

Multi operations allow you to tell the receiver and your other components to do a number of things with the push of just two buttons on the remote control. For example, you can program the unit to turn on your TV, turn on your DVD player, go into a specific sound mode and start playing the loaded DVD. This feature allows you to decide which operations you want performed as well as the order in which you want them performed. The steps below show you how to program a string of up to 5 different operations based on eight possible components. You do not need to program the power of this unit, or any PIONEER product, to go on, it/they will do so automatically when the MULTI OPERATION function is used. Also, for some DVD players you will not need to program a play command. Most DVDs will start to play automatically if their power goes on and a DVD is loaded.



Be sure to recall or teach the remote control commands for each component before attempting multi operations (see "Setting Up the Remote Control to Control Other Components," p. 54).

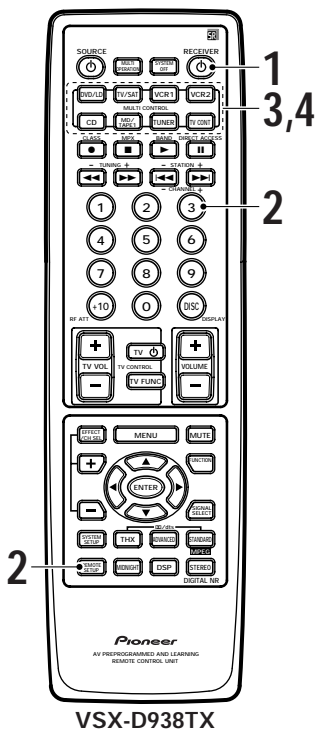

VSX-D938TX

1 Turn on your TV and the receiver.

Make sure your TV is set to the appropriate video input (for example, VIDEO 1).

2 Press REMOTE SETUP and **3** at the same time to select the MULTI OPERATION SETUP mode.

The REMOTE SETUP menu appears on your TV screen. The MULTI CONTROL and the SYSTEM OFF buttons start to blink.

To cancel MULTI OPERATION SETUP mode
Press REMOTE SETUP.

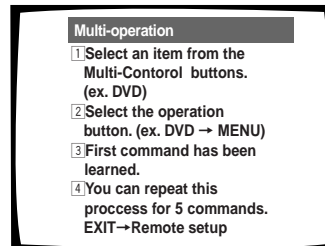

3 Press FUNCTION that you want to use to start the MULTI OPERATION.

You can use any MULTI CONTROL button for this procedure. It does not matter which one you choose but for example purposes we will use the DVD/LD button.

This MULTI CONTROL button will be used when you want to recall the MULTI OPERATION commands for use (see the next page: "Performing multi operations").

Also, the SYSTEM OFF button will blink. See the next page for instructions how to use the SYSTEM OFF button.

4 Press MULTI CONTROL for the component whose operation you want to start MULTI OPERATIONS with (for example, TV CONT button).

The selected button will light steadily.

- Each button can perform various preset multi operations (see step 5 on the next page).

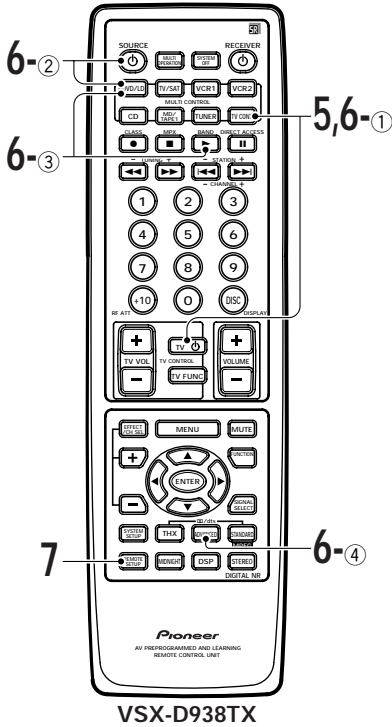

VSX-D938TX

5 Press the operation, for example TV ⏻ (POWER), you want to input.

6 Repeat steps 4 and 5 to input MULTI OPERATIONS for the components and commands you want to input. You can also tell the receiver to go into a specific sound mode (THX, ADVANCED, STANDARD, MIDNIGHT, DSP or STEREO) by inputting that command (for example, see operation ④ below).

You can repeat this process for up to five commands.

For example : you could enter the following four operations using the preceding steps 4 and 5.

- ① Press TV CONT button and TV ⏻ (POWER) to turn on your TV (as explained above).
- ② Press DVD/LD then ⏻ (POWER) to turn on your DVD player (if it is not a PIONEER product).
- ③ Press DVD/LD then ▶ (play) to start playing the DVD player.
- ④ Press ADVANCED THEATER mode to put receiver in that sound mode. When you employ MULTI OPERATIONS (see below), these four tasks will be performed in the same order.

7 Press REMOTE SETUP to exit the MULTI OPERATION SETUP mode.

The remote control and TV return to their previous operation modes.

Performing multi operations

Follow the procedures below to perform multi operations which you programmed in the section before this.

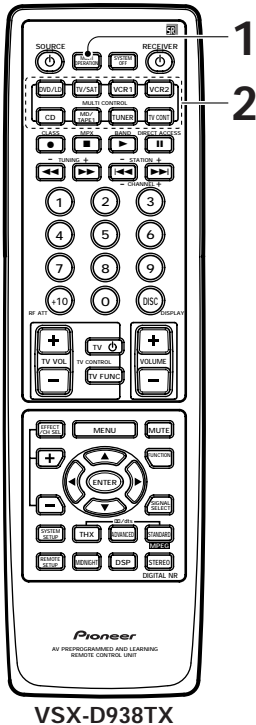

VSX-D938TX

1 Press MULTI OPERATION on the remote control. The MULTI CONTROL buttons start to blink.

2 Press MULTI CONTROL that has been set up with multi operations.

The power of the main unit goes on and the programmed multi operations are performed automatically.

System OFF

The SYSTEM OFF feature allows you to tell the receiver and your other components to stop and turn off with the push of only one button on the remote control. For example, you can program the unit to stop your DVD, turn off your TV, turn off your DVD player and turn off the receiver itself. You do not need to program in other the power for PIONEER components, they will go off automatically in this mode. The receiver itself will go off automatically as well.

The steps below show you how to program a string of up to 5 different SYSTEM OFF operations based on eight possible components.



Be sure to recall or teach the remote control commands for each component before attempting multi operations (see "Setting Up the Remote Control to Control Other Components," p.54).

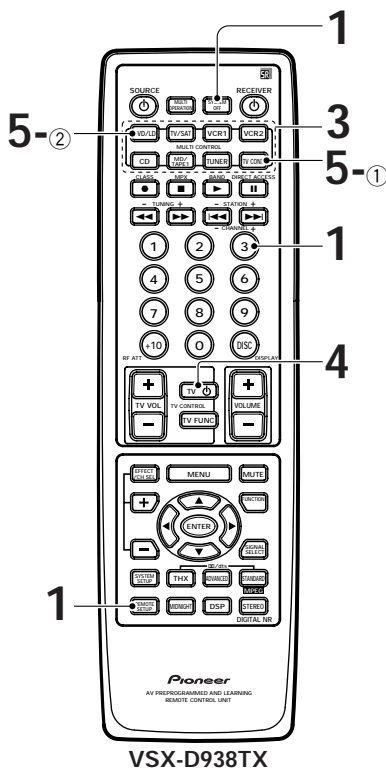

VSX-D938TX

1 Press REMOTE SETUP and at the same time to select the MULTI OPERATION SETUP mode.

The REMOTE SETUP menu appears on your TV screen. The MULTI CONTROL and the SYSTEM OFF buttons start to blink.

To cancel MULTI OPERATION SETUP mode
Press REMOTE SETUP.

2 Press SYSTEM OFF.

The SYSTEM OFF button will blink.

3 Press MULTI CONTROL for the component whose operation you want to start SYSTEM OFF with (for example, TV CONT button).

The selected button will light steadily.

4 Press the operation, for example TV (POWER), you want to Input.

5 Repeat steps 3 and 4 to input SYSTEM OFF for the components and commands you want to input.

You can repeat this process for up to five commands.

For example: You could enter the following two operations using the preceding steps 3 and 4.

① Press TV CONT button and TV (POWER) to turn off your TV (as explained above).

② Press DVD/LD then (POWER) to turn off your DVD player (if it is not a PIONEER product).

When you employ SYSTEM OFF (see below), these two tasks will be performed in the same order.

To exit SYSTEM OFF SETUP mode

Press REMOTE SETUP.

Using the system off button

This button will turn off the receiver and any component that has programmed into the SYSTEM OFF settings (see above) as well as turn off all PIONEER components regardless of whether they have been programmed into SYSTEM OFF. If you use this feature when a DVD is playing, the player will stop the play mode before switching off.

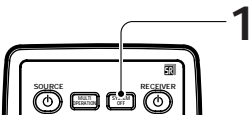

1 Press SYSTEM OFF on the remote control.

Setting Up the Direct Function

The direct function is designed in case you have an external video source connected to your TV (a video source that is not going through the VSX-D938TX/D908TX/D908TX-G). For this explanation we will call this the "external video deck." You would like to control external video deck with this unit's remote control so you have assigned it a function button (for example purposes, the VCR 2 button). Yet, if you put the receiver in VCR 2 mode you will get no picture on your TV because the external video deck signal is not going through the VSX-D938TX/D908TX/D908TX-G. To get around this problem, you set the DIRECT FUNCTION for VCR 2 to OFF. Now when you press VCR 2 function button you can control the external video deck with the remote control but the receiver does not go into VCR 2 mode.

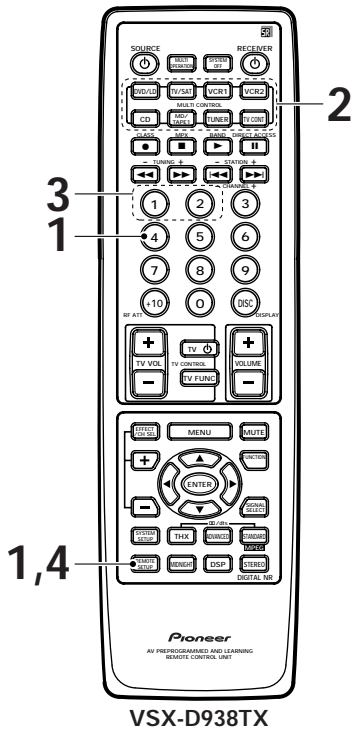

1 Press REMOTE SETUP and ④ at the same time to select the DIRECT FUNCTION mode.

The MULTI CONTROL buttons DVD/LD, TV/SAT, VCR 1, VCR 2, CD, and MD/TAPE 1 start to blink.

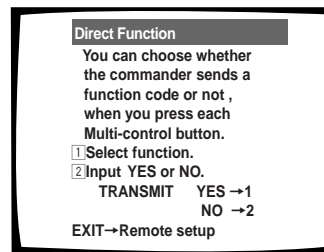

2 Select a component by pressing its MULTI CONTROL button.

3 Set the DIRECT FUNCTION of each external source to NO by pressing ②.

4 Press REMOTE SETUP to exit the DIRECT FUNCTION mode.



The default setting is all YES. If you have turned a DIRECT FUNCTION to NO and want to turn it back to YES, follow the directions above and press ① in step 3.

Remote back light

This function is useful for using the unit in a dark room.

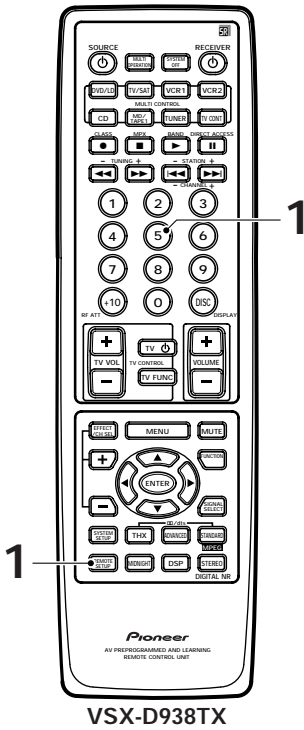

1 Press and hold both REMOTE SETUP and 5.

The remote back light strength cycles in the following order:



The default setting is MAX.

Resetting the Remote Control

The following operations allow you to erase the settings stored in the remote control.

Erasing the multi operations

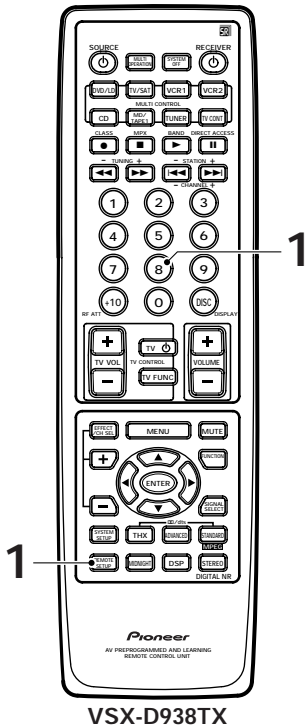

- 1** Press and hold both **REMOTE SETUP** and **8** for more than 3 seconds.

The MULTI CONTROL buttons will blink 3 times and all personal multi operation settings will be erased.

Erasing the learned remote control commands

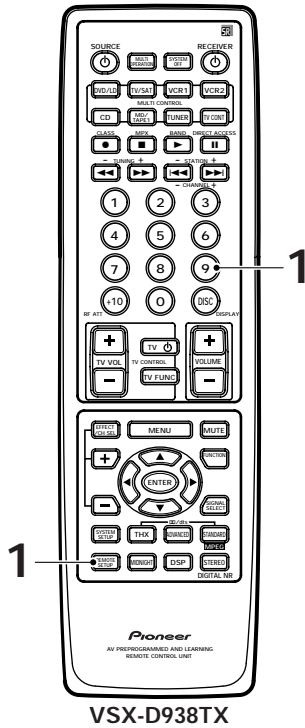

- 1 Press and hold both REMOTE SETUP and 9 for more than 3 seconds.

The MULTI CONTROL buttons will blink 3 times and all signals which have been learned from other remote controls will be erased.

Erasing all signals learned and preset codes

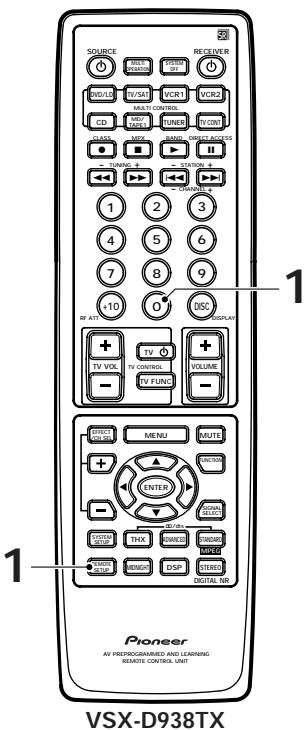

- 1 Press and hold both REMOTE SETUP and 0 for more than 3 seconds.

The MULTI CONTROL buttons will blink 3 times and all preset codes will be erased.

Dolby Digital

Dolby Digital is a compression format which records the sound of 6 channels of the theater surround system (Dolby Digital) on the movie film digital track. Of the 6 channels, the sub woofer channel is intended for bass only, and because the frequency range is smaller than the main channel, it is expressed as 5.1 channel.

Dolby Digital is the name of the Dolby surround multi-channel digital system that was developed after the Dolby Surround System and Dolby Pro Logic Surround System.

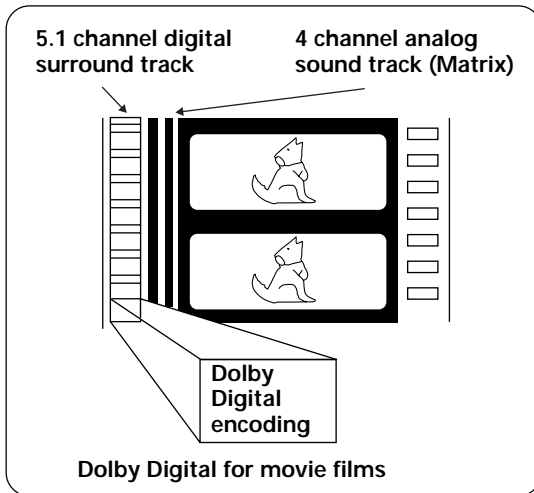

The number of movies made using Dolby Digital since 1992 has exceeded 300 and continues to increase. For compact disc players and laser disc digital sounds, 16 bits are used to sample the original analog audio waveform and sampling is carried out 44,100 times every second. However, because an enormous amount of recording signal data is required for the multi channel system with this method, AC-3 is used to compress the data. In reproducing audio signals, the smaller the bit number used, the lower the sound quality. With AC-3, drop in auditory sound quality is prevented by using masking technology and digital filtering technology based on the human auditory characteristics.

Laser disc format

Laser discs are now available on the market in large numbers. This means that the recording of different format audio signals on the laser disc raises the important question of compatibility with existing laser discs. Dolby Digital tracks on Laser discs record signals using the space of one analog audio channel so it will maintain compatibility with existing discs and players.

As shown in the following figure, the digital audio sounds of Dolby Digital discs can be played back as currently done. Analog sounds are played back by using the other channel without the Dolby Digital signals for monaural audio signals.

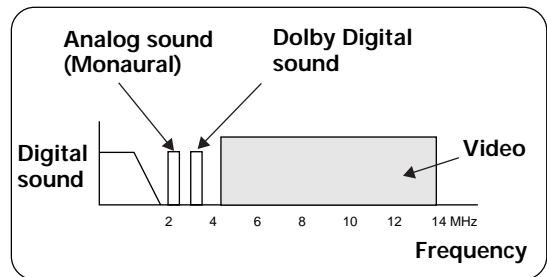

Comparison with Dolby Pro Logic Surround

Dolby Digital is also known as the 5.1 channel system. It is equipped with 5 channels (front left, front right, center, surround left, surround right) in the frequency range from 20 Hz to 20 kHz and an independent Low Frequency Effect (LFE) channel. The sub woofer channel is also called Low Frequency Effect (LFE). The sub woofer channel can be used as desired to enjoy strong bass sounds. The table on the next page shows the comparison with Dolby Pro Logic Surround effects.

DTS

DTS has been adopted as a sound recording format in the latest movie theaters since the release of "JURASSIC PARK" in 1993, and has a good reputation for high quality sound and dynamic surround effects.

In this system, 6 channels of digital sound are recorded on CD-ROM, rather than on the film. DTS adopts a simultaneous playback format. With a low rate of compression of sound signals and a high rate of transmittance, a higher sound quality format is produced. Also, unlike the process of recording digital sounds on film directly, the only components required are a CD-ROM player as might be used with a personal computer and a DTS processor, and therefore less investment is required than with other formats. For this reason, the format is being introduced in more and more movie theaters, and is being adopted in home movie software (DVD, LD) and music software (5.1 channel CD).

More than 11,000 movie theaters around the world have adopted the DTS format, which is now the most popular digital format for movie theaters, especially in U.S.A, Europe, and Asia.

	Dolby Digital	DTS	Dolby Pro Logic Surround
No. of recorded channels	5.1 channels (Max.)	6 channels (Max.)	2 channels
No. of playback channels	5.1 channels (Max.)	6 channels (Max.)	4 channels
Playback channel structure	Front Left, Front Right, Center, Surround Left, Surround Right, Sub Woofer	Front Left, Front Right, Center, Surround Left, Surround Right, Sub Woofer	Front Left, Front Right, Center, Surround
Sound processing	Digital discrete processing	Digital discrete processing	Analog matrix processing
Rear (Surround) high frequency playback limit	20,000 Hz	20,000 Hz	7,000 Hz
Other	<ul style="list-style-type: none"> • 5.1 completely independent channels • High dynamic range • Stable position, high phase characteristics, and advanced surround effects reproduction • High efficiency (Compression rate of about one-tenth) 	<ul style="list-style-type: none"> • 6 completely independent channels • High dynamic range • Stable position, high phase characteristics, and advanced surround effects reproduction • Low compression rate (about one-fourth), high quality sound 	

Warning about DTS test mode

The VSX-D938TX/D908TX/D908TX-G has a mode for PIONEER repairmen to test the DTS sound quality. You will never need to access this mode. Rather you should be careful NOT to put the receiver in this mode because doing so will erase all your setup parameters like speaker settings, delay settings, channel settings, etc.

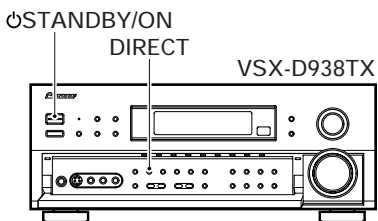

In STANDBY mode, holding the DIRECT button and pressing the STANDBY/ON button will put the receiver in DTS test mode. Be careful NOT to do this.

The above described method is similar to choosing either PAL or NTSC video setting and choosing 8 Ω or 6 Ω setting so be particularly careful when performing these operations not to accidentally put the receiver in DTS test mode.



If you accidentally put the receiver in DTS test mode, repeat the same procedure (as above) to put the receiver back in a usable mode. After this you will need to reset your setup parameters (speaker settings, delay settings, channel settings, etc.).

THX

THX is a Lucasfilm, Ltd. program dedicated to maximum accuracy in movie presentation. Movie sound tracks are recorded in large movie dubbing stages using movie theater equipment. For a sound track to be presented accurately in your home, special technologies are required. In your home the room is much smaller and has a bright sound, the speakers are very different and there are only six of them, plus, you sit much closer to each one of those speakers. Because of these differences we often miss the power and emotion that thrills us in a good movie. Now Pioneer and THX have teamed up to bring the full glory of accurate cinema sound to the comfort and convenience of your home.

Re-Equalization™ : In a theater the room is very large and dead sounding, you sit a long way back from the speakers and the speakers themselves are very specialized. Because a sound track recorded in this dead sounding space when it is played at home it sounds overbright. THX Re-Equalization adjusts for this difference in a very precise way.

Dynamic Decorrelation™ : When a sound track sends mono sound to the surround speakers it often seems to be coming from one side instead of from all around you as it would in a theater. Dynamic Decorrelation helps to correct this inaccuracy.

Timbre Matching™ : When recording a sound track it is very important that the surround sounds move smoothly and seamlessly around the theater. It is very distracting when sounds seem to jump from speaker to speaker.

Timbre Matching helps to smooth the movement of the surround sounds even though you are using only two speakers.

Bass Peak Level Manager™ : Some Dolby Digital and DTS soundtracks can produce bass peaks that are undesirable in a home theater environment. The Bass Peak Level Manager allows you to set the maximum peak levels appropriate to your system. (Set this function according to the **bass peak level** instructions on page 35.)

Loudspeaker Position Time Synchronization™ : This feature allows you to adjust for the difference in the distance from each individual loudspeaker to the listening position. Doing this ensures that all the speakers operate in precise synchronization improving the seamless nature of the soundfield. (Set this function according to the **channel delay** instructions on page 31.)

MPEG Audio (VSX-D938TX only)

MPEG is an audio encoding system which delivers high quality audio for music and movies. By removing frequencies which are out of the human hearing range, the sound is then compressed to enable the transmission of mono, stereo, or multichannel (5.1 and 7.1) audio in a single bitstream which is why it has become a standard audio format for DVD and personal computers. The composition and versatility of MPEG audio also ensures that the presentation of a multichannel soundtrack will sound appropriate on everything from a 7.1 channel surround sound home theater setup to a mono television set. Above all, MPEG audio is designed to be compatible with past and future MPEG audio versions, which means that future versions of MPEG audio will be compatible with decoders currently being produced (the signal is merely reconfigured to fit the number of channels available in a system).

Preset Code List

VSX-D938TX

Device	Manufacturer	Code	Device	Manufacturer	Code
DVD	TOSHIBA	001	VCR	CROWN	418, 423, 425
	SONY	002		DAEWOO	418,423
	PANASONIC	003		DANSAI	425
	JVC	004		DE GRAAF	406
	SAMSUNG	005		DECCA	414, 419
	SHARP	006		DUAL	417
	AKAI	007		DUMONT	410, 414, 419
	RCA	009		ELCATECH	425
PIONEER	000, 008	FIDELITY		419	
LD	DENON	106		FINLANDIA	410, 414
	HITACHI	105		FINLUX	406, 410, 414, 419
	PHILIPS	104		FIRSTLINE	405, 409, 411, 424, 425
	RADIOLA	104		FISHER	410
	SONY	101,103		FRONTECH	423
	TELEFUNKEN	100		FUNAI	419
	PIONEER	100, 102 (DVD code)		GBC	414
SAT	PIONEER	200, 202		GENERAL	423
TUNER	PIONEER	500		GOLDSTAR	411
VCR	PHILIPS	414, 428		GOODMANS	411, 418, 419, 423, 425
	PANASONIC	403, 408		GRAETZ	410, 417
	THOMSON	417, 420, 428		GRANADA	410, 414
	SONY	416, 417		GRANDIENTE	430
	JVC	407, 417, 428		GRANDIN	411, 419, 425
	GRUNDIG	408, 414, 419, 425, 426, 427		HCM	425, 426
	AKAI	401,417		HINARI	412, 413, 425, 426
	HITACHI	406, 417, 419		HYPSON	425
	TOSHIBA	405, 409, 414, 417, 428		IMPERIAL	419
	MITSUBISHI	407, 409, 414		INTERFUNK	414
	SHARP	402		ITT	401, 410, 417, 428
	ORION	412, 413, 424		ITV	411, 418
	SANYO	410		KAISUI	425
	FERGUSON	417, 420, 421		KENDO	401, 424
	BLAUPUNKT	403, 408, 417, 427	KORPEL	425	
	NOKIA	401, 410, 417	LEYCO	425	
	SELECO	417	LOEWE	411, 414	
	AIWA	413,419	LUXOR	401, 409, 410	
	AKIBA	425	M-ELECTRONIC	419	
	ALBA	413, 415, 418, 423, 424	MANESTH	405, 425	
	AMBASSADOR	423	MARANTZ	414	
	AMSTRAD	419	MATSUI	412, 413, 424	
	ANITECH	425	MEMOREX	410, 411, 419	
	ASA	411, 414	MEMPHIS	425	
	BAIRD	410, 417, 419, 421	METZ	403, 427	
	BASIC LINE	418, 423, 425	MINERVA	427	
	BRANDT	420, 422	MULTITECH	419, 425	
	BRANDT	417	MURPHY	419	
	ELECTRONIQUE		NBC	407, 417	
	BUSH	413, 415, 418, 424, 425	NECKERMANN	414	
	CATRON	423	NESCO	425	
	CGB	419	NORDMENDE	417, 428	
	CIMLINE	425	OCEANIC	417, 419	
	CLATRONIC	423	OSAKI	411, 419, 425	
	CONDOR	423	OTTO VERSAND	414	
			PALLADIUM	411, 417, 425	
			PATHE MARCONI	417	
			PENTAX	406	

VSX-D938TX

Device	Manufacturer	Code	Device	Manufacturer	Code	
VCR	PERDIO	419	TAPE	YAMAHA	811, 816	
	PHONOLA	414		PIONEER	800, 819	
	PORTLAND	423	CD	AKAI	308	
	PROLINE	419, 426		ARCAM	312	
	PYE	414		ASUKA	313	
	QUELLE	414		AUDIO TON	312	
	RADIOLA	414		BUSH	305	
	REX	417, 428		CALIFORNIA	304	
	ROADSTAR	411, 418, 425		AUDIO LAB		
	SABA	417, 420, 428		CYRUS	312	
	SAISHO	412, 424		DENON	309	
	SALORA	401, 409		DUAL	313, 319	
	SANSUI	407, 417		FISHER	317	
	SBR	414		GOLDSTAR	302	
	SCHAUB LORENZ	417, 419		GRUNDIG	312	
	SCHNEIDER	414, 419, 425		HITACHI	307	
	SEI	414		INTER SOUND	313	
	SENTRA	423		JVC	303	
	SHINTOM	425		KENWOOD	310, 311	
	SIEMENS	410, 411, 427		KODAK	322	
	SINGER	405		LINN	312	
	SINUDYNE	414		LUXMAN	318	
	SOLAVOX	423		M ELECTRONIC	323	
	SUNSTAR	419		MARANTZ	304, 312	
	SUNTRONIC	419		MATSUI	312	
	TASHIKO	419		MCS	304	
	TATUNG	414, 417, 419		MEMOREX	300	
	TEC	423		MERIDIAN	312	
	TELEAVIA	417		MITSUBISHI	308	
	TELEFUNKEN	417, 420, 422, 428		NAD	316	
	TENOSAL	425		NAIM	312	
	TENSAI	419		ONKYO	320	
	THORN	410, 417		PANASONIC	304	
	UNIVERSUM	401, 411, 414, 419, 427		PHILIPS	312, 322	
	YAMISHI	425		QUAD	312	
	YOKAN	425		QUASER	304	
	YOKO	423		ROADSTAR	323	
	PIONEER	400, 404, 407, 431, (DVD Video Recorder), 414		ROTEL	312	
	TAPE	AKAI		823	SABA	319
		ARCAM		810	SANYO	317
		DENON		810, 821	SHARP	321
FISHER		813		SONY	301, 316	
GRUNDIG		815		TECHNICS	304, 306	
JVC		802	TELEFUNKEN	319		
KENWOOD		804, 807, 816	THOMSON	319		
LUXMAN		805	UNIVERSUM	312		
MARNATZ		815	YAMAHA	314, 315		
MEMOREX		819	PIONEER	300, 325 (CD-Recorder)		
MITSUBISHI		823	TV	PHILIPS	601, 607, 610, 636	
NAKAMICHI		806		SONY	604	
ONKYO		808, 812		GRUNDIG	601, 632	
PHILIPS		815		PANASONIC	601, 608, 620, 622	
SANSUI		818		TOSHIBA	605, 632	
SHERWOOD		809		TELEFUNKEN	612, 614, 631	
SONY		801, 817		SHARP	602	
TANDBERG		814		SAMSUNG	607, 615, 623, 625	
TECHNICS		803		HITACHI	601, 606, 610, 612, 620, 621, 633, 637	
TOSHIBA		820, 822		SABA	601, 612, 620, 630	
				BRANDT	612	

VSX-D938TX

Device	Manufacturer	Code	Device	Manufacturer	Code
TV	SANYO	611, 624, 627	TV	FISHER	603, 611, 615, 624
	THOMSON	612, 630, 631		FORMENTI	603, 607, 620
	FERGUSON	607, 612, 630		FRONTECH	601, 620, 625
	NOKIA	603, 620, 631		FRONTECH/ PROTECH	603
	MITSUBISHI	601, 609		FUJITSU	627
	SCHNEIDER	607, 619, 626		FUNAI	617, 625
	GOLDSTAR	607, 629		GBC	603, 620
	BLAUPUNKT	601		GEC	607, 610, 627
	NORDMENDE	603, 612, 630, 631		GELOSO	603, 623
	RADIOLA	607		GENEXXA	601, 619
	JVC	613		GOODMANS	607, 616, 626, 627, 636
	DAEWOO	607, 623, 636		GORENJE	615
	ORION	603, 607, 616, 617		GPM	619
	SIEMENS	601		GRAETZ	601, 620
	ACURA	623		GRANADA	607, 611, 620, 621, 627
	ADMIRAL	601		GRANDIENTE	639
	AKAI	603, 611, 620		GRANDIN	618
	AKURA	619		HANSEATIC	607, 620
	ALBA	607, 616, 619, 623		HCM	618, 623
	AMSTRAD	620, 623, 626		HINARI	607, 619, 623
	ANITECH	623		HISAWA	618
	ASA	624		HUANYU	636
	ASUKA	619		HYPSON	607, 618, 625
	AUDIOGONIC	607, 612		ICE	625, 626
	BASIC LINE	619, 623		IMPERIAL	615, 620
	BAUR	601, 607, 620		INDIANA	607
	BEKO	615		INGELEN	601
	BEON	607		INTERFUNK	601, 603, 607, 620
	BLUE SKY	619		INTERVISION	625, 628
	BLUE STAR	618		ISUKAI	619
	BPL	618		ITC	620
	BTC	619		ITT	601, 603, 620
	BUSH	607, 619, 620, 623, 626, 636		JEC	605
	CASCADE	623		KAISUI	618, 619, 623
	CATHAY	607		KAPSCH	601
	CENTURION	607		KENDO	620
	CGB	620		KENNEDY	603, 620
	CIMLINE	623		KORPEL	607
	CLARIVOX	607		KOYODA	623
	CLATRONIC	615		LEYCO	607, 617, 625, 627
	CONDOR	615		LIESENK&TTER	607
	CONTEC	623		LUXOR	603, 620, 621
	CROSLEY	603		M ELECTRONIC	601, 623, 624, 633, 635, 636
	CROWN	615, 623		M-ELECTRONIC	607, 612, 630
	CRYSTAL	620		MAGNADYNE	603, 628
	CYBERTRON	619		MAGNAFON	628
	DAINICHI	619		MANESTH	616, 625
	DANSAI	607		MARANTZ	607
	DAYTON	623		MARK	607
	DECCA	607, 627		MATSUI	607, 616, 617, 620, 623, 626, 627
	DIXI	607, 623		MCMICHAEL	610
	DUMONT	632		MEDIATOR	607
	ELIN	607		MEMOREX	623
	ELITE	619		METZ	601
	ELTA	623		MINERVA	601, 632
	EMERSON	620		MULTITECH	623, 628
	ERRES	607		NECKERMANN	601, 607
	FINLANDIA	611, 621, 635			
	FINLUX	603, 607, 624, 627, 632, 633, 635			
	FIRSTLINE	617, 623			

VSX-D938TX

Device	Manufacturer	Code	Device	Manufacturer	Code	
TV	NEI	607, 620	TV	SONOKO	607, 623	
	NIKKAI	605, 607, 619, 625, 627		SONOLOR	601, 611	
	NOBLIKO	628		SONTEC	607	
	OCEANIC	601, 603, 620		SOUNDWAVE	607	
	OSAKI	619, 625, 627		STANDARD	619, 623	
	OSO	619		STERN	601	
	OSUME	627		SUSUMU	619	
	OTTO VERSAND	601, 603, 607, 620		SYSLINE	607	
	PALLADIUM	615		TANDY	601, 619, 627	
	PANAMA	625		TASHIKO	610	
	PATHO CINEMA	620		TATUNG	607, 627	
	PAUSA	623		TEC	620	
	PHILCO	603, 620		TELEAVIA	612	
	PHOENIX	603		TELETECH	623	
	PHONOLA	607		TENSAI	617, 619	
	PROFEX	620, 623		THORN	601, 607, 620, 624, 627	
	PROTECH	607, 620, 623, 625, 628		TOMASHI	618	
	QUELLE	601, 603, 607, 620, 624, 632		TOWADA	620	
	R-LINE	607		ULTRAVOX	603, 620, 628	
	RBM	632		UNIVERSUM	601, 607, 615, 620, 624, 625, 633, 635	
	REDIFFUSION	603, 620		VESTEL	607	
	REX	601, 625		VOXSON	601	
	ROADSTAR	619, 623, 625		WALTHAM	621	
	SAISHO	616, 623, 625		WATSON	607	
	SALORA	601, 603, 620, 621		WATT RADIO	603, 620, 628	
	SAMBERS	628		WHITE	607	
	SBR	607, 610		WESTINGHOUSE		
	SCHAUB LORENZ	620		YOKO	607, 620, 625	
	SEG	620, 625		PIONEER	600, 601, 603, 607, 612, 620, 630	
	SEI	603, 617, 628				
	SELECO	601, 620		MD	SONY	901
	SIAREM	603, 628			KENWOOD	903
	SINUDYNE	603, 616, 617, 628			SHARP	902
	SKANTIC	621			TEAC	904
SOLAVOX	601		ONKYO	905		
			DENON	906		
			PIONEER	900, 902		

VSX-D908TX/D908TX-G

Device	Manufacturer	Code	Device	Manufacturer	Code		
DVD	TOSHIBA	001	TAPE	PIONEER	800		
	SONY	002	CD	SONY	301, 316, 317, 318		
PANASONIC	003	TECHNICS		304, 326			
JVC	004	KENWOOD		310, 321, 311			
SAMSUNG	005	DENON		309			
SHARP	006	RCA		302, 319, 313			
AKAI	007	PHILIPS		312, 322			
RCA	009	YAMAHA		315, 314, 328			
PIONEER	000, 008	JVC		303			
LD	SONY	101		TEAC	305, 306, 327, 324, 325		
	PANASONIC	105, 106		ONKYO MARANTZ SANYO OPTIMUS PIONEER	320, 308, 307		
	KENWOOD	103	323, 312, 324				
	PHILIPS	104	313				
	MITSUBISHI	100	300				
	RCA	107	300, 329				
	PIONEER	100	(CD-Recorder)				
102 (DVD code)							
SAT	RCA	201 (SAT), 203 (SAT)	MD	SONY	901		
	SONY	202 (SAT)		KENWOOD	903		
	PIONEER	200 (SAT), 204 (Digital Tuner)		SHARP	902		
VCR	RCA	401, 406, 408, 414, 405, 413, 411, 415 403, 404, 417	TEAC	ONKYO	905		
				DENON	906		
				PIONEER	900, 902		
	ZENITH	414, 408, 426, 403	TV	RCA	601, 610, 615, 616, 617, 618		
				MAGNAVOX	603, 620		
	FISHER	410, 426, 412, 427, 425, 420		ZENITH	607, 610, 603, 612, 629		
				MAGNAVOX	601, 608, 607, 610, 617, 602, 628 618		
	PANASONIC	408, 432, 433		GE	PANASONIC	608, 622, 607	
					SONY	604	
					SONY	605, 602, 626, 621	
	TOSHIBA	405, 409, 426		HITACHI	TOSHIBA	609, 610, 602, 621	
					MITSUBISHI	606, 610, 624, 625, 618	
	JVC	428, 430, 429, 408, 414, 431, 407		HITACHI	JVC	613, 623	
			HITACHI		602, 619, 627		
	SONY	408, 401, 406, 436, 434	SHARP	SANYO	621, 614		
				SONY	607		
				PHILIPS	610, 623, 621, 602		
MITSUBISHI	416, 417, 404, 408	GOLDSTAR	GOLDSTAR	610, 623, 621, 602			
			MITSUBISHI	610, 623, 621, 602			
SANYO	409, 420, 421, 422, 423, 424, 408 407	SHACK	RADIO	635			
			SHARP	GRANDIENTE	600		
				OPTIMUS	PIONEER		
			GOLDSTAR	410, 412, 425, 435	CATV	JERROLD	711, 701, 702, 712, 704, 713, 703, 714, 716, 715
						SHARP	S.ATLANTA
			OPTIMUS	402, 418, 419	PIONEER	ZENITH	707, 717, 710
						GRANDIENTE	PIONEER
PIONEER	452	TUNER	PIONEER	500			
			400, 453 (DVD Video Recorder)				
TAPE	SONY TECHNICS KENWOOD TEAC DENON ONKYO YAMAHA JVC FISHER OPTIMUS	801, 806 803 804, 807 805 810 809, 808 811, 812 802 813 800					

Troubleshooting

Incorrect operations are often mistaken for trouble and malfunctions. If you think that there is something wrong with this component, check the points below. Sometimes the trouble may lie in another component. Investigate the other components and electrical appliances being used. If the trouble cannot be rectified even after exercising the checks listed below, ask your nearest PIONEER authorized service center or your dealer to carry out repair work.

Symptom	Cause	Remedy
The power does not turn ON.	<ul style="list-style-type: none"> The power plug is disconnected. The protection circuit may have been activated. 	<ul style="list-style-type: none"> Connect the power plug to the wall outlet. Disconnect the power plug from the outlet, and insert again.
The unit does not respond when the buttons are pressed.	<ul style="list-style-type: none"> Static electricity caused by dry air. 	<ul style="list-style-type: none"> Disconnect the power plug from the outlet, and insert again.
No sound is output when a function is selected.	<ul style="list-style-type: none"> Improper connections. Sound is muted. The volume is turned down. The TAPE 2 MONITOR is ON. Speakers are turned OFF. DIGITAL/ANALOG switch is set incorrectly. 	<ul style="list-style-type: none"> Make sure the component is connected correctly (see p. 8-17). Press MUTE on the remote control. Adjust MASTER VOLUME. Press the TAPE 2 MONITOR button. Press SPEAKERS (A/B) to select the speakers you connected. Set SIGNAL SELECT (see p. 44)
No image is output when a function is selected.	<ul style="list-style-type: none"> Improper connections. The input source is not properly selected. 	<ul style="list-style-type: none"> Make sure the component is connected correctly (see p. 8, 9). Press the correct function button.
Considerable noise in radio broadcasts.	<ul style="list-style-type: none"> Incorrect frequency. The antenna is not connected. AC-3 RF and/or digital cables are near the antenna terminals and wires. 	<ul style="list-style-type: none"> Tune in the correct frequency. Connect the antenna (see p.13). Route AC-3 RF and digital cables away from the antenna terminals and wires.
	<p>FM broadcasts</p> <ul style="list-style-type: none"> The FM antenna is not fully extended or is poorly positioned. Weak radio signals. 	<ul style="list-style-type: none"> Fully extend the FM wire antenna, position for best reception, and secure to a wall. Connect an outdoor FM antenna (see p.13).
	<p>AM broadcasts</p> <ul style="list-style-type: none"> The AM antenna is poorly positioned. Weak radio signals. Interference caused by other equipment (fluorescent lamp, motor, etc.). 	<ul style="list-style-type: none"> Adjust the direction and position for best reception. Connect an additional internal or external AM antenna (see p.13). Turn off the equipment causing the noise or move it away from the receiver. Place the antenna farther away from the equipment causing the noise.
Broadcast stations cannot be selected automatically.	<ul style="list-style-type: none"> Weak radio signals. 	<ul style="list-style-type: none"> Connect an outdoor antenna (see p.13).
Sub woofer output is very low.	<ul style="list-style-type: none"> Settings route signal away from Sub woofer. 	<ul style="list-style-type: none"> To get more signal to the sub woofer set it to PLUS or choose SMALL for the FRONT speakers.

Symptom	Cause	Remedy
No sound from surround or center speakers.	<ul style="list-style-type: none"> • Speaker settings are incorrect. • The surround and/or center levels are turned down. • The surround and/or center speakers are disconnected. 	<ul style="list-style-type: none"> • See "Speaker setting" on p.29-30 to check the speaker setting. • See "Channel level" on p.32 to check the speaker levels. • Connect the speakers (see p.14,15).
Sound is produced from some components, but not from digital components.	<ul style="list-style-type: none"> • SIGNAL SELECT is set incorrectly. • The digital inputs are assigned incorrectly, or not at all. 	<ul style="list-style-type: none"> • Set SIGNAL SELECT to "DIGITAL" or "ANALOG" according to the type of connections made (see p.44). • Set the digital input settings correctly (see p.10, 37).
No sound is output or a noise is output when software with DTS is played back.	<ul style="list-style-type: none"> • SIGNAL SELECT is set to "ANALOG". • A DVD player not compatible with DTS is used, or the setting of the DVD player is incorrect. • The digital output level has been turned down on a CD player or other component equipped with digital output level adjustment capability. (The DTS signal has been altered by the player, and cannot be read.) 	<ul style="list-style-type: none"> • Make digital connections (see p.10-11) and set SIGNAL SELECT to "DIGITAL" (see p.44). • Refer to the instruction manual supplied with the DVD player. • Set the digital volume level of the player to full, or to the neutral position.
The sound is output intermittently when software with DTS is played back. The overload indicator is lit.	<ul style="list-style-type: none"> • Disc being played back has a huge amount of information on it. 	<ul style="list-style-type: none"> • Use the STANDARD mode to get the best results (see p.41).
When a search is performed by a DTS compatible CD player during playback, noise is output.	<ul style="list-style-type: none"> • The search function performed by the player interferes with the reading of digital information. 	<ul style="list-style-type: none"> • This is not a malfunction, but be sure to turn the volume down to prevent the output of loud noise from your speakers.
Cannot be remote controlled.	<ul style="list-style-type: none"> • The remote control batteries have worn out. • Too far away or bad angle of operation. • There is an obstacle between the receiver and the remote control. • Strong light such as fluorescent light is shining onto the unit's remote control signal light-receiving window. • A cord is connected to the CONTROL IN terminal on this unit. • The IR -Receiver type is mismatched with the setting. 	<ul style="list-style-type: none"> • Replace the batteries (see p.7). • Operate within 7 m, 30° of the remote sensor on the front panel (see p.7). • Remove the obstacle or operate from another position. • Avoid exposing the remote sensor on the front panel to direct light. • Connect cord to the correct jack. • Disconnect the IR Receiver from the rear panel, and set to the other IR Receiver type.
The display is dark.	<ul style="list-style-type: none"> • The FL DIMMER button is pushed. 	<ul style="list-style-type: none"> • Press FL DIMMER on the front panel repeatedly to return to the default setting.

If the unit does not operate normally due to external effects such as static electricity

Disconnect the power plug from the outlet and insert again to return to normal operating conditions.

Specifications

VSX-D938TX: (Singapore model)

Continuous Power Output (STEREO MODE)
 Front 110 W + 110 W (DIN; 1kHz, T.H.D 1%, 8 Ω)

Continuous Power Output (SURROUND MODE)
 Front 110 W + 110 W (DIN; 1kHz, T.H.D 1%, 8 Ω)
 Center 110 W (DIN; 1kHz, T.H.D 1%, 8 Ω)
 Surround 110 W + 110 W (DIN; 1kHz, T.H.D 1%, 8 Ω)

Rated Power Output 100 W + 100 W (20Hz–20kHz 0.09%, 8 Ω)

Input (Sensitivity/Impedance)
 PHONO MM 4.7 mV/47 kΩ
 VCR 1, VCR 2, DVD/LD, TV/SAT, VIDEO, CD, MD/TAPE 1, TAPE 2 335 mV/47 kΩ

Frequency Response
 PHONO MM 20 Hz to 20,000 Hz ±0.3 dB
 VCR 1, VCR 2, DVD/LD, TV/SAT, VIDEO, CD, MD/TAPE 1, TAPE 2 5 Hz to 100,000 Hz ⁺⁰/₋₃ dB

Output (Level/Impedance)
 VCR 1 REC, VCR 2 REC, MD/TAPE 1 REC, TAPE 2 REC 335 mV/2.2 kΩ

Tone Control
 BASS ± 6 dB (100 Hz)
 TREBLE ± 6 dB (10 kHz)
 LOUDNESS +3 dB (100 Hz/10 kHz)

Signal-to-Noise Ratio [DIN(Continuous power output/50 mW)]*
 PHONO MM 68 dB/61dB
 VCR 1, VCR 2, DVD/LD, TV/SAT, VIDEO, CD, MD/TAPE 1, TAPE 2 92 dB/62 dB

VIDEO Section

Input (Sensitivity/Impedance)
 VCR 1, VCR 2, DVD/LD, TV/SAT, VIDEO 1 Vp-p/75 Ω

Output (Level/Impedance)
 VCR 1, VCR 2, MONITOR 1 Vp-p/75 Ω

Frequency Response
 VCR 1, VCR 2, MONITOR 5 Hz to 100,000 Hz ⁺⁰/₋₃ dB
 Signal-to-Noise Ratio 65 dB

* Direct: ON

FM Tuner Section

Frequency Range 87.5 MHz to 108 MHz
 Usable Sensitivity Mono: 15.2 dBf, IHF (1.6 μV/75 Ω)
 50 dB Quieting Sensitivity Mono: 20.2 dBf
 Stereo: 41.2 dBf
 Signal-to-Noise Ratio Mono: 76 dB (at 85 dBf)
 Stereo: 72 dB (at 85 dBf)
 Distortion Stereo: 0.6 % (1 kHz)
 Alternate Channel Selectivity 70 dB (400 kHz)
 Stereo Separation 40 dB (1 kHz)
 Frequency Response 30 Hz to 15 kHz (± 1) dB
 Antenna Input 75 Ω unbalanced

AM Tuner Section

Frequency Range 531 kHz to 1,620 kHz(9kHz step)
 Sensitivity (IHF, Loop antenna) 350 μV/m
 Selectivity 25 dB
 Signal-to-Noise Ratio 50 dB
 Antenna Loop antenna

Miscellaneous

Power Requirements
 Singaporean model 220-230V AC, 50/60Hz
 Power Consumption
 Singaporean model 400 W
 Power Consumption in Standby mode 1.0 W
 AC Outlet
 SWITCHED (x2) Total 100 W MAX
 UNSWITCHED 100 W MAX
 Dimensions 420 (W) × 173 (H) × 470 (D) mm
 Weight (without package) 16.2 kg

Furnished Parts

FM Antenna 1
 AM Loop Antenna 1
 Dry Cell Batteries (SIZE "AA" (IEC LR6)) 2
 Remote Control Unit 1
 Operating Instructions 1

NOTE:

Specifications and the design are subject to possible modifications without notice, due to improvements.

**VSX-D938TX (Taiwan model)/D908TX/
D908TX-G:**

Continuous Power Output (STEREO MODE)
Front 110 W + 110 W (DIN; 1kHz, T.H.D 1%, 8 Ω)

Continuous Power Output (SURROUND MODE)
Front 110 W + 110 W (DIN; 1kHz, T.H.D 1%, 8 Ω)
Center 110 W (DIN; 1kHz, T.H.D 1%, 8 Ω)
Surround 110 W + 110 W
(DIN; 1kHz, T.H.D 1%, 8 Ω)

Rated Power Output 100 W + 100 W
(20 Hz–20 kHz 0.09%, 8 Ω)

Input (Sensitivity/Impedance)

PHONO MM 4.7 mV/47 k Ω
VCR 1, VCR 2, DVD/LD, TV/SAT, VIDEO, CD,
MD/TAPE 1, TAPE 2 335 mV/47 k Ω

Frequency Response

PHONO MM 20 Hz to 20,000 Hz ± 0.3 dB
VCR 1, VCR 2, DVD/LD, TV/SAT, VIDEO, CD,
MD/TAPE 1, TAPE 2 5 Hz to 100,000 Hz $^{+0}_{-3}$ dB

Output (Level/Impedance)

VCR 1 REC, VCR 2 REC, MD/TAPE 1 REC, TAPE 2 REC
..... 335 mV/2.2 k Ω

Tone Control

BASS ± 6 dB (100 Hz)
TREBLE ± 6 dB (10 kHz)
LOUDNESS +3 dB (100 Hz/10 kHz)

Signal-to-Noise Ratio (IHF, short circuited, A network)

PHONO MM 80 dB
VCR 1, VCR 2, DVD/LD, TV/SAT, VIDEO, CD, MD/TAPE 1,
TAPE 2 97 dB

Signal-to-Noise Ratio [EIA, at 1 W (1 kHz)]

PHONO MM 80 dB
VCR 1, VCR 2, DVD/LD, TV/SAT, VIDEO, CD, MD/TAPE 1,
TAPE 2 83 dB

VIDEO Section

Input (Sensitivity/Impedance)

VCR 1, VCR 2, DVD/LD, TV/SAT, VIDEO 1 V_{p-p}/75 Ω

Output (Level/Impedance)

VCR 1, VCR 2, MONITOR 1 V_{p-p}/75 Ω

Frequency Response

VCR 1, VCR 2, MONITOR 5 Hz to 100,000 Hz $^{+0}_{-3}$ dB

Signal-to-Noise Ratio 65 dB

FM Tuner Section

Frequency Range 87.5 MHz to 108 MHz
Usable Sensitivity Mono: 13.2 dBf, IHF (1.3 μ V/75 Ω)
50 dB Quieting Sensitivity Mono: 20.2 dBf
Stereo: 38.6 dBf

Signal-to-Noise Ratio Mono: 73 dB (at 85 dBf)
Stereo: 70 dB (at 85 dBf)

Distortion Stereo: 0.5 % (1 kHz)

Alternate Channel Selectivity 60 dB (400 kHz)

Stereo Separation 40 dB (1 kHz)

Frequency Response 30 Hz to 15 kHz (± 1) dB

Antenna Input 75 Ω unbalanced

AM Tuner Section

Frequency Range

VSX-D938TX (Taiwan model)
531 kHz to 1,620 kHz(9 kHz step)

VSX-D908TX/D908TX-G
531 kHz to 1,620 kHz(9 kHz step)
530 kHz to 1,700 kHz(10 kHz step)

Sensitivity (IHF, Loop antenna) 350 μ V/m

Selectivity 25 dB

Signal-to-Noise Ratio 50 dB

Antenna Loop antenna

Miscellaneous

Power Requirements

VSX-D938TX (Taiwan model) AC 110 V, 50/60 Hz

VSX-D908TX/D908TX-G
AC 110/120-127V/220V/240V (Switchable), 50/60 Hz

Power Consumption 1000 W

Power Consumption in Standby mode 1.0 W

AC Outlet

SWITCHED ($\times 2$) Total 100 W MAX

UNSWITCHED 100 W MAX

Dimensions 420 (W) \times 173 (H) \times 470 (D) mm
Weight (without package)

VSX-D938TX (Taiwan model) 16.2 kg

VSX-D908TX/D908TX-G 15.2 kg

Furnished Parts

FM Antenna 1

AM Loop Antenna 1

Dry Cell Batteries (SIZE "AA" (IEC LR6)) 2

Remote Control Unit 1

Operating Instructions 1

NOTE:

Specifications and the design are subject to possible modifications without notice, due to improvements.

Power cord CAUTION!

Handle the power cord by the plug. Do not pull out the plug by tugging the cord and never touch the power cord when your hands are wet as this could cause a short circuit or electric shock. Do not place the unit, a piece of furniture, etc., on the power cord, or pinch the cord. Never make a knot in the cord or tie it with other cords. The power cords should be routed such that they are not likely to be stepped on. A damaged power cord can cause a fire or give you an electrical shock. Check the power cord once in a while. When you find it damaged, ask your nearest PIONEER authorized service center or your dealer for a replacement.

Maintenance of External Surfaces

- Use a polishing cloth or dry cloth to wipe off dust and dirt.
- When the surfaces are dirty, wipe with a soft cloth dipped in some neutral cleanser diluted five or six times with water, and wrung out well, and then wipe again with a dry cloth. Do not use furniture wax or cleaners.
- Never use thinners, benzine, insecticide sprays or other chemicals on or near this unit, since these will corrode the surfaces.

Published by Pioneer Electronic Corporation.
Copyright © 1999 Pioneer Electronic Corporation.
All rights reserved.

PIONEER ELECTRONIC CORPORATION 4-1, Meguro 1-Chome, Meguro-ku, Tokyo 153-8654, Japan

PIONEER ELECTRONICS [USA] INC. P.O. BOX 1540, Long Beach, California 90801-1540, USA

PIONEER ELECTRONICS OF CANADA, INC. 300 Allstate Parkway, Markham, Ontario L3R 0P2, Canada

PIONEER ELECTRONIC [EUROPE] N.V. Haven 1087, Keetberglaan 1, 9120 Melsele, Belgium TEL: 03/570.05.11

PIONEER ELECTRONICS AUSTRALIA PTY. LTD. 178-184 Boundary Road, Braeside, Victoria 3195, Australia, TEL: 03-9586-6300

PIONEER ELECTRONICS DE MEXICO S.A. DE C.V. San Lorenzo Num 1009 3er piso Desp. 302 Col. Del Valle, Mexico D.F. C.P. 03100 TEL: 5-688-52-90

Free Manuals Download Website

<http://myh66.com>

<http://usermanuals.us>

<http://www.somanuals.com>

<http://www.4manuals.cc>

<http://www.manual-lib.com>

<http://www.404manual.com>

<http://www.luxmanual.com>

<http://aubethermostatmanual.com>

Golf course search by state

<http://golfingnear.com>

Email search by domain

<http://emailbydomain.com>

Auto manuals search

<http://auto.somanuals.com>

TV manuals search

<http://tv.somanuals.com>