

Pioneer

FILE-TYPE COMPACT DISC PLAYER

PD-F1009

Operating Instructions



WARNING: TO PREVENT FIRE OR SHOCK HAZARD, DO NOT EXPOSE THIS APPLIANCE TO RAIN OR MOISTURE.

IMPORTANT NOTICE

The serial number for this equipment is located on the rear panel. Please write this serial number on your enclosed warranty card and keep it in a secure area. This is for your security.

IMPORTANT



The lightning flash with arrowhead symbol, within an equilateral triangle, is intended to alert the user to the presence of uninsulated "dangerous voltage" within the product's enclosure that may be of sufficient magnitude to constitute a risk of electric shock to persons.

CAUTION

**RISK OF ELECTRIC SHOCK
DO NOT OPEN**

CAUTION:

TO PREVENT THE RISK OF ELECTRIC SHOCK, DO NOT REMOVE COVER (OR BACK). NO USER-SERVICEABLE PARTS INSIDE. REFER SERVICING TO QUALIFIED SERVICE PERSONNEL.



The exclamation point within an equilateral triangle is intended to alert the user to the presence of important operating and maintenance (servicing) instructions in the literature accompanying the appliance.

IMPORTANT SAFETY INSTRUCTIONS

READ INSTRUCTIONS — All the safety and operating instructions should be read before the product is operated.

RETAIN INSTRUCTIONS — The safety and operating instructions should be retained for future reference.

HEED WARNINGS — All warnings on the product and in the operating instructions should be adhered to.

FOLLOW INSTRUCTIONS — All operating and use instructions should be followed.

CLEANING — Unplug this product from the wall outlet before cleaning. The product should be cleaned only with a polishing cloth or a soft dry cloth. Never clean with furniture wax, benzine, insecticides or other volatile liquids since they may corrode the cabinet.

ATTACHMENTS — Do not use attachments not recommended by the product manufacturer as they may cause hazards.

WATER AND MOISTURE — Do not use this product near water — for example, near a bathtub, wash bowl, kitchen sink, or laundry tub; in a wet basement; or near a swimming pool; and the like.

ACCESSORIES — Do not place this product on an unstable cart, stand, tripod, bracket, or table. The product may fall, causing serious injury to a child or adult, and serious damage to the product. Use only with a cart, stand, tripod, bracket, or table recommended by the manufacturer, or sold with the product. Any mounting of the product should follow the manufacturer's instructions, and should use a mounting accessory recommended by the manufacturer.

CART — A product and cart combination should be moved with care. Quick stops, excessive force, and uneven surfaces may cause the product and cart combination to overturn.



VENTILATION — Slots and openings in the cabinet are provided for ventilation and to ensure reliable operation of the product and to protect it from overheating, and these openings must not be blocked or covered. The openings should never be blocked by placing the product on a bed, sofa, rug, or other similar surface. This product should not be placed in a built-in installation such as a bookcase or rack unless proper ventilation is provided or the manufacturer's instructions have been adhered to.

POWER SOURCES — This product should be operated only from the type of power source indicated on the marking label. If you are not sure of the type of power supply to your home, consult your product dealer or local power company.

LOCATION — The appliance should be installed in a stable location.

NONUSE PERIODS — The power cord of the appliance should be unplugged from the outlet when left unused for a long period of time.

GROUNDING OR POLARIZATION

- If this product is equipped with a polarized alternating current line plug (a plug having one blade wider than the other), it will fit into the outlet only one way. This is a safety feature. If you are unable to insert the plug fully into the outlet, try reversing the plug. If the plug should still fail to fit, contact your electrician to replace your obsolete outlet. Do not defeat the safety purpose of the polarized plug.
- If this product is equipped with a three-wire grounding type plug, a plug having a third (grounding) pin, it will only fit into a grounding type power outlet. This is a safety feature. If you are unable to insert the plug into the outlet, contact your electrician to replace your obsolete outlet. Do not defeat the safety purpose of the grounding type plug.

POWER-CORD PROTECTION — Power-supply cords should be routed so that they are not likely to be walked on or pinched by items placed upon or against them, paying particular attention to cords at plugs, convenience receptacles, and the point where they exit from the product.

OUTDOOR ANTENNA GROUNDING — If an outside antenna or cable system is connected to the product, be sure the antenna or cable system is grounded so as to provide some protection against voltage surges and built-up static charges. Article 810 of the National Electrical Code, ANSI/NFPA 70, provides information with regard to proper grounding of the mast and supporting structure, grounding of the lead-in wire to an antenna discharge unit, size of grounding conductors, location of antenna-discharge unit, connection to grounding electrodes, and requirements for the grounding electrode. See Figure A.

LIGHTNING — For added protection for this product during a lightning storm, or when it is left unattended and unused for long periods of time, unplug it from the wall outlet and disconnect the antenna or cable system. This will prevent damage to the product due to lightning and power-line surges.

POWER LINES — An outside antenna system should not be located in the vicinity of overhead power lines or other electric light or power circuits, or where it can fall into such power lines or circuits. When installing an outside antenna system, extreme care should be taken to keep from touching such power lines or circuits as contact with them might be fatal.

OVERLOADING — Do not overload wall outlets, extension cords, or integral convenience receptacles as this can result in a risk of fire or electric shock.

OBJECT AND LIQUID ENTRY — Never push objects of any kind into this product through openings as they may touch dangerous voltage points or short-out parts that could result in a fire or electric shock. Never spill liquid of any kind on the product.

SERVICING — Do not attempt to service this product yourself as opening or removing covers may expose you to dangerous voltage or other hazards. Refer all servicing to qualified service personnel.

DAMAGE REQUIRING SERVICE — Unplug this product from the wall outlet and refer servicing to qualified service personnel under the following conditions:

- When the power-supply cord or plug is damaged.
- If liquid has been spilled, or objects have fallen into the product.
- If the product has been exposed to rain or water.
- If the product does not operate normally by following the operating instructions. Adjust only those controls that are covered by the operating instructions as an improper adjustment of other controls may result in damage and will often require extensive work by a qualified technician to restore the product to its normal operation.
- If the product has been dropped or damaged in any way.
- When the product exhibits a distinct change in performance — this indicates a need for service.

REPLACEMENT PARTS — When replacement parts are required, be sure the service technician has used replacement parts specified by the manufacturer or have the same characteristics as the original part. Unauthorized substitutions may result in fire, electric shock, or other hazards.

SAFETY CHECK — Upon completion of any service or repairs to this product, ask the service technician to perform safety checks to determine that the product is in proper operating condition.

WALL OR CEILING MOUNTING — The product should not be mounted to a wall or ceiling.

HEAT — The product should be situated away from heat sources such as radiators, heat registers, stoves, or other products (including amplifiers) that produce heat.

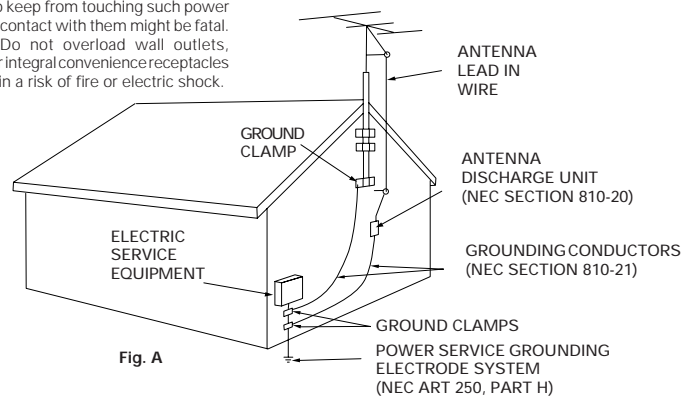

Fig. A

NEC — NATIONAL ELECTRICAL CODE

CAUTION

- Use of controls or adjustments or performance of procedures other than those specified herein may result in hazardous radiation exposure.
- The use of optical instruments with this product will increase eye hazard.

This equipment has been tested and found to comply with the limits for a Class B digital device, pursuant to Part 15 of the FCC Rules. These limits are designed to provide reasonable protection against harmful interference in a residential installation. This equipment generates, uses, and can radiate radio frequency energy and, if not installed and used in accordance with the instructions, may cause harmful interference to radio communications. However, there is no guarantee that interference will not occur in a particular installation. If this equipment does cause harmful interference to radio or television reception, which can be determined by turning the equipment off and on, the user is encouraged to try to correct the interference by one or more of the following measures:

- Reorient or relocate the receiving antenna.
- Increase the separation between the equipment and receiver.
- Connect the equipment into an outlet on a circuit different from that to which the receiver is connected.
- Consult the dealer or an experienced radio/TV technician for help.

Information to User

Alteration or modifications carried out without appropriate authorization may invalidate the user's right to operate the equipment.

[For Canadian model]

CAUTION: TO PREVENT ELECTRIC SHOCK DO NOT USE THIS (POLARIZED) PLUG WITH AN EXTENSION CORD, RECEPTACLE OR OTHER OUTLET UNLESS THE BLADES CAN BE FULLY INSERTED TO PREVENT BLADE EXPOSURE.

ATTENTION: POUR PREVENIR LES CHOCS ELECTRIQUES NE PAS UTILISER CETTE FICHE POLARISEE AVEC UN PROLONGATEUR, UNE PRISE DE COURANT OU UNE AUTRE SORTIE DE COURANT, SAUF SI LES LAMES PEUVENT ETRE INSEREES A FOND SANS EN LAISSER AUCUNE PARTIE A DECOUVERT.

CAUTION

This product satisfies FCC regulations when shielded cables and connectors are used to connect the unit to other equipment. To prevent electromagnetic interference with electric appliances such as radios and televisions, use shielded cables and connectors for connections.

[For Canadian model]

This Class B digital apparatus complies with Canadian ICES-003.

[Pour le modèle Canadien]

Cet appareil numérique de la classe B est conforme à la norme NMB-003 du Canada.

This player is for consumer use. If the player is used in a business (for example, used for a long period at a restaurant), the player will not be covered under warranty. CD video, VIDEO CD, CD graphics and CD-ROM discs can not be played with this player.

Location

Install the player in a well-ventilated location where it will not be exposed to high temperatures or humidity.

Do not install the player in a location which is exposed to direct rays of the sun, or near stoves or radiators. Excessive heat can adversely affect the cabinet and internal components. Installation of the player in a damp or dusty environment may also result in a malfunction or an accident. (Avoid installation near cookers etc., where the player may be exposed to oily smoke, steam or heat.)

Do not install the player on a tottered stand nor in an unstable or inclined place.

Thank you for buying this Pioneer product.

Please read through these operating instructions so you will know how to operate your model properly. After you have finished reading the instructions, put them away in a safe place for future reference.

CONTENTS

BEFORE YOU USE THE PLAYER	4
CAUTIONS REGARDING HANDLING	5
CONNECTIONS	6
NAMES OF PARTS	7
HOW TO LOAD THE DISCS	9
BASIC OPERATIONS	
To listen in order from the first track	10
To select the disc and track	10
To select a play mode	10
Playing a disc that is not loaded in the rack	11
To play a track you want to hear	11
To start playback from a specific disc	11
Opening or closing the hood during playback	11
VARIOUS OPERATIONS	
To program and play only the discs you want to hear ...	12
To repeat playback	13
To store your favorite tracks	13
To find out which discs you've listened to recently	14
To playback tracks/discs at random	14
To program tracks/discs in a desired order	15
To scan quickly through tracks on a disc	16
To use the DISPLAY button	17
TROUBLESHOOTING	
SPECIFICATIONS	19

Condensation

When this unit is brought into a warm room from previously cold surroundings or when the room temperature rises sharply, condensation may form inside, and the unit may not be able to attain its full performance. If this occurs, allow the unit to stand for about an hour or raise the room temperature gradually.

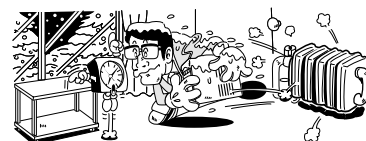



BEFORE YOU USE THE PLAYER

HERE'S WHAT YOU CAN DO!

❑ 301 CD giga changer for the compact 16 inch width

The new roulette-type mechanism allows for a capacity of 301 CDs.

❑ One-disc jump-in playback thanks to a single loader slot

The PD-F1009 is equipped with a single loader that lets you easily play a disc that is not loaded in the rack. What's more, a priority key makes for excellent operability of the jump-in play function.

❑ Compatible with recordable CDs

As well as regular CDs, this unit can play CD-R and CD-RW discs.

❑ CD TEXT compatible

The disc titles are displayed while playing CD TEXT disc.

❑ Many handy functions for taking maximum advantage of the changer

The PD-F1009 is equipped with three listening modes (ALL, SINGLE and CUSTOM) with 5 custom files, as well as a direct button for even greater operability. What's more, a jog dial on the main unit makes it even easier to select discs and so on.

❑ Disc detection function

When the hood is closed, the set automatically detects whether or not a disc is loaded.

❑ Energy-saving design

This unit is designed to use 1W of energy when this player is in standby mode.

CONFIRM SUPPLIED ACCESSORIES

Remote control unit x 1

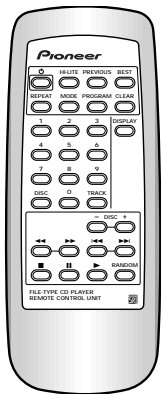

Audio cable x 1

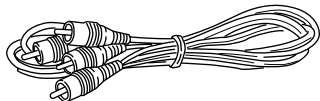

Control cable x 1



Size AA/R6P dry cell batteries x 2

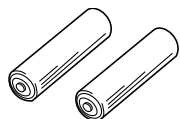

Other included items

- Warranty card
- Operating Instructions (this manual)

PUT BATTERIES INTO THE REMOTE CONTROL UNIT

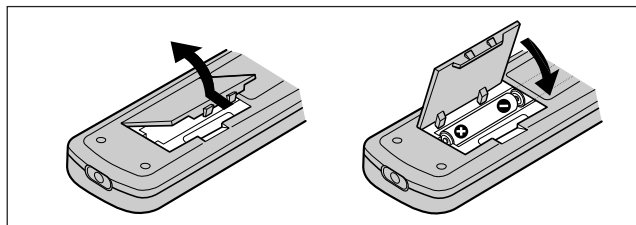

Open the lid of the battery compartment on the rear of the remote control unit, and insert the batteries, taking care to align the ⊕ and ⊖ polarities correctly.

Notes!!

- In order to prevent battery leakage, remove the batteries when not using the remote control unit for an extended period (one month or more). If leakage occurs, carefully wipe away any battery fluid inside the compartment, and replace the batteries with new ones.
- Do not allow books or other objects to rest on top of the remote control unit, since the buttons may be depressed, causing faster exhaustion of the batteries.

Incorrect use of batteries may cause leakage or rupture. Always be sure to follow these guidelines:

- Always insert batteries into the battery compartment correctly matching the positive ⊕ and negative ⊖ polarities, as shown by the display inside the compartment.
- Never mix new and used batteries.
- Batteries of the same size may have different voltages, depending on brand. Do not mix different brands of batteries.



CAUTIONS REGARDING HANDLING

Precautions regarding installation

- Placing and using the compact disc player for long periods on heat-generating sources such as amplifiers will affect performance. Avoid placing the player on heat-generating sources.
- Install this compact disc player as far as possible from tuners and TV sets. A compact disc player installed in close proximity to such equipment may cause noise or degradation of the picture.
- Such noise may be particularly noticeable when an indoor antenna is used. In such cases, make use of an outdoor antenna, or turn off power to the compact disc player.
- **Please place this unit on a level surface.**



Cleaning the player

To clean the PLAYER, wipe with a soft, dry cloth. For stubborn dirt, wet a soft cloth with a mild detergent solution made by diluting one part detergent to 5 or 6 parts water, wring well, then wipe off the dirt. Also use a dry cloth to wipe the surface dry. Do not use volatile liquids such as benzene and thinner which are harmful to the unit.

Storing discs

- Discs are made of the same kinds of plastic used for conventional analog audio records. Be careful not to allow discs to warp; always store discs in their cases vertically, avoiding locations with high heat or humidity, or extremely low temperatures. Avoid leaving discs in cars, since the seat of a car in direct sunlight can become unbelievably hot.
- Always read and abide by the precautionary notes listed on disc labels.

CD lens cleaner

The player's pickup lens should not become dirty in normal use, but if for some reason it should malfunction due to soiling, consult your nearest PIONEER authorized service center. Lens cleaners for CD players are commercially available, but special care should be exercised in their use since some may cause damage to the lens.

Cleaning and handling compact discs

- The presence of fingerprints or smudges on the surface of the disc will not directly affect the recorded signals, but depending on the degree of contamination, the brightness of the light reflected from the signal surfaces may be reduced, causing degradation of sound quality. Always keep your discs clean by wiping them gently with a soft cloth from the inner edge toward the outer periphery.

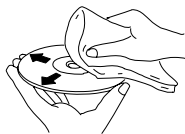

- If a disc becomes very dirty, dip a soft cloth in water, and after wringing it out well, wipe the dirt away gently, and then remove any water drops with another soft, dry cloth.
- Do not use record cleaning sprays or anti-static agents on discs. Also, never clean discs with benzene, thinner, or other volatile solvents, since damage to the disc surface may result.



With this player, use discs which display the mark shown below. (Optical audio digital discs.)



Playing CD-R and CD-RW discs in this CD changer

- This unit can play CD-R and CD-RW discs. However, it may not be possible to play unfinalized discs* which have very little recording time left on them.

* What is finalization?

Finalizing a CD-R or CD-RW disc means making a recorded disc playable on an ordinary CD player. In the case of CD-RWs, the player must be specifically compatible with CD-RW discs for it to play them.

- When holding discs, do not touch their signal surfaces. Hold by the edges, or by one edge and the center hole.
- Do not affix gummed labels or tape to the label surfaces. Also, do not scratch or damage the label.
- Discs rotate at high speed inside the player. Do not use damaged (cracked or warped) discs.
- Do not play a CD with a special shape (having other shape than a circular disc, such as a heart shaped disc). Otherwise malfunction may occur.
- The CD accessories (stabilizer protection sheet, protection ring, etc.) which are marketed for improving the sound quality or protecting discs as well as the disc cleaner should not be used with this system because they may cause malfunction.

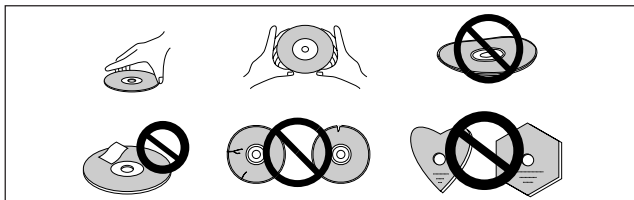

Re-transporting

When transporting this unit in the future, remove all discs from the rack. Turn off the STANDBY/ON switch, wait for "OFF" to go out from the display. Then unplug the power cord.

Precautions concerning use of optical fiber cables

- Fully insert the optical fiber cable plugs all the way into the jacks.
- Be careful not to fold or crimp the cable. When coiling an optical fiber cable for storage, make sure the diameter of the coil is 15 cm (5-14/16 in.) or larger.
- Use an optical fiber cable with a length of 3 m (10 ft.) or less.
- Protect the optical fiber cable plugs from scratches and dust.
- When the unit is not connected using an optical fiber cable, be sure to keep the protective dust cap plugged into the optical digital output jack at all times.

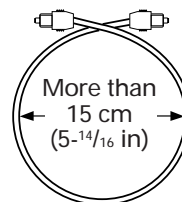



CONNECTIONS

Before making or changing the connections, switch off the power and disconnect the power cord from the AC outlet.

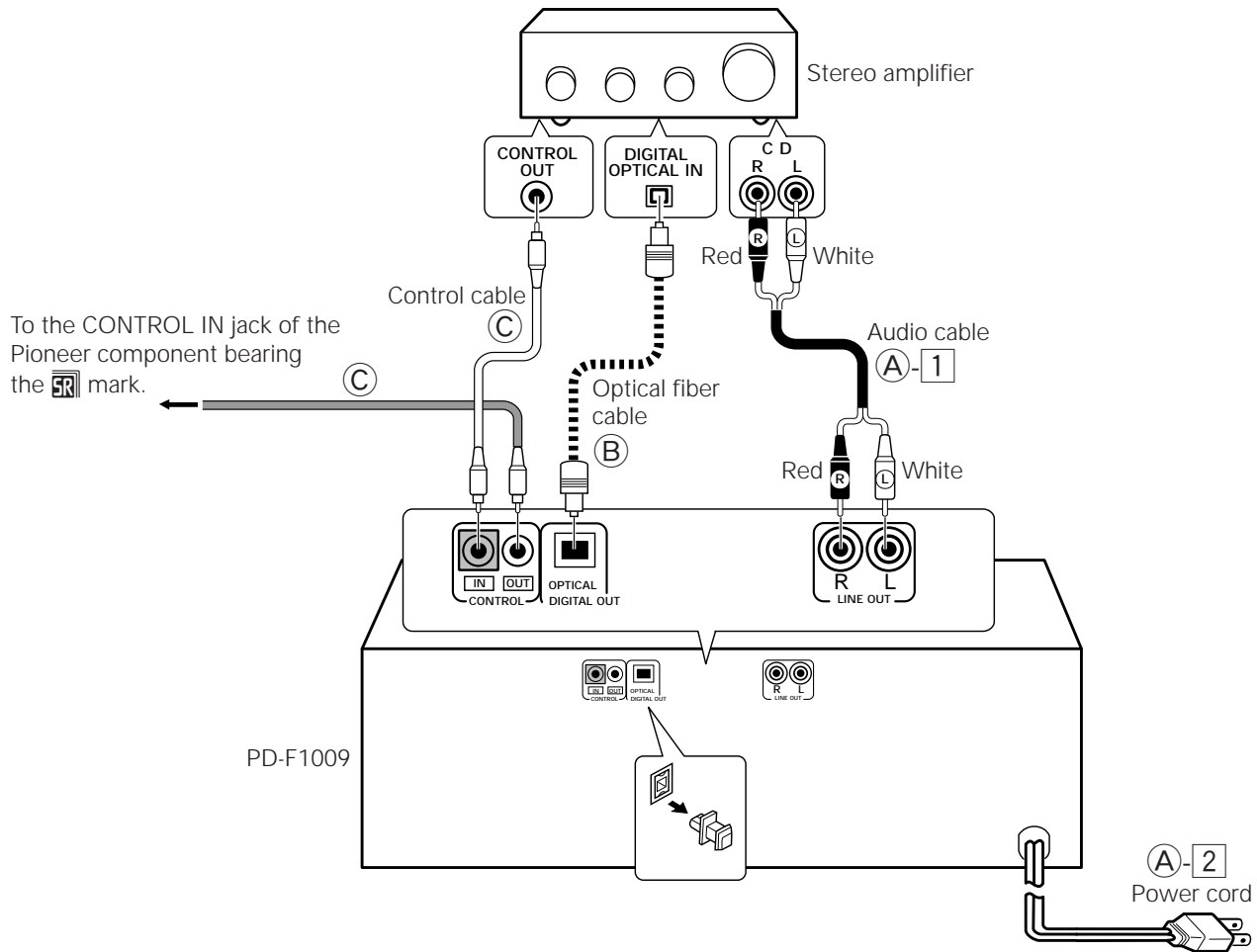

Ⓐ Making connections

- 1 Connect the **LINE OUT** jacks of this unit to the input jacks (CD or AUX) of the amplifier. Make sure that the white plugs are connected to the left (L) jacks and the red plugs to the right (R) jacks.
 - Be sure not to connect this unit to the amplifier's **PHONO** jacks, as sound will be distorted and normal playback will not be possible.
- 2 Connect the power cord to a household AC wall outlet.
 - Make sure plugs are inserted fully into the wall outlet.

Note!!

If you connect the power cord to a "SWITCHED" AC outlet on an amplifier, you will not be able to use this unit's memory function.

Ⓑ Connecting the OPTICAL FIBER CABLE

CD can be played using the digital output. This unit can be connected to an amplifier equipped with an optical digital jack.

1. Remove the protective dust cap from this unit's **OPTICAL DIGITAL OUT** jack.
2. Use an optical fiber cable to connect the **OPTICAL DIGITAL OUT** jack of this unit to the optical input jack of the amplifier.
 - Align the plug of the optical fiber cable with the optical digital jack and fully insert the plug to make a secure connection.

Use a separately sold optical fiber cable for the optical digital jack connections.

Ⓒ System remote control with a Pioneer stereo amplifier that has the SR mark

When a Pioneer stereo amplifier bearing the SR mark is used, connect the **CONTROL IN** jack on the rear panel of the CD player to the **CONTROL OUT** jack of the amplifier. This will enable the CD player to be controlled using the remote control unit supplied with the stereo amplifier. If you do not plan to use this feature, it is not necessary to connect the **CONTROL IN/OUT** jacks.

- The remote control unit supplied with the amplifier can be used to control Play, Stop, Pause, Track/Disc Search and Disc Change operations.
- For instructions regarding connections and operation, refer to the operating instructions provided with your stereo amplifier.

Notes!!

- When a control cable is connected to the player's **CONTROL IN** jack, direct control of the player with the remote control unit is not possible. Operate the player with the remote control unit by aiming it at the amplifier.
- Be sure to connect both of the control cable's plugs securely to the **CONTROL IN** and **CONTROL OUT** jacks. Do not connect only one end of the cable.
- Be sure to turn off the power of the amplifier before connecting the power cord and output cable.
- When only the digital output is connected, the remote sensor of the amplifier does not function. To operate it, connect the output cable to the stereo amplifier as well as connecting the digital output.



NAMES OF PARTS

FRONT PANEL

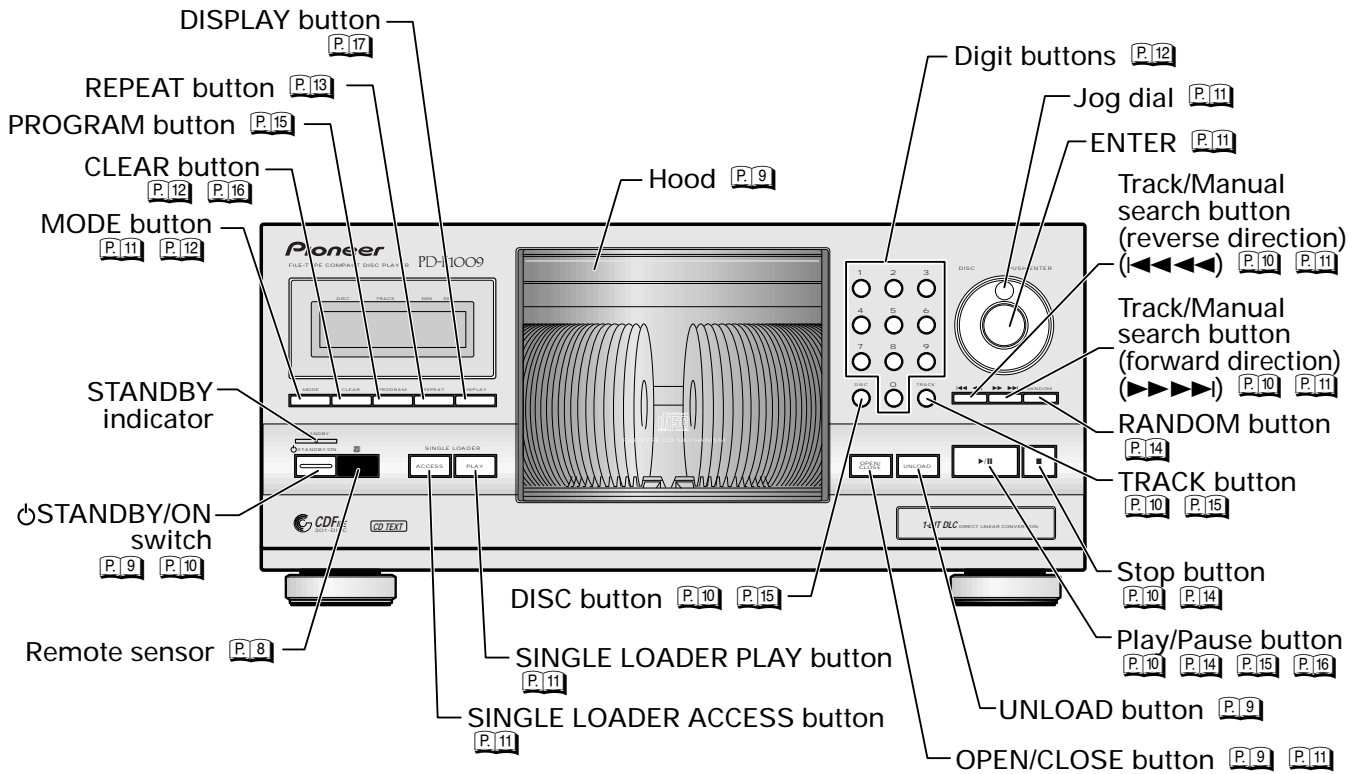

BEFORE OPERATING

DISPLAY

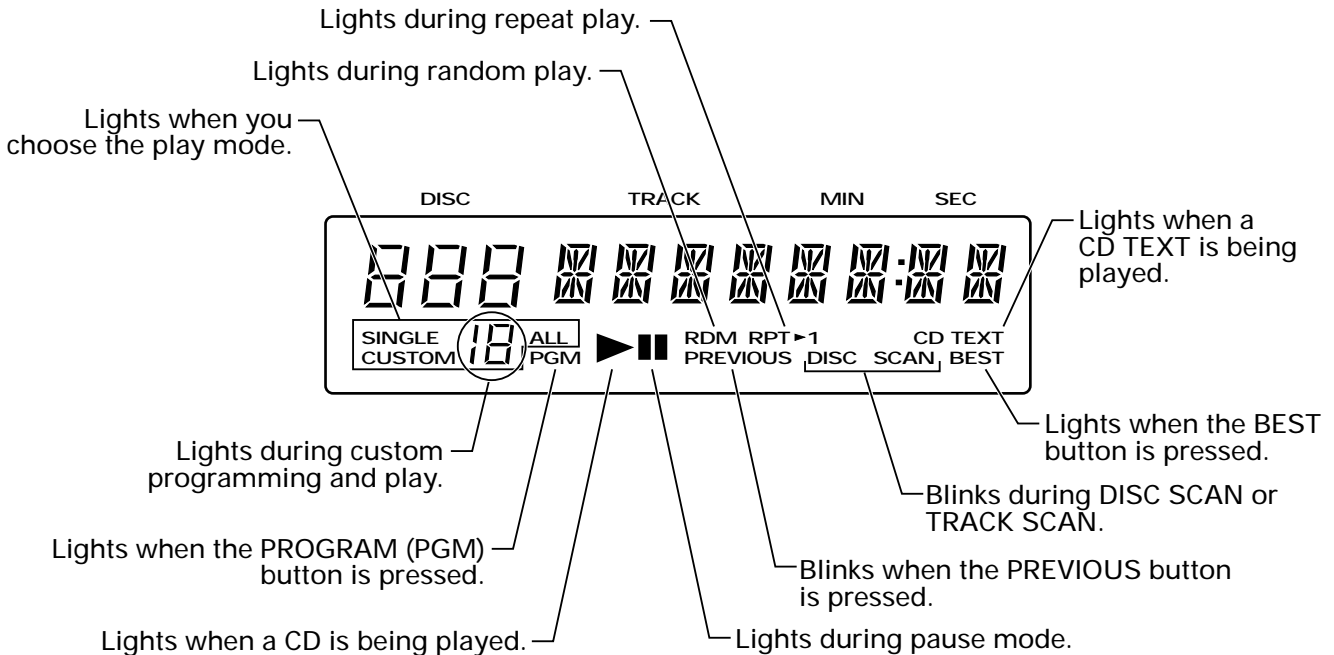



NAMES OF PARTS

REMOTE CONTROL UNIT

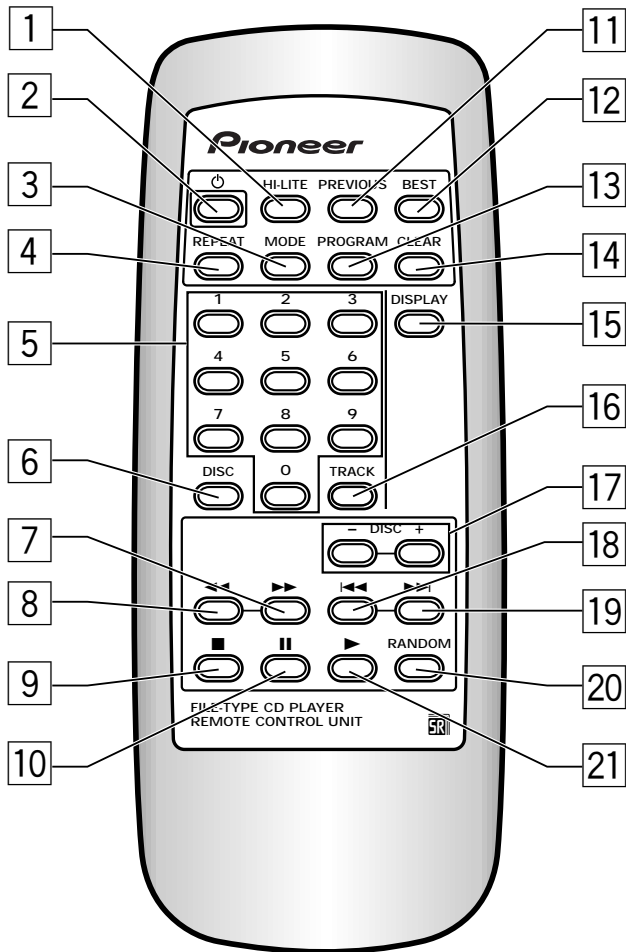

- 1 HI-LITE button [P.17](#)
- 2 STANDBY/ON ϕ button [P.9](#) [P.10](#)
- 3 MODE button [P.11](#) [P.12](#)
- 4 REPEAT button [P.13](#)
- 5 Digit buttons [P.12](#)
- 6 DISC button [P.10](#) [P.15](#)
- 7 Fast forward ($\blacktriangleright\blacktriangleright$) button [P.10](#)
- 8 Fast reverse ($\blacktriangleleft\blacktriangleleft$) button [P.10](#)
- 9 Stop (\blacksquare) button [P.10](#) [P.14](#)
- 10 Pause (\parallel) button [P.10](#)
- 11 PREVIOUS button [P.14](#)
- 12 BEST button [P.13](#)
- 13 PROGRAM button [P.15](#)
- 14 CLEAR button [P.12](#) [P.16](#)
- 15 DISPLAY button [P.17](#)
- 16 TRACK button [P.10](#) [P.15](#)
- 17 DISC (-/+) buttons [P.12](#)
- 18 Skip (reverse) ($\blacktriangleleft\blacktriangleleft$) button [P.10](#) [P.11](#)
- 19 Skip (forward) ($\blacktriangleright\blacktriangleright$) button [P.10](#) [P.11](#)
- 20 RANDOM button [P.14](#)
- 21 Play (\blacktriangleright) button [P.10](#) [P.14](#) [P.15](#) [P.16](#)

REMOTE CONTROL OPERATIONS

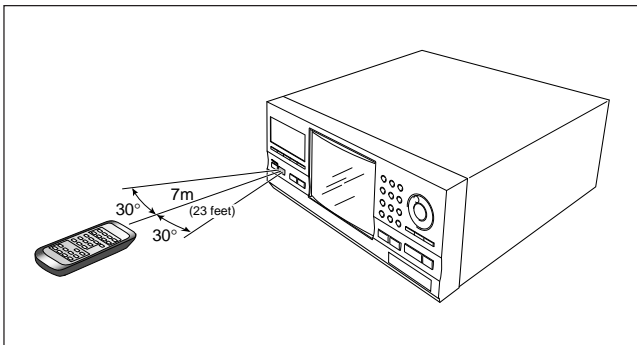

When operating the remote control unit, point the unit's infrared signal transmitter at the remote control receiver (Remote Sensor) on the front panel of the player. The remote control unit can be used within a range of about 7 meters (23 feet) from the remote sensor, and within angles of up to about 30 degrees.

Notes!!

- If the remote control sensor window is in a position where it receives strong light such as sunlight or fluorescent light, control may not be possible.



HOW TO LOAD THE DISCS (Be sure to read this before operation)

Loading discs into the rack

- You can load up to **300 discs** in the rack. The numbers marked on the rack are used as the disc numbers. These are marked in a clockwise order from **1 to 300**.
- The following procedure describes how to load discs from disc No. 1.

1



Press **STANDBY/ON**.



2

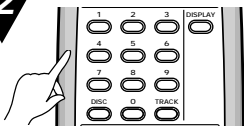

Ensure that the disc No. shown on the display is "1".

If disc number "1" is not displayed, press digit button 1.

(Carry out step 3 within 5 seconds.)

3



Press **UNLOAD**.

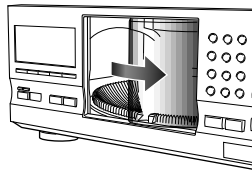

The hood will open. When **UNLOAD** is pressed, the hood opens to the disc corresponding to the disc No. displayed on the front of the unit.

4

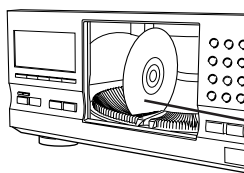

Load the disc into the rack with the label side (printed surface) facing to the right.

Label side faces right.
(Side to be played faces left.)

Note!!

- Inserting more than one disc into the slot will damage the discs and cause the unit to malfunction.

5

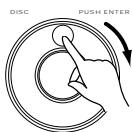

Turn the jog dial clockwise to rotate the rack.

When the jog dial is turned clockwise, the rack turns in the direction in which the disc number increases (1, 2, 3 ...). When turned counterclockwise, the rack turns in the opposite direction.

6

Load other discs into the rack by repeating steps 4 and 5 for each of them.

7



Press **OPEN/CLOSE**.

The hood will close. When the hood closes, the rack is revolved once for disc detection (disc loaded/not loaded detection function).

Tip:

Difference between **OPEN/CLOSE** and **UNLOAD**

OPEN/CLOSE: The hood is simply opened or closed.

UNLOAD: The slot corresponding to the disc No. being displayed rotates to the center position then the hood is opened.

Notes!!

- Do not attempt to open the hood with your hand.
- Be careful not to pinch your fingers when opening and closing the hood.
- If **PLAY** operation (**PLAY**, **BEST**, **Hi-LITE**, **PREVIOUS**) is carried out before disc detection finishes, **PLAY** operation will proceed to without detection. In this case, detection will operate after **PLAY** is finished. Detection may not function properly depending on the color or shape etc., of the disc.

WARNING:

Do not put your hand or any other object inside the rack, otherwise injury or part damage may result.

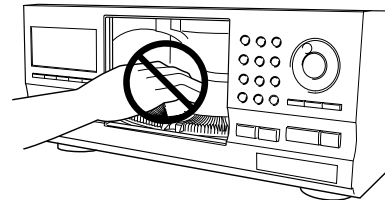

- While changing or inserting discs, be careful not to press any buttons on the main unit or the remote control. The rack may move suddenly, and then your fingers may be caught between discs and the side of door.
- When changing or inserting discs, make sure the rack is stopped. Do not attempt to put a disc in when the rack is moving.
- Do not put anything other than CDs inside the rack.
- Load only one disc into each disc slot.
- Do not apply force to the rack. This can cause a malfunction.
- 8-cm (3-in.) discs cannot be played as they are. First attach the 8-cm (3-in.) disc adapter to each 8-cm (3-in.) disc and load them together in the player.
- Never start playback by placing the 8-cm (3-in.) disc adapter alone, without attaching it to a disc.
- The unit will not operate if the hood is opened during playback. Be sure to close the hood before attempting any operation.
- To load or remove a disc in or from the slot which is seen through the hood, press **OPEN/CLOSE**. The hood is opened, "HOLD" is displayed and the disc can be loaded in or ejected from the slot seen through the hood. Even while "HOLD" is being displayed, the rack can be rotated by pressing **DISC (-/+)**.

To remove the discs...

1 Press **UNLOAD**.

2 Select the number of the disc you want to unload by turning the jog dial or pressing **DISC (-/+)** on the remote control unit.

- The rack rotates until the selected disc comes to the front of the unit.

3 Remove from the rack.

4 Press **OPEN/CLOSE**.

- The hood will close.



BASIC OPERATIONS

- You can also use the remote control.

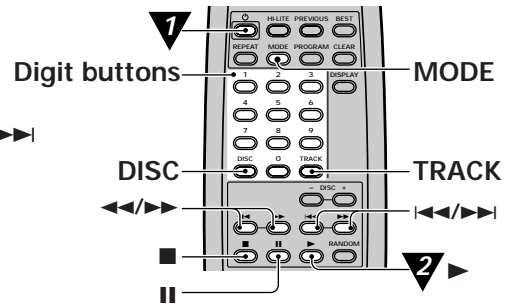
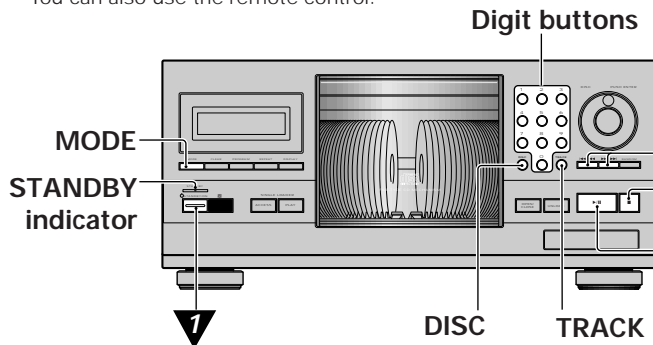

To listen in order from the first track

1 Press **STANDBY/ON**.
To turn the power off ... Press STANDBY/ON again.

2 Press **▶/|| (or ▶)**.
The tracks are played in order starting from the first track on the disc with the lowest disc No.

- If you choose a play mode beforehand, the tracks/discs are played back according to the respective play mode.
- Tips:**
- If you play a CD TEXT disc, the title of the disc being played are shown on the display.
 - During CD TEXT disc playback, the display can be changed by pressing DISPLAY.

To select the disc and track

2 Use the digit buttons to select the disc, then press **DISC**.

7 Use the digit buttons to select the track, and press **TRACK**.

To select a play mode

Press **MODE** during play or stop mode.
Press a few times to choose the mode you desire.
Playback occurs according to the chosen mode.

- ALL** :All discs are played back.
- SINGLE** :One disc is played back.
- CUSTOM** :Only discs stored in the CUSTOM file are played back (1 to 5) (see pages 12 to create a custom file).

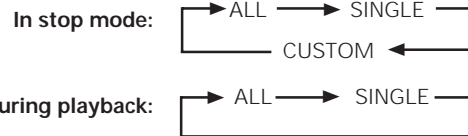

To stop play Press **■**.

To pause play Press **▶/|| (or ||)**.
To start playback again, press **▶/||**.

To skip to another track Tap **◀◀◀/▶▶▶** (or **◀/▶**) on the remote control unit.

To fast forward/reverse. Hold-down **◀◀◀/▶▶▶** (or **◀/▶**) on the remote control unit).

- When you select **SINGLE** during playback, only the current disc will be played.
- If you press **MODE** during program mode, the program contents will be erased.

- Notes!!**
- When you turn the power ON, playback starts according to the last selected play mode.
 - If you did not select a play mode, playback starts in **ALL**.
 - SINGLE** is selected automatically when playing the disc loaded in the Single Loader slot.

<Last disc memory>
When you press **■** or turn the power OFF, the unit memorizes the disc that was being played. The next time you press **▶/||**, playback will start from that same disc. (This feature is available except in the PROGRAM play, BEST play, PREVIOUS scan, HI-LITE scan and RANDOM play modes.)

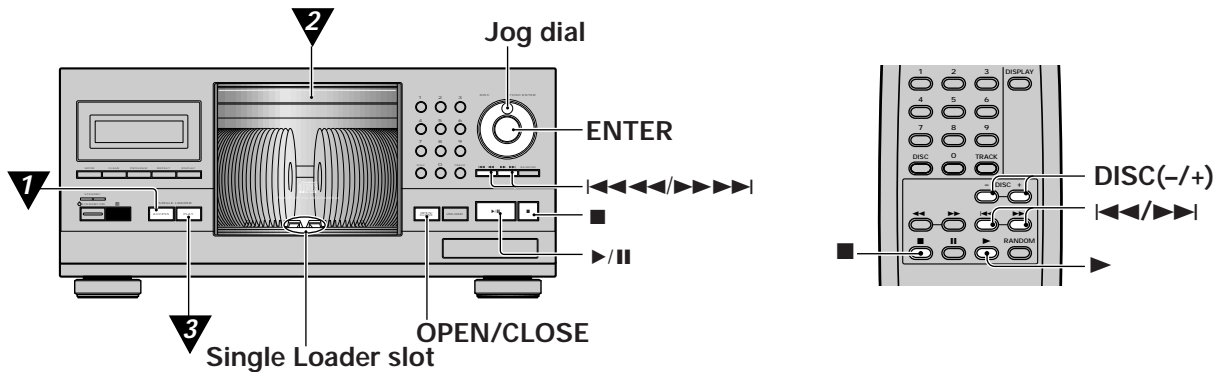

Playing a disc that is not loaded in the rack

Use the single loader slot to play discs that are not loaded in the rack.

1

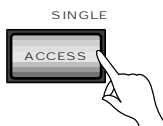

Press **SINGLE LOADER ACCESS**.

- The hood will open with the single loader slot located in the front of the unit.

2

Loading the disc into the Single Loader slot with the label side (printed surface) facing to the right.

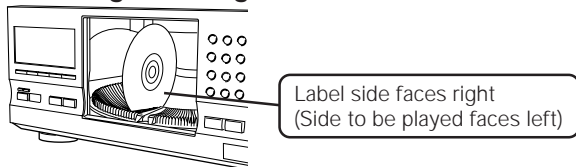

3

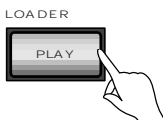

Press **SINGLE LOADER PLAY**.

The play mode is set to SINGLE.

Tips:

- The disc in the single loader slot can also be selected with the **jog dial**. Use the **jog dial** to select the spot after disc number 300 and before disc number 0 (where "P0" is displayed).
- If a disc has been loaded in the Single Loader slot, pressing **SINGLE LOADER PLAY** allows you to play it anytime, even during playback of a disc stored in the rack.
- To play the disc in the Single Loader slot using the remote control unit, press "0" and **DISC**.

To play a track you want to hear

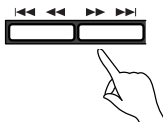

Press **||<<<</>>>>||** during play or pause to choose the track number you desire (or press **||<</>>||** on the remote control).

During pause, press **▶/||** after choosing the track.

To start playback from a specific disc

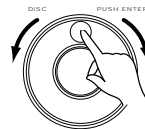

In the player pause, turn the jog dial to select the disc number.

During pause, press **▶/||** or **ENTER** (**▶** on the remote control unit) after choosing the disc.

(To perform this operation from the remote control unit, use the **DISC (-/+)** buttons to select the disc number.)

- Playback starts from the first track of the chosen disc.

Opening or closing the hood during playback

To open the hood during playback



Press the **OPEN/CLOSE** button and hold it in for about 2 seconds.

- "HOLD" is displayed after opening the hood.
- In this case, the rack does not rotate.
- When the playback of the current disc has completed, the unit enters stop mode. The next disc is played after the hood has been closed.

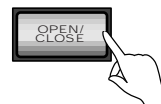

To close the hood, press **OPEN/CLOSE** again.

Note!!

If the hood is opened during play, **UNLOAD** and **SINGLE LOADER ACCESS** function are defeated.



VARIOUS OPERATIONS

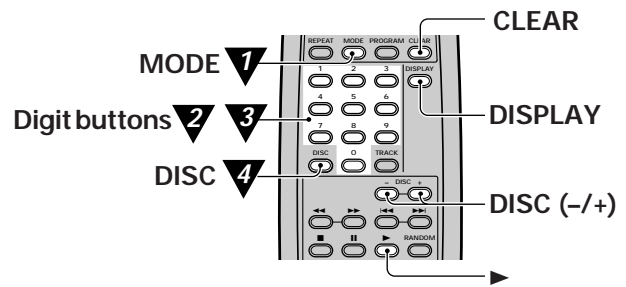
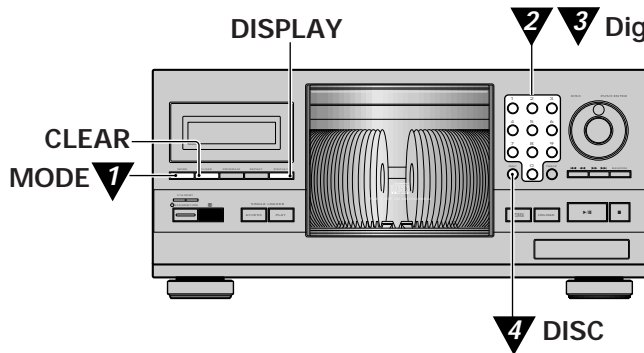

To program and play only the discs you want to hear (CUSTOM play)

This unit lets you program up to 300 of your favorite discs. For example, you can store all the discs of your favorite artist, or some other group of personal selections, and play only those discs. You can even add other discs to the custom later on. Also, there are 5 programmable custom files in which you can program any discs you like.

Operation example : Programming discs 3 and 12 in custom file 5

1

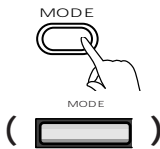

In the stop mode, press the **MODE** button several times to set the custom mode.

2

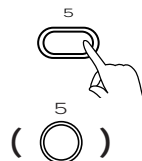

Select the custom number with the digit buttons.

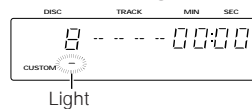

- If some disc number appears, press CLEAR.

3

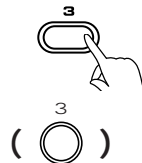

Select the disc number with the remote control unit's digit buttons.



- The disc number can also be selected with DISC (-/+) or the main unit's jog dial. In this case, because custom registration will function after approx. 2 seconds, step 4 is not necessary.

4

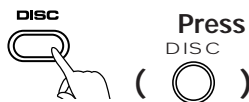

Press **DISC**.

5

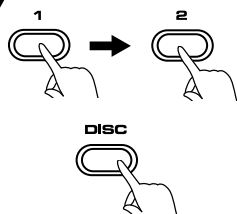

Repeat steps 3 and 4 to store other discs.



To start playback

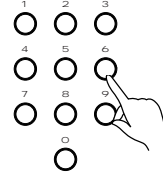

Follow steps 1 and 2 then press ►.

Playback starts from the lowest disc No.

Checking the numbers of the stored discs.

After steps 1 and 2, press **DISPLAY** 3 times. You should see a display like that shown below. Press **DISC(-/+)**. Each time you press **DISC(-/+)**, a disc number stored in the CUSTOM file is displayed. When all the disc numbers have been displayed, the disc number changes to a blank. (To perform this operation on the main unit, turn the jog dial clockwise.)

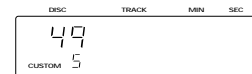

Pressing the front panel's **CLEAR** button during the custom mode will cancel the displayed disc number from the custom file.

- When the **jog dial** is used during custom playback, only the discs stored in the custom file can be selected.
- If you use the **digit** buttons and **DISC** during CUSTOM playback to choose a disc not stored in the CUSTOM file, "NO DISC" will be displayed for approximately 3 seconds.
- When a disc appointed to the CUSTOM file is not loaded in the rack, "NO DISC" is displayed for approximately 3 seconds, the disc is erased from memory, and CUSTOM searches for the next disc.
- The discs stored in the CUSTOM file will not be erased when you turn off the power.



VARIOUS OPERATIONS

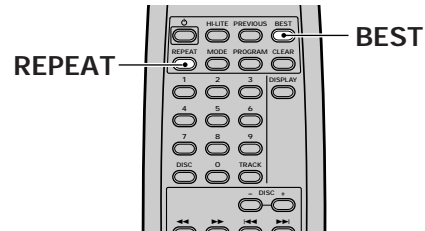
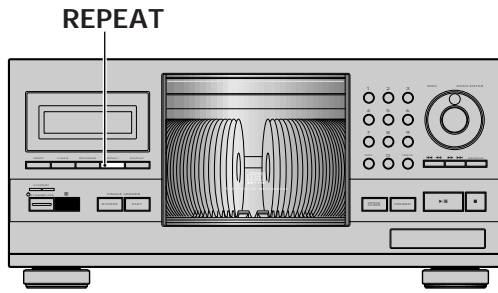

To repeat playback (REPEAT play)

The operation is available only from the remote control unit.

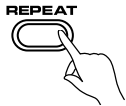

Press the **REPEAT** button during playback. Each time you press the button, the repeat mode changes as follows.



(One track repeat)

Repeats the current or a selected track during play operations other than HI-LITE scan and PREVIOUS scan.

(ALL repeat)

Repeats in one of the following 3 ways according to the play mode.

ALL : Repeats all the tracks on all the discs (1 - 300).

SINGLE : Repeats all the tracks on the selected disc.

CUSTOM : All of the discs classified under one of the 5 CUSTOM banks are played repeatedly.

(OFF)

Cancels repeat play and returns the unit to normal play mode.

- To stop repeat playback, press ■.
- During ALL repeat mode, if the ALL, SINGLE or CUSTOM play mode is not displayed, the currently playing program mode (i.e. PROGRAM play, BEST play, PREVIOUS scan or HI-LITE scan) will be repeated.

To store your favorite tracks (BEST play)

To use the one-touch memory, just press the **BEST** button while playing a track you like. You can store up to 20 tracks.

- The operation is available only from the remote control unit.
- These operations can not be performed on the CD inserted into the SINGLE LOADER SLOT.



Press **BEST** while playing a track you like.

The BEST indicator blinks and the disc and track number are stored in memory.



<To listen to the memorized tracks>



Press **BEST** during stop mode.

The BEST indicator lights and playback starts from the most recently memorized track.

- If you press **CLEAR** during Best playback, the current track is erased and the next track starts to play.
- You cannot memorize a track twice by pressing **BEST** during Best playback.
- If you press **BEST** to memorize a track when 20 tracks are already memorized, the oldest track is erased from memory and the new track is memorized.
- The memorized contents are stored, even when the power is turned off.



VARIOUS OPERATIONS

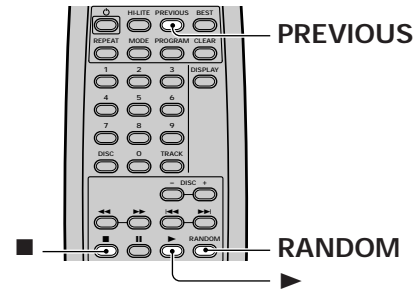
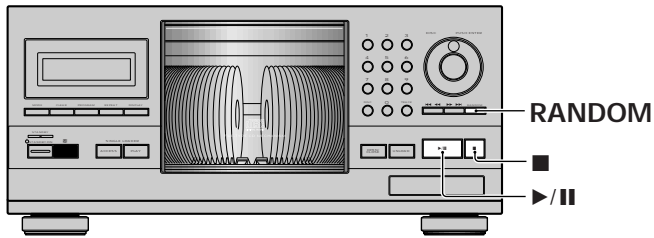

To find out which discs you've listened to recently (PREVIOUS scan)

- This function scans the discs in reverse order, starting from the last disc you played.
- It can remember up to 20 discs. If the total number of discs exceeds 20, the oldest disc will be erased to make room for the new disc.
- The operation is available only from the remote control unit.
- These operations can not be performed on the CD inserted into the SINGLE LOADER SLOT.

Example: If you played discs 1, 2, 9, 12 and 13 in order.

PREVIOUS



Press the PREVIOUS button.

- The unit plays a 10 second portion located one minute into the first track of each disc, starting from the last disc you played: 13, 12, 9, 2, 1.



Blink

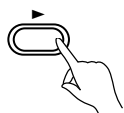

Press ► (►/II) when you reach the disc you want to hear.

- Previous disc scan is canceled and normal play resumes.



- To cancel the scanning, press ■.
- Discs played during random, program, HI-LITE scan, Best and Single Loader playback are not included in the PREVIOUS scan.
- If the first track is less than 1 minute long, the first 10 seconds of the track the beginning will be played. If the first track is less than 10 seconds long, the entire track will be played.

To playback tracks/discs at random (RANDOM play)

RANDOM selects tracks at random from the disc(s) in the current play mode and plays each track once. The selected play mode stops after its contents are played back. (Refer to chart below.)

Play mode selected	Play contents
ALL	Plays all tracks in all discs in a random order.
SINGLE	Plays all the tracks from a single disc at random.
CUSTOM	Plays all tracks in the discs stored in the CUSTOM file in a random order.

RANDOM



Press RANDOM during either play or stop mode.

- The RANDOM indicator lights up and random play according to the current play mode starts.



To stop random play, press ■.

Notes!!

- Random play cannot be activated during the program mode. (If you press **RANDOM** during program play or best play, the program contents will be erased and the unit will start to play tracks at random from all the discs.)
- If you press **REPEAT** during random play, the contents of the random mode are repeated. (RANDOM REPEAT)
- If you press **MODE** during random play, random play is switched to the ALL or SINGLE play.
- If all discs contain no more than 16 tracks, random play can play every track in the discs once.
If any of the discs contain more than 16 tracks, random play plays the same number of tracks as the total number of tracks in the discs, but the tracks with track number 17 or more are not always played once.
- If disc detection has not finished, random play will begin after it has detection has finished.

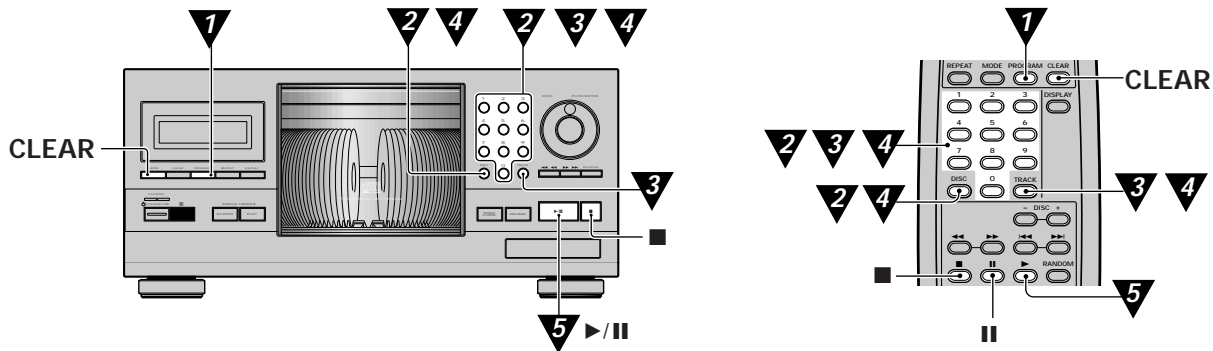

To program tracks/discs in a desired order (PROGRAM play)

- The remote control is the most convenient way to perform these operations.
- You can program up to 36 steps.
- The same operation is possible by pressing the button indicated between parentheses.

Operation example : Programming disc 2, track 7 as step 1, and disc 5, track 3 as step 2.

1 Press PROGRAM during stop mode.

DISC TRACK MIN SEC
1 - 01 - 00:00
PGM

2 Use the digit buttons to select the disc, then press DISC.

DISC TRACK MIN SEC
2 - 01 - P:01
PGM

The PROGRAM indicator starts to blink.

3 Use the digit buttons to select the track, and press TRACK.

DISC TRACK MIN SEC
7 :
PGM

DISC TRACK MIN SEC
2 07 P:01
PGM

4 Repeat steps 2 and 3 to program additional discs and tracks.

Once the track times have been added, the PGM indicator stops blinking and the following display appears (Total Time).

DISC TRACK MIN SEC
P - 02 13:04
PGM

5 Press ►.

The program play starts from the track that was programmed first.

The following operations can only be performed during normal play, HI-LITE scan or PREVIOUS scan

<Programming tracks during normal play> (Direct program)

1. Press PROGRAM.
 - Program mode is activated.
2. Press PROGRAM during playback.
 - The current track is programmed.

<Programming during normal playback> (Preprogramming)

You can program during normal playback.

(→ Operation example 1 2 3 4)

- The player changes to program play when the current track finishes playing back.
- To change to program mode directly, press ►.

The following operations can only be performed during stop mode

<Programming an entire disc as one step> (Disc all program)

If you skip step 3 of the operation example, disc 2 is programmed as step 1.



VARIOUS OPERATIONS

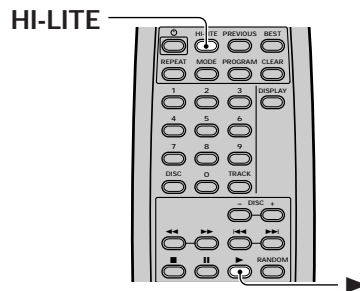

<Programming a pause (remote control only)> (Pause program)

If you press **II** at step **4**, you can program a pause. When you press **II**, "PA" appears in the display instead of the disc number.

- For example, when making a program for recording both sides of a cassette tape, press **II** to insert a pause after programming the tracks for one side. After turning the tape over, press **II** to resume recording.

Notes!!

- You cannot program a pause as the first step, nor program two pauses in a row.
- When you program a pause, it counts as 1 step and reduces the total number of tracks you can program.

To erase a program...

Press **■** twice during playback (or once in stop mode). You can also erase the program by pressing **MODE**, **RANDOM**, **PREVIOUS**, or **SINGLE LOADER PL1AY** in either play or stop mode (or by pressing **BEST** in stop mode).

To cancel a program step

- In stop mode, each time you press **CLEAR**, the last step in the program is erased.
 - If a programmed disc is missing or inserted backwards during program play, "NO DISC" appears in the display, the step is automatically erased, and playback proceeds to the next step.
 - Program contents are stored in memory even when the power is turned off.
- Press the **DISPLAY** twice to check the number of steps that have been programmed.



This indicates the number of programmed steps.

Notes!!

- If step **5** is carried out before the accumulated time is displayed, the program play starts and the time is not displayed.
- When UNLOAD is pressed while a program has been entered, the disc for the 1st program step comes on the center position and the hood opens.
- The display is not shown if the total time of the program is 100 minutes or more.

To scan quickly through tracks on a disc (HI-LITE scan)

- The operation is available only from the remote control unit.

This function plays a 10 second portion located 1 minute from the start of each track on all the discs in the current play mode.

<Disc scan>



Press once

Press HI-LITE during either play or stop mode.

- The unit plays a 10 second portion located 1 minute into the first track of each CD, starting from the first CD.

The "DISC" and "SCAN" indicator blinks.

<Track scan>



Press twice

Press HI-LITE twice during either play or stop mode.

- The unit plays a 10 second portion located 1 minute into each track of each CD, starting from the first CD.

The "SCAN" indicator blinks.

<Program scan> Press HI-LITE during program mode.



Press once

- The unit plays a 10 second portion located 1 minute into each track in the program.

The "SCAN" indicator blinks.

<Best selection memory scan>



Press once

Press HI-LITE during best selection memory playback.

- The unit plays a 10 second portion located 1 minute into each track in the best selection memory.

The "SCAN" indicator blinks.

<To return to normal playback>

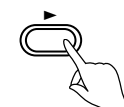

Press **▶** (or **▶/II**) when you reach the track you want to hear.

HI-LITE scan is canceled and normal play resumes.

- To cancel HI-LITE scan, press **■**.



VARIOUS OPERATIONS

DISPLAY

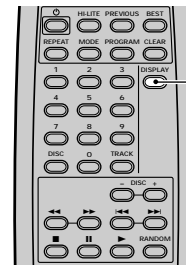
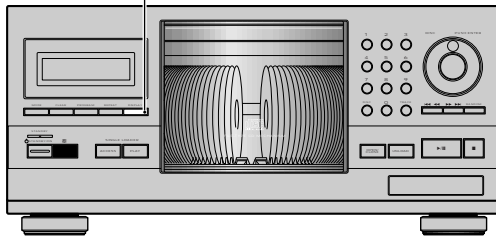

DISPLAY

Notes!!

- You can use **⏮**/**⏭** to skip to another track during track scan.
- If the player is in ALL REPEAT mode, the HI-LITE scan will repeat.
- If the track is less than 1 minute long, the first 10 seconds of the track will be played. If the track is less than 10 seconds long, the entire track will be played.

- * When playing a disc containing CD TEXT, the disc title appears after the elapsed time display.

(Example: BEETHOVEN SYMPHONY)



When the CD TEXT disc starts to be played, the disc title scrolls on the display.

(The scrolled title can consist up to 60 characters.)

- The top 8 characters of the title are shown in stop mode.

To use the DISPLAY button

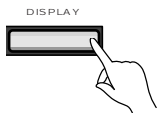

Press DISPLAY during playback.

Each time you press **DISPLAY**, the display changes as follows.

Disc number, Track number and Elapsed Time. *

↓

Remaining time (TRACK)

↓

Remaining time (DISC)

↓

Total time (TOTAL)

Characters that can be shown in the title display

- Alphabet (Lowercase letters are converted into uppercase.)
A B C D E F G H I J K L M N O P Q R S T U V W X Y Z
 - Numerals and symbols
0 1 2 3 4 5 6 7 8 9 - + / \ | X _ (Space)
- Other symbols than the above are shown as (Space).

Notes!!

- Time remaining on the track may not be displayed for tracks numbered greater than 24.
- Time remaining on the disc is not displayed during RANDOM, PROGRAM or BEST play.
- During PROGRAM play

Disc number, Track number and Elapsed Time. *

↓

Remaining time (TRACK)

↓

Total program time and number of steps (TOTAL)

- During BEST play

Disc number, Track number and Elapsed Time. *

↓

Remaining time (TRACK)

↓

Total number of steps memorized in BEST (TOTAL)



TROUBLESHOOTING

Incorrect operations are often mistaken for trouble and malfunctions. If you think that there is something wrong with this component, check the points below. Sometimes the trouble may lie in another component. Investigate the other components and electrical appliances being used. If the trouble cannot be rectified even after exercising the checks listed below, ask your nearest PIONEER authorized service center or your dealer to carry out repair work.

Symptom	Cause	Remedy
No sound	<ul style="list-style-type: none"> Output cables are connected incorrectly or loosely. Incorrect operation of stereo amplifier. Pin plugs and/or amplifier terminals are dirty. Player is in pause mode. The disc is loaded with the label side leftward. 	<ul style="list-style-type: none"> Connect properly. Check the settings of amplifier switches and sound volume controls. Clean away dirt. Press ► or II. Reload the disc with the label side rightward.
When playback is started, it stops immediately. Pauses or stops during playback.	<ul style="list-style-type: none"> Disc is inserted in the wrong way. Smudges, etc., on the disc. 	<ul style="list-style-type: none"> Insert the disc correctly with the label side leftward. Clean the smudges from the disc and then play it again.
Remote control will not function.	<ul style="list-style-type: none"> Dead batteries. Obstruction between player and remote control unit. 	<ul style="list-style-type: none"> Replace batteries. Relocate remote control unit or remove obstruction.

Abnormal functioning of this unit may be caused by static electricity, or other external interference. To restore normal operation unplug the AC power cord and then plug it in again.

SELF-DIAGNOSTICS FUNCTION

The unit incorporates the self-diagnostic function.

When an abnormality is detected during operation of the unit, an error message (service No.) appears on the unit's display automatically. Treat the error by following the instructions in "Countermeasures".

Display on the unit



Service No.	Unit Status	Countermeasures
U1	The disc may not be loaded properly in the rack.	<ul style="list-style-type: none"> Reload the discs properly. (Insert only one disc in a slot.) Check if there is a foreign object attached onto the disc. Check if there is a foreign object in the rack.
U2	There is an operation error in the mechanical section.	<ul style="list-style-type: none"> Check if there is a foreign object in the rack. Unplug the power cord then plug it in again.
U3	There is an error related to the hood.	<ul style="list-style-type: none"> Check if the hood is caught by anything. Unplug the power cord then plug it in again.

If the same display appears again, there may be an error in the mechanical section. When requesting servicing, please also let us know the service number displayed on the unit.



SPECIFICATIONS

1. General

Type Compact disc digital audio system
 Power requirements AC 120V, 60 Hz
 Power consumption 12 W
 Power consumption in standby mode 1 W
 Operating temperature +5°C – +35°C
 (+41°F – +95°F)
 Weight (without package) 7.5 kg (16 lb 9 oz.)
 External dimensions 420(W) X 433(D) X 193(H) mm
 (16-9/16(W) X 17-1/16(D) X 7-5/8(H) in.)

2. Audio section

Frequency response 2 Hz - 20 kHz
 S/N ratio 98 dB or more (EIAJ)
 Dynamic range 96 dB or more (EIAJ)
 Harmonic distortion 0.003 % or less (EIAJ)
 Level difference between channels 1.0 dB or less (EIAJ)
 Output voltage 2 Vrms (EIAJ)
 Wow and flutter less than ±0.001 % (W.PEAK)
 (below measurable level) (EIAJ)
 Channels 2-channel (stereo)

3. Input/Output terminal

Audio line output
 Control input/output jacks
 Optical digital output jack

4. Accessories

- Remote control unit 1
- Size AA/R6P dry cell batteries 2
- Audio cable 1
- Control cable 1
- Warranty card 1
- Operating instructions 1

Note!!

Specifications and design subject to possible modification without notice, due to improvements.

POWER-CORD CAUTION

Handle the power cord by the plug. Do not pull out the plug by tugging the cord and never touch the power cord when your hands are wet as this could cause a short circuit or an electric shock. Do not place the unit, a piece of furniture, etc., on the power cord, or pinch the cord. Never make a knot in the cord or tie it with other cords. The power cords should be routed such that they are not likely to be stepped on. A damaged power cord can cause a fire or give you an electrical shock. Check the power cord once in a while. When you find it damaged, ask your nearest PIONEER authorized service center or your dealer for a replacement.



Dear Customer:

Selecting fine audio equipment such as the unit you've just purchased is only the start of your musical enjoyment. Now it's time to consider how you can maximize the fun and excitement your equipment offers. This manufacturer and the Electronic Industries Association's Consumer Electronics Group want you to get the most out of your equipment by playing it at a safe level. One that lets the sound come through loud and clear without annoying blaring or distortion-and, most importantly, without affecting your sensitive hearing.

Sound can be deceiving. Over time your hearing "comfort level" adapts to higher volumes of sound. So what sounds "normal" can actually be loud and harmful to your hearing. Guard against this by setting your equipment at a safe level BEFORE your hearing adapts.

To establish a safe level:

- Start your volume control at a low setting.
- Slowly increase the sound until you can hear it comfortably and clearly, and without distortion.

Once you have established a comfortable sound level:

- Set the dial and leave it there.

Taking a minute to do this now will help to prevent hearing damage or loss in the future. After all, we want you listening for a lifetime.

We Want You Listening For A Lifetime

Used wisely, your new sound equipment will provide a lifetime of fun and enjoyment. Since hearing damage from loud noise is often undetectable until it is too late, this manufacturer and the Electronic Industries Association's Consumer Electronics Group recommend you avoid prolonged exposure to excessive noise. This list of sound levels is included for your protection.

Decibel

Level	Example
30	Quiet library, soft whispers
40	Living room, refrigerator, bedroom away from traffic
50	Light traffic, normal conversation, quiet office
60	Air conditioner at 20 feet, sewing machine
70	Vacuum cleaner, hair dryer, noisy restaurant
80	Average city traffic, garbage disposals, alarm clock at two feet.

THE FOLLOWING NOISES CAN BE DANGEROUS UNDER CONSTANT EXPOSURE

90	Subway, motorcycle, truck traffic, lawn mower
100	Garbage truck, chain saw, pneumatic drill
120	Rock band concert in front of speakers, thunderclap
140	Gunshot blast, jet plane
180	Rocket launching pad

Information courtesy of the Deafness Research Foundation.



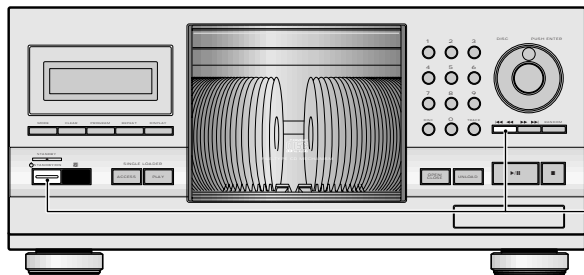

POWER ON DEMO display

POWER ON DEMO display mode allows you to see variations of the display. To enter the POWER ON DEMO display mode, press POWER and then ◀◀ within 1 second after turning on the power.
To cancel the POWER ON DEMO display mode, press any button.

Should this product require service in the U.S.A. and you wish to locate the nearest Pioneer Authorized Independent Service Company, or if you wish to purchase replacement parts, operating instructions, service manuals, or accessories, please call the number shown below.

8 0 0 - 4 2 1 - 1 4 0 4

Please do not ship your product to Pioneer without first calling the Customer Service Department at the above listed number for assistance.

PIONEER ELECTRONICS SERVICE, INC.
CUSTOMER SERVICE DEPARTMENT
P.O. BOX 1760, LONG BEACH,
CA 90801-1760, U.S.A.

For warranty information please see the Limited Warranty sheet included with your product.

Should this product require service in Canada, please contact a Pioneer Canadian Authorized Dealer to locate the nearest Pioneer Authorized Service Company in Canada.
Alternatively, please contact the Customer Service Department at the following address:

Pioneer Electronics of Canada, Inc.
Customer Service Department
300 Allstate Parkway, Markham, Ontario
L3R OP2
(905) 479-4411
1-877-283-5901

For warranty information please see the Limited Warranty sheet included with your product.

Si ce produit doit être réparé au Canada, veuillez vous adresser à un distributeur autorisée Pioneer au Canada pour obtenir le nom de la Société de Service Autorisée Pioneer le plus près de chez vous. Ou encore, veuillez communiquer avec le Service de Clientèle de Pioneer:

Pioneer électroniques du Canada, Inc.
Département de service aux consommateurs
300 Allstate Parkway, Markham, Ontario
L3R OP2
(905) 479-4411
1-877-283-5901

Pour obtenir des renseignements sur la garantie, veuillez vous reporter au feuillet sur la Garantie Limitée qui accompagne le produit.

Published by Pioneer Corporation.
Copyright © 1999 Pioneer Corporation.
All rights reserved.

PIONEER CORPORATION

4-1, Meguro 1-Chome, Meguro-ku, Tokyo 153-8654, Japan

PIONEER ELECTRONICS [USA] INC. P.O. BOX 1540, Long Beach, California 90801-1540, U.S.A.

PIONEER ELECTRONICS OF CANADA, INC. 300 Allstate Parkway, Markham, Ontario L3R OP2, Canada

PIONEER ELECTRONIC [EUROPE] N.V. Haven 1087, Keetberglaan 1, 9120 Melsele, Belgium TEL: 03/570.05.11

PIONEER ELECTRONICS AUSTRALIA PTY. LTD. 178-184 Boundary Road, Braeside, Victoria 3195, Australia, TEL: [03] 9586-6300

PIONEER ELECTRONICS DE MEXICO S.A. DE C.V. San Lorenzo Num 1009 3er piso Desp. 302 Col. Del Valle, Mexico D.F. C.P. 03100 TEL: 5-688-52-90

Free Manuals Download Website

<http://myh66.com>

<http://usermanuals.us>

<http://www.somanuals.com>

<http://www.4manuals.cc>

<http://www.manual-lib.com>

<http://www.404manual.com>

<http://www.luxmanual.com>

<http://aubethermostatmanual.com>

Golf course search by state

<http://golfingnear.com>

Email search by domain

<http://emailbydomain.com>

Auto manuals search

<http://auto.somanuals.com>

TV manuals search

<http://tv.somanuals.com>