

Pioneer

ELITE

**AUDIO/VIDEO
MULTI-CHANNEL RECEIVER**

VSX-21

Operating Instructions

Thank you for buying this Pioneer product.
Please read through these operating instructions so you will know how to operate your model properly. After you have finished reading the instructions, put them away in a safe place for future reference.

IMPORTANT NOTICE

The serial number for this equipment is located on the rear panel. Please write this serial number on your enclosed warranty card and keep it in a secure area. This is for your security.

WARNING: TO PREVENT FIRE OR SHOCK HAZARD, DO NOT EXPOSE THIS APPLIANCE TO RAIN OR MOISTURE.

THE POWER SWITCH IS SECONDARY CONNECTED AND THEREFORE DOES NOT SEPARATE THE UNIT FROM MAINS POWER IN THE STANDBY POSITION.

[For Canadian model]

CAUTION: TO PREVENT ELECTRIC SHOCK DO NOT USE THIS (POLARIZED) PLUG WITH AN EXTENSION CORD, RECEPTACLE OR OTHER OUTLET UNLESS THE BLADES CAN BE FULLY INSERTED TO PREVENT BLADE EXPOSURE.

ATTENTION: POUR PREVENIR LES CHOCES ELECTRIQUES NE PAS UTILISER CETTE FICHE POLARISEE AVEC UN PROLONGATEUR, UNE PRISE DE COURANT OU UNE AUTRE SORTIE DE COURANT, SAUF SI LES LAMES PEUVENT ETRE INSEREES A FOND SANS EN LAISSER AUCUNE PARTIE A DECOUVERT.

IMPORTANT



The lightning flash with arrowhead symbol, within an equilateral triangle, is intended to alert the user to the presence of uninsulated "dangerous voltage" within the product's enclosure that may be of sufficient magnitude to constitute a risk of electric shock to persons.

CAUTION

**RISK OF ELECTRIC SHOCK
DO NOT OPEN**

CAUTION:
TO PREVENT THE RISK OF ELECTRIC SHOCK, DO NOT REMOVE COVER (OR BACK). NO USER-SERVICEABLE PARTS INSIDE. REFER SERVICING TO QUALIFIED SERVICE PERSONNEL.



The exclamation point within an equilateral triangle is intended to alert the user to the presence of important operating and maintenance (servicing) instructions in the literature accompanying the appliance.

This equipment has been tested and found to comply with the limits for a Class B digital device, pursuant to Part 15 of the FCC Rules. These limits are designed to provide reasonable protection against harmful interference in a residential installation. This equipment generates, uses, and can radiate radio frequency energy and, if not installed and used in accordance with the instructions, may cause harmful interference to radio communications. However, there is no guarantee that interference will not occur in a particular installation. If this equipment does cause harmful interference to radio or television reception, which can be determined by turning the equipment off and on, the user is encouraged to try to correct the interference by one or more of the following measures:

- Reorient or relocate the receiving antenna.
- Increase the separation between the equipment and receiver.
- Connect the equipment into an outlet on a circuit different from that to which the receiver is connected.
- Consult the dealer or an experienced radio/TV technician for help.

Information to User

Alteration or modifications carried out without appropriate authorization may invalidate the user's right to operate the equipment.

IMPORTANT SAFETY INSTRUCTIONS

READ INSTRUCTIONS — All the safety and operating instructions should be read before the product is operated.

RETAIN INSTRUCTIONS — The safety and operating instructions should be retained for future reference.

HEED WARNINGS — All warnings on the product and in the operating instructions should be adhered to.

FOLLOW INSTRUCTIONS — All operating and use instructions should be followed.

CLEANING — Unplug this product from the wall outlet before cleaning. The product should be cleaned only with a polishing cloth or a soft dry cloth. Never clean with furniture wax, benzine, insecticides or other volatile liquids since they may corrode the cabinet.

ATTACHMENTS — Do not use attachments not recommended by the product manufacturer as they may cause hazards.

WATER AND MOISTURE — Do not use this product near water — for example, near a bathtub, wash bowl, kitchen sink, or laundry tub; in a wet basement; or near a swimming pool; and the like.

ACCESSORIES — Do not place this product on an unstable cart, stand, tripod, bracket, or table. The product may fall, causing serious injury to a child or adult, and serious damage to the product. Use only with a cart, stand, tripod, bracket, or table recommended by the manufacturer, or sold with the product. Any mounting of the product should follow the manufacturer's instructions, and should use a mounting accessory recommended by the manufacturer.

CART — A product and cart combination should be moved with care. Quick stops, excessive force, and uneven surfaces may cause the product and cart combination to overturn.



VENTILATION — Slots and openings in the cabinet are provided for ventilation and to ensure reliable operation of the product and to protect it from overheating, and these openings must not be blocked or covered. The openings should never be blocked by placing the product on a bed, sofa, rug, or other similar surface. This product should not be placed in a built-in installation such as a bookcase or rack unless proper ventilation is provided or the manufacturer's instructions have been adhered to.

POWER SOURCES — This product should be operated only from the type of power source indicated on the marking label. If you are not sure of the type of power supply to your home, consult your product dealer or local power company.

LOCATION — The appliance should be installed in a stable location.

NONUSE PERIODS — The power cord of the appliance should be unplugged from the outlet when left unused for a long period of time.

GROUNDING OR POLARIZATION

- If this product is equipped with a polarized alternating current line plug (a plug having one blade wider than the other), it will fit into the outlet only one way. This is a safety feature. If you are unable to insert the plug fully into the outlet, try reversing the plug. If the plug should still fail to fit, contact your electrician to replace your obsolete outlet. Do not defeat the safety purpose of the polarized plug.

- If this product is equipped with a three-wire grounding type plug, a plug having a third (grounding) pin, it will only fit into a grounding type power outlet. This is a safety feature. If you are unable to insert the plug into the outlet, contact your electrician to replace your obsolete outlet. Do not defeat the safety purpose of the grounding type plug.

POWER-CORD PROTECTION — Power-supply cords should be routed so that they are not likely to be walked on or pinched by items placed upon or against them, paying particular attention to cords at plugs, convenience receptacles, and the point where they exit from the product.

OUTDOOR ANTENNA GROUNDING — If an outside antenna or cable system is connected to the product, be sure the antenna or cable system is grounded so as to provide some protection against voltage surges and built-up static charges. Article 810 of the National Electrical Code, ANSI/NFPA 70, provides information with regard to proper grounding of the mast and supporting structure, grounding of the lead-in wire to an antenna discharge unit, size of grounding conductors, location of antenna-discharge unit, connection to grounding electrodes, and requirements for the grounding electrode. See Figure A.

LIGHTNING — For added protection for this product during a lightning storm, or when it is left unattended and unused for long periods of time, unplug it from the wall outlet and disconnect the antenna or cable system. This will prevent damage to the product due to lightning and power-line surges.

POWER LINES — An outside antenna system should not be located in the vicinity of overhead power lines or other electric light or power circuits, or where it can fall into such power lines or circuits. When installing an outside antenna system, extreme care should be taken to keep from touching such power lines or circuits as contact with them might be fatal.

OVERLOADING — Do not overload wall outlets, extension cords, or integral convenience receptacles as this can result in a risk of fire or electric shock.

OBJECT AND LIQUID ENTRY — Never push objects of any kind into this product through openings as they may touch dangerous voltage points or short-out parts that could result in a fire or electric shock. Never spill liquid of any kind on the product.

SERVICING — Do not attempt to service this product yourself as opening or removing covers may expose you to dangerous voltage or other hazards. Refer all servicing to qualified service personnel.

DAMAGE REQUIRING SERVICE — Unplug this product from the wall outlet and refer servicing to qualified service personnel under the following conditions:

- When the power-supply cord or plug is damaged.
- If liquid has been spilled, or objects have fallen into the product.
- If the product has been exposed to rain or water.
- If the product does not operate normally by following the operating instructions. Adjust only those controls that are covered by the operating instructions as an improper adjustment of other controls may result in damage and will often require extensive work by a qualified technician to restore the product to its normal operation.
- If the product has been dropped or damaged in any way.
- When the product exhibits a distinct change in performance — this indicates a need for service.

REPLACEMENT PARTS — When replacement parts are required, be sure the service technician has used replacement parts specified by the manufacturer or have the same characteristics as the original part. Unauthorized substitutions may result in fire, electric shock, or other hazards.

SAFETY CHECK — Upon completion of any service or repairs to this product, ask the service technician to perform safety checks to determine that the product is in proper operating condition.

WALL OR CEILING MOUNTING — The product should not be mounted to a wall or ceiling.

HEAT — The product should be situated away from heat sources such as radiators, heat registers, stoves, or other products (including amplifiers) that produce heat.

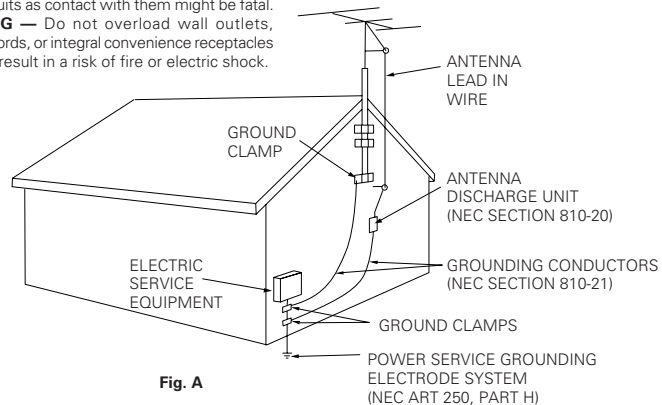

Fig. A

NEC — NATIONAL ELECTRICAL CODE

Features

DTS (Digital Theater Systems) decoder equipped

DTS is a digital sound system introduced in theaters. Playback of DVD, LD, and CD recorded in DTS audio creates the environment of a theater or the sensation of a concert hall in your home.

*"DTS" and "DTS Digital Surround" are trademarks of Digital Theater Systems, Inc.
Manufactured under licence from Digital Theater Systems, Inc.*

Dolby Digital and Dolby Pro Logic

No need to worry about program formats! When playing Dolby Digital or Dolby Pro Logic software in the  (Dolby) mode, decoding switches automatically according to the input signal. All you have to do is sit back and enjoy! (When connecting a DVD/LD player or LD player using the AC-3 RF output, a commercially available RF demodulator (RFD-1) is required.)

Manufactured under license from Dolby Laboratories. "Dolby", "AC-3", "Pro Logic", " and double-D symbol are trademarks of Dolby Laboratories. Confidential Unpublished Works. © 1992 - 1997 Dolby Laboratories, Inc. All rights reserved.

CINEMA Re-EQ

In a theater the room is very large and dead sounding, you sit a long way back from the speaker and the speakers themselves are very specialized. Because a soundtrack recorded in this dead sounding space when it is played at home it sounds overbright. THX Re-Equalization adjusts for this difference in a very precise way.

ADVANCED THEATER modes

Four sound modes that enhance DTS and Dolby audio performance by simulating the environment of a movie theater (DRAMA, ACTION), or the ambience of a concert hall (MUSICAL). With 5-D THEATER, you can enjoy Dolby Pro Logic encoded software in simulated Dolby Digital.

Various Surround Effects (DSP)

The DSP (Digital Signal Processing) surround mode allows you to transform your living room into six different sonic environments when listening to music or watching movies.

Midnight Listening Mode

When late night hours or other factors require that the volume be kept low, the surround effects may tend to become less than satisfactory. When the midnight listening mode is on, you can enjoy the effects of quality surround sound even at low volumes.

Optical Digital Output

The digital signal input can be directly output to digital recording components such as MD, DAT and CD-R from the optical digital output jack to create digital recordings.

DIGITAL NR function

Noise in the playback source can be reduced to a minimum so you can enjoy a clearer sound.

5.1 Channel Input

By connecting components equipped with 5.1 channel output to the DVD 5.1 channel input on this unit, you can enjoy 5.1 channel surround sound. Connections can be made to a DVD player or Multi channel decoder equipped with 5.1 channel analog output jacks.

5 Channels of Independent Amplification

This receiver incorporates 5 independent 100 watt power amplifiers which enable high quality playback of Dolby Digital and DTS surround sound. This construction provides improved linearity and accurate reproduction of each channel for true high fidelity reproduction from even the most demanding Dolby Digital program sources.

Remote Control of Other Components

The supplied remote control can be used to operate a variety of other components simply by recalling the appropriate preset code. In addition, the multi-operation functions allow you to perform a variety of operations automatically.

The Energy-saving Design

This unit is designed to use minimal electricity when power is switched OFF (during Standby). Regarding the value of the power consumption in standby mode, refer to "Specifications" on page 57.

Introductory Information	6
Checking the Supplied Accessories	6
How to Use This Manual	6
Preparing the Remote Control	6
Receiver Installation	7
When Making Cable Connections	7
Connections	8
Antennas	8
Audio Components Connections	9
Video Components Connections	10
Digital Connections	11
DVD 5.1 Channel Connection	12
Speakers	13
Preparations	16
Setting Up for Surround Sound	16
Setting Up the Remote Control	22
Clearing the Remote Control Settings	23
Names of Parts and Basic Operations	24
Display	24
Remote Control	25
Front Panel	26
Sound Modes	28
Switching ANALOG/DIGITAL Signal Input	29
Playing Sources with Dolby Digital or DTS Sound	30
Selecting a Sound Mode	31
CINEMA Re-EQ playback	33
Listening in MIDNIGHT Listening Mode	35
Tuner Operations	36
Automatic and Manual Tuning	36
Direct Tuning	37
Memorizing Frequently Tuned Stations	38
Recalling the Memorized Stations	39
Other Operations	40
Playback	40
Recording from Audio Components	42
Recording from Video Components	43
Remote Controlling Other Components	44
Background Control of Other Components	51
Additional Information	52
Dolby Digital	52
DTS	53
Troubleshooting	54
Preset Code List	56
Specifications	57

Introductory Information

Checking the Supplied Accessories

Please check that you have received all of the following accessories with the receiver.



FM wire antenna



AM loop antenna

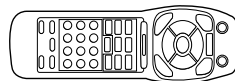

Remote control unit

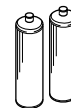

"AA" IEC LR6 batteries x 2

How to Use This Manual

This manual is divided into two main sections :

SET UP

This section explains how to make the necessary connections from the receiver to your other audio and video components. Receiver operations described later in this section under the heading "Preparations" enable you to set up and customize your home entertainment center.

OPERATION

This section provides complete information about operation of the receiver and supplied remote control.

The following marks and symbols are used throughout this manual:



Provides additional information, precautions, and advice.



Indicates a blinking button, indicator, or display.



Indicates a steadily lit button, indicator, or display.

Preparing the Remote Control

Loading the batteries

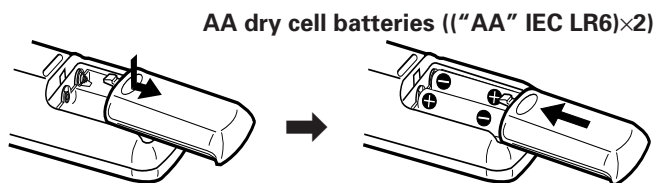

When you notice a decrease in the operating range of the remote control, replace all batteries with new ones.



When changing the batteries, it is recommended that you load new batteries within five minutes of removing the old batteries. If not, the preset codes may be canceled and you will need to set them again.

CAUTION!

Incorrect use of batteries may result in such hazards as leakage and bursting. Observe the following precautions.

- Never use new and old batteries together.
- Insert the plus and minus sides of the batteries properly according to the marks in the battery case.
- Batteries with the same shape may have different voltages. Do not use different batteries together.

Power connection

[SWITCHED 100 W (0.8 A) MAX]

Switching this receiver on or putting it in standby also switches components connected to the receiver's AC OUTLET jacks on and off. When connecting components to the AC OUTLET jacks, leave the power switch of the connected components in the ON position. Total power consumption of connected components should not exceed 100W (0.8 A) .

CAUTION!

- To avoid malfunction, overheating, and possible fire risk, do not connect high-wattage appliances such as blow dryers and irons to the AC OUTLET jacks.
- Do not connect a monitor or TV set.
Even if the power consumption of the TV or monitor is within the acceptable limits, when monitors or TV sets are switched on, they consume a large amount of power and may exceed the capacity of this receiver.

Operating range of remote control unit

Point the remote control toward the remote sensor  on the front panel of this unit to operate. The remote control unit will operate the receiver for up to a distance of 23 feet (7 m) within 30° angle on each side of the sensor of the remote sensor as illustrated below.

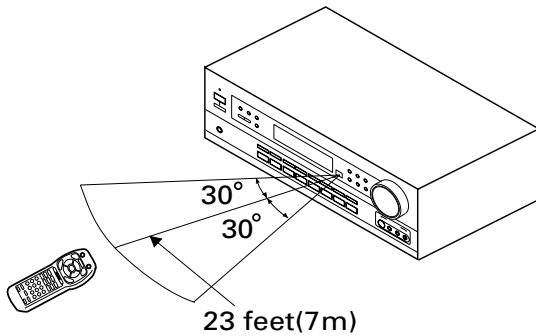

Remote control may not function properly if :

- There are obstacles between the remote control and the remote sensor.
- Direct sunlight or fluorescent light is shining onto the remote sensor.
- The receiver is located near a device emitting infrared rays.
- Operated simultaneously with another remote control which uses infrared rays.

Operating other PIONEER components

Connecting an optional control cord allows you to operate other PIONEER components simply by pointing the receiver's remote control at the remote sensor on the front panel of the receiver. The receiver then sends the remote control signals to the other devices via the CONTROL OUT terminal.

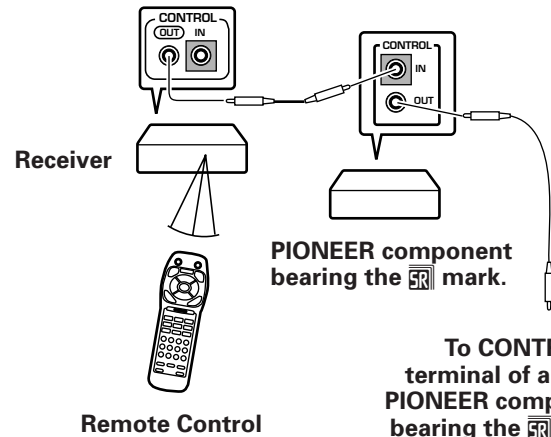

You can also control PIONEER components (and those made by other manufacturers) by pointing the receiver's remote control directly at the respective component. This type of operation does not require control cords. All you have to do is recall the appropriate preset code (Refer to "Recalling preset codes" on page 22).

Receiver Installation

- Do not place objects directly on top of this unit. It will prevent proper heat dispersal.
- When installing in a rack, etc., be sure to leave more than 8 inches of space above the receiver.

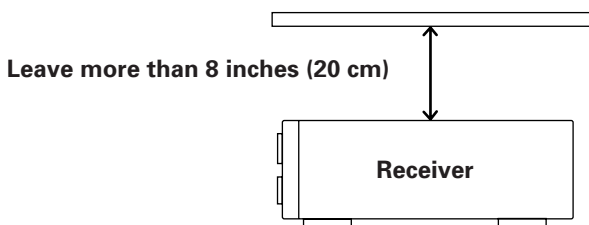

It is recommended that you place the receiver to the left of your cassette and/or video decks. This will prevent noise caused by leakage flux from the transformer in the receiver. If you experience noise during playback of your cassette and/or video decks, move them farther away from the receiver.

When Making Cable Connections

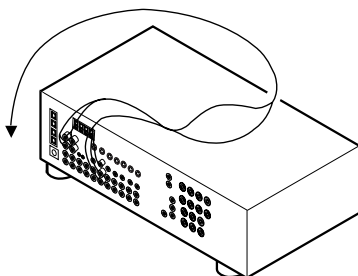

Be careful not to arrange cables in a manner that bends the cables over the top of this unit as shown in the illustration. If the cables are brought over this unit, the magnetic field produced by the transformers in this unit may cause a humming noise to come from the speakers.

Antennas

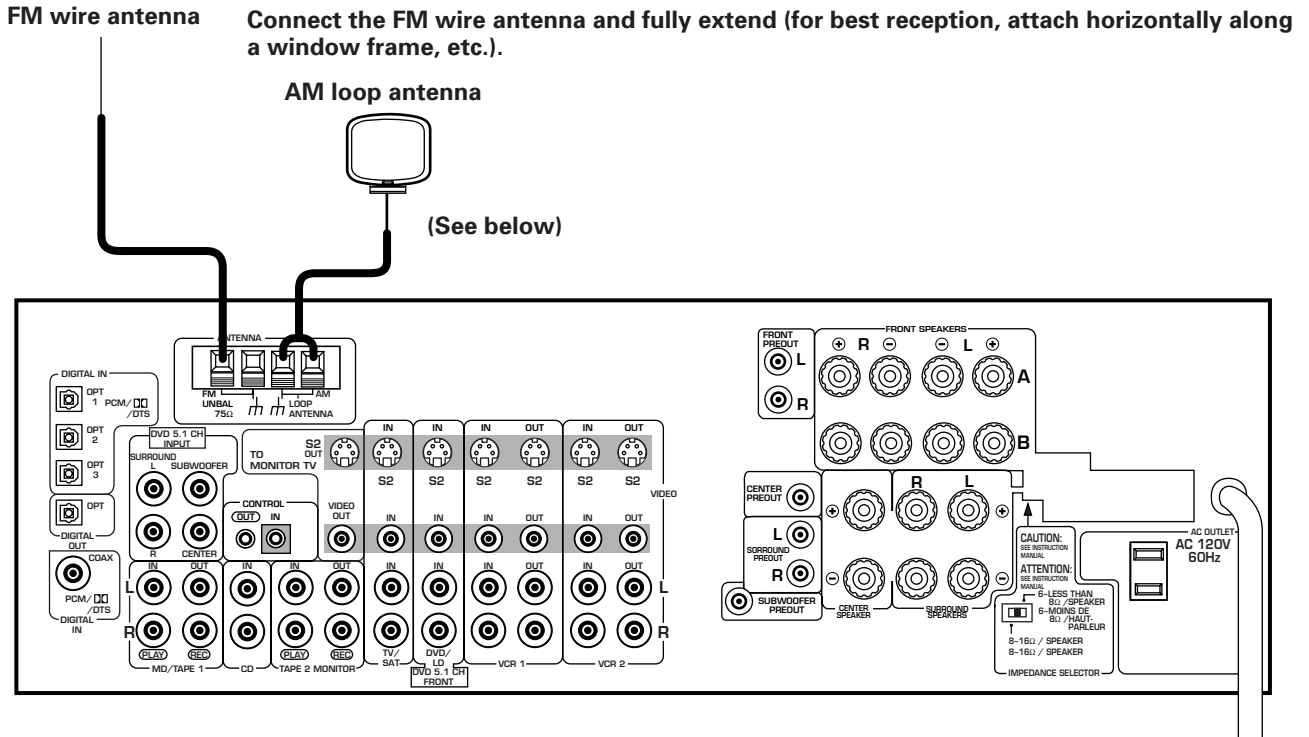

■ AM loop antenna

- 1 Assemble the antenna.

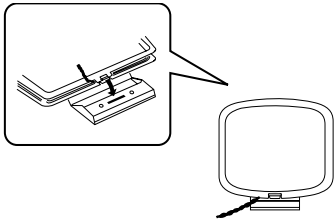

- 2 Twist exposed wire strands together and insert into AM antenna terminals.

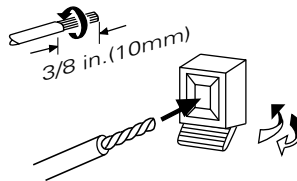

- 3 Attach to a wall, etc. (if desired) and face toward the direction providing the best reception.

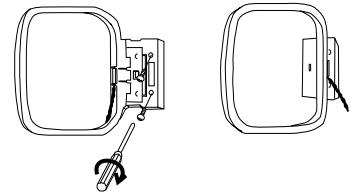

Using external antennas

■ To improve FM reception

Connect an external FM antenna.

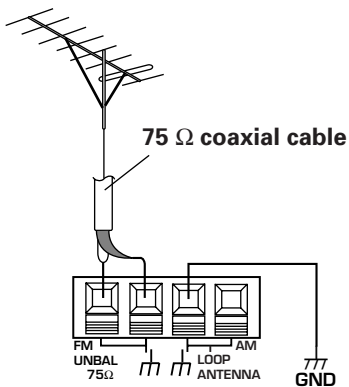

■ To improve AM reception

Connect a 15 to 18 feet (5~6 m) length of vinyl-coated wire to the AM antenna terminal in addition to the supplied AM loop antenna. For the best possible reception, suspend horizontally outdoors.

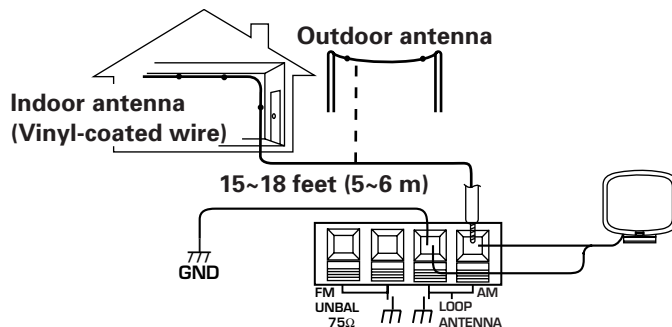

Audio Components Connections

Be sure to switch power to standby and remove the power cord from the wall outlet when you make or change connections.

Connect your audio components as shown below. Refer to "Digital Connections" on page 11 when making digital connections from your DVD or LD player.

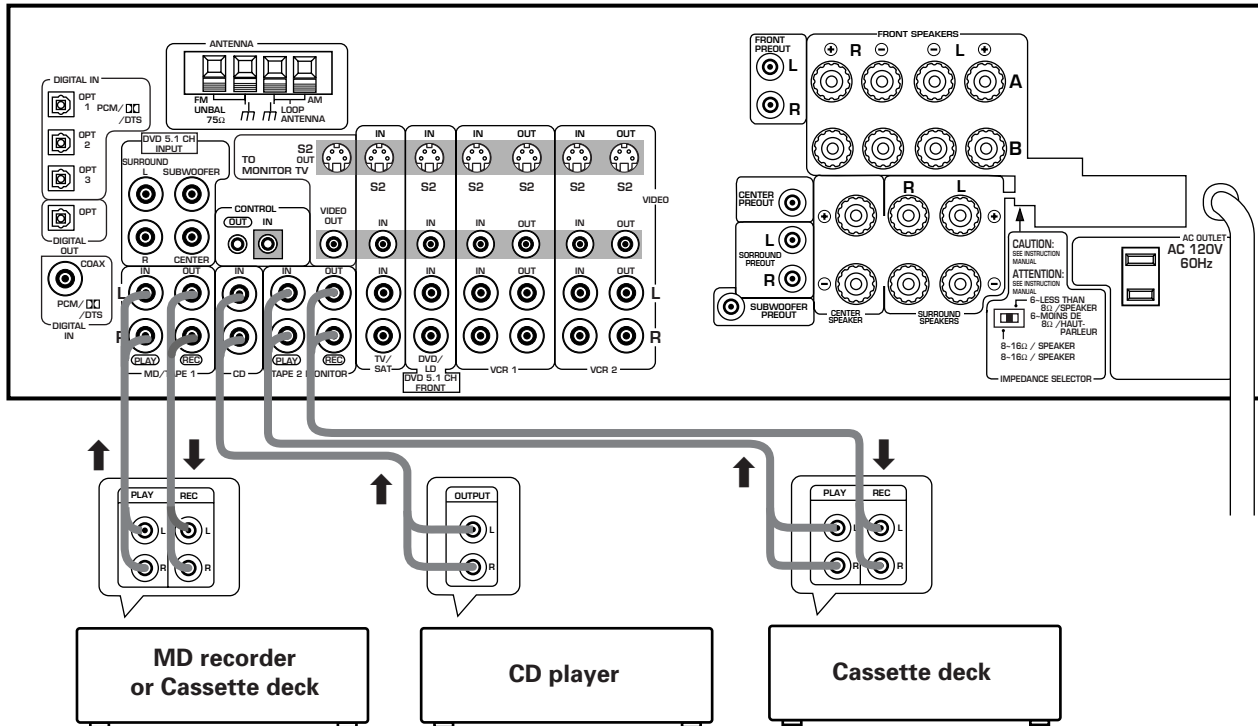

*The arrows indicate the direction of the audio signal.

■ Audio cords

Use audio cords (not supplied) to connect the audio components.

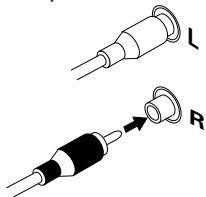

Connect red plugs to R (right) and white plugs to L (left). Be sure to insert completely.

Cassette deck placement

Depending on where the cassette deck is placed, noise may occur during playback of your cassette deck which is caused by leakage flux from the transformer in the receiver. If you experience noise, move the cassette deck farther away from the receiver.

Video Components Connections

- When connecting components, the receiver should be off and the power cord unplugged.
- Connect your video components as shown below. Also, refer to "Digital Connections" on page 11 when making digital connections from your DVD or LD player.
- Although only "S2" is printed on the S-Video jacks on the rear panel, S, S1 and S2 S-video connection can be made as well.
- If your TV monitor or video camera has an S-Video input, clearer picture reproduction is possible by connecting the receiver to your TV monitor or video camera via the S-Video jack.

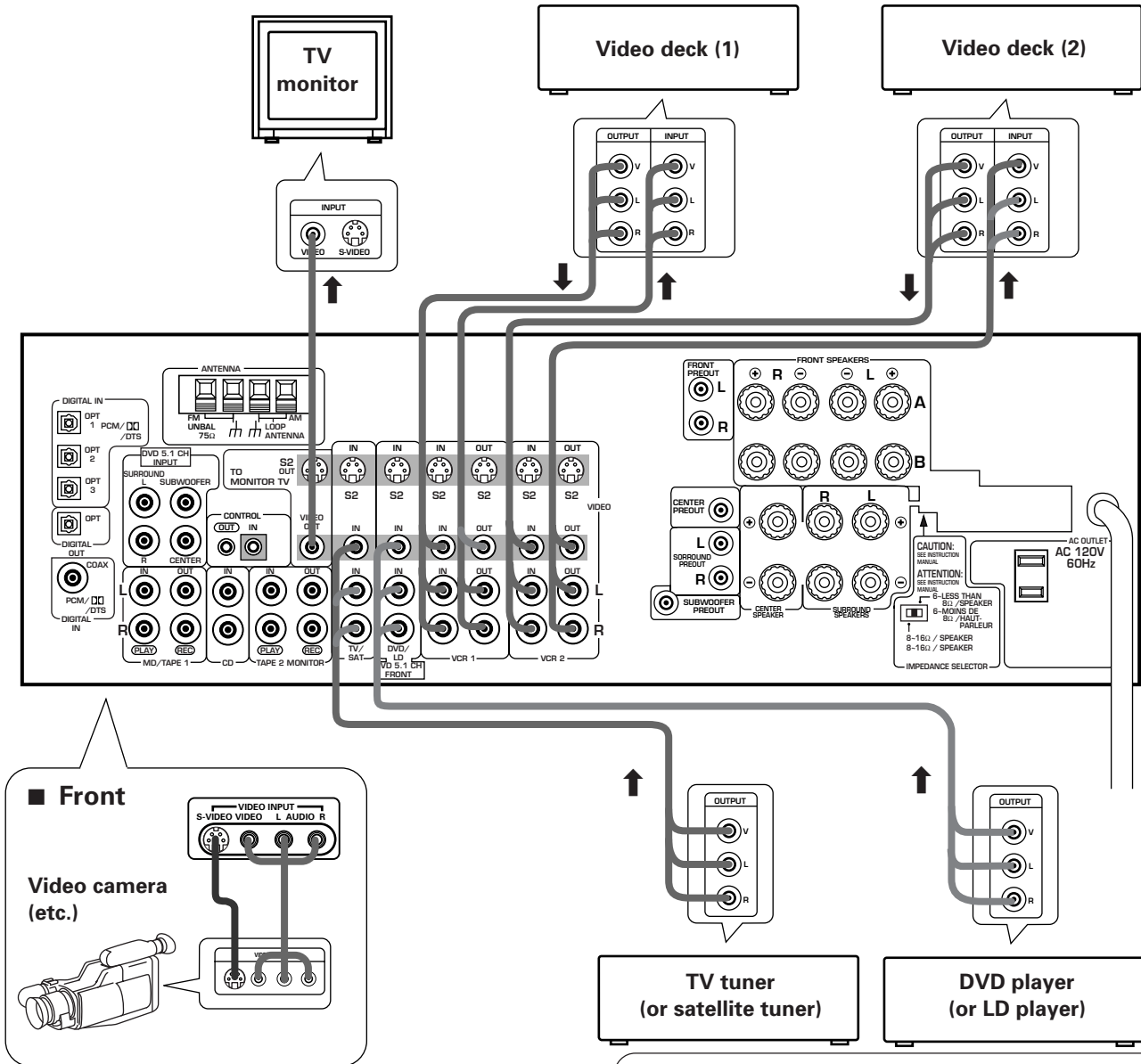

When connecting components equipped with S-video jacks, you can make connections to this unit using S-video cords (not supplied). However, this unit is not designed to convert the format of the video signal. Therefore, the signal from the S2 IN cannot be output from the VIDEO OUT and similarly the signal from the VIDEO IN cannot be output from the S2 OUT.

Audio/Video cords

Use audio/video cords (not supplied) to connect the video components and a video cord to connect the TV or monitor.

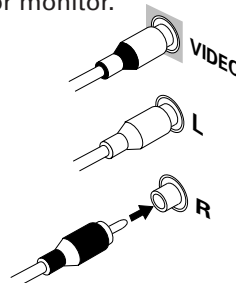

Connect red plugs to R (right), white plugs to L (left), and the yellow plugs to VIDEO.
Be sure to insert completely.

Digital Connections

Digital components can be connected as shown below. You can select up to four of the following to be assigned to the digital inputs on this unit: DVD/LD, TV/SAT, MD/TAPE, CD, VCR1 (VCR). To assign the digital inputs, refer to "Setting Up for Surround Sound" on page 16.

The digital signal input is output directly to digital recording components from the optical digital output jack.

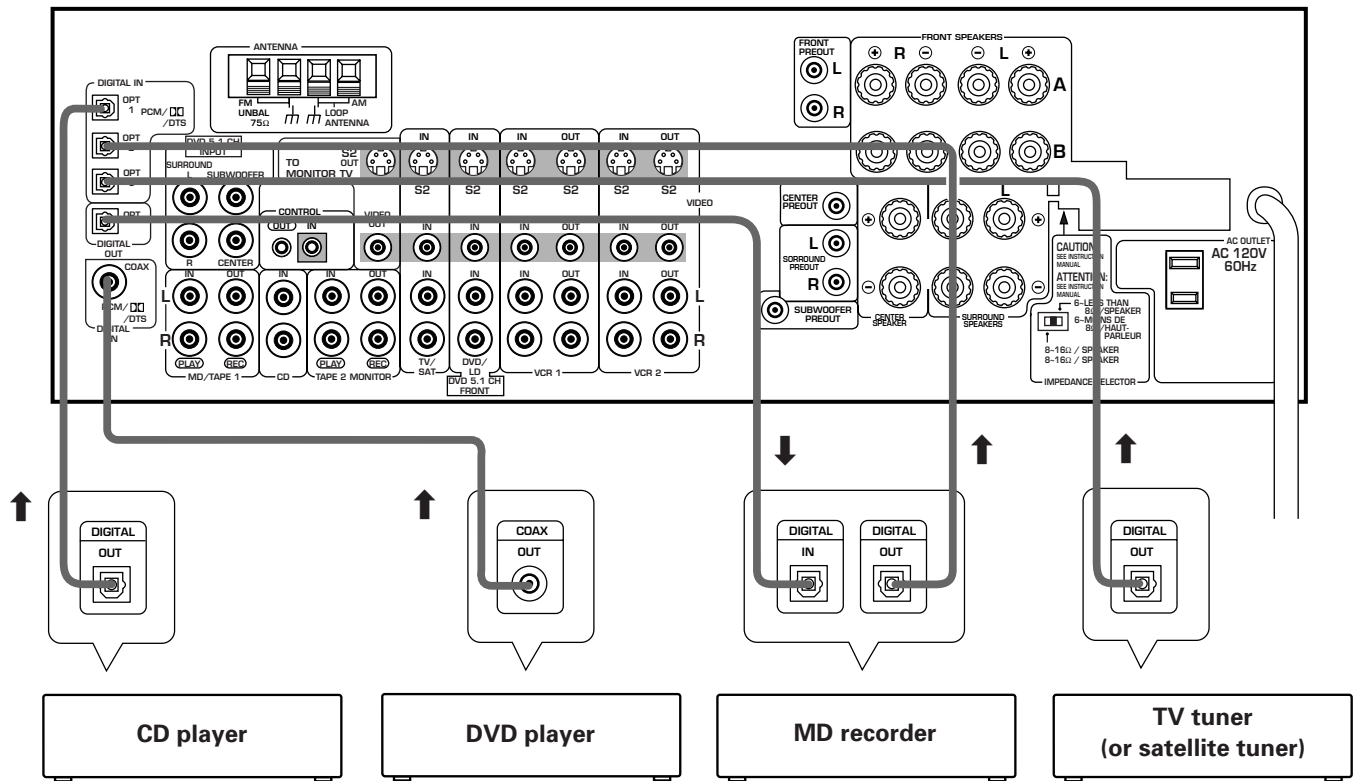

When playing LD recorded in Dolby Digital
 When connecting a DVD/LD player or LD player using the AC-3 RF output, a commercially available RF demodulator (RFD-1) is required. The RF demodulator changes the RF signal to a digital signal which is then processed by the receiver through the digital input jacks. For more details, refer to the instruction manual supplied with the RFD-1.

The factory setting for each of the digital inputs is described below.

- COAX : DVD
- OPT 1 : CD
- OPT 2 : MD
- OPT 3 : TV

■ Digital audio cords/Optical cables

Commercially available digital audio coaxial cords (standard video cords can also be used) or optical cables (not supplied) are used to connect digital components to this receiver.

When you use optical digital input or output terminals, pull off the caps and insert the plugs. Be sure to insert completely.

Digital audio cord (or standard video cord)

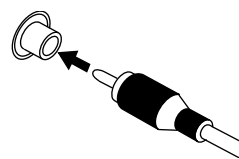

Optical cable

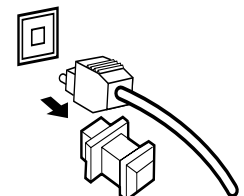

DVD 5.1 Channel Connection

DVD and LD discs are often compatible with both 2 channel and 5.1 channel audio output formats. Refer to page 33 for more information on how to switch between the two input methods.

Connections can be made from a DVD player or Multi channel decoder equipped with 5.1 analog outputs to the 5.1 analog inputs on this unit.

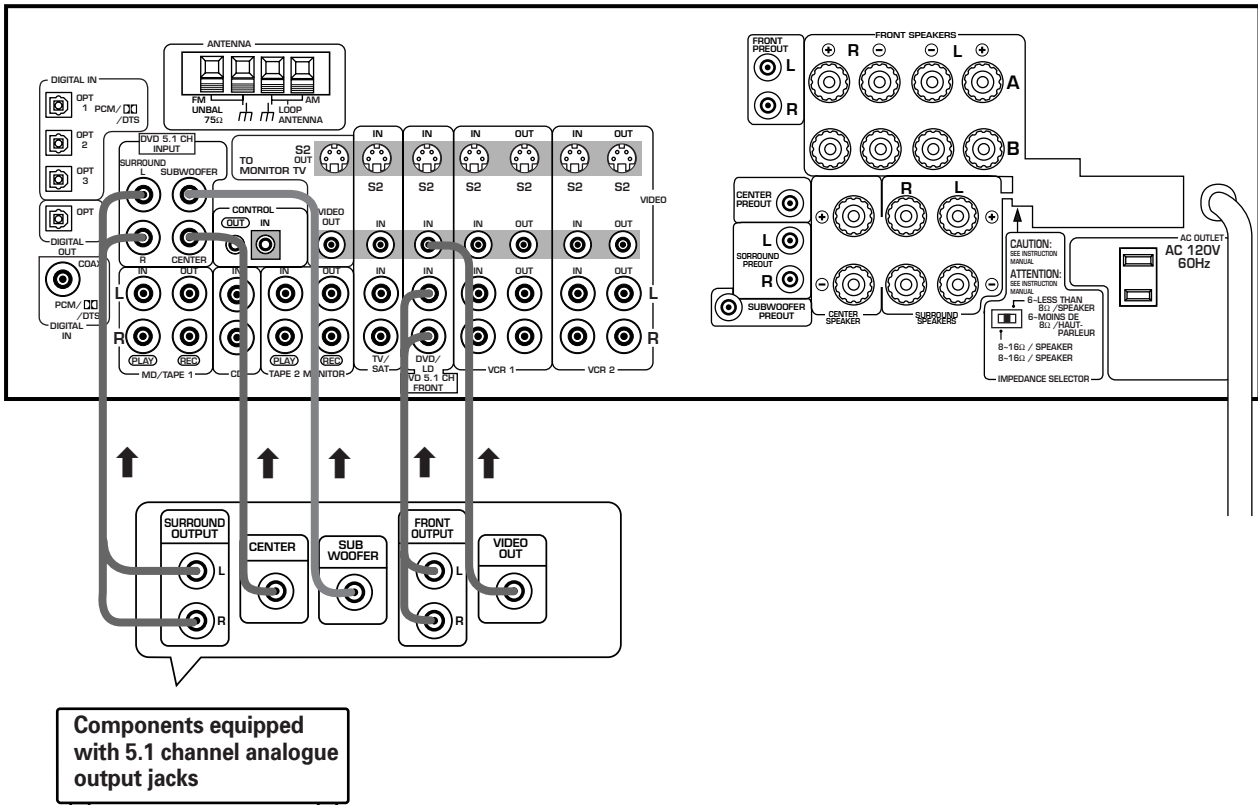

The 5.1 channel input can only be used when DVD/LD is selected.

Speakers

- Use speakers with a nominal impedance of 6 Ω to 16 Ω.
- The front speaker B terminal is only used in stereo mode (Not available during DVD 5.1 channel, DSP mode, or Dolby/DTS mode).
- When you use the speaker on your TV as a center speaker, please connect the CENTER PREOUT jack on this unit to the audio input jack on your TV. In this case, the center speaker shown below is unnecessary. Refer to the instruction manual supplied with the TV or monitor you are connecting to for more information.
- You can set the configuration of your speaker system, whether the sizes of the speakers are large or small, and whether or not you have a sub woofer connected. (Refer to pages 16 to 18)

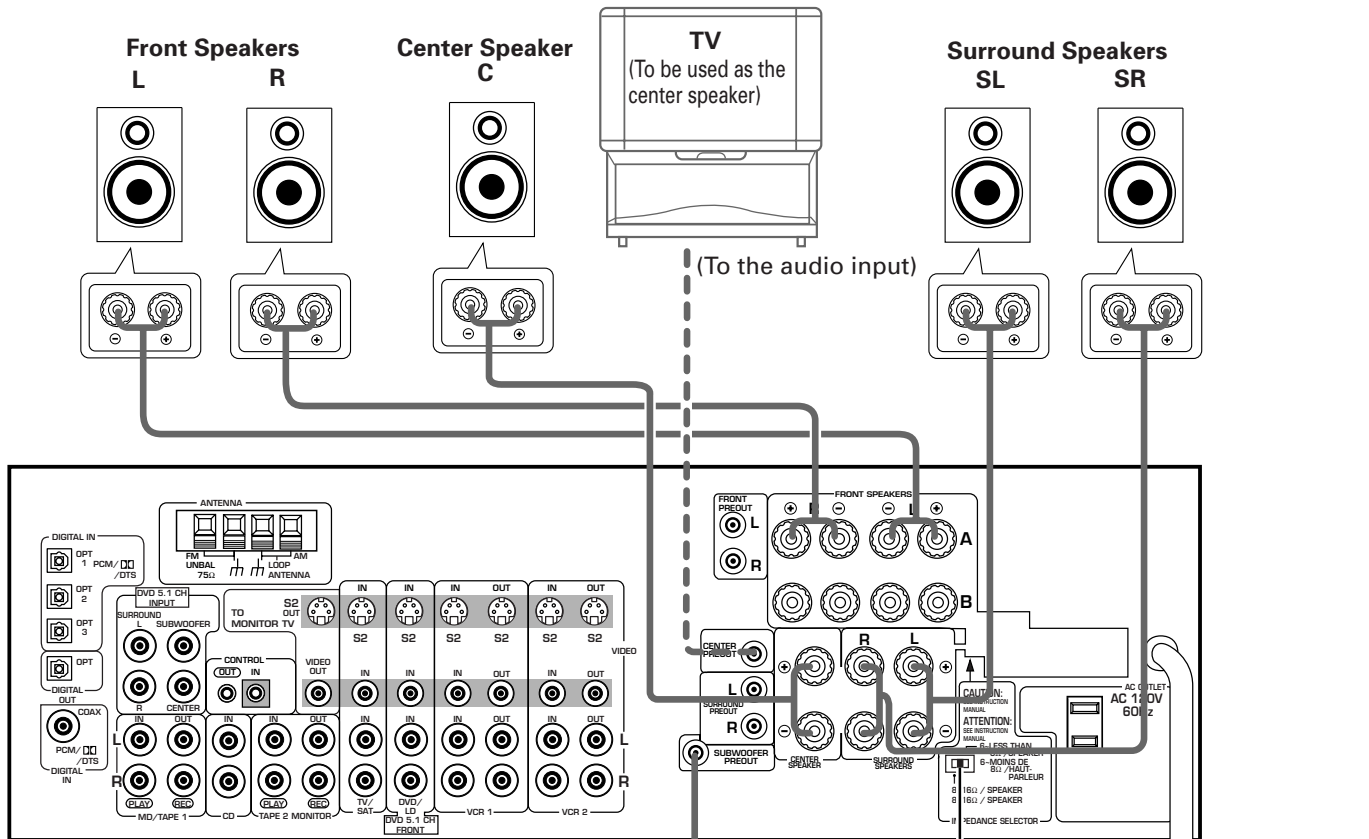

Powered Sub Woofer

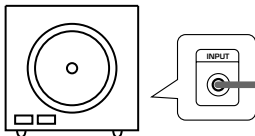

Connection methods that differ from the example shown in this manual may be available. For more details, refer to the instruction manual supplied with the sub woofer.

Use speakers with nominal impedance of 6 Ω to 8 Ω or 8 Ω to 16 Ω.

- When using speakers with impedance of at least 6 Ω but less than 8 Ω, set the IMPEDANCE SELECTOR to the "6~LESS THAN 8 Ω" position.
- When using 8 Ω to 16 Ω, set the IMPEDANCE SELECTOR to "8~16 Ω" position.

Be sure to complete all other connections before connecting this unit to the AC power source.

■ Speaker terminals

Turn counter-clockwise to loosen, and insert the wire. Then turn clockwise to tighten.

Twist exposed wire strands together.

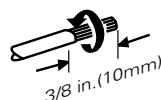

Speaker placement

To achieve the best possible surround sound, install your speakers as shown below. Be sure all speakers are installed securely to prevent accidents and improve sound quality.

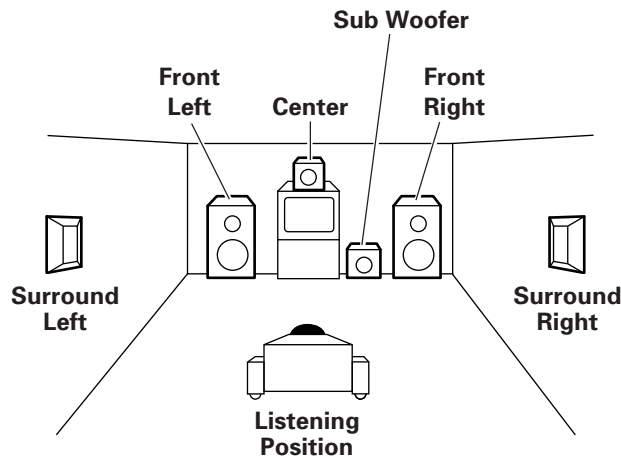

- Install the left and right front speakers at equal distances from the TV.
- When installing speakers near the TV, we recommend using magnetically shielded speakers to prevent possible interference such as distortion in the color of the TV screen. If you do not have magnetically shielded speakers and notice discoloration of the TV screen, place the speakers farther away from the TV.
- Install the center speaker above, below the TV so that the sound of the center channel is localized at the TV screen.

CAUTION:

When installing the center speaker on top of the TV, be sure to secure it with tape or some other suitable means.

Otherwise, the speaker may fall from the TV due to external shocks such as earthquakes, and it may lead to endangering those nearby or damaging the speaker.

- If possible, install the surround speakers slightly above ear level.
- It may be difficult to obtain a cohesive surround effect if the surround speakers are installed farther away from the listening position than the front and center speakers.

Setting Up for Surround Sound

Be sure to switch the power of this unit on (The STANDBY indicator goes out).

To ensure the best possible surround sound, be sure to complete the following set up operations. This is particularly important when using the  (Dolby)/DTS sound mode. You only need to make these settings once (unless you change the placement of your current speaker system or add new speakers, etc.). Refer to the following pages for detailed descriptions of the settings available for each mode.

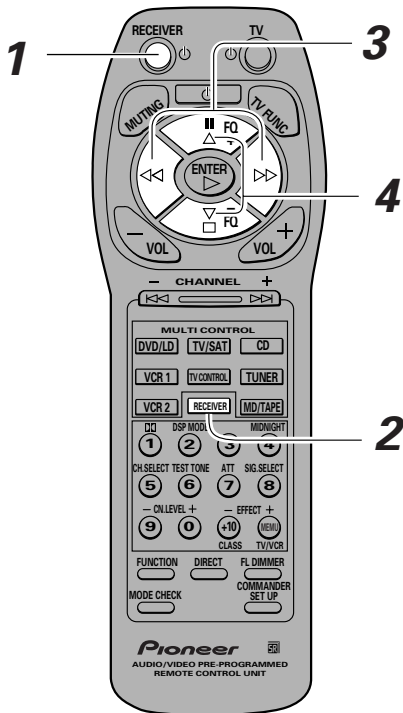

1 Press RECEIVER to turn the power on.

The STANDBY indicator goes out.

2 Press RECEIVER.

This switches the remote to the surround setup mode.

3 Press or to select the mode you desire.

For best results, start with "SPEAKER setting mode" and make your initial adjustments in the order described below.

The current settings are displayed automatically.

SPEAKER (Front, Center, Surround) setting mode (page 17)

Use to specify the type of speakers you have connected.

SUB WOOFER ON/OFF setting mode (page 18)

Use to specify the sub woofer as on or off.

Crossover frequency setting mode (page 18)

Use to determine which frequencies will be sent to the sub woofer or "Large" speakers.

LFE attenuator setting mode (page 18)

Use to specify the peak level for the LFE channel and the crossover network for rerouted bass frequencies.

Low cut filter ON/OFF setting mode (page 19)

Use to cut the distorted sound from the sub woofer.

FRONT speaker distance setting mode (page 19)

Use to specify the distance from your listening position to your front speaker.

CENTER speaker distance setting mode (page 19)

Use to specify the distance from your listening position to your center speaker.

SURROUND speaker distance setting mode (page 19)

Use to specify the distance from your listening position to your surround speakers.

Dynamic range control setting mode (page 20)

Use to compress the dynamic range of the sound track.

Coaxial digital input setting (page 20)

Use to specify the input to be assigned to the coaxial digital input.

Optical digital input 1 setting (page 20)

Use to specify the input to be assigned to the optical digital input 1.

Optical digital input 2 setting (page 20)

Use to specify the input to be assigned to the optical digital input 2.

Optical digital input 3 setting (page 21)

Use to specify the input to be assigned to the optical digital input 3.

4 Press or to select the setting you desire.

The setting is entered automatically.

5 Repeat steps 3 and 4 to set other surround modes.



- Press ENTER to exit the setting mode.
- The setting mode is automatically exited if no operation is performed for 20 seconds.

SPEAKER setting mode

Establishes the size and configuration of the speaker system you have connected.

In the display, "F", "C", and "S" refer to front, center, and surround speakers respectively. Speaker size is denoted as "L" for large speakers, "S" for small speakers, and "*" (asterisk) if no speaker is connected.



If the cone size of your speaker is larger than 5 in. (12 cm), please set to Large.

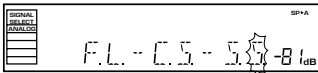
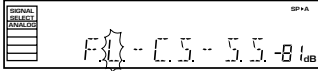

* Press \triangleright to advance to the next setting, and press \triangleleft to return to previous setting.

1 Press \triangle or ∇ to set the front speaker.

Front speaker (initial setting is "L (Large)")

- Select "FL" if your speakers will reproduce bass frequencies effectively or if you did not connect a sub woofer.
- Select "FS" to send bass frequencies to the sub woofer. (The center and surround speakers cannot be set to Large if the front speakers are set to Small. In this case, all bass frequencies are sent to the sub woofer.)

2 Press \triangle or ∇ to set the center speaker.

Center speaker (initial setting is "L (Large)")

- Select "CL" if your speaker will reproduce bass frequencies effectively.
- Select "CS" to send bass frequencies to the other speakers or sub woofer.
- Select "C*" if you did not connect a center speaker. In this case, the center channel is output from the front speakers.

3 Press \triangle or ∇ to set the surround speaker.

Surround speaker (initial setting is "L (Large)")

- Select "SL" if your speakers will reproduce bass frequencies effectively.
- Select "SS" to send bass frequencies to the other speakers or sub woofer.
- Select "S*" if you did not connect surround speakers. In this case, the sound of the surround channels is output from the front and center speakers.

SUB WOOFER ON/OFF setting mode

Sets whether the SUB WOOFER is used or not.



- Initial setting is "ON".
- Setting the front speaker size to "Small" in the SPEAKER setting mode automatically locks the sub woofer in the "ON" position.

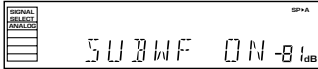

Press Δ or ∇ to select sub woofer ON or OFF.

Crossover frequency setting mode

Setting speakers to "Small" in "SPEAKER setting mode" sends the respective channels' bass frequencies to the sub woofer (or "Large" speakers). This function lets you determine which frequencies will be sent to the sub woofer or "Large" speakers.



- Initial setting is "100 Hz".
- If all speakers (front, center, and surround) are set to "Large" in SPEAKER setting mode, crossover frequency cannot be set. (***) appears in the display.)



Press Δ or ∇ to specify the crossover frequency for your small speakers (100 Hz, 150 Hz or 200 Hz).

100 Hz

Sends bass frequencies below 100 Hz to the sub woofer (or Large speakers).

150 Hz

Sends bass frequencies below 150 Hz to the sub woofer (or Large speakers).

200 Hz

Sends bass frequencies below 200 Hz to the sub woofer (or Large speakers). We recommend setting 200 Hz when only small speakers are used.

LFE attenuator setting mode

Dolby Digital and DTS audio sources include ultra-low bass tones. Set the LFE attenuator as needed to prevent the ultra-low bass tones from distorting the sound from the speakers.



- Initial setting is "0 dB".
- When ∞ is selected (** appears in the display), LFE is not available.



Press Δ or ∇ to set the attenuation level (0 dB, 10 dB or ** dB (∞)).

Low cut filter ON/OFF setting mode

Turn the low cut filter ON when distorted sound is output through the sub woofer.



- Initial setting is "OFF".
- If the SUB WOOFER is set to "OFF" in the SUB WOOFER ON/OFF setting mode, the low cut filter cannot be set.
- The low cut filter is not effective when DTS signals are input.

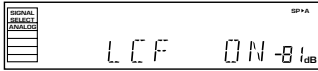

Press Δ or ∇ to select low cut filter ON or OFF.

FRONT speaker distance setting mode

Sets the distance from the FRONT speaker to the listening position.



- Initial setting is 10 feet.
- One step equals about 1 foot.

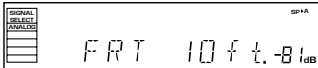

Press Δ or ∇ to set the distance of the FRONT speaker from the main listening position (up to 30 steps).

CENTER speaker distance setting mode

Normally as the Center speaker is placed directly in front in the listening room, it is closer to the listening position than the Front speakers. This means that the sound from the Center speaker will be heard before the Front speakers. To prevent this, set the Center speaker distance setting to delay the sound from the Center speaker so that the sound from the Front and Center speakers will be heard at the same time.



- Initial setting is 10 feet.
- When "C*" is selected in SPEAKER setting mode, the Center distance cannot be set.
- One step equals about 1 foot.

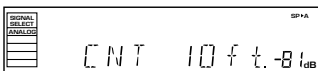

Press Δ or ∇ to set the distance of the CENTER speaker from the main listening position (up to 30 steps).

SURROUND speaker distance setting mode

Use to set the SURROUND speaker distance. Like the CENTER speaker position, the SURROUND speakers may be set in a location closer or farther than the FRONT speakers. Set the distance of the SURROUND speakers accurately to hear sounds coming from both FRONT and SURROUND speakers at the same time.



- Initial setting is 10 feet.
- When "S*" is selected in SPEAKER setting mode, the SURROUND distance cannot be set.
- One step equals about 1 foot.

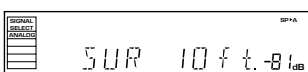

Press Δ or ∇ to set the distance of the SURROUND speaker from the main listening position (up to 30 steps).

Dynamic range control setting mode

Dynamic range is the difference between the loudest and softest sounds in any given signal. The dynamic range control helps you play back sounds so the quieter sounds are audible yet the louder sounds don't get distorted. It does this by compressing the dynamic range. When watching a movie at low volume, setting this function enables low level sounds to be heard more easily.



- Initial setting is "OFF".
- When the volume level is increased, set to OFF.
- For listening enjoyment at low volumes, set to "MAX" for maximum dynamic range compression.
- Dynamic range control is effective only when a Dolby Digital signal is being played back.



Press Δ or ∇ to set the dynamic range control (OFF, MAX or MID).

Coaxial digital input setting

Sets the input component to be assigned to the coaxial digital input jack.



- Initial setting is "DVD".

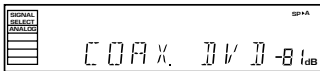

Press Δ or ∇ to select the coaxial digital input (DVD, TV, CD, MD, VCR 1 or OFF).

Optical digital input 1 setting

Sets the input component to be assigned to the optical input 1 jack.



- Initial setting is "CD".

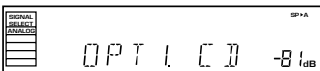

Press Δ or ∇ to select the optical digital input 1 (DVD, TV, CD, MD, VCR 1 or OFF).

Optical digital input 2 setting

Sets the input to be assigned to the optical input 2 terminal.



- Initial setting is "MD".

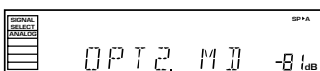

Press Δ or ∇ to select the optical digital input 2 (DVD, TV, CD, MD, VCR 1 or OFF).

Optical digital input 3 setting

Sets the input component to be assigned to the optical input 3 jack.



- Initial setting is "TV".
- You cannot assign the same component to more than one digital input jack. The jack most recently selected is established for the component and the jack formerly selected is turned off.
- DVD/LD, TV/SAT, CD, MD/TAPE, VCR 1 digital input connection is possible.

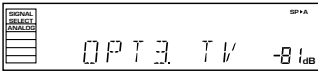

Press Δ or ∇ to set the optical digital input 3 (DVD, TV, CD, MD, VCR 1).

Setting the volume level of each channel (Adjusting the speaker volume balance)



- Sound from the SUB WOOFER seems quiet.
- The speaker volume can be adjusted without outputting the test tone by pressing CHANNEL LEVEL or CHANNEL SELECT.
- Initial setting is 0 dB.

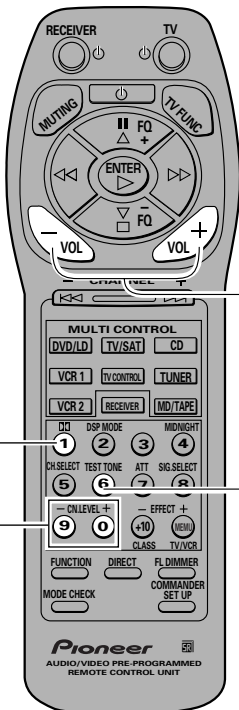

1 Press \square .

2 Press VOL + or - to adjust the volume to an appropriate level.

3 Press TEST TONE to output the test tone.
The test tone is output in the following order.

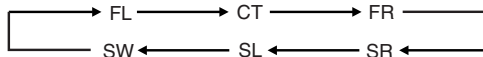

- Test tone is only output in Dolby/DTS mode.

4 Adjust speaker levels so that you hear the test tone at the same volume from each speaker when seated in the main listening position.

The channel level ranges ± 10 dB.



- Levels can be set for each surround mode.

5 Press TEST TONE to turn off the test tone.

Setting Up the Remote Control

In addition to controlling the receiver, the supplied remote control can operate your other components (DVD, MD, VCR, TV, LD, CD, etc.). If your component(s) are listed in the "Preset Code List" on page 56, simply recall the corresponding preset code.

Recalling preset codes

The following steps show you how to recall preset codes for each MULTI CONTROL button. Once the preset code is assigned, pressing the button will automatically set the remote to operate the respective component.



- Refer to "Preset Code List" on page 56 for the components and manufacturers available.
- Refer to "Remote Controlling Other Components" on pages 44 to 50 and "Background Control of Other Components" on page 51 for detailed explanations on how to operate your other components.

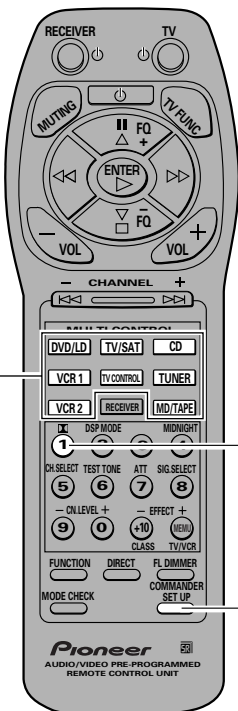

1 Press COMMANDER SET UP and 1 at the same time to select the preset mode.

The MULTI CONTROL buttons on the remote control start to blink.

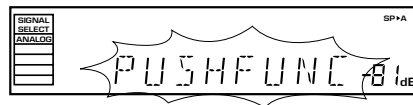
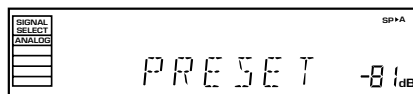

To cancel the preset mode
Press COMMANDER SET UP.

2 Press the MULTI CONTROL button for the component you want to control.

Each button can be set to control one of the following components

- DVD/LD** : DVD/LD player
- TV/SAT** : TV or Satellite tuner
- CD** : CD player
- MD/TAPE** : MD recorder or Tape recorder
- VCR 1** : Video deck
- VCR 2** : Video deck
- TV CONTROL** : TV or Cable TV tuner

The selected button lights steadily and the first manufacturer (and preset code(s)) appear in the display.

3 Press Δ or ∇ repeatedly to display the name of the component's manufacturer.

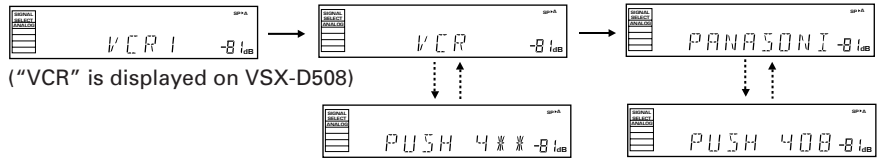

A list of all available preset codes is provided on page 56.

4 Point the remote toward the component to be controlled, enter the 3 digit setup code.

When you enter the setup code, the remote emits a power ON/OFF signal. If the component turns ON or OFF, you have entered the proper code.

If the component does not turn ON or OFF and there is more than one setup code, press \triangleleft or \triangleright to select another code in step 3 or try inputting another code (starting again from step 2).

Some manufacturers use several sets of remote control signals and the first code may not correspond to your component.

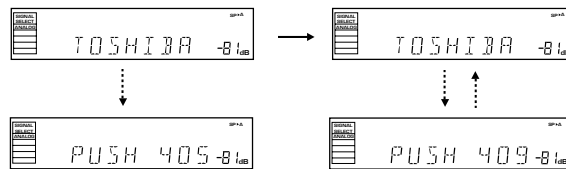

Repeat steps 2 through 4 to assign preset codes for as many components as necessary.

5 Press COMMANDER SET UP to exit the preset mode.

The remote control returns to the previous operation mode.



- When operating a PIONEER'S DVD/LD player, set the manufacturer code to "000" in the preset mode.
- All codes enrolled in the manufacturer code list can be set even if a code is not displayed.
- RECEIVER cannot be preset.

Clearing the Remote Control Settings

Clears all presets and restores factory installed presets.

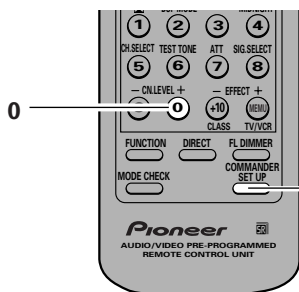

Press the COMMANDER SET UP and 0 at the same time for more 3 seconds.

- All the multi-control buttons on the remote control blinks. After blinking three times, all the settings are canceled.

Display

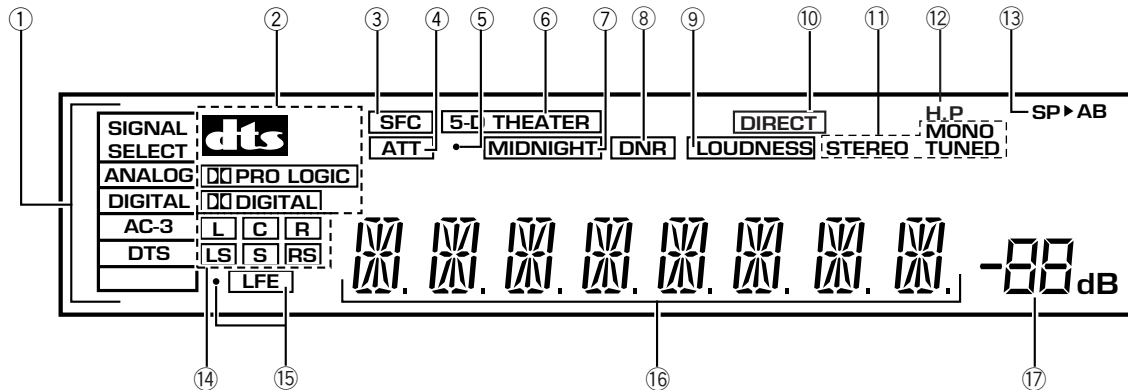

① SIGNAL SELECT indicators

Light to indicate the type of input signal selected for the current component (refer to "Front Panel", ⑮, SIGNAL SELECT on pages 26, 27).

ANALOG : Lights when the analog audio signals are selected.

DIGITAL : Lights when the digital audio signals are selected.

AC-3 : Lights when a source with Dolby Digital signals is played.

DTS : Lights when a source with DTS audio signals is played.

② Digital indicators

dts : Lights when DTS signals are input. (Dolby/DTS mode is ON)

PRO LOGIC : When the Dolby mode on the receiver is on, this indicator lights during 2 channel playback of Dolby Digital sources.

DIGITAL : When the Dolby mode on the receiver is on, this indicator lights to indicate playback of a Dolby Digital signal. However, **PRO LOGIC** lights during 2 channel playback of Dolby Digital.

③ SFC (DSP) mode indicator

Lights when the DSP mode or ADVANCED THEATER mode (except for 5-D THEATER) is selected.

(Refer to "Surround modes" on page 28)

④ ATT indicator

Lights when ATT (refer to "Remote Control", ⑦, Number buttons on page 25) is used to reduce the level of the input signal (available in ANALOG mode only).

⑤ Overload indicator

When "ANALOG" is selected in SIGNAL SELECT, this indicator lights to show that an excessively strong signal is being processed. When this occurs, press ATT on the remote control to attenuate the signal. Also, when "DIGITAL" is selected in SIGNAL SELECTOR, this indicator lights to show that a source containing an excessive amount of information is being processed.

When this occurs, refer to pages 31 and 32.

⑥ 5-D THEATER indicator

Lights when 5-D THEATER is selected.

⑦ MIDNIGHT indicator

Lights when the MIDNIGHT mode is on.

⑧ DNR indicator

Lights when the DIGITAL NR is on.

⑨ LOUDNESS indicator

Lights when loudness is on (refer to "Front Panel", ⑧, LOUDNESS on pages 26, 27).

⑩ DIRECT indicator

Lights when direct playback is on (refer to "Front Panel", ⑫, DIRECT on pages 26, 27).

⑪ Tuner indicators

STEREO : Lights when an FM stereo broadcast is received in the auto stereo mode.

TUNED : Lights when a broadcast is received.

MONO : Lights when the tuner is set to receive FM broadcasts in monaural.

⑫ H.P indicator

Lights when headphones are plugged in.

⑬ Speaker indicators

Light to indicate the current speaker system (refer to "Front Panel", ⑦, SPEAKERS (A/B) on pages 26, 27).

SP A : Lights when speaker system A is selected.

SP B : Lights when speaker system B is selected.

⑭ Program format indicators

The following indicators light to show the channels being played back.

L : Left front*1*2, **C** : Center*1, **R** : Right front*1*2,

LS : Left surround*1, **S** : Surround (mono)*2,

RS : Right surround*1

*1: Indicates 5.1ch Dolby Digital/DTS playback.

*2: Indicates Dolby surround playback.

⑮ LFE indicator

LFE (Low Frequency Effects) indicator lights to indicate that the program source contains an LFE channel. The indicator to the left of LFE lights during actual playback of the LFE signals (LFE signals are not present in all parts of the sound track).

⑯ Character display

⑰ Volume level display

Displays the volume level. Volume level is maintained even when the power is off. ---dB indicates the minimum level, and 0dB indicates the maximum level.

• Depending on the level settings for individual channels, the MAX level can range between -10dB and 0dB.

Remote Control

These pages describe the buttons on the remote control used to operate the receiver.

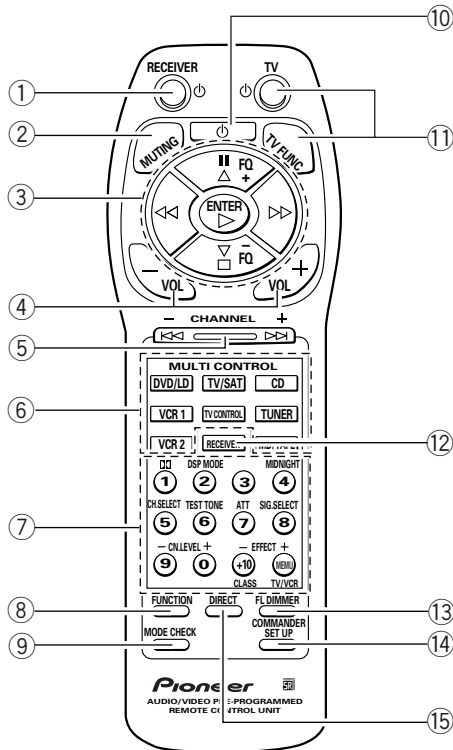

① RECEIVER button

Press to switch the receiver on or to put in standby.

② MUTING button

Press to mute the volume. "MUTING" appears in the display. Press again to cancel.

③ $\Delta/\nabla/\triangleleft/\triangleright$ /ENTER buttons

Specific use of these buttons is described in conjunction with the operations they are used in.

ENTER : Press to switch the band (FM/AM) when using the tuner.

④ VOL (+/-) buttons

Press to adjust the volume. When VOL (+/-) buttons are pressed while muting, muting is canceled.

⑤ CHANNEL (+/-) button

Use to select preset stations when operating the tuner. When the remote is used to control other components, this button may be used to change channels, tracks, or chapters.

⑥ MULTI CONTROL buttons

Use these buttons to select the remote operation mode.

For example, pressing TUNER sets the remote to operate the tuner functions.

⑦ Number buttons

These buttons can perform a variety of different functions depending on the remote operation mode.

• [RECEIVER operations (press RECEIVER first)]

DOLBY : Press repeatedly to select the standard Dolby/DTS mode and the ADVANCED THEATER modes. (Refer to page 30, 32)

DSP MODE : Press repeatedly to select a DSP sound mode (refer to page 31).

MIDNIGHT : Press to hear surround sound effectively at low volumes (refer to page 35).

CH.SELECT : Use to select a speaker when adjusting speaker levels.

TEST TONE : Press to switch the test tone on or off when listening to a surround mode (refer to page 21).

ATT : Press to attenuate (lower) the level of the input signals and prevent distortion (refer to "Display", ⑤, Overload indicator on page 24).

SIG.SELECT : When the same component uses both analog and digital connections, use to select input signals as digital or analog.

CH.LEVEL (-/+) : Use to adjust individual speaker levels.

EFFECT (+/-) : Use to adjust the DSP mode effect level.

• [TUNER operations (press TUNER first)]

Number buttons (0~9) : During preset tuning, use to input the number of the preset station. Use to input the station frequency during direct tuning.

CLASS (+10) : Press repeatedly to switch the preset station classes during preset tuning.

MENU : Press to activate direct tuning.

⑧ FUNCTION button

Press repeatedly to select a source.

⑨ MODE CHECK button

Press to confirm the current remote operation mode and to switch operation modes without changing the source (refer to page 51).

⑩ Power button

Press to turn on or put in standby all connected components other than this unit.

⑪ TV/TV FUNC button

Press TV to turn the TV's power on or put in standby. Press TV FUNC to select the TV for remote control operation.

⑫ RECEIVER button

Press to select the receiver for remote control operation.

⑬ FL DIMMER button

Press to adjust the brightness of the fluorescent display. Four levels of brightness ranging from very dim to very bright can be selected.

⑭ COMMANDER SET UP button

Use to customize the remote control functions. (Refer to "Setting Up the Remote Control" starting on page 22.)

⑮ DIRECT button

Use to playback original source audio. When DIRECT is ON, Dolby, DSP, LOUDNESS, DIGITAL NR and MIDNIGHT mode are automatically turned OFF.

Front Panel

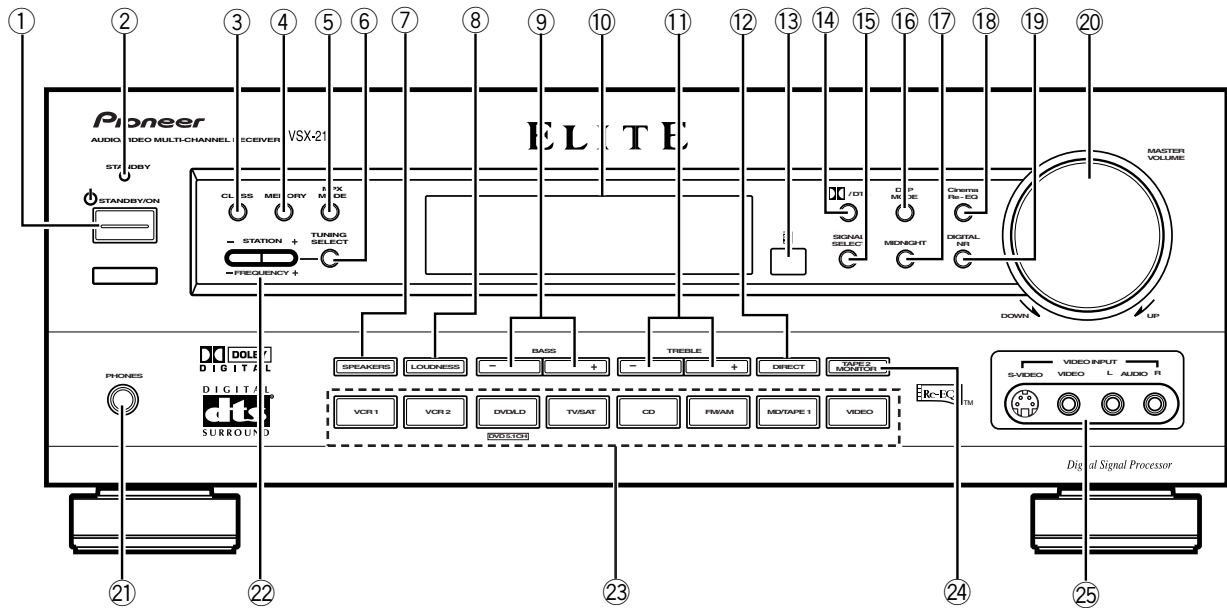

- ① **STANDBY/ON button**
Press to switch the receiver on or put in standby.
- ② **STANDBY indicator**
Lights when the receiver is in standby mode. (Please note that this receiver consumes a small amount of power (2.5 W) during the standby mode.)
- ③ **CLASS button**
Press repeatedly to switch the preset station classes. (Refer to "Memorizing Frequency Tuned Stations" on page 38 and "Recalling the Memorizing Stations" on page 39)
- ④ **MEMORY button**
Press to memorize a preset station. (Refer to "Memorizing Frequency Tuned Stations" on page 38)
- ⑤ **MPX MODE button**
Press to switch between auto stereo and monaural ("MONO") reception of FM broadcasts. When the broadcast signal is weak, selecting "MONO" will improve the sound quality.
- ⑥ **TUNING SELECT button**
Press to switch between STATION and FREQUENCY.
- ⑦ **SPEAKERS button**
Press repeatedly to switch between A and B speaker systems as follows.

→ A
→ B
→ A+B
→ OFF
- ⑧ **LOUDNESS button**
Switches the loudness on or off. Use to raise the level of the bass and treble so they can be more easily heard when listening at low volumes.
- ⑨ **BASS (+/-) button**
Press to adjust low frequencies in the range of ±6.
- ⑩ **Display (Refer to page 24)**
- ⑪ **TREBLE (+/-) button**
Used to adjust high frequencies in the range of ±6.
- ⑫ **DIRECT button**
Switches direct playback on or off. Use to bypass the receiver's tone control circuitry or level control for higher fidelity to the program source. When DIRECT is ON, Dolby, DSP, LOUDNESS, DIGITAL NR and MIDNIGHT mode are automatically turned OFF.
- ⑬ **Remote sensor**
Point the remote control toward the remote sensor to operate the receiver.
- ⑭ **DOLBY / DTS button**
Press repeatedly to select the standard Dolby/DTS mode and the ADVANCED THEATER modes. (Refer to page 30, 32)
- ⑮ **SIGNAL SELECT button**
Use to select input signals for the digital components. First press DVD/LD, TV/SAT, MD/TAPE 1, CD or VCR 1 (⑫, Function buttons) to select the component, then press SIGNAL SELECT repeatedly to select one of the following:
ANALOG : Selects the analog (R and L) audio signals.
DIGITAL : Selects the digital audio signals. This receiver automatically detects and displays the format of the signal being input. AC-3 lights when Dolby Digital signals are input, and DTS lights when DTS signals are input. (AC-3 and DTS decoding is switched automatically.)

- SIGNAL SELECT is fixed in the "ANALOG" position for components not assigned to one of the four digital input jacks.
- Because the audio from a karaoke microphone and LD recorded with analog audio only is not output from the digital output, set SIGNAL SELECT to "ANALOG".
- This receiver can only play back Dolby Digital, PCM (32kHz, 44kHz, and 48kHz), and DTS digital signal formats. With digital signal formats other than these, set SIGNAL SELECT to "ANALOG".

⑩ DSP MODE button

Press repeatedly to select a DSP sound mode (HALL 1, HALL 2, JAZZ, DANCE, THEATER 1, or THEATER 2). Use these modes to produce surround sound from standard (two channel) stereo sources.

⑪ MIDNIGHT button

Press to hear effective surround sound at low volume levels. The effect is automatically adjusted according to the volume level.

⑫ Cinema Re-EQ button

Switches Cinema Re-EQ on or off. Use to high frequency characteristics are reduced at the front channels (Front Left, Center, Front Right). (refer to page 33.)

⑬ DIGITAL NR button

Switches DIGITAL NR on or off. Use to reduce noise in digital audio sources (refer to page 34.)

⑭ MASTER VOLUME

After turning on the desired component, rotate to adjust the volume.

⑮ PHONES jack

Connect headphones for private listening (the speakers turn off automatically).

⑯ STATION/FREQUENCY (+/-) button

STATION: Press to select the preset channel.

FREQUENCY: Press to select the frequency.

⑰ Function buttons

Selects the function. Each press switches the DVD/LD input between DVD/LD and DVD 5.1 channel.

⑱ TAPE 2 MONITOR button

Switches the TAPE 2 monitor on or off (refer to page 42).

⑲ VIDEO INPUT jacks

Connect a video camera, video game system, etc. to the VIDEO INPUT jacks (refer to page 10).

Sound Modes

This receiver incorporates two surround modes for enjoyment of a variety of program sources.

Surround modes

(Dolby) mode

Use this mode when playing Dolby Digital or Dolby Pro Logic software. Decoding switches automatically according to the input signal, so all you have to do is enjoy!

You can identify Dolby Digital software by the  or  marks. Most Dolby Pro Logic software is marked , but unmarked software may also incorporate Dolby Pro Logic.

For more information about Dolby formats, refer to page 52.



ADVANCED THEATER modes

MUSICAL



Simulates the acoustic environment of a large concert hall and is suitable for music or musical sources marked

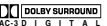

DRAMA

Simulates the relaxed environment of a classic medium size movie theater, and is suitable for watching dramas on sources marked  () or .

ACTION

Simulates the acoustic environment of a modern large movie theater. You can enjoy the power and dynamics of motion picture audio which is suitable for action movies on sources marked  () or .

5-D THEATER

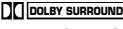
Simulates the clear and dynamic five channel sound of Dolby Digital audio on Dolby Pro Logic software marked . Also, when used with DTS or Dolby Digital sources, you can experience a sense of travelling with the soundtrack.

DSP modes

The DSP (Digital Signal Processing) modes allow you to transform your living room into a variety of different sonic environments when playing standard (two-channel) stereo sources, Dolby Pro Logic sources, and Dolby Digital sources.

HALL 1

Simulates the acoustic environment of a large concert hall of wooden construction. Complex delay of reflected sounds coupled with reverberation effects create a dynamic and beautiful sound characteristic of an orchestra performing in a concert hall, making it suitable for classical music

HALL 2

Simulates the acoustic environment of a concert hall with stone walls. The rich reverberations and natural fullness of the sound create the auditory impression of being in a concert hall, making it suitable for classical music.

JAZZ

Simulates the acoustic environment of a jazz club. Less delay on the reflected sounds emphasizes the sensation of hearing a live band.

DANCE

Simulates the acoustic environment and strong bass sound of a nightclub with a square dance floor. A short delay on the reflected sounds emulates the raw power of the dance music.

THEATER 1

Adjusts the delay of the reflected sound to simulate the acoustic environment of a medium sized movie theater.

THEATER 2

Simulates the acoustic environment of a theater while maintaining proper localization of each channel.

Switching ANALOG/DIGITAL Signal Input

The input of the component set in the digital input setting (Refer to page 20, 21) can be switched to an analog or digital input signal by pressing the SIGNAL SELECT button.

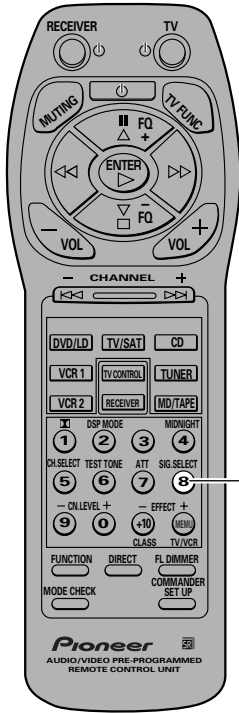

SIG.SELECT

1 Press **SIG. SELECT** on the remote control or **SIGNAL SELECT** on the front panel to select the input signal corresponding to the source component.

Each press switches between ANALOG and DIGITAL signal selection.

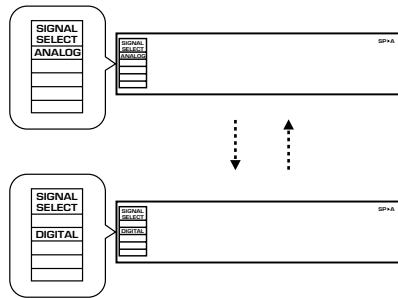

2 While **SIGNAL SELECT** is set to **DIGITAL**, **AC-3** lights when a Dolby Digital signal is input, and **DTS** lights when a DTS signal is input

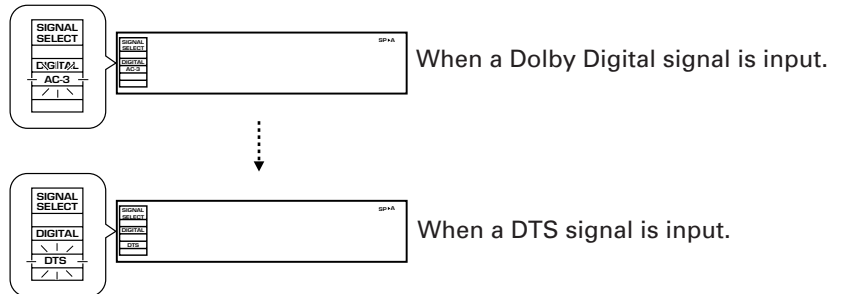

SIGNAL SELECT

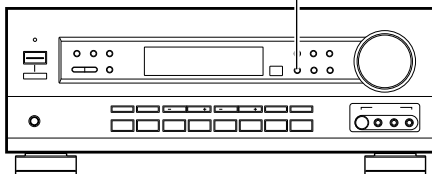

- SIGNAL SELECT is fixed in the "ANALOG" position for components not assigned to one of the four digital input jacks.
- Because the audio from a karaoke microphone and LD recorded with analog audio only is not output from the digital output, set SIGNAL SELECT to "ANALOG".
- This receiver can only play back Dolby Digital, PCM (32kHz, 44kHz, and 48kHz), DTS digital signal formats. With digital signal formats other than these, set SIGNAL SELECT to "ANALOG".
- When an LD or CD player compatible with DTS is played back with SIGNAL SELECT set in "ANALOG", digital noise is output caused by playing back the DTS directly (no decoding). To prevent noise, you need to make digital connections (Refer to pages 20, 21) and set SIGNAL SELECT to "DIGITAL".
- Some DVD players don't output DTS signals. For more details, refer to the instruction manual supplied with your DVD player.

Playing Sources with Dolby Digital or DTS Sound

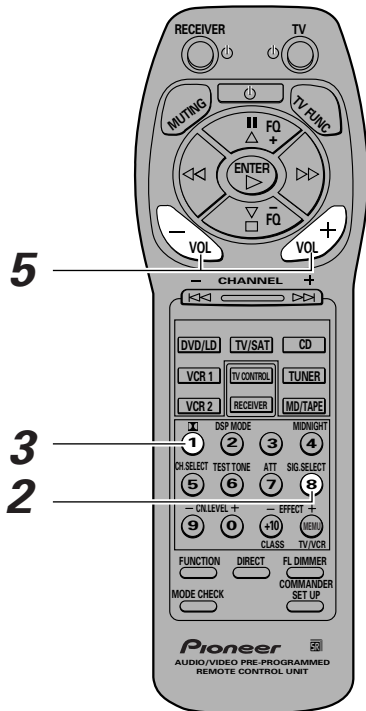

1 Follow steps 1 to 3 of the playback procedure. (Refer to "Playback" on page 40.)

- ① Turn on the power of the playback component.
- ② Press RECEIVER to turn on the receiver.
- ③ Press FUNCTION to select the source component you want to play.

2 Press SIG.SELECT on the remote control or SIGNAL SELECT on the front panel to select DIGITAL.

(Refer to "Switching ANALOG/DIGITAL signal input" on the previous page.)

3 Press to switch the Dolby/DTS mode on.

Each press changes the Dolby/DTS mode.

(Refer to "Switching the Dolby/DTS mode" on page 32.)

4 Start playback of the component you selected in step 1.

5 Press VOL (+/-) to adjust the volume level.

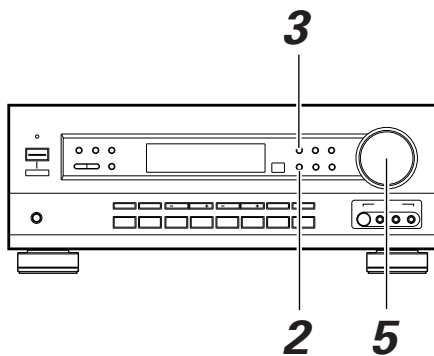

- When an LD or CD player compatible with DTS is played back with SIGNAL SELECT set in "ANALOG", digital noise is output caused by playing back the DTS directly (no decoding). To prevent noise, you need to make digital connections (Refer to pages 20, 21) and set SIGNAL SELECT to "DIGITAL".



When playing LD recorded in Dolby Digital

When connecting a DVD/LD player or LD player using the AC-3 RF output, a commercially available RF demodulator (RFD-1) is required. The RF demodulator changes the RF signal to a digital signal which is then processed by the receiver at the digital input jacks. For more details, refer to the instruction manual supplied with the RFD-1.

Refer to pages 52, 53 for explanations of Dolby Digital, Dolby Pro Logic, and DTS.

Selecting a Sound Mode

To ensure the best possible surround sound, be sure to complete the set up procedures described in "Setting Up for Surround Sound" (starting on page 16) before using the sound modes. This is particularly important when using the  (Dolby)/DTS sound mode. When using the sound modes, SPEAKERS A are used. If SPEAKERS B are selected and a sound mode is turned on, selection automatically switches to SPEAKERS A only.

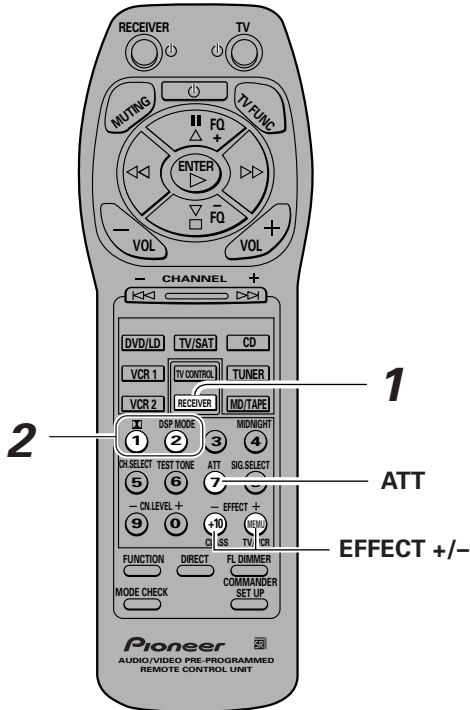

Surround operation



1 Press RECEIVER.

This sets the remote to select the sound mode.
(You can skip this step when using the controls on the receiver.)

2 Select the sound mode.

- For  (Dolby)/DTS mode → Press 
- For DSP modes → Press DSP MODE repeatedly
Each press changes the DSP mode as follows:

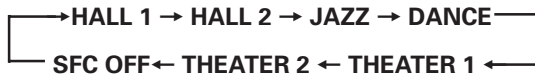

- The amount of effect of each DSP mode can be adjusted in the range of 10 to 90 (the default setting value is 70) by pressing EFFECT +/-.

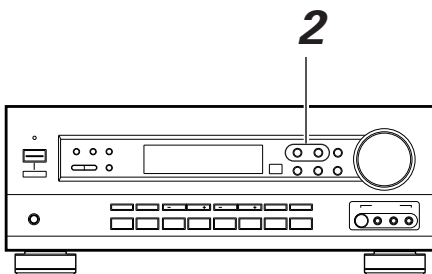

Switching the Dolby/DTS mode (ADVANCED THEATER mode)

Switch the Dolby/DTS mode by pressing the **Dolby/DTS** button. When Dolby/DTS mode is ON, Dolby Pro Logic, Dolby Digital, and DTS signal processing is performed automatically corresponding to the input signal.

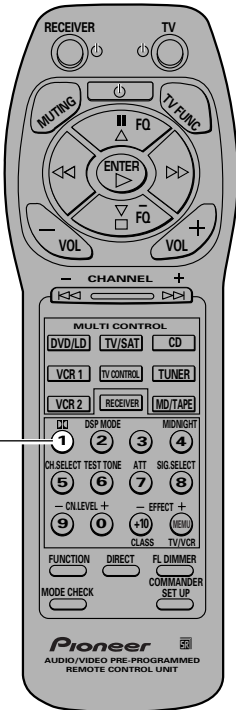

Switch the Dolby/DTS mode on and off by pressing **Dolby/DTS on the remote control or **Dolby/DTS** on the front panel.**

Each press changes the display as follows.

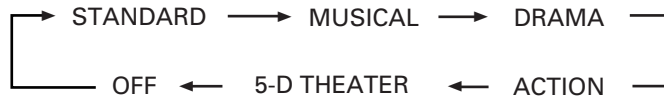

Refer to page 28 for more details about each surround effect.



- The effects of Dolby/DTS mode can be adjusted in the range of 10 to 90 by pressing EFFECT +/- . (The default setting is 70) . Also, the effect level can be set in each Dolby/DTS mode by pressing the EFFECT(+/-) button. STANDARD and 5-D THEATER modes cannot be changed.
- If the ADVANCED THEATER mode (MUSICAL, DRAMA, ACTION) is ON when the digital input is selected, the overload indicator may flicker. If this bothers you, set the ADVANCED THEATER mode to STANDARD.

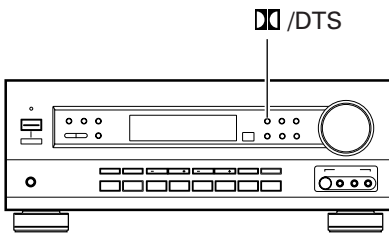

DVD 5.1ch input playback

Connect a component with 5.1 channel output to enjoy the surround sound created by 5.1 channel playback.

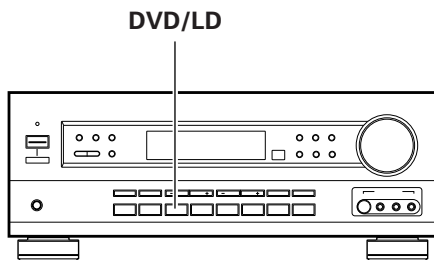

Press DVD/LD on the unit.

Each press switches the input: DVD/LD ↔ DVD/LD 5.1ch



- When DVD 5.1ch input is selected, Dolby mode, DSP mode, SIGNAL SELECT, input ATT, DIRECT, TONE, MIDNIGHT mode, DIGITAL NR and speakers B cannot be operated.
- When DVD 5.1ch input is selected, only the volume level and channel levels can be set.

Using Cinema Re-EQ

THX Cinema Re-EQ* is a process developed by Lucasfilm, Ltd. to make Dolby Surround soundtracks originally intended for playback at movie theaters sound more natural when played through a typical home theater set up. Due to differences in room acoustics and the kind of speakers typically used in movie theaters compared to those found in the home, some movie soundtracks can sound overly 'bright' when played on home systems. Cinema Re-EQ compensates for these differences for a more accurate presentation.

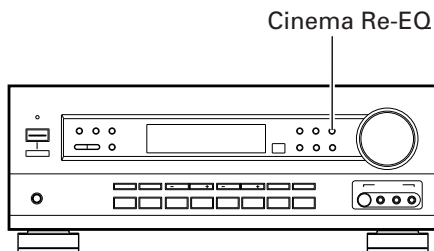

1 Select an input source.

Like the other surround effects, Cinema Re-EQ is not set universally, but for each input source separately.

2 Press Cinema Re-EQ to switch the effect on/off.



Since the Cinema Re-EQ effect is designed to work with Dolby surround software, ADVANCED THEATER (STANDARD) mode is switched on automatically when Cinema Re-EQ is switched on. Likewise, if any other ADVANCED THEATER mode except STANDARD is switched off while Cinema Re-EQ is on, Cinema Re-EQ will also be switched off.

DSP effects cannot be used together with Cinema Re-EQ. Switching on Cinema Re-EQ will automatically switch off any DSP effect currently set.

3 Playback the source material.

Cinema Re-EQ can safely be switched during playback.

* THX and Cinema Re-EQ are trademarks of Lucasfilm, Ltd.

Reducing noise during playback (DIGITAL NR function)

When DIGITAL NR is on, extraneous noise during playback can be reduced.

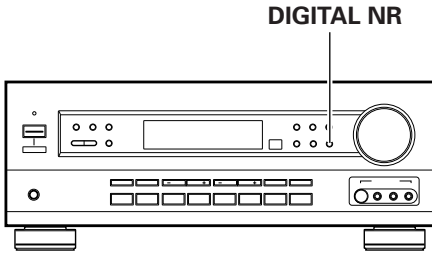

Press DIGITAL NR on the front panel.

Each press switches DIGITAL NR on or off.

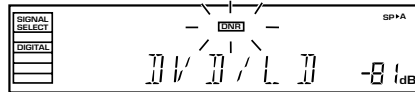

• In cases described below, DIGITAL NR cannot be used.

- ① Dolby/DTS mode is ON.
- ② DSP mode is ON.
- ③ DVD 5.1ch input is selected.
- ④ Dolby Digital or DTS signals are being input.

* When DIGITAL NR is on and Dolby Digital or DTS signals are input, DIGITAL NR is automatically switched off.

• In cases described below, noises may not be reduced even if DIGITAL NR is on.

- Sudden noise
- Extremely loud noise
- Signals that do not contain many high frequencies

• For each source, DIGITAL NR is effective at and above levels shown below.

- Cassette tape 20 dB
- Video tape 15 dB
- AM tuner 10 to 15 dB
- FM tuner 15 to 16 dB

* Depending on the condition of the source, there may not be a noticeable improvement in the quality of the sound.

Listening in MIDNIGHT Listening Mode

When the volume is low, surround effects tend to become less than satisfactory. Turn the MIDNIGHT listening mode on to enjoy the effects of quality surround sound even at low volumes. This mode allows you to hear effective surround sound of movies at low volume levels.

Press MIDNIGHT.

Each press switches MIDNIGHT listening mode on or off.

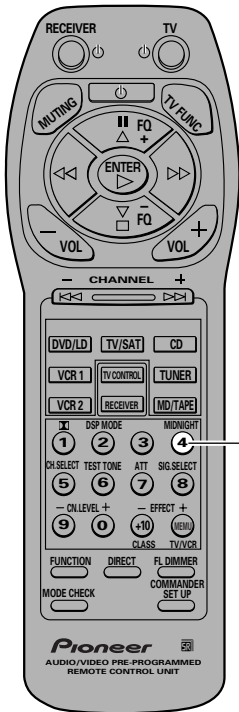

The effect automatically adjusts according to the volume level.

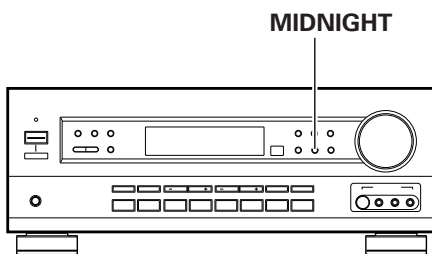

Automatic and Manual Tuning

The following steps show you how to tune in FM and AM radio broadcasts using the automatic (search) and manual (step) tuning functions. If you already know the exact frequency of the station you want, see "Direct Tuning" on the following page.

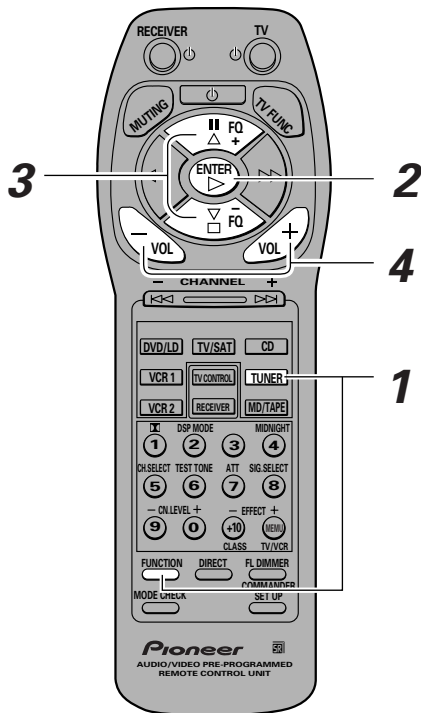

- 1 Press FUNCTION repeatedly on the remote or FM/AM on the front panel to select the tuner. Press TUNER to set the remote to the tuner operation mode.**

The station you were previously tuned to is received automatically.

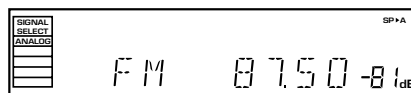

- 2 Press ENTER on the remote or FM/AM on the front panel to select the band (FM or AM).**

Each press switches the band: FM ↔ AM



- 3 Tune in the station.**

For Automatic Tuning

Press and hold FQ +/- (Δ/▽) for about one second, then release. The tuner starts searching the selected band and stops automatically at the first station it locates. Repeat to locate other stations.

For Manual Tuning

- To change frequencies one step at a time, press FQ +/- (Δ/▽) repeatedly.
- To change frequencies quickly, hold down FQ +/- (Δ/▽) and release when you reach the frequency you want.

When using the front panel

Press FREQUENCY (+/-) until the frequency you want appears in the display.

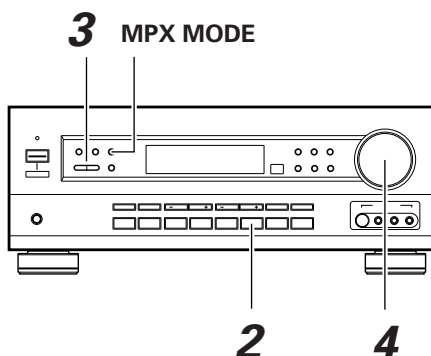

- 4 Adjust the volume.**

MPX Mode

If the TUNED or STEREO indicators do not light when tuning an FM station, because the station is too far away or the broadcast signal is weak, press MPX MODE on the front panel to switch to monaural (MONO) reception. This should improve reception enough for you to enjoy the broadcast.

Direct Tuning

The following steps show you how to tune directly to a specific frequency using the remote control.

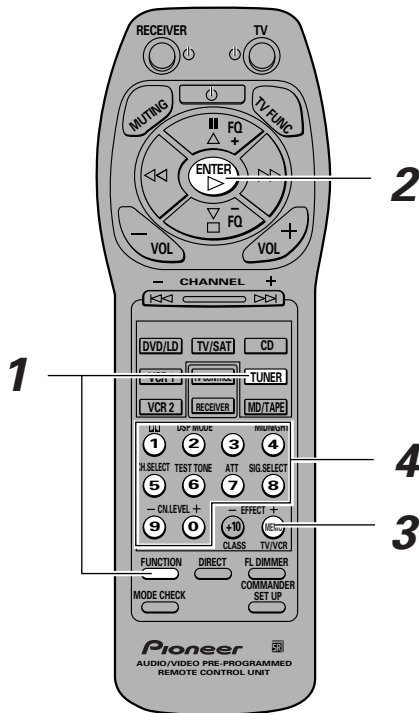

- 1 Press FUNCTION repeatedly on the remote or FM/AM on the front panel to select the tuner. Press TUNER to set the remote to the tuner operation mode.**

The station you were previously tuned to is received automatically.

- 2 Press ENTER to select the band (FM or AM).**

Each press switches the band: FM ↔ AM

- 3 Press MENU to activate the direct tuning mode.**

The cursor blinks in the display on the front panel.

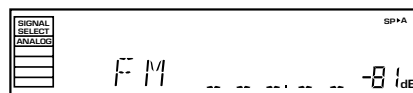

- 4 Use the number buttons to enter the frequency of the station you want.**

Example:

To tune station 106.00 (FM), press: ① → ⑥ → ⑦ → ① → ①

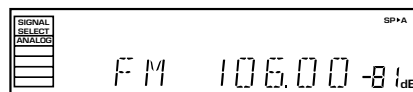

To cancel before inputting the frequency

Press MENU, and enter the frequency again.

Memorizing Frequently Tuned Stations

The following steps show you how to memorize up to 30 radio stations in 3 classes (each holding 10 channels). When memorizing FM frequencies, the receiver also memorizes the MPX mode (STEREO or MONO).

Using the front panel

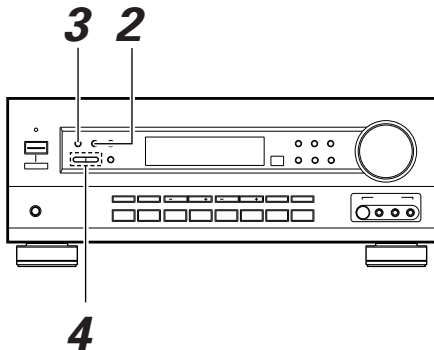

- 1 Tune in the station you want to have memorized.**
See "Automatic and Manual Tuning" or "Direct Tuning" on pages 36, 37.

- 2 Press MEMORY to activate the memory function.**
"A--" blinks in the display.



- 3 Press CLASS repeatedly to select a class.**
Each press switches the display:

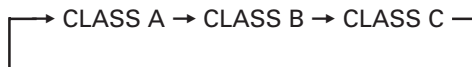

- 4 Press STATION (+/-) to select a channel (1~10) within the respective class.**

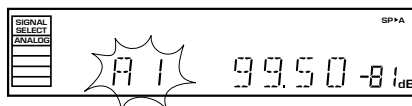

The station is memorized automatically after 5 seconds.

Repeat steps 1 through 4 to memorize up to 30 stations.

Recalling the Memorized Stations

Using the remote control

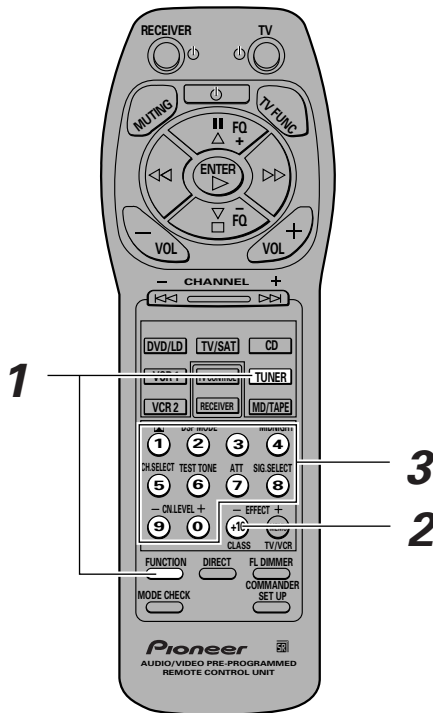

- 1 Press **FUNCTION** repeatedly on the remote or **FM/AM** on the front panel to select the tuner. Press **TUNER** to set the remote to the tuner operation mode.

The station you were previously tuned to is received automatically.

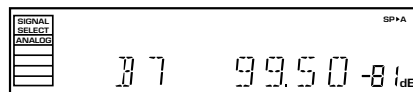

- 2 Press **CLASS** repeatedly to select a class.

Each press switches the display:

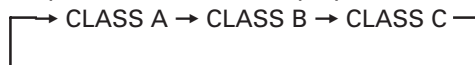

- 3 Use the **number buttons** to select the channel you want.

To select channel 7, press ⑦.

To select channel 10, press ⑩.

For example : If 99.50 MHz (FM) was memorized in class B at channel 7.

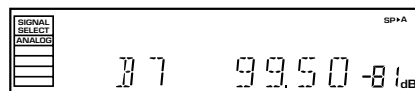

To skip through each channel in order

Press **CHANNEL +/-** repeatedly.

Using the front panel

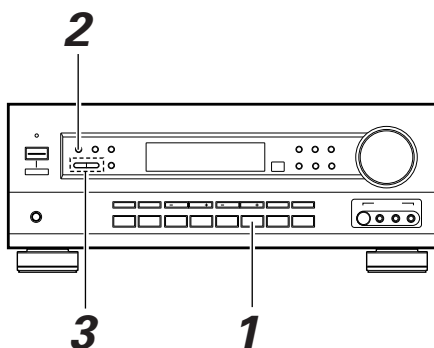

- 1 Press **FM/AM**.
- 2 Press **CLASS** repeatedly to select a class.
- 3 Press **STATION +/-** to select the channel you want.

Playback

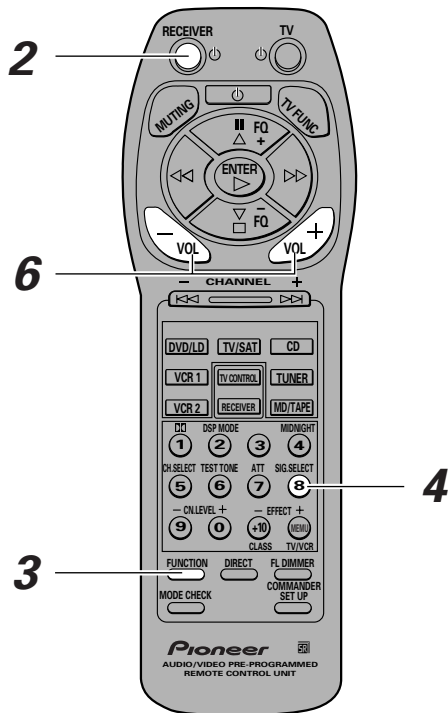

1 Turn on the power of the playback component.

2 Press **RECEIVER** to turn on the receiver. **STANDBY indicator**
Be sure that the standby indicator turns off on the front panel.



3 Press **FUNCTION** to select the source you want to playback.

The source you want to playback is displayed in the following order:

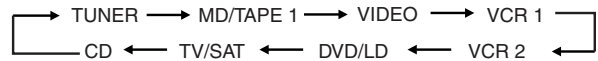

4 Press **SIG. SELECT** on the remote control or **SIGNAL SELECT** on the front panel to select the input signal corresponding to the source component.

(Refer to "Switching ANALOG/DIGITAL signal input" on page 29.)

5 Start playback of the component you selected in step 1.

6 Press **VOL (+/-)** to adjust the volume level in the range of --- dB (MIN) to 0 dB (MAX).



- Depending on the channel level setting, the MAX volume level may differ 0 to -10 dB from the level displayed.
- When this receiver is not going to be used for a long time, it is recommended that you turn off the main power.

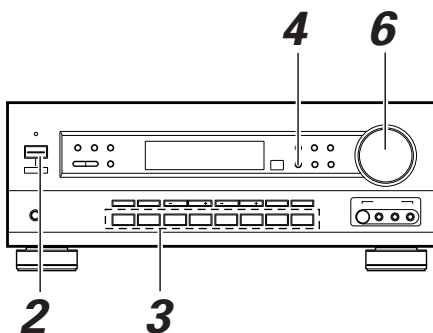

Adjusting bass and treble (tone control)

Use BASS (+/-) or TREBLE (+/-) to adjust the low and high frequencies.

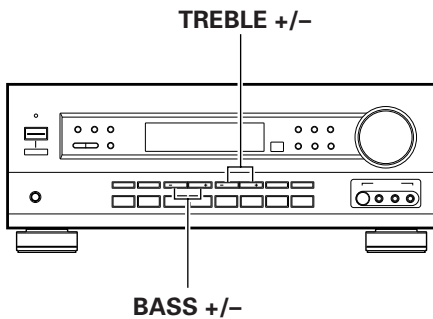

Press BASS (+/-) to adjust the low frequencies.

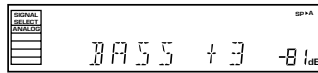

Press TREBLE (+/-) to adjust the high frequencies.

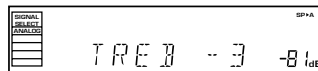

- The tone control can be adjusted in a range of ± 6 .
- Pressing + and - simultaneously restores the setting to 0.
- In cases described below, the tone control cannot be adjusted.
 - ① Dolby/DTS mode is ON.
 - ② DSP mode is ON.
 - ③ DVD 5.1ch input is selected.

Adjusting the brightness of the display

Use FL DIMMER to adjust the brightness of the fluorescent display.

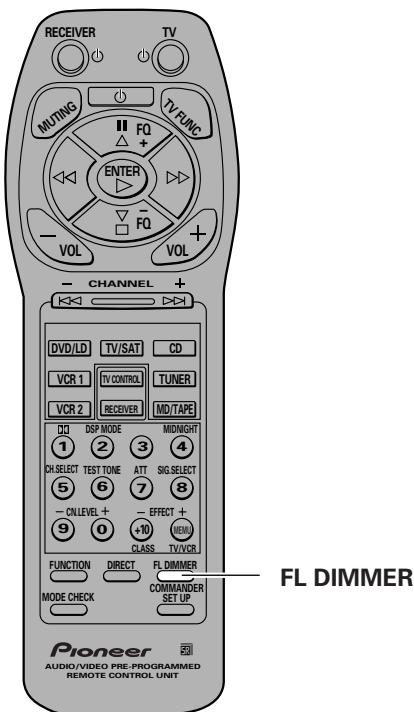

Press FL DIMMER.

Four levels of brightness ranging from very dim to very bright can be selected. Each press changes the brightness of the display. When rotating through the options, the default brightness can also be selected.



In standby, pressing STANDBY/ON while holding down the  /DTS button returns the display to the default brightness.

Recording from Audio Components

The following operations show you how to record audio to the cassette, DAT, or MD deck connected to the MD/TAPE 1 or TAPE 2 MONITOR jacks.



The receiver's volume, balance, tone (BASS, TREBLE, and LOUDNESS), and surround effects have no effect on the recorded signal.

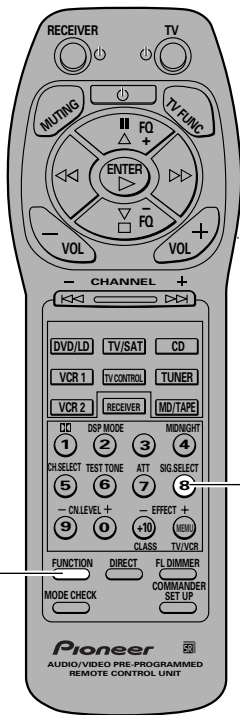

1 Select the component you want to record.

Press SIG. SELECT on the remote or SIGNAL SELECT on the front panel to select "ANALOG" when making analog recordings, or "DIGITAL" when making digital recordings. (Refer to "Switching ANALOG/DIGITAL signal input" on page 29.)

2 Prepare the program source.

(Tune in the radio station or load the CD, etc.)

3 Insert a blank tape into the cassette deck (MD/TAPE 1 or TAPE 2 MONITOR) and adjust the recording level (if necessary).

4 Start recording on the cassette deck, then start playback from the source component.

Record monitor (TAPE 2 MONITOR)

If you connect a cassette deck (etc.) with a record monitor function to the TAPE 2 MONITOR jacks, you can listen to the sound of the recording as it is being recorded.

Press TAPE 2 MONITOR to switch between the sound of the recording (TAPE 2 indicator on) and the sound of the source component (TAPE 2 indicator off).



- This receiver outputs the input signal directly to the recording device. As there is no conversion of the audio signal, recordings cannot be made from analog to digital, and similarly from digital to analog.
- Recordings cannot be made from TAPE 2 MONITOR to MD/TAPE 1.

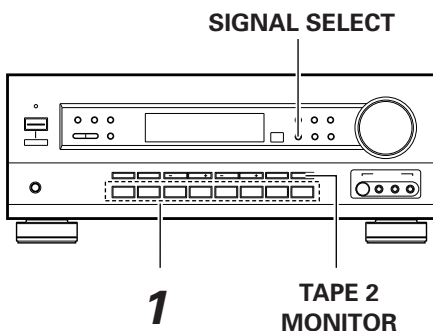

Recording from Video Components

The following operations show you how to record audio and video to the video tape recorder connected to the VCR 1 or VCR 2 jacks.



The receiver's volume, balance, tone (BASS, TREBLE, and LOUDNESS), and surround effects have no effect on the recorded signal.

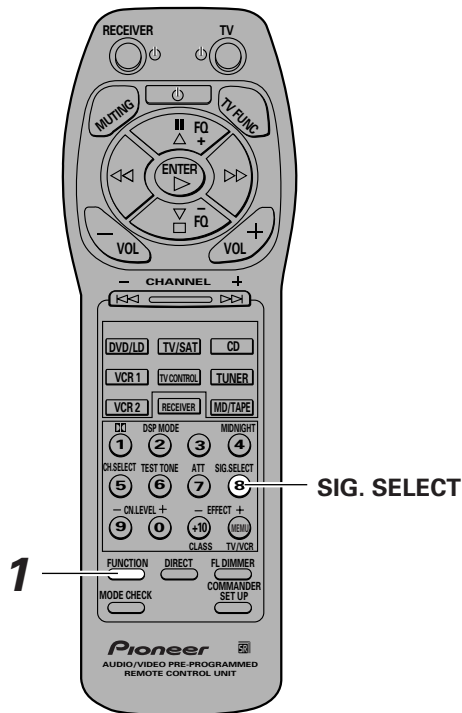

1 Select the component you want to record.

Be sure to press SIG. SELECT on the remote or SIGNAL SELECT on the front panel to choose "ANALOG". (Refer to "Switching ANALOG/DIGITAL signal input" on page 29.)

2 Prepare the program source.

(Load the DVD or LD, etc.)

3 Insert a blank tape into the video tape recorder (VCR 1).

4 Start recording on the video tape recorder, then start playback from the source component.



- Recording cannot be made from analog to digital, and similarly from digital to analog.
- When recording a DVD, the recorded image may flicker or be difficult to view because of the copy protection signal programmed on the DVD.

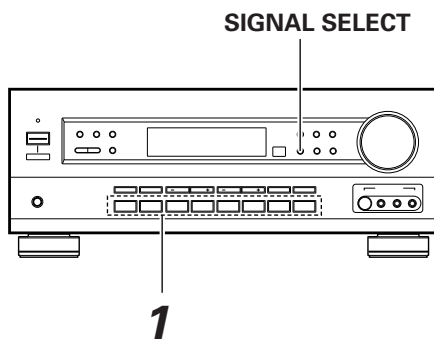

Remote Controlling Other Components

DVD or LD player operations



Before performing these operations, press the DVD/LD (MULTI CONTROL) button to switch the remote to the DVD/LD operation mode.

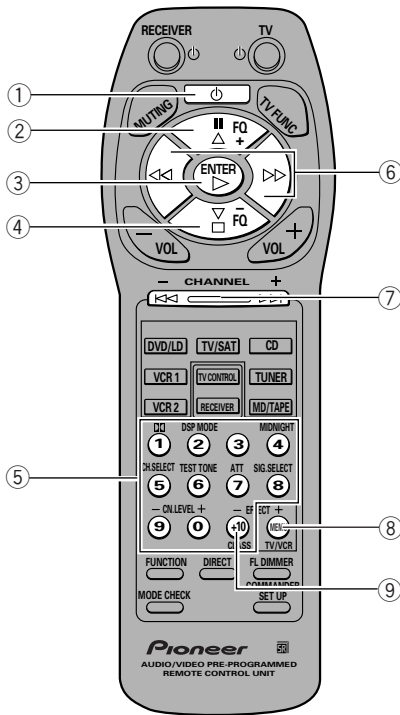

- ① Press to switch the DVD or LD player on or off.
- ② Press to pause playback. (With certain models, this button may freeze the frame.)
- ③ Press to start playback.
- ④ Press to stop playback. (With certain models, pressing this button when the unit is stopped may open the disc tray.)

⑤ Number buttons

Use to select chapters (tracks).

⑥

: Hold down for fast reverse playback.
 : Hold down for fast forward playback.

⑦

: Press to return to the beginning of the current chapter (track). Press repeatedly to return to the beginning of previous chapters (tracks).
 : Press to advance to the beginning of the next chapter (track). Press repeatedly to advance to the beginning of following chapters (tracks).

⑧ MENU

LD : Switches between sides A and B of the disc.
 DVD : Switches the menu screen on and off.

⑨ +10

Use when selecting chapter (track) numbers higher than 10.

To select chapter (track) 34, press :

+10 → +10 → +10 → 4

To select chapter (track) 20, press :

+10 → +10 → 0



Press DVD/LD (MULTI CONTROL) two times in succession to make the buttons blink. While the buttons are blinking, you can operate the player by pressing the following buttons.

② , ③ ENTER, ⑥ , ⑧ MENU key

⑨ title key

Pressing the DVD/LD button again or not pressing any buttons for 30 seconds returns the remote control to its former condition.

*With some Pioneer DVD and DVD/LD players, cursor operation can be performed without pressing DVD/LD.

TV operations



Before performing these operations, press TV CONTROL or TV/SAT (MULTI CONTROL) to switch the remote to the TV operation mode.

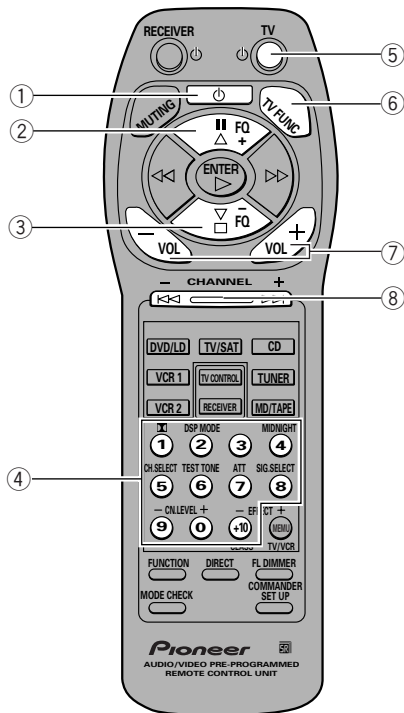

- ① Press to switch the TV on or off.
- ② Raises the volume of the TV.
- ③ Lowers the volume of the TV.
- ④ **Number buttons**
Use to select a specific TV channel.
- ⑤ **TV**
Press to switch the TV on or off. (This operation is possible regardless of the current remote operation mode, however, it can only be used with the component assigned to TV CONTROL.)
- ⑥ **TV FUNC**
Press to switch the TV's input (not possible with all models). (This operation is possible regardless of the current remote operation mode.)
- ⑦ **VOL (+/-)**
Use to adjust the volume of the TV.
- ⑧ **CHANNEL (+/-)**
Use to select a TV channel.

SAT (Satellite Tuner) operations



- The following operations are available from the receiver's remote control after you recall a Satellite tuner preset code (refer to "Setting up the Remote Control" on page 22).
- Before performing these operations, press the TV/SAT (MULTI CONTROL) button to switch the remote to the TV/SAT operation mode.

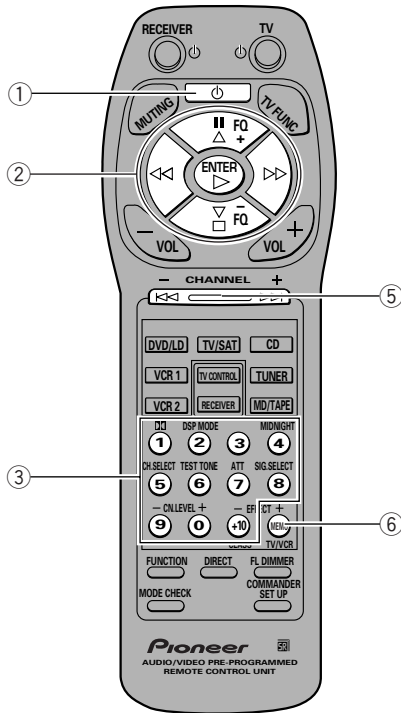

- ① Press to switch the satellite tuner on or off.
- ② Use as cursor buttons to obtain information about programs.
- ③ **Number buttons**
Use to select satellite channels.
- ④ **ENTER**
Press to select the position selected using the cursor buttons (///).
- ⑤ (**GUIDE**)
Use to turn the program information screen on or off.
- ⑥ **DISC (MENU)**
Use to turn the main menu on or off.

CD player operations



Before performing these operations, press the CD (MULTI CONTROL) button to switch the remote to the CD operation mode.

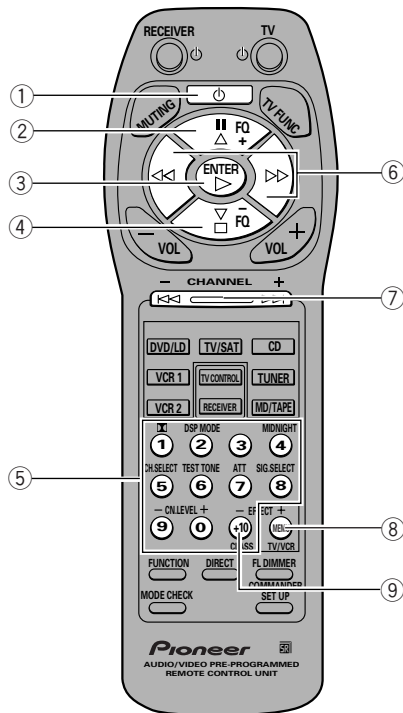

- ① Press to switch the CD player on or off.
- ② Press to pause playback.
- ③ Press to start playback.
- ④ Press to stop playback.
- ⑤ **Number buttons**
Use to select tracks.
- ⑥
 - ◀◀ : Hold down for fast reverse playback.
 - ▶▶ : Hold down for fast forward playback.
- ⑦
 - ◀◀ : Press to return to the beginning of the current track. Press repeatedly to return to the beginning of previous tracks.
 - ▶▶ : Press to advance to the beginning of the next track. Press repeatedly to advance to the beginning of following tracks.
- ⑧ **MENU**
For multi-disc CD changers, use to select the disc numbers (not possible with all models).
For example, to select disc 34, press :
3 → 4 → MENU.
- ⑨ **+10**
Use when selecting track numbers higher than 10.
For example, to select track 34, press :
+10 → +10 → +10 → 4

MD recorder operations



Before performing these operations, press the MD/TAPE (MULTI CONTROL) button to switch the remote to the MD/TAPE operation mode.

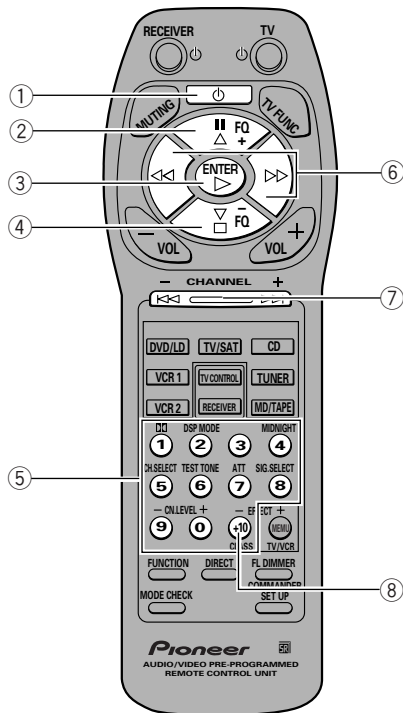

- ① Press to switch the MD recorder on or off.
- ② Press to pause playback.
- ③ Press to start playback.
- ④ Press to stop playback.
- ⑤ **Number buttons**
Use to select tracks.
- ⑥
 : Hold down for fast reverse playback.
 : Hold down for fast forward playback.
- ⑦
 : Press to return to the beginning of the current track. Press repeatedly to return to the beginning of previous tracks.
 : Press to advance to the beginning of the next track. Press repeatedly to advance to the beginning of following tracks.
- ⑧ **+10**
Use when selecting track numbers higher than 10 or 100.
For example (in case of MJ-D707 (PIONEER)),
1) To select track 15, press :
+10 → 1 → 5

2) To select track 115, press :
+10 → +10 → 1 → 1 → 5

To start recording

Press both ② and ④ simultaneously.

Cassette deck operations



Before performing these operations, press the MD/TAPE (MULTI CONTROL) button to switch the remote to the MD/TAPE operation mode.

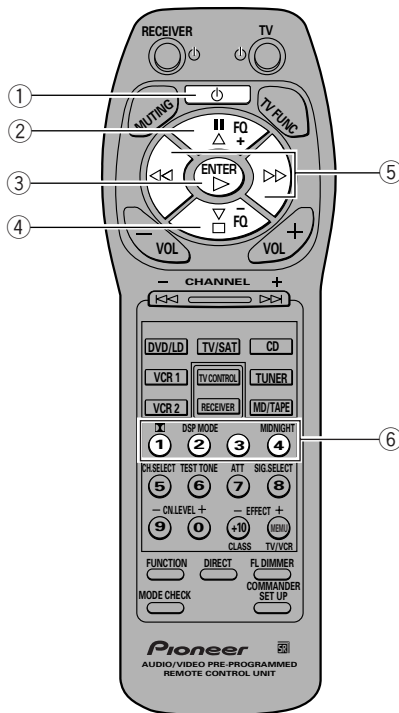

- ① Press to switch the cassette deck on or off (not possible with all models).
- ② Press to pause playback or recording.
- ③ Press to start playback.
- ④ Press to stop playback or recording.
- ⑤
 - : Press to rewind the tape. Hold down during playback for fast reverse playback (not possible with all models).
 - : Press to fast forward the tape. Hold down during playback for fast forward playback (not possible with all models).
- ⑥ **Number buttons**
 - Use to operate deck 1 of a double cassette deck (not possible with all cassette decks).
 - 1 button** () Press to rewind the tape. Hold down during playback for fast reverse playback (not possible with all models).
 - 2 button** () Press to stop playback or recording.
 - 3 button** () Press to start playback.
 - 4 button** () Press to fast forward the tape. Hold down during playback for fast forward playback.

To start recording

Press both ② and ④ simultaneously.
You cannot record on deck 1 of a double cassette deck.

VCR operations



Before performing these operations, press the VCR 1 or VCR 2 (MULTI CONTROL) button to switch the remote to the VCR operation mode.

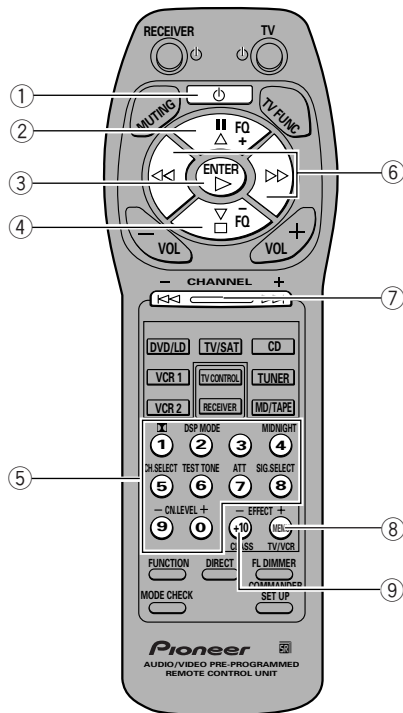

- ① Press to switch the VCR 1 or VCR 2 (VCR only on VSX-D508S) on or off (not possible with all models).
- ② Press to pause playback or recording.
- ③ Press to start playback.
- ④ Press to stop playback or recording.
- ⑤ **Number buttons**
Use to select a specific channel on the VCR's TV tuner.
- ⑥ **◀◀** : Press to rewind the tape. Hold down during playback for fast reverse playback (not possible with all models).
▶▶ : Press to fast forward the tape. Hold down during playback for fast forward playback (not possible with all models).
- ⑦ **CHANNEL (+/-)**
Use to change the channel of the VCR's TV tuner.
- ⑧ **TV/VCR**
Use to switch the VCR's antenna output between TV and VCR.
- ⑨ **+10 (ENTER)**
Use to select the channel specified with the number buttons (not all models require this step).

To start recording

Press both ② and ④ simultaneously.

Background Control of Other Components

The following steps show you how to control one component while listening to another. This may be useful if you want to rewind a tape while listening to CD, etc.

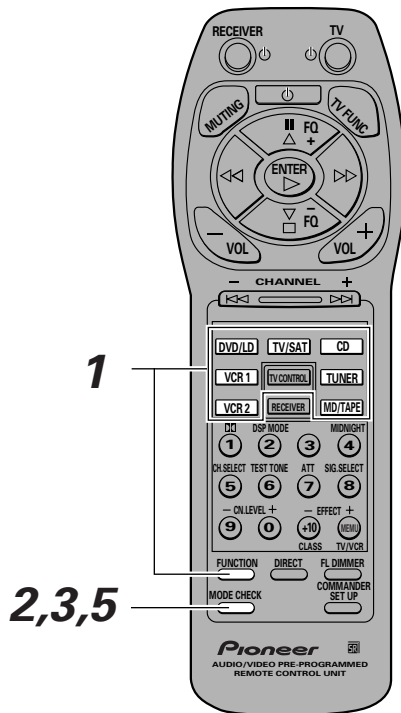

1 Select a component, then start playback.

For example:

Press FUNCTION to select the CD player, then press the CD button, and start playing a CD. (You should hear the sound of the CD playing back.)

2 Press MODE CHECK to display the current operation mode.

The corresponding MULTI CONTROL button lights up.

For example:

The CD button should light up to indicate that the remote is set to operate the CD player.

3 Press MODE CHECK repeatedly to select another operation mode.

Each time you press MODE CHECK, the next MULTI CONTROL button should light, enabling you to operate the selected device.

For example:

Press repeatedly to light the MD/TAPE button. The receiver's function remains set to CD (and you should still hear the CD player), but the remote control is now set to operate the tape deck.

4 Perform the desired operation(s).

The remote control remains in the selected operation mode, so you may perform as many operations as necessary.

For example :

Press ◀◀ to rewind the tape.

5 Press MODE CHECK repeatedly to switch back to the original operation mode.

You can also switch back to the original operation mode by pressing the corresponding MULTI CONTROL button.

For example :

Press MODE CHECK repeatedly to light the CD button, or press the CD button.

Dolby Digital

Dolby Digital is a compression format which records the sound of 6 channels of the theater surround system (Dolby Digital) on the movie film digital track. Of the 6 channels, the sub woofer channel is intended for bass only, and because the frequency range is smaller than the main channel, it is expressed as 5.1 channel.

Dolby Digital is the name of the Dolby surround multi-channel digital system that was developed after the Dolby Surround System and Dolby Pro Logic Surround System.

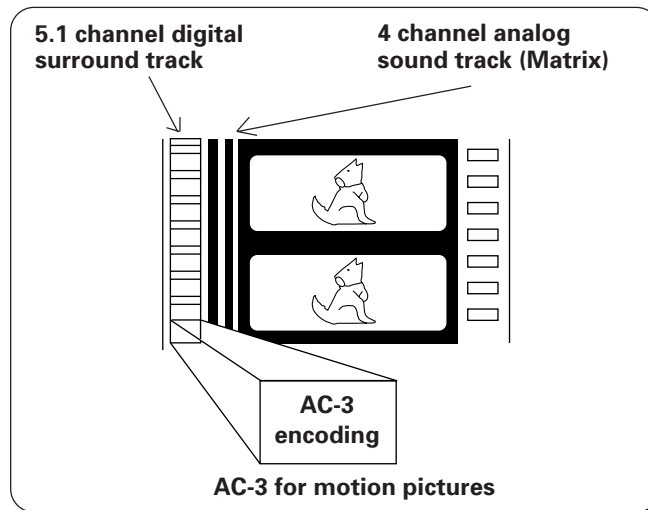

The number of movies made using Dolby Digital since 1992 has exceeded 300 and continues to increase. For compact disc players and laser disc digital sounds, 16 bits are used to sample the original analog audio waveform and sampling is carried out 44,100 times every second. However because an enormous amount of recording signal data is required for the multi channel system with this method, AC-3 is used to compress the data.

In reproducing audio signals, the smaller the bit number used, the lower the sound quality. With AC-3, drop in auditory sound quality is prevented by using masking technology and digital filtering technology based on the personal auditory characteristics.

Laser disc format

Laser discs are now available on the market in large numbers. This means that the recording of different format audio signals on the laser disc raises the important question of compatibility with existing laser discs. Dolby Digital records signals using one analog audio channel to maintain this compatibility with existing discs and players.

As shown in the following figure, the digital audio sounds of Dolby Digital discs can be played back as currently done. Analog sounds are played back by using the other channel without the Dolby Digital signals for monaural audio signals.

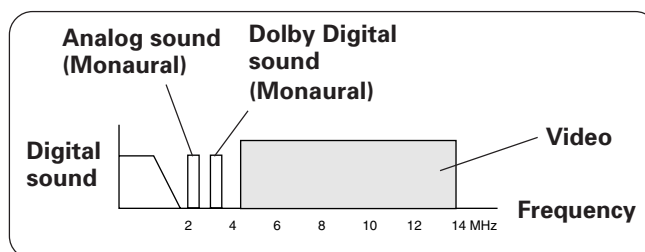

Comparison with Dolby Pro Logic Surround

Dolby Digital is also known as the 5.1 channel system. It is equipped with 5 channels (front left, front right, center, surround left, surround right) in the frequency range from 20 Hz to 20 kHz and an independent sub woofer channel. The sub woofer channel is also called LFE (Low Frequency Effect).

The LFE channel can be used as desired to enjoy strong bass sounds.

The table on the next page shows the comparison with Dolby Pro Logic Surround effects.

DTS

DTS has been adopted as a sound recording format in the latest movie theaters since the release of "JURASSIC PARK" in 1993, and has a good reputation for high quality sound and dynamic surround effects.

In this system, 6 channels of digital sound are recorded on CD-ROM, not on the film. It adopts a simultaneous playback format. With a low rate of compression of sound signals and a high rate of transmittance, higher sound quality format is produced. Also, unlike the process of recording digital sounds on film directly, the only components required are a CD-ROM player as might be used with a personal computer and a DTS processor, and therefore less investment is required than with other formats. For this reason, the format is being introduced in more and more movie theaters, and is being adopted in home movie software (DVD, LD) and music software (5.1 channel CD).

More than 11,000 movie theaters around the world have adopted the DTS format, which is now the most popular digital format for movie theaters, especially in U.S.A, Europe, and Asia.

	Dolby Digital	DTS	Dolby Pro Logic Surround
No. of recorded channels	5.1 channels (Max.)	6 channels (Max.)	2 channels
No. of playback channels	5.1 channels (Max.)	6 channels (Max.)	4 channels
Playback channel structure	Front Left, Front Right, Center, Surround Left, Surround Right, Sub Woofer	Front Left, Front Right, Center, Surround Left, Surround Right, Sub Woofer	Front Left, Front Right, Center, Surround
Sound processing	Digital discrete processing	Digital discrete processing	Analog matrix processing
Rear (Surround) high frequency playback limit	20,000 Hz	20,000 Hz	7,000 Hz
Other	<ul style="list-style-type: none"> • 5.1 completely independent channels • High dynamic range • Stable position, high phase characteristics, and advanced surround effects reproduction • High efficiency (Compression rate of about one-tenth) 	<ul style="list-style-type: none"> • 6 completely independent channels • High dynamic range • Stable position, high phase characteristics, and advanced surround effects reproduction • Low compression rate (about one-fourth), high quality sound 	

Troubleshooting

Incorrect operations are often mistaken for trouble and malfunctions. If you think that there is something wrong with this component, check the points below. Sometimes the trouble may lie in another component. Investigate the other components and electrical appliances being used. If the trouble cannot be rectified even after exercising the checks listed below, ask your nearest PIONEER authorized service center or your dealer to carry out repair work.

Symptom	Cause	Remedy
The power does not turn ON.	<ul style="list-style-type: none"> The power plug is disconnected. The protection circuit may have been activated. 	<ul style="list-style-type: none"> Connect the power plug to the wall outlet. Disconnect the power plug from the outlet, and insert again.
The unit does not respond when the buttons are pressed.	<ul style="list-style-type: none"> Static electricity caused by dry air. 	<ul style="list-style-type: none"> Disconnect the power plug from the outlet, and insert again.
No sound is output when a function is selected.	<ul style="list-style-type: none"> Improper connections. Sound is muted. The volume is turned down. The TAPE 2 MONITOR is ON. Speakers are turned OFF. 	<ul style="list-style-type: none"> Make sure the component is connected correctly (refer to pages 9 to 14). Press MUTING on the remote control. Adjust MASTER VOLUME. Press the TAPE 2 MONITOR button. Press SPEAKERS or SPEAKERS (A/B) to select the speakers you connected.
No image is output when a function is selected.	<ul style="list-style-type: none"> Improper connections. The input source is not properly selected. 	<ul style="list-style-type: none"> Make sure the component is connected correctly (refer to pages 10, 11). Press the correct function button.
Considerable noise in radio broadcasts.	<ul style="list-style-type: none"> Incorrect frequency. The antenna is not connected. AC-3 RF and/or digital cables are near the antenna terminals and wires. 	<ul style="list-style-type: none"> Tune in the correct frequency. Connect the antenna (refer to page 8). Route AC-3 RF and digital cables away from the antenna terminals and wires.
FM broadcasts		
	<ul style="list-style-type: none"> The FM antenna is not fully extended or is poorly positioned. Weak radio signals. 	<ul style="list-style-type: none"> Fully extend the FM wire antenna, position for best reception, and secure to a wall. Connect an outdoor FM antenna (refer to page 8).
AM broadcasts		
	<ul style="list-style-type: none"> The AM antenna is poorly positioned. Weak radio signals. Interference cause by other equipment (fluorescent lamp, motor, etc.). 	<ul style="list-style-type: none"> Adjust the direction and position for best reception. Connect an additional internal or external AM antenna (refer to page 8). Turn off the equipment causing the noise or move it away from the receiver. Place the antenna farther away from the equipment causing the noise.

Symptom	Cause	Remedy
Broadcast stations cannot be selected automatically.	<ul style="list-style-type: none"> Weak radio signals. 	<ul style="list-style-type: none"> Connect an outdoor antenna (refer to page 8).
No sound from surround or center speakers.	<ul style="list-style-type: none"> Speaker settings are incorrect. The rear and/or center levels are turned down. The surround and/or center speakers are disconnected. 	<ul style="list-style-type: none"> Refer to "SPEAKER setting mode" on page 17 to check the speaker settings. Refer to "Setting the volume level of each channel" on page 21 to check the speaker levels. Connect the speakers (refer to page 13).
Sound is produced from other components, but not from LD or DVD player.	<ul style="list-style-type: none"> SIGNAL SELECT is set incorrectly. The digital inputs are assigned incorrectly, or not at all. 	<ul style="list-style-type: none"> Set SIGNAL SELECT to "DIGITAL" or "ANALOG" according to the type of connections made (refer to page 29). Set the digital input settings correctly (refer to page 16, 20, 21).
No sound is output or a noise is output when software with DTS is played back.	<ul style="list-style-type: none"> SIGNAL SELECT is set to "ANALOG". A DVD player not compatible with DTS is used, or the setting of the DVD player is incorrect. The digital output level is adjusted on a CD player or other component equipped with digital output level adjustment capability. (The DTS signal has been altered by the player, and cannot be read.) 	<ul style="list-style-type: none"> Make digital connections (refer to page 11) and set SIGNAL SELECT to "DIGITAL" (refer to page 29). Refer to the instruction manual supplied with the DVD player. Set the digital volume level of the player to full, or to the neutral position.
The sound is output intermittently when software with DTS is played back.	<ul style="list-style-type: none"> The overload indicator is lighting (refer to page 24). 	<ul style="list-style-type: none"> Set the ADVANCED THEATER mode to STANDARD (refer to page 32).
When a search is performed by a DTS compatible CD player during playback, noise is output.	<ul style="list-style-type: none"> The search function performed by the player slightly alters the digital information, making it unreadable. 	<ul style="list-style-type: none"> This is not a malfunction, but be sure to turn the volume down to prevent the output of loud noise from your speakers.
Cannot be remote controlled.	<ul style="list-style-type: none"> The remote control batteries have worn out. Too far away or bad angle of operation. There is an obstacle between the receiver and the remote control. Strong light such as fluorescent light is shining onto the unit's remote control signal light-receiving window. A cord is connected to the CONTROL IN terminal on this unit. 	<ul style="list-style-type: none"> Replace the batteries (refer to page 6). Operate within 23 feet (7 m), 30° of the remote sensor on the front panel (refer to page 7). Remove the obstacle or operate from another position. Avoid exposing the remote sensor on the front panel to direct light. Connect cord to the correct jack.
The display is dark.	<ul style="list-style-type: none"> The FL DIMMER button is pushed. 	<ul style="list-style-type: none"> Press FL DIMMER on the remote control repeatedly to return to the default.

If the unit does not operate normally due to external effects such as static electricity

Disconnect the power plug from the outlet and insert again to return to normal operating conditions.

Preset Code List

Device	Manufacturer	Code	Device	Manufacturer	Code
DVD	TOSHIBA	001	TAPE	OPTIMUS	800
	SONY	002		PIONEER	800
	PANASONIC	003	CD	SONY	301,316,317,318
	JVC	004		TECHNICS	304,326
	SAMSUNG	005		KENWOOD	310,321,311
	SHARP	006		DENON	309
	AKAI	007		RCA	302,319,313
	RCA	009		PHILIPS	312,322
	PIONEER	000, 003		YAMAHA	315,314,328
LD	SONY	101	JVC	303	
	PANASONIC	105,106	TEAC	305,306,327,324,325	
	KENWOOD	103	ONKYO	320,308,307	
	PHILIPS	104	MARANTZ	323,312,324	
	mitsubishi	100	SANYO	313	
	RCA	107	OPTIMUS	300	
	PIONEER	100	PIONEER	300,329	
SAT	RCA	201,203	MD	SONY	901
	SONY	202		KENWOOD	903
	PIONEER	200		SHARP	902
VCR	RCA	401,406,408,414,405,413,411 415		TEAC	904
	ZENITH	403,404,417		ONKYO	905
	MAGNAVOX	414,408,426,403		DENON	906
	FISHER	410,426,412,427,425,420	PIONEER	900,902	
	PANASONIC	408,432,433	TV	RCA	601,610,615,616,617,618
	TOSHIBA	405,409,426		ZENITH	603,620
	JVC	428,430,429,408,414,431,407		MAGNAVOX	607,610,603,612,629
	HITACHI	408,401,406,436,434		GE	601,608,607,610,617,602,628 618
	SONY	416,417,404,408		PANASONIC	608,622,607
	MITSUBISHI	409,420,421,422,423,424,408 407		SONY	604
	SANYO	410,412,425,435		TOSHIBA	605,602,626,621
	SHARP	402,418,419		MITSUBISHI	609,610,602,621
	GOLDSTAR	411,409		HITACHI	606,610,624,625,618
	OPTIMUS	408,432,433,402,418,419		JVC	613,623
	GRANDIENTE	452		SHARP	602,619,627
	PIONEER	400,453	SANYO	621,614	
	TAPE	SONY	801,806	PHILIPS	607
TECHNICS		803	GOLDSTAR	610,623,621,602	
KENWOOD		804,807	RADIO	610,623,621,602	
TEAC		805	SHACK		
DENON		810	GRADIENTE	635	
ONKYO		809,808	PIONEER	600	
YAMAHA		811,812	CATV*	JERROLD	711,701,702,712,704,713,703 714,716,715
JVC		802		S.A.	705,706,708,709
FISHER		813		ZENITH	707,717,710
				PIONEER	700

* The CATV codes are preset into TV CONTROL.

Specifications

Amplifier Section

Continuous average power output of 100 watts* per channel, min., at 8 ohms, from 20 Hz to 20,000 Hz with no more than 0.09% total harmonic distortion (front).**

Continuous Power Output

Front	100 W + 100 W (1 kHz, 0.8 %, 8 Ω)
Center	100 W (1 kHz, 0.8 %, 8 Ω)
Rear	100 W + 100 W (1 kHz, 0.8 %, 8 Ω)

Continuous Power Output (DIN)

Front	120 W + 120 W (1 kHz, T.H.D. 1 %, 8 Ω)
-------------	--

Input (Sensitivity/Impedance)

VCR 1, VCR 2, DVD/LD, TV/SAT, VIDEO, CD, MD/TAPE, TAPE 2	200 mV/47 kΩ
--	--------------

Frequency Response

VCR 1, VCR 2, DVD/LD, TV/SAT, VIDEO, CD, MD/TAPE, TAPE 2	5 Hz to 100,000 Hz $_{-3}^{+0}$ dB
--	------------------------------------

Output (Level/Impedance)

VCR 1 REC, VCR 2 REC, MD/TAPE REC, TAPE 2 REC	200 mV/2.2 kΩ
---	---------------

Tone Control

BASS	± 6 dB (100 Hz)
TREBLE	± 6 dB (10 kHz)
LOUDNESS	+9 dB/+7 dB (100 Hz/10 kHz)

Signal-to-Noise Ratio (IHF, short circuited, A network)

VCR 1, VCR 2, DVD/LD, TV/SAT, VIDEO, CD, MD/TAPE, TAPE 2	97 dB
--	-------

Signal-to-Noise Ratio [EIA, at 1 W (1 kHz)]

VCR 1, VCR 2, DVD/LD, TV/SAT, VIDEO, CD, MD/TAPE, TAPE 2	80 dB
--	-------

VIDEO Section

Input (Sensitivity/Impedance)

VCR 1, VCR 2, DVD/LD, TV/SAT, VIDEO	1 Vp-p/75 Ω
---	-------------

Output (Level/Impedance)

VCR 1, VCR 2, MONITOR	1 Vp-p/75 Ω
-----------------------------	-------------

Frequency Response

VCR 1, VCR 2, MONITOR	5 Hz to 7 MHz $_{-3}^{+0}$ dB
-----------------------------	-------------------------------

Signal-to-Noise Ratio

.....	55 dB
-------	-------

Cross Talk

.....	55 dB
-------	-------

* Measured pursuant to the Federal Trade Commission's Trade Regulation rule on Power Output Claims for Amplifiers.

** Measured by Audio Spectrum Analyzer.

FM Tuner Section

Frequency Range	87.5 MHz to 108 MHz
Usable Sensitivity	Mono: 13.2 dBf, IHF (1.3 μV/75 Ω)
50 dB Quieting Sensitivity	Mono: 20.2 dBf
.....	Stereo: 38.6 dBf
Signal-to-Noise Ratio	Mono: 73 dB (at 85 dBf)
.....	Stereo: 70 dB (at 85 dBf)
Distortion	Stereo: 0.5 % (1 kHz)
Alternate Channel Selectivity	60 dB (400 kHz)
Stereo Separation	40 dB (1 kHz)
Frequency Response	30 Hz to 15 kHz (± 1) dB
Antenna Input	75 Ω unbalanced

AM Tuner Section

Frequency Range	531 kHz to 1,620 kHz
Sensitivity (IHF, Loop antenna)	350 μV/m
Selectivity	25 dB
Signal-to-Noise Ratio	50 dB
Antenna	Loop antenna

Miscellaneous

Power Requirement	AC 120 V, 60 Hz
Power Consumption	280 W, 400 VA
Power Consumption in Standby mode	2.5 W
AC Outlet	
SWITCHED	100 W (0.8 A) MAX
Dimensions	420 (W) × 158 (H) × 401 (D) mm
.....	16-9/16 (W) × 6-1/4 (H) × 15-6/8 (D) in
Weight (without package)	9.8 kg (21 lb 10 oz)

Furnished Parts

FM Antenna	1
AM Loop Antenna	1
Dry Cell Batteries (SIZE "AA" (IEC LR6))	2
Remote Control Unit	1
Operating Instructions	1
Sub instruction manual [System Set up]	1

NOTE:

Specifications and the design are subject to possible modifications without notice, due to improvements.



Dear Customer:

Selecting fine audio equipment such as the unit you've just purchased is only the start of your musical enjoyment. Now it's time to consider how you can maximize the fun and excitement your equipment offers. This manufacturer and the Electronic Industries Association's Consumer Electronics Group want you to get the most out of your equipment by playing it at a safe level. One that lets the sound come through loud and clear without annoying blaring or distortion-and, most importantly, without affecting your sensitive hearing.

Sound can be deceiving. Over time your hearing "comfort level" adapts to higher volumes of sound. So what sounds "normal" can actually be loud and harmful to your hearing. Guard against this by setting your equipment at a safe level BEFORE your hearing adapts.

To establish a safe level:

- Start your volume control at a low setting.
- Slowly increase the sound until you can hear it comfortably and clearly, and without distortion.

Once you have established a comfortable sound level:

- Set the dial and leave it there.

Taking a minute to do this now will help to prevent hearing damage or loss in the future. After all, we want you listening for a lifetime.

Power cord CAUTION!

Handle the power cord by the plug. Do not pull out the plug by tugging the cord and never touch the power cord when your hands are wet as this could cause a short circuit or electric shock. Do not place the unit, a piece of furniture, etc., on the power cord, or pinch the cord. Never make a knot in the cord or tie it with other cords. The power cords should be routed such that they are not likely to be stepped on. A damaged power cord can cause a fire or give you an electrical shock. Check the power cord once in a while. When you find it damaged, ask your nearest PIONEER authorized service center or your dealer for a replacement.

For Assistance With Basic Set-up, Operation, or Trouble Shooting, You May Contact Our Customer Service Hotline at 1(800)421-1404(USA ONLY)

We Want You Listening For A Lifetime

Used wisely, your new sound equipment will provide a lifetime of fun and enjoyment. Since hearing damage from loud noise is often undetectable until it is too late, this manufacturer and the Electronic Industries Association's Consumer Electronics Group recommend you avoid prolonged exposure to excessive noise. This list of sound levels is included for your protection.

Decibel

Level	Example
30	Quiet library, soft whispers
40	Living room, refrigerator, bedroom away from traffic
50	Light traffic, normal conversation, quiet office
60	Air conditioner at 20 feet, sewing machine
70	Vacuum cleaner, hair dryer, noisy restaurant
80	Average city traffic, garbage disposals, alarm clock at two feet.

THE FOLLOWING NOISES CAN BE DANGEROUS UNDER CONSTANT EXPOSURE

90	Subway, motorcycle, truck traffic, lawn mower
100	Garbage truck, chain saw, pneumatic drill
120	Rock band concert in front of speakers, thunderclap
140	Gunshot blast, jet plane
180	Rocket launching pad

Information courtesy of the Deafness Research Foundation.



Maintenance of External Surfaces

- Use a polishing cloth or dry cloth to wipe off dust and dirt.
- When the surfaces are dirty, wipe with a soft cloth dipped in some neutral cleanser diluted five or six times with water, and wrung out well, and then wipe again with a dry cloth. Do not use furniture wax or cleaners.
- Never use thinners, benzine, insecticide sprays or other chemicals on or near this unit, since these will corrode the surfaces.

Should this product require service in the U.S.A. and you wish to locate the nearest Pioneer Authorized Independent Service Company, or if you wish to purchase replacement parts, operating instructions, service manuals, or accessories, please call the number shown below.

8 0 0 – 4 2 1 – 1 4 0 4

Please do not ship your product to Pioneer without first calling the Customer Service Department at the above listed number for assistance.

PIONEER ELECTRONICS SERVICE, INC.
CUSTOMER SERVICE DEPARTMENT
P.O. BOX 1760, LONG BEACH,
CA 90801-1760, U.S.A.

For warranty information please see the Limited Warranty sheet included with your product.

Should this product require service in Canada, please contact a Pioneer Canadian Authorized Dealer to locate the nearest Pioneer Authorized Service Company in Canada.
Alternatively, please contact the Customer Service Department at the following address:

Pioneer Electronics of Canada, Inc.
Customer Service Department
300 Allstate Parkway, Markham, Ontario L3R
OP2
(905) 479-4411
1-877-283-5901

For warranty information please see the Limited Warranty sheet included with your product.

Si ce produit doit être réparé au Canada, veuillez vous adresser à un distributeur autorisée Pioneer au Canada pour obtenir le nom de la Société de Service Autorisée Pioneer le plus près de chez vous. Ou encore, veuillez vous communiquer avec le Service de Clientèle de Pioneer:

Pioneer électroniques du Canada, Inc.
Département de service au consommateurs
300 Allstate Parkway, Markham, Ontario L3R
OP2
(905) 479-4411
1-877-283-5901

Pour obtenir des renseignements sur la garantie, veuillez vous reporter au feuillet sur la Garantie Limitée qui accompagne le produit.

Published by Pioneer Electronic Corporation.
Copyright © 1999 Pioneer Electronic Corporation.
All rights reserved.

PIONEER ELECTRONIC CORPORATION 4-1, Meguro 1-Chome, Meguro-ku, Tokyo 153-8654, Japan
PIONEER ELECTRONICS [USA] INC. P.O. BOX 1540, Long Beach, California 90801-1540
PIONEER ELECTRONICS OF CANADA, INC. 300 Allstate Parkway, Markham, Ontario L3R OP2, Canada
PIONEER ELECTRONIC [EUROPE] N.V. Haven 1087, Keetberglaan 1, 9120 Melsele, Belgium TEL: 03/570.05.11
PIONEER ELECTRONICS AUSTRALIA PTY. LTD. 178-184 Boundary Road, Braeside, Victoria 3195, Australia, TEL: 03-9586-6300
PIONEER ELECTRONICS DE MEXICO S.A. DE C.V. San Lorenzo Num 1009 3er piso Desp. 302 Col. Del Valle, Mexico D.F. C.P. 03100 TEL: 5-688-52-90

Free Manuals Download Website

<http://myh66.com>

<http://usermanuals.us>

<http://www.somanuals.com>

<http://www.4manuals.cc>

<http://www.manual-lib.com>

<http://www.404manual.com>

<http://www.luxmanual.com>

<http://aubethermostatmanual.com>

Golf course search by state

<http://golfingnear.com>

Email search by domain

<http://emailbydomain.com>

Auto manuals search

<http://auto.somanuals.com>

TV manuals search

<http://tv.somanuals.com>