

*Pioneer*

**AUDIO/VIDEO  
MULTI-CHANNEL RECEIVER**

**VSX-D710S**

**VSX-D810S**

**VSX-D850S**

**Operating Instructions**

**WARNING:** TO PREVENT FIRE OR SHOCK HAZARD, DO NOT EXPOSE THIS APPLIANCE TO RAIN OR MOISTURE.

THE STANDBY/ON BUTON IS SECONDARY CONNECTED AND THEREFORE DOES NOT SEPARATE THE UNIT FROM MAINS POWER IN STANDBY POSITION.

## IMPORTANT



The lightning flash with arrowhead symbol, within an equilateral triangle, is intended to alert the user to the presence of uninsulated "dangerous voltage" within the product's enclosure that may be of sufficient magnitude to constitute a risk of electric shock to persons.

**CAUTION**  
RISK OF ELECTRIC SHOCK  
DO NOT OPEN

CAUTION:  
TO PREVENT THE RISK OF ELECTRIC SHOCK, DO NOT REMOVE COVER (OR BACK). NO USER-SERVICEABLE PARTS INSIDE. REFER SERVICING TO QUALIFIED SERVICE PERSONNEL.



The exclamation point within an equilateral triangle is intended to alert the user to the presence of important operating and maintenance (servicing) instructions in the literature accompanying the appliance.

**NOTE:** This equipment has been tested and found to comply with the limits for a Class B digital device, pursuant to Part 15 of the FCC Rules. These limits are designed to provide reasonable protection against harmful interference in a residential installation. This equipment generates, uses, and can radiate radio frequency energy and, if not installed and used in accordance with the instructions, may cause harmful interference to radio communications. However, there is no guarantee that interference will not occur in a particular installation. If this equipment does cause harmful interference to radio or television reception, which can be determined by turning the equipment off and on, the user is encouraged to try to correct the interference by one or more of the following measures:

- Reorient or relocate the receiving antenna.
- Increase the separation between the equipment and receiver.
- Connect the equipment into an outlet on a circuit different from that to which the receiver is connected.
- Consult the dealer or an experienced radio/TV technician for help.

## IMPORTANT NOTICE

The serial number for this equipment is located on the rear panel. Please write this serial number on your enclosed warranty card and keep it in a secure area. This is for your security.

### [For Canadian model]

This Class B digital apparatus complies with Canadian ICES-003.

### [Pour le modèle Canadien]

Cet appareil numérique de la classe B est conforme à la norme NMB-003 du Canada.

*Manufactured under license from Dolby Laboratories. "Dolby", "Pro Logic" and the double-D symbol are trademarks of Dolby Laboratories. Confidential Unpublished Works. © 1992-1997 Dolby Laboratories, Inc. All rights reserved.*

## [For Canadian model]

**CAUTION:** TO PREVENT ELECTRIC SHOCK DO NOT USE THIS (POLARIZED) PLUG WITH AN EXTENSION CORD, RECEPTACLE OR OTHER OUTLET UNLESS THE BLADES CAN BE FULLY INSERTED TO PREVENT BLADE EXPOSURE.

**ATTENTION:** POUR PREVENIR LES CHOCS ELECTRIQUES NE PAS UTILISER CETTE FICHE POLARISEE AVEC UN PROLONGATEUR, UNE PRISE DE COURANT OU UNE AUTRE SORTIE DE COURANT, SAUF SI LES LAMES PEUVENT ETRE INSERES A FOND SANS EN LAISSER AUCUNE PARTIE A DECOUVERT.

*"DTS", "ES" and "DTS Digital Surround" are trademarks of Digital Theater Systems, Inc. Manufactured under license from Digital Theater Systems, Inc.*

### [For U.S. model]



As an ENERGY STAR® Partner, Pioneer Corporation has determined that this product meets the ENERGY STAR® guidelines for energy efficiency. K001 En

If the socket outlets on the associated equipment are not suitable for the plug supplied with the product, the plug must be removed and an appropriate one fitted. Replacement and mounting of an AC plug on the power supply cord of this unit should be performed only by qualified service personnel. The cut-off plug must be disposed of as an electrical shock hazard could exist if connected to a socket outlet. H022AE n

## Information to User

Alteration or modifications carried out without appropriate authorization may invalidate the user's right to operate the equipment.

# IMPORTANT SAFETY INSTRUCTIONS

**READ INSTRUCTIONS** — All the safety and operating instructions should be read before the product is operated.

**RETAIN INSTRUCTIONS** — The safety and operating instructions should be retained for future reference.

**HEED WARNINGS** — All warnings on the product and in the operating instructions should be adhered to.

**FOLLOW INSTRUCTIONS** — All operating and use instructions should be followed.

**CLEANING** — Unplug this product from the wall outlet before cleaning. The product should be cleaned only with a polishing cloth or a soft dry cloth. Never clean with furniture wax, benzine, insecticides or other volatile liquids since they may corrode the cabinet.

**ATTACHMENTS** — Do not use attachments not recommended by the product manufacturer as they may cause hazards.

**WATER AND MOISTURE** — Do not use this product near water — for example, near a bathtub, wash bowl, kitchen sink, or laundry tub; in a wet basement; or near a swimming pool; and the like.

**ACCESSORIES** — Do not place this product on an unstable cart, stand, tripod, bracket, or table. The product may fall, causing serious injury to a child or adult, and serious damage to the product. Use only with a cart, stand, tripod, bracket, or table recommended by the manufacturer, or sold with the product. Any mounting of the product should follow the manufacturer's instructions, and should use a mounting accessory recommended by the manufacturer.

**CART** — A product and cart combination should be moved with care. Quick stops, excessive force, and uneven surfaces may cause the product and cart combination to overturn.



**VENTILATION** — Slots and openings in the cabinet are provided for ventilation and to ensure reliable operation of the product and to protect it from overheating, and these openings must not be blocked or covered. The openings should never be blocked by placing the product on a bed, sofa, rug, or other similar surface. This product should not be placed in a built-in installation such as a bookcase or rack unless proper ventilation is provided or the manufacturer's instructions have been adhered to.

**POWER SOURCES** — This product should be operated only from the type of power source indicated on the marking label. If you are not sure of the type of power supply to your home, consult your product dealer or local power company.

**LOCATION** — The appliance should be installed in a stable location.

**NONUSE PERIODS** — The power cord of the appliance should be unplugged from the outlet when left unused for a long period of time.

## GROUNDING OR POLARIZATION

- If this product is equipped with a polarized alternating current line plug (a plug having one blade wider than the other), it will fit into the outlet only one way. This is a safety feature. If you are unable to insert the plug fully into the outlet, try reversing the plug. If the plug should still fail to fit, contact your electrician to replace your obsolete outlet. Do not defeat the safety purpose of the polarized plug.
- If this product is equipped with a three-wire grounding type plug, a plug having a third (grounding) pin, it will only fit into a grounding type power outlet. This is a safety feature. If you are unable to insert the plug into the outlet, contact your electrician to replace your obsolete outlet. Do not defeat the safety purpose of the grounding type plug.

**POWER-CORD PROTECTION** — Power-supply cords should be routed so that they are not likely to be walked on or pinched by items placed upon or against them, paying particular attention to cords at plugs, convenience receptacles, and the point where they exit from the product.

**OUTDOOR ANTENNA GROUNDING** — If an outside antenna or cable system is connected to the product, be sure the antenna or cable system is grounded so as to provide some protection against voltage surges and built-up static charges. Article 810 of the National Electrical Code, ANSI/NFPA 70, provides information with regard to proper grounding of the mast and supporting structure, grounding of the lead-in wire to an antenna discharge unit, size of grounding conductors, location of antenna-discharge unit, connection to grounding electrodes, and requirements for the grounding electrode. See Figure A.

**LIGHTNING** — For added protection for this product during a lightning storm, or when it is left unattended and unused for long periods of time, unplug it from the wall outlet and disconnect the antenna or cable system. This will prevent damage to the product due to lightning and power-line surges.

**POWER LINES** — An outside antenna system should not be located in the vicinity of overhead power lines or other electric light or power circuits, or where it can fall into such power lines or circuits. When installing an outside antenna system, extreme care should be taken to keep from touching such power lines or circuits as contact with them might be fatal.

**OVERLOADING** — Do not overload wall outlets, extension cords, or integral convenience receptacles as this can result in a risk of fire or electric shock.

**OBJECT AND LIQUID ENTRY** — Never push objects of any kind into this product through openings as they may touch dangerous voltage points or short-out parts that could result in a fire or electric shock. Never spill liquid of any kind on the product.

**SERVICING** — Do not attempt to service this product yourself as opening or removing covers may expose you to dangerous voltage or other hazards. Refer all servicing to qualified service personnel.

**DAMAGE REQUIRING SERVICE** — Unplug this product from the wall outlet and refer servicing to qualified service personnel under the following conditions:

- When the power-supply cord or plug is damaged.
- If liquid has been spilled, or objects have fallen into the product.
- If the product has been exposed to rain or water.
- If the product does not operate normally by following the operating instructions. Adjust only those controls that are covered by the operating instructions as an improper adjustment of other controls may result in damage and will often require extensive work by a qualified technician to restore the product to its normal operation.
- If the product has been dropped or damaged in any way.
- When the product exhibits a distinct change in performance — this indicates a need for service.

**REPLACEMENT PARTS** — When replacement parts are required, be sure the service technician has used replacement parts specified by the manufacturer or have the same characteristics as the original part. Unauthorized substitutions may result in fire, electric shock, or other hazards.

**SAFETY CHECK** — Upon completion of any service or repairs to this product, ask the service technician to perform safety checks to determine that the product is in proper operating condition.

**WALL OR CEILING MOUNTING** — The product should not be mounted to a wall or ceiling.

**HEAT** — The product should be situated away from heat sources such as radiators, heat registers, stoves, or other products (including amplifiers) that produce heat.

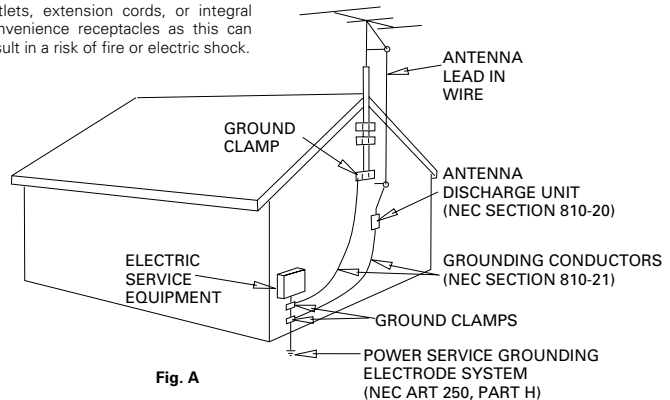

NEC — NATIONAL ELECTRICAL CODE

## Checking the Supplied Accessories

Please check that you've received the following supplied accessories:

- AM loop antenna
- FM wire antenna
- Dry Cell Batteries x2  
(VSX-D710S/D810S : type AA IEC R6P)  
(VSX-D850S : type AA IEC LR6)
- Remote Control Unit
- Operating Instructions

## Using this Manual

This manual is for the VSX-D710S/D810S/D850S audio/video multi-channel receivers.

It is divided into two main sections:

### Set up

This section covers installing your receiver and connecting up all the other components in your home theater system to it. It also describes how to set up a multi-channel speaker system to take full advantage of the great surround sound features of your receiver.

### Operation

This section shows you how to use every feature of the receiver and its remote control unit. It also covers using the supplied remote control to operate your other home theater components. To find out more about a specific button, control or indicator, see Displays & Controls starting on page 22. This will point you to the relevant chapter in the manual.

In the Additional Information section (p.50-51) you'll find a troubleshooting section and specifications.

## Installing the Receiver

Please note:

- Do not place objects directly on top of this unit. This would prevent proper heat dispersal.
- When installing in a rack, shelf, etc., be sure to leave more than 8 inches (20 cm.) of space above the receiver.

## When Making Cable Connections

Be careful not to arrange cables in a manner that bends the cables over the top of this unit. If the cables are laid on top of the unit, the magnetic field produced by the transformers in this unit may cause a humming noise to come from the speakers.

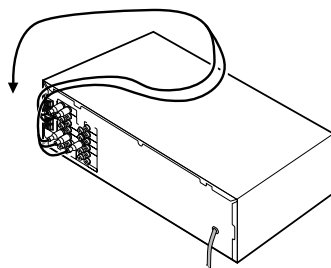

## Loading the Batteries

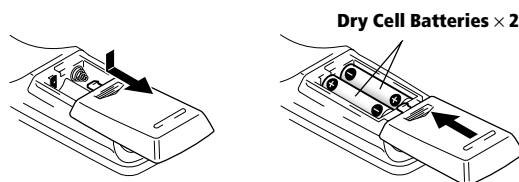

### CAUTION:

Incorrect use of batteries may result in such hazards as leakage and bursting. Observe the following precautions:

- Never use new and old batteries together.
- Insert the plus and minus sides of the batteries properly according to the marks in the battery case.
- Batteries of the same shape may have different voltages. Do not use different batteries together.
- When disposing of used batteries, please comply with governmental regulations or environmental public institution's rules that apply in your country or area.

## Operating Range of Remote Control Unit

The remote control may not work properly if:

- There are obstacles between the remote control and the receiver's remote sensor.
- Direct sunlight or fluorescent light is shining onto the remote sensor.
- The receiver is located near a device that is emitting infrared rays.
- The receiver is operated simultaneously with another infrared remote control unit.

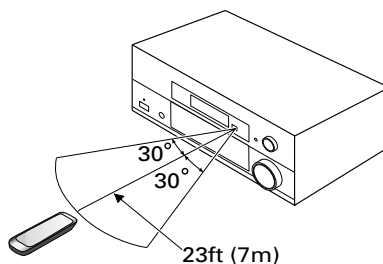

Congratulations on buying this fine Pioneer product.

Please read through these operating instructions so you will know how to operate your model properly. After you have finished reading the instructions, put them away in a safe place for future reference.

## 01 Introductory Information 4

- Checking the Supplied Accessories 4
- Using this Manual 4
- Installing the Receiver 4
- When Making Cable Connections 4
- Loading the Batteries 4
- Operating Range of Remote Control Unit 4

## 02 Contents 5

## 03 Connecting Your Equipment 6

- Audio/Video Cords 6
- Digital audio Cords/Optical Cables 6
- Connecting Digital Components 6
- Example Connection for a DVD/LD or LD Player 7
- Connecting Audio Components 8
- Connecting DVD 7.1 Channel (5.1 for VSX-D710S) Components 9
- Connecting Video Components 10
- Connecting Antennas 11
- Connecting Speakers (VSX-D710S) 12
- Connecting Speakers (VSX-D810S/D850S) 13
- Hints on Speaker Placement 14
- Connecting Additional Amplifiers (VSX-D810S/D850S only) 15
- AC Outlet [switched 100 W (0.8 A) max] 15

## 04 Preparations 16

- Setting Up for Surround Sound 16
- Setting the Volume Level of Each Channel 21

## 05 Displays & Controls 22

- Front Panel 22
- Display 23
- Remote Control (VSX-D710S/D810S) 24
- Remote Control (VSX-D850S) 26
- LCD Display (VSX-D850S only) 26

## 06 Sound Modes 27

- Learning about the Sound Modes 27
- Switching ANALOG/DIGITAL Signal Input 29
- Playing Sources with Dolby Digital or DTS Sound 29
- Selecting a Sound Mode 30

- Surround operation 30
- ADVANCED THEATER mode (Dolby/DTS mode) 30
- DVD 5.1 ch/7.1ch (5.1 ch for VSX-D710S) input playback 31
- MIDNIGHT Listening Mode 31
- Playing other Source 31

## 07 Using the Tuner 32

- Finding a Station 32
- Tuning Directly to a Station 32
- Memorizing Stations 33
- Recalling Memorized Stations 33

## 08 Making a Recording 34

- Making an Audio or a Video Recording 34
- Record MONITOR 34
- Making a Digital Recording 34

## 09 Controlling the Rest of Your System 35

- Recalling Preset Codes 35
- Setting Up Using Preset Code Search (VSX-D710S/D810S) 36
- Setting Up Using Library Search (VSX-D850S) 36
- Setting Up Using Brand Name Search (VSX-850 only) 37
- Learning Mode: Programming Signals from other Remote Controls 38
- Erasing One of the Remote Control button Settings 39
- Clearing All the Remote Control Settings 39
- Direct Function 39
- Checking Preset Code 40
- Operating other Pioneer Components 40
- CD/MD/CD-R/VCR/DVD/LD/DVR Player/Cassette Deck Controls 41
- Cable TV/Satellite TV/TV/DTV Controls 42
- Preset Code List 43

## 10 Additional Information 50

- Troubleshooting 50
- Specifications 51



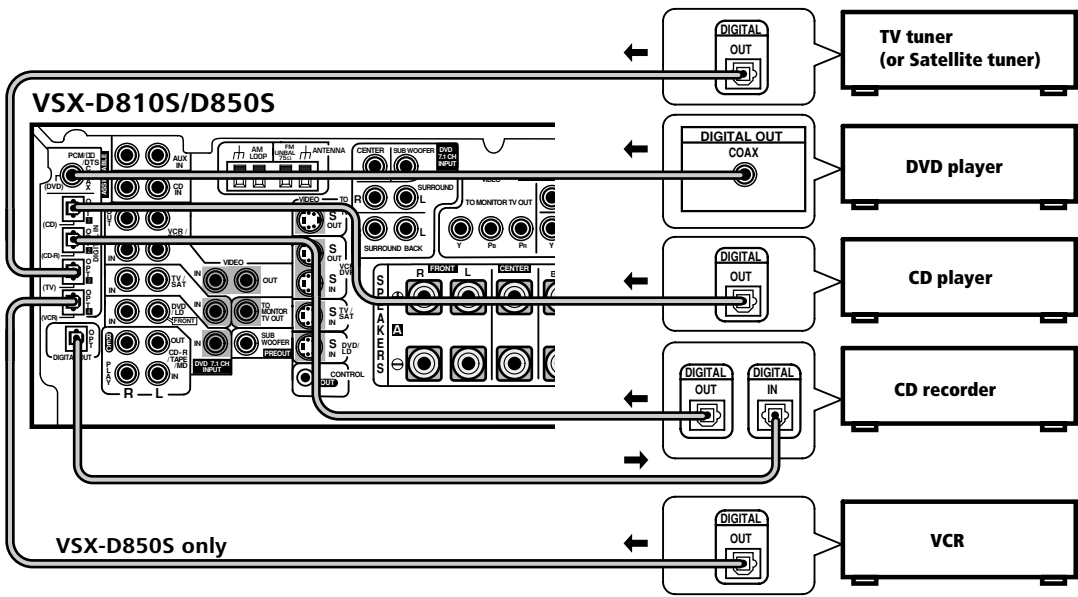

## Example Connection for a DVD/LD or LD Player

Since some LDs have soundtracks recorded on the special **RF** format you need to make special hook ups to ensure you can play all LDs on your system. If you don't have an LD (or an LD player with your DVD player) you don't need to worry about this. For the VSX-D710S/D810S/D850S hook up your DVD/LD or LD player directly and make sure you make both a **RF** output and either a coaxial or optical digital connection. Of course you must hook up your DVD/LD or LD player with standard (coaxial or optical) digital connections but if you are able to hook up your player with a **RF** output (if your player has one) this will ensure you can use all LDs available. We also recommend hooking up your digital components to analog audio jacks as well.

Before making or changing the connections, switch off the power and disconnect the power cord from the AC wall outlet. The diagram is for the VSX-D850S but hook up an RF Demodulator to the VSX-D710S in the same manner.

The arrows indicate the direction of the audio signal.

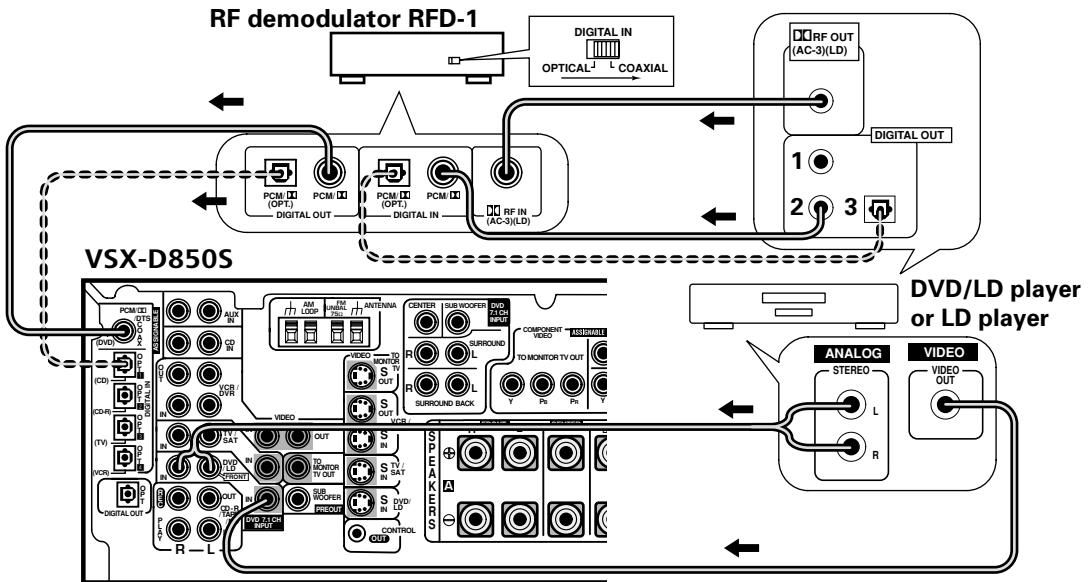

### MEMO:

Be sure to make either a digital coaxial or digital optical connection as well, but you don't need to make both. Make sure the RF demodulator digital in switch is set correctly (optical or coaxial depending on the connection). See the component's instruction manual if you are unsure about its input and output jacks.

# Connecting Your Equipment

## Connecting Audio Components

To begin set up, connect your audio components to the jacks as shown below. These are all analog connections and your analog audio components (like a cassette deck) use these jacks. Remember that for components you want to record with you need to hook up four plugs (a set of stereo ins and a set of stereo outs), but for components that only play you only need to hook up one set of stereo plugs (two plugs). To use digital source features you must hook up your digital components to the digital inputs (see the previous page for more on digital connections) but it is also a good idea to hook up your digital components to these analog audio jacks. If you want to record to/from digital components (like an MD) to/from analog components, you must hook up your digital equipment with these analog connections.

When connecting your equipment, always make sure the power is turned off and the power cord is disconnected from the wall outlet.

The arrows indicate the direction of the audio signal.

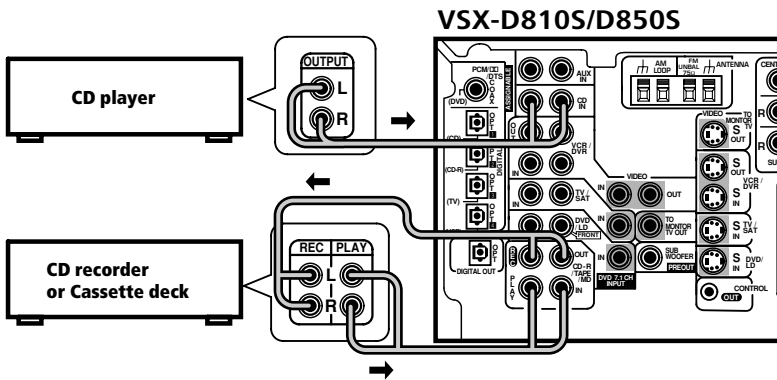
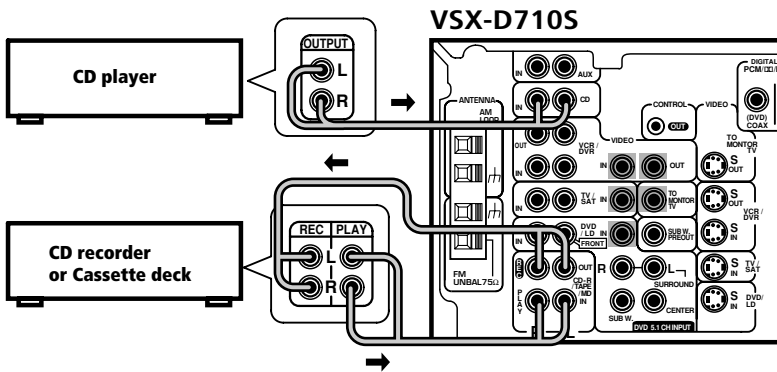

**Cassette deck placement**  
Depending on where the cassette deck is placed, noise may occur during playback of your cassette deck which is caused by leakage flux from the transformer in the receiver. If you experience noise, move the cassette deck farther away from the receiver.



## Connecting DVD 7.1 Channel (5.1 ch for VSX-D710S) Components

DVD and LD discs are compatible with both 2 channel and 7.1 channel audio output formats. Connections can be made from a DVD player/multi-channel decoder equipped with 7.1 analog outputs to the 6.1 analog inputs on this unit (the surround back channel is mono on the VSX-D810S/D850S models so we refer to it as 6.1 ch). You need to connect both the left and right surround back channels for the VSX-D810S/D850S models but the sound from this channel will only be mono. Always make sure that the receiver is switched off and unplugged from the wall outlet before making or changing any connections.

The arrows indicate the direction of the audio signal.

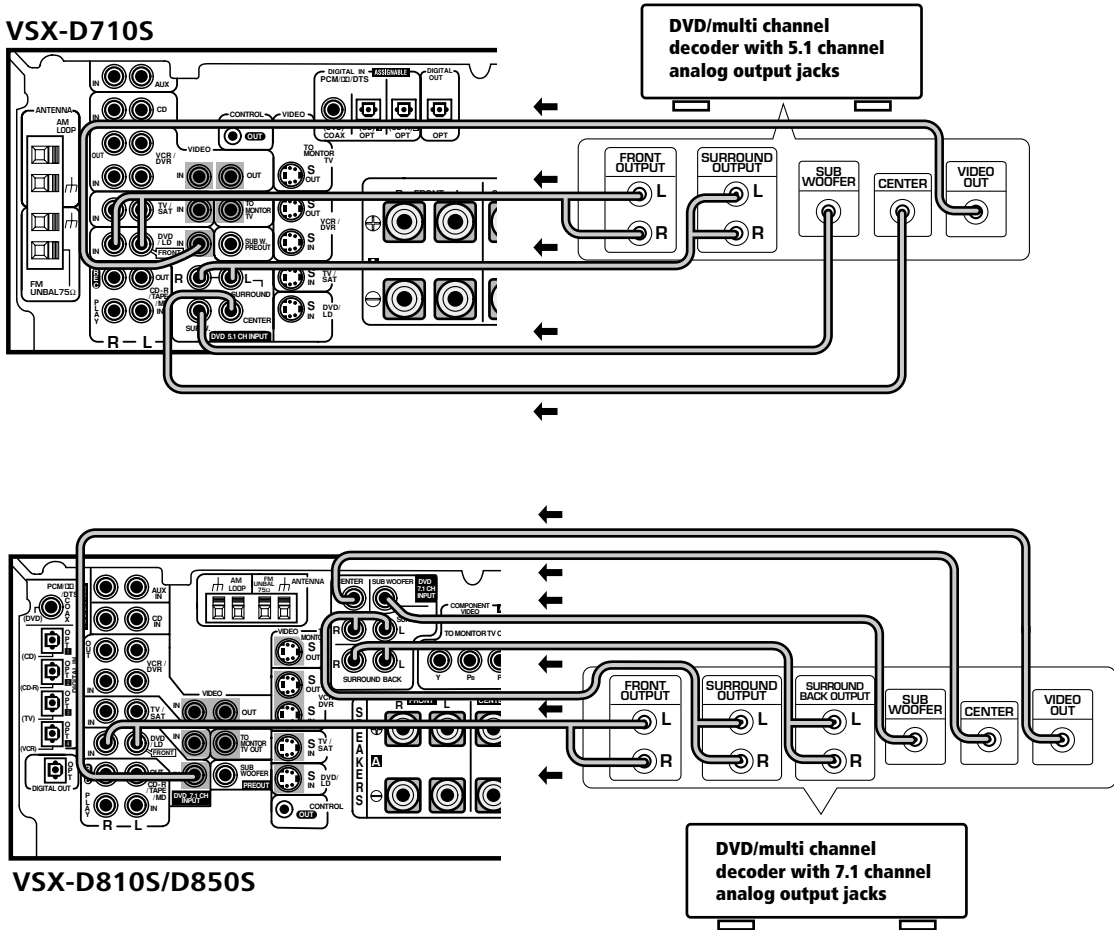

**MEMO:**

- The 7.1 channel (5.1 channel for VSX-D710S) input can only be used when DVD 7.1 ch (5.1 channel for VSX-D710S) input is selected.
- For 6.1 channel output select the SB 1ch setting (see p. 20). In this case you can connect the single surround back speaker to either the left or right surround back terminals.

# Connecting Your Equipment

## Connecting Video Components

Connect your video components to the jacks as shown below. Regarding digital video components (like a DVD player), you must use the analog video connections pictured on this page for the video signal but in order to use a digital source (like a DVD) you must hook up their audio to a digital audio input (see p. 6-7). It is also a good idea to hook up your digital components with analog audio connections as well (see p. 8).

When connecting your equipment always make sure the power is turned off and the power cord is disconnected from the wall outlet.

The arrows indicate the direction of the audio signal.

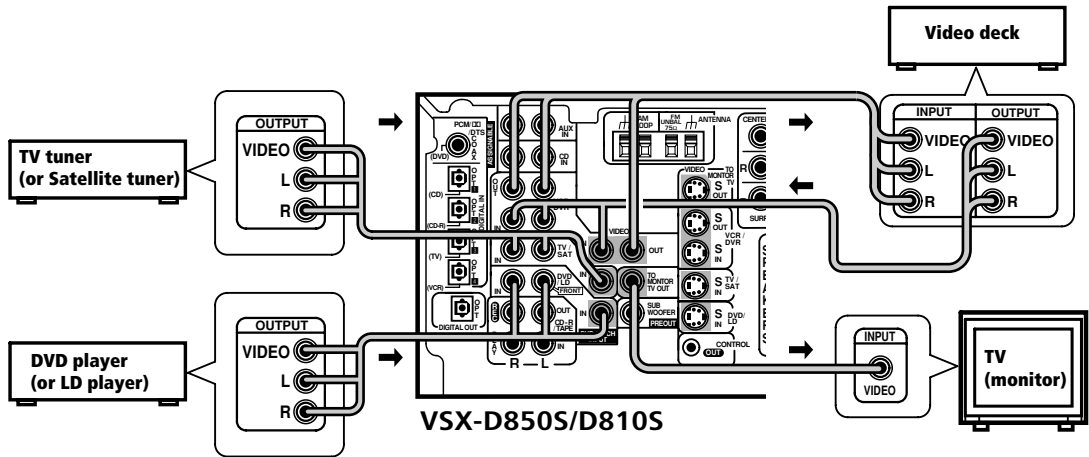
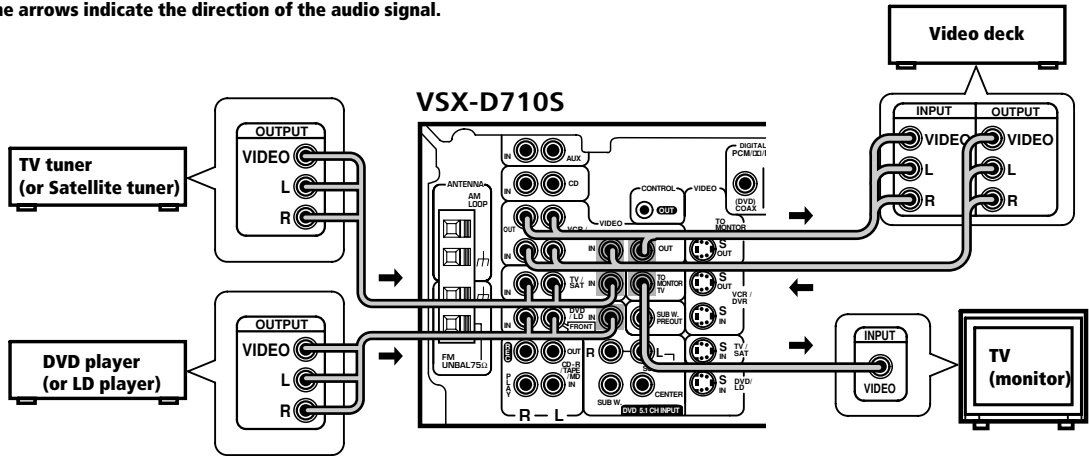

### Front

Front video connections are accessed via the front panel input selector as "VIDEO."

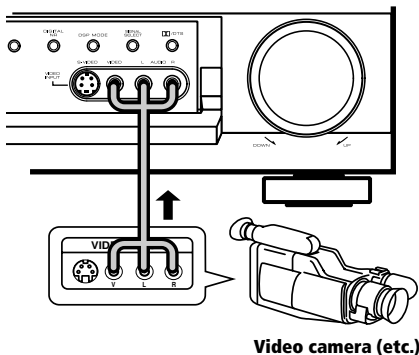

### MEMO:

This receiver also has S-Video and component video inputs and outputs. These can give you a better picture than the standard composite video connections. For S-Video connections use an S-Video cord (not supplied); for component video connections use a three-way RCA cord (not supplied).

Note that a signal fed into a video input on this receiver is only sent to your TV from the corresponding video output. In other words, if you connect your VCR to this receiver using a standard video cord, you need to connect the receiver to your TV using a standard video cord. If your DVD player is connected using an S-Video cord, make sure that you also connect the receiver to your TV with an S-Video cord.

## Connecting Antennas

Connect the AM loop antenna and the FM wire antenna as shown below. To improve reception and sound quality, connect external antennas (see Using external antennas, below). Always make sure that the receiver is switched off and unplugged from the wall outlet before making or changing any connections.

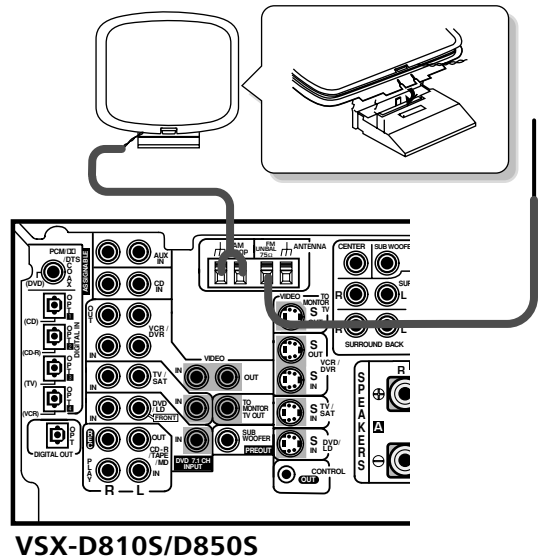
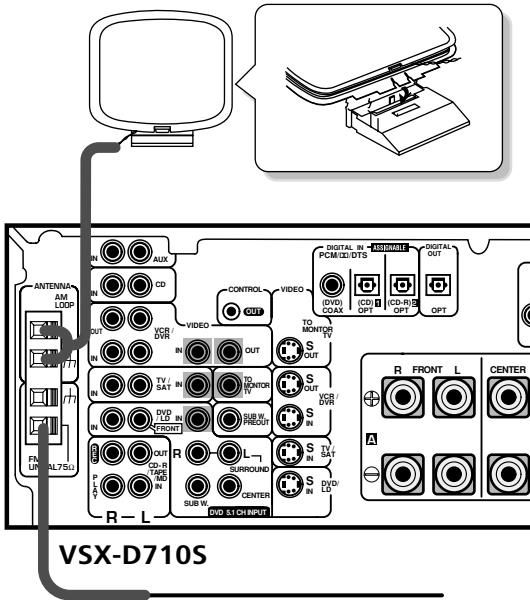

### AM loop antenna

Assemble the antenna and connect to the receiver. Attach to a wall, etc. (if desired) and face in the direction that gives the best reception.

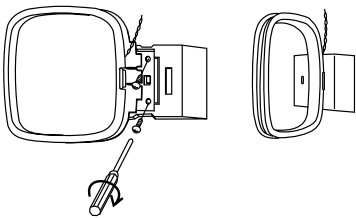

### FM wire antenna

Connect the FM wire antenna and fully extend vertically along a window frame or other suitable area, etc.

### Antenna snap connectors

Twist the exposed wire strands together and insert into the hole, then snap the connector shut.

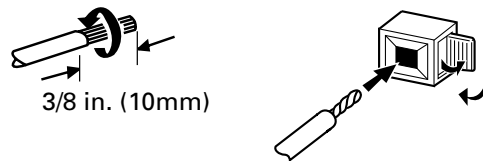

## Using External Antennas

### To improve FM reception

Connect an external FM antenna.

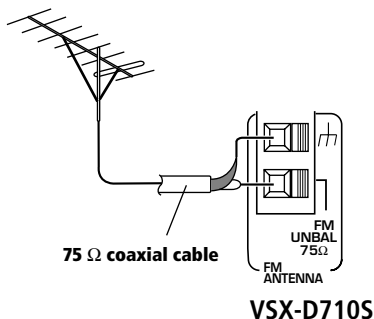

### To improve AM reception

Connect a 15-18 feet length of vinyl-coated wire to the AM antenna terminal without disconnecting the supplied AM loop antenna.

For the best possible reception, suspend horizontally outdoors.

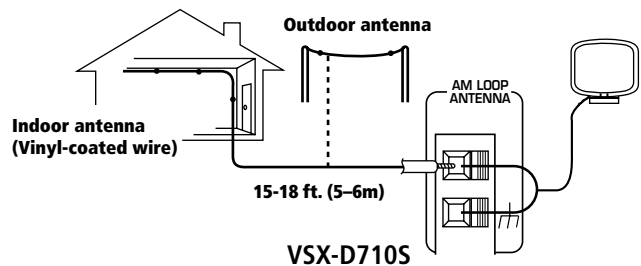

## Connecting Speakers (VSX-D710S)

A full complement of six speakers is shown here but, naturally, everyone's home setup will vary. Simply connect the speakers you have in the manner described below. The receiver will work with just two stereo speakers (called "front" speakers in the diagram) but we recommend you use at least three speakers and five is best.

Make sure you connect the speaker on the right to the right terminal and the speaker on the left to the left terminal. Also make sure the positive and negative (+/-) terminals on the receiver match those on the speakers.

### MEMO:

- The receiver has two speaker systems, A & B. A is the main system supporting the full complement of surround sound speakers. If you switch on both A & B speaker systems, only front speakers and the subwoofer will be audible. No sound will come from the center or surround speakers but multi channel sources will be down-mixed to the active speakers so no sound will be lost. Similarly, if you choose just the B system you'll only hear the front speakers connected to the B system and multi channel sources will be down-mixed to these two speakers.
- Use speakers with a nominal impedance of 8 Ω to 16 Ω.

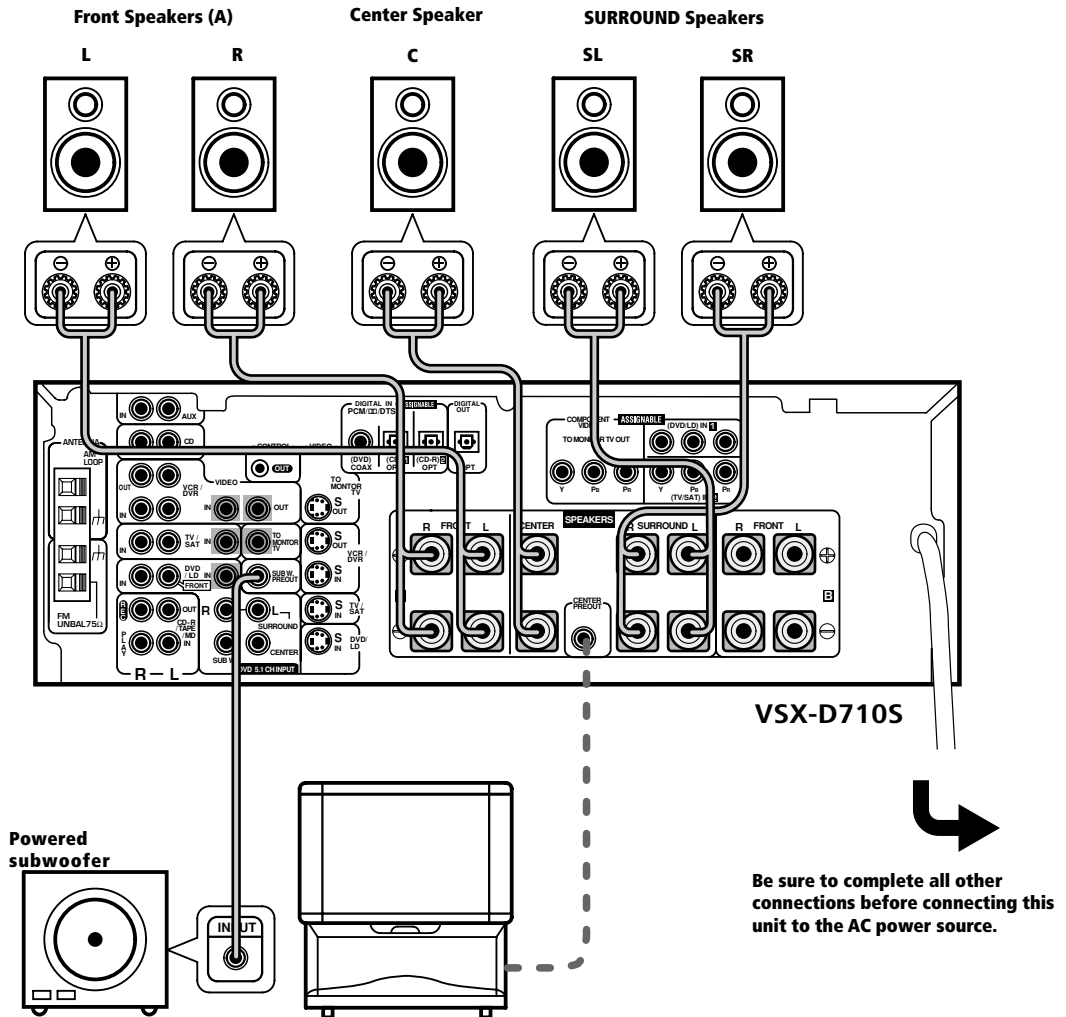

When using the speaker on your TV as the center speaker ('C'), connect the CENTER PREOUT jack on this unit to the audio input jack on your TV. In this case, the center speaker shown is unnecessary.

## Connecting Speakers (VSX-D810S/D850S)

A full complement of seven speakers is shown here but, naturally, everyone's home setup will vary. Simply connect the speakers you have in the manner described below. The receiver will work with just two stereo speakers (called "front" speakers in the diagram) but we recommend you use at least three speakers. To get the most out of the VSX-D810S/D850S models hook up all seven speakers, including a surround back speaker, the latest advancement in home theater. You can only hook up one speaker here as the surround back channel is mono on the VSX-D810S/D850S models. This is actually 6.1 ch sound but we usually refer to it by its regular name, 7.1 ch sound. The two are essentially the same thing both offering surround back sound. If you don't hook up a surround back speaker you can use that speaker terminal to hook up your subwoofer.

Make sure you connect the speaker on the right to the right terminal and the speaker on the left to the left terminal. Also make sure the positive and negative (+/-) terminals on the receiver match those on the speakers.

### MEMO:

- The receiver has two speaker systems, A & B. A is the main system supporting the full complement of surround sound speakers. **If you switch on both A & B speaker systems, only front speakers and the subwoofer will be audible. No sound will come from the center or surround speakers** but multi channel sources will be down-mixed to the active speakers so no sound will be lost. Similarly, if you choose just the B system you'll only hear the front speakers connected to the B system and multi channel sources will be down-mixed to these two speakers.
- Use speakers with a nominal impedance of 8 Ω to 16 Ω.
- If you select subwoofer (SB SUBWF) in the surround back speakers setting mode (see p.17) you can hook a subwoofer up to the surround back speaker terminals. In this case the terminals will be used for this "passive subwoofer" and no surround back sound will come from these terminals.

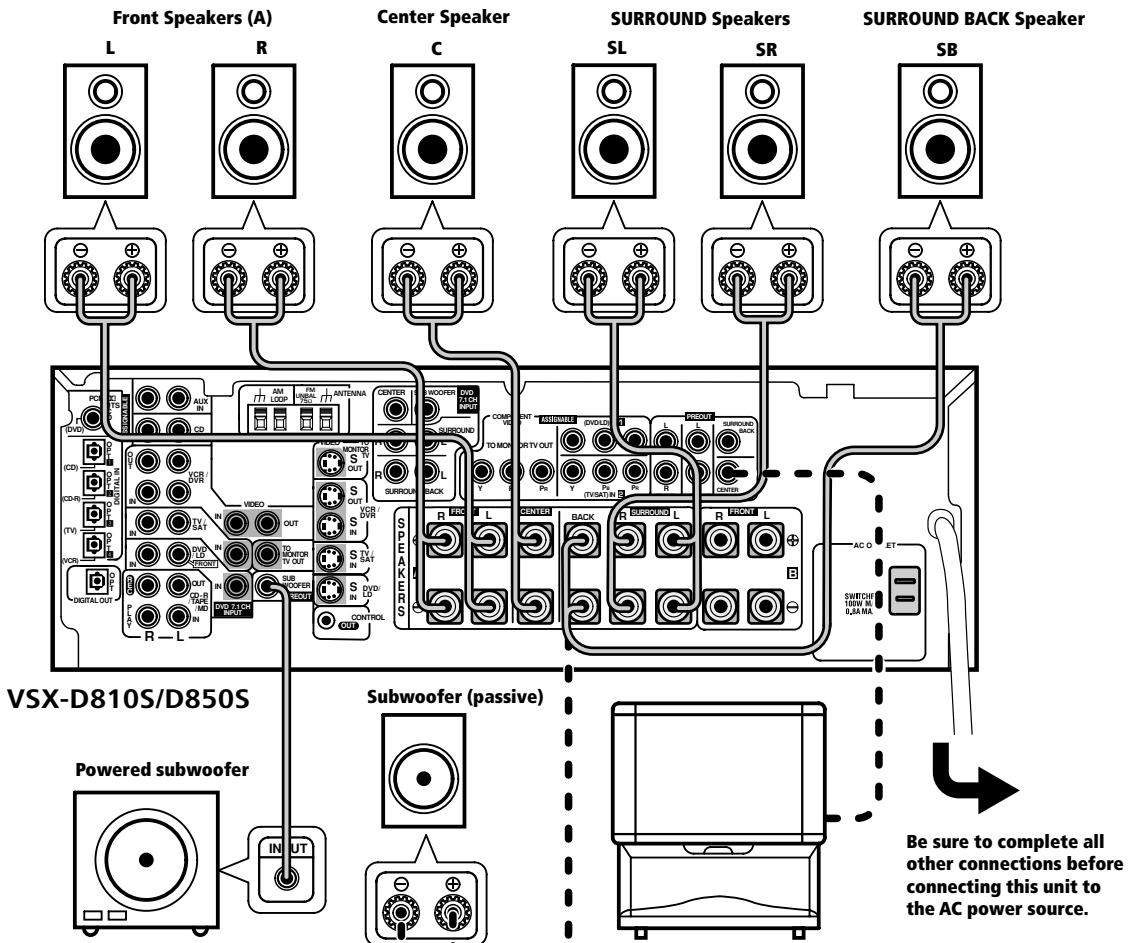

When using the speaker on your TV as the center speaker ('C'), connect the CENTER PREOUT jack on this unit to the audio input jack on your TV. In this case, the center speaker shown is unnecessary.

# Connecting Your Equipment

## Speaker terminals

- 1 Twist exposed wire strands together.
- 2 Loosen speaker terminal and insert exposed wire.
- 3 Tighten terminal.

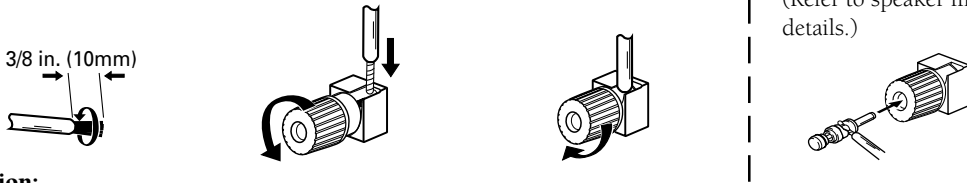

The speaker terminals also accept single banana plugs. (Refer to speaker manual for details.)

**Caution:**

**Make sure that all the bare speaker wire is twisted together and inserted fully into the speaker terminal. If any of the bare speaker wire touches the back panel it may cause the power to cut off as a safety measure.**

## Hints on Speaker Placement

Speakers are usually designed with a particular placement in mind. Some are designed to be floor standing, while others should be placed on stands to sound their best. Some should be placed near a wall; others should be placed away from walls. Follow the guidelines on placement that the speaker manufacturer provided with your particular speakers to get the most out of them.

- Place the front left and right speakers at equal distances from the TV.
- When placing speakers near the TV, we recommend using magnetically shielded speakers to prevent possible interference, such as discoloration of the picture when the TV is switched on. If you do not have magnetically shielded speakers and notice discoloration of the TV picture, move the speakers farther away from the TV.
- Install the center speaker above or below the TV so that the sound of the center channel is localized at the TV screen.

**CAUTION!**

If you choose to install the center speaker on top of the TV, be sure to secure it with putty, or by other suitable means, to reduce the risk of damage or injury resulting from the speaker falling from the TV in the event of external shocks such as earthquakes.

- If possible, install the surround speakers slightly above ear level.
- Try not to install the surround speakers farther away from the listening position than the front and center speakers. Doing so can weaken the surround sound effect.

To achieve the best possible surround sound, install your speakers as shown on the right. Be sure all speakers are installed securely to prevent accidents and improve sound quality.

Overhead view of speaker set up ~VSX-D710S~

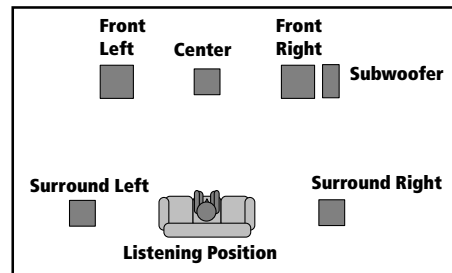

3-D view of speaker set up



Overhead view of speaker set up ~VSX-D810S/D850S~

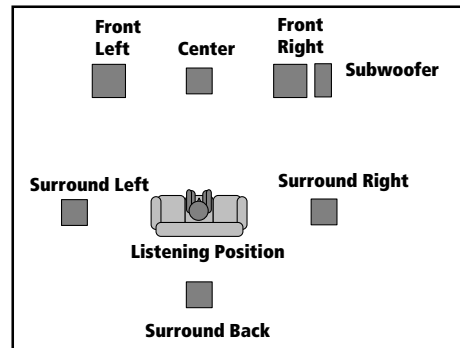

3-D view of speaker set up



## Connecting Additional Amplifiers (VSX-D810S/D850S only)

This receiver has more than sufficient power for any home use, however it is possible to add additional amplifiers to every channel. Make the connections shown below to add amplifiers to power your speakers. Always make sure that the receiver is switched off and unplugged from the wall outlet before making or changing any connections.

The arrows indicate the direction of the audio signal.

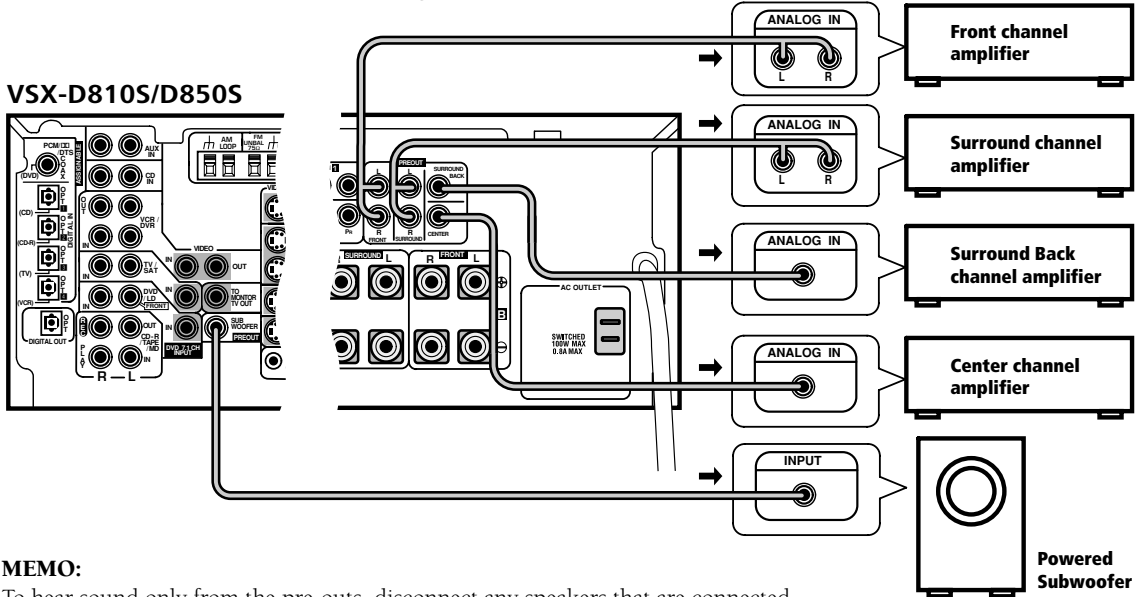

### MEMO:

To hear sound only from the pre-outs, disconnect any speakers that are connected directly to the receiver. (Using the **SPEAKERS** button to switch off the speakers also mutes the pre-outs; you must set it to either A, B, or A+B.)

## AC Outlet [switched 100 W (0.8 A) max]

Power supplied through this outlet is turned on and off by the receiver's POWER switch.

Total electrical power consumption of connected equipment should not exceed 100 W (0.8 A).

### CAUTION

Do not connect a heater, TV, etc. Also, make sure no exposed speaker wire is touching the rear panel, this may cause the receiver to turn off automatically.

### MEMO:

- This unit should be disconnected by removing the power plug from the wall socket when not in regular use, e.g., on vacation.
- Do not connect appliances with high power consumption such as heaters, irons, or television sets to this AC OUTLET in order to avoid overheating and fire risk. This can also cause the receiver to malfunction.

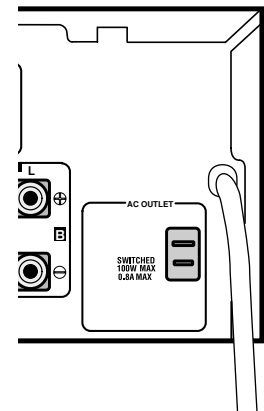

### CAUTION:

**DO NOT CONNECT A MONITOR OR TV SET TO THIS UNIT'S AC OUTLET.**

### POWER-CORD CAUTION

Handle the power cord by the plug. Do not pull out the plug by tugging the cord and never touch the power cord when your hands are wet as this could cause a short circuit or electric shock. Do not place the unit, a piece of furniture, etc., on the power cord, or pinch the cord. Never make a knot in the cord or tie it with other cords. The power cords should be routed such that they are not likely to be stepped on. A damaged power cord can cause a fire or give you an electrical shock. Check the power cord once in a while. When you find it damaged, ask your nearest PIONEER authorized service center or your dealer for a replacement.

## Setting Up for Surround Sound

Be sure to switch the power of this unit on (The STANDBY indicator goes out).

To ensure the best possible surround sound, be sure to complete the following set up operations. This is particularly important when using the **DD** (Dolby)/DTS surround mode. You only need to make these settings once (unless you change the placement of your current speaker system or add new speakers, etc.). Refer to the following pages for detailed descriptions of the settings available for each mode.

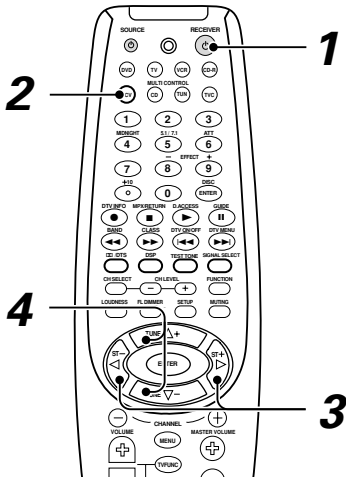

### 1 Press **RECEIVER** to turn the power on.

The STANDBY indicator goes out.

### 2 Press **RCV**.

This button switches the remote to the receiver's surround setup mode.

### 3 Press **◀** or **▶** to select the mode you want to set.

For best results, start with "SPEAKERS setting mode" and make your initial adjustments in the order described below.

The current settings are displayed automatically.

- **DTS-ES ON/OFF setting mode (page 17) (VSX-D810S/D850S only)**  
Use to turn the DTS-ES (surround back) channels ON or OFF (for DTS discs only).
- **SPEAKERS (Front, Center, Surround) setting mode (page 17)**  
Use to specify the size and type of speakers you have connected.
- **SPEAKERS (Surround Back) setting mode (page 17) (VSX-D810S/D850S only)**  
Use to specify the size and type of surround back speaker you have connected or if you have connected a subwoofer here.
- **SUBWOOFER ON/PLUS/OFF setting mode (page 18)**  
Use to specify if the subwoofer is set to on, plus or off.
- **Crossover frequency setting mode (page 18)**  
Use to determine which frequencies will be sent to the subwoofer (or "Large" speakers if you don't have a subwoofer).

- **LFE attenuator setting mode (page 18)**  
Use to specify the peak level for the LFE channel and the crossover network for rerouted bass frequencies.
  - **Low cut filter ON/OFF setting mode (page 18)**  
Use to cut the distorted sound from the subwoofer.
  - **FRONT speakers distance setting mode (page 18)**  
Use to specify the distance from your listening position to your front speaker.
  - **CENTER speakers distance setting mode (page 18)**  
Use to specify the distance from your listening position to your center speaker.
  - **SURROUND speakers distance setting mode (page 19)**  
Use to specify the distance from your listening position to your surround speakers.
  - **SURROUND BACK speakers distance setting mode (VSX-D810S/D850S only) (page 19)**  
Use to specify the distance from your listening position to your surround back speaker.
  - **Dynamic range control setting mode (page 19)**  
Use to compress the dynamic range of the sound track.
  - **Dual mono setting mode (page 19)**  
Use with **DD** Digital software that has dual mono encoding if you want to isolate one channel or listen in this specialized mono mode.
  - **Component input 1 setting (page 20)**  
Use to specify the video component connected to this input.
  - **Component input 2 setting (page 20)**  
Use to specify the video component connected to this input.
  - **Multi Channel External Decoder Surround Back 1ch/2ch setting (VSX-D810S/D850S only) (page 20)**  
Use to specify whether you hooked up your External Multi Channel Decoder surround back speaker connection with one or two cords. If you're not using a External Multi Channel Decoder ignore this setting.
  - **Coaxial digital input setting (page 20)**  
Use to specify the input to be assigned to the coaxial digital input.
  - **Optical digital input 1 setting (page 20)**  
Use to specify the input assigned to this optical digital input.
  - **Optical digital input 2 setting (page 20)**  
Use to specify the input assigned to this optical digital input.
  - **Optical digital input 3 setting (VSX-D810S/D850S only) (page 20)**  
Use to specify the input assigned to this optical digital input.
  - **Optical digital input 4 setting (VSX-D850S only) (page 21)**  
Use to specify the input assigned to this optical digital input.
- 4 Press **△** or **▽** to select the setting you want.  
The setting is entered automatically.
- 5 Repeat steps 3 and 4 to set other surround modes.

#### MEMO:

Press ENTER to exit the setting mode.  
The setting mode is automatically exited if no operation is performed within 20 seconds.



### DTS-ES ON/OFF setting mode (VSX-D810S/D850S only)

This setting allows you to hear surround back channels on DTS disc regardless of whether the disc itself is a 5.1 Ch disc or a 6.1 Ch disc. Naturally you need to hook up surround back speakers (see p. 13) and set them properly (see below on this page) in order to hear surround back channels. If you choose ON you will hear surround back channels with DTS discs. If you choose OFF you will not.

Choose DTS-ES ON or OFF by using the  $\Delta$  or  $\nabla$  buttons.

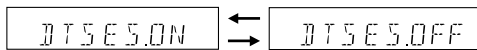

**MEMO:**

- If you choose none for the surround back speakers setting later on this page you won't be able to select ON here.
- You'll only get surround back channel sound when the receiver is in STANDARD mode (see p. 27-29), DTS-ES is set to ON and the disc is a DTS 5.1/6.1 channel disc.

### SPEAKERS (Front, Center, Surround) setting mode

This setting establishes the size and configuration of the speaker system you have connected. So, for example, here you set whether you have connected surround speakers or not, and how big they are. Selecting "Large" or "Small" will determine how much bass is sent by the receiver to the speakers being set.

In the display, "F", "C", and "S" refer to front, center, and surround speakers respectively. Speaker size is denoted as "L" for large speakers, "S" for small speakers, and "\*" (asterisk) if no speaker is connected.

Choose a speaker setting mode according to the speakers you hooked up. Use the  $\Delta$  or  $\nabla$  buttons.

The configurations shown below will appear in the display on the front of the receiver. One of them should match your speaker set up. Cycle through the different possibilities until you find the one that matches your set up.

Press  $\triangleright$  to advance to the next receiver setting, and press  $\triangleleft$  to return to a previous receiver setting.

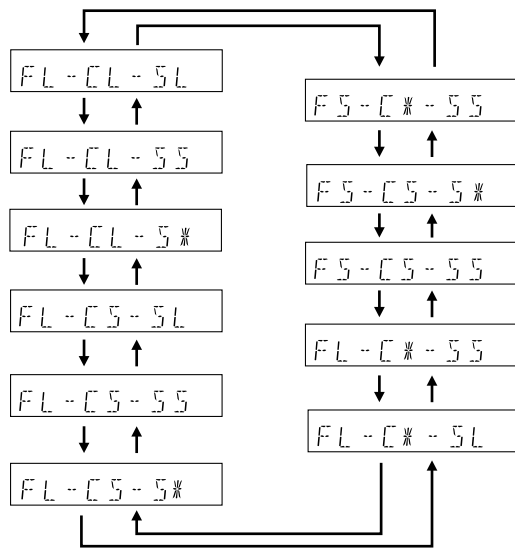

**MEMO:**

If the cone size (diameter) of the speaker is larger than 5 inches, please set to Large.

### SPEAKERS (Surround Back) setting mode (VSX-D810S/D850S only)

This setting establishes the size of the speaker connected to the surround back terminal (VSX-D810S/D850S only). You can choose a surround back speaker and its size or you can choose to hook a subwoofer to this terminal.

Switch the surround back speaker setting mode according to the size of the speaker you hooked up. Use the  $\Delta$  or  $\nabla$  buttons.

The configurations shown below will appear in the display on the front of the receiver. Choose one. Cycle through the different possibilities until you find the one that matches your set up.

If you select SB SUBWF here you can hook a subwoofer up to the surround back speaker terminals (see p.13). In this case the terminals will be used for this "passive subwoofer" and no surround back sound will come from these terminals.

Press  $\triangleright$  to advance to the next receiver setting, and press  $\triangleleft$  to return to a previous receiver setting.

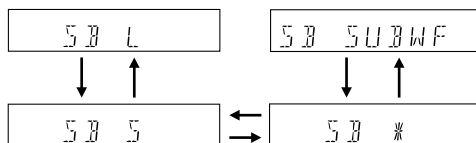

**MEMO:**

- You can only set the surround back speaker to large if the surround speakers are set to small.
- If you choose none for surround speakers (see previous setup) you won't be able to select any surround back speakers either.
- If you choose A+B speaker systems no sound is heard from the "passive subwoofer".

## Preparations

### SUBWOOFER ON/PLUS/OFF setting mode

Sets whether the SUBWOOFER is used or not. Also, when used you have the option to use the “PLUS” setting.

Press  $\Delta$  or  $\nabla$  to select subwoofer ON, PLUS or OFF.

#### MEMO:

- The initial setting is “ON”.
- Setting the front speaker size to “Small” in the SPEAKERS setting mode automatically locks the subwoofer in the “ON” position.
- Use the PLUS for extra bass. When you use PLUS you will get the bass sounds from the subwoofer even if the front speakers are set to “Large”.
- If you select “OFF” in this setting you won’t be able to select subwoofer in the surround back speaker setting above.

### Crossover frequency setting mode

Crossover frequency is the point where the receiver divides the high and low sounds (the frequencies) between the speakers. Since most smaller speakers can’t handle deep bass tones, this setting allows you to send those sounds to the subwoofer (or speakers set to “Large” if you don’t have a subwoofer) instead of the speakers set to “Small” in your system. Choose the point at which you want the frequency routed to the subwoofer (or “Large” speakers).

We recommend setting this to 200 Hz if smaller bookshelf-type speakers are used for your “Small” speakers.

Press  $\Delta$  or  $\nabla$  to specify the crossover frequency for your small speakers (100 Hz, 150 Hz or 200 Hz).

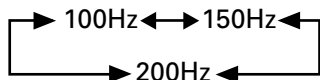

#### 100 Hz

Sends bass frequencies below 100 Hz to the subwoofer (or “Large” speakers).

#### 150 Hz

Sends bass frequencies below 150 Hz to the subwoofer (or “Large” speakers).

#### 200 Hz

Sends bass frequencies below 200 Hz to the subwoofer (or “Large” speakers).

#### MEMO:

- The initial setting is “100 Hz”.
- If all speakers (front, center, and surround) are set to “Large” in SPEAKERS setting mode, crossover frequency cannot be set because there are no “Small” speakers (\* \* \* appears in the display).

### LFE attenuator setting mode

Dolby Digital and DTS audio sources include ultra-low bass tones. Set the LFE attenuator as needed to prevent the ultra-low bass tones from distorting the sound from the speakers.

Press  $\Delta$  or  $\nabla$  to set the attenuation level (0 dB, 10 dB or \* \* dB( $\infty$ )).



#### MEMO:

- The initial setting is “0 dB”.
- When  $\infty$  is selected (\* \* appears in the display), LFE is not available.

### Low cut filter ON/OFF setting mode

Turn the low cut filter ON when distorted sound is output through the subwoofer.

Press  $\Delta$  or  $\nabla$  to select low cut filter ON or OFF.

#### MEMO:

- The initial setting is “OFF”.
- If the SUBWOOFER is set to “OFF” in the SUBWOOFER ON/OFF setting mode, the low cut filter cannot be set.

### FRONT speakers distance setting mode

Sets the distance from the FRONT speakers to the listening position.

Press  $\Delta$  or  $\nabla$  to set the distance of the FRONT speakers from the main listening position (within a 30 foot range).

#### MEMO:

- The initial setting is 10 ft.
- One step equals about 1ft.

### CENTER speaker distance setting mode

Sets the distance from the CENTER speakers to the listening position.

Press  $\Delta$  or  $\nabla$  to set the distance of the CENTER speaker from the main listening position (within a 30 foot range).

#### MEMO:

- The initial setting is 10 ft.
- When “C\*” is selected in SPEAKERS setting mode, the Center distance cannot be set.
- One step equals about 1 ft.

## SURROUND speakers distance setting mode

Use to set the SURROUND speakers distance. Like the CENTER speaker position, the SURROUND speakers may be set in a location closer or farther to your main listening position than the FRONT speakers. Set the distance of the SURROUND speakers accurately to hear sounds coming from both FRONT and SURROUND speakers at the same time.

Press  $\Delta$  or  $\nabla$  to set the distance of the SURROUND speakers from the main listening position (within a 30 foot range).

### MEMO:

- The initial setting is 10 ft.
- When “**S\***” is selected in SPEAKERS setting mode, the SURROUND distance cannot be set.
- One step equals about 1 ft.

## SURROUND BACK speaker distance setting mode (VSX-D810S/D850S only)

Use to set the SURROUND back speaker distance. Like the SURROUND speakers, the SURROUND BACK speakers may be set in a location closer or farther to your main listening position than the FRONT speakers. Set the distance of the SURROUND speakers accurately to hear sounds coming from both FRONT and SURROUND speakers at the same time.

Press  $\Delta$  or  $\nabla$  to set the distance of the SURROUND speakers from the main listening position (within a 30 foot range).

### MEMO:

- The initial setting is 10 ft.
- When “**SB\***” is selected in SPEAKERS setting mode, the SURROUND BACK distance cannot be set.
- One step equals about 1 ft.

## Dynamic range control setting mode

Dynamic range is the difference between the loudest and softest sounds in any given signal. The dynamic range control helps you play back sounds so the quieter sounds are audible yet the louder sounds don't get distorted. It does this by compressing the dynamic range. When watching a movie at low volume, setting this function enables low level sounds to be heard more easily but you won't be jolted by louder sounds.

Press  $\Delta$  or  $\nabla$  to set the dynamic range control (OFF, MAX, or MID).

### MEMO:

- The initial setting is “**OFF**”.
- When the volume level is increased, set to OFF.
- For listening enjoyment at low volumes, set to “**MAX**” for maximum dynamic range compression.
- Dynamic range control is effective only when a Dolby Digital signal is being played back.

## Dual mono setting

The dual mono setting can only be used when listening to Dolby Digital discs that have dual mono software encoded in them. As of now these are not that widely used. With this setting you can choose which channel in the dual mono setting you want to listen to. Thus, it is useful for soundtracks that have one language on one channel and a different language on the other. Remember you can only use this setting if you have Dolby Digital software with this feature and want to isolate one of the channels therein.

There are two different ways to route the sound in the dual mono setting, one is with Dolby Digital mode on, the other with Dolby Digital mode off. If Dolby Digital mode is switched on, the ch1 setting will play channel 1 through your center speaker. The ch2 setting will play channel 2 through your center speaker. With Dolby Digital mode off, the dual mono sound routing is as follows: In the **ch1** setting your will hear channel 1 out of both front speakers. In the **ch2** setting you will hear channel 2 out of both speakers. In the **L. c1 R. c2** setting the speakers will play the soundtrack independently of each other. The left front speaker will play channel 1 and the right front speaker will play channel 2.

Press  $\Delta$  or  $\nabla$  to cycle through the possible DUAL MONO settings.

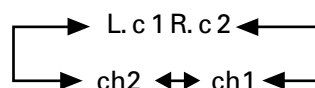

### MEMO:

- The default setting of this feature is **ch1**.

### Component input 1 setting

Tells the receiver What (DVD player, etc.) is connected to this input.

Press  $\Delta$  or  $\nabla$  to select the component setting (DVD, TV, VCR or OFF).

**MEMO:**

- The initial setting is “DVD”.

### Component input 2 setting

Tells the receiver What (TV, player etc.) is connected to this input.

Press  $\Delta$  or  $\nabla$  to select the component setting (TV, VCR, OFF or DVD).

**MEMO:**

- The initial setting is “TV”.

### Multi Channel External Decoder Surround Back 1ch/2ch setting (VSX-D810S/VSX-D850S only)

You only need to make this setting if you are using a multi channel external decoder with your DVD player. If you aren't just ignore this setting.

Press  $\Delta$  or  $\nabla$  to select the channel setting. Select 1ch if your DVD is outputting 6.1 sound (the surround back channel is mono) or select 2ch if your DVD is outputting 7.1 sound (the surround back channel is stereo).

### Coaxial digital input setting

Here you tell the receiver what component you have hooked up to the coaxial digital input jack.

Press  $\Delta$  or  $\nabla$  to select the coaxial digital input (DVD, TV, CD, CD-R, VCR, or OFF).

After you assign the component to this digital jack whenever you select that component, for example a CD player, the receiver will automatically change to the digital input setting. You can see this in the DIGITAL/ANALOG indicator on the front of the receiver.

**MEMO:**

- The initial setting is “DVD”.

### Optical digital input 1 setting

Here you tell the receiver what component you have hooked up to the optical input jack 1.

Press  $\Delta$  or  $\nabla$  to select the optical digital input 1 (DVD, TV, CD, CD-R, VCR, or OFF).

After you assign a component to this digital jack whenever you select that component, for example a CD player, the receiver will automatically change to the digital input setting. You can see this in the DIGITAL/ANALOG indicator on the front of the receiver.

**MEMO:**

- The initial setting is “CD”.

### Optical digital input 2 setting

Here you tell the receiver what component you have hooked up to the optical input jack 2.

Press  $\Delta$  or  $\nabla$  to select the optical digital input 2 (DVD, TV, CD, CD-R, VCR, or OFF).

After you assign a component to this digital jack whenever you select that component, for example a CD player, the receiver will automatically change to the digital input setting. You can see this in the DIGITAL/ANALOG indicator on the front of the receiver.

**MEMO:**

- The initial setting is “CD-R”.

### Optical digital input 3 setting (VSX-D810S/VSX-D850S only)

Here you tell the receiver what component you have hooked up to the optical input jack 3.

Press  $\Delta$  or  $\nabla$  to select the optical digital input 2 (DVD, TV, CD, CD-R, VCR, or OFF).

After you assign a component to this digital jack, whenever you select that component, for example a CD player, the receiver will automatically change to the digital input setting. You can see this in the DIGITAL/ANALOG indicator on the front of the receiver.

**MEMO:**

- The initial setting is “TV”.

## Optical digital input 4 setting (VSX-D850S only)

Here you tell the receiver what component you have hooked up to the optical input jack 4.

Press  $\Delta$  or  $\nabla$  to select the optical digital input 2 (DVD, TV, CD, CD-R, VCR, or OFF).

After you assign a component to this digital jack whenever you select that component, for example a CD player, the receiver will automatically change to the digital input setting. You can see this in the DIGITAL/ANALOG indicator on the front of the receiver.

### MEMO:

- The initial setting is “VCR”.
- The digital out signal corresponds to the selected input function (for example, DVD).

## Setting the Volume Level of Each Channel (adjusting the speaker volume balance)

Use to set the relative volume of each channel.

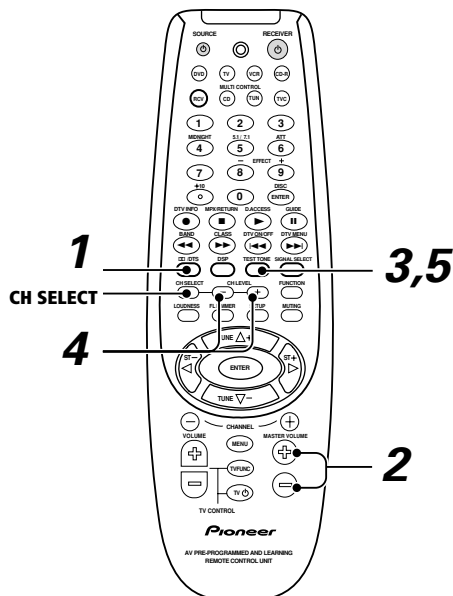

- 1 Press **DOLBY/DTS**.
- 2 Press **MASTER VOLUME +** or **-** to adjust the volume to an appropriate level.

- 3 Press **TEST TONE** to output the test tone.

The test tone is output in the following order.

VSX-D710S

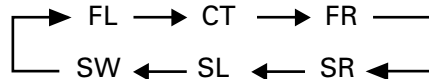

VSX-D810S/D850S

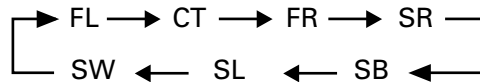

- Test tone is only output in Dolby/DTS modes. The test tone sequence corresponds to the speaker setting mode.
- 4 **Adjust speaker levels so that you hear the test tone at the same volume from each speaker when seated in the main listening position.**
    - If a speaker is deselected in the speaker setting mode (see p. 17) then no test tone will be output for that speaker.
    - The channel level range is  $\pm 10$  dB.
    - Levels can be set for each surround mode.
  - 5 Press **TEST TONE** to turn off the test tone.

### MEMO:

- Since the SUBWOOFER transmits an ultra-low frequency its sound may seem quieter than it actually is.
- The speaker volume can be adjusted without outputting the test tone by pressing **CH LEVEL** or **CH SELECT** button.
- Initial setting is 0 dB.
- You can set each sound mode individually and these settings are completely independent of each other. The sound modes you can set include DSP, stereo, DVD 7.1 Ch and **DOLBY/DTS**, as explained in steps above. However, you can only use the test tone feature when setting **DOLBY/DTS**.

## Front Panel

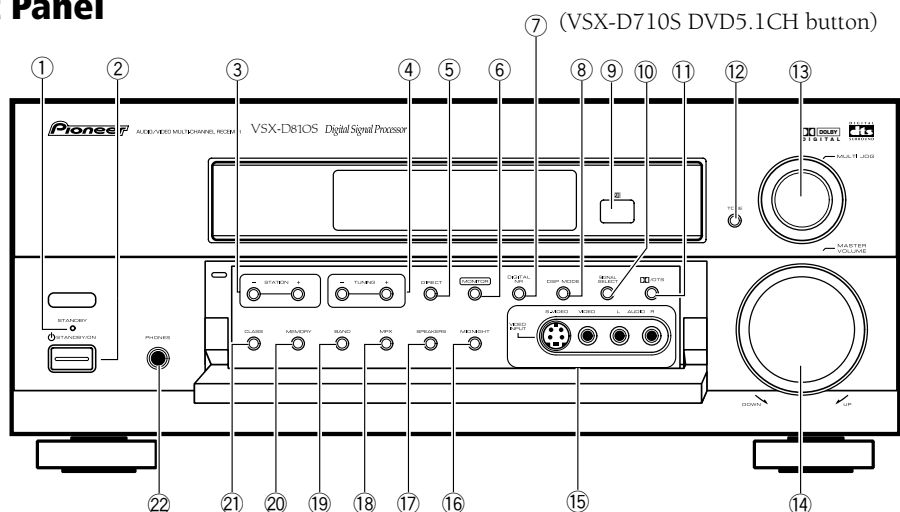

- ① **STANDBY indicator**  
Lights when the receiver is in standby mode (note that the receiver consumes a small amount of power (1W) in standby mode).
- ② **STANDBY/ON button**  
Switches the receiver between on and standby (note that the receiver consumes a small amount of power (1W) in standby mode).
- ③ **STATION (+/-) buttons (see pages 32-33)**  
Selects station memories when using the tuner.
- ④ **TUNING (+/-) buttons (see pages 32-33)**  
Selects the frequency when using the tuner.
- ⑤ **DIRECT button**  
Use to switch DIRECT playback on or off. This mode bypasses the tone controls, channel levels, **DD**/DTS and DSP modes for the most accurate reproduction of a program source.
- ⑥ **MONITOR button**  
Press to switch tape monitoring on/off.
- ⑦ **DIGITAL NR button (VSX-D810S/D850S)**  
Switches the DIGITAL NR on or off.  
**DVD5.1CH button (VSX-D710S) (see page 31)**  
On the VSX-D810S/D850S use this button to switch the DIGITAL NR on or off. On the VSX-D710S this button switches between DVD5.1CH input and regular DVD input.
- ⑧ **DSP MODE button (see page 28, 30)**  
Use to switch between the various DSP modes available (**HALL 1, HALL 2, JAZZ, DANCE, THEATER 1, THEATER 2, 6CH STEREO [VSX-D810S/D850S only]**) and **DSP off**. Use this button to create different surround sound effects from any stereo source.
- ⑨ **Remote sensor**  
Receives the signals from the remote control.
- ⑩ **SIGNAL SELECT button (see page 29)**  
Use to select an analog or digital or AUTO (VSX-D810S/D850S only) signal.
- ⑪ **DD /DTS button (see pages 27, 29)**  
Use to switch between the various Dolby/DTS surround modes.
- ⑫ **TONE button**  
This button allows you to activate the BASS & TREBLE controls. To adjust the BASS and/or TREBLE use the MULTI JOG DIAL. Tone can only be used in 2 channel stereo sound mode. The tones controls have no effect on the B speaker system.
- ⑬ **MULTI JOG dial**  
You can use this dial for two purposes. Firstly, in normal mode turn it to select a source component. Secondly, use it to adjust the BASS and/or TREBLE levels when the TONE button has been activated (as explained above).
- ⑭ **MASTER VOLUME**  
Use to set the overall listening volume.
- ⑮ **VIDEO INPUT jacks**  
Connect a video camera, video game system, etc. to the **VIDEO INPUT** jacks (refer to page 10).
- ⑯ **MIDNIGHT button (see page 31)**  
Use when listening to movie soundtracks at low volume. This feature will enable you to hear quiet sounds and not get jolted by loud or sudden sound effects.
- ⑰ **SPEAKERS button**  
Use to switch the speaker system **A → B → A+B → off**. In **B** and **A+B** speaker modes you hear only 2 channel stereo sound.
- ⑱ **MPX button (see page 32)**  
If the **TUNED** or **STEREO** indicators don't light when tuning to an FM station because the signal is weak, press the MPX button to switch the receiver into mono reception mode. This should improve the sound quality and allow you to enjoy the broadcast.
- ⑲ **BAND button (see page 32-33)**  
Press to select the AM or FM band.
- ⑳ **MEMORY button (see page 33)**  
Press to memorize a station for recall using the **STATION (+/-)** buttons.
- ㉑ **CLASS button (see pages 33)**  
Switches between the three banks (classes) of station memories.
- ㉒ **PHONES jack**  
Use to connect headphones but this does not switch the speakers off.

# Display

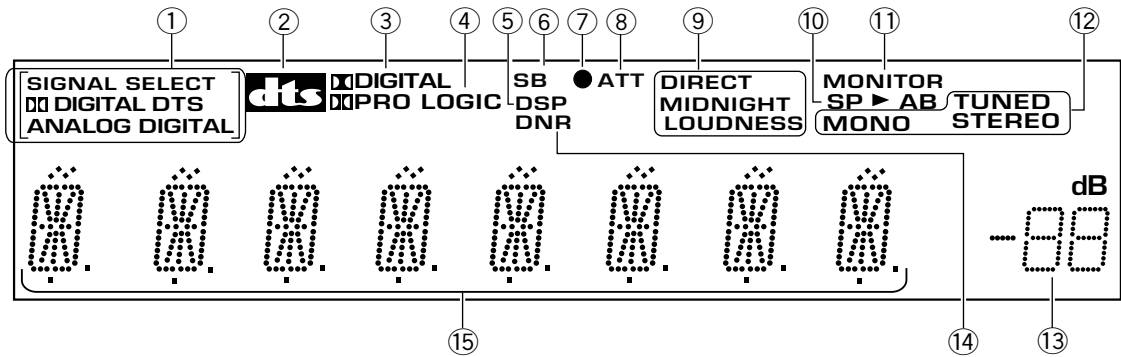

① **SIGNAL SELECT indicators**

Light to indicate the type of input signal assigned for the current component (see “Front Panel”, ⑩ SIGNAL SELECT). When the AUTO setting is being used on VSX-D810S & VSX-D850S receivers a set of brackets will appear around the SIGNAL SELECT indicators.

**DIGITAL** : Lights when a DOLBY DIGITAL signal is played.

**DTS**: Lights when a source with DTS audio signals is played.

**ANALOG** : Lights when an analog signal is selected.

**DIGITAL** : Lights when a digital audio signal is selected.

[ ]: Lights when the AUTO setting is selected. (VSX-D810S/D850S only)

② **DTS indicator**

Lights when DTS mode is being used.

③ **DIGITAL indicator**

When the [ ] (DOLBY)/DTS mode of the receiver is on, this lights to indicate playback of a Dolby Digital signal. However, [ ] PRO LOGIC lights during [ ] channel playback of Dolby Digital.

④ **PRO LOGIC indicator**

When the [ ] (DOLBY)/DTS mode of the receiver is on, this lights to indicate playback of a Dolby Pro Logic source.

⑤ **DSP indicator**

Lights when any Advanced Theater or DSP mode is selected.

⑥ **Surround Back indicator (VSX-D810S/D850S only)**

Lights when most Surround Back channel flag encoded (6.1channel) software is playing. (With some Surround Back channel software the surround back indicator won't light because there is no flag encoded in the software.) If you play DTS 5.1/6.1 channel software surround sound will be heard whether it is encoded with a surround back channel flag or not.

⑦ **OVERLOAD indicator**

This lights when an analog signal is too strong (the SIGNAL SELECT needs to be on ANALOG). It indicates the sound is distorting and the input signal should be reduced.

⑧ **ATT indicator**

Lights when ATT is used to attenuate (reduce) the level of the input signal (can only be used in ANALOG mode).

⑨ **DIRECT indicator**

Lights when source DIRECT is in use. This function bypasses all tone, channel levels, DSP and Dolby Surround effects.

**MIDNIGHT indicator**

Lights when MIDNIGHT listening mode is in use.

**LOUDNESS indicator**

Lights when the LOUDNESS is on. LOUDNESS is used to boost the bass and treble when listening at low levels.

⑩ **SPEAKER indicator**

Shows if the speaker system is on or not. SP ► A (and/or) B means speakers are switched on. SP ► means speakers are switched off.

⑪ **MONITOR indicator**

Lights when MONITOR is selected to hear a recording as it's being made (see page 34).

⑫ **TUNER indicators**

**MONO:**

Lights when the mono mode is set using the MPX MODE button.

**TUNED:**

Lights when a broadcast is being received.

**STEREO:**

Lights when a stereo FM broadcast is being received in auto stereo mode.

⑬ **MASTER VOLUME LEVEL**

Shows the overall volume level. Volume level is maintained even when the power is off. ---dB indicates the minimum level, and 0dB indicates the maximum level.

- Depending on the level settings you make for individual channels, the MAX level can range between -10dB and 0dB.

⑭ **DNR indicator (VSX-D810S/D850S only)**

Lights when the digital noise reduction is on. Use to reduce extraneous noise. It can be used with any sound mode.

⑮ **CHARACTER display**

Shows the radio frequency or function (DVD/LD, CD, etc.) receiver is using.

## Remote Control (VSX-D710S/D810S)

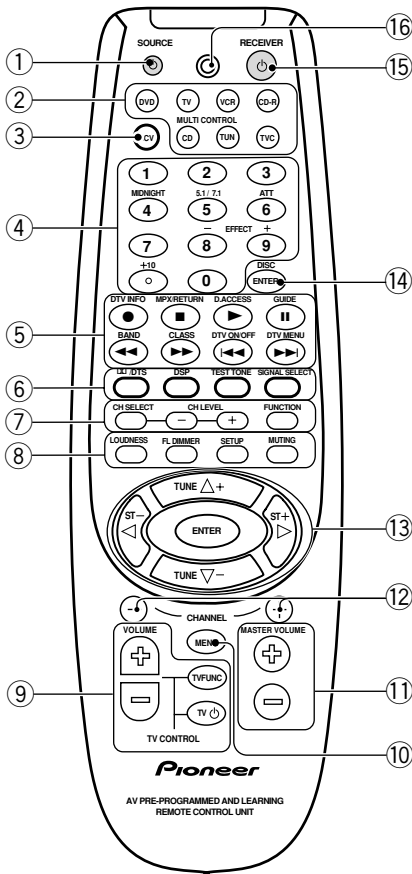

① **SOURCE** button

Use to turn on/off other components connected to the receiver.

② **MULTI CONTROL** buttons

Use to put the receiver/remote control in the stated mode.

For other equipment controls, see Controlling the Rest of Your System on pages 35-49.

③ **RCV** button (see page 16)

Use this button when setting up the surround sound for the receiver. Also press it if you want to use special features attached to some of the number buttons, for example MIDNIGHT, 5.1/7.1, or ATT.

④ **NUMBER/MODE** buttons

Use the number buttons to select the radio frequency in tuner DIRECT ACCESS (see page 32) mode or the tracks in CD, DVD mode etc.

Also, buttons marked with the following names have special functions. If you try to use one of these functions but the display flashes it means that function cannot be used in the current mode (for example DSP modes cannot be used when 5.1 Ch setting is on).

**MIDNIGHT** (see page 31)

Use to put receiver in MIDNIGHT mode. To use first press the **RCV** button then operate this button.

**5.1 Ch (VSX-D710S) 7.1Ch (VSX-D810S/D850S)** (see page 31)

When the DVD/LD or DVD 5.1/7.1 Ch function is selected each press switches the DVD/LD input between DVD/LD and DVD 5.1/7.1 Ch. To use first press the **RCV** button then operate this button.

**ATT**

When the overload indicator lights use this button to attenuate (lower) the level of an analog input signal and prevent distortion. To use first press the **RCV** button then operate this button.

**EFFECT +/-** buttons (see page 30)

Use to add or subtract the amount of effect in different DSP sound modes (except 6 Ch Stereo) or advanced listening modes.

To use first press the **RCV** button then operate these buttons.

⑤ **THE FOLLOWING BUTTONS ARE BOTH CONTROLS FOR OTHER COMPONENTS (LIKE A DVD PLAYER) AND DEDICATED TUNER CONTROLS. THE TUNER CONTROLS ARE EXPLAINED HERE. YOU CAN USE THEM AFTER YOU HAVE PUSHED THE TUNER MULTI CONTROL BUTTON.**

**BAND** button (see pages 32, 33)

Use to switch between the AM and FM band when in TUNER mode.

**CLASS** button (see pages 33)

Use to switch between the three banks (classes) of station memories.

**MPX/RETURN** button (see page 32)

Use to switch between auto stereo and mono reception of FM broadcasts. If the signal is weak then switching to MONO will improve the sound quality. Also, this is the pause button for CDs, tapes, DVDs, etc.

**D. ACCESS** button (see page 32)

Use to directly access a radio station by pressing the number of the station you want.

**DTV INFO** button

Use to bring up information screens on a digital TV.

**DTV MENU** button

Use to bring up menus on a digital TV.

**DTV ON/OFF** button

Use to turn a digital TV on/off.

**GUIDE** button

Use to bring up the guides on a digital TV.



- ⑥ **DD /DTS button (see pages 27, 29)**  
Use to put receiver in DOLBY DIGITAL, DOLBY SURROUND and DTS modes.  
**DSP button (see pages 28, 30)**  
Use to put receiver in one of the DSP modes.  
**TEST TONE button (see page 21)**  
Use to sound the TEST TONE when setting up the surround sound of the receiver (the DD /DTS mode must be on).  
**SIGNAL SELECT (see page 29)**  
Use to select the proper signal (analog, digital) for the source you are inputting. On the VSX-D810S & VSX-D850S receivers there is an AUTO setting. In this setting the receiver will automatically switch between the analog and digital signals according to what is being input. If both signals are input the AUTO setting will choose the digital one. This setting is convenient as the receiver will always choose the best or appropriate signal.
- ⑦ **CH SELECT button (see page 21)**  
Use to select a speaker when setting up the surround sound of the receiver. To use first press the **RCV** button then operate this button.  
**CH LEVEL +/- (see page 21)**  
Use to set up the levels of the surround sound of the receiver. To use first press the **RCV** button then operate this button.  
**FUNCTION button**  
Use to select the playback or recording source. This button lets you cycle through the different functions of the receiver in the following order: CD, TUNER, AUX, CDR/TAPE, VCR/DVR, DVD/LD, DVD 7.1 Ch, VIDEO, and TV/SAT (VSX-D810S/D850S).  
CD, TUNER, AUX, CDR/TAPE, VCR/DVR, DVD/LD, VIDEO, and TV/SAT (VSX-D710S).
- ⑧ **LOUDNESS button**  
Use to switch on the loudness. This feature is useful for getting good bass and treble sounds listening at low volumes.  
**FL DIMMER button**  
Use this button to make the fluorescent display (FL) dimmer or brighter. There are three brightness settings as well as an off setting.  
**SETUP button (see page 35-40)**  
Use this button when setting up the remote control to control other components.  
**MUTING button**  
Use to mute the sound or restore the sound if it has been muted.
- ⑨ **THE FOLLOWING BUTTONS ARE DEDICATED TV CONTROL. THEY ARE ONLY USED FOR CONTROLLING YOUR TV.**  
**TV FUNC button**  
Use select the TV function.  
**TV ⏻ button**  
Use to turn on/off the power of the TV.  
**TV VOLUME +/- buttons**  
Use to adjust the volume on your TV.
- ⑩ **MENU button**  
Use to access different menus associated with your DVD player.
- ⑪ **MASTER VOLUME +/- buttons**  
Use to set the overall listening volume.
- ⑫ **CHANNEL +/- buttons**  
Use to select the stations of memorized radio frequencies. Also use to skip tracks backward or forward on CDs, DVDs, etc.
- ⑬ **< > Δ ∇ ( TUNE/ST +/-) & ENTER buttons (see pages 16-21)**  
Use these arrow buttons when setting up your surround sound system (see pages 16-21). These buttons are also used to control DVD menus/options and for deck 1 of a double cassette deck player. The TUNE/ST +/- buttons can be used to find radio frequencies and preset stations, respectively.
- ⑭ **DISC (ENTER) button**  
Use to select a disc an in multi-CD player. To use first press the **RCV** button then operate this button.
- ⑮ **RECEIVER ⏻ (POWER) button**  
This switches between STANDBY mode and power ON for this receiver.
- ⑯ **LED DISPLAY (see pages 35-40)**  
This display flashes when a command is sent from the remote control to the receiver. It also flashes at other times, for example when teaching the receiver preset codes, with specific meanings.

## Remote Control (VSX-D850S)

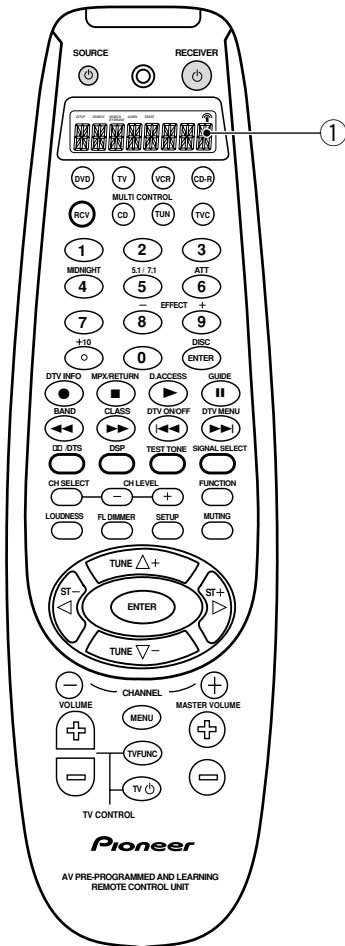

## LCD Display (VSX-D850S only)

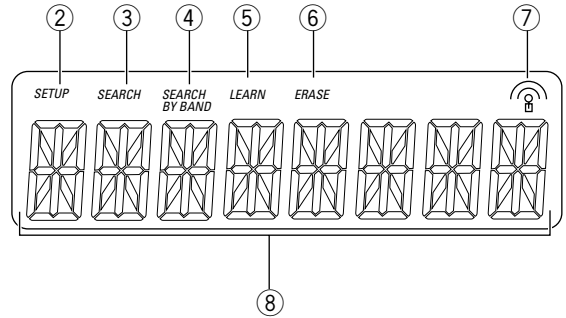

- ① **LCD display**
- ② **SETUP**  
Indicates that the remote is in Setup mode.
- ③ **SEARCH**  
Indicates that the remote is in preset code Search mode.
- ④ **SEARCH BY BRAND**  
Indicates that the remote is in preset code Search by brand mode.
- ⑤ **LEARN**  
Indicates that the remote is in Learning mode and ready to learn signals from other remote controllers.
- ⑥ **ERASE**  
Indicates that the remote is in Erase mode.
- ⑦ **Transmit icon**  
Blinks to indicate the remote is transmitting control signals.
- ⑧ **CHARACTER display**  
Shows preset codes and other information.

## Learning about the Sound Modes



The sound modes are explained here.

There are two cinema modes:  STANDARD, and ADVANCED THEATER. These are designed to be used with multi channel surround sound audio/visual sources (like DVDs and LDs). Intrinsic to home theater, these modes can deliver realistic and powerful surround sound that recreates the movie theater experience. You may need to experiment with them to see which settings suit your home system and personal tastes.

The DSP and STEREO modes are designed to be used with music sources but some DSP modes are also suited for film soundtracks. Again, try different settings with various soundtracks to see which you like.

### (STANDARD) mode

This mode is for pure decoding of Dolby Digital, DTS and Dolby Surround sources. No special effects are added. It is good for enjoying movies that have been recorded in Dolby Digital, DTS or Dolby Surround.

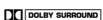
You can identify Dolby Digital software by the  or  marks. Most Dolby Surround software is marked , but unmarked software may also incorporate Dolby Surround.

## ADVANCED THEATER modes

### MUSICAL

Simulates the acoustic environment of a large concert hall and is suitable for music or musical sources marked .

( ) or .

### DRAMA

Simulates the relaxed environment of a classic medium size movie theater, and is suitable for watching dramas on

sources marked  () or .

### ACTION

Simulates the acoustic environment of a large modern movie theater. You can enjoy the power and dynamics of

motion picture audio which is best used with action movies on sources marked ,  or .

### EXPANDED (VSX-D710S)

This mode is especially designed to give sound depth to stereo sources. The overall effect builds a dynamic and broad sound space, allowing two-channel (stereo) signals to faithfully imitate a five speaker sound. Use with Dolby Pro Logic for a stereo surround effect. You can also use with Dolby Digital sources for a wider stereo field than STANDARD mode.

### 5/6-D THEATER (VSX-D810S/D850S)

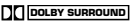
This mode is especially designed to give sound depth to stereo sources. The overall effect builds a dynamic and broad sound space, allowing two-channel (stereo) signals to faithfully imitate a six speaker sound. The mode should be used in conjunction with Dolby Pro Logic for sources bearing the  mark.

# Sound Modes

---

## DSP modes

The DSP (Digital Signal Processing) modes allow you to transform your living room into a variety of different sonic environments when playing standard (two-channel) stereo sources, Dolby Pro Logic sources, and Dolby Digital sources. DSP modes do not work when the speakers are off.

### HALL 1

Simulates the acoustic environment of a large, wooden concert hall. Complex delay of reflected sounds coupled with reverberation effects create the dynamic and beautiful sound characteristics of an orchestra performing in a concert hall, making it suitable for classical music.

### HALL 2

Simulates the acoustic environment of a concert hall with stone walls. The rich reverberations and natural fullness of the sound create the auditory impression of being in a concert hall, also making it suitable for classical music.

### JAZZ

Simulates the acoustic environment of a jazz club. Less delay on the reflected sounds emphasizes the sensation of hearing a live band.

### DANCE

Simulates the acoustic environment and strong bass sound of a dance club. A short delay on the reflected sounds emulates the raw power of the dance music.

### THEATER 1

Adjusts the delay of the reflected sound to simulate the acoustic environment of a medium sized movie theater.

### THEATER 2

Simulates the acoustic environment of a theater while maintaining proper localization of each channel.

### 5/6Ch STEREO (VSX-D810S/D850S)

This mode reproduces stereo sound but uses all the speakers in the system to induce a rich, all-around sound.

### MEMO:

- When using 96 kHz PCM playback, STANDARD, ADVANCED THEATER, and DSP sound modes are not available.

## Switching ANALOG/DIGITAL Signal Input

When you select a function (for example CD) that is only hooked up by a digital connection, then the ANALOG/DIGITAL signal input switch will automatically choose digital for VSX-D810S/D850S. If you have that function hooked up by both digital and analog connections this switch lets you choose which to listen to.

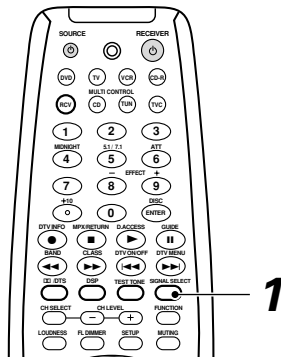

- 1 Press **SIGNAL SELECT** to select the input signal corresponding to the source component.

Each press switches between ANALOG and DIGITAL signal selection (VSX-D710S).

On the VSX-D810S & VSX-D850S receivers there is an AUTO setting. In this setting the receiver will automatically switch between the analog and digital signals according to what is being input. If both signals are input the AUTO setting will choose the digital one. This setting is convenient as the receiver will always choose the best or appropriate signal.

- 2 While **SIGNAL SELECT** is set to DIGITAL, **DD** DIGITAL lights when a Dolby Digital signal is input, **DTS** lights when a DTS signal is input.

**MEMO:**

- SIGNAL SELECT is fixed in the “ANALOG” position for components not assigned to one of the digital input jacks.
- This receiver can only play back Dolby Digital, PCM (32kHz, 44kHz, and 48kHz [VSX-D810S & VSX-D850S can play 96kHz]), and DTS, digital signal formats. With digital signal formats other than these, set SIGNAL SELECT to “ANALOG”.
- Some DVD players don't output DTS signals. For more details, refer to the instruction manual supplied with your DVD player.

## Playing Sources with Dolby Digital or DTS Sound

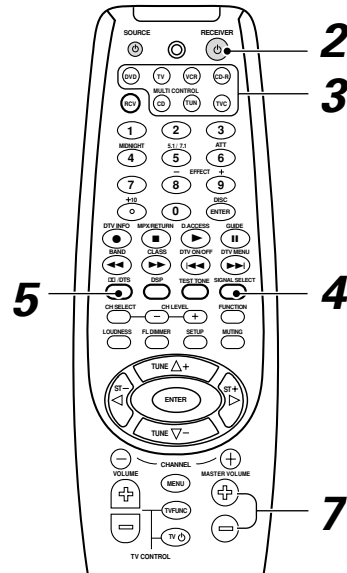

- 1 Turn on the power of the playback component.
- 2 Turn on the power of the receiver.  
Be sure that the standby indicator turns off on the front panel.
- 3 Press **MULTI CONTROL** buttons or the **FUNCTION** button to select the source you want to playback.  
If the DIRECT FUNCTION is OFF you have to use the **FUNCTION** button to select the source (see p.39).
- 4 Press **SIGNAL SELECT** to select DIGITAL.  
(Refer to “Switching ANALOG/DIGITAL signal input” on this page.)
- 5 Press **DD/DTS** to switch the Dolby/DTS mode on.
- 6 Start playback of the component you selected in step 1.
- 7 Press **MASTER VOLUME (+/-)** to adjust the volume level.

**MEMO:**

- You can only hear the sound on DTS encoded discs if the CD or LD player with DTS is digitally connected to this receiver. If you play a DTS encoded disc through analog connections you will only hear digital noise, not the soundtrack. To prevent noise, you need to make digital connections (Refer to page 6-7) and set SIGNAL SELECT to “DIGITAL”.

## Selecting a Sound Mode

To ensure the best possible surround sound, be sure to complete the set up procedures described in “Setting Up for Surround Sound” (starting on page 16) before using the sound modes. This is particularly important when using the **DD** (Dolby) surround mode.

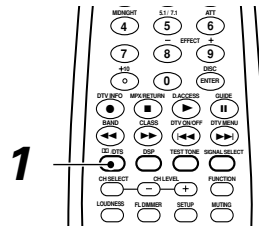

## Surround operation

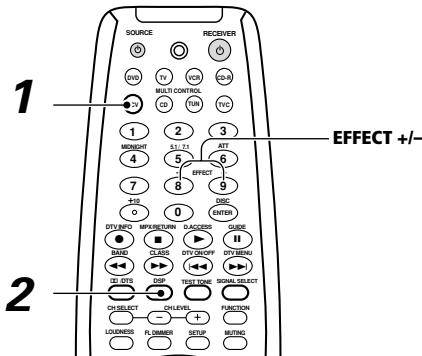

### 1 Press RCV.

This sets the remote to select the sound mode. (You can skip this step when using the controls on the receiver.)

### 2 Press DSP MODE to select the sound mode.

Each press changes the DSP mode as follows:

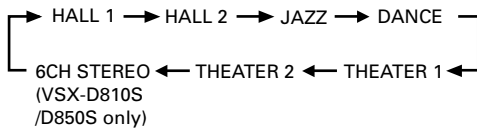

### MEMO:

- The amount of effect of each DSP mode can be adjusted in the range of 10 to 90 (the default setting value is 70) by pressing EFFECT +/-.
- The DSP effects can't be heard in 6 channel stereo (VSX-D810S/D850S only).
- For VSX-D810S/VSX-D850S receivers, when the surround back channel is set to off 6 channel stereo becomes 5 channel stereo.

## ADVANCED THEATER mode ( Dolby/ DTS mode)

Switch on the Dolby/DTS mode by pressing the **DD**/DTS button. When Dolby/DTS mode is ON, Dolby Pro Logic, Dolby Digital and DTS, and signal processing is performed automatically corresponding to the input signal. Use this button to cycle through the various modes.

When the STANDARD mode is selected, DSP modes are off.

- 1 Switch the Dolby/DTS mode on and off by pressing **DD**/DTS on the remote control or **DD**/DTS on the front panel.

Each press changes the display as follows.

(VSX-D710S)



(VSX-D810S/D850S)

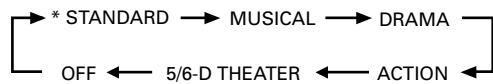

\*When using DTS 5.1/6.1 ch discs in STANDARD mode the display will change to “DTS-ES”. Naturally the playback will still be 6.1 output.(VSX-D810S/D850S)

Refer to page 27 for more details about each surround effect.

### MEMO:

- The effects of Dolby/DTS mode can be adjusted in the range of 10 to 90 by pressing EFFECT +/- (the default setting is 70). Also, the effect level can be set in each ADVANCED THEATER mode by pressing the EFFECT +/- button. The STANDARD mode cannot be changed.
- For the VSX-D810S/VSX-D850S, when the surround back channel is set to off in the speakers settings, 6-D Theater becomes 5-D Theater.

## DVD 5.1 ch./7.1 ch (5.1 ch for VSX-D710S) input playback

If you want you can connect a component with 7.1 channel (5.1 channel for VSX-D710S) analog output to enjoy surround sound playback. In this case the surround sound will be externally decoded and then fed into the receiver.

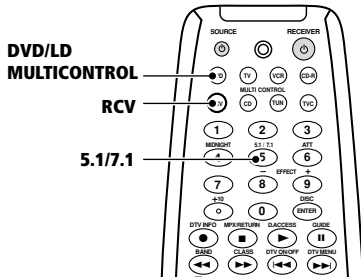

To switch on DVD 7.1 ch (5.1 ch for VSX-D710S) mode press the **DVD/LD MULTICONTROL** button on the remote, then **RCV**, then **5.1/7.1** button.

VSX-D710S only: On the main unit press the **DVD 5.1CH** button to switch on 5.1 ch mode.

Press the **5.1/7.1** button on the remote to go back to the DVD/LD mode. If you're using the main unit, choose any other function with the **MULTI JOG**.

### MEMO:

- When 5.1 ch/7.1 ch input is selected, Dolby mode, DSP mode, SIGNAL SELECT, ATT, DIRECT, TONE, MIDNIGHT mode, LOUDNESS and speakers B cannot be operated.
- When 5.1 ch/7.1 ch input is selected, only the volume level and channel levels can be set.

## MIDNIGHT Listening Mode

When listening at low volume, surround effects tend to become less than satisfactory. Turn the MIDNIGHT listening mode on to enjoy the effects of quality surround sound even at low volumes. This mode allows you to hear effective surround sound of movies at low volume levels.

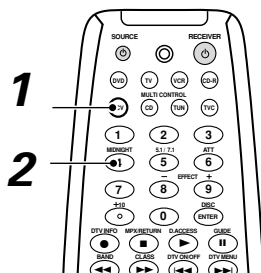

### 1 Press RCV.

This sets the remote to select the sound mode. (You can skip this step when using the controls on the receiver.)

### 2 Press MIDNIGHT.

Each press switches MIDNIGHT listening mode on or off.

### MEMO:

- The effect automatically adjusts according to the volume level.

## Playing other Sources

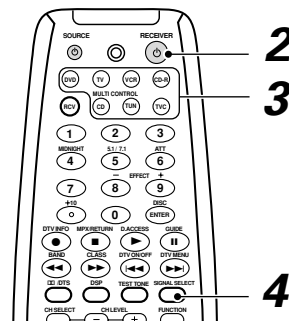

### 1 Turn on the power of the playback component.

### 2 Turn on the power of the receiver.

Be sure that the standby indicator turns off on the front panel.

### 3 Press **MULTI CONTROL** buttons or the **FUNCTION** button to select the source you want to playback.

If the DIRECT FUNCTION is OFF you have to use the FUNCTION button to select the source (see p.39).

### 4 If necessary, press **SIGNAL SELECT** to select the input signal corresponding to the source component (see p.29).

### 5 Start playback of the component you selected in step 1.

## Finding a Station

The following steps show you how to tune in to FM and AM radio broadcasts using the automatic (search) and manual (step) tuning functions. If you already know the exact frequency of the station you want to listen to, see Tuning Directly to a Station on this page. Once you are tuned to a station you can memorize the frequency for recall later—see Memorizing Stations on page 33 for more on how to do this.

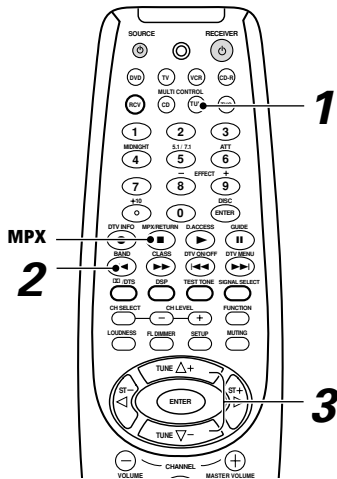

- 1 Press the **MULTI CONTROL TUN** button on the remote control.

On the receiver, use the **MULTI JOG** to select the tuner mode.

- 2 Use the **BAND** button to change the band (FM or AM), if necessary.

Each press switches the band between FM and AM. On the receiver, pressing the **BAND** button switches between bands.

- 3 **Tune to a station.**

### Automatic tuning

To search for stations in the currently selected band, press and hold either the **TUNE +** or **TUNE -** button for about a second. The receiver will start searching for the next station, stopping when it has found one. Repeat this step to search for other stations.

### Manual tuning

To change the frequency one step at a time, press the **TUNE +** or **TUNE -** ( $\Delta$ / $\nabla$ ) buttons.

### High speed tuning

Press and hold the **TUNE +** or **TUNE -** button for high speed tuning, releasing the button once the desired frequency is reached.

## MPX mode

If the **TUNED** or **STEREO** indicators don't light when tuning to an FM station because the signal is weak, press the **MPX** button to switch the receiver into mono reception mode. This should improve the sound quality and allow you to enjoy the broadcast.

## Tuning Directly to a Station

Sometimes, you'll already know the frequency of the station you want to listen to. In this case, you can simply enter the frequency directly using the number buttons on the remote control (this function is not available using the front panel controls of the receiver).

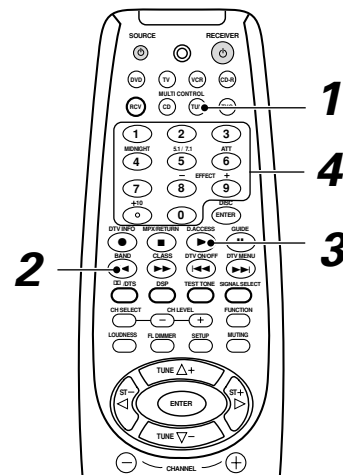

- 1 Press the **MULTI CONTROL TUN** button on the remote control.

On the receiver, use the **MULTI JOG** to select the tuner mode.

- 2 Press the **BAND** button to select either FM or AM.

Each press switches the band between FM and AM. On the receiver, pressing the **BAND** button switches between bands.

- 3 Press **D.ACCESS** (**DIRECT ACCESS**).

- 4 Use the number buttons to enter the frequency of the radio station.

Example: To tune to 106.00 (FM), press **1 - 0 - 6 - 0 - 0**

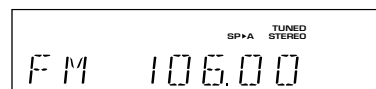

### MEMO:

- If you make a mistake while inputting the frequency, press the **D.ACCESS** button twice to cancel the frequency and start again.



## Memorizing Stations

If you often listen to a particular radio station, it's convenient to have the receiver store the frequency for easy recall whenever you want to listen to that station. This saves the effort of manually tuning in each time. The VSX-D710S/D810S/D850S can memorize up to 30 stations, stored in three banks, or classes, (A,B and C) of 10 stations each. When memorizing FM frequencies, the receiver also stores the MPX setting (auto stereo or mono, see p.32). The process for memorizing stations is only possible from the controls on the front panel of the receiver.

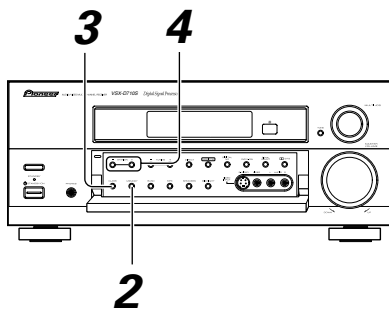

### 1 Tune to a station you want to memorize.

See Finding a Station and Tuning Directly to a Station, on pages 32 and this page, for more on how to do this.

### 2 Press **MEMORY**.

The display shows a blinking memory class.

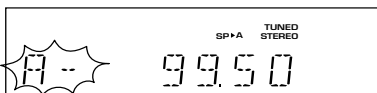

### 3 Press **CLASS** to select one of the three classes.

Repeatedly pressing this button cycles through the three available classes, A, B and C.

### 4 Press **STATION +/-** to select the desired station memory number.

Pressing these buttons repeatedly cycles through the 10 available station memories in each class. After choosing the location you want, the preset class and number blink for about 5 seconds and the receiver stores the station.

Repeat steps 1 to 4 to memorize up to 30 stations.

## Recalling Memorized Stations

Having memorized up to 30 stations (see the previous explanation for how to do this), preset stations can be easily recalled.

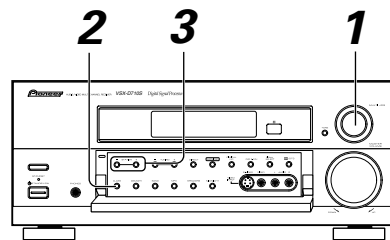
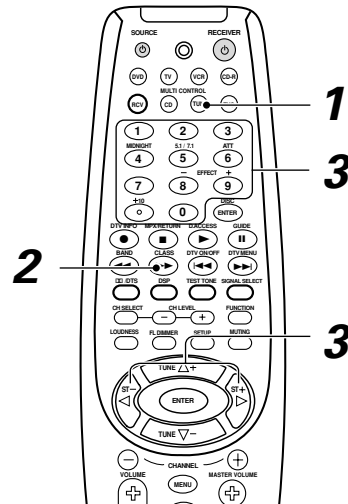

### 1 Press the **MULTI CONTROL TUN** button on the remote control.

On the receiver, use the **MULTI JOG** to select the tuner mode.

### 2 Press **CLASS** to select the class in which the station is stored.

Repeatedly pressing this button cycles through the three available classes, A, B and C.

### 3 Use the **ST +/-** buttons to select the station memory in which the station is stored.

Alternatively, recall the station memory using the number buttons on the remote control.

#### MEMO:

- If the receiver is left disconnected from the AC power outlet for a lengthy period, the station memories will be lost and will have to be reprogrammed.

## Making an Audio or a Video Recording

The following steps show you how to make an audio or a video recording from the built in tuner, or from an audio or video source connected to the receiver (such as a CD player or TV). Recordings can be made to a CD-Recorder, cassette deck, MD, VCR, or DVR deck connected to the CD-R/TAPE/MD, VCR or DVR in/out connectors.

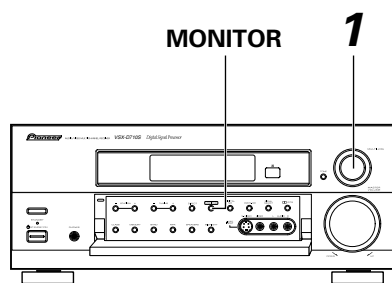
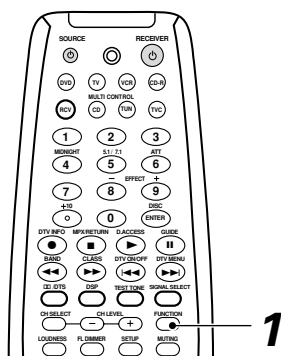

- 1 Turn the **MULTI JOG** dial to select a source to record (you can also use the **MULTI CONTROL** buttons if the **DIRECT FUNCTION** is on).

All functions except **MONITOR** are accessible from the remote control.

- 2 Prepare the program source.

Tune to the radio station, load the CD, etc. For a video recording load the video, DVD etc.

- 3 Insert a blank tape, MD, video etc. into the recording device connected to either **CD-R/MD/TAPE** or **VCR/DVR** and set the recording levels.

Refer to the instructions that came with the recorder if you are unsure how to do this. Most video recorders set the audio recording level automatically—check your video's instruction manual if you are unsure whether yours has manual controls.

- 4 Start recording, then start playback of the source component.

### MEMO:

The receiver's volume, tone control (bass & treble) loudness, and surround effects have no effect on the recorded signal.

## Record MONITOR

You can listen to (monitor) the recording as it's being made using the **MONITOR** button on the front panel (a cassette deck would have to have a record monitor function).

Press the **MONITOR** button to switch between the recorded signal and the original source signal.

## Making a Digital Recording

The VSX-D710S has one optical digital output jack. The VSX-D810S/D850S has one coaxial digital output jack and one optical digital output jack. The quality of these two types of connections is the same so you only need to match the type of connection on this receiver with the type of connection on your component. If you want to make a digital recording from this receiver hook up the optical output on this receiver to the optical input on the digital component you want to record into. The source component (like MD, CD, DVD, etc.) must be digital also, of course, and hooked up to this receiver in a digital manner. Make sure the analog/digital switch is set to digital (see p. 29) The recording procedure is the same as described above.

Refer to the table below for the type of digital connections available in each receiver model.

MODEL	COAX IN	OPT IN	OPT OUT
<b>VSX-D710S</b>	<b>1</b>	<b>2</b>	<b>1</b>
<b>VSX-D810S</b>	<b>1</b>	<b>3</b>	<b>1</b>
<b>VSX-D850S</b>	<b>1</b>	<b>4</b>	<b>1</b>

## Recalling Preset Codes

The following steps show you how to recall preset codes for each MULTI CONTROL button. Once the preset code is assigned, pressing the button will automatically set the remote to operate the respective component.

**MEMO:**

- Refer to “Preset Code List” on pages 43 to 49 for the components and manufacturers available.
- Refer to “Controlling the Rest of Your System” on pages 35 to 49 for detailed explanations on how to operate your other components.

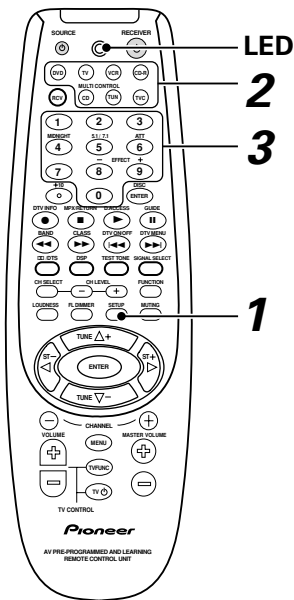

**1 Press SETUP and hold for three seconds to select the Preset mode.**

The LED lights steadily for two seconds. (VSX-D850S only: The LCD display shows SETUP.)

**To cancel the preset mode at any time**

Press **SETUP**.

The remote control will also return to the previous mode after thirty seconds of inactivity.

**2 Press the MULTI CONTROL button for the component you want to control.**

Each button can be set to control one of the following components

- DVD** DVD/LD player or DVD Recorder
- TV** TV, Satellite tuner or Cable TV tuner
- VCR** VCR or Digital Video Recorder
- CD** CD player
- CD-R** CD Recorder, Tape deck or MD player
- TVC** TV or Cable TV tuner
- TUN** FM/ AM tuner

**3 Use the number buttons to enter the 4 digit setup code. (see pages 43-49 for Preset Code List)**

The LED will blink for half a second after each digit is input and will show a long, two second blink to confirm a valid code has been input. (VSX-D850S only: The code appears in the LCD display as you input it. The display shows OK if it's a valid code.) If the LED blinks three times it means an invalid code has been input or an error has occurred. Check the preset code list and try again. If you are not able to input a preset code you can refer to page 38 to teach the remote control individual commands.

The remote control returns to the previous operation mode. It will also return to the previous mode after thirty seconds of inactivity.

**4 Repeat steps 1 through 3 to assign preset codes for as many components as necessary.**

**MEMO:**

- You can only input a code for the component type written on each MULTI CONTROL button.
- If you recall a preset code for the tuner (TUN MULTI CONTROL), you will not be able to control the built-in tuner of this receiver using the remote. To reset the remote to the built-in tuner, input the preset code 7008.
- To erase the preset code for the current MULTI CONTROL button, enter 0000 as the code in step 3.

## Setting Up Using Preset Code Search (VSX-D710S/D810S)

An alternative method of setting up the remote with preset codes is to use the search feature. The remote transmits batches of 10 codes; when you see the component responding you just scan through those last 10 codes until you find the correct one.

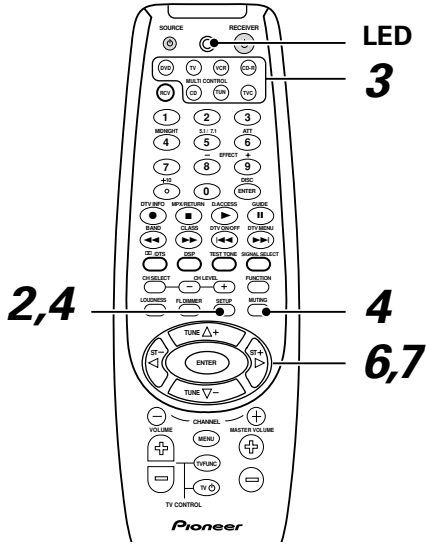

- 1 Switch on the component you want to control.

If the component is some kind of player (CD player, VCR, etc.), then start it playing.

- 2 Press and hold **SETUP** for three seconds.

The LED lights steadily for two seconds. The remote control will also return to the previous mode after thirty seconds of inactivity.

- 3 Press the **MULTI CONTROL** button for the component you want to control.

Each button can be set to control one of the following components

<b>DVD</b>	DVD/LD player or DVD Recorder
<b>TV</b>	TV, Satellite tuner or Cable TV tuner
<b>VCR</b>	VCR or Digital Video Recorder
<b>CD</b>	CD player
<b>CD-R</b>	CD Recorder, Tape deck or MD player
<b>TVC</b>	TV or Cable TV tuner
<b>TUN</b>	FM/ AM tuner

- 4 Press and hold **SETUP** for two seconds.

A batch of 10 codes is transmitted and the LED blinks during transmission. If you see the component respond, by stopping (for playback components only) or switching off, go on to the step 5, otherwise repeat this step.

If you want to cancel the search mode, press and hold **MUTING** for two seconds.

- 5 Switch the component back on or restart playback.
- 6 Use the  $\Delta$   $\nabla$  buttons to scan through the last 10 codes transmitted to identify the correct code.

The LED will blink during transmission of the code. Stop when you see the component stop or switch off. You can also verify you have the correct code by pressing **PLAY**, **STOP**, **VOL +/-**, etc.

- 7 Press and hold **ENTER** for three seconds to save the preset code.

The remote control automatically returns to normal usage.

## Setting Up Using Full Library Search (VSX-D850S)

An alternative method of setting up the remote with preset codes is to use the Library Search feature. The remote transmits batches of 10 codes; when you see the component responding you just scan through those last 10 codes until you find the correct one.

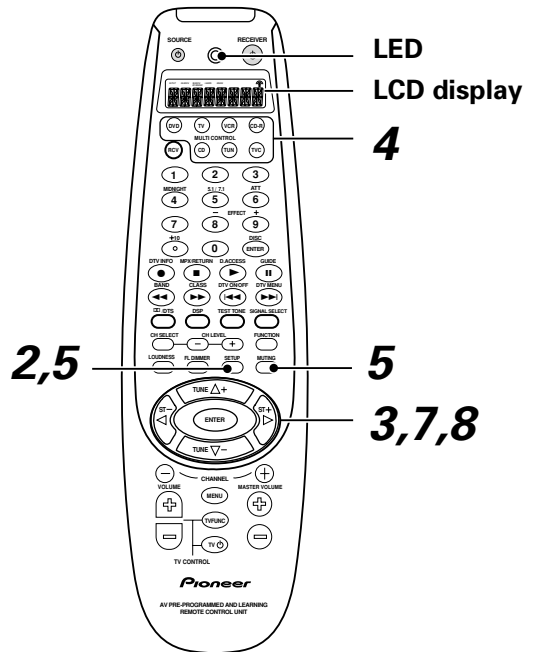

- 1 Switch on the component you want to control.

If the component is some kind of player (CD player, VCR, etc.), then start it playing.

- 2 Press and hold **SETUP** for three seconds.

The remote's LCD display shows **SETUP**. The remote control will also return to the previous mode after thirty seconds of inactivity.

### 3 Use the ◀▶ buttons to select the Full Library Search mode.

The remote's LCD display shows SEARCH.

### 4 Press the MULTI CONTROL button for the component you want to control.

Each button can be set to control one of the following components

<b>DVD</b>	DVD/LD player or DVD Recorder
<b>TV</b>	TV, Satellite tuner or Cable TV tuner
<b>VCR</b>	VCR or Digital Video Recorder
<b>CD</b>	CD player
<b>CD-R</b>	CD Recorder, Tape deck or MD player
<b>TVC</b>	TV or Cable TV tuner
<b>TUN</b>	FM/ AM tuner

### 5 Press and hold SETUP for two seconds.

A batch of 10 codes is transmitted and the LED blinks during transmission.

If you see the component respond, by stopping (for playback components only) or switching off, go on to the step 6, otherwise repeat this step. After the ten codes have been sent the search icon blinks.

If you want to cancel the search mode, press and hold MUTING for two seconds.

### 6 Switch the component back on or restart playback.

### 7 Use the Δ ▽ buttons to scan through the last 10 codes transmitted to identify the correct code.

The transmission icon is on while the codes are sent out. Stop when you see the component stop or switch off. The LCD display shows the I.D.

You can also verify you have the correct code by pressing PLAY, STOP, VOL +/-, etc.

### 8 Press and hold ENTER for three seconds to save the preset code.

### 2 Press and hold SETUP for three seconds.

The remote's LCD display shows SETUP.

The remote control will also return to the previous mode after thirty seconds of inactivity.

### 3 Use the ◀▶ buttons to select the Brand Search mode, then press ENTER.

The remote's LCD display shows BRAND SEARCH.

### 4 Press the MULTI CONTROL button for the component you want to control.

Each button can be set to control one of the following components

<b>DVD</b>	DVD/LD player or DVD Recorder
<b>TV</b>	TV, Satellite tuner or Cable TV tuner
<b>VCR</b>	VCR or Digital Video Recorder
<b>CD</b>	CD player
<b>CD-R</b>	CD Recorder, Tape deck or MD player
<b>TVC</b>	TV or Cable TV tuner
<b>TUN</b>	FM/ AM tuner

### 5 Use the Δ ▽ buttons to select the brand of the component.

The brand names appear in the remote's LCD display. If the brand of your component doesn't appear then you can't use this feature.

### 6 Press and hold SETUP for two seconds.

A batch of 10 codes is transmitted and the transmission icon is on while the codes are sent out. After all ten codes have been sent the search icon blinks.

If you see the component respond, by stopping (for playback components only) or switching off, go on to the step 6, otherwise repeat this step.

If you want to cancel the search mode, press and hold MUTING for two seconds.

### 7 Switch the component back on or restart playback.

### 8 Use the Δ ▽ buttons to scan through the last 10 codes transmitted to identify the correct code.

The transmission icon is on while the codes are sent out. Stop when you see the component stop or switch off. The display shows the I.D.

You can also verify you have the correct code by pressing PLAY, STOP, VOL +/-, etc.

### 9 Press and hold ENTER for three seconds to save the preset code.

## Setting Up Using Brand Name Search (VSX-D850S only)

An alternative method of setting up the remote with preset codes is to use the Brand Search feature. The remote transmits batches of 10 codes; when you see the component responding you just scan through those last 10 codes until you find the correct one.

### 1 Switch on the component you want to control.

If the component is some kind of player (CD player, VCR, etc.), then start it playing.

## Learning Mode: Programming Signals from other Remote Controls

If preset codes are not available for your component(s), or the available preset codes do not operate correctly, you can use this function to program in signals from the remote control(s) of your other component(s). This operation can also be used after recalling a preset code to program additional operations not covered in the preset codes.

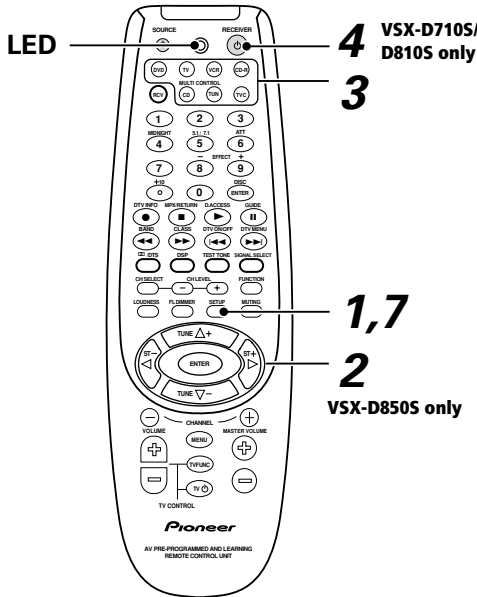

- 1 **Press SETUP and hold for three seconds.**  
The LED on the remote control will light for two seconds.  
**To cancel the Learning mode at any time**  
Press **SETUP**.  
The remote control will also return to the previous mode after thirty seconds of inactivity.
- 2 **VSX-D850S only: Use the < > buttons to select the Learning mode.**  
The Learning mode is indicated by the Learning icon (LEARN) in the remote's LCD display.
- 3 **Press the MULTI CONTROL button for the component you want to control**
- 4 **VSX-D710S/D810S: Press and hold the RECEIVER button for two seconds to start the Learning mode.**  
The LED lights steadily.  
**To cancel LEARNING setup mode**  
Press **SETUP** for one second.  
If no commands are entered within thirty seconds the remote will revert to its previous mode.

- 5 **Point the two remote controls towards each other. Press the button to be learned on this receiver's remote control (for example the ► [play] button).**

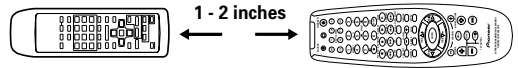

Point the remote controls directly at each other, about 1-2 inches apart, and press the button on the remote control for the operation you want to program. The LED flashes rapidly. For VSX-D850S, the LEARN icon blinking.

- 6 **Press the corresponding button on the other remote control to be taught to this receiver's remote control (in the above example the ► [play] button).**

Point the remote controls toward each other. Press the button on the other remote control corresponding to the operation you wish to program. The LED on this receiver's remote will go out and then resume a steady light if the operation is learned. (For VSX-D850S model the LEARN icon will light steadily and the LCD display will show "OK" if the operation has been learned.) If the operation hasn't been learned for some reason the LED will blink for three seconds and then light steadily. (For VSX-D850S model the LCD will display "error" if the operation hasn't been learned.) If this happens press the teaching key repeatedly, varying the distances between the remotes, until you see the LED on this unit's remote light steadily, without blinking first.

### To program additional operations for the current component

Repeat steps 5 and 6.

### To program operations for another component

Repeat steps 2 through 6 (VSX-D850S).

Repeat steps 3 through 6 (VSX-D710S/D810S).

- 7 **Press and hold SETUP for one second to exit the LEARNING setup mode.**

After thirty seconds of inactivity the remote control will automatically leave the LEARNING mode and revert to its previous mode.

### MEMO:

- Some commands from other remote controls cannot be learned, but in most cases the remotes just need to be moved closer together or farther apart.
- Certain buttons represent modes that cannot be learned from other remote controls. These include: RCV, CH SELECT, CH LEVEL, FUNCTION LOUDNESS, FL DIMMER, and MUTING.
- TV CONTROL buttons ( TV, VOL +/-, and TV FUNC ) can only be learned in TV & TVC mode.

### Erasing One of the Remote Control Button Settings

This erases one of the buttons you have programmed and restores the factory installed preset to that button.

VSX-D710S/D810S:

- 1 Press SETUP and hold for three seconds.**

The LED on the remote control will light for two seconds.
- 2 Press the MULTI CONTROL button relating to the function of the button to be cleared.**

The remote control will return to the previous mode after thirty seconds of inactivity.
- 3 Press the RECEIVER  $\odot$  button twice within three seconds to start erase mode.**

The LED blinks.
- 4 Press the button to be cleared for three seconds.**

The LED lights steadily for three seconds and then goes off.
- 5 Repeat steps 4 to erase other codes.**
- 6 Press and hold the SETUP button for one second to exit the erase mode.**

VSX-D850S:

- 1 Press SETUP and hold for three seconds.**

The LED on the remote control will light for two seconds and the display shows SETUP.
- 2 Use the  $\triangleleft \triangleright$  buttons to select the Erase mode.**

The LCD display shows ERASE.
- 3 Press the MULTI CONTROL button relating to the function of the button to be cleared.**
- 4 Press the button you want to clear.**
- 5 Repeat steps 3-4 to erase other codes.**

### Clearing All the Remote Control Settings

Clears all presets, all learned functions and restores the factory presets.

- 1 Press SETUP and hold for three seconds.**

For the VSX-D710S and VSX-D810S the LED on the remote control lights for two seconds. For the VSX-D850S the SETUP icon lights.  
If you want to cancel the Clearing mode, press **SETUP**.  
The remote control will also return to the previous mode after thirty seconds of inactivity.

- 2 Use the number buttons to enter 0123.**

The LED light for half a second for each digit input. On the VSX-D710S and VSX-D810S the LED lights for two seconds to indicate that the settings have been restored to the factory presets. (If the LED blinks three times, then you made a mistake with the code—try re-entering it.) On the VSX-D850S the LCD displays 0123 and then “OK” for two seconds if the four digit code has been accepted. If any error has occurred display will blink three times.

### Direct Function

The direct function is a useful feature which allows you keep the receiver in one function (for example, CD) while putting the remote control in a different function. This could let you, for example, use the remote control to set up and listen to a CD on the receiver and then use the remote control to rewind a tape in your VCR while you continue to listen to your CD player.

When the DIRECT function is ON any MULTI CONTROL button you press will change the function of both the receiver and the remote control. When you turn the DIRECT function OFF, you can operate the remote control without affecting the receiver. Thus you could switch the remote control the VCR and operate that component while the receiver plays a different component.

To set a MULTI CONTROL button to DIRECT ON or DIRECT OFF:

- 1 Press SETUP and hold for three seconds.**

On the VSX-D710S and VSX-D810S the LED on the remote control will light for two seconds. On the VSX-D850S the LCD display SETUP icon will light. If you want to cancel the Direct Function mode, press **SETUP**.  
The remote control will also return to the previous mode after thirty seconds of inactivity.
- 2 Press the MULTI CONTROL button that you want to set up.**
- 3 Use the number buttons to enter 9990 (DIRECT ON) or 9995 (DIRECT OFF).**

The LED will light for half a second on each digit input. Then, on the VSX-D710S and VSX-D810S the LED will light for two seconds to indicate that it's been correctly set. (If the LED blinks three times, then you made a mistake with the code—try re-entering it.) On the VSX-D850S, the LCD will display “OK” to show the four digit code has been accepted. If it hasn't been accepted the display will blink three times.

#### MEMO:

- TV CONT doesn't have this feature and thus can't use the DIRECT FUNCTION.

### Checking Preset Codes

To check which preset code is associated with a MULTI CONTROL button:

VSX-D710S/D810S:

**1 Press SETUP and hold for three seconds.**

The LED on the remote control lights for two seconds.

**2 Press the MULTI CONTROL button you want to check the preset code for.**

**3 Press and hold ENTER for two seconds.**

Each preset code consists of four digits, for example 1329. Each digit will be represented by a series of blinks on the remote's LED—3 blinks to represent the digit "3", etc. ("0" is represented by 10 blinks.)

VSX-D850S:

**1 Press and hold for three seconds the MULTI CONTROL button you want to check the preset code for.**

The preset code appears in the remote's LCD display.

### Operating other Pioneer Components

By connecting a control cord (optional), you can control other Pioneer equipment using this remote control unit. Point the remote control unit towards the remote sensor of this unit, even when operating other equipment.

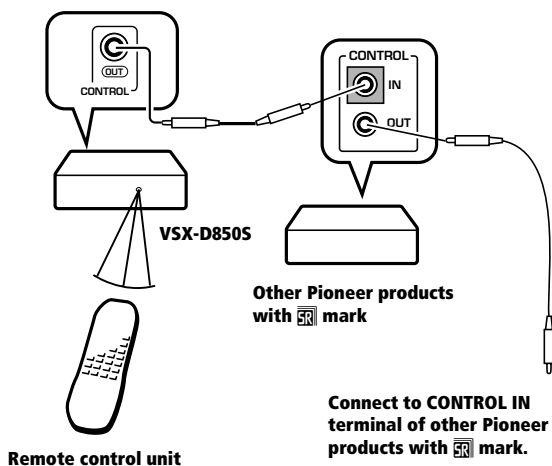

The remote control signals are received by the remote sensor of this unit, and sent to the other devices via the **CONTROL OUT** terminal.

**MEMO:**

















- You can also control Pioneer components by pointing the receiver's remote control directly at the component. This type of operation does not require control cords.



## CD/MD/CD-R/VCR/DVD/LD/DVR Player/Cassette Deck Controls

This remote control can control these components after entering the proper codes or teaching the receiver the commands (see p.35-37).

Use **MULTI CONTROL** buttons to put the remote control in the stated mode.

Button(s)	Function	Components
SOURCE 	Press to switch the components between STANDBY and ON.	CD/MD/CD-R/VCR/DVD/LD/DVR Player/Cassette deck
	Press to return to the start of the current track. Repeated presses skips to the start of previous tracks.	CD/MD/CD-R/DVD/LD Player
	Go back channels (channel -).	VCR/DVR
	Play the reverse side of the tape on a reversible deck.	Cassette deck
	Press to advance to the start of the next track. Repeated presses skips to the start of following tracks.	CD/MD/CD-R/LD Player
	Go forward channels (channel +).	VCR
	Play the forward side of the tape on a reversible deck.	Cassette deck
	Pause playback or recording.	CD/MD/CD-R/VCR/DVD/LD/DVR Player/Cassette deck
	Hold down for fast forward playback.	CD/MD/CD-R/VCR/DVD/LD/DVR Player/Cassette deck
	Hold down for fast reverse playback.	CD/MD/CD-R/VCR/DVD/LD/DVR Player/Cassette deck
	Start playback.	CD/MD/CD-R/VCR/DVD/LD/DVR Player/Cassette deck
	Stop playback (on some models, pressing this when the disc is already stopped will cause the disc tray to open).	CD/MD/CD-R/VCR/DVD/LD/DVR Player/Cassette deck
Number Buttons	Directly access tracks on a program source.	CD/MD/CD-R/VCR/LD Player
	Use the number buttons to navigate the on-screen display.	DVD/DVR Player
+10 Button	Select tracks higher than 10. Press this button and the remaining number to get the track (+10 Button + 3= track 13).	CD/MD/CD-R/VCR/LD Player
DISC Button	Choose the disc.	Multiple CD player
	Ejects the disc	MD Player
	Press to switches between the VCR tuner and the TV tuner.	VCR/Cassette deck
	Changes sides of the LD.	LD Player
● RECORD Button	Start recording. To prevent accidental recording, this button must be pressed twice to take effect (the second press must be within 10 seconds of the first).	VCR/DVR Player
MENU	Displays menus concerning the current DVD or DVR you are using.	DVD/DVR Player
	Pause the tape.	Cassette deck
	Stop the tape.	Cassette deck
ENTER	Start playback.	Cassette deck
	Fast rewind the tape.	Cassette deck
	Fast forward the tape	Cassette deck
    & ENTER	Navigate DVD menus/options.	DVD/DVR Player

## Controlling the Rest of Your System

### Cable TV/Satellite TV/TV/DTV Controls

This remote control can control these components after entering the proper codes or teaching the receiver the commands (see p.35-37).

Use **MULTI CONTROL** buttons to put the remote control in the stated mode.

Button(s)	Function	Components
TV	Press to switch the DTV on or off. Press to switch the TV or CATV between STANDBY and ON.	DTV Cable TV/Satellite TV/TV
TV FUNC.	Press to switch the TV input. (Not possible with all models. If it doesn't work with the preset code, use the learning feature.)	TV
CHANNEL +/-	Select channels.	Cable TV/Satellite TV/TV/DTV
TV VOL +/-	Adjust the TV volume.	Cable TV/Satellite TV/TV/DTV
SOURCE	Press to switch the DTV on or off.	DTV
	Move to lower numbered channels Choose the RED commands on a DTV menu.	Cable TV/Satellite TV/TV DTV
	Use to move to higher numbered channels Use to choose the YELLOW commands on a DTV menu.	Cable TV/Satellite TV/TV DTV
	Use as the GUIDE button for navigating	DTV
	Use to choose the GREEN commands on a DTV menu.	DTV
	Use to choose the BLUE commands on a DTV menu.	DTV
	Use to get INFO on the DTV program.	DTV
	Use to switch DTV audio tracks	DTV
Number Buttons	Use to select a specific TV channel.	Cable TV/Satellite TV/TV/DTV
+10 Button	Use to add a decimal point when selecting a specific TV channel.	DTV
DISC Button	Use to enter a channel.	DTV
MENU	Select different menus from the DTV functions. Select the menu screen.	DTV Cable TV/Satellite TV/TV
& ENTER	Select or adjust and navigate items on the menu screen. ENTER : Use to bring up the DTV menus.	DTV
ENTER	Press to select or adjust and navigate items on the menu screen.	Cable TV/Satellite TV/TV/DTV
EFFECT +/-	For TV and cable TV use this button to immediately enter a new channel (CHANNEL ENTER function). For satellite TV use this button to exit the menu screen.	Cable TV/Satellite TV/TV/DTV

#### MEMO:

- The first four buttons for the VSX-D710S/D810S/D850S are dedicated to control the TV assigned to the **TVC** button. Thus if you only have one TV to hook up to this system assign it to the **TVC MULTI CONTROL** button. If you have two TVs, assign the main TV to the **TVC** button. If you hook up your system this way, the first four TV controls will always be accessible.

## Preset Code List

You can only set these codes for the buttons that assigned to the respective components. So, for example, the TV codes can only be set to the TV or TVC button.

TV	TV	TVC
<b>Manufacturer</b>	<b>Code</b>	
PHILIPS	1008, 1017, 1020 1025, 1104, 1115	
SONY	1001, 1007, 1016	
PANASONIC	1023, 1054, 1055 1075, 1076, 1082 1087, 1121, 1124	
TOSHIBA	1015, 1016, 1027 1031, 1050, 1051 1085	
TELEFUNKEN	1005, 1026, 1034 1038, 1042, 1046 1075, 1097	
SHARP	1016, 1019, 1041 1056, 1124	
SAMSUNG	1006, 1011, 1013 1017, 1026, 1027 1039, 1062, 1079 1089, 1092, 1102	
FERGUSON	1005, 1017, 1033 1046, 1065, 1084 1091	
mitsubishi	1011, 1016, 1041 1045, 1049, 1062 1114	
GOLDSTAR	1002, 1011, 1013 1017, 1019, 1026 1046, 1062, 1079 1092	
BLAUPUNKT	1066, 1068, 1071 1075, 1115	
RADIOLA	1008, 1017	
JVC	1016, 1024, 1030 1053, 1065, 1067 1103, 1122	
DAEWOO	1006, 1011, 1017 1019, 1028, 1040 1050, 1104, 1110 1118, 1119	
ORION	1017, 1063, 1083 1095, 1098, 1099 1112	
SIEMENS	1017, 1052, 1066 1068, 1071, 1075 1115	
ADMIRAL	1041, 1055, 1075 1112	
ADYSON	1014, 1079	
AIKO	1040	
AKAI	1013, 1074	
AKURA	1080, 1089	
ACURA	1006	
ALARON	1063, 1078	
ALBA	1006, 1016, 1017 1080, 1103	
ALLORGAN	1095	
ANAM	1004, 1006, 1029 1054, 1064, 1087 1108	
ANAM NATIONAL	1054, 1087, 1108	
AMBASSADOR	1061	
AMERICA ACTION	1064	
AMPLIVISION	1079	
AMPRO	1126	
AMSTRAD	1006, 1017, 1103 1105	
ANITECH	1006, 1029, 1036	
AOC	1011, 1013	
ARCAM	1078, 1079	
ASBERG	1036	
ASUKA	1080	
ATLANTIC	1073	
AUDIOSONIC	1017, 1046	
AUDIOVOX	1040, 1064, 1110 1118	
AUTOVOX	1036, 1073	
BANG & OLUFSEN	1116	
BASIC LINE	1006, 1080	
BAYSONIC	1064	
BAUR	1007, 1017, 1114 1115	
BEKO	1102	
BELCOR	1011	
BELL & HOWELL	1009, 1050	
BEON	1017	
BINATONE	1079	
BLUE SKY	1080	
BLUE STAR	1090	
BONDSTEC	1086	
BOOTS	1079	
BPL	1090	
BSR	1095	
BRADFORD	1064	
BRANDT	1046, 1069, 1070 1072	
BRITANNIA	1078	
BROCKWOOD	1011	
BROKSONIC	1083, 1112	
BTC	1080	
BUSH	1006, 1016, 1017 1080, 1090, 1095 1103, 1104 1013, 1026	
CANDLE	1013	
CARNIVALE	1016	
CARREFOUR	1016	
CARVER	1025, 1058	
CASCADE	1006	
CATHAY	1017	
CENTURY	1075	
CENTURION	1017	
CELEBRITY	1001	
CCE	1017	
CGE	1034, 1036, 1038 1086, 1097	
CIMLINE	1006	
CINERAL	1040, 1110	
CITIZEN	1013, 1019, 1026 1027, 1040	
CLARIVOX	1017	
CLATRONIC	1036, 1086, 1102	
CME	1007, 1015, 1114	
CONCERTO	1026	
CONDOR	1098, 1102	
CONTEC	1006, 1016, 1064 1078	
CONTINENTAL EDISON	1069, 1070 1072	
CRAIG	1054	
CROSLEY	1025, 1034, 1036 1038, 1075	
CROWN	1006, 1017, 1019 1036, 1064, 1102 1106	
CRYSTAL	1109	
CS ELECTRONICS	1078	
CTC	1086	
CURTIS MATHES	1009, 1013, 1019 1022, 1023, 1025 1026, 1027, 1041 1047, 1050, 1057 1110, 1113, 1129 1131	
CYBERTRON	1080	
CXC	1064	
DAINICHI	1077, 1080	
DANSAI	1017	
DAYTRON	1006, 1011	
DECCA	1017, 1032	
DE GRAAF	1074	
DENON	1047	
DIXI	1006, 1017	
DUAL TEC	1079	
DUMONT	1010, 1011, 1031	
DWIN	1125, 1127	
ECE	1017	
ELBE	1088	
ELECTROBAND	1001	
ELIN	1017	
ELITE	1080, 1098	
ELTA	1006	
EMERSON	1011, 1018, 1019 1050, 1061, 1062 1063, 1064, 1075 1083, 1090, 1112 1118, 1119	
ENVISION	1013	
ERRES	1008, 1017	
ETRON	1006, 1120	
EXPERT	1073	
FIDELITY	1078	
FINLANDIA	1074	
FINLUX	1017, 1031, 1032 1044	
FISHER	1050, 1074, 1079 1096, 1102	
FLINT	1111	
FORMENTI	1017, 1075, 1098	
FORTRESS	1041	
FRONTECH	1055, 1086, 1089 1109	
FUJITSU	1032, 1063, 1073	
FUNAI	1059, 1063, 1064 1089, 1095, 1096 1064	
FUTURETECH	1064	
GE	1012, 1022, 1023 1041, 1062, 1090 1110, 1129, 1131 1017, 1020, 1032 1072, 1079	
GELOC	1072, 1079	
GELOSO	1006, 1075	
GENEXXA	1055, 1080	
GIBRALTER	1010, 1011, 1013	
GOODMANS	1016, 1017, 1032 1079, 1103, 1104 1102	
GORENJE	1102	
GPM	1080	
GRAETZ	1055	
GRANADA	1017, 1032, 1048 1074, 1079, 1100	
GRADIENTE	1024, 1026, 1058	
GRANDIN	1090	

## Controlling the Rest of Your System

GRUNDIG	1031, 1066, 1068 1072, 1115	MANESTH	1079, 1089, 1098	PHONOLA	1008, 1017
GRUNPY	1063, 1064	MARANTZ	1013, 1017, 1025	PILOT	1011, 1013, 1019
HALLMARK	1062	MARK	1017	PORTLAND	1011, 1019, 1040
HANSEATIC	1017, 1098	MATSUI	1006, 1015, 1016 1017, 1032, 1074, 1079, 1095, 1103	PRISM	1023
HARLEY DAVIDSON	1063			PROFEX	1006, 1037
HARVARD	1029, 1064	MATSUSHITA	1087	PROLINE	1099
HARMAN/KARDON	1025	MCMICHAEL	1020	PROSOCAN	1022
HCM	1006, 1090, 1105	MEDIATOR	1008, 1017	PROTECH	1006, 1017, 1043 1079, 1086, 1089 1106, 1109
HINARI	1006, 1016, 1017 1080	MEGATRON	1047, 1062	PROTON	1062, 1113
HISAWA	1090, 1111	MEMOREX	1006, 1009, 1026 1049, 1050, 1062 1087, 1112	PULSAR	1010, 1011
HITACHI	1014, 1016, 1018 1020, 1021, 1026 1044, 1046, 1047 1055, 1069, 1070 1079, 1081, 1097 1078, 1104	METZ	1075	PYE	1008
HUANYU	1017, 1089, 1090	MGA	1011, 1013, 1049 1062	QUASAR	1023, 1056, 1087
HYPSON	1017, 1089, 1090	MIDLAND	1010, 1019, 1022 1023	QUELLE	1007, 1017, 1031 1034, 1038, 1071 1075, 1097, 1114 1115
ICE	1079, 1089, 1103	MINERVA	1031, 1115	QUESTA	1016
ICES	1080	MINOKA	1105	R-LINE	1017
IMPERIAL	1034, 1036, 1038 1086, 1102, 1106	MINUTZ	1012	RANK ARENA	1016
INDIANA	1017	MIVAR	1078, 1092, 1093 1094	RBM	1031
INFINITY	1025	MOTION	1036	RCA	1011, 1018, 1022 1023, 1039, 1041 1128, 1129, 1130 1131, 1132
INGELEN	1055	MOTOROLA	1041	REALISTIC	1011, 1013, 1019 1026, 1050, 1056 1062, 1064
INNO HIT	1032	MTC	1011, 1013, 1026 1027, 1078, 1114	REX	1055, 1073, 1088 1089
INNOVA	1017	MULTITECH	1006, 1036, 1043 1064, 1078	REVOX	1017
INTEQ	1010	NAD	1051, 1057, 1062	ROADSTAR	1006, 1080, 1089 1106
INTERBUY	1029	NEC	1011, 1013, 1016 1026, 1058	RUNCO	1010, 1013, 1117
INTERFUNK	1017, 1055, 1086 1114	NECKERMANN	1017, 1066, 1075 1115	SABA	1035, 1046, 1055 1069, 1070, 1072 1075, 1091 1084
INTERVISION	1017, 1029, 1043 1079, 1089	NEI	1017, 1109	SACCS	1084
ISUKAI	1080	NETSAT	1017	SAISHO	1006, 1089, 1109
ITS	1103	NICAMAGIC	1078	SALORA	1055
ITT	1055	NIKKAI	1014, 1015, 1017 1032, 1078, 1080 1089	SAMBERS	1036, 1043, 1075
JBL	1025	NIKKO	1013, 1040, 1062	SAMPO	1013, 1019
JCB	1001	NOBLIKO	1036, 1043	SAMSUX	1019
KAISUI	1006, 1078, 1079 1080, 1090,	NORDMENDE	1046, 1069, 1070 1075, 1091	SANDRA	1078
KAMP	1078	NTC	1040	SANSEI	1110
KAPSCH	1055, 1073	OCEANIC	1055, 1077	SANSUI	1112
KAWASHO	1078	ONWA	1064	SANYO	1016, 1032, 1048 1050, 1052, 1074 1075, 1100
KEC	1064	OPTIMUS	1050, 1057, 1087	SBR	1008, 1017, 1020
KENDO	1017	OPTONICA	1041, 1056	SCHNEIDER	1017, 1080, 1086 1096, 1103
KNEISSEL	1088	OSAKI	1014, 1032, 1079 1080, 1089, 1105 1080	SCIMITSU	1011
KENWOOD	1011, 1013	OSO	1080	SCOTCH	1062
KINGSLEY	1078	OSUME	1014, 1032, 1052	SCOTT	1011, 1062, 1063 1064, 1083
KONIG	1114	OTTO	1007, 1114	SEARS	1022, 1025, 1026 1050, 1051, 1059 1062, 1063
KORPEL	1017	OTTO VERSAND	1007, 1016, 1017 1066, 1075, 1079 1098, 1115	SEG	1016, 1036, 1079 1089
KOYODA	1006	PALLADIUM	1102, 1106	SEI	1043, 1075, 1095
KTV	1013, 1019, 1064 1095	PANAMA	1079, 1089	SEI-SINUDYNE	1007
LEYCO	1017, 1032, 1089 1095	PATHE MARCONI	1069, 1070, 1072	SELECO	1055, 1073, 1088
LG	1026	PATHE CINEMA	1075, 1078, 1084 1098	SEMIVOX	1064
LIESENK&TTER	1017	PAUSA	1006	SEMP	1051
LLOYTRON	1014	PENNEY	1003, 1011, 1012 1013, 1019, 1022 1023, 1026, 1027 1051, 1062, 1131	SENTRA	1015
LOEWE	1035, 1114			SHOGUN	1011
LOGIK	1009	PERDIO	1098	SHORAI	1095
LUMA	1073	PHAPSODY	1078	SSS	1011, 1064
LUXMAN	1026	PHASE	1014	SIAREM	1043, 1075
LXI	1022, 1025, 1050 1051, 1062	PHILCO	1011, 1013, 1025 1034, 1036, 1038 1047, 1075, 1086 1112		
M ELECTRONIC	1006, 1017, 1029 1044, 1046, 1055 1079, 1091, 1104				
MAGNAVOX	1013, 1016, 1025 1063				
MAGNADYNE	1043, 1086				
MAGNAFON	1036, 1043, 1075				
MAJESTIC	1009				

SINDYNE	1043, 1075, 1095
SIGNATURE	1009
SILVER	1016
SKY	1017
SKY-WORTH	1017
SOLAVOX	1014, 1055
SONITRON	1074
SONOKO	1006, 1017
SONOLOR	1055, 1074, 1077
SONTEC	1017
SOUNDESIGN	1062, 1063, 1064
SOUNDWAVE	1017, 1106
SQUAREVIEW	1059
STANDARD	1006, 1079, 1080
STARLITE	1064
STERN	1055, 1073, 1088
SUNKAI	1095, 1099
SUPERTECH	1078
SUPREME	1001
SUSUMU	1080
SYLVANIA	1013, 1025
SYMPHONIC	1059
SYSLINE	1017
TANDY	1032, 1041, 1055
	1079, 1080
TASHIKO	1016, 1020, 1079
TEC	1079, 1086
TECHNEMA	1098
TECHNICS	1023, 1087, 1121
TECHNOL ACE	1063
TECHWOOD	1023, 1026
TEKNIKA	1009, 1011, 1019
	1025, 1026, 1027
	1040, 1049, 1063
	1064
TELEAVIA	1072
TELEMEISTER	1098
TELETECH	1006
TELETON	1016, 1073, 1079
TENSAI	1080, 1095, 1098
TEXTET	1078, 1080
THOMSON	1046, 1069, 1070
	1072, 1091
THORN	1015, 1017, 1032
	1034, 1038, 1065
	1067, 1114
TMK	1026, 1061, 1062
TOMASHI	1090
TOTEVISION	1019
TRIUMPH	1085
TUTUNG	1017, 1032, 1079
UHER	1073, 1096, 1098
ULTRA	1067
ULTRAVOX	1043
UNIVERSUM	1017, 1044, 1089
	1102
VECTOR RESEARCH	1013
VESTEL	1017
VICTOR	1016, 1024, 1053
	1087
VIDEOSAT	1086
VIDEOTECHNIC	1079
VIDIKRON	1025
VIDTECH	1011, 1016, 1062
VISION	1098
VOXSON	1055
WALTHAM	1079
WATSON	1017, 1098
WATT RADIO	1043

WARDS	1009, 1011, 1012
	1013, 1025, 1026
	1056, 1062, 1063
WEGA	1016
WHITE WESTINGHOUSE	1017, 1078
	1098, 1112, 1118
	1119
YAMAHA	1011, 1013
YOKO	1017, 1079, 1101
	1109
ZANUSSI	1073
ZENITH	1009, 1010, 1040
	1112
PIONEER	1018, 1046, 1055
	1057, 1060, 1091
	1107, 1123, 1124

## MD PLAYER



Manufacturer	Code
SONY	5401
KENWOOD	5402, 5407
SHARP	5403
ONKYO	5404
ORION	5406
DENON	5405
PIONEER	5408

## LD PLAYER



Manufacturer	Code
AKAI	5222
BBK	5224
CYRUS	5207
DENON	5202
DISCO VISION	5201
FUNAI	5217
HITACHI	5201
HONG DENG	5213
IDALL	5219
KEBAO	5215
MARANTZ	5203, 5205
MITSUBISHI	5202
NAD	5202
PANASONIC	5210
PHILIPS	5203, 5207, 5209
RADIOLA	5207
ROWA	5212
SALORA	5203
SEGA	5201
SHARP	5221
SHINCO	5211
SMC	5220
SONY	5204, 5206, 5216
	5218
SUPER	5215
TELEFUNKEN	5202
TOSHIBA	5223
PIONEER	5201, 5202, 5208
	5214

## CD PLAYER

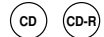

Manufacturer	Code
AIWA	5016, 5021
AKAI	5014, 5020, 5032
ANAM	5041
ARCAM	5021
AUDIOLAB	5021
AUDIOMECA	5021
AUDIO TON	5021
BESTAR	5022
BURMESTER	5045
CALIFORNIA AUDIO LABS	5004
CARVER	5021, 5025, 5046
CONDOR	5018, 5022
CURTIS MATHES	5004
CYRUS	5021
DENON	5002, 5006, 5040
	5060
DKK	5001
DUAL	5031
DYNAMIC BASS	5025
EMERSON	5038
EROICA	5053, 5054
FANTASIA	5051
FISHER	5024, 5025
GARRARD	5044, 5045
GENEXXA	5005, 5038
GOLDSTAR	5043, 5051
GRUNDIG	5021
HARMAN/KARDON	5021, 5023
HITACHI	5005
INKEL	5015, 5026, 5046
JVC	5011
KENWOOD	5003, 5008, 5029
	5056, 5057, 5062
KRELL	5021
LINN	5021
LUXMAN	5036
LXI	5038
MAGNAVOX	5021, 5038
MARANTZ	5004, 5009, 5017
	5021, 5026
MATSUI	5021
MCS	5004
MEMOREX	5022
MERIDIAN	5021
MICROMEGA	5021
MISSION	5021
MITSUBISHI	5014, 5020
MTC	5045
NAD	5001
NAIM	5021
NIKKO	5024, 5041, 5051
NSM	5021
ONKYO	5012, 5013, 5042
	5059
OPTIMUS	5001, 5005, 5008
	5019, 5025, 5038
	5045, 5046, 5048
ORION	5061
PANASONIC	5004, 5037
PARASOUND	5045
PHILIPS	5021, 5055
PMG	5022
POPPY	5022
PROTON	5021
QED	5021
QUAD	5021
QUASAR	5004,
RCA	5010, 5025, 5038

# Controlling the Rest of Your System

REALISTIC	5025, 5026, 5045
REVOX	5021
ROTEL	5021, 5045
SAE	5021
SANSUI	5021, 5033, 5038
SANYO	5025, 5039
SCHNEIDER	5018
SCOTT	5038
SEARS	5038
SHARP	5008, 5026, 5058
SHERWOOD	5015, 5026, 5031
SONY	5001, 5027, 5050
SOUDSIGN	5019
TASCAM	5045
TEAC	5024, 5026, 5044 5045
TECHNICS	5004, 5034, 5037
THORENS	5021
TOSHIBA	5049
UNIVERSUM	5021
YAMAHA	5007, 5028
YORX	5047
VICTOR	5011
WARDS	5010, 5021
PIONEER	5005, 5030, 5035 5038, 5048, 5052 5063

## TAPE DECK



Manufacturer	Code
ADC	6013
AIWA	6002, 6022, 6017 6018
AKAI	6015, 6016
ANAM	6035
ARCAM	6005
CARVER	6002, 6028
DENON	6005, 6039
DUAL	6037
DYNAMIC BASS	6028
EROICA	6041
FISHER	6028
GARRARD	6036
GOLDSTAR	6036
GRUNDIG	6002
HARMON/KARDON	6002, 6014
INKEL	6003
JVC	6027, 6030, 6031
KENWOOD	6003, 6004, 6019 6024, 6025
KYOCERA	6013
LOTTE	6034
LUXMAN	6029
MAGNAVOX	6002
MARANTZ	6002
MEMOREX	6008, 6009
mitsubishi	6016
NAKAMICHI	6020
NIKKO	6035
OLYMPUS	6029
ONKYO	6010, 6011, 6032
OPTIMUS	6001, 6021
PANASONIC	6023
PHILIPS	6002
RCA	6028
RENAISSANCE	6040
REVOX	6002

SAMSUNG	6038
SANSUI	6002
SANYO	6028
SHARP	6019
SONIC	6036
SONY	6012, 6026, 6033
TEAC	6038
TECHNICS	6023
THORENS	6002
VICTOR	6027, 6030
WARDS	6001
YAMAHA	6006, 6007, 6019
PIONEER	6001, 6008, 6009 6021,

## DVD PLAYER



Manufacturer	Code
TOSHIBA	5302
SONY	5306
PANASONIC	5301, 5322
KENWOOD	5307
JVC	5311, 5318
SAMSUNG	5313
AKAI	5316
HARMAN/KARDON	5314
MAGNAVOX	5302
mitsubishi	5303
ONKYO	5302, 5317, 5319
PROSCAN	5304
RCA	5304
SHARP	5320
THETA DIGITAL	5312
TECHNICS	5301
THOMSON	5310
YAMAHA	5301, 5309
PHILIPS	5302, 5308
ZENITH	5302, 5315
PIONEER	5305, 5312, 5321 5322

## AMPLIFIER



Manufacturer	Code
AUDIOLAB	8005
DENON	8002
GRUNDIG	8005
MARANTZ	8005
MICROMEGA	8005
PHILIPS	8005
PIONEER	8004
REVOX	8005
TANDBERG	8003
THORENS	8005
YAMAHA	8001, 8006

## MISC AUDIO



Manufacturer	Code
JERROLD	8201, 8203
STARCOM	8201
SCIENTIFIC ATLANTA	8202

## RECEIVERS



Manufacturer	Code
ADC	7042
AIWA	7012, 7023, 7031 7055, 7064 7011, 7027
AKAI	7010, 7046
ARCAM	7018, 7048
AUDIOLAB	7059
CAPETRONIC	7042
CARVER	7055, 7059
CURTIS	7008
DAEWOO	7032
DENON	7001, 7056, 7058
DUAL	7040
EROICA	7005
FANTASIA	7037
FERGUSON	7042
FINE ARTS	7059
FISHER	7028
GARRARD	7032, 7034, 7035
GOLDSTAR	7010
GOODMANS	7027
GP AUDIO	7033
GRUNDIG	7018, 7059
HARMAN/KARDON	7009, 7051
INKEL	7038, 7040
JBL	7009
JVC	7007, 7036, 7042
KENWOOD	7003, 7017, 7025 7026, 7044, 7053 7063, 7066 7037, 7039
LOTTE	7021
LUXMAN	7030, 7042, 7055 7059
MARANTZ	7004, 7018, 7055 7059
MCINTOSH	7020
MCS	7004
MCSILVER	7037
MICROMEGE	7018, 7059
NIKKO	7032, 7037, 7046
OPTIMUS	7017, 7034, 7042 7049, 7052
ONKYO	7013, 7029
PALLADIUM	7050
PANASONIC	7004, 7024, 7041
PHILIPS	7018, 7030, 7045 7048, 7051, 7055 7059
PHONOTREND	7038
QUASAR	7004
RCA	7006, 7042
RENAISSANCE	7043
REVOX	7018
ROADSTAR	7027
SABA	7042
SAISHO	7027
SAMSUNG	7010
SANSUI	7027, 7055
SANYO	7028

SCHNEIDER	7042
SHARP	7017
SHERWOOD	7038
SOUNDESIGN	7049
SONY	7015, 7054, 7057 7060
TAE KWANG	7034
TEAC	7010, 7035
TECHNICS	7004, 7062, 7065
TELEFUNKEN	7019, 7024, 7041 7061, 7062, 7065
THORENS	7018, 7059
UHER	7027, 7042, 7050
VICTOR	7007
WARDS	7002, 7006, 7008
YAMAHA	7016, 7017
PIONEER	7002, 7008, 7014 7022, 7042, 7047 7050, 7052

## VCR



Manufacturer	Code
PHILIPS	2015, 2035, 2074 2075
PANASONIC	2015, 2042, 2053 2054, 2055, 2087
THOMSON	2021, 2064, 2074
SONY	2001, 2009, 2012 2013, 2014, 2015
JVC	2008, 2021, 2033 2049, 2050, 2074 2080
GRUNDIG	2003, 2005, 2007 2010, 2034, 2035 2048, 2050, 2054 2069, 2071, 2075
AKAI	2021, 2029, 2038 2060, 2063
HITACHI	2001, 2004, 2021 2022, 2043, 2056 2057
TOSHIBA	2021, 2023, 2024 2035, 2074
MITSUBISHI	2023, 2027, 2033 2035, 2045
SHARP	2027, 2073
ORION	2002, 2004, 2016 2036, 2046, 2052 2070, 2072, 2078
SANYO	2025, 2026, 2037 2057
FERGUSON	2021, 2039, 2064 2065
BLAUPUNKT	2003, 2005, 2010 2014, 2041, 2042 2048, 2054, 2055 2075
NOKIA	2025, 2037, 2038 2057
ADMIRAL	2027, 2052
ADVENTURA	2001
AIKO	2059
AIWA	2001, 2017, 2062 2070, 2072
AKIBA	2034
ALBA	2011, 2034, 2052 2059, 2063, 2072
AMBASSADOR	2011

AMERICA ACTION	2059
AMERICAN HIGH	2015
AMSTRAD	2001, 2059, 2067 2068
ANAM	2017, 2042, 2054 2057, 2059, 2082 2084
ANAM NATIONAL	2042, 2054, 2087
ANITECH	2034
ASA	2017, 2035
ASHA	2057
ASUKA	2017
AUDIOVOX	2017
BAIRD	2001, 2021, 2037 2039
BASIC LINE	2011, 2034, 2059
BEAUMARK	2057
BELL & HOWELL	2037
BRANDT	2047, 2064, 2065
BRANDT ELECTRONIC	2021
BROKSONIC	2002, 2040, 2046 2052, 2078
BUSH	2034, 2052, 2059 2072
CALIX	2017
CANON	2015
CAPEHART	2011
CARVER	2035
CATRON	2011
CCE	2034, 2059
CGE	2001
CIMLINE	2034
CINERAL	2059
CITIZEN	2017, 2059
CLATRONIC	2011
COLT	2034
COMBITECH	2072
CONDOR	2011
CRAIG	2017, 2026, 2034 2057, 2058
CROWN	2011, 2034, 2059
CURTIS MATHES	2015, 2021, 2032 2042
CYBERNEX	2057
CYRUS	2035
DAEWOO	2011, 2024, 2025 2059, 2083
DANSAI	2034
DAYTRON	2011
DECCA	2001, 2035
DE GRAAF	2022, 2043
DENON	2022
DUAL	2021
DUMONT	2001, 2035, 2037
DYNATECH	2001
ELBE	2018
ELCATECH	2034
ELECTROHOME	2017
ELECTROPHONIC	2017
EMEREX	2012
EMERSON	2001, 2002, 2017 2023, 2040, 2046 2051, 2052, 2059 2078, 2083
ESC	2057, 2059
FIDELITY	2001
FINLANDIA	2035, 2037
FINLUX	2001, 2022, 2035 2037
FIRSTLINE	2017, 2023, 2024 2034, 2052

FISHER	2025, 2026, 2030 2037
FRONTECH	2011
FUJI	2015
FUNAI	2001
GARRARD	2001
GE	2015, 2027, 2032 2057
GEC	2035
GENERAL	2011, 2028
GOLDHAND	2034
GOLDSTAR	2017, 2018, 2053 2079
GOODMANS	2001, 2017, 2034 2059, 2075
GO VIDEO	2077, 2081
GRAETZ	2005, 2021, 2037 2057
GRANADA	2025, 2035, 2037
GRADIENTE	2001, 2008
GRANDIN	2001, 2017, 2034
HANSEATIC	2017
HARMAN/KARDON	2018, 2035
HARLEY DAVIDSON	2001
HARWOOD	2034
HCM	2034
HEADQUARTER	2025
HINARI	2004, 2034, 2057 2072
HI-Q	2026
HUGHES NETWORK SYSTEMS	2022
HYPSON	2034
IMPERIAL	2001
INGERSOL	2004
INTERFUNK	2035
ITT	2005, 2021, 2025 2037, 2038, 2057 2074
ITV	2017, 2059
JENSEN	2021
KAISUI	2034
KEC	2017, 2059
KENDO	2038, 2052
KENWOOD	2018, 2021, 2033
KLH	2034
KODAK	2015, 2017
KORPEL	2034
LAYCO	2034
LENCO	2059
LG	2079
LLOYD'S	2001, 2051
LOEWE	2004, 2005, 2017 2035
LOGIK	2004, 2034, 2057
LUXOR	2023, 2025, 2027 2037, 2038
LXI	2017
M ELECTRONIC	2001
MAGNASONIC	2059
MAGNAVOX	2001, 2015, 2019 2035
MAGNIN	2057
MANESTH	2024, 2034
MARANTZ	2003, 2005, 2015 2035
MARTA	2017
MATSUI	2004, 2016, 2036 2052, 2070, 2072
MATSUSHITA	2015, 2042, 2055
MEI	2015
MELECTRONIC	2018

# Controlling the Rest of Your System

MEMOREX	2001, 2015, 2017 2019, 2025, 2026 2027, 2037, 2052 2057, 2062, 2085 2087, 2088
MEMPHIS	2034
METZ	2003, 2005, 2017 2042, 2048, 2055 2069
MGA	2023, 2057
MGN TECHNOLOGY	2057
MINCRVA	2048
MINERVA	2005, 2010, 2048
MINOLTA	2022
MOTOROLA	2015, 2027
MTC	2001, 2057
MULTITECH	2001, 2034
MURPHY	2001
NAD	2031
NATIONAL	2054
NEC	2018, 2020, 2021 2033, 2037
NECKERMANN	2035
NESCO	2034
NIKKO	2017
NIKON	2014
NOBLEX	2057
NOKIA	2021, 2025, 2037 2038, 2057
NORDMENDE	2021, 2061, 2064 2065, 2074
OCEANIC	2001, 2021
OKANO	2063, 2070
OLYMPUS	2015, 2054
OPTIMUS	2017, 2027, 2031 2037, 2042, 2077 2086, 2087, 2088 2001, 2017, 2034
OSAKI	2035
OTTO VERSAND	2005, 2017, 2021 2034
PALLADIUM	2021
PATHE MARCONI	2016
PATHE CINEMA	2022
PENTAX	2015, 2017, 2018 2020, 2022, 2057
PENNY	2001
PERDIO	2015, 2018, 2052 2078
PHILCO	2035
PHONOLA	2017
PILOT	2011
PORTLAND	2066
PROFEX	2057
PROFITRONIC	2001
PROLINE	2001
PROSCAN	2032
PROTEC	2034
PULSAR	2019
PYE	2035
QUARTER	2025
QUARTZ	2025
QUASAR	2015, 2042, 2087
QUELLE	2035
RADIO SHACK	2001, 2085
RADIOLA	2035
RADIX	2017
RANDEX	2017
RCA	2015, 2022, 2027 2032, 2038, 2057

REALISTIC	2001, 2015, 2017, 2025, 2026, 2027, 2037
REX	2021, 2074
RFT	2075
RICOH	2014
ROADSTAR	2017, 2034, 2057 2059
RUNCO	2019
SABA	2021, 2049, 2050 2061, 2064, 2065 2074
SAISHO	2004, 2016, 2036 2052
SALORA	2023, 2025, 2038
SANKY	2019, 2027
SANSUI	2001, 2021, 2033 2052, 2058, 2078
SAMSUNG	2024, 2057, 2076 2077
SAVILLE	2072
SBR	2035
SCHAUB LORENZ	2001, 2005, 2021 2037
SCHNEIDER	2001, 2034, 2035
SCOTT	2023, 2024, 2040 2046
SEARS	2001, 2015, 2017 2022, 2025, 2026 2037
SEG	2057, 2066
SEI	2004, 2035
SELECO	2021
SEMP	2024
SENTRA	2011
SHINTOM	2034, 2037
SHOGUN	2057
SHORAI	2004
SIEMENS	2003, 2005, 2010 2017, 2030, 2035 2037, 2048
SILVA	2017
SINGER	2024, 2034
SINUDYNE	2004, 2035
SOLAVOX	2011
SONOLOR	2025
SONTEC	2017
STS	2022
SUNKAI	2070
SUNSTAR	2001
SUNTRONIC	2001
SYLVANIA	2001, 2015, 2023 2035
SYMPHONIC	2001
TASHIKO	2001
TATUNG	2001, 2021, 2035
TEAC	2001, 2021
TEC	2011
TECHNICS	2015, 2042, 2054
TEKNIKA	2001, 2015, 2007 2017, 2028
TELEAVIA	2021
TELEFUNKEN	2021, 2047, 2058 2064, 2074 2034
TENOSAL	2001, 2066
TENSAI	2001
THOMAS	2001
THORN	2016, 2021, 2037
TMK	2051, 2057
TOTEVISION	2017, 2057

TOWADA	2066
UHER	2057
UNITECH	2057
UNIVERSUM	2001, 2006, 2010 2017, 2035, 2038 2048, 2057, 2067
VECTOR	2024
VECTOR RESEARCH	2018, 2020
VICTOR	2008, 2021, 2033
VIDEO CONCEPTS	2020, 2024
VIDEOSONIC	2057
WARDS	2001, 2015, 2022 2026, 2027, 2032 2034, 2035, 2057
WHITE WESTINGHOUSE	2052, 2059
XR-1000	2001
XR-1001	2015
XR-1002	2034
YAMAHA	2018
YAMISHI	2034
YOKAN	2034
YOKO	2011, 2057
ZENITH	2001, 2014, 2019 2052, 2078
PIONEER	2031, 2033, 2035 2044, 2056

## SATELLITE TUNER



Manufacturer	Code
ABSAT	4006
AST	4027
ALBA	4029, 4034, 4037 4052
ALDES	4019
AMSTRAD	4003, 4016, 4025 4038, 4039, 4042
ANKARO	4013, 4019, 4030 4044
ANTTRON	4009, 4034
ARMSTRONG	4015
ASTRA	4005
ASTRO	4008, 4039, 4045
AVALON	4031
AXIS	4030, 4046
BT	4053
BEKO	4010
BEST	4030
BLAUPUNKT	4008
BOCA	4015, 4043
BRAIN WAVE	4022
BRITISH SKY BROADCASTING	4058
BUSH	4002
CNT	4045
CAMBRIDGE	4024
CANAL SATELLITE	4059
CANAL+	4059
CHANNEL MASTER	4029
COMLINK	4019
CONNEXIONS	4031
CROWN	4015
CYRUS	4011
D-BOX	4054
DDC	4029
DNT	4011, 4031
ECHOSTAR	4031, 4036, 4061
EMANON	4034
FTE HUMAX	4060
FERGUSON	4002, 4009, 4010 4023
FIDELITY	4016



FINLUX	4005, 4024, 4032 4037
FRACARRO	4061
FRECOM	4034
FUBE	4030, 4031, 4034
G-SAT	4009
GALAXIS	4019, 4057, 4060
GENERAL INSTRUMENT	4012
GOLD BOX	4059
GOODING	4048
GOODMANS	4010
GRUNDIG	4008, 4010, 4048
HINARI	4009
HIRSCHMANN	4008, 4032, 4039 4040, 4049
HITACHI	4037
HOUSTON	4053
HUTH	4013, 4015, 4019 4026
ITT	4005
INVIDEO	4061
INTERVISION	4050
JVC	4048
JOHANSSON	4022
KATHREIN	4004, 4006, 4008 4011, 4035, 4041
KREISELMEYER	4008
KYOSTAR	4034
LA SAT	4043, 4045
LENCO	4034
LENNOX	4050
LUPUS	4030
LUXOR	4005, 4049
MANHATTAN	4037, 4045, 4050
MARANTZ	4011
MASPRO	4004, 4023
MATSUI	4024, 4048
MEDIASAT	4059
MEDIAMARKT	4015
MINERVA	4048
MORGAN'S	4015, 4043
NAVEX	4022
NEUHAUS	4039
NEUSAT	4057
NEUHAUS	4013
NIKKO	4028
NOKIA	4005, 4032, 4037 4049, 4054, 4063
NORDMENDE	4029
ORBITECH	4039
OXFORD	4024
PACE	4002, 4009, 4014 4023, 4037, 4055 4058
PALLADIUM	4048
PALSAT	4039
PANDA	4037
PHILIPS	4007, 4011, 4020 4037, 4048, 4059
PHONOTREND	4019, 4050
PIONEER	4021, 4059
PLANET	4061
PROMAX	4037
PROSAT	4019
QUADRAL	4029, 4044
RADIOLA	4011
RADIX	4031, 4064
RFT	4011, 4013, 4019
SAT	4027, 4038
SABA	4023, 4045
SABRE	4037

SAGEM	4056
SALORA	4005
SATCOM	4026, 4051
SATEC	4009
SATMASTER	4026
SATPARTNER	4022, 4034, 4040 4045
SCHWAIGER	4009, 4041
SEEMANN	4031, 4046
SEG	4030, 4034
SIEMENS	4008
SKYMASTER	4019, 4044, 4051
SONY	4017, 4018
STRONG	4062
SUNSTAR	4043
TPS	4056
TANTEC	4023, 4037
TECHNISAT	4001, 4039
TECHNILAND	4026
TELEFUNKEN	4034
TELEKA	4015, 4052
TELESAT	4051
THOMSON	4037, 4059
TONNA	4026, 4053
TRIAD	4027
TRIASAT	4040
UNITOR	4022
UNIVERSUM	4008, 4049
VENTANA	4011
VORTEC	4034
VTECH	4027
WINERSAT	4022
WISI	4008, 4027, 4031 4037
XSAT	4006, 4065
XCOM MULTIMEDIA	4065
ZEHNDER	4033, 4045, 4047

## CABLE TV



Manufacturer	Code
ABC	3002, 3003, 3004 3006, 3008
ANDOVER	3037
BELL & HOWELL	3006
BIRGMINGHAM CABLE COMMUNICATION	3020
BRITISH TELECOM	3002, 3012
CABLETIME	3016, 3019, 3025 3029
CONTEC	3009
CLYDE	3011
CRYPTOVISION	3038
DAEHAN	3043
DAERYUNG	3003
DECSAT	3027
EVERQUESST	3007
FILMNET	3028
FRANCE TELECOM	3030
GEAC	3011
GEMINI	3007
GENERAL INSTRUMENT	3004, 3020 3031, 3046
GOLDSTAR	3014, 3047
GRUNDIG	3035
HITACHI	3004
JASCO	3007
JERROLD	3002, 3004, 3005 3006, 3007, 3020 3031, 3046
LG ALPS	3044

MEMOREX	3001
MNET	3009, 3028
NOW	3041
OAK	3009
PACIFIC	3039
PANASONIC	3001, 3013
PARAGON	3001
PULSAR	3001
PVP STEREO VISUAL MATRIX	3002
PIONEER	3010, 3014, 3018 3036
QUASAR	3001
RADIO SHACK	3007
REMBRANDT	3004
RUNCO	3001
SAMSUNG	3014, 3040
SATBOX	3024
SIGNAL	3007
SIGNATURE	3004
STS	3015
SALORA	3026
SCIENTIFIC	3003, 3032, 3049
SCIENTIFIC ATLANTA	3003, 3008 3021
SEAWOO	3045
STARCOM	3002, 3007
STARGATE	3007
STARQUEST	3007
TAIHAN	3043
TELESERVICE	3022
TELE+1	3028
TUDI	3023
TUSA	3007
TOCOM	3005
TONGKOOK	3042, 3048
TOSHIBA	3001
UNITED CABLE	3002
VIDEOWAY	3017
VISICABLE+	3033
WESTMINSTER	3012
WOLSEY GENE	3037
ZENITH	3001, 3034

## Troubleshooting

Incorrect operations are often mistaken for trouble and malfunctions. If you think that there is something wrong with this component, check the points below. Sometimes the trouble may lie in another component. Investigate the other components and electrical appliances being used. If the trouble cannot be rectified even after exercising the checks listed below, ask your nearest PIONEER authorized service center or your dealer to carry out repair work.

### The power does not turn ON.

- Connect the power plug to the wall outlet.
- Disconnect the power plug from the outlet, and insert again.
- Make sure there are no loose strands of speaker wire touching the rear panel. This could cause the receiver to shut off automatically.

### The unit does not respond when the buttons are pressed.

#### No sound is output when a function is selected.

- Make sure the component is connected correctly (refer to pages 6 to 15).
- Press **MUTING** on the remote control.
- Adjust **MASTER VOLUME**.
- Press the **MONITOR** button.
- Press **SPEAKERS** to select the speakers you connected.

#### No image is output when a function is selected.

- Make sure the component is connected correctly (refer to pages 6 to 15).
- Press the correct function button.

### Considerable noise in radio broadcasts.

- Tune in the correct frequency.
- Connect the antenna (refer to page 11).
- Route **RF** and digital cables away from the antenna terminals and wires.
- Fully extend the FM wire antenna, position for best reception, and secure to a wall.
- Connect an outdoor FM antenna (refer to page 11).
- Adjust the direction and position for best reception.
- Connect an additional internal or external AM antenna (refer to page 11).
- Turn off the equipment causing the noise or move it away from the receiver.
- Place the antenna farther away from the equipment causing the noise.

### Broadcast stations cannot be selected automatically.

- Connect an outdoor antenna (refer to page 11).

### No sound from surround or center speakers.

- Refer to "SPEAKERS setting mode" on page 17 to check the speaker settings.
- Refer to "Setting the volume level of each channel" on page 21 to check the speaker levels.
- Connect the speakers (refer to page 12,13).
- Make sure that both A and B sets of speakers are not switched on at the same time (A+B setting).

### Sound is produced from other components, but not from LD or DVD player.

- Set SIGNAL SELECT to "DIGITAL" or "ANALOG" according to the type of connections made (refer to page 29).
- Set the digital input settings correctly (refer to pages 20-21).
- Make digital connections (refer to page 6-7) and set SIGNAL SELECT to "DIGITAL" (refer to page 29).
- Refer to the instruction manual supplied with the DVD player.

### No audio is output when software with DTS is played back.

- Make sure your DVD is digitally connected to this receiver (refer to page 6-7) and set the SIGNAL SELECT to "DIGITAL".

### When a search is performed by a DTS compatible CD player during playback, noise is output.

- This is not a malfunction, but be sure to turn the volume down to prevent the output of loud noise from your speakers.

### Cannot be remote controlled.

- Replace the batteries (refer to page 4).
- Operate within 23 feet ( 7 m), 30° of the remote sensor on the front panel (refer to page 4).
- Remove the obstacle or operate from another position.
- Avoid exposing the remote sensor on the front panel to direct light.

### The display is dark or off.

- Press **FL DIMMER** on the remote control repeatedly to return to the default.

If the unit does not operate normally due to external effects such as static electricity. Disconnect the power plug from the outlet and insert again to return to normal operating conditions.

## Specifications

### Amplifier Section

**Continuous average power output of 100 watts (VSX-D850S is 110 watts)\* per channel, min., at 8 ohms, from 20 Hz to 20,000 Hz with no more than 0.2 %\*\* total harmonic distortion (front).**

Continuous Power Output (VSX-D710S/D810S)  
 Front ..... 100 W per channel (1kHz, 1.0 %, 8 Ω)  
 Center ..... 100 W (1kHz, 1.0 %, 8 Ω)  
 Surround ..... 100 W per channel (1kHz, 1.0 %, 8 Ω)  
 Surround Back ..... 100 W (1kHz, 1.0 %, 8 Ω)\*\*

Continuous Power Output (VSX-D850S)  
 Front ..... 110 W per channel (1kHz, 1.0 %, 8 Ω)  
 Center ..... 110 W (1kHz, 1.0 %, 8 Ω)  
 Surround ..... 110 W per channel (1kHz, 1.0 %, 8 Ω)  
 Surround Back ..... 110 W (1kHz, 1.0 %, 8 Ω)

Input (Sensitivity/Impedance)  
 CD, AUX, VCR/DVR, CD-R/TAPE/MD, DVD/LD,  
 TV/SAT, VIDEO  
 ..... 200 mV/47 kΩ

Frequency Response  
 CD, AUX, VCR/DVR, CD-R/TAPE/MD, DVD/LD,  
 TV/SAT, VIDEO  
 ..... 5 Hz to 100,000 Hz <sup>+0</sup>/<sub>-3</sub> dB

Output (Level/Impedance)  
 VCR/DVR REC, CD-R/TAPE/MD REC  
 ..... 200 mV/2.2 kΩ

Tone Control  
 BASS ..... ± 6 dB (100 Hz)  
 TREBLE ..... ± 6 dB (10 kHz)  
 LOUDNESS ..... +9 dB (100 Hz/10 kHz)

Signal-to-Noise Ratio (IHF, short circuited, A network)  
 CD, AUX, VCR/DVR, CD-R/TAPE/MD, DVD/LD,  
 TV/SAT, VIDEO  
 ..... 96 dB

Signal-to Noise Ratio [EIA, at 1 W (1 kHz)]  
 CD, AUX, VCR/DVR, CD-R/TAPE/MD, DVD/LD,  
 TV/SAT, VIDEO  
 ..... 79 dB

### Video Section

Input (Sensitivity/Impedance)  
 VCR/DVR, DVD/LD, TV/SAT, VIDEO  
 ..... 1 Vp-p/75 Ω

Output (Level/Impedance)  
 VCR/DVR ..... 1 Vp-p/75 Ω

Frequency Response  
 VCR/DVR, DVD/LD, TV/SAT, VIDEO → MONITOR  
 ..... 5 Hz to 7 MHz <sup>+0</sup>/<sub>-3</sub> dB

Signal-to-Noise Ratio ..... 55 dB  
 Cross Talk ..... 55 dB

### FM Tuner Section

Frequency Range ..... 87.5 MHz to 108 MHz  
 Usable Sensitivity  
 ..... Mono:13.2 dBf, IHF (1.3 μV/ 75 Ω)  
 50 dB Quieting Sensitivity ..... Mono: 20.2 dB  
 Stereo: 38.6 dBf  
 Signal-to-Noise Ratio ..... Mono: 73 dB (at 85 dBf)  
 Stereo: 70 dB (at 85 dBf)  
 Distortion ..... Stereo: 0.5 % (1 kHz)  
 Alternate Channel Selectivity ..... 60 dB (400 kHz)  
 Stereo Separation ..... 40 dB (1 kHz)  
 Frequency Response ..... 30 Hz to 15 kHz (±1) dB  
 Antenna Input (DIN) ..... 75 Ω unbalanced

### AM Tuner Section

Frequency Range ..... 530 kHz to 1,700 kHz  
 Sensitivity (IHF, Loop antenna) ..... 350 μV/m  
 Selectivity ..... 25 dB  
 Signal-to-Noise Ratio ..... 50 dB  
 Antenna ..... Loop antenna

### Miscellaneous

Power Requirements ..... AC 120 V, 60 Hz  
 Power Consumption  
 VSX-D710S ..... 250 W  
 350 VA  
 VSX-D810S ..... 290 W  
 420 VA  
 VSX-D850S ..... 290 W  
 420 VA  
 In Standby ..... 1 W  
 AC Outlet ..... 100 W MAX. (SWITCHED)  
 Dimensions ..... 420 (W) x 158 (H) x 401 (D) mm  
 (16-9/16 (W) x 6-4/16 (H) x 15-13/16 (D) in.)  
 Weight (without package)  
 VSX-D710S ..... 8.8 kg (19 lb 7 oz)  
 VSX-D810S ..... 10.5 kg (23 lb 3 oz)  
 VSX-D850S ..... 10.5 kg (23 lb 3 oz)

### Furnished Parts

FM wire Antenna ..... 1  
 AM loop Antenna ..... 1  
 Dry Cell Batteries  
 VSX-D710S/D810S : AA Size / IEC R6P ..... 2  
 VSX-D850S : AA Size / IEC LR6 ..... 2  
 Remote Control Unit ..... 1  
 Operating Instructions ..... 1

### NOTE:

- Specifications and the design are subject to possible modifications without notice, due to improvements.
- \* Measured pursuant to the Federal Trade Commission's Trade Regulation rule on Power Output Claims for Amplifiers.
- \*\* Measured by Audio Spectrum Analyzer.
- \*\*\* VSX-D810S only.



## We Want You Listening For A Lifetime

*Dear Customer:*

Selecting fine audio equipment such as the unit you've just purchased is only the start of your musical enjoyment. Now it's time to consider how you can maximize the fun and excitement your equipment offers. This manufacturer and the Electronic Industries Association's Consumer Electronics Group want you to get the most out of your equipment by playing it at a safe level. One that lets the sound come through loud and clear without annoying blaring or distortion-and, most importantly, without affecting your sensitive hearing.

Sound can be deceiving. Over time your hearing "comfort level" adapts to higher volumes of sound. So what sounds "normal" can actually be loud and harmful to your hearing. Guard against this by setting your equipment at a safe level BEFORE your hearing adapts.

**To establish a safe level:**

- Start your volume control at a low setting.
- Slowly increase the sound until you can hear it comfortably and clearly, and without distortion.

**Once you have established a comfortable sound level:**

- Set the dial and leave it there.

Taking a minute to do this now will help to prevent hearing damage or loss in the future. After all, we want you listening for a lifetime.

Used wisely, your new sound equipment will provide a lifetime of fun and enjoyment. Since hearing damage from loud noise is often undetectable until it is too late, this manufacturer and the Electronic Industries Association's Consumer Electronics Group recommend you avoid prolonged exposure to excessive noise. This list of sound levels is included for your protection.

**Decibel**

<u>Level</u>	<u>Example</u>
30	Quiet library, soft whispers
40	Living room, refrigerator, bedroom away from traffic
50	Light traffic, normal conversation, quiet office
60	Air conditioner at 20 feet, sewing machine
70	Vacuum cleaner, hair dryer, noisy restaurant
80	Average city traffic, garbage disposals, alarm clock at two feet.

**THE FOLLOWING NOISES CAN BE DANGEROUS UNDER CONSTANT EXPOSURE**

90	Subway, motorcycle, truck traffic, lawn mower
100	Garbage truck, chain saw, pneumatic drill
120	Rock band concert in front of speakers, thunderclap
140	Gunshot blast, jet plane
180	Rocket launching pad

Information courtesy of the Deafness Research Foundation.



Should this product require service in the U.S.A. and you wish to locate the nearest Pioneer Authorized Independent Service Company, or if you wish to purchase replacement parts, operating instructions, service manuals, or accessories, please call the number shown below.

8 0 0 - 4 2 1 - 1 4 0 4

Please do not ship your product to Pioneer without first calling the Customer Service Department at the above listed number for assistance.

Pioneer Electronics Service, Inc.  
Customer Service Department  
P.O. BOX 1760, Long Beach,  
CA 90801-1760, U.S.A.

For warranty information please see the Limited Warranty sheet included with your product.

Should this product require service in Canada, please contact a Pioneer Canadian Authorized Dealer to locate the nearest Pioneer Authorized Service Company in Canada. Alternatively, please contact the Customer Service Department at the following address:

Pioneer Electronics of Canada, Inc.  
Customer Service Department  
300 Allstate Parkway, Markham, Ontario L3R OP2  
(905)479-4411  
1(877)283-5901

For warranty information please see the Limited Warranty sheet included with your product.

Si ce produit doit être réparé au Canada, veuillez vous adresser à un distributeur autorisé Pioneer du Canada pour obtenir le nom du Centre de Service Autorisé Pioneer le plus près de chez-vous. Vous pouvez aussi contacter le Service à la clientèle de Pioneer:

Pioneer Électroniques du Canada, Inc.  
Service à la clientèle  
300, Allstate Parkway, Markham, Ontario L3R OP2  
(905)479-4411  
1(877)283-5901

Pour obtenir des renseignements sur la garantie, veuillez vous reporter au feuillet sur la garantie restreinte qui accompagne le produit.

S018A2L

Published by Pioneer Corporation.  
Copyright © 2000 Pioneer Corporation.  
All rights reserved.

**PIONEER CORPORATION** 4-1, Meguro 1-Chome, Meguro-ku, Tokyo 153-8654, Japan

**PIONEER ELECTRONICS [USA] INC.** P.O. BOX 1540, Long Beach, California 90801-1540, U.S.A.

**PIONEER ELECTRONICS OF CANADA, INC.** 300 Allstate Parkway, Markham, Ontario L3R OP2, Canada

**PIONEER EUROPE NV** Haven 1087, Keetberglaan 1, B-9120 Melsele, Belgium TEL: 03/570.05.11

**PIONEER ELECTRONICS AUSTRALIA PTY. LTD.** 178-184 Boundary Road, Braeside, Victoria 3195, Australia, TEL: [03] 9586-6300

**PIONEER ELECTRONICS DE MEXICO S.A. DE C.V.** San Lorenzo 1009 3er Piso Desp. 302 Col. Del Valle Mexico D.F. C.P. 03100  
TEL: 5-688-52-90

## Free Manuals Download Website

<http://myh66.com>

<http://usermanuals.us>

<http://www.somanuals.com>

<http://www.4manuals.cc>

<http://www.manual-lib.com>

<http://www.404manual.com>

<http://www.luxmanual.com>

<http://aubethermostatmanual.com>

Golf course search by state

<http://golfingnear.com>

Email search by domain

<http://emailbydomain.com>

Auto manuals search

<http://auto.somanuals.com>

TV manuals search

<http://tv.somanuals.com>