



**Pioneer** *sound.vision.soul*

**Digital High Definition Tuner**

**SH-DT510**

Operating instructions

# Safety First

<p><b>IMPORTANT</b></p>  <p>The lightning flash with arrowhead symbol, within an equilateral triangle, is intended to alert the user to the presence of uninsulated "dangerous voltage" within the product's enclosure that may be of sufficient magnitude to constitute a risk of electric shock to persons.</p>	<p><b>CAUTION</b></p> <p><b>RISK OF ELECTRIC SHOCK DO NOT OPEN</b></p> <p><b>CAUTION:</b> TO PREVENT THE RISK OF ELECTRIC SHOCK, DO NOT REMOVE COVER (OR BACK). NO USER-SERVICEABLE PARTS INSIDE. REFER SERVICING TO QUALIFIED SERVICE PERSONNEL.</p>	 <p>The exclamation point within an equilateral triangle is intended to alert the user to the presence of important operating and maintenance (servicing) instructions in the literature accompanying the appliance.</p>
--	---	---

D3-4-2-1-1\_En-A

Thank you for buying this Pioneer product. Please read through these operating instructions so you will know how to operate your model properly. After you have finished reading the instructions, put them away in a safe place for future reference.

## WARNING

**This equipment is not waterproof. To prevent a fire or shock hazard, do not place any container filled with liquid near this equipment (such as a vase or flower pot) or expose it to dripping, splashing, rain or moisture.**

D3-4-2-1-3\_A\_En

## WARNING

*Before plugging in for the first time, read the following section carefully.*

**The voltage of the available power supply differs according to country or region. Be sure that the power supply voltage of the area where this unit will be used meets the required voltage (e.g., 230V or 120V) written on the rear panel.**

D3-4-2-1-4\_A\_En

## WARNING

**To prevent a fire hazard, do not place any naked flame sources (such as a lighted candle) on the equipment.**

D3-4-2-1-7a\_A\_En

## VENTILATION CAUTION

**When installing this unit, make sure to leave space around the unit for ventilation to improve heat radiation (at least 8 cm at top, 5 cm at rear, and 5 cm at each side).**

## WARNING

Slots and openings in the cabinet are provided for ventilation to ensure reliable operation of the product, and to protect it from overheating. To prevent fire hazard, the openings should never be blocked or covered with items (such as newspapers, table-cloths, curtains) or by operating the equipment on thick carpet or a bed.

D3-4-2-1-7b\_A\_En

## Operating Environment

Operating environment temperature and humidity:  
+5 °C – +40 °C (+41F – +104F); less than 85 %RH  
(cooling vents not blocked)

Do not install this unit in a poorly ventilated area, or in locations exposed to high humidity or direct sunlight (or strong artificial light)

D3-4-2-1-7c\_A\_En

### CAUTION

The STANDBY/ON switch on this unit will not completely shut off all power from the AC outlet. Since the power cord serves as the main disconnect device for the unit, you will need to unplug it from the AC outlet to shut down all power. Therefore, make sure the unit has been installed so that the power cord can be easily unplugged from the AC outlet in case of an accident. To avoid fire hazard, the power cord should also be unplugged from the AC outlet when left unused for a long period of time (for example, when on vacation).

D3-4-2-2a\_A\_En

### STANDBY/ON Button

**STANDBY: When set to the STANDBY position, the main power flow is cut and the unit is no longer fully operational. A minute flow of power feeds the unit to maintain operation readiness.**

### STANDBY Indicator

The red indicator is lit when the unit is in the standby mode.

### WARNING

**This product equipped with a three-wire grounding (earthed) plug - a plug that has a third (grounding) pin. This plug only fits a grounding-type power outlet. If you are unable to insert the plug into an outlet, contact a licensed electrician to replace the outlet with a properly grounded one. Do not defeat the safety purpose of the grounding plug.**

D3-4-2-1-6\_A\_En

# TABLE OF CONTENTS

<b>Safety First .....</b>	<b>2</b>
<b>Chapter 1: Introduction .....</b>	<b>6</b>
Summary of Features .....	6
Getting Started .....	7
Menu Tree .....	8
<b>Chapter 2: Installation .....</b>	<b>9</b>
<b>Introduction .....</b>	<b>9</b>
<b>Package Contents .....</b>	<b>9</b>
<b>Description of Equipment .....</b>	<b>9</b>
<b>Remote Control Unit (RCU) .....</b>	<b>9</b>
Functions Of RCU Buttons .....	10
<b>Front Panel .....</b>	<b>11</b>
<b>Rear Panel .....</b>	<b>11</b>
<b>Physical Installation .....</b>	<b>12</b>
<b>Sample Configurations .....</b>	<b>13</b>
HDMI Connection .....	13
High Definition TV(Y/Pb/Pr) Connection .....	13
S-Video Connection .....	14
Composite Video Connection .....	14
Antenna Loop Connection .....	15
Digital Audio Connection .....	15
<b>Chapter 3: Channel Setting .....</b>	<b>16</b>
<b>Introduction .....</b>	<b>16</b>
<b>INSTALLATION .....</b>	<b>17</b>
<b>QUICK SCAN .....</b>	<b>17</b>
<b>AUTO SCAN .....</b>	<b>18</b>
<b>MANUAL SCAN .....</b>	<b>19</b>
<b>CLEAR ALL DATA .....</b>	<b>19</b>

<b>General Setting .....</b>	<b>20</b>
<b>TIME SETUP .....</b>	<b>20</b>
<b>AUDIO SETUP .....</b>	<b>20</b>
<b>i - PLATE SETUP .....</b>	<b>21</b>
<b>SOFTWARE .....</b>	<b>22</b>
CURRENT VERSION .....	22
INSTALL NEW S/W .....	22
<b>Chapter 4: Using the Tuner .....</b>	<b>23</b>
<b>Introduction .....</b>	<b>23</b>
<b>Switching the Tuner On and Off .....</b>	<b>23</b>
<b>Using the Menus and Remote Control Unit (RCU).....</b>	<b>23</b>
Selecting Favorite Channels .....	24
Favorite Channel List .....	24
PARENTAL GUIDANCE .....	25
CHANGE PASSWORD .....	25
i-PLATE (INFORMATION PLATE) .....	26
TELETEXT / Closed Caption .....	27
SLEEP .....	28
<b>Appendix A: Interference with The HDTV Tuner .....</b>	<b>29</b>
<b>Appendix B: Troubleshooting .....</b>	<b>30</b>
<b>Appendix C: DTV CHANNEL TABLE .....</b>	<b>32</b>
<b>Appendix D: Specifications .....</b>	<b>34</b>
<b>Glossary .....</b>	<b>36</b>

# Chapter 1: Introduction

## Digital High Definition Tuner's Functions

The SH-DT510 digital High Definition tuner opens up a new world of free-to-air terrestrial programming. This tuner can receive channels from VHF/UHF band TV station's digital signals. All the major terrestrial free-to-air digital station numbers currently available in your area are listed in the on-screen menu. To access the high quality digital programs, simply select the channel number on your remote control.

The SH-DT510 tuner is MPEG 2 / DVB-T (digital video broadcast-terrestrial) compliant, delivering crisp video images and excellent sound. It supports a broad signal range from 51-858 MHz, and can be easily programmed for all the channels within the VHF/UHF frequency spectrum.

## Summary of Features

The SH-DT510 supports digital functions that are MPEG 2-DVB compliant. Just follow the friendly On-Screen Display (OSD) to guide you through all the steps necessary to configure your tuner ; then begin enjoying all the video and audio channels with crisp picture quality and the crystal clear sound.

**The key features of the receiver are described below:**

### Front Panel

The Front Panel of the tuner includes an LED display with important channel information. For more information on the Front Panel refer to Chapter 2

### Remote Control Unit ( RCU )

The Remote Control Unit (RCU) provides access to a full range of the system features. In addition to providing access to terrestrial programs with the channel and volume controls, it can also be used to access all the system menus.

In particular, the RCU has to be used to configure the transmission parameter settings, select the channels you want to include in the program list, as well as access many other configuration options. For more information on using the RCU, refer to Chapter 2 and to the various system operations described in Chapter 3.

### **System Menus**

All the tuner's features can be accessed through the system menus. These menus can be accessed with simple point and click actions, using the navigation and select buttons on the RCU. The menus include items such as Transmission Parameter Configuration, Channel List, Audio Options, and Parental Lock. For more information on using the menu system, refer to the simple "Menu Tree" described later in this chapter, or refer to the more detailed menu descriptions in Chapters 3 and 4.

### **Parental Lock**

Channels which are not suitable for viewing by children can be protected by using the parental lock feature. (Password is initially set to "0000".)

## **Getting Started**

This section provides a brief introduction to the SH-DT510 tuner. If a service provider or professional system installer has already installed your digital High Definition tuner and antenna, then this section should provide all the information you need to start using the tuner. For more information on basic operations, refer to Chapter 3.



Before connecting any devices to the tuner, refer to the "Safety First" page.

# Menu Tree

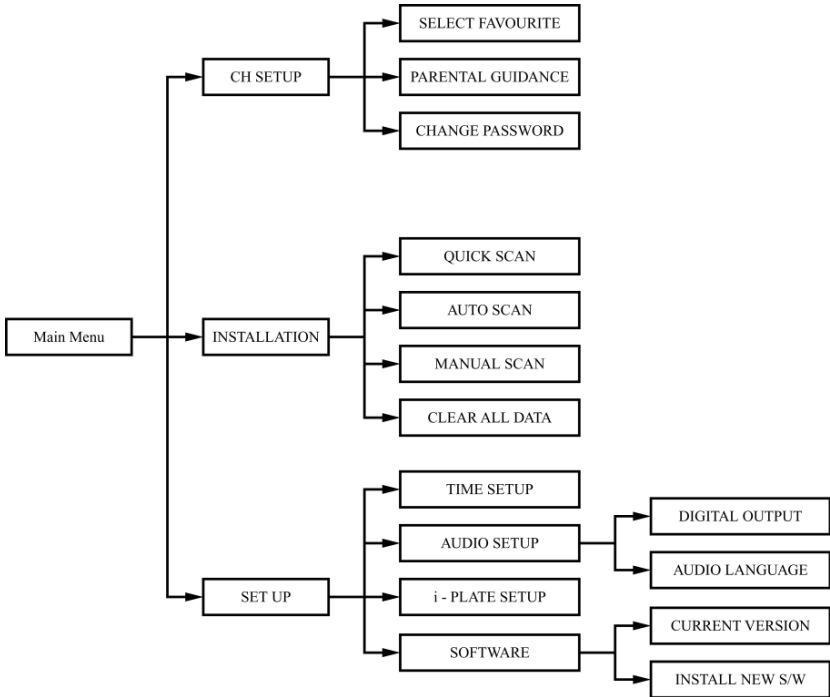

**Note:**

You need to enter a " Password " to access some of the functionality in the menu. Password is initially set to "0000". For more information, please refer Chapter 4 "CHANGE PASSWORD".



## Chapter 2: Installation

### Introduction

If your service provider or system installer has already set up the antenna and connected the tuner, then you can start the operations specified in Chapter 4. However, if you are setting up the system by yourself, please read through this section and be sure you follow all of the precautions listed under "Safety First".

### Package Contents

Unpack the tuner and check that all of the items listed below are included.

- SH-DT510 Digital High Definition tuner
- Remote Control Unit (with 2 AAA batteries)
- Audio Cable
- Video Cable
- Y/Pb/Pr cable
- Power Cable
- Operating instructions

### Description of Equipment

The SH-DT510 digital High Definition tuner is designed to receive Free-To-Air digital programming from VHF/UHF terrestrial TV channels. Please see the following description:

#### Remote Control Unit (RCU)

The RCU provides easy access to all of the tuner's functions, including selecting channels and using the menus. It uses infrared signals and must be operated at a distance of three to four meters from the receiver. When using the RCU, be sure that there is a direct line of sight to the tuner.

The batteries for the RCU are packaged separately. Before you start using the tuner, please install these batteries with +/- terminals aligned as per the picture below.

**Note:**

- To avoid damaging the RCU through battery leakage, discard any depleted or old batteries.
- When disposing of used batteries, please comply with governmental regulations or environmental public instruction's rules that apply in your country/area.

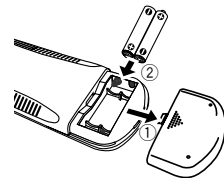

## Functions Of RCU Buttons

The buttons on the remote control are described as follows:

- **STANDBY/ON:** Switches the tuner between ON and STANDBY modes.
- **Numeric Buttons:** For entering channel number or password.
- **INFO:** Displays i-Plate providing information about the current channel.
- **MENU:** Activates the On-Screen Menu.
- **FAV.:** Selects the Favorite channel list.
- **Direction buttons:** Move through menus or submenus.
- **ENTER:** Displays channel list or enters highlighted menu feature.
- **CH+/CH-:** Selects viewing channel one up or down in program list.
- **VOL+/VOL-:** Raises or lowers audio volume.
- **A.RATIO:** Adjusts the picture height/width ratio between 16:9 and 4:3.
  - 16:9(Wide Screen Display) : to display 16:9 program on 16:9 TV screen to display 4:3 program on 4:3 TV screen.
  - 4:3(16:9 Letterbox): to display 16:9 program on 4:3 TV screen in letterbox.
  - 4:3(16:9 Crop) : to display 16:9 program cropped on 4:3 TV screen.
- **V.FORMAT:** Toggle between "PAL (625i)", "1080i-50(1125i)", "720P-50(750P)", and "576P-50(625P)" video format through Y/Pb/Pr video format connector to optimise resolution.
 

Note:

  - PAL, 625i and 720x576i are identical,
  - 1080i-50, 1125i and 1920x1080i are identical,
  - 720P-50, 750P and 1280x720p are identical,
  - 576P-50, 625P and 720x576p are identical.
- **MUTE:** Audio mute toggle.
- **TTX:** For Teletext Emulation and DVB Subtitle.
- **RETURN:** Exits main menu or one level up from submenus, and exits from the EPG and information screens.
- **LIST:** Displays the complete channel /program list.
- **AUDIO:** Show the multiple table to move ↑/↓ buttons for selecting language
- **Colour buttons:** 4 colour buttons are prepared to be used for TELETEXT operations. Use for fast access a group or block of Teletext pages.
- **SLEEP:** Sets the sleep timer.

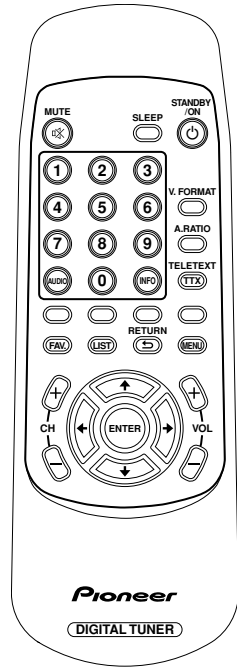

## Front Panel

The buttons and indicators on the Front Panel of your SH-DT510 are described in the following picture and table:

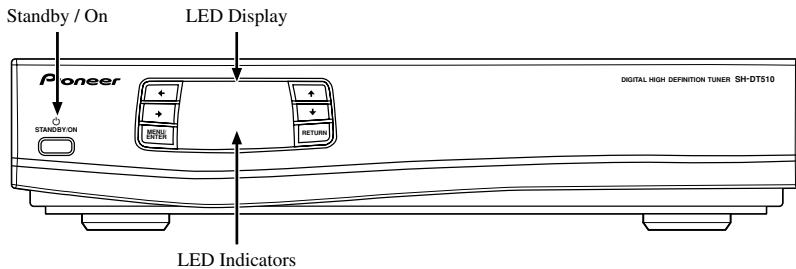

## Rear Panel

The rear panel carries connectors for attaching VHF/UHF antenna and other home entertainment equipment. To ensure highest quality video output, it is recommended to use (in order of preference) HDMI, Component Video, S-Video, Composite Video.

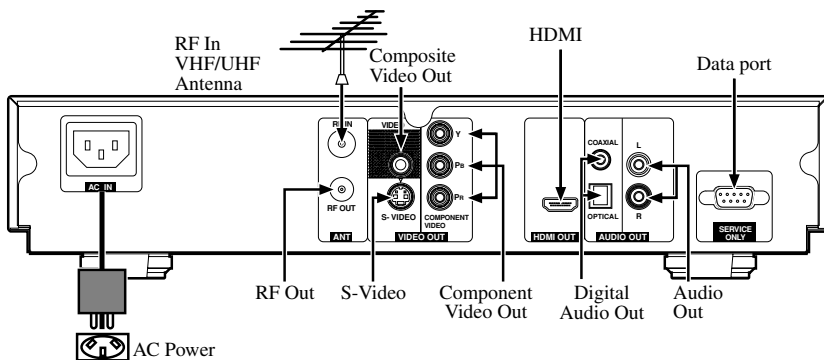

<b>Terminals</b>	<b>Description</b>
S-Video Out	Connects to the S-Video input on your TV or VCR.
Data Port	For service use only.
RF In	Connects the VHF/UHF antenna. This connector accepts input signals ranging from 51 to 858 MHz.
Composite Video Out	Connects to the video input on your TV, VCR or DVR.
Audio Out (L, R)	Connects to the audio input on your TV, VCR, DVR or stereo system.
RF Out	Connects to TV or VCR RF input (for video and mono audio signals).
AC IN	Connecting to mains supply and plug the receiver into the main, the power source from 240 Vac, 50 Hz
Digital Audio Out (Optical and Coaxial)	Connects to the digital (Optical and Coaxial) audio input on a home theatre surround system.
Component Out (Y/Pb/Pr)	Connects to the component (Y/Pb/Pr) video input on your TV set.
HDMI Out	Connects to the HDMI input on your TV.

## **Physical Installation**

There are many ways to connect the Digital High Definition tuner to your TV, depending on the equipment and connection types you have. However, for the best video/audio quality, use the best quality HDMI Terminal if available. Always disconnect the tuner from the power source prior to connecting or disconnecting.

# Sample Configurations

## HDMI Connection

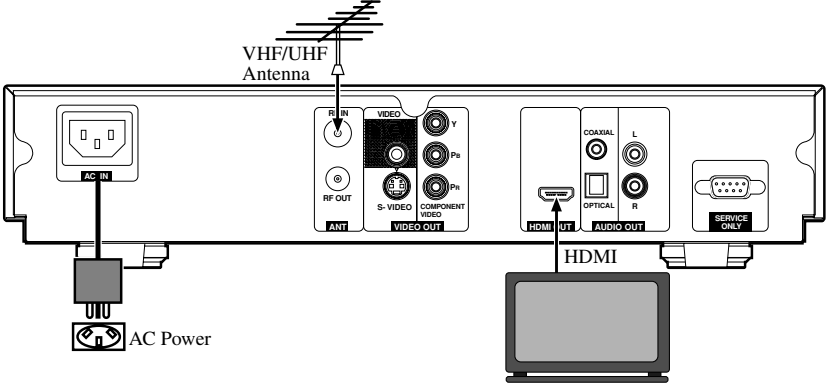

## High Definition TV(Y/Pb/Pr) Connection

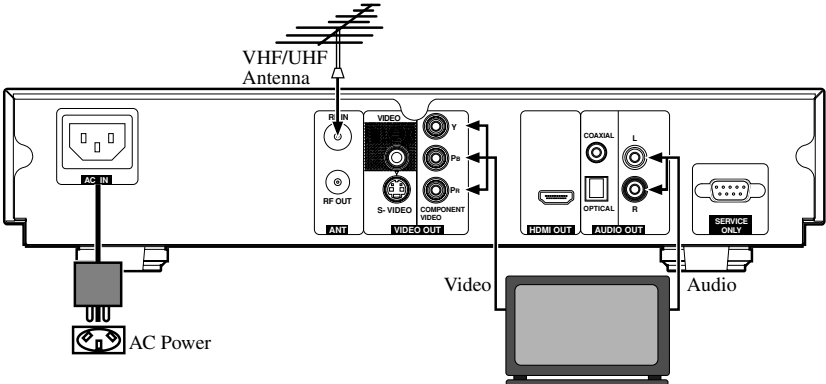

## S-Video Connection

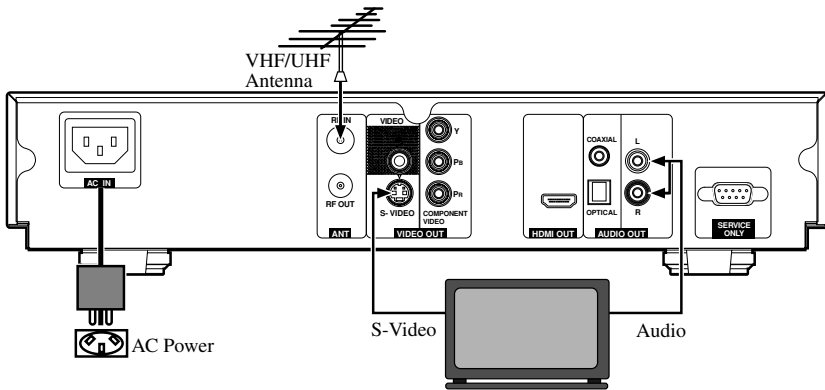

### Note:

Connecting video through S-Video, OSD can not work under 1080i / 720p and 576p modes. Please connect your TV to Y/Pb/Pr or HDMI output for OSD properly displaying under 1080i / 720p & 576p modes.

## Composite Video Connection

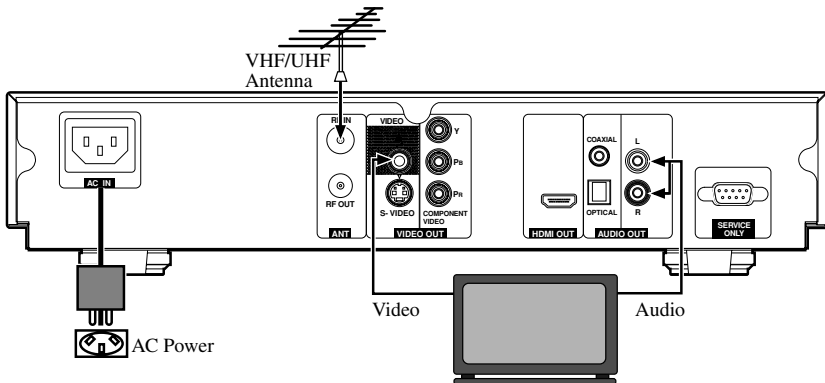

## Antenna Loop Connection Using RF Output to connect with VCR or Secondary TV

The RF OUT only support signal loop-thru but not the re-modulation for the received program.

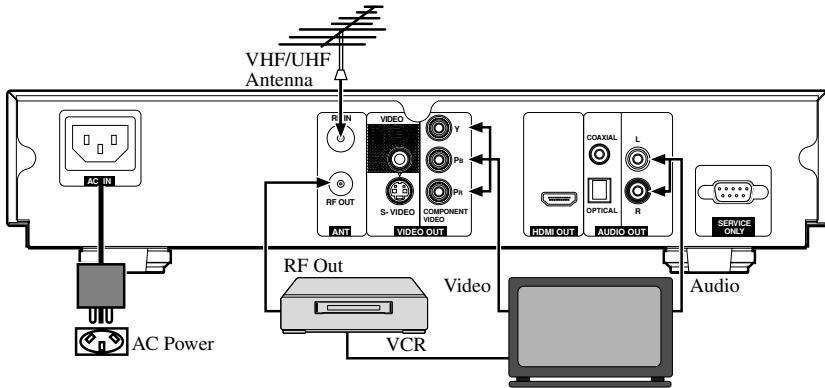

## Digital Audio Connection

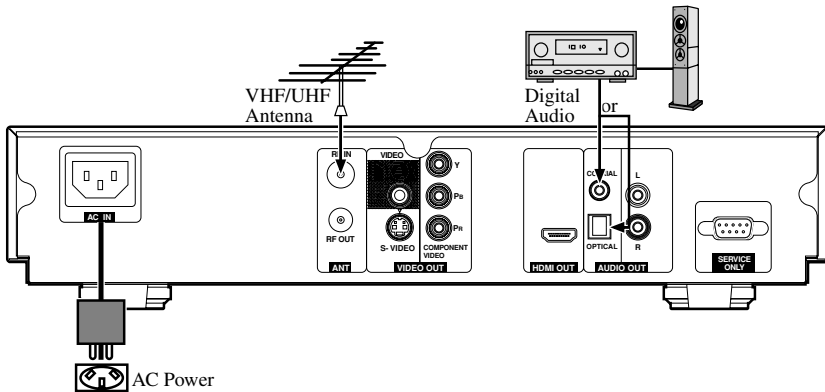

# Chapter 3: Channel Setting

## Introduction

After finishing the hardware installation as described in Chapter 2, switch on the tuner.

It will display Data base is Empty and instruct you to press the "MENU" button on the remote control.

The following menu will be displayed after pressing the "MENU" button.

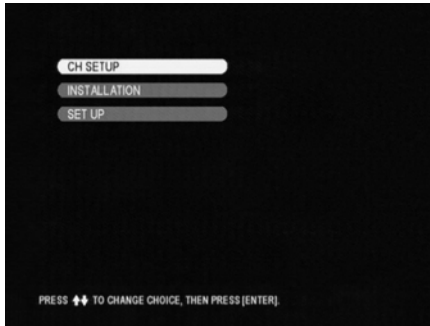

- Initial Screen

Menu	Description
CH SETUP	Set up favorite channels in the Favorite list, set up, control and activate Parental Guidance and Password
INSTALLATION	Search channels using one of three scan modes.
SET UP	General setup for the tuner, update the tuner's software version

**Note:**

Use the "MENU" button on the RCU to display the Main Menu, the arrow buttons to move through the menus, the "ENTER" button to choose specific items, and "RETURN" button to return to the previous menu.



## INSTALLATION



- **INSTALLATION MENU** gives 4 different sub-menu.

QUICK SCAN  
AUTO SCAN  
MANUAL SCAN  
CLEAR ALL DATA

## QUICK SCAN

If you live in one of the cities or regions listed in the QUICK SCAN menu, select your city or region and start scanning all digital TV channel signals .

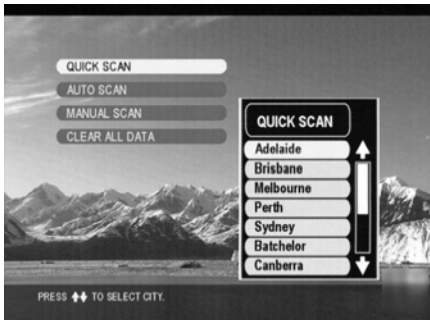

- On the user installation page, select **QUICK SCAN**.
- Scroll up or down the list to find the city or region that you live in and press "ENTER" button to start scanning.
- The tuner will scan through the channels available in your area.  
**Note :**

The frequencies of these channels are preset in the tuner's database. If the channel frequency is changed by the local TV station or a new channel commences broadcasting, you will have to find these channels using **MANUAL SCAN**.

## AUTO SCAN

Auto Scan searches for digital programs on all channels, 5 to 69, through the VHF and UHF bands.

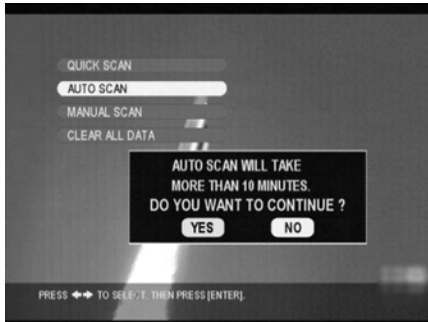

- Select **AUTO SCAN** and press "ENTER" button.
- Select **YES** then press "ENTER" button to start channel search.
- The tuner starts scanning from channel 5 to channel 69. The percentage bar shows the progress made.
- Once the digital TV signal is scanned, the channel number and program name will be shown on the Program List above the percentage bar.
- Scanning will finish on channel 69, after that, you can press the "RETURN" button to leave this window and start watching DTV programs.

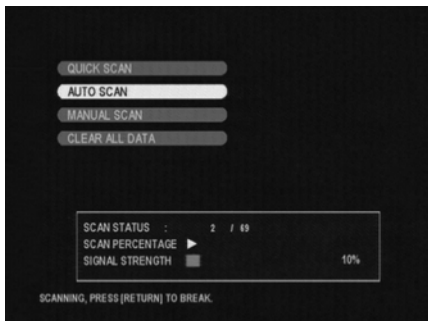

## MANUAL SCAN

Manual Scan search the channel based on user request frequency and bandwidth.

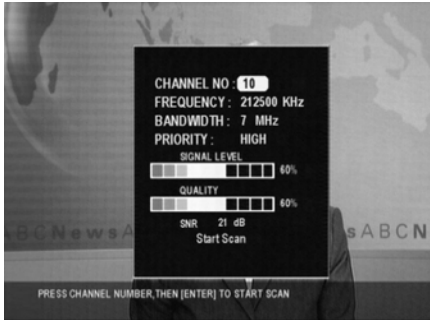

- On the Installation page, select **MANUAL SCAN** and press **"ENTER"** button.
- Select channel number. Be sure you know the channel number and its RF frequency.
- Check **FREQUENCY**, **BANDWIDTH** and **PRIORITY** to ensure that these parameters are correct, then highlight **Start Scan** and press **"ENTER"** button to start the scan.
- When the tuner locks onto a channel, the words **"Start Scan"** will change to **"Get Channel Success"** (Ideally it should be **"Get Channel Success"** but if difficult to change OSD, leave as it is). You can press **RETURN** twice to leave the Installation page and watch the program immediately or continue scanning for other channels. If you want to know the signal level and SNR (Signal to Noise ratio) while watching a digital TV channel, navigate to this page.
- If the signal is not locked, **"Start Scan"** will show **"Timeout error"**. You can try to scan the signal again, or refer to the Signal Level bar and Quality band to align the antenna to improve your signal reception. Contact an antenna installer if you cannot lock onto the signal after trying all of the suggestions in this manual.

## CLEAR ALL DATA

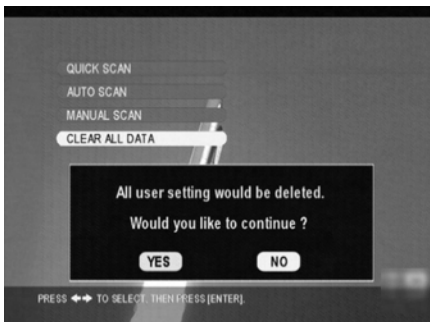

- This option allows you to reset the tuner to its factory settings, losing all channels and setup changes you have made. Select **CLEAR ALL DATA** to reset the tuner.

### WARNING:

Do not choose this option if you do not understand the functioning of the tuner. No viewing channels will remain afterwards. Setup procedures and scanning will have to be performed again after taking this step.

## General Setting



- Selecting **SET UP** will display this sub-menu.

TIME SETUP  
AUDIO SETUP  
i - PLATE SETUP  
SOFTWARE

## TIME SETUP



- **TIME SETUP** sets the time in "**TIME ZONE**". Use the "**←**" and "**→**" buttons to select the local time zone you are located in and press the "**ENTER**" button.

**Note :**

A correct time zone setting can help box to display the correct time in the i-PLATE. All other time related information like service duration for NOW and NEXT extended information would show the time information according to the time zone you selected.

## AUDIO SETUP



- Selecting this option allows you to select the appropriate **DIGITAL OUTPUT** for your Audio equipment. Also you can change the language by selecting **AUDIO LANGUAGE**.

**Note :**

The audio language you select will only work when the broadcasting signal carries that language sound track.

## i - PLATE SETUP



- On selecting this option from the above menu, you can change the i-PLATE display time and format.

## SOFTWARE

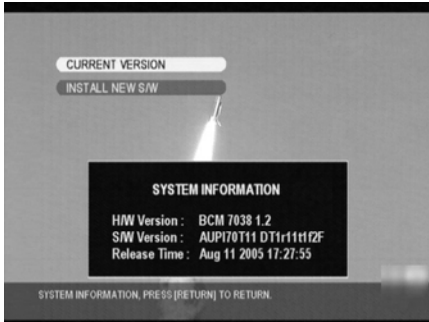

- When you select the **SOFTWARE** menu, there are two sub-menus displayed:

CURRENT VERSION  
INSTALL NEW S/W

### CURRENT VERSION

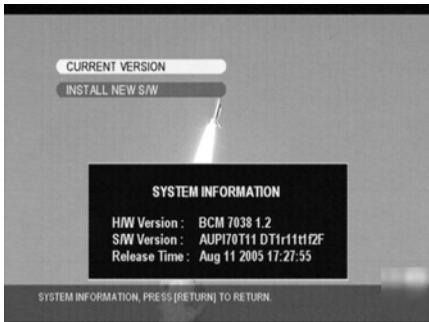

- Under the **CURRENT VERSION** sub-menu, the ID number of installed hardware and software versions of the tuner are displayed.

### INSTALL NEW S/W

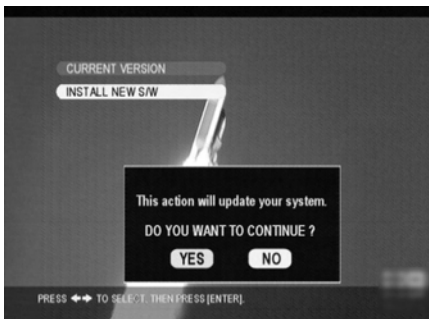

- Service use only

## Chapter 4: Using the Tuner

### Introduction

Once the channels are downloaded, you can start enjoying the full range of video and audio programs. Operating the tuner is extremely easy. You can control the show tuner directly from the Front Panel or with the RCU as described below. The tuner's menu provides access to a listing of all the channels configured on your tuner and parental controls that allow you to access or restrict sensitive programming, as well as the various audio options.

### Switching the Tuner On and Off

You can use the Standby/On button on the RCU to alternate the tuner between ON and Standby modes.

### Using the Menus and Remote Control Unit (RCU)

Just by pressing the buttons on the RCU, you can operate most common functions, such as selecting the programs, displaying Information and adjusting the volume. But to access some of the more complicated functions (such as Digital TV channel setting, program listing and system settings) or to configure the tuner, you will need to use the on-screen menus. Most functions can be accessed either via the buttons on the Front Panel of the tuner or with the RCU. However, for items that require numeric inputs, the RCU must be used. There are two ways to access the various menu items:

1. Press the "MENU" button, highlight the required item with the navigation button (↑/↓/←/→), press "ENTER" button and continue moving through the menus until you find the item you desire.
2. Select LIST, FAV. from RCU to directly access the service.

To close the menu or navigate back in the menu hierarchy, press the "RETURN" button.

## Selecting Favorite Channels

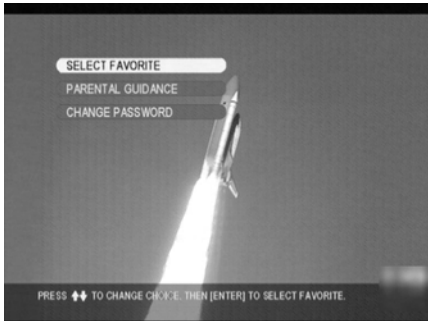

- Under the "CH SETUP" sub-menu, you can select "SELECT FAVORITE" to set up favorite channels.
- Use "↑" and "↓" buttons to select the channel, use "←" and "→" buttons to select "FAV.1" or "FAV.2"
- When you highlight "FAV.", the direction icon will show.
- After you have made all the selections, press "ENTER" button to register them.

## Favorite Channel List

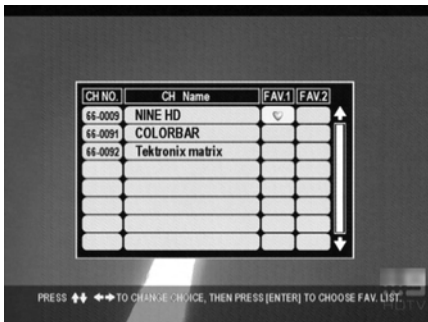

- When you are watching Broadcasting, you can press the "FAV." button on the remote control to call up the Favorite List.
- Use "↑" and "↓" buttons to browse through the program lists and highlight the channel you want to watch, then press "ENTER" button.



## PARENTAL GUIDANCE

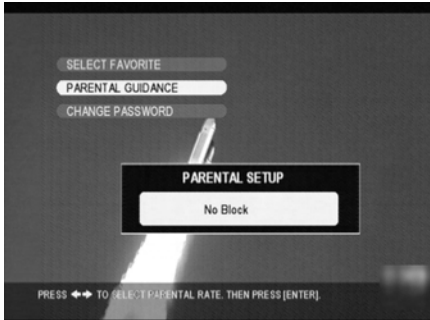

- Under CHSETUP sub-menu, you can select PARENTAL GUIDANCE to block programs.
- Use "←" and "→" buttons to select the Rating, press "ENTER" button to confirm the setting.
- When DTV programs broadcasted are accompanied by the ratings, the programs will be blocked based on your setting, then you have to enter PASSWORD to resume watching the program. Pass word is set to "0000" at factory initial setting.

## CHANGE PASSWORD

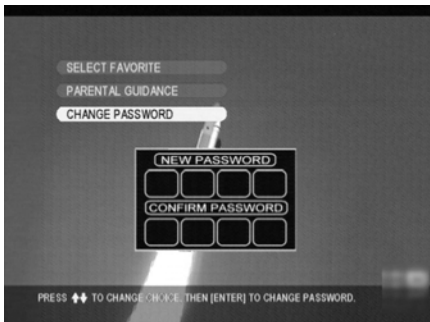

- You can change the password by selecting the CHANGE PASSWORD. Entering desired Password, and re-type it again to confirm.
- Password is set to "0000" at factory initial setting.

## i-PLATE (INFORMATION PLATE)

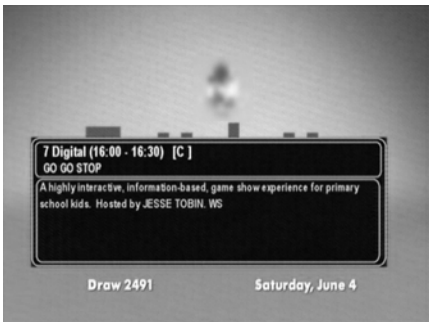

- While watching DTV you can press the "INFO" button to activate extended program information.
- The i-PLATE will pop up with the following information,
  - Current Channel Number
  - Network Name
  - Program Name
  - Audio Output (PCM or Dolby Digital)
  - Digital / Analog TV signal
  - Teletext
  - Current Local Time
  - Date and Month
- While the i-PLATE is still on the screen, you can press "INFO" button again to call up the extended program information of the current TV channel (NOW) .
- Press the "INFO" button again and you can call up the extended program information of the next program (NEXT).
- To leave, you simply press "RETURN" button.

## TELETEXT / Closed Caption

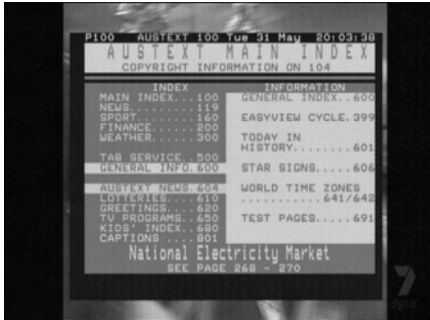

- When the i-PLATE indicated that Teletext / Closed Caption data is available on the current channel, you can press the " TTX " button on the remote control to display it on the TV screen.
- 4 Colour buttons are assigned for TTX. You can select a group or block of pages displayed in the coloured brackets at the bottom of the screen by pressing the corresponding colour. (RED/GREEN/YELLOW/BLUE)

## SLEEP

When the selected time elapses, the Sleep Timer automatically places the system into the standby mode.

Press "SLEEP" button to select the desired time.



- The timer starts counting.
- To cancel the Sleep Timer, select "OFF" by pressing "SLEEP" button.
- Each time you press "SLEEP" button the selection is switched as below:

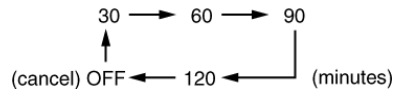

- The factory default is "OFF".

# Appendix A: Interference with The HDTV Tuner

## Weather Induced Signal Fading

Natural calamities may affect signal reception. If the terrestrial TV programming is often affected by inclement weather conditions, there are a few basic steps you can take to improve reception:

1. Make sure your antenna is aimed to receive the strongest possible signal.
2. If this does not solve the problem, consider installing a larger antenna with higher gain. This can help to gather more signal transmitted from the TV station.
3. If you live in an area subject to frequent snow or freezing rain, you may need to install a deicing system to eliminate the accumulation of unwanted ice, snow or moisture from the surface of your antenna.
4. If the program reception is not good affected by heavy winds, you can stabilize the antenna mast with cables.

## Home Appliances' Interference

When you turn on home appliances like air conditioner and washing machine while you are using the tuner, in a very rare case It is possible that the power surge caused by turning on these home appliances may interfere tuner's performance.

In such case we suggest that you use a different AC power source (different AC outlet) between SH-DT510 and other home appliances (devices which can generate AC surge), or use a surge protector, available from computer, hardware or electrical stores.

## Appendix B: Troubleshooting

If you encounter any problems with the tuner, look through this section for a description of your problem. Try solving the problem by following the given solutions. However, if after attempting all the recommended actions you still cannot solve the problem, please contact PIONEER SERVICE AND PARTS CENTER.

If the unit does not operate normally due to external effects, disconnect the power plug from the outlet for 1 minute and insert again to return to normal operating conditions.

Problem	Solution
(1) The tuner front panel power indicator doesn't light up, and no message on the front panel.	(a) Check the main lead and make sure the power plug is well plugged into a stable power outlet.
(2) Has message on the front panel but no picture on your TV screen.	(a) Press "MENU" button on the remote control or front panel to call up On Screen Display. (b) Make sure the connector type between set top box and your TV set matches each other. For instance, if you use RCA or Y/Pb/Pr connector you may choose the same external video input RCA or Y/Pb/ on the TV set. (c) Check the brightness level of your TV screen is high enough.
(3) Poor picture quality.	(a) Check the antenna and make sure it is aligned to the correct direction. Use tuner's "MANUAL SETUP" page to check the Signal Level and when aligning the antenna. (b) If you use any kind of amplifier to boost the signal level, check whether it works well, and consult your antenna installer. Some amplifiers are not good to digital reception. (c) Refer to solutions in item (2) above.
(4) No audio service.	(a) Check the tuner and your TV's volume are properly set and not in "MUTE" mode. (b) Make sure the audio connectors are correctly and firmly connected. (c) Make sure the appropriate DIGITAL OUTPUT (PCM or Dolby Digital) is selected. (d) Scan this channel again by using "MANUAL SETUP" and see if the audio service will come back. (e) Check with the local TV stations. Sometimes they are just testing new services on their TV or Radio channels.

Problem	Solution
(5) No video service.	(a) Scan this channel again by using "MANUAL SETUP" and see if the video service will come back. (b) Check with the local TV stations. Sometimes they are just testing new video services on their channels and the video service may stop every once in a while.
(6) Does not have all the channels available after activating "AUTO SCAN" when first time installing the receiver.	(a) Try "MANUAL SCAN" to scan these missing channels. This is caused by unexpected frequency offset. For instance, in Sunshine Coast Australia, channel 47 and 65 are transmitted on 662.625 and 788.625 MHz, 125KHz offset to the legitimate frequencies 662.5 and 788.5 MHz. Likewise channel 9A in Tasmania. SH-DT510 can receive them by Auto Scan most times, but we suggest you use Manual Scan when first time installing the tuner. Once the signal is picked up by the receiver, all the transmission parameters will be stored in your receiver's memory so that the next time you can scan these channels using Auto Scan without any problem.
(7) Does not have all the channels available after using "QUICK SCAN".	(a) Try "AUTO SCAN" to scan all the channels in VHF & UHF bands. (b) If you still cannot get some channels please use "MANUAL SCAN" to scan them one by one.
(8) Cannot lock signal by using "MANUAL SCAN".	(a) Check and make sure the frequency you entered is exactly the center frequency of the wanted channel.
(9) No Teletext.	(a) Make sure the channel you are watching carries teletext information. (b) Press "TTX" button on the remote control to double check there's teletext data output.
(10) Cannot receive channels after moving the tuner between cities. (for instance from Melbourne to Sydney)	(a) Enter into OSD menu and clean all channel memory. (b) Re-scan the channel using AUTO SCAN, QUICK SCAN or MANUAL SCAN.

1: Contact your service provider or system installer.

## Appendix C: DTV CHANNEL TABLE

The following is a list of DTV channels available in Australia. First, into "MANUAL SETUP" Second, select the VHF channel number, then use a middle frequency to start search. (For instance, if you are in Sydney and want to scan Digital 7, First, into MANUAL SETUP select Channel 6 and make sure the Frequency is 177500 kHz, then start scanning)

City	Identifier	Channel & Middle Frequency	Transmitter Location	Start Date
Adelaide	Digital 7	VHF 6 - 177.5MHz	Main Transmitter - Mt Lofty	1/1/2001
	Digital 9	VHF 8 - 191.625MHz	Main Transmitter - Mt Lofty	1/1/2001
	Digital 10	VHF 11 - 219.5MHz	Main Transmitter - Mt Lofty	1/1/2001
	Digital ABC	VHF 12 - 226.5MHz	Main Transmitter _ Mt Lofty	1/1/2001
	Digital SBS	UHF 33 - 564.5MHz	Main Transmitter - Mt Lofty	1/1/2001
Brisbane	Digital 7	VHF 6 - 177.5MHz	Main Transmitter - Mt Coot-tha	1/1/2001
	Digital 9	VHF 8 - 191.625MHz	Main Transmitter - Mt Coot-tha	1/1/2001
	Digital 10	VHF 11 - 219.5MHz	Main Transmitter - Mt Coot-tha	1/1/2001
	Digital ABC	VHF 12 - 226.5MHz	Main Transmitter - Mt Coot-tha	1/1/2001
	Digital SBS	UHF 36 - 585.5MHz	Main Transmitter - Mt Coot-tha	1/1/2001
Melbourne	Digital 7	VHF 6 - 177.5MHz	Main Transmitter - Mt Dandenong	1/1/2001
	Digital 9	VHF 8 - 191.625MHz	Main Transmitter - Mt Dandenong	1/1/2001
	Digital 10	VHF 11 - 219.5MHz	Main Transmitter - Mt Dandenong	1/1/2001
	Digital ABC	VHF 12 - 226.5MHz	Main Transmitter - Mt Dandenong	1/1/2001
	Digital SBS	UHF 29 - 536.625MHz	Main Transmitter - Mt Dandenong	1/1/2001
Perth	Digital 7	VHF 6 - 177.5MHz	Main Transmitter _ Carmel	1/1/2001
	Digital 9	VHF 8 - 191.625MHz	Main Transmitter _ Carmel	1/1/2001
	Digital 10	VHF 11 - 219.5MHz	Main Transmitter _ Carmel	1/1/2001
	Digital ABC	VHF 12 - 226.5MHz	Main Transmitter _ Carmel	1/1/2001
	Digital SBS	UHF 29 - 536.625MHz	Main Transmitter _ Bickley	1/1/2001
Sydney	Digital 7	VHF 6 - 177.5MHz	Main Transmitter Artarmon	1/1/2001
	Digital 9	VHF 8 - 191.625MHz	Main Transmitter Artarmon	1/1/2001
	Digital 10	VHF 11 - 219.5MHz	Main Transmitter Artarmon	1/1/2001
	Digital ABC	VHF 12 - 226.5MHz	Main Transmitter Artarmon	1/1/2001
	Digital SBS	UHF 34 - 571.5MHz	Main Transmitter Gore Hill	1/1/2001
Batchelor	QQQ -51	UHF 50 - 683.5MHz		
	SBS -54	UHF 53 - 704.5MHz	Mardango Cres	2005
	ABD -69	UHF 56 - 725.5MHz	Mardango Cres	
	NTD -60	UHF 59 - 746.5MHz	Mardango Cres	
	TND -63	UHF 62 - 767.5MHz	Mardango Cres	
	IMP -66	UHF 65 - 788.5MHz		



City	Identifier	Channel & Middle Frequency	Transmitter Location	Start Date
Canberra	CTC -7	VHF 6 - 177.5MHz	Telstra Tower Black Mountain	30/6/2002
	ABC -9	VHF 9A - 205.5MHz	Telstra Tower Black Mountain	30/6/2002
	WIN -31	VHF 11 - 219.5MHz	Telstra Tower Black Mountain	30/6/2002
	CBN -34	VHF 12 -226.5MHz	Telstra Tower Black Mountain	30/6/2002
	SBS -28	UHF 30 -543.5MHz	Telstra Tower Black Mountain	30/6/2002
Darwin	SBS -28	UHF 29 - 536.625MHz	Deloraine Rd	30/6/2002
	ABD -6	UHF 30 - 543.5MHz	Deloraine Rd	30/6/2002
	NTD -8	UHF 31 - 550.5MHz	Deloraine Rd	30/6/2002
	TND -34	UHF 32 -557.5MHz	Deloraine Rd	30/6/2002
Newcastle	NBN -3	UHF 36 - 585.5MHz	Mt Sugarloaf	30/6/2001
	NEN -54	UHF 53 - 704.5MHz	Mt Sugarloaf	30/6/2001
	NRN -57	UHF 51 - 690.5MHz	Mt Sugarloaf	30/6/2001
	ABHN -5A/ 4B	UHF 37 - 592.5MHz	Mt Sugarloaf	30/6/2001
		UHF 38 - 599.5MHz	Mt Sugarloaf	30/6/2001
Wollongong	SBS -45	UHF 36 - 585.5MHz	WIN Tower Knights Hill	
	WIN -59	UHF 37 - 592.5MHz	NTL Tower Knights Hill	
	CTC -62	UHF 38 - 599.5MHz	WIN Tower Knights Hill	30/6/2002
	CBN -65	UHF 51 - 690.5MHz	NTL Tower Knights Hill	30/6/2002
	ABWN -56	UHF 54 - 711.625MHz	NTL Tower Knights Hill	30/6/2002
Hobart	SBS -53	VHF 7 - 184.5MHz	Mt Wellington	
	WIM-7	VHF 8 - 191.625MHz	Mt Wellington	
	ABC-8	VHF 9A - 205.5MHz	Mt Wellington	
	SBS-9A	VHF 10 - 212.5MHz	Mt Wellington	
Hobart NE	Southern	VHF 11 - 219.5MHz	Mt Wellington	
	Cross -10	UHF 56 - 725.5MHz	Government Hills	
	Digital 10	UHF 62 - 767.5 MHz	Government Hills	
	ABC -56	UHF 64 - 781.5 MHz	Government Hills	
	Southern	UHF 65 - 788.5 MHz	Government Hills	
	Cross -62	UHF 66 - 795.5 MHz	Government Hills	
	SBS -64 WIN -65 Digital 10			

**Note:**

- (a) The Channel Number Display of tuner's front panel is the logical channel number. It is different from VHF/UHF channel number shown in the column "CHANNEL & FREQUENCY" of this table.
- (b) If you have trouble getting DTV channel's signal, please contact your local antenna installer for help.
- (c) For updated channel table please contact your local dealer.

# Appendix D: Specifications

## Standards Compliance

Compliant Standard DVB-T, MPEG-2

## RF Input/Output

Frequency Australian Allocation ; VHF(104.5 ~ 226.5MHz)  
UHF(526.5 ~ 816.5MHz)

Loop Through 51-858MHz

Bandwidth 7 MHz

Connector Input ; IEC Female  
Output ; IEC Male

Demodulator COFDM

FFT Mode 2K , 8K

Constellation QPSK , 16QAM , 64 QAM

Guard Interval 1/4, 1/8, 1/16, 1/32

Inner Coding Rate 1/2, 2/3, 3/4, 5/6, 7/8

## Video

Formats MPEG-2 MP@ML and MP@HL

Aspect Ratio 4:3 , 16:9

Picture Resolution "PAL (625i)", "1080i-50(1125i)",  
"720P-50(750P)", "576P-50(625P)"

Output Connector

- HDMI[High-Definition Multimedia Interface]
- Composite RCA jack(Y)
- Component (Y/Pb/Pr) RCA jacks(G,B,R)
- S-Video Mini Din

## Audio

Formats MPEG-1 layer I and layer II  
PCM & Dolby Digital

Output Connector

- Analog RCA jacks(R,W)
- SPDIF(Optical) Square connector
- SPDIF(Coaxial) RCA jacks(O)

## Data

Serial Data Port RS-232C(Service Only)

## OSD

Number of Colour > 256

## Application System Resources

CPU 300 MIPS

RAM Memory 64 MB SDRAM

Flash Memory 2 MB

**Front Panel**

Function Control  
Channel Display

7 Buttons  
4 Digits / 7-segment display

**Remote Control**

Buttons

35 Buttons  
including Standby, CH+, CH-....etc

**Power Supply**

Input Voltage  
Power Consumption

240V ~ 50 Hz  
18W (3W standby)

**Dimension**

Size  
Weight

(W × D × H) 360 × 268 × 80 mm  
3.0 Kg

**Environmental Data**

Operating Temperature

5 °C ~ 40 °C

**EMC / Safety Standard**

AS/NZS CISPR 13:2003  
AS/NZS 60065: 2003

\*Specifications are subject to change without notice

# Glossary

- \* **Aspect Ratio** : It is the ratio of the width of the screen to the height. The two relevant digital TV formats are 16:9 (widescreen) or 4:3 (the traditional screen ratio). 16:9 is more ergonomically suitable for the human eye.
- \* **Bandwidth** : Frequency range allows for carrying a certain radio signal. The speed of data transmission depends on the available bandwidth of the transmission channel.
- \* **Coaxial Cable** : A type of cable used to transmit high frequency signals e.g. from the VHF/UHF antenna to the terrestrial Digital TV receiver.
- \* **Composite Video** : There are three elements of the video system : First - the "active video" which means the picture to be displayed on the screen and its associated colours. Second - the "sync" decides where to place each pixel on the screen. Third - the "blanking" tells the display when to turn off the electron beam so no retrace across the screen. These three elements combined together is called "composite video" when connecting to a display through connectors.
- \* **DVB** : Abbreviation for "Digital Video Broadcasting". An international organization created in October 1993, whose primary objective is to achieve a common framework for all technical platforms of digital broadcasting systems including DVB-C (cable), DVB-S (satellite), DVB-T (terrestrial), DVB-MC (MMDS), DVB-CS (SMATV).
- \* **EPG** : Abbreviation for "Electronic Program Guide". Software that enable viewers to navigate through the large number of channels offered by digital TV broadcaster and select the desired services.
- \* **Frequency** : The property of a signal which is measured in cycles per second(=Hertz).
- \* **HDCP** : HDCP is a specification developed by Intel Corporation to protect digital entertainment content access the HDMI interface.
- \* **HDMI** : Abbreviation for High-Definition Multimedia Interface to provide crystal-clear digital quality over a signal cable.
- \* **Letterbox** : The picture with aspect ratio 16:9 in a 4:3 TV screen with blank lines on top and bottom. It is the means to watch a wide screen TV program on a 4:3 TV screen.

- \* **Megahertz (MHz)** : Millions of cycles per second, which describes frequencies of radio wave or electric current.
- \* **OSD**: Abbreviation of "On Screen Display", used in digital set top box. OSD is comprised of a main menu and many submenu with lots of options of functions inside.
- \* **PAL** : Stands for "Phase Alternating Line", the European video standard which has the image format of 4 by 3,625 horizontal lines, 50 Hz and a total 8 MHz of video channel width.
- \* **PID** : Stands for "Packet Identifier". It is a code used for identifying video, audio PCR and other elements that form a particular service in the transport stream.
- \* **RF Channel** : Radiated Frequency Channel, for instance channel 28 for SBS Network in analog TV transmission. However in digital TV, one RF channel may carry 4 to 6 subchannels like SBS HD, SBS Digital.
- \* **S-Video (also called Y/C)** : The standard for the way a video signal is carried on the cable. Y represents brightness and C represents colour. S-Video cables have separate wires for the colour and brightness so it offers a better picture quality than the composite video.
- \* **VHF** : Stands for "Very High Frequency", starts from 30 to 300 MHz corresponding to channels 5-12, including Bands I, II and III.
- \* **UHF** : Stands for "Ultra High Frequency", starts from 300 to 3000 MHz corresponding to channels 28-69, including Bands IV and V.
- \* **Y/Pb/Pr** : Component Video Output. It is better than S-Video and Composite Video output in terms of picture quality. Y/Pb/Pr is the standard HDTV connector.

AFTER-SALES SERVICE FOR PIONEER PRODUCTS

PIONEER ELECTRONICS AUSTRALIA PTY. LTD  
PIONEER SERVICE AND PARTS CENTER  
2211 PRINCES HIGHWAY MULGRAVE, VICTORIA 3170  
PHONE:1800-988-268

Published by Pioneer Corporation.  
Copyright © 2005 Pioneer Corporation.  
All rights reserved.

---

**PIONEER CORPORATION**

4-1, Meguro 1-Chome, Meguro-ku, Tokyo 153-8654, Japan

**PIONEER ELECTRONICS (USA) INC.**

P.O. BOX 1540, Long Beach, California 90810-1540, U.S.A. TEL: (800) 421-1404

**PIONEER ELECTRONICS OF CANADA, INC.**

300 Allstate Parkway, Markham, Ontario L3R OP2, Canada TEL: 1-877-283-5901

**PIONEER EUROPE NV**

Haven 1087, Keetberglaan 1, B-9120 Melsele, Belgium TEL: 03/570.05.11

**PIONEER ELECTRONICS ASIACENTRE PTE. LTD.**

253 Alexandra Road, #04-01, Singapore 159936 TEL: 65-6472-7555

**PIONEER ELECTRONICS AUSTRALIA PTY. LTD.**

178-184 Boundary Road, Braeside, Victoria 3195, Australia, TEL: (03) 9586-6300

**PIONEER ELECTRONICS DE MEXICO S.A. DE C.V.**

Bldv.Manuel Avila Camacho 138 10 piso Col.Lomas de Chapultepec, Mexico,D.F. 11000 TEL: 55-9178-4270

K002\_A\_En

## Free Manuals Download Website

<http://myh66.com>

<http://usermanuals.us>

<http://www.somanuals.com>

<http://www.4manuals.cc>

<http://www.manual-lib.com>

<http://www.404manual.com>

<http://www.luxmanual.com>

<http://aubethermostatmanual.com>

Golf course search by state

<http://golfingnear.com>

Email search by domain

<http://emailbydomain.com>

Auto manuals search

<http://auto.somanuals.com>

TV manuals search

<http://tv.somanuals.com>