

HDD & DVD Player / Recorder
DVDR3570H / DVDR3590H

User Manual

This product comes with
Premium Home Service
Refer to the inside page for details.

Thank you for choosing Philips.

Need help fast?

Read your Quick Start Guide and/or User Manual first for quick tips that make using your Philips product more enjoyable.

**Register your product and get support
at www.philips.com/welcome**



PHILIPS

Premium Home Service

United Kingdom, Ireland

Dear valued customer,

Thank you for buying a Philips DVD Recorder.
Your product comes with the Philips 'Premium Home Service' warranty.

Should you require any assistance in operating your set, Philips offers you professional support via:

Philips Support Center website

www.philips.com/support

or

Philips Consumer Care Helpline *

where our trained representatives will guide you, step-by-step, to solve any issues you have.

If we are unable to provide a solution, Philips will be pleased to pick-up your DVD Recorder from your home; and provide a service replacement set, within 7 days. That's the Philips 'Premium Home Service' commitment to you. This service comes free-of-charge (except for Consumer Care Helpline) and applies to all Philips DVD Recorders during the Philips warranty period.

For more information, please contact a representative via the Philips Consumer Care Helpline.

* Refer to the back page of this manual for the Philips Customer Care phone number in your country.
Please have with you the model number, serial number and purchase date of your product when contacting Philips Customer Care.

Important notes for users in U.K.

Mains plug

This apparatus is fitted with an approved 13 Amp plug. To change a fuse in this type of plug proceed as follows:

- 1 Remove fuse cover and fuse.
- 2 Fix new fuse which should be a BSI 362 5 Amp, A.S.T.A. or BSI approved type.
- 3 Refit the fuse cover.

If the fitted plug is not suitable for your socket outlets, it should be cut off and an appropriate plug fitted in its place.

If the mains plug contains a fuse, this should have a value of 5 Amp. If a plug without a fuse is used, the fuse at the distribution board should not be greater than 5 Amp.

Note: The severed plug must be disposed off to avoid a possible shock hazard should it be inserted into a 13 Amp socket elsewhere.

How to connect a plug

The wires in the mains lead are coloured with the following code: blue = neutral (N), brown = live (L).

- As these colours may not correspond with the colour markings identifying the terminals in your plug, proceed as follows:
 - Connect the blue wire to the terminal marked N or coloured black.
 - Connect the brown wire to the terminal marked L or coloured red.
 - Do not connect either wire to the earth terminal in the plug, marked E (or e) or coloured green (or green and yellow).

Before replacing the plug cover, make certain that the cord grip is clamped over the sheath of the lead - not simply over the two wires.

Copyright in the U.K.

Recording and playback of material may require consent. See Copyright Act 1956 and The Performer's Protection Acts 1958 to 1972.

VIDEO Plus+

VIDEO Plus+® is a registered trademark of Gemstar Development Corporation. The VIDEO Plus+® system is manufactured under license from Gemstar Development Corporation.



Manufactured under license from Dolby Laboratories. "Dolby", "Pro-Logic" and the double-D symbol are trademarks of Dolby Laboratories.



DivX Ultra Certified products: "DivX, DivX Ultra Certified, and associated logos are trademarks of DivX, Inc. and are used under license.

CAUTION

VISIBLE AND INVISIBLE LASER RADIATION WHEN OPEN. AVOID EXPOSURE TO BEAM

Due to the inconsistency of disc formats provided by various disc manufacturers, your DVD system/ player/recorder may require a playability enhancement or upgrade. As DVD technology advances, these enhancement will become common and will be easy to complete. Go to www.philips.com/support for software upgrade.

'CONSUMERS SHOULD NOTE THAT NOT ALL HIGH DEFINITION TELEVISION SETS ARE FULLY COMPATIBLE WITH THIS PRODUCT AND MAY CAUSE ARTIFACTS TO BE DISPLAYED IN THE PICTURE. IN CASE OF 525 OR 625 PROGRESSIVE SCAN PICTURE PROBLEMS, IT IS RECOMMENDED THAT THE USER SWITCH THE CONNECTION TO THE 'STANDARD DEFINITION' OUTPUT. IF THERE ARE QUESTIONS REGARDING OUR TV SET COMPATIBILITY WITH THIS MODEL 525p AND 625p DVD PLAYER, PLEASE CONTACT OUR CUSTOMER SERVICE CENTER.'

This product incorporates copyright protection technology that is protected by US patents. Use of this copyright protection technology must be authorised by Macrovision, and is intended for home and other limited viewing uses only unless otherwise authorised by Macrovision. Reverse engineering or disassembly is prohibited.

U.S. Patent Number 4,631,603; 4,819,098; 4,907,093; 5,315,448; and 6,516,132

This product complies with the radio interference requirements of the European Community.

CE This product complies with the requirements of the following directives and guidelines: 2006/95/EC + 2004/108/EC

Disposal of your old product



Your product is designed and manufactured with high quality materials and components, which can be recycled and reused. When this crossed-out wheeled bin symbol is attached to a product it means the product is covered by the European Directive 2002/96/EC. Please inform yourself about the local separate collection system for electrical and electronic products.

Please act according to your local rules and do not dispose of your old products with your normal household waste. The correct disposal of your old product will help prevent potential negative consequences for the environment and human health.

LASER

Type	Semiconductor laser InGaAlP (DVD) AlGaAs (CD)
Wave length	658 nm (DVD) 90 nm (CD)
Output Power	30 mW (DVD+RW write) 1.0 mW (DVD read) 1.0 mW (CD read)
Beam divergence	84 degrees (DVD) 61 degrees (CD)

For Customer Use:

Read carefully the information located at the bottom or rear of your DVD Recorder and enter below the Serial No. Retain this information for future reference.

Model No. DVD/HDD RECORDER
DVDR3570H, DVDR3590H

Serial No. _____

CAUTION!

This unit does not contain any user-serviceable parts. Please leave all maintenance work to qualified personnel.

Table of Contents

General

Care and Safety Information	8
Setup precautions.....	8
Cleaning discs	8
Hard Disk Drive (HDD) handling care.....	8
Energy saving message	8
Product Information	9
Introduction.....	9
Accessories supplied	9
Region codes.....	9
Special features	10~11

Product Overview

Remote Control	12~14
Using the remote control	14
Main Unit	15

Connections & Setup

Step 1: Basic Recorder Connections	16~19
Connecting the antenna cables	16
Connecting the video cable.....	17~18
Connecting the audio cables	19
Step 2: Optional Connections	20~23
Connecting to a Cable Box or Satellite Receiver	20
Connecting to a VCR or other similar device.....	21
Connecting to a VCR and Cable Box/Satellite Receiver.....	22
Connecting to a camcorder	23
Step 3: Installation and Set-up	24~25

Watch TV

Control TV Programmes	26~28
Viewing live TV.....	26
About Time Shift buffer - temporary HDD storage	26~27
Pause live TV function.....	28
Instant replay function	28
FlexTime function.....	28

Main Menu

Using the Home menu	29~30
About the Home menu.....	29
Viewing media information.....	30

Recording

Before Recording	31~34
Recording media	31
Default recording settings	32~34
Record TV Programmes	35~41
Record current TV programme	35
Record a specific section of TV programmes	35
Simultaneous record and play function.....	36
Automatic recording from Satellite Receiver	37
About timer recording.....	38
Timer recording (VIDEO Plus+ system).....	38~39
Timer recording (manually).....	39~40
Changing/Deleting a scheduled recording.....	41
Record from external devices	42~44
Recording from an external device (Camcorder/VCR/DVD player).....	42
Recording from a DV Camcorder	43~44

Table of Contents

Copy TV programmes from HDD	45~46
About copying	45
Copying recordings to recordable DVD.....	45
Changing the screen display for recordable DVD	46

Copy Files

Copy files between HDD, USB and DVD	47~48
Copying files from HDD to USB or recordable DVD.....	47
Copying files from USB to HDD or recordable DVD.....	48
Copying files from CD/DVD to HDD or USB.....	48

Playback

Playback from HDD	49~51
Hard Disk navigation.....	49
Basic operation	50
Delete/Lock/Protect a title in the HDD	51
Repeat hard disk playback.....	51
Playback from USB device	52
Playback from Disc	53~55
Playable discs	53
Starting disc playback.....	53~55
Additional Playback Features	56~63

Edit Recordings

Edit Recordings - Hard Disk	64~68
Changing the title name.....	64
Selecting the genre.....	64
Video editing.....	65~68
Edit Recordings - Recordable DVD	69~74
About editing recordable DVDs.....	69
Changing the disc/title name.....	70
Making the edited DVD±RW compatible	70
Deleting all recordings/titles.....	70
Finalising the DVD±R for playback.....	71
Deleting a recording/title.....	71
Lock/Unlock the disc for playback.....	72
Protecting the recorded titles (DVD±RW).....	72
Video editing.....	73~74

System Settings

System Menu Options	75~85
System menu navigation	75
Language settings.....	76
Playback settings.....	77~78
Video Output settings.....	79
Audio settings.....	80
Analogue tuner settings.....	81~83
Set up settings.....	84~85

Other

Other Information	86~87
Setting up Progressive Scan feature.....	86
Copyright notice.....	86
Installing the latest software	87
Frequently Asked Questions	88~90
Troubleshooting	91~95
Display panel symbols/messages	96~97
Glossary	98~99
Specifications	100

Care and Safety Information

IMPORTANT NOTE!

DO NOT disconnect the recorder from the power supply unless you are intending not to use this product for a long period of time. Power is needed to enable the recorder to perform essential tasks like timer recordings and automatically updating the system date/time.

Setup precautions

Finding a suitable location

- Place this unit on a flat, hard and stable surface. Do not place the unit on a carpet.
- Do not place this unit on top of other equipment that might heat it up (e.g., receiver or amplifier).
- Do not put anything under this unit (e.g., CDs, magazines).
- Install this unit near the AC outlet where the AC power plug can be easily reached.

Space for ventilation

- Place this unit in a location with adequate ventilation to prevent internal heat build up. Allow at least 10 cm (4") clearance from the rear and the top of this unit and 5cm (2") from the left and right to prevent overheating.

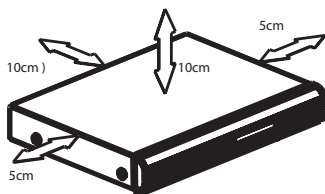

Avoid high temperature, moisture, water and dust

- This unit must not be exposed to dripping or splashing.
- Do not place any object or items that can damage this unit (e.g., liquid filled objects, lighted candles).

Cleaning discs

CAUTION!

Risk of damage to discs! Never use solvents such as benzene, thinner, cleaners available commercially, or anti-static sprays intended for discs.

- Wipe the disc with a micro fibre cleaning cloth from the centre to the edge in a straight line movement.

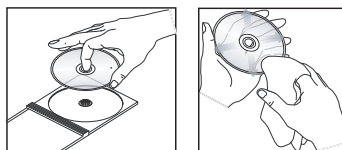

Hard Disk Drive (HDD) handling care

To avoid damage to the hard disk and losing important data:

- Do not move the recorder or subject it to vibration whilst in operation.
- Do not remove the AC power plug from the mains socket without switching the recorder to standby mode.

It is recommended to archive important recording to a recordable DVD as backup.

Energy saving message

In order to minimise power consumption in standby mode, we recommend you to leave this unit with Eco mode enable and turn off the front panel display brightness. See Playback settings - { Display } option and Setup settings - { Eco mode } option.

Product Information

Introduction

This DVD/Hard Disk Drive (HDD) recorder changes the way you watch TV. You have full control over the TV programmes you watch, because the Time Shift Buffer function stores all the programmes that the recorder is tuned to. You can 'pause' TV programmes with Pause Live TV function, or repeat any scene with the Instant Replay function.

Recording has never been easier with the built-in Hard Disk Drive, you can record up to 180~300 hours of video in SEP (Super Extended Play) recording mode.

Model	Hard Disk Drive (HDD)	Maximum recording hours
DVDR3570H	160 GB	180
DVDR3590H	250 GB	300

On top of that, you can store the DivX movies, music files and digital camera photos in the HDD Media Jukebox.

	DVDR3570H	DVDR3590H
DivX files	150	270
Photos	10,000	10,000
Music files	4,500	7,000

When you want to save or share a recording, simply copy it to a recordable DVD. You can also copy recordings from your video camera or camcorder through the i-Link connection.

Before you can start using this recorder, you must complete the basic connection and initial recorder set-up in three simple steps.

Step 1: Basic recorder connections.

Step 2: Optional connections for other devices.

Step 3: Installation and set-up.

Please take time to read this user manual before using your recorder. It contains important information and notes regarding the operation of your DVD recorder.

Helpful Hint:

– Refer to the type plate at the rear or bottom of the product for identification and supply ratings.

Accessories supplied

- Quick Start Guide
- RF antenna cable
- Scart cable
- Remote control and batteries

Region codes

DVD movies are usually not released at the same time in all regions of the world, thus all DVD players/recorders are programmed to a specific region code.

Countries	DVD Region code
Europe	 

Product Information (continued)

Special features

Pause Live TV

Every TV programme is now under your control, allowing you to take a break without missing a moment. You can pause any live TV programme by simply pressing PAUSE LIVE TV button and resume playback by pressing the PAUSE LIVE TV button again. You can now continue watching the remainder of the programme or if you want to return to the live TV programme again, just press the LIVE TV button.

Instant Replay

You can repeat any scene of a live TV programme by pressing the REPLAY (◀) button, as often as you like. If you wish to return to the live TV programme again, just press the LIVE TV button.

To enjoy Instant Replay, you need to turn your recorder on and watch your favourite TV programmes via your recorder.

FlexTime

You can be truly flexible with your time now with FlexTime. FlexTime allows you to start watching a TV programme while it is still being recorded, you do not need to wait for the recording to finish before starting to watch it. Alternatively, you can also watch another earlier recorded programme, play a DVD or DivX movie or enjoy some music while the recorder is recording the TV programme.

Time Shift Buffer (TSB)

As soon as you turn on your recorder, the TV channel it is tuned to will be stored into the Time Shift Buffer. Think of this as a temporary storage for TV programmes allowing you great flexibility. It can contain up to 6 (six) hour of TV programmes and will automatically flush anything that is older. You can mark portions of the Time Shift Buffer and copy them to your recordings list for later viewing or copying to recordable DVD. The recorder needs to be turned on for the Time Shift Buffer to be active. When the recorder is turned off, the Time Shift Buffer is automatically cleared.

VIDEO Plus+

This is a simple programming system for recorders. To use it, enter the programming number associated with your television programme. You can find this number in your favourite listings magazine.

Product Information (continued)

English

SAT Recording

This function enables you to record a programme from your Satellite Receiver or any other device. Make sure that the device is connected to the EXT2-TO VCR/SAT socket of this recorder, and the timer setting has been done on the connected device.

Follow TV

With this function you can align the sequence of the channels on your TV (analogue only) with those on your recorder. This enhances the efficiency of the system for recordings. Make sure you have connected the TV to the EXT1 TO TV socket of this recorder.

* The Follow TV feature may not work properly on every TV.

i.LINK

i.LINK, also known as 'FireWire' or 'IEEE 1394', is a digital connection for connecting your camcorder to enable you to make high quality copies of your camcorder videos. The connector can be found behind the front flap door.

Remote Control

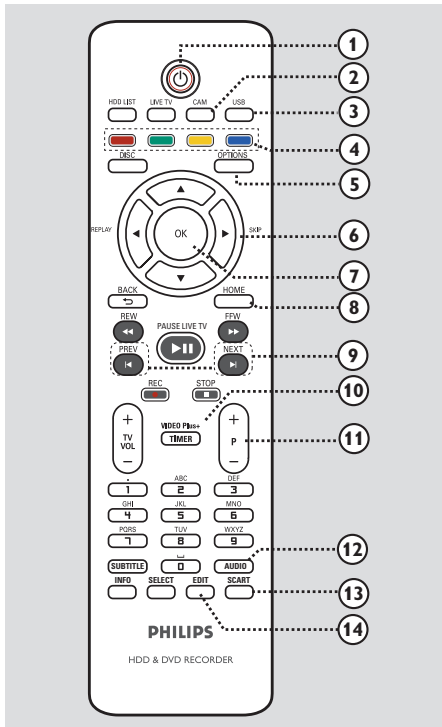

- ① **Power**
– Turns on this unit or turns off to normal standby mode.
- ② **CAM**
– Switches to the camcorder that is connected to the DV IN CAM2 socket.
- ③ **USB**
– Switches to USB mode and shows the content of the USB device.
- ④ **Colour coded buttons**
– These buttons can be used to select the coloured options available in some menus.

- ⑤ **OPTIONS**
– Enters/exits the Options menu. This menu provides various setting options.
- ⑥ **◀ ▶**: Cursor buttons for moving to the left/right. In recorder's Live TV mode, replay or skip the scene by a specified length of time.
▲ ▼: Cursor buttons for moving up/down.
- ⑦ **OK**
– Confirms an entry or selection.
- ⑧ **HOME**
– Enters/exits the recorder's Home menu.
- ⑨ **PREV ◀ / NEXT ▶**
– Skips to previous or next title/chapter/track.
- ⑩ **TIMER (VIDEO Plus+)**
– Enters/Exits the timer programming mode.
- ⑪ **P + –**
– While in Live TV mode, select the next or previous TV channel or the external input source (EXT1, EXT2, CAM1).
– While in camcorder mode, select other external input source (EXT1, EXT2, CAM1).
- ⑫ **AUDIO**
– Selects an audio language/channel.
- ⑬ **SCART**
(only effective when your TV is connected with the Scart cable to EXT1 of your recorder)
– Switches to the device that is connected to the EXT2 Scart connector of your recorder. If no device is connected to EXT2, it switches to TV preset instead. To switch back to recorder mode, press this button again.
- ⑭ **EDIT**
– Enters/exits the editing menu.

Remote Control (continued)

15 LIVE TV

- Switches to live TV mode. It activates the Time Shift Buffer that allows you to pause or replay the TV programme at any time.

16 HDD LIST

- Shows the list of your recordings stored in the internal hard disk.

17 DISC

- Shows the content of the disc.

18 BACK ◀

- Returns to the previous menu.

19 REW ◀◀ / FFW ▶▶

- Fast reverse or fast forward search.

20 PAUSE LIVE TV ⏸

- Pauses or resumes a live TV programme.
- Starts or pauses playback of any recorded title or disc.

STOP ■

- Stops playback/recording.
- Hold down this button to open or close the disc tray.

REC ●

- Starts recording the currently viewed TV programme. Press repeatedly to set the recording length in 30-minute increments.

21 TV VOL + –

- Adjusts the volume of the TV (for Philips TVs or compatible brands only).

22 Alphanumeric keypad

- Used to enter numbers or letters (using SMS style entry).
- Selects a chapter/track/title number to play.
- Selects the recorder's preset tuner channel.

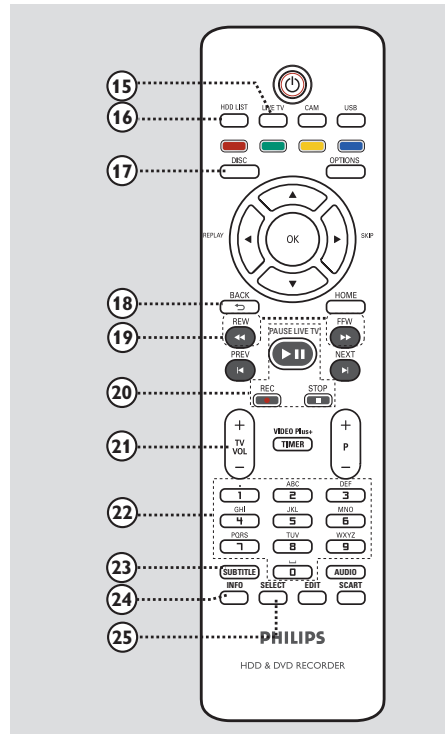

23 SUBTITLE

- Selects a DVD subtitle language.

24 INFO

- Displays on-screen information.

25 SELECT

- Selects multiple files for copying or deleting.
- Toggles between 'T' (title) and 'C' (chapter) selection during disc playback, then use the ◀ / ▶ keys to select the previous or next title/chapter.
- Toggles between upper and lower case characters while using the alphanumeric keypad.

Remote Control (continued)

Using the remote control

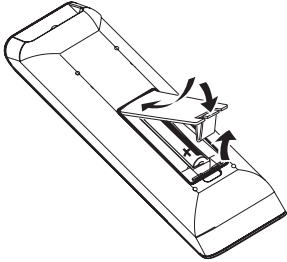

- 1 Open the battery compartment cover.
- 2 Insert two batteries type R03 or AAA. Match the indications (+ -) inside the battery compartment.
- 3 Close the cover.
- 4 Point the remote control directly at the remote sensor on the front panel and select the desired function.

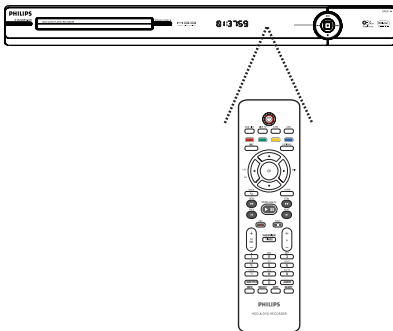



CAUTION!

- Remove batteries if they are exhausted or if the remote control is not to be used for a long time.
- Do not mix batteries (old and new or carbon and alkaline, etc.).
- Batteries contain chemical substances, they should be disposed of properly.

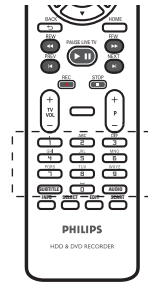
Using the alphanumeric keypad to enter the characters



- Press a number button repeatedly until the required character or the number appears.
- To enter special symbols, press button  repeatedly.
- To select upper/lower case (capital/small) letters, press **SELECT**.
- To enter a space, press button .

Main Unit

English

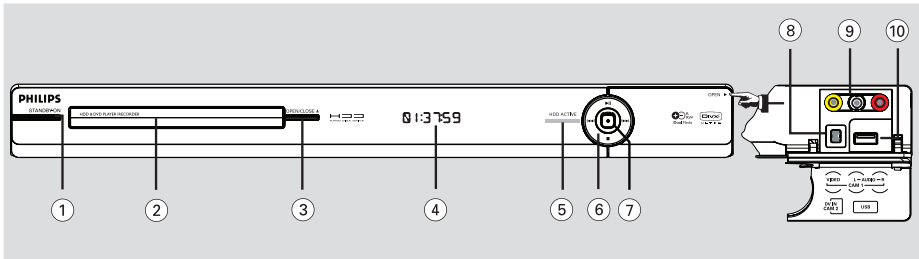

① STANDBY-ON

- Turns on this unit or turns off to normal standby mode.

② Disc tray

③ OPEN CLOSE ▲

- Opens or closes the disc tray.

④ Display panel

- Shows information about the current status of the recorder.

⑤ HDD ACTIVE

- Lights up when access hard disk.

⑥ ►||

- Pauses or resumes a live TV show.
- Starts or pauses playback.



- Skips to the previous or next chapter/track. Hold down the button to make a reverse/forward search.



- Stops playback/recording.

⑦ ●

- Starts recording the currently viewed TV programme. Press repeatedly to set the recording length in 30-minute increments.
- Lights up while recording is in progress.

Sockets behind the flap

Flip down the door as indicated by the **OPEN** u label at the right hand corner.

⑧ DV IN-CAM2 socket

- Input for digital camcorders (also referred to as FireWire or IEEE1394).

⑨ VIDEO-AUDIO-CAM1 socket

- Composite video and audio inputs for camcorder/DVD player/VCR or other similar device.

⑩ USB socket

- Input for USB flash drive, USB memory reader or digital camera.
* Not all brands and models of digital cameras are supported, except those compliant with the PTP standard.

Step 1: Basic Recorder Connections

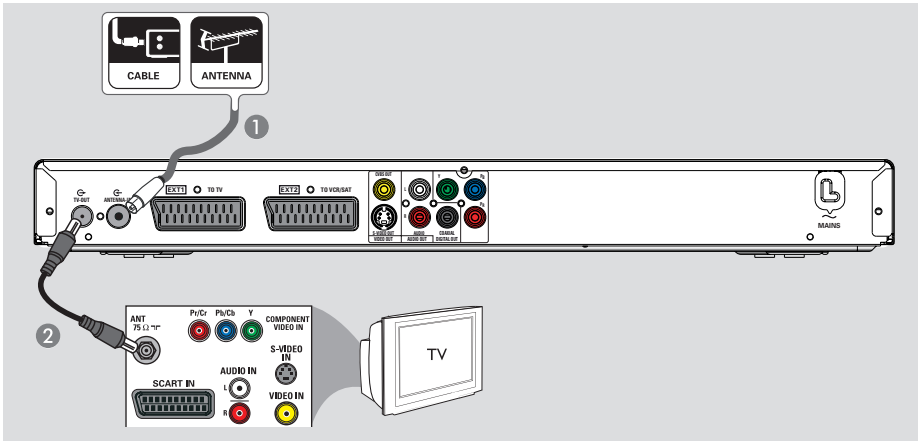

Connecting the antenna cables

These connections enable you to watch and record TV programmes using this recorder. If the antenna signal is connected via a Cable Box or Satellite Receiver, ensure that these devices are turned on in order to watch or record the cable programmes.

- **If you want to connect to a VCR and/or a separate Cable Box/ Satellite Receiver,** see 'Step 2: Optional Connections' for details.

Helpful Hint:

– Depending on how you have currently connected your TV channel (directly from an off-air antenna or cable box or VCR), you'll have to disconnect some of the cables before you make the antenna connection.

- 1 Connect the existing Antenna cable (it can be from the off-air wall socket or Cable Box) to the **ANTENNA-IN** socket on the recorder.
- 2 Connect a RF antenna cable (supplied) from the **TV-OUT** socket on the recorder to the antenna input socket on your TV (usually labelled as ANT, ANTENNA IN, RF IN).

Step I: Basic Recorder Connections (continued)

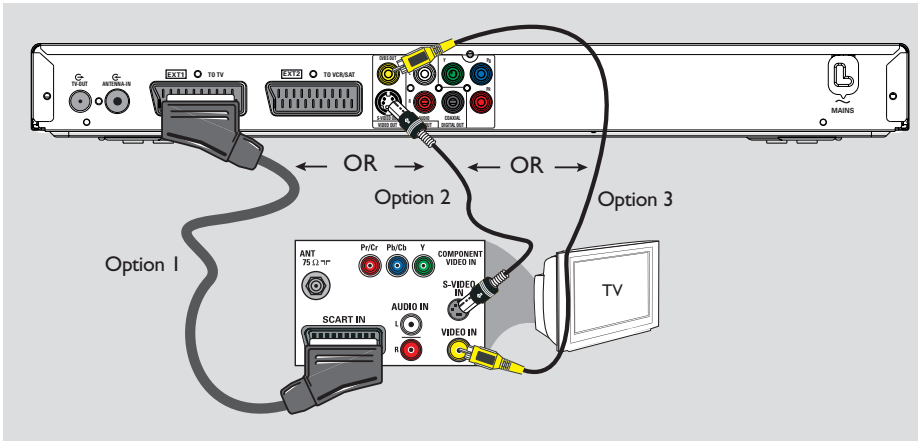

Connecting the video cable

This connection enables you to view the playback from this recorder. You only need to choose **one** of the options below to make your video connection.

- For a standard TV, follow option 1, 2 or 3.
- For a progressive scan TV, follow option 4.

Helpful Hint:

– Audio connection is only required if you are using the Y Pb Pr, S-VIDEO or CVBS socket to connect your TV. See 'Connecting the audio cables' for details.

Option 1: Using the Scart socket

- Connect a scart cable (supplied) from the **EXT1 TO TV** socket on the recorder to the corresponding SCART socket on the TV.

Helpful Hint:

– Use the EXT2-TO VCR/SAT socket for connecting the recorder to additional device.

Option 2: Using the S-Video socket

- Connect a S-video cable (not supplied) from the **S-VIDEO OUT** socket on the recorder to the S-Video input socket (usually labelled as Y/C or S-VHS) on the TV.

Option 3: Using the Video (CVBS) socket

- Connect a composite video cable (yellow - not supplied) from the **CVBS OUT** socket on the recorder to the video input socket (usually labelled as A/V In, Video In, Composite or Baseband) on the TV.

Step I: Basic Recorder Connections (continued)

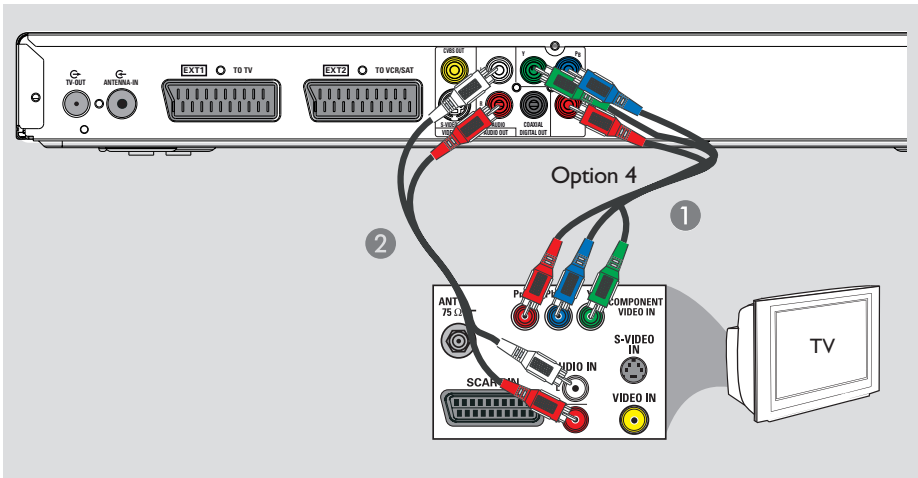

Option 4: Using Component video socket / Connecting to a Progressive Scan TV

The progressive scan video quality is only available when using Y Pb Pr connection and a progressive scan TV is required. It provides superior picture quality when watching DVD movies.

- 1 Connect the component video cables (red/ blue/green - not supplied) from the **Y Pb Pr** sockets on the recorder to the corresponding component video input sockets (usually labelled as Y Pb/Cb Pr/Cr or YUV) on the TV.
- 2 Connect the audio cable (red/white - not supplied) from the **AUDIO OUT L/R** sockets on the recorder to the audio input sockets on the TV.

Note:

To enable Y Pb Pr (YUV) connection, you must set the recorder's video output correctly.

- 1 Make an addition video connection from this recorder to your TV using Scart, S-Video or Video (CVBS).
- 2 Turn on your TV to the correct viewing channel for the above video connection.
- 3 When you have completed the installation and set-up, change the video output setting of this recorder as follows:
 - 1) Press **OPTIONS**.
 - 2) Move to { **Settings** } > { **Video output** } > { **Active video output** } > { **Comp. video (YUV)** }, then press **OK** to confirm.
- To activate Progressive Scan output, see 'Other information - Setting up Progressive Scan feature' for details.
- 4 Switch your TV to the correct viewing channel for the Component video connection (refer to your TV's user manual).

Step I: Basic Recorder Connections (continued)

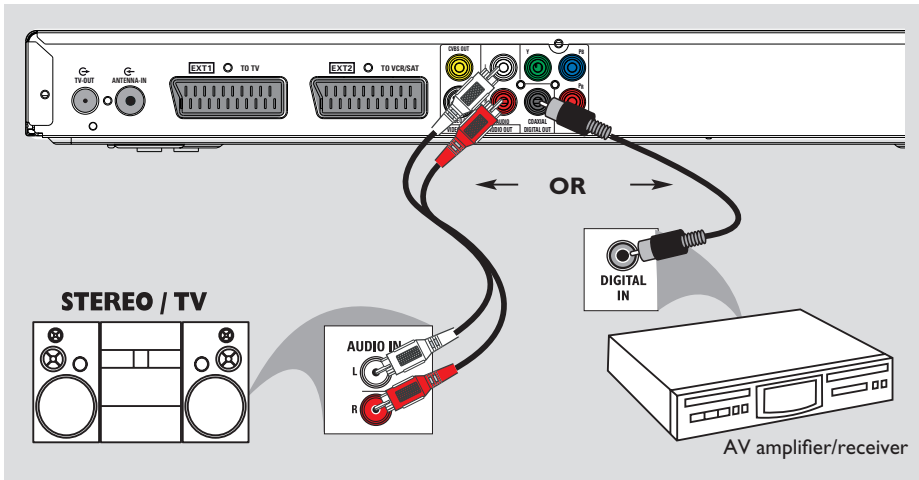

Connecting the audio cables

This connection enables you to listen to the playback from this recorder. However, this connection is not required if this recorder is connected to the TV using the Scart connector.

Option 1: Using the analogue audio sockets

You can connect the recorder to a two channel stereo system (mini system, TV) or receiver in order to enjoy the stereo sound system.

- Connect the audio cable (red/white - not supplied) from the **AUDIO OUT** sockets to the audio input sockets of the connected device.

Option 2: Using the digital audio socket

You can connect the recorder to an AV amplifier/receiver in order to enjoy multichannel surround sound.

- Connect a coaxial cable (not supplied) from the **COAXIAL DIGITAL OUT** socket to the digital coaxial input socket (or labelled as **COAXIAL IN** or **DIGITAL IN**) of the connected device.

Helpful Hint:

– You have to set the appropriate *Digital Audio Output* setting. Otherwise, no sound or interference may occur. See 'System Menu Options - Audio settings' for details.

Step 2: Optional Connections

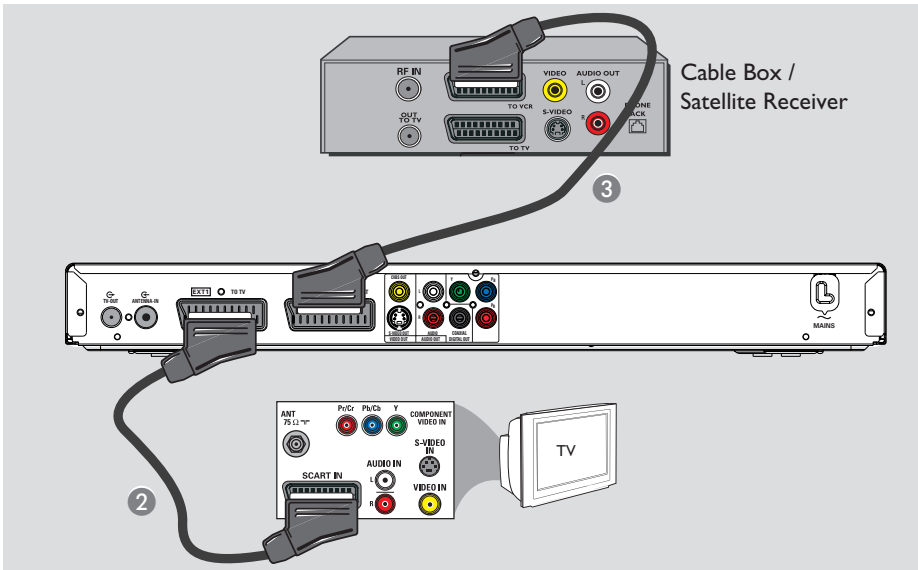

Connecting to a Cable Box or Satellite Receiver

Option 1

If your Cable Box/Satellite Receiver has only an antenna output socket (RF OUT or TO TV), see 'Basic Recorder Connections - Connecting the antenna cables' for details.

Option 2 (as shown on the above illustration) **If your Cable Box/Satellite Receiver has a Scart output socket**

- 1 Keep the existing antenna connection from the Cable Box/Satellite Receiver to your TV.
- 2 Connect a scart cable (supplied) from the **EXT1 TO TV** socket on the recorder to the corresponding SCART socket on the TV.
- 3 Connect another scart cable (not supplied) from the **EXT2-TO VCR/SAT** socket on the recorder to the Scart socket (usually labelled as TV OUT or TO VCR) on the Cable Box/ Satellite Receiver.

Helpful Hint:

– If your TV is connected to the recorder via the COMPONENT VIDEO (Y Pb Pr) sockets, then connect the external cable box/satellite receiver to the EXT1 TO TV socket.

Step 2: Optional Connections (continued)

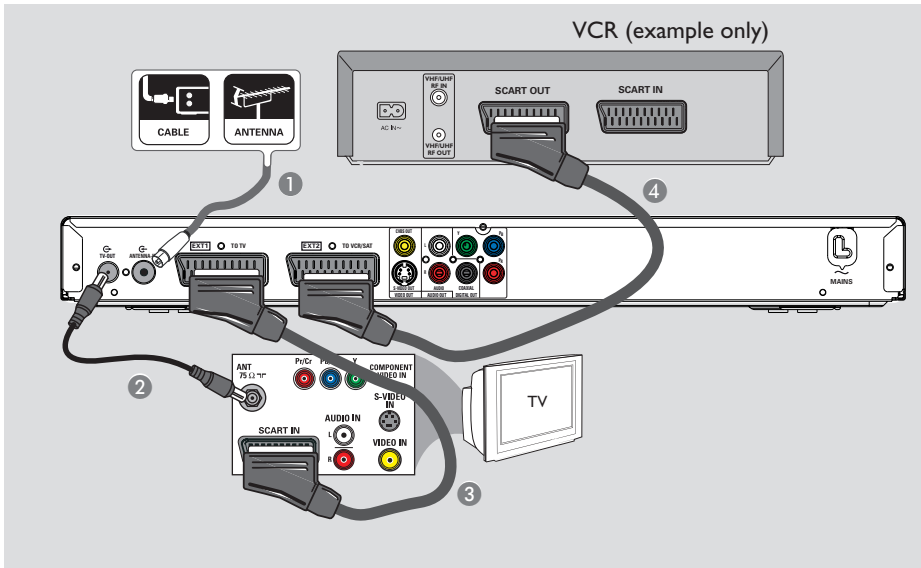

Connecting to a VCR or other similar device

This connection enables you to record from video tape to hard disk and allows the VCR to be used for playback on the TV if the recorder is turned off.

Note:

Your new recorder can replace the VCR for all your recording needs. Just unplug all the connections to your VCR.

- 1 Connect the existing Antenna cable (it can be from the off-air wall socket or Cable Box) to the **ANTENNA-IN** socket on the recorder.
- 2 Connect a RF antenna cable (supplied) from the **TV-OUT** socket on the recorder to the antenna input socket on your TV (usually labelled as ANT, ANTENNA IN, RF IN).

- 3 Connect a scart cable (supplied) from the **EXT1 TO TV** socket on the recorder to the corresponding SCART socket on the TV.
- 4 Connect another scart cable (not supplied) from the **EXT2-TO VCR/SAT** socket on the recorder to the Scart socket (usually labelled as TV OUT or TO TV) on the VCR.

Helpful Hints:

- Most commercial video cassettes and DVDs are copy-protected and therefore cannot be recorded.
- Connect the recorder directly to the TV. If there is a VCR or an additional device in between, the picture quality may be poor.

Step 2: Optional Connections (continued)

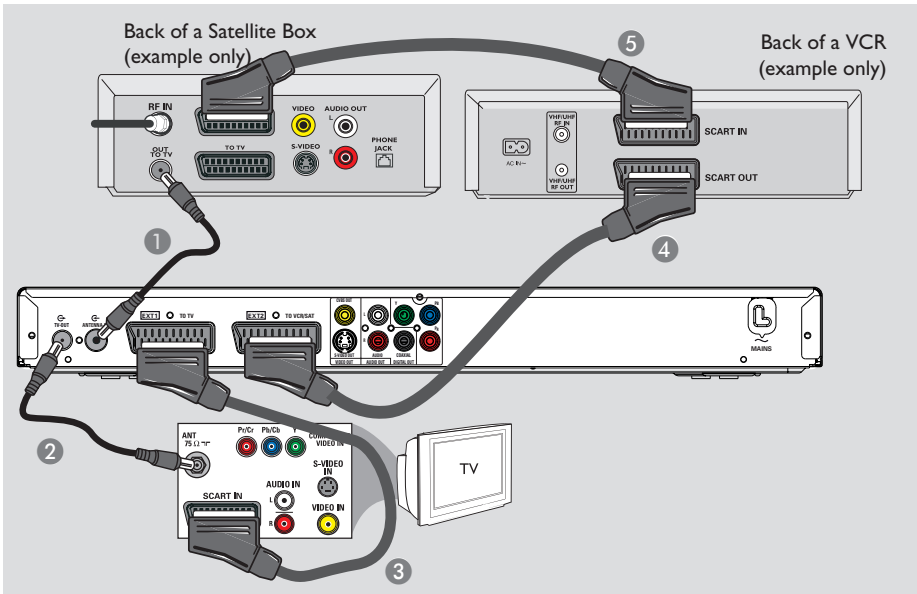

Connecting to a VCR and Cable Box/Satellite Receiver

- 1 Connect the existing Antenna cable from the antenna output socket on the Cable Box or Satellite Receiver to the **ANTENNA-IN** socket on the recorder.
- 2 Connect a RF antenna cable (supplied) from the **TV-OUT** socket on the recorder to the antenna input socket on your TV (usually labelled as ANT, ANTENNA IN, RF IN).
- 3 Connect a scart cable (supplied) from the **EXT1 TO TV** socket on the recorder to the corresponding SCART socket on the TV.
- 4 Connect another scart cable (not supplied) from the **EXT2-TO VCR/SAT** socket on the recorder to the Scart socket (usually labelled as TV OUT or TO TV) on the VCR.
- 5 Connect another scart cable (not supplied) from the Scart socket (usually labelled as TV IN or TO DECODER) on the VCR to the Scart socket (usually labelled as TV OUT or TO VCR) on the Cable Box/ Satellite Receiver.

Step 2: Optional Connections (continued)

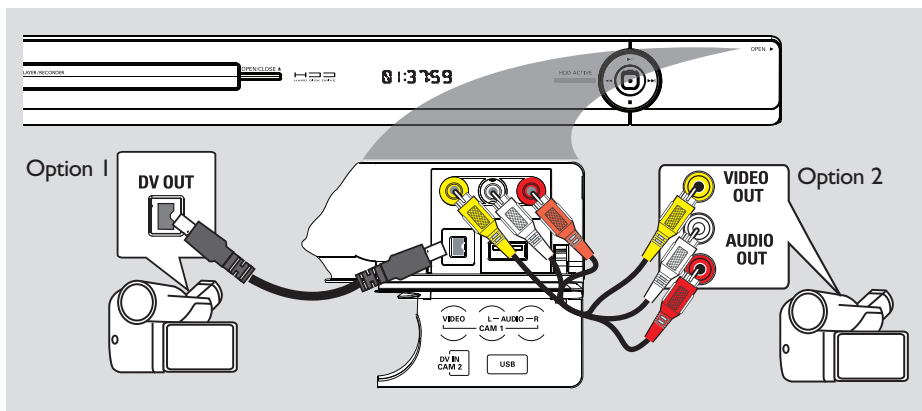

Connecting to a camcorder

You can use the front sockets to copy camcorder recordings. These sockets are located behind the flap on the right hand side which provides convenient connections.

Option 1: Using the DV IN socket

Use this connection if you have a Digital Video or Digital 8 camcorder. The DV socket conforms to the i.LINK standard. It provides the best picture quality.

- 1 Connect an i.LINK 4-pin cable (not supplied) from the **DV IN** socket on the recorder to the appropriate DV OUT socket on the camcorder.
- 2 Press **CAM** on the remote control to select 'CAM2'.

Helpful Hint:

– It is not possible to record from this recorder to your camcorder via the DV IN socket on your recorder.

Option 2: Using the VIDEO In socket

Use the VIDEO connection if your camcorder has only a single video output (Composite Video, CVBS). It provides good picture quality.

- 1 Connect the **VIDEO** socket at the front panel of the recorder to the corresponding S-VHS or Video output socket on the camcorder.
- 2 Connect the audio cable (red/white - not supplied) from the **AUDIO L/R** sockets at the front panel of the recorder to the audio output socket on the camcorder.
- 3 Press **CAM** on the remote control followed by **P** +/- repeatedly to select 'CAM1'.

Helpful Hint:

– If you connect your camcorder to the scart socket at the rear of this recorder, select { EXT1 } or { EXT2 } as the input source.

Step 3: Installation and Set-up

The installation menu appears the very first time you turn on this recorder. These settings help you set up the basic recorder features easily, including TV programme installation and language settings.

Before you start ...

Complete the installation settings before inserting a disc for playback or recording.

- 1 Turn on the TV.
- 2 Press **STANDBY-ON**  to turn on the recorder.
→ Your TV should show the recorder's initial installation screen now - { **Menu Language** } screen.
→ If not, you may need to select the correct input on your TV. Refer to your TV's user manual on how to select the correct input on your TV.

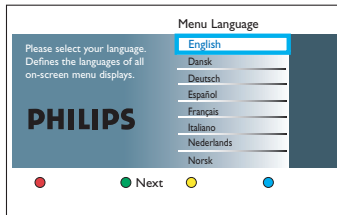

- 3 Use **▲▼** keys on the remote control to select the desired on-screen display language and press **OK** to confirm.
- 4 The Country Selection screen appears on the TV. Move the selection bar to the country you live in and press **OK** to confirm.
→ This setting is important for automatic installation of TV channels in your area.

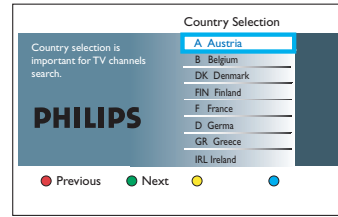

Note: Press the **Red** button on the remote control for returning to the previous screen or press the **Green** button for proceeding to the next installation step.

- 5 The TV shape screen appears on the TV. Select the appropriate TV shape in the way you want the wide-screen movies to be displayed and press **OK** to confirm.

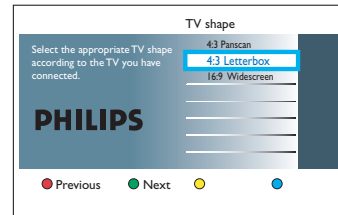

4:3 PanScan (PS)



4:3 LetterBox (LB)



16:9 (Widescreen)

- 6 The Channel Search screen appears on the TV. Press **OK** to start auto channel search.
→ The recorder starts the analogue channel search.

Step 3: Installation and Set-up (continued)

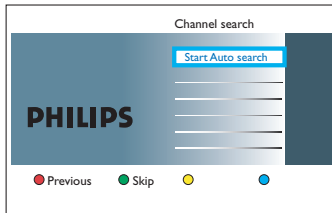

Note: Make sure you have successfully made all the required connections to this recorder, the TV and Satellite Receiver/ Cable Box (if any) and turned them on. The channel search will detect the signals and save all the available programme channels.

- 7 After the channel search is finished, the number of found and stored channels appear, press the **Green** button to continue.

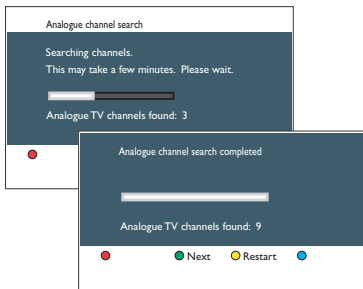

- 8 The Time entry screen appears. Use the **alphanumeric keypad 0-9** or **▲▼** keys to enter the correct time, then press **OK** to confirm or the **Green** button to continue.

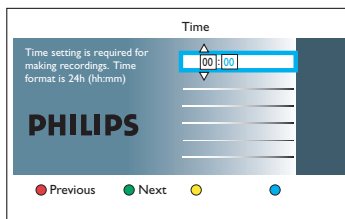

- 9 The Date entry screen appears. Use the **alphanumeric keypad 0-9** or **▲▼** keys to enter the correct date, then press **OK** to confirm or the **Green** button to continue.

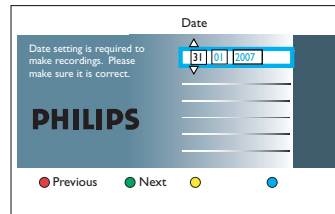

- 10 The installation is now completed. Press the **Green** button on the remote control to close the screen.

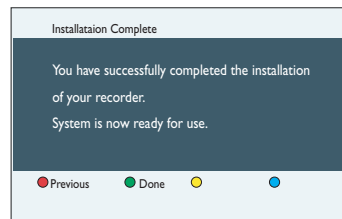

The DVD recorder is now ready for use.

Control TV Programmes

Viewing live TV

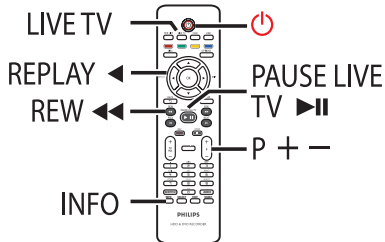

- 1 Turn on the TV. If necessary, switch the TV to the correct input channel for viewing the recorder's playback.
 - 2 Press **STANDBY-ON**  to turn on this recorder.
→ You should see the TV programme on the TV. If not, press **LIVE TV**.
 - 3 Press **P +/-** to select a desired channel.
→ The TV programme you are tuned to is automatically stored in the Time Shift Buffer. This allows you to pause the live TV and resume playback at any time.
- If you switch to another TV channel on the recorder, a new title will be created and a vertical line will be shown on the Time Shift video bar.



- You can choose to display or hide the Time Shift video bar by pressing the **INFO** on the remote control.

About Time Shift Buffer - temporary HDD storage

The current TV programme will be stored in the temporary hard disk storage called '**TSB**' (Time Shift Buffer) once the recorder is turned on. It continuously stores up to 6 (six) hours of TV programmes.

The Time Shift video bar indicates the status and timing of the stored TV programmes.

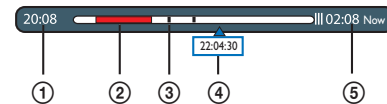

The Time Shift video bar consists of the following information:

- 1 The TV programme start time.
Once it has exceeded 6 (six) hours, the start time will be changed accordingly.
- 2 Clips that are selected to be recorded onto the hard disk (marked Red).
- 3 Title markers (when you switch to a TV channel for more than 2 minutes, a new title marker will be created).
- 4 Current position and time of the TV programme broadcast.
- 5 Present time

Helpful Hint:

– The Time Shift Buffer stores and retains up to the last 6 (six) hours of TV programmes when the recorder is turned on. If you switch the recorder to standby mode, all the contents in the Time Shift Buffer will be cleared.

Control TV Programmes (continued)

Marking the contents for recording

You need to 'mark' the contents in the Time Shift Buffer before it can be recorded to the hard disk. The recording will take effect when you put the recorder to standby mode.

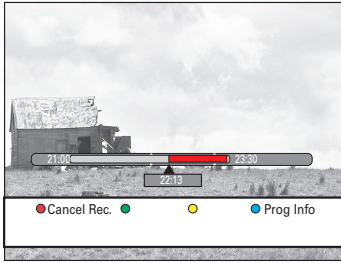

To find a scene within the Time Shift Buffer

- Use ◀◀ / ▶▶ or ◀ / ▶ keys.

To mark the starting point of recording

- Press **REC** ● once.

To mark the end of the recording

- Navigate to the end of the scene and press **STOP** ■.

To cancel the marked recording

- Press the **Red** button.

Helpful Hint:

– You can set the length of skip search interval, see chapter 'System Menu Options - Playback settings - { Replay interval } / { Skip interval }' for details.

Clearing the Time Shift Buffer

All the contents in the Time Shift Buffer will be cleared when you switch the recorder to standby mode, except for the marked contents which will then be stored into the hard disk. You can also clear the contents using the following steps while the recorder is turned on.

- 1 Press **OPTIONS** on the remote control.
→ The tools menu appears.

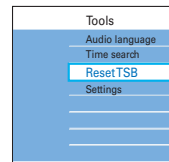

- 2 Move to { **Reset TSB** } and press **OK**.
→ A warning message on clearing the Time Shift Buffer appears.

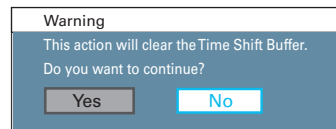

- 3 To proceed, select { **Yes** } in the menu and press **OK** on the remote control.
- Otherwise, select { **No** } in the menu and press **OK** on the remote control to abort the operation.

Note:

In addition, executing the following actions will also clear the contents in the Time Shift Buffer:

- Press **CAM** on the remote control.
- Access { **Tuner** } option in the system settings menu.
- Change the { **Record mode** } or { **Clock** } setting.

Control TV Programmes (continued)

Pause live TV function

Before you start ...

Turn on the recorder to LIVE TV mode to watch your favourite TV programmes.

- 1 Press **PAUSE LIVE TV ►||** on the remote control to pause playback.
 - 2 To resume playback, press the same button again.
- If you want to return to the live TV programme, just press **LIVE TV**.

Instant replay function

Before you start ...

Turn on the recorder to LIVE TV mode to watch your favourite TV programmes.

- Press **◀** on the remote control to replay the live TV programme.
→ The scene is jumped back by 30 seconds (default setting) upon every single press.
- If you want to return to the live TV programme, just press **LIVE TV**.

FlexTime function

- While recording is in progress, press **▲** on the remote control to go back to the beginning of the recording and start playback.
OR
- Press **REW ◀◀** or **PREV |◀** until you reach the scene to begin.

Using the Home menu

About the Home menu

Home menu allows access to contents on your Hard Disk recording, media files on Hard Disk, and contents of disc and USB. It also allows transferring of content among various media types.

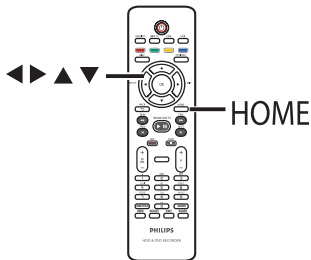

- 3 Use ◀▶▲▼ keys to select recordings, audio/video files or photos.
- 4 Press ▶|| to start playback.

- 1 Press **HOME** on the remote control.
→ The Home menu appears.

Source	Content
Hard Disk	Recordings
Disc Tray	Video files
USB	Music
	Photo

- 2 Move the selection bar to a desired media or function and press ▶ or **OK** to select.

{ **Hard Disk** }

To access the contents stored on the hard disk, such as your recordings, photos, music or video files.

{ **Disc Tray** }

To access the contents of the disc. In case the tray is empty, nothing will be shown.

{ **USB** }

To access the contents of the connected USB flash drive or camera. In case there is no device connected or the device is not able to detect by the recorder, nothing will be shown.

Using the Home menu (continued)

Viewing media information

To view general information on the selected media such as size, remaining space, media type etc.

- 1 Press **HOME**.
→ The Home menu appears.
- 2 Move the selection bar to a desired source.
→ If the media information is available, a text label will be appeared next to the blue softkey.
- 3 Press the **Blue** button on the remote control to display the information.

{ **HDD Info** }

Recorder hard disk information.

- Remaining hard disk size for video partition (TV recordings and DivX movies).
- Space used by protected/unprotected titles.
- Free time for recording based on the current active recording mode.
- Remaining hard disk size for data partition (for music and photo files) and its free space size for recording.

{ **DVDR Info** }

DVD±R or DVD±RW information.

- Disc name, type and status
- Total size.
- Used space.
- Available space.
- Space used by protected titles.

{ **USB Info** }

USB drive information.

- Name.
- Total memory size.
- Available space.

- 4 Press the **Blue** button again returns to the previous menu.

Recording media

The recording media for this recorder are internal hard disk drive and DVD±R/±RW/+R DL.



- The hard disk has a high storage density which enables long recording duration and quick access to the recording titles.



DVD±RW (DVD Rewritable)

- Discs that are rewritable can be used for multiple recordings once the existing data is erased.



DVD±R (DVD Recordable)

- Discs can only be used for a single recording. Each new recording is always added at the end of all previous recordings as existing recordings cannot be overwritten.
- Editing can be done on DVD±R discs as long as they have not been finalised.
- You can also delete unwanted recordings. However, the disc space occupied by the deleted recordings cannot be recovered for further recording.
- To play a DVD±R disc on other DVD players, it must be finalised. After this is done, no more data can be added to the disc. See 'Edit Recordings - Recordable DVD - Finalising the DVD±R for playback' for details.



DVD+R DL (DVD+R Double Layer)

- It contains the same usage as DVD+R, the only difference is the capacity of 8.5 GB. It offers two recordable layers on a single DVD disc. The layers are accessible from the same side of the disc, so recording can occur completely uninterrupted.

Supported disc type and media speeds

Disc	Media speeds
DVD+R	1x - 16x
DVD+RW	2.4x - 8x
DVD-R	1x - 16x
DVD-RW	2.4x - 4x
DVD+R DL	2.4x

Helpful Hints:

- In some cases, you may not be able to add new recording to a recordable DVD that contains recordings from other DVD recorders.
- If the newly recorded title in the hard disk is not accessible, turn the recorder off and on again to recover the recording.
- If you are unable to fit a title to a recordable DVD, split the title to remove the unwanted sections. See 'Edit Recordings - Hard Disk - Video editing' for details.
- If power failure occurred while copying the recordings from hard disk is in progress, it may lead to a bad disc.

Before Recording (continued)

Default recording settings

You can preset your recording settings in the recording setup menu.

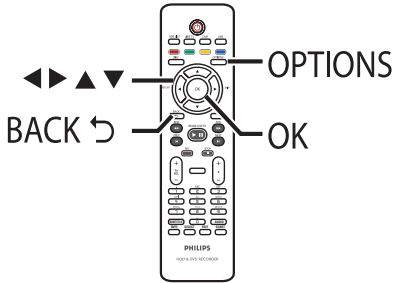

- 1 Press **OPTIONS** on the remote control.
→ The tools menu appears.

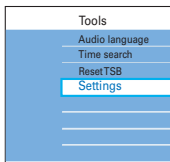

- 2 Move to { **Settings** } and press **OK**.
→ The system settings menu appears.

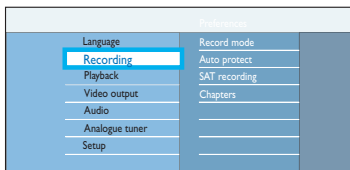

- 3 Move to { **Recording** } and press **►**.

- 4 Use **▲▼** keys to select the setting you wish to change and press **►** to access its options.
→ Instructions and explanations of the options are provided in the following pages.
→ If the option in the menu is greyed out, that means the feature is not available or not possible to change at the current state.
- 5 Press **OK** to confirm any new settings.
 - To return to the previous menu screen, press **◀**.
- 6 To exit, press **OPTIONS**.

Helpful Hints:

- Changing the Recording Mode clears the contents in the Time Shift Buffer, only the marked contents (in red bar) will be recorded into the hard disk of this recorder.
- Your recording picture quality will be changed according to the selected record mode, including watching the live TV through the recorder.

Before Recording (continued)

Recording settings (underlined options are the factory default settings)

Record mode

The recording mode defines the picture quality of recordings and the maximum recording time.

DVDR3570H

Record Mode	Hours of recordings can be stored on the HDD or an empty DVD recordable disc.		
	HDD (160 GB)	DVD±R/ DVD±RW	DVD+R Double Layer
HQ (high quality)	23	1	1 hr 55 mins
SP (standard play)	45	2	3 hrs 40 mins
SPP (standard play plus)	56	2.5	4 hrs 35 mins
LP (long play)	68	3	5 hrs 30 mins
EP (extended play)	90	4	7 hrs 20 mins
SLP (super long play)	135	6	11 hrs 5 mins
SEP (super extended play)	180	8	14 hrs 45 mins

DVDR3590H

Record Mode	Hours of recordings can be stored on the HDD or an empty DVD recordable disc.		
	HDD (250GB)	DVD±R/ DVD±RW	DVD+R Double Layer
HQ (high quality)	40	1	1 hr 55 mins
SP (standard play)	77	2	3 hrs 40 mins
SPP (standard play plus)	96	2.5	4 hrs 35 mins
LP (long play)	115	3	5 hrs 30 mins
EP (extended play)	153	4	7 hrs 20 mins
SLP (super long play)	230	6	11 hrs 5 mins
SEP (super extended play)	300	8	14 hrs 45 mins

Note: When copying from hard disk to a recordable DVD, the recording mode of the selected recording in the hard disk will automatically be transferred. Selecting another recording mode is not possible. The factory default setting is **SPP**.

Auto protect

With this feature, delete and edit on the protected titles are not possible.

- { **On** } – New recorded titles will be automatically protected.
- { **Off** } – Disable the function.

Note: To delete a protected title, first press the Blue button on the remote control to turn off the protect feature, then press the Red button to delete.

SAT recording

This feature is only available if you have connected a Satellite Receiver or other device to the EXT2-TO VCR/SAT scart socket of this recorder. See 'Record to Hard Disk - Automatic recording from Satellite Receiver' for details.

- { **On** } – Enable this recorder to start and stop recording when a signal is received from the connected device.
- { **Off** } – Disable the function.

Before Recording (continued)

Recording settings (underlined options are the factory default settings)

Chapters

Automatically divides a recording (title) into chapters by inserting chapter markers at a specific interval. This enables you to access a specific point in the recording quickly.

- { **Smart** } – This setting is only available for the DV camcorder recording. A chapter marker is inserted whenever there is a break in the time code on the DV tape.
- { **Off** } – No chapter marker is inserted in the recording.
- { **Standard** } – Chapter markers are inserted automatically during recording at approximately 5 (five) minutes interval.

Record TV Programme

CAUTION!

- Copy prohibited contents cannot be recorded on this recorder.
- When the hard disk is full, making a new recording automatically deletes the oldest unprotected title on the hard disk to make space for the new recording.

Record current TV programme

Follow the instructions below to record the TV programmes to this recorder's hard disk, where you can store for future viewing and copy to a recordable DVD disc if required.

- 1 While the Time Shift Buffer is at 'LIVE' position, press **REC** ● on the remote control.
→ It starts recording from the current position, up to maximum of 6 (six) hours.

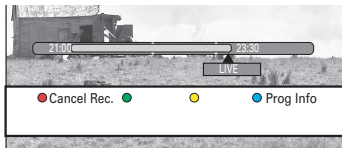

- Press **REC** ● repeatedly will set the recording time length in 30-minute increments, up to a maximum of 6 (six) hours.
- 2 You can turn off your TV and the recorder to standby mode while recording.
→ The recorder continues recording and stops at the designated end time.
- If you wish to stop the recording before the scheduled time, press **STOP** ■.

Record a specific section of TV programmes

This is only possible for the TV programmes that can be found in the Time Shift Buffer.

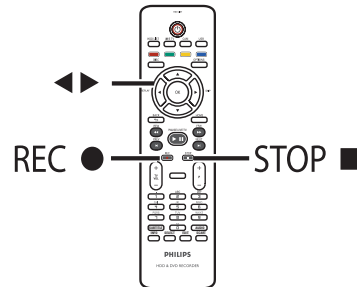

- 1 Use ◀▶ keys to search for the beginning of the scene where you want to start recording.

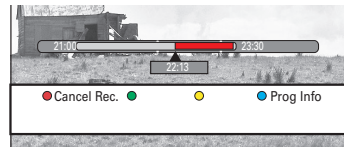

- 2 Press **REC** ● on the remote control.
 - 3 Press ▶ to search for the point where you want to end the recording and press **STOP** ■ on the remote control.
→ A red marking will be visible on the video bar to indicate the marked recording.
- To cancel the recording, press the **Red** button for { **Cancel Rec** }.

Record TV Programme (continued)

Simultaneous record and play function

While recording a TV programme to the hard disk, you can play a previously recorded title from hard disk, playback a DVD video disc or you can also playback music, photo slideshows or DivX videos from hard disk, optical disc or USB. It is also possible to watch playback from other connected devices.

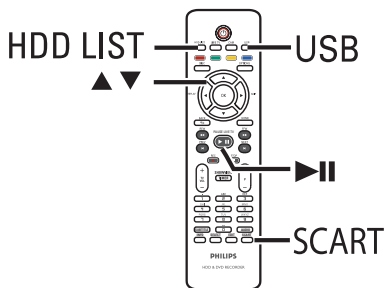

Playback from HDD

- 1 Press **HDD LIST** on the remote control.

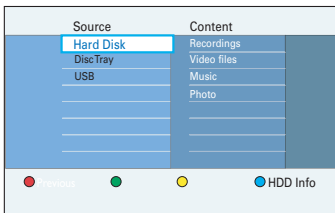

- 2 Use **▲▼** keys to reach the title you want to play.
- 3 Press **▶||** to start playback.

Playback from DVD

- 1 Press **OPEN CLOSE ▲** on the recorder's front panel.
- 2 Load in a disc to start playback.

Playback from USB

- 1 Insert a USB flash drive to the USB socket.
- 2 Press **USB** on the remote control.
- 3 Select a file and press **▶||** to start playback.

Playback from other device

This is only possible if this recorder is connected to the TV using the EXT1 TO TV socket.

- Press **SCART** to view the picture from the device which is connected to the EXT2-TO VCR/SAT socket of this recorder.
- If there is no device connected to the EXT2-TO VCR/SAT socket, pressing **SCART** switches to TV preset.

Watching other TV programmes

- Use the TV's channel up/down button to select a different TV channel.

Helpful Hint:

– Remember to switch the TV back to its video input channel if you want to watch the TV channel through the recorder or play back the recorded disc.

Record TV Programme (continued)

Automatic recording from Satellite Receiver

The feature is only applicable for the Satellite Receiver (or any similar devices) that is connected to the EXT2-TO VCR/ SAT scart socket of this recorder. In addition, the Satellite Receiver must have a timer function that is able to control the recording function of this recorder.

Before you start ...

Ensure that the { **SAT recording** } mode in the recording setting is set to { **On** }.

- 1 Use the Satellite Receiver's timer programming function to program the recording (refer to the Satellite Receiver's user manual).
→ Each recording can be programme up to 6 (six) hours.
- 2 Turn off the Satellite Receiver to standby mode.
- 3 Turn off the recorder to standby mode.
→ Leave the recorder and Satellite Receiver in standby mode for the recording.
→ The recorder starts recording when it detects a signal from the Satellite Receiver.

Helpful Hint:

– The recorder's timer recordings take priority over automatic satellite recording. Automatic Satellite recording stops if the recorder's timer recording is due to start.

Record TV Programme (continued)

About timer recording

Use the timer recording to automatically start and stop a recording at a later date/time. This recorder tunes to the right programme channel and begins recording at the specified time.

With this recorder, you can schedule up to **40 recordings** at a time and up to 6 (six) hours for each recording. During timer recording, changing the recorder's channel is not possible.

Note: If the scheduled timer recording is longer than 6 (six) hours, it splits into two or more titles.

There are two ways to program a timer recording

- Using the VIDEO Plus+
- Using manual timer programming

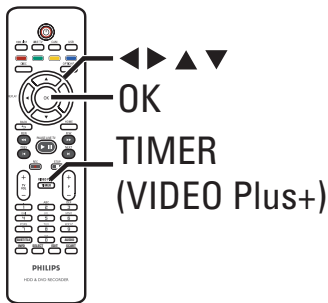

About 'VPS/PDC'

'VPS' (Video Programming System) or 'PDC' (Programme Delivery Control) is used to control the start and duration of TV channel recordings. If a TV programme starts earlier or ends later than was scheduled, this recorder will then turn on and off at the correct time.

Timer recording (VIDEO Plus+ system)

This is a simple timer programming system. To use it, enter the VIDEO Plus+ programme number associated with your television programme. You can find this number in your TV listings magazine.

- 1 Turn on the TV to the correct viewing channel for the recorder.
- 2 Press **TIMER (VIDEO Plus+)** on the remote control.
→ The timer menu appears.

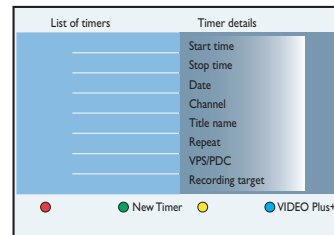

- 3 Press the **Blue** button on the remote control for { **VIDEO Plus+** }
→ The VIDEO Plus+ entry menu appears.

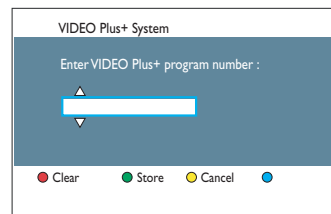

- 4 Use the **alphanumeric keypad 0-9** to enter the VIDEO Plus+ programme number (e.g. 5-312-4 or 5,312 4, key in '53124').
- To clear the programming number, press the **Red** button for { **Clear** }.

Record TV Programme (continued)

- To cancel the programming and exit the menu, press the **Yellow** button for { **Cancel** }.
- ⑤ To confirm your entry, press the **Green** button for { **Store** }.
→ A message to enter channel list appears.
- ⑥ Select { **OK** } in the menu and press **OK** to confirm.
→ The programme information appears.

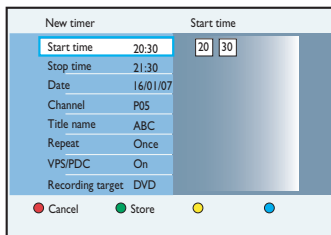

- ⑦ To change the recording settings, move to the respective field and press u.

{ Repeat }	- <u>O</u> nce - <u>W</u> eekly - <u>M</u> on~ <u>F</u> ri
{ VPS/PDC }	- <u>O</u> ff - <u>O</u> n
{ Recording target }	- <u>H</u> DD - <u>D</u> VD

- ⑧ Select a setting and press **OK**.
- ⑨ Once complete, store the setting by pressing the **Green** button for { **Store** }.
- ⑩ To exit, press **TIMER (VIDEO Plus+)**.
→ The 'TIMER' icon lights up on the display panel if a timer recording is set.

Helpful Hint:

– If the recorder is not in standby mode, a notification message appears before the timer recording begins. If you ignore the message, the recorder automatically switches to the respective channel and starts recording.

Timer recording (manually)

- ① Turn on the TV to the correct viewing channel for the recorder.
- ② Press **TIMER (VIDEO Plus+)** on the remote control.
→ The timer menu appears.

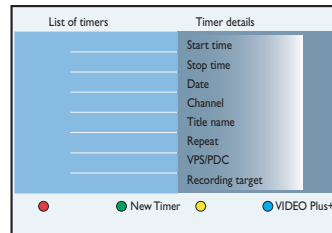

- ③ Press the **Green** button on the remote control for { **New Timer** }.
→ The new timer entry menu appears.

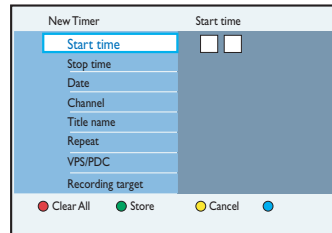

Record TV Programme (continued)

{ Start time }	Enter the start time of recording (hours : minutes).
{ Stop time }	Enter the end time of recording (hours : minutes).
{ Date }	Enter the date for recording (Day/ Month/Year).
{ Channel }	Select the TV channel or the external input channel for recording.
{ Title name }	Enter the title name for this recording.
{ Repeat }	Select a repeat recording setting (Once, Weekly, Mon~Fri).
{ VPS/PDC }	Turn on or off the VPS/PDC setting.
{ Recording target }	Select the destination for recording (HDD or DVD).

Helpful Hint:

– If the recorder is not in standby mode, a notification message appears before the timer recording begins. If you ignore the message, the recorder automatically switches to the respective channel and starts recording.

- 4 Select the entry field and press ►.
- 5 Use ▲▼ keys or the **alphanumeric keypad 0-9** to select or enter the recording information, then press **OK** to confirm.
- 6 Once complete, store the setting by pressing the **Green** button for { **Store** }.
- 7 To exit, press **TIMER (VIDEO Plus+)**.
→ The 'TIMER' icon lights up on the display panel if a timer recording is set.

Record TV Programme (continued)

Changing/Deleting a scheduled recording

- 1 Turn on the TV to the correct viewing channel for the recorder.
- 2 Press **TIMER (VIDEO Plus+)** on the remote control.
→ The timer menu appears.

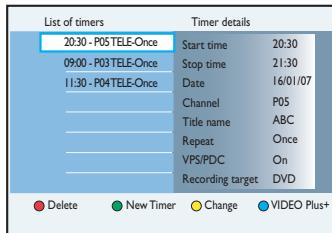

- 3 Select a scheduled recording which you want to delete or edit.
- 4 To delete the scheduled recording, press the **Red** button on the remote control for { **Delete** }.
- 5 To change the scheduled recording, press the **Yellow** button on the remote control for { **Change** }.
→ The timer entry menu appears.

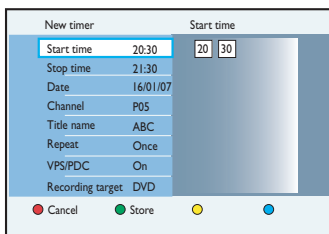

- 6 Make the necessary changes in the respective entry field.

Record from external devices

Recording from an external device (Camcorder/VCR/DVD player)

When you connect your external device to this recorder, you can choose to make a recording from the external device to the hard disk or a recordable DVD. Copy-protected material cannot be recorded on this recorder.

Before you start...

Mark the contents in the Time Shift Buffer for which you wish to record to the hard disk. Otherwise, all the contents will be cleared when you start camcorder recording.

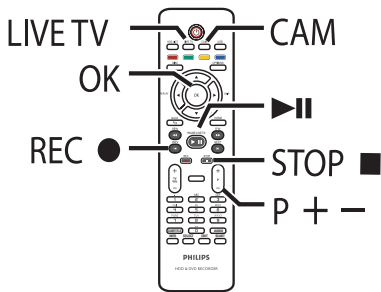

- 1 Turn on the TV to the correct viewing channel for the recorder.
- 2 Connect the external device (e.g. camcorder, VCR, DVD player) to this recorder.
- 3 Press **CAM** on the remote control.
→ A warning message appears. All the contents in the Time Shift Buffer will be cleared, only the 'marked' contents will be stored onto the hard disk.

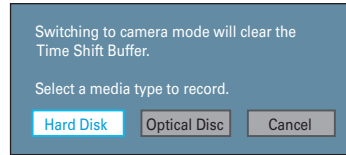

- 4 Select the destination for recording and press **OK** to confirm.
- 5 Press **P +/-** repeatedly to select the correct input channel that matches the connected socket of the device.
→ { CAM 1 } : S-VIDEO or VIDEO socket at the front.
→ { EXT 1 } : EXT1 TO TV scart socket at the back.
→ { EXT 2 } : EXT2-TO VCR/SAT scart socket at the back.
- 6 Turn on the external device and find the place where you want the recording to begin, then put the external device to pause mode.
- 7 Press **REC** ● to start recording and start the external device playback.
 - To pause the recording, press ►||.
 - To continue recording, press ►|| again.
→ A new chapter marker is created after recording restarts (for recordable DVD only).
- 8 To stop the recording, press **STOP** ■.
→ A new title will be created when you begin another recording.
- 9 To exit, press **LIVE TV**.

Helpful Hint:

– While recording from an external device to the hard disk or recordable DVD is in progress, you can press the OK button to generate chapter marker at a specific point.

Record from external devices (continued)

Recording from a DV Camcorder

When you connect a DV camcorder to the DV IN socket of this recorder, you can control both the camcorder and this recorder using the recorder's remote control. Furthermore, the smart chaptering feature ensures the chapter markers are created at each break in the images.

Before you start...

Mark the contents in the Time Shift Buffer for which you wish to record to the hard disk. Otherwise, all the contents will be cleared when you start camcorder recording.

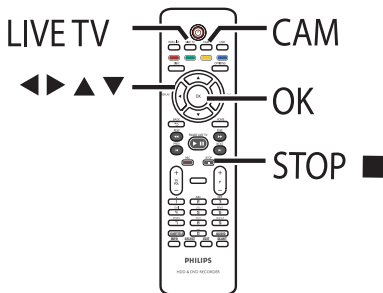

- 1 Turn on the TV to the correct viewing channel for the recorder.
- 2 Connect your Digital Video or Digital 8 camcorder to the **DV IN** socket of this recorder.

- 3 Press **CAM** on the remote control.
→ A warning message appears. All the contents in the Time Shift Buffer will be cleared, only the 'marked' contents will be stored onto the hard disk.

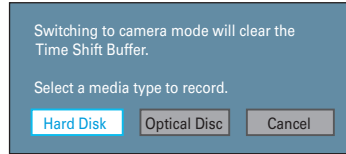

- 4 Select the destination for recording and press **OK** to confirm.
- 5 Turn on the DV camcorder and start playback.
- 6 Press **REC** ● to start recording.

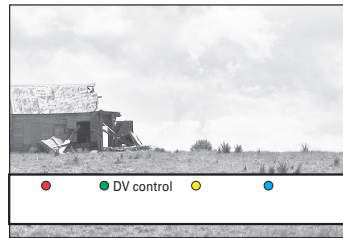

- 7 To use the recorder's remote control to control the camcorder's operation during recording, press the **Green** button on the remote control for { **DV control** }.
→ The DV control buttons display on the screen.



Record from external devices (continued)

- 8 You can navigate to the respective control keys on the screen to control the playback of your DV camcorder.
- 9 To stop the recording, press **STOP ■**.
→ Both the recorder and camcorder stop.
- 10 To exit, press **LIVE TV**.

Helpful Hints:

- *Some camcorders cannot be controlled by on-screen DV control buttons.*
- *Mixing of PAL and NTSC video format recording on a same recordable DVD is not possible.*
- *If a part of the tape is blank, the recording will pause. Recording starts automatically when there is a recordable signal. However, if there is more than 5 (five) minutes of blank tape, the recording ends automatically.*

Copy TV programmes from HDD

About copying

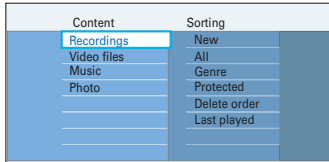

TV programmes recorded to the hard disk will be kept as 'Recordings' content. It allows you to edit your recording easily and copy to a recordable DVD for safe keeping or later viewing.

The time required for copying is depending on the recording mode that was used on the hard disk recordings. It is not possible to change the recording mode for the copying process. It is therefore important that you choose the appropriate recording mode when you set up the recording to the hard disk.

The copying process is done at a higher speed than the recording. The maximum copying speed is up to 4x. You cannot shorten the time required for recording even with high-speed discs.

Hard disk Recordable DVD

HDD recording mode	Hours of recordings can be stored in an empty 4.7GB recordable DVD	Time required for copying 1 hour of recording
HQ	1	15.0 mins
SP	2	8.0 mins
SPP	2.5	7.0 mins
LP	3	6.0 mins
EP	4	4.5 mins
SLP	6	3.5 mins
SEP	8	2.5 mins

Helpful Hint:

– If you are unable to fit a title to a recordable DVD, split the title to remove the unwanted sections. See 'Edit Recordings - Hard Disk - Video editing' for details.

Copying recordings to recordable DVD

- 1 Turn on the TV to the correct viewing channel for the recorder.
- 2 Insert a recordable DVD into the recorder.
- 3 Press **HDD LIST** on the remote control.
- 4 Use **▲▼** keys to reach the title you want, then press the **Green** button on the remote control for { **Copy** }.
→ The making disc copy information appears.

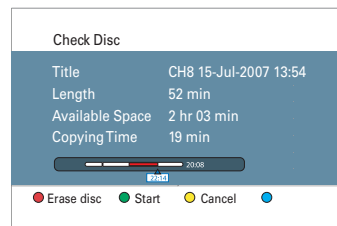

- 5 Press the **Green** button to start copy.
 - Otherwise, press the **Yellow** button to abort the operation.
 - If you are using a DVD±RW for recording, you can press **◀ / ▶** to select the space in the disc where you want the recording to be placed (e.g. the space of a deleted title).

Copy TV programmes from HDD (continued)

Changing the screen display for recordable DVD

If the recordable DVD has been used in a computer drive or in another recorder, the screen menu may not be displayed correctly.

Before you can make recording to this disc on this recorder, you must change the screen display of the disc to 'Philips' type.

- 1 Load in a recordable DVD.
- 2 Press **HOME** on the remote control.
- 3 Move to { **Disc Tray** }.

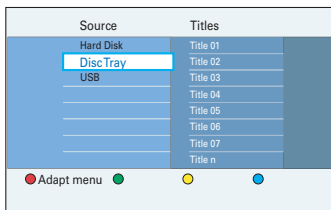

- 4 If { **Adapt menu** } appears, it means this disc has a different menu format. Press the **Red** button on the remote control.
→ A message to confirm your action appears on the TV.
- 5 Press **OK** to confirm adapt menu action.

Copy files between HDD, USB and DVD

A part of this recorder's hard disk drive can be used as a Media Jukebox, allowing you to store and playback your videos, music and photos. You can copy these files from either USB or DVD to the hard disk, from hard disk to USB and recordable DVD and even directly between USB and recordable DVD.

Note:

It is not possible to copy video or TV recordings from the hard disk to a USB device.

The Media Jukebox supports the following files:

- MP3 and Windows Media music (.mp3 and .wma)
- JPEG digital camera photos (.jpg)
- DivX movies (.avi and .divx)

Copying files from HDD to USB or recordable DVD

You can copy the files from the recorder's hard disk to your USB thumb drive or recordable DVD. When copy to USB, only data files (MP3, WMA, DivX and JPEG) are allowed.

- 1 Turn on the TV to the correct viewing channel for the recorder.
- 2 Insert a recordable DVD into the recorder or a USB thumb drive to the USB slot.
- 3 Press **HOME**.
- 4 Select the media where the files are stored and press **▶**.
- 5 Use **◀▶▲▼** keys to reach the title you want. To make multiple selection, press **SELECT**.

- 6 Press the **Green** button for { **Copy** }.
→ Media type selection screen appears.

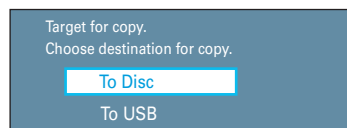

- 7 Select the destination for copying and press **OK** to confirm.
 - Otherwise, press **BACK** **↶** to return to the previous menu.
- 8 Press **OK** again to start copy.
 - Otherwise, select { **Cancel** } in the menu and press **OK** to abort the operation.

Copy files between HDD, USB and DVD (continued)

Copying files from USB to HDD or recordable DVD

You can copy the data files (MP3, WMA, DivX and JPEG) in your USB drive to this recorder's hard disk drive or recordable DVD.

- 1 Turn on the TV to the correct viewing channel for the recorder.
- 2 Connect the USB flash drive/memory card reader or digital camera to the **USB** socket at the front panel of the recorder.
- 3 Press **USB** on the remote control to view the files.
- 4 Navigate in the menu and select the files to copy. To make multiple selection, press **SELECT**.
- 5 Press the **Green** button for { **Copy** }.
→ Media type selection screen appears.

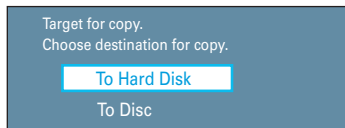

- 6 Select the destination for copying and press **OK** to confirm.
 - Otherwise, press **BACK** to return to the previous menu.
- 7 A confirmation dialogue appears, press **OK** to start copy.

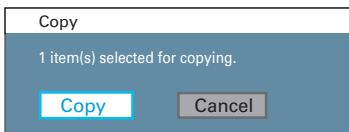

- Otherwise, select { **Cancel** } in the menu and press **OK** to abort the operation.

Copying files from CD/DVD to HDD or USB

You can copy the files in your disc to this recorder's hard disk drive or USB device. However, when copy to a USB device, only data files (MP3, WMA, DivX and JPEG) are allowed.

- 1 Turn on the TV to the correct viewing channel for the recorder.
- 2 Insert a CD/DVD into the recorder.
- 3 Press **DISC** on the remote control.
→ The disc content menu appears.
- 4 Use **◀▶▲▼** keys to reach the title you want. To make multiple selection, press **SELECT**.
- 5 Press the **Green** button for { **Copy** }.
→ Media type selection screen appears.

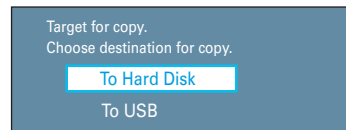

- 6 Select the destination for copying and press **OK** to confirm.
 - Otherwise, press **BACK** to return to the previous menu.
- 7 A confirmation dialogue appears, press **OK** to start copy.
 - Otherwise, select { **Cancel** } in the menu and press **OK** to abort the operation.

Helpful Hint:

– All DivX (.avi or .divx) files will be copied to the Video partition of the hard disk, while all music (.mp3 or .wma) and digital camera photos (.jpg) will be copied to the Data partition.

Playback from Hard Disk

Hard Disk navigation

The Hard Disk drive serves as a media jukebox which allows you to store all sources of recordings (TV recordings, videos, music and photos). The titles recorded or copied to the hard disk will automatically be saved under separate contents based on the characteristics of the recordings.

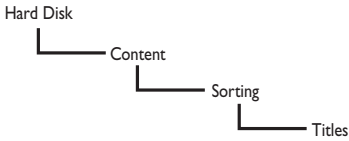

- 1 Press **HOME**.
→ The Home menu appears.

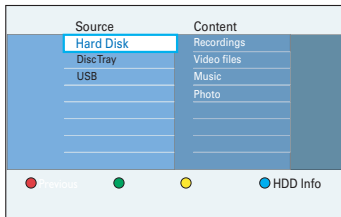

{ Recordings }
Contains recordings from the Time Shift Buffer (TV programmes).

{ Video files }
Contains only DivX or compatible video files (.avi or .divx).

{ Music }
Contains only audio files (.mp3 or .wma).

{ Photo }
Contains only picture files (.jpg or .jpeg).

- 2 Select a contents type and press **▶** to access its sorting display options.

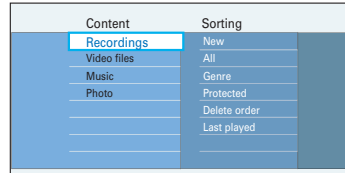

- The sorting options are varied with the kind of content selected.
- 3 Select a sorting option and press **▶** to view the titles.
 - 4 To exit the menu, press **HOME**.

Playback from Hard Disk (continued)

Basic operation

Each recording stored on the hard disk is displayed in the HDD list with an Index Picture.

- 1 Press **HDD LIST** on the remote control.

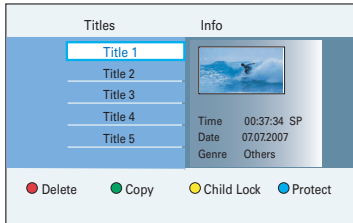



- 2 Use **▲▼** keys to reach the title you want to play, then press **▶||** to start playback.

- This recorder has resume playback ability. Playback always begins at the last stopped point. To start playback from the beginning, press **OK**.
- Symbols at the { **Info** } screen indicating:

 – title is still part of the recording in the 'Time Shift Buffer'.

 – title is locked.

 – title is protected.

 – title has been viewed.

 – title has been edited.

- 3 During playback, you can use the following buttons on the remote control to access additional playback features.

PREV ◀ / NEXT ▶

- Move to the beginning or previous/next chapter.

REW ◀◀ / FFW ▶▶

- Fast backward/forward search. Press the button again to increase the search speed (4x, 16x, 64x, 256x).
- While in pause mode, start slow motion playback.

t (REPLAY) / u (SKIP)

- Skip backward or forward in the Time Shift Buffer.

INFO

- Show or hide the title information, video bar and additional features that can be accessed via the colour coded button.

PAUSE LIVE TV ▶||

- View a still picture or resume playback.

STOP ■

- Stop playback.

- 4 To exit the menu, press **HOME**.

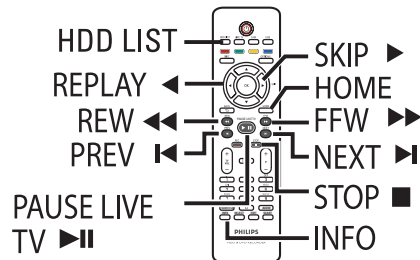

Playback from Hard Disk (continued)

Delete/Lock/Protect a title in the HDD

These options are displayed at the bottom of the hard disk title content menu.

- 1 Press **HDD LIST** on the remote control.
- 2 Use **▲▼** keys to reach the title you want.
- 3 Press the matching colour coded button on the remote control to access the options displayed at the bottom of the menu.

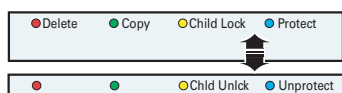

{ Delete }

Red button – Delete the selected title from the hard disk.

{ Copy }

Green button – Copy the selected title to a recordable DVD. Copy to USB device only possible for data files.

{ Child Lock } / { Chld Unlick }

Yellow button – Lock or unlock the selected title from viewing. A four-digit pin code is required to play the locked title or to unlock the title.

Note: This option only visible if the { Child lock } setting is enabled. See 'System Menu Options - Playback settings - { Access }'.

{ Protect } / { Unprotect }

Blue button – Protect or unprotect the title against editing or automatic deletion of recordings.

- 4 To exit the menu, press **HOME**.

Repeat hard disk playback

While playback the title in the hard disk, you can select to repeat playback the title or a specific segment within the title.



- Press the **Yellow** button on the remote control for { **Repeat** }.
→ The title will be played back repeatedly until you press the **Yellow** button again.
- Press the **Blue** button on the remote control for { **Repeat A-B** }.
→ The first press to mark the starting point of repeat playback and the second press to mark the ending point.
→ The marked segment will be played back repeatedly until you press the **Blue** button again.

Playback from USB device

You can view, copy or delete the contents of a USB flash drive/memory card reader or digital camera through this recorder.

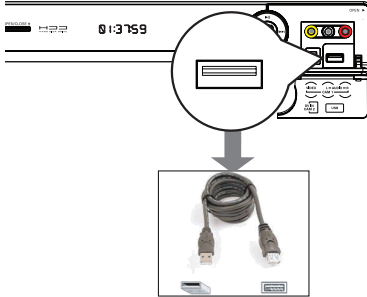

- 1 Connect the USB flash drive/memory card reader or digital camera directly to the **USB** socket on the front panel (as shown in the above illustration).
- 2 Press **USB** on the remote control to view the files.
→ The content menu appears.

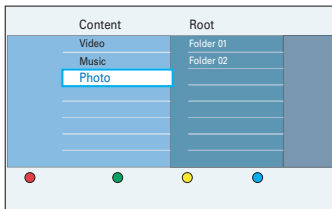

- 3 Select the file to play and press **▶||** to start playback.
- During playback, the available playback settings are displayed at the bottom of the screen.
→ For more playback information, see 'Playing an audio CD (MP3/WMA)', 'Playing a JPEG photo (slideshow)' or 'Playing a DivX disc' for details.

- 4 To stop playback, press **STOP** or remove the USB flash drive/memory card reader or digital camera from the USB socket.

Helpful Hints:

- The USB socket only supports playback and copying of JPEG/MP3/WMA/DivX files.
- The USB socket does not support the connection of other USB devices except to a USB flash drive/memory card reader or digital camera.
- When the USB device does not fit into the USB socket, a USB extension cable is required.

Playback from Disc

Playable discs

Using this recorder, you can play and record on the following discs:

Recording and Playback

DVD±RW

(DVD Rewritable);
can be recorded on
over and over.



DVD±R

(DVD Recordable);
can be recorded
only once.



DVD+R DL

(DVD+R Double Layer);
same as DVD±R.



Playback only:

DVD Video (Digital Versatile Disc)



CD-RW (CD-Rewritable)
Audio/ MP3/ JPEG contents



CD-R (CD-Recordable)
Audio/ MP3/ JPEG contents



Audio CD (Compact Disc Digital Audio)



MP3/WMA-Disc



Video CD

(Formats 1.0, 1.1, 2.0)



Super Video CD







DivX, DivX Ultra



IMPORTANT!

- If the inhibit icon 'X' or  appears on the TV screen when a button is pressed, it means the function is not available on the current disc or at the current time.
- DVD discs and players are designed with regional restrictions. Before playing a disc, make sure the disc is for the same region zone as your player.

Starting disc playback

- 1 Press **STANDBY-ON**  to turn on the recorder.
- 2 Press **OPEN CLOSE**  on the front of the recorder.
 - You can also hold down the **STOP**  button on the remote control to open and close the disc tray.
- 3 Place the disc into the tray with the label facing up, then press **OPEN CLOSE** .
 - For double-sided discs, load the side which you want to play facing up.
- 4 Turn on the TV to the correct viewing channel for the recorder.
- 5 Playback may start automatically.
 - Otherwise, press **DISC**. Navigate to the track/title to play and press **▶||**.

Helpful Hints:

- This recorder has resume playback ability (for certain type of disc). Press **PLAY** to resume playback or press **OK** to start playback from the beginning.
- If the pin code entry dialogue appears on the TV, this means that the child lock was activated for the inserted disc. You have to enter your four-digit pin code.

Playback from Disc (continued)

Playing a DVD video disc

Normally the DVD disc contains a disc menu. You may have to make your selection (e.g., subtitle or audio language) within the disc menu.

- 1 Insert a DVD.
- If the disc menu appears, use ▲▼ keys to select a play option and press **OK** to confirm or the **alphanumeric keypad 0-9** to input your selection.

To access the disc menu

- Press **DISC** on the remote control.

To select the previous or next chapter/title

- During playback, press **SELECT** on the remote control to toggle between 'TITLE' or 'CHAPTER', then press ◀ / ▶.

- 2 To stop playback, press **STOP ■**.

Playing a (Super) Video CDs

(Super) Video CDs may feature 'PBC' (Play Back Control). This allows you to play the video CDs interactively, following the menu on the display.

- 1 Insert a (Super) Video CD.
 - If the disc index menu appears, use ▲▼ keys to select a play option or use the **alphanumeric keypad 0-9** to input your selection and press **OK** to confirm.
 - To return to the previous menu, press **BACK ↵** on the remote control.
- 2 To stop playback, press **STOP ■**.

Playing a DVD recordable disc

- 1 Insert a DVD recordable disc.
 - The Index Picture screen appears.

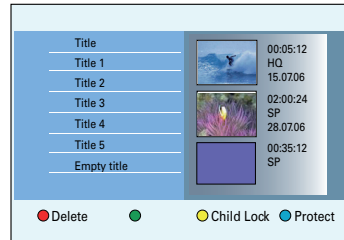

- 2 Use ▲▼ keys to select a title to play, then press ▶||.
- 3 To stop playback, press **STOP ■**.

Helpful Hint:

– If the message 'EMPTY DISC' appears on the display panel, this means that there are no recordings on this disc.

Playback from Disc (continued)

Playing an audio CD (MP3/WMA)

MP3 (MPEG1 Audio Layer-3) files are highly compressed music files. The MP3 format lets you store about ten times more data (music, pictures) on a single CD-ROM than a regular CD.

- 1 Insert an audio CD.
→ The content menu appears.
- Otherwise, press **DISC**.

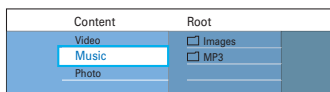

- 2 Select the audio album or track to play and press **▶▶**.

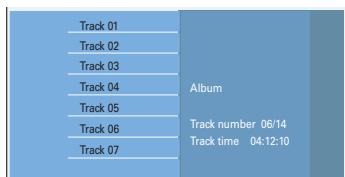

- 3 During playback, you can press **◀ / ▶** to select the next/previous track.
- 4 To stop playback, press **STOP ■**.

Helpful Hints:

- If both JPEG pictures and MP3/WMA are in the same disc, you can choose to playback the JPEG pictures or MP3/WMA by selecting { Photo } or { Music } in the menu.
- Only the first session of a multi-session CD will be played back.
- This recorder does not support MP3PRO audio format.
- If any special characters are present in the MP3 track name (ID3) or album name, it might not be displayed correctly on the screen because this recorder does not support the characters.

Playing a DivX file

See 'System Menu Options - Setup Settings - { DivX VOD }' for information on purchasing or renting movies from DivX VOD service. This recorder can only playback DivX movies which are less than 4GB.

- 1 Press **HOME**.
- 2 Select the media where the DivX file is stored and press **▶**.
- 3 Select { **Video** } in the content menu.
- 4 Use **◀▶▲▼** keys to reach the title you want to play, then press **▶▶** to start playback.

During playback, you can;

- If multilingual subtitles are available on the DivX disc, you can press **SUBTITLE** on the remote control to change the subtitle language.
- If the DivX title provides different audio tracks, you can press **AUDIO** on the remote control to change the audio stream.
- To select the font type that supports the recorded subtitle:
 - 1) Press **OPTIONS**.
 - 2) Move to { **Character set** } in the menu and press **▶**.
 - 3) Make your selection and press **OK**.
- 5 To stop playback, press **STOP ■**.

Helpful Hints:

- Subtitle files with the following file name extensions (.srt, .smi, .sub, .ssa, .ass) are supported but do not appear on the file navigation menu.
- The subtitle file name has to be the same as the file name of the movie.
- The subtitle can only be displayed up to an average of 45 characters.

Additional Playback Features

Playing JPEG photo files (slide show)

- 1 Press **HOME**.

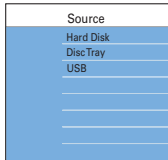

- 2 Select the media where the JPEG photos are stored and press **▶**.

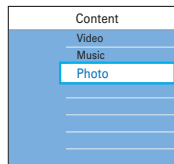

- 3 Select **{ Photo }** in the menu and press **▶**.

- From Hard Disk only, **{ Photo folders }** and **{ Photo albums }** options appear. Press **▶** again to select the option you want the photo files to appear.

Note: **{ Photo albums }** option is not available on optical disc and USB.

- 4 Press **▶** repeatedly until a list of photo file names appear.
→ The first 4 photos found in the currently selected folder will be displayed at the right hand panel.

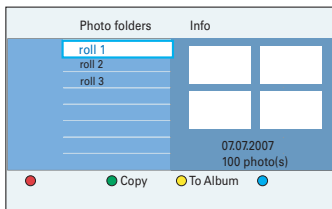

- 5 Select a file and press **▶||** to start the slide show playback or press **OK** to show the overview images.
- During playback, the available playback settings are displayed at the bottom of the screen.

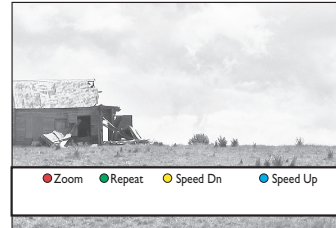

{ Zoom }

Red button – Activate zoom mode. The slideshow playback will pause.

{ Zoom In }	Blue button: enlarge the picture.
{ Zoom Out }	Yellow button: revert to the actual size.
{ End }	Red button: exit zoom mode and continue slideshow playback.

{ Repeat }

Green button – Toggle between repeat on and off.

{ Speed Dn } / { Speed Up }

Yellow and Blue buttons – Change the slideshow playback speed.

{ Slow }	10 (ten) seconds interval.
{ Medium }	5 (five) seconds interval.
{ Fast }	3 (three) seconds interval.

- 6 To stop playback, press **STOP ■**.

Additional Playback Features (continued)

Helpful Hints:

- If both JPEG photos and MP3s are in the same disc, you can choose to playback the JPEG photos or MP3s by selecting { Photo } or { Music } in the menu.
- If the JPEG photo is not recorded with an 'exif' type file, the actual thumbnail picture will not be shown on the display. It will be replaced with a 'blue mountain' thumbnail picture.
- Some types of JPEG file cannot be played on this recorder.
- It may require longer time for the recorder to display the disc content on the TV due to the large number of songs/pictures compiled into one disc.
- Unreadable disc or disc with no name will be displayed as 'Unknown Data'.
- During JPEG photo playback, pressing **OPTIONS** button switches to live TV mode.

Supported JPEG picture formats

File format:

- The file extension has to be '*.JPG' and '*.JPEG'.
- This recorder can only display digital camera pictures according to the JPEG-EXIF format, typically used by almost all digital cameras. It cannot display Motion JPEG, progressive JPEG and other JPEG formats, or pictures in formats other than JPEG, or sound clips associated with pictures.
- The JPEG photos with resolution more than 13 megapixel cannot be supported.

Playing musical slideshow

This is only possible if both the JPEG photo files and music are stored in the same media.

- 1 Press **HOME**.
- 2 Select the media where the music are stored and press ►.



- 3 Select { **Music** } in the menu and press ►.
- 4 Use ◀▶▲▼ keys to reach the folder/file you want to play, then press ►|| to start playback.

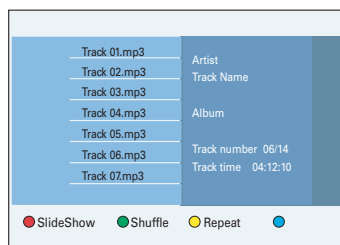

- 5 Press the **Red** button on the remote control for { **SlideShow** }.
→ The { **Photo Content** } menu appears.
- 6 Select a photo file and press ►|| to start slideshow playback.
→ The music keeps playing back and will be repeated if reaches the end of the playlist or track.
- 7 Press **STOP** ■ to stop the slideshow.

Additional Playback Features (continued)

Creating a photo playlist (album)

You can customise the JPEG photos slideshow playback by storing your selection in an album.

This recorder can handle up to a maximum of 100 albums. Each album can contain up to 100 images.

Note:

This feature is only available for photos stored in the Hard Disk.

- 1 Press **HOME**.
- 2 Select { **Hard Disk** } in the menu and press **▶**.
- 3 Move to { **Photo** } > { **Photo folders** } in the menu, then press **▶**.

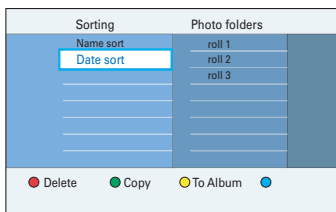

- 4 To select all the photos in the selected folder, press **SELECT** on the remote control.
- 5 To select a specific photos in the folder, press **OK** to show the overview images.

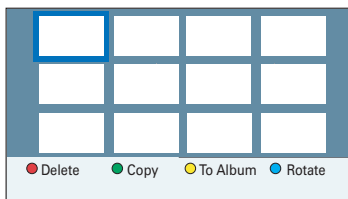

- 6 Use **◀▶▲▼** keys to navigate and press **SELECT** to select the photo.
→ A marking appears on the top right hand corner of the selected photo(s).
- 7 To delete a photo or the selected photo(s), press the **Red** button for { **Delete** }.
- 7 Press the **Yellow** button on the remote control for { **To Album** }.
→ The { Add Photo to Album } menu appears.
- 8 Create a new album or select an existing album, then press **OK** to add the photo(s) to it.
→ The selected photos are now stored in the album.
- 9 To exit the menu, press **HOME**.

Additional Playback Features (continued)

Editing the album

You can re-arrange the photo position in the album in order to create the desired slideshow playback order, or remove the photo(s) from the album. However, the photos in the 'Photo folders' remain unchanged.

Note:

This feature is only available for photos stored in the Hard Disk.

- 1 Press **HOME**.
- 2 Select { **Hard Disk** } in the menu and press **▶**.
- 3 Move to { **Photo** } > { **Photo albums** } in the menu, then press **▶**.
→ A list of photo albums appears.

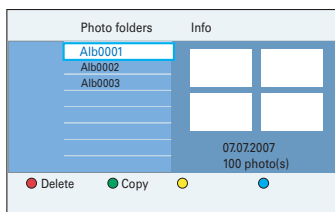

- 4 Use **▲▼** keys to select an album and press **OK** to view the overview images.

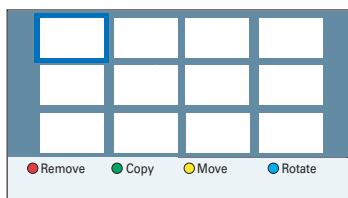

- 5 Use **◀▶▲▼** keys to navigate and press **SELECT** to select the photo.
→ A marking appears on the top right hand corner of the selected photo(s).

To change the photo(s) position in the album

- 6 Press the **Yellow** button on the remote control for { **Move** }.
→ A 'navigator' appears in the menu, it enables you to select the position between the photos.
- 7 Use **◀▶▲▼** keys to move the 'navigator' around the menu and press **OK** to confirm the position where you want to insert the photo(s).

To rotate the selected photo(s)

- 8 Press the **Blue** button for { **Rotate** }.
→ The photo rotates in 90 degree clockwise increments for each press.

To remove the photo(s) from the album

- Press the **Red** button for { **Remove** }.
- 9 To exit the menu, press **HOME**.

Deleting an album

- 1 Select an album from the { **Photo albums** } list.
- 2 Press the **Red** button for { **Delete** }.

Changing the album information

- 1 Select an album from the { **Photo albums** } list.
- 2 Press **EDIT** on the remote control.
- 3 Make the necessary changes on the respective fields (name or date) and press **OK** and **EDIT** to exit the menu.

Additional Playback Features (continued)

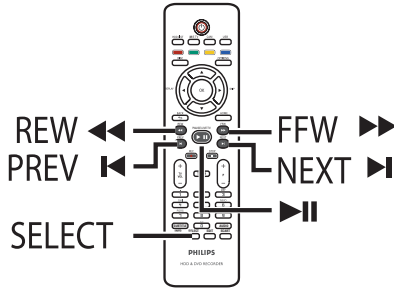

Selecting another title/ chapter/ track

When a disc contains more than one track, title or chapter, you can change to a different track, title or chapter as follows.

During playback,

- Press ► to go to the next title/chapter/ track.
- Press ◀ to return to the start of the current title/chapter/track.
- Pressing ◀ twice can return to the start of the previous title/chapter/track.

OR

- Use the **alphanumeric keypad 0-9** to input the title/chapter/track number.

OR

- Press **SELECT** on the remote control to toggle between 'Title' or 'Chapter', then press ◀ / ► to select the previous or next title/ chapter.

Searching forwards/ backwards

You can fast forward or fast reverse a disc during playback and select a desired search speed.

- 1 During playback, press ◀◀ (reverse) or ▶▶ (forward) until the search speed status bar (4X) appears on the TV.
→ The sound will be muted.
- 2 Press ◀◀ (reverse) or ▶▶ (forward) repeatedly to cycle through the different search speed (4X, 8X, 32X).
- 3 To resume normal playback, press ▶▶.

Pausing playback / slow motion play

- 1 During playback, press ▶▶ to pause playback and display a still picture.
- 2 Press ◀◀ (reverse) or ▶▶ (forward) until the slow motion status bar (1/8X) appears on the TV.
→ The sound will be muted.
- 3 Press the ◀◀ (reverse) or ▶▶ (forward) repeatedly to cycle through the different slow motion speed (1/8X, 1/4X, 1/2X).
- 4 To resume normal playback, press ▶▶.

Additional Playback Features (continued)

During disc playback, press **INFO** on the remote control to display the available playback options. These options are varied depending on the disc type and can be selected by pressing the matching colour coded buttons on the remote control.



Scan disc

(for CD, VCD, DVD±R/±RW disc only)
This function allows you to preview the first 10 seconds of each track on the disc.

- 1 During playback, press the **Red** button on the remote control.
→ The recorder skips to the next track after 10 seconds of playback.
- 2 To resume normal playback, press the **Red** button again.

Shuffle play

(for CD, MP3 disc only)
Select shuffle play mode to allow the recorder to randomly select and play tracks on the disc.

- 1 Press the **Green** button on the remote control.
→ It starts play back of all the tracks within the folder in a random order.
- 2 To cancel shuffle playback, press the **Green** button again.

Repeat play

The repeat play options vary depending on the disc type.

- 1 During playback, press the **Yellow** button on the remote control to select one of the repeat options.
→ Repeat chapter (DVD, DVD±R/±RW only)
→ Repeat track/title
→ Repeat folder/playlist (if applicable)
→ Repeat entire disc (video CD, audio CD, DVD±R/±RW only)
- 2 To cancel repeat playback, press the **Yellow** button repeatedly until the repeat mode is off or press **STOP** ■.

Repeat playback a specific segment (A-B)

You can repeat the playback of a specific segment within a title/chapter track. To do this, you must mark the start and end of the segment you want.

- 1 During playback, press the **Blue** button on the remote control.
→ This indicates that the start point has been marked.
- 2 Press the **Blue** button again to mark the end of the segment.
→ A visual marker is placed on the programme bar.
→ Playback skips to the start of the marked segment. The segment is repeated until the repeat mode is cancelled.
- 3 To cancel repeat playback, press the **Blue** button once again.

Additional Playback Features (continued)

Using the Toolbar options

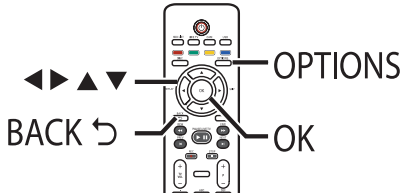

- 1 During playback, press **OPTIONS** on the remote control.
→ The available options might differ depending on the state of playback or media type.

During HDD playback:

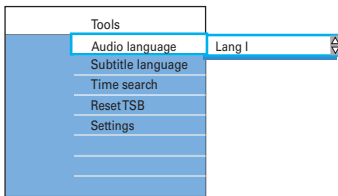

During disc playback:

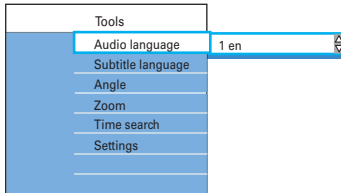

- 2 Use **▲ ▼** keys to select a setting.
- 3 Press **▶** to enter its options.
→ Instructions and explanations of the options are provided in the following pages.
→ If the selection in the menu is greyed out, that means the feature is not available or cannot be changed in the current state.
- 4 To exit, press **OPTIONS**.

Note:

Select { **Settings** } to access the system setup menu options. See 'System Menu Options' for details.

Clearing the Time Shift Buffer

This option is only available while in live TV mode.

- 1 Move to { **Reset TSB** } and press **▶**.
- 2 Press **OK**.
→ A warning message appears.
- 3 To proceed, select { **Yes** } in the menu and press **OK** on the remote control.
→ The contents in the Time Shift Buffer (TSB) will be cleared.

Changing audio soundtrack language

This operation works only on DVDs with multiple soundtrack language, or VCDs with multiple audio channel, or DVD±R/±RW recorded with 5.1 multi-channel.

- 1 Move to { **Audio language** } and press **▶** to enter its options.
- 2 Press **▼** repeatedly until the audio language or soundtrack you want is selected.
→ The languages may be numbered or abbreviated, such as 'en' for English.
→ { Lang I } is the original broadcast language and { Lang II } is the additional broadcast language.
- 3 Press **◀** to confirm.

Helpful Hint:

– While in disc playback mode, you can also press the **AUDIO** on the remote control repeatedly to select different audio language.

Additional Playback Features (continued)

Changing subtitle language

This operation works only on DVDs with multiple subtitle languages. You can change to the language you want while playing DVD.

- 1 Move to { **Subtitle language** } and press ► to enter its options.
- 2 Press ▼ repeatedly until the language you want is selected.
→ The languages may be numbered or abbreviated, such as 'en' for English.
- 3 Press ◀ to confirm.

Helpful Hint:

– While in disc playback mode, you can also press the **SUBTITLE** on the remote control repeatedly to select different subtitle language.

Switching camera angles

This option is only available with DVDs that contain sequences recorded from different camera angles. This allows you to view the picture from different angles.

- 1 Move to { **Angle** } and press ► to enter its options.
→ The camera angles available for selection appear.
- 2 Select the camera angle you want to switch to and press ◀ to confirm.

Zooming in/out

This option only available on DVDs and recordable DVDs playback. It allows you to enlarge the picture on the TV screen and to pan through the enlarged picture.

- 1 Move to { **Zoom** } and press **OK** to enter zoom in mode.
→ The zoom status bar appears and displays the zoom factor.

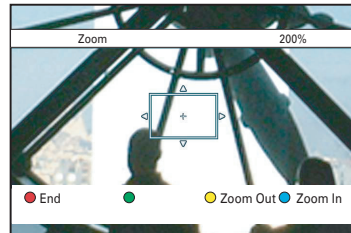

- 2 Press the **Blue** button on the remote control to zoom in or **Yellow** button to zoom out.
- 3 Use ◀ ▶ ▲ ▼ keys to pan through the zoomed picture.
- 4 To exit zoom mode, press the **Red** button.

Searching by time

This option allows you to skip to a specific point in the current disc or a specific time in the Time Shift Buffer.

- 1 Move to { **Time search** } and press ► to enter the time field (hours : minutes : seconds).
- 2 Use the **alphanumeric keypad 0-9** to enter the time where playback should start.
- 3 Press **OK** to confirm.
→ Playback skips to the time entered.

Edit Recordings - Hard Disk

Changing the title name

Some TV channels transmit the name of the programme. In this case, the programme name will automatically be stored when recording to the hard disk. Otherwise, only the programme number and date/time of the recording will be stored as title name.

- 1 Press **HDD LIST** on the remote control.

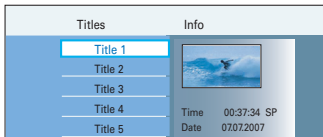

- 2 Use **▲▼** keys to reach the title you want.
- 3 Press **EDIT** on the remote control.
→ The HDD edit menu appears.



- 4 Move to { **Title name** } in the menu and press **▶**.
- 5 Use **▲▼** keys to change the character/number or make an entry by using the **alphanumeric keypad 0-9**.
→ Use **◀▶** keys to move to the previous or next field.
 - To switch between upper and lower case characters, press **SELECT**.
 - To clear the title name, press the **Red** button for { **Clear** }.
- 6 Press **OK** to confirm the changes.

Selecting the genre

You may select the genre type provided in the list for easy and fast searching of a recorded title.

- 1 Press **HDD LIST** on the remote control.
- 2 Use **▲▼** keys to reach the title you want.
- 3 Press **EDIT** on the remote control.
→ The HDD edit menu appears.



- 4 Move to { **Genre** } in the menu and press **▶**.
- 5 Select a genre type and press **◀** to confirm.

Edit Recordings - Hard Disk (continued)

Video editing

This recorder allows you to edit the video content after a recording has been made. You can insert/delete chapter markers or hide unwanted scenes.

When you play back a recording in video edit mode, the entire recording will be played back including the hidden scenes.

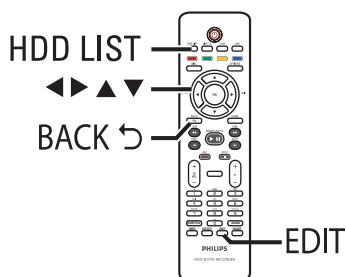

- 1 Press **HDD LIST** on the remote control.
- 2 Use **▲▼** keys to reach the title you want.
- 3 Press **EDIT** on the remote control.
→ The HDD edit menu appears.

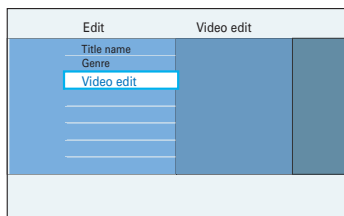

- 4 Move to { **Video edit** } and press **OK** to start video edit playback.

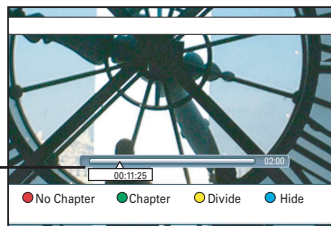

Video bar:

In the video bar, the record playback head represents the actual position of the playback.

- 5 Press the matching colour coded buttons on the remote control to access the options displayed at the bottom of the menu.

{ **No Chapter** }

Red button – Erase all the chapter markers in the current title.

{ **Chapter** }

Green button – Access chapter editing menu.

{ **Divide** }

Yellow button – Divide the recording into two separate titles.

{ **Hide** } / { **Stop Hide** }

Blue and Green buttons – Define the scene to hide.

{ **Show** } / { **Stop Show** }

Blue and Green buttons – Make the hidden scene visible.

- 6 To exit, press **EDIT**.

Helpful Hint:

– The edited title will be appeared with ✂ symbol in the menu.

Edit Recordings - Hard Disk (continued)

Merge/split a specific chapter within a recording

You can create a chapter by inserting chapter marker (using the SPLIT option) or remove a chapter marker (using the MERGE option).

- During hard disk recording playback, press **▶||** to pause playback at the scene where you want to edit.
- Use **◀◀ / ▶▶** keys or **◀ / ▶** keys on the remote control for fast reverse or forward search.
- Press the **Green** button on the remote control for **{ Chapter }**.
→ The chapter editing menu appears.

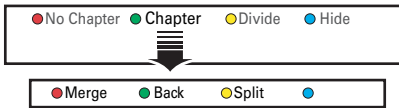

- Press the matching colour coded buttons on the remote control to access the options displayed at the bottom of the menu.

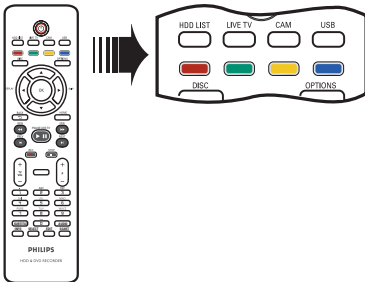

{ Merge }

Merge the current chapter with the chapter before it.

Note: If the previous chapter was selected to be hidden, then the joined chapter will also be hidden.

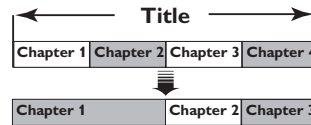

(for example, chapter 2 is selected)

{ Back }

Return to the previous screen.

{ Split }

Insert a new chapter marker at the current point of playback. This allows you to access a specific point in the recording easily or set a chapter you wish to hide (for example, commercial scenes).

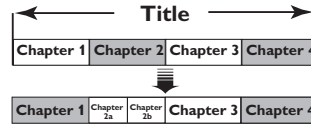

(for example, chapter 2 is selected)

Helpful Hint:

– There is a limit on chapter markers that can be stored within a title and on the hard disk drive.

Edit Recordings - Hard Disk (continued)

Dividing titles

You can divide a title into two or more titles. You can use this function to separate and delete undesired portions of a recording, such as commercials.

CAUTION!

Once a title has been divided, it cannot be reversed.

- 1 During hard disk recording playback, press **▶||** to pause playback at the scene where you want to edit.

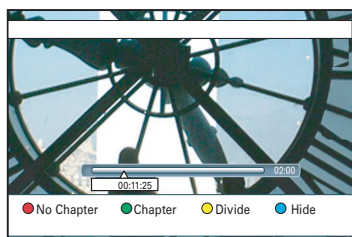

- Use **◀◀ / ▶▶** or **◀ / ▶** keys on the remote control for fast reverse or forward search.
- 2 Press **EDIT** on the remote control.
- 3 Press the **Yellow** button on the remote control for { **Divide** }.
→ A new title and new Index Picture will be created from the current point of playback.

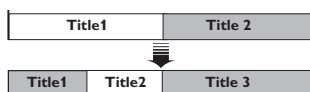

(for example, title 1 is selected)

Hiding unwanted scenes

You can choose to hide certain scenes for playback (e.g., skipping a commercial scene) or make the hidden scene visible again.

- 1 During hard disk recording playback, press **▶||** to pause playback at the scene where you want to edit.
- Use **◀◀ / ▶▶** keys or **◀ / ▶** keys on the remote control for fast reverse or forward search.

- 2 Press **EDIT** on the remote control.
- 3 Press the **Blue** button on the remote control for { **Hide** }.
→ It sets the start marker for hide.

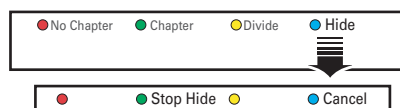

- 4 Press **▶▶** key on the remote control to search for the end of the scene to hide.
- 5 Press the **Green** button for { **Stop Hide** }.
→ It sets the end marker for hide.
→ The 'hidden' area will be marked in blue.
- Otherwise, cancel the operation by pressing the **Blue** button on the remote control for { **Cancel** }.
- 6 To exit, press **EDIT**.

Edit Recordings - Hard Disk (continued)

Showing the hidden scene

- 1 During hard disk recording playback, press **EDIT** on the remote control.
→ The hidden chapter will be played back while in video editing mode



Hidden scenes

- 2 Press the **Blue** button on the remote control for { **Show** }.
→ It marks the beginning of scene to show.
- 3 Press **▶▶** on the remote control to search for the end of the scene to show.
- 4 Press the **Green** button for { **Stop Show** }.
- Otherwise, cancel the operation by pressing the **Blue** button on the remote control for { **Cancel** }.

Helpful Hints:

- All the hidden chapters will be played back while in video editing mode.
- The selection of scenes to hide or show can only be done within a title.

Deleting all chapter markers

During recording, the chapter marker is set automatically at a specific interval if the function is active. You can choose to delete all the chapter markers when the recording has finished.

- 1 During hard disk recording playback, press **EDIT** on the remote control.

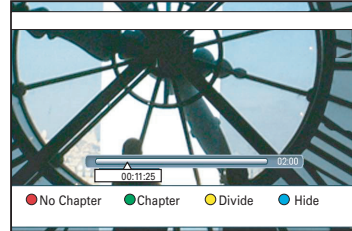

- 2 Press the **Red** button on the remote control for { **No Chapter** }.
→ All the chapter markers in the current title will be deleted.

Edit Recordings - Recordable DVD

About editing recordable DVDs

This recorder offers various disc edit options. You can change the disc content and settings of a recorded DVD from the editing menu. If a DVD±R has been finalised, it cannot be edited. The edited contents may not be available if you play the disc on another DVD player.

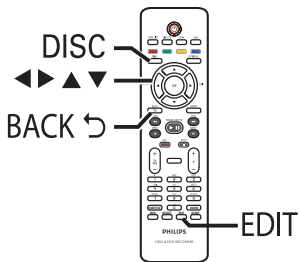

The displayed options in the editing menu differ depending on the situation and disc type.

- Change disc name
- Make DVD compatible (DVD±RW only)
- Finalise disc (DVD±R only)
- Change title name
- Delete all titles
- Video editing



Index Picture screen

The Index Picture screen shows your recordings on a recordable DVD. It appears on the TV once you load a recordable DVD or when playback is stopped.

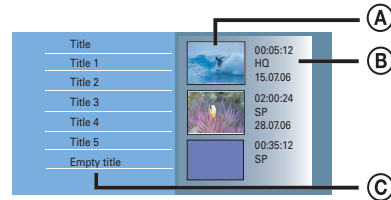

An Index Picture screen represents each recording information save :

- (A) The title's Index Picture.
- (B) The title's information (length of recording, record mode and date).
- (C) The empty space for recording.

Helpful Hint:

- If the disc is not recorded from this recorder, the format of Index Picture screen might be different. You have to adapt the disc menu to the format of this recorder before editing. See 'About Home - Changing the disc format for recordable DVD' for details.

Edit Recordings - Recordable DVD (continued)

Changing the disc/title name

The original disc/title name is generated automatically by the recorder. You can change the disc/title name by following the steps below.

- 1 Insert a recorded DVD into the recorder.
→ The Index Picture screen appears.
- 2 Press **EDIT** on the remote control.
→ The editing menu appears.
- 3 Move to { **Disc name** } or { **Title name** } in the menu and press **▶**.
- 4 Use **▲ ▼** keys to change the character/number or make an entry by using the **alphanumeric keypad 0-9**.
→ Use **◀ ▶** keys to move to the previous or next field.
- To switch between upper and lower case characters, press **SELECT** on the remote control.
- 5 Press **OK** to confirm the changes.

Making the edited DVD±RW compatible

The edited DVD±RW may still display the original titles or hidden scenes when played back on other DVD players. This function allows you to make an edited DVD±RW compatible with other players.

- 1 Insert a recorded DVD±RW into the recorder.
→ The Index Picture screen appears.
- 2 Press **EDIT** on the remote control.
→ The editing menu appears.
- 3 Move to { **Compatible** } and press **OK**.
→ If the option is not available for selection, it means that the disc is already compatible.
- 4 Press **OK** to proceed.

Deleting all recordings/titles

Allows you to delete all the recordings from the current recordable DVD.

- 1 Insert a recorded DVD into the recorder.
→ The Index Picture screen appears.
- 2 Press **EDIT** on the remote control.
→ The editing menu appears.
- 3 Move to { **Delete all** } and press **OK**.
→ A warning message appears.
- 4 To proceed, select { **Erase** } in the menu and press **OK** on the remote control.
- Otherwise, select { **Cancel** } in the menu and press **OK** to abort the operation.

Edit Recordings - Recordable DVD (continued)

Finalising the DVD±R for playback

It is necessary to finalise a DVD±R or DVD±R (DL) disc before you can play it on another DVD player. Otherwise, the DVD±R can only be played back on this recorder.

Note:

After a DVD±R disc has been finalised, no further recordings or editing can be made to it. Make sure that you have completed all the recordings and editing before finalising the disc.

- 1 Insert a recorded DVD±R into the recorder.
→ The Index Picture screen appears.
- Otherwise, press **DISC**.
- 2 Press **EDIT** on the remote control.
→ The edit menu appears.
- 3 Move to { **Finalise** } and press **OK**.
→ A warning message appears.
- 4 To proceed, select { **Finalise** } in the menu and press **OK** on the remote control.
→ Finalisation may take more than 30 minutes, depending on the length of recordings.
→ Do not try to open the disc tray or turn the power off as this may render the disc unusable.
- Otherwise, select { **Cancel** } in the menu and press **OK** to abort the operation.

Deleting a recording/title

You can delete a specific title from the disc. However, for DVD±R discs, the deleted space cannot be used for further recordings.

- 1 Insert a recorded DVD into the recorder.
→ The Index Picture screen appears.
- Otherwise, press **DISC**.
- 2 Use ◀▶▲▼ keys to reach the title you want.

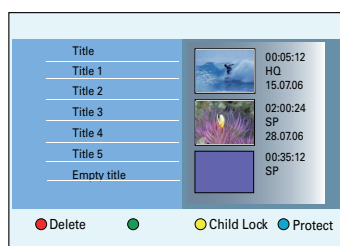

- 3 Press the **Red** button on the remote control for { **Delete** }.
→ A warning message appears.
- 4 To proceed, select { **Delete** } in the menu and press **OK** on the remote control.
→ For DVD±RW disc, 'Empty Title' will be appeared in the Index Picture screen where the title was deleted. The empty space can be used for new recordings.
→ For DVD±R disc, 'Deleted title' will be appeared in the Index Picture screen where the title was deleted. During playback, the deleted title will be skipped.
- Otherwise, select { **Cancel** } in the menu and press **OK** to abort the operation.

Edit Recordings - Recordable DVD (continued)

Lock/Unlock the disc for playback

You can choose to lock the recorded disc from viewing.

Before you start ...

Turn on the Child Lock feature. See 'System Menu Options - Playback settings - Access - Child lock' for details.

- ① Insert a recorded DVD into the recorder.
→ The Index Picture screen appears.
- Otherwise, press **DISC**.
- ② Press the **Yellow** button on the remote control for { **Child Lock** }.

Note:

Once the disc is locked, a four-digit pin code is required to play the disc or to unlock the disc.

Protecting the recorded titles (DVD±RW)

You can choose to protect the recorded title on a DVD±RW in order to prevent the recordings from being accidentally erased or edited.

- ① Insert a recorded DVD±RW into the recorder.
→ The Index Picture screen appears.
- Otherwise, press **DISC**.
- ② Use ◀▶▲▼ keys to reach the title you want.
- ③ Press the **Blue** button on the remote control for { **Protect** }.

Note:

Once the title has been protected, the Blue button option changes to { **Unprotect** }. Select this to cancel the protect setting if required.



Edit Recordings - Recordable DVD (continued)

Video editing

This recorder allows you to edit the video content after a recording has been made. You can add/delete chapter marker or hide unwanted scenes.

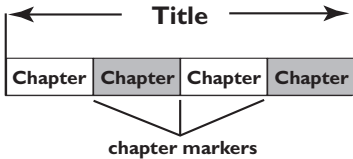

When you play back a recording in video edit mode, the entire recording will be played back including the hidden scenes.

- 1 Insert a recorded DVD into the recorder.
→ The Index Picture screen appears.
- Otherwise, press **DISC**.
- 2 Use ◀▶▲▼ keys to reach the title you want, then press ▶▶ to start playback.
- 3 Use ◀◀ / ▶▶ keys or ◀ / ▶ keys on the remote control to search for the scene you want to edit, then press ▶▶ to pause playback.
- 4 Press **EDIT** on the remote control.
→ The video editing menu appears.

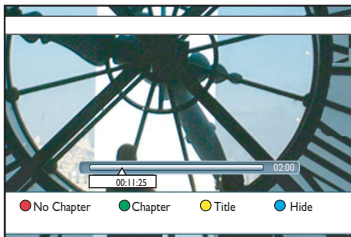

- 5 Press the matching colour coded buttons on the remote control to access the options displayed at the bottom of the menu.

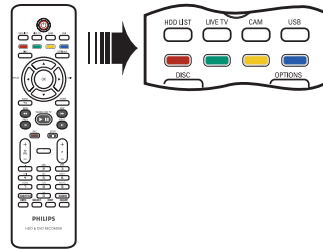

{ No Chapter }

Red button – Erase all the chapter markers in the current title.

{ Chapter }

Green button – Access chapter editing menu.

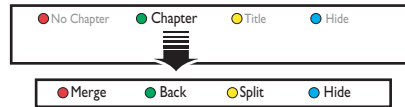

{ Merge }

Merge the current chapter with the chapter before it.

Note: If the two chapters were hidden, then the joined chapter will also be hidden.

{ Back }

Return to the previous screen.

{ Split }

Insert a new chapter marker at the current point of playback. This allows you to access a specific point in the recording easily or set a chapter you wish to hide.

{ Hide } / { Show }

Hide or show the current chapter. During playback, the hidden chapter will be skipped.

Edit Recordings - Recordable DVD (continued)

{ Title }

Yellow button – Access title editing menu.

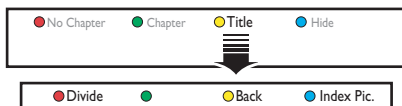

{ Divide } for DVD±RW only

Create a new title from the current point of playback. The existing title will be divided into two titles.

Caution! Once a title has been divided, it cannot be reversed.

{ Back }

Return to the previous screen.

{ Index Pic }

Use the current scene as the Index Picture.

Note: In the Index Picture screen, normally the first frame of a recording is shown as the title's Index Picture.

{ Hide } / { Show }

Blue button – Hide or show the current chapter.

Helpful Hints:

- All the hidden chapters will be played back while in video editing mode.
- The selection of scenes to hide or show can only be done within a title.
- There is a limit on chapter markers that can be stored within a title and the hard disk drive.

System Menu Options

System menu navigation

The system menu provides various setup options for your recorder.

Before you start ...

Mark the contents in the Time Shift Buffer for which you wish to record to the hard disk. Otherwise, all the contents will be cleared when you access { **Tuner** } or { **Set up** } option.

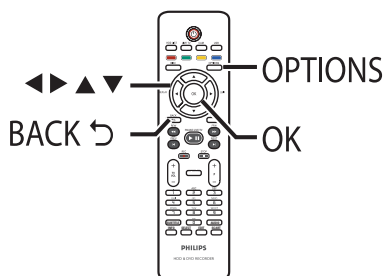

- 3 Use ▲▼◀▶ keys to move the selection bar up/down/left/right to cycle through the menu options.
→ Instructions and explanations of the options are provided in the following pages.
→ If the selection in the menu is greyed out, that means the feature is not available or cannot be changed in the current state.
- 4 Press **OK** to confirm the selection or new setting.
 - To return to the previous menu screen, press ◀.
- 5 To exit, press **OPTIONS**.

Note:

For { **Recording** } setting, see 'Before Recording - Default Recording settings' for details.

- 1 Press **OPTIONS** on the remote control.
→ The tools menu appears.

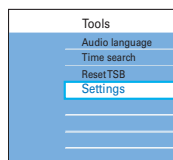

- 2 Move to { **Settings** } and press **OK**.
→ The system settings menu appears.

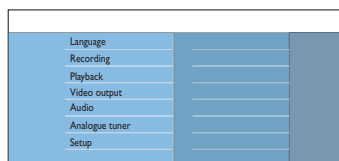

System Menu Options (continued)

Language settings (underlined options are the factory default settings)

Audio language

Select the preferred audio language for DVDs with multiple sound tracks, VCDs with multiple audio channels, or DVD±R/±RW recorded with 5.1 multi-channel.

Subtitle language

Select the preferred subtitle language for DVD playback.

Notes:

- If the selected audio/subtitle language is not available on the disc, the disc's default language will be used instead.
- For some DVDs, the subtitle/audio language can only be changed via the DVD disc menu.

Dual language

Select the recording language to be used for TV programmes (analogue TV channels only) which are transmitted an additional audio language. For example, if a programme is available in English and Spanish, with Spanish being the additional language option.

{ Lang. I } – Original broadcast language.

{ Lang. II } – Additional audio language.

Menu language

Select the menu language for this unit's on-screen display. This setting will be taken from the initial installation.

System Menu Options (continued)

Playback settings (underlined options are the factory default settings)

Access

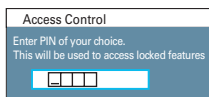

When this is selected, you will be prompted to enter the four-digit pin code.

Notes:

- When doing this for the first time, use the alphanumeric keypad 0-9 on the remote control to enter any four-digit pin code you prefer.
- If you forget your four-digit pin code, key in '1504'. Then enter any four-digit you prefer and enter the same pin code again to confirm it.

Child lock:

With this feature, you can prevent children from viewing certain discs or the recorded titles in the hard disk.

- { On } – Enable child lock function.
A four-digit pin code must be entered in order to play the locked disc or title in the hard disk.
- { Off } – All discs can be played.

Notes:

- This recorder can memorise settings for 50 discs.
- When this feature is enabled, it appears as { Child Lock } at the bottom of the coloured options screen whenever you select a title in the content menu. You can press the **Yellow** button on the remote control to set the child lock on or off.

Change PIN:

Set a new pin code. Follow the instructions in the menu to change the pin code.

Note: To cancel the change, press **BACK** on the remote control.

Display

OSD:

Set the level of on-screen display information.

- { Full } – Complete information is always displayed during use.
- { Reduced } – The help text and colour button bar will be removed from the display.

Front panel brightness:

Set the front panel display brightness.

- { Bright } – Normal brightness.
- { Dimmed } – Medium brightness.
- { Off } – Turn off the display.

System Menu Options (continued)

Playback settings (underlined options are the factory default settings)

PBC Play Back Control feature is only applicable for VCD/SVCD only. It allows you to play Video CDs (2.0) interactively, following the menu on the display.

- { Off } – The VCD/SVCD skips the index menu and playback directly from the beginning.
- { On } – The index menu (if available) appears on the TV when you load a VCD/SVCD.

Note: This option is not visible unless a VCD/SVCD is in the disc tray.

Replay interval Set the replay interval (minutes : seconds) and press **OK** to confirm. The maximum setting is 59 minutes and 59 seconds. In live TV mode, use ◀ key on the remote control to do the skip backward playback.

Skip interval Set the skip interval (minutes : seconds) and press **OK** to confirm. The maximum setting is 59 minutes and 59 seconds. In live TV mode, use ▶ key on the remote control to do the skip ahead playback.

System Menu Options (continued)

Video Output settings (underlined options are the factory default settings)

TV shape

The picture shape can be adjusted to fit your TV.

{ **4:3 Letterbox** } – For a ‘wide-screen’ display with black bars on the top and bottom.



{ **4:3 Panscan** } – For a full-height picture with the sides trimmed.



{ **16:9 Widescreen** } – For wide-screen TV (frame ratio 16:9).



Active video output

Select the type of video output that matches the video connection between this recorder and your TV.

{ **SCART (RGB)** } – For SCART connection.

{ **Comp. Video (YUV)** } – For Component video connection.

To enable progressive scan feature, go to { Video format } setting.

Note: Video output setting is not required for S-Video or Composite (CVBS) video connection.

Video format

This feature is only applicable for Component video connection. You can choose between progressive and interlaced video format, check your TV for compatibility.

{ **Progressive** } – Turn on progressive scan mode. Select this if your TV is progressive-scan compatible.

{ **Interlaced** } – For TV that is not compatible with progressive-scan video.

Note: If you choose a setting that is incompatible with your TV, you may not be able to see any picture at all. In this case, wait for 15 seconds for auto recovery or turn off the progressive scan as below:

- 1) Disconnect this unit's ~MAINS from the power supply.
- 2) Hold down **◀◀** on this unit whilst reconnecting its ~MAINS to the power supply.

Black level

Adapt the colour dynamic for NTSC disc.

{ **Normal** } – Normal colour contrast.

{ **Enhanced** } – Improve the colour contrast and brightens the picture of an NTSC-compatible DVD.

Vertical

This feature is only available in progressive scan mode.

Use **▲ ▼** keys to adjust the vertical position of the picture on your TV screen, press **OK** to confirm the setting.

System Menu Options (continued)

Audio settings (underlined options are the factory default settings)

Audio output

This setting is only required if you are using the recorder's COAXIAL/OPTICAL OUT socket to connect other audio/video device.

- { **All** } – Select this if the connected device has a built-in multi-channel decoder that supports one of the multi-channel audio format (Dolby Digital, MPEG-2).
- { **PCM only** } – Select this if the connected device is not capable of decoding multi-channel audio. The system converts the Dolby Digital and MPEG-2 multi-channel signals to PCM (Pulse Code Modulation).

Sound mode

This setting is only required if you used the recorder's AUDIO OUT L/R sockets to connect other audio/video device.

- { **Stereo** } – The sound output through the left and right audio channels. Use this setting when this recorder is connected to a TV or Stereo system.
- { **Surround** } – The connected audio/video device is compatible with Dolby Surround. Dolby Digital and MPEG-2 multi-channel are mixed to a compatible two-channel output signal.

Night mode

This mode optimises playback of sound at low volume. High volume outputs will be softened and low volume outputs are brought upward to an audible level. This feature is only applicable to DVD disc playback.

- { **On** } – Turn on night mode.
- { **Off** } – Turn off night mode. Select this to enjoy the surround sound with its full dynamic range.

System Menu Options (continued)

Analogue Tuner settings

Auto search

Press **OK** on the remote control to start the automatic TV channel search process and replace all previously stored analogue TV channels. This process may take several minutes.

Follow TV

This feature is only available if you have connected this recorder to your TV using the EXT1 TO TV scart socket. It allows you to copy the preset order from your TV to the recorder (analogue channels only).

- 1) Press **OK** the remote control to access.
- 2) Press **OK** to confirm the message on the TV, 'TV 01' appears on the display panel. Use the **TV's remote control** to select programme number {1} at your TV, then press **OK** on the recorder's remote control.
 - If the recorder finds the same TV channel as on the TV, it stores it as 'P01'. 'TV 02' will then appear on the display panel.
 - If no video signal is received from the TV, 'NO TV' will appear.
 - If you make a mistake, press **BACK** button to return to 'TV 01' setting.
- 3) Use the **TV's remote control** to select programme number {2} at your TV, then press **OK** on the recorder's remote control. Repeat the above steps until you have assigned all the TV channels.
- 4) To exit the menu, press **OPTIONS**.

Note: The Follow TV feature may not work properly on every TV. In case no channels are matched, please proceed with manual install.

Manual install

Use this setting only if the automatic install detected the wrong tuner signals.

- { **Entry mode** } – Select manual search based on channel allocation or frequency entry
{ **CH** (channel), **S-CH** (specified hyperband channel), **MHz** (frequency) }, then press **OK**.
- { **Entry** } – Use the **alphanumeric keypad 0-9** to enter the frequency value or the channel number, then press **OK** and the **Green** button for { **Store** }.
OR
– Press the **Blue** button on the remote control for { **Search** }, once you have found the correct frequency/channel, press the **Green** button for { **Store** }.

System Menu Options (continued)

Analogue Tuner settings

Manual install

continued ...

- { **Preset** } – Use the **alphanumeric keypad 0-9** to enter the preset number for the channel to store (e.g. '01'), press **OK** and the **Green** button for { **Store** }.

- { **Preset name** } – Use the **alphanumeric keypad 0-9** to enter the preset channel name, press **OK** and the **Green** button for { **Store** }. All channels can have a name of up to four characters.

- { **Decoder** } – Select { **On** } if the current TV channel is transmitted by coded TV signals that can only be viewed properly with a decoder which is connected to the EXT2-TO VCR/ SAT socket.

- { **TV system** } – Set the TV system that produces the least distortion of picture and sound. See last page 'TV System Guide' for more information.

- { **NICAM** } – NICAM is a digital sound transmission system. It can transmit either one stereo channel or two separate mono channels. Selects { **On** } to improve the sound transmission or { **Off** } if the reception is poor.

- { **Finetune** } – Use **▲ ▼** keys to adjust the frequency of the TV channel if the reception is poor and press **OK** to confirm.

System Menu Options (continued)

Analogue Tuner settings

Sort channels

Change the order of the stored channels according to your preference.



- 1) Select the channel that you want to move and press ►.
- 2) Move the selection bar to the preset number for which you want to place the channel and press ◀ or **OK** to confirm.

Favourites

Define your favourite channels that can be quick accessed by using the programme up/down button (**P** + **—**) on the remote control.

<input checked="" type="checkbox"/>	1	BBC
<input checked="" type="checkbox"/>	2	RTL4
<input type="checkbox"/>	3	ARD
<input checked="" type="checkbox"/>	4	ORF2
<input checked="" type="checkbox"/>	5	
<input type="checkbox"/>	6	TELET
<input type="checkbox"/>	7	

– Mark (or unmarked) your favourite channels using the **OK** button on the remote control.

Note: Unmarked channels can only be accessed by pressing the corresponding number button on the remote control.

System Menu Options (continued)

Set up settings (underlined options are the factory default settings)

Clock	Set the clock for your recorder before you can use any of the timer recording features.
Clock preset:	The time/date can be set automatically on this recorder if the stored TV channel transmits a time signal. { <u>Auto</u> } – The recorder automatically detects the first available channel which is transmitting the time/date information. { <u>XXX</u> } (preset channel) – Select the TV channel to use for transmitting the time/date information. { <u>Off</u> } – Disable automatic clock setting. Select this before setting the time/date manually.
Time:	Set the time manually. { <u>00 : 00</u> } – Use ▲ ▼ keys to set the hours and minutes. Use ◀ ▶ keys to move in the entry field. Once complete, press OK .
Date:	Set the date manually. { <u>31/01/2007</u> } – Use ▲ ▼ keys to set the day, month and year, Use ◀ ▶ keys to move in the entry field. Once complete, press OK .
Country	Select the country of your residence for auto channel tuning.
Remote control	You only need to set this if you are using more than one Philips remote control in the same room. { <u>DVD</u> } – Enable control of this recorder using the Philips DVD player's remote control (not supplied). { <u>Native</u> } – Disable second RC control function.
Eco mode	This is an energy saving mode. { <u>On</u> } – When switches to standby mode, the power consumption is less than the normal standby power. { <u>Off</u> } – Turn off eco mode.

System Menu Options (continued)

Set up settings (underlined options are the factory default settings)

Screen saver

The TV screen turns black to prevent damage to the screen due to over exposure to a static image for too long.

{ **Off** } – Disable screen saver function.

{ **5, 10, 30 minutes** } – Set the TV to screen saver mode after a period of inactivity (for example, recorder is put to pause or stop state).

DivX(R) VOD

Philips provides you with the DivX® VOD (Video On Demand) registration code that allows you to rent or purchase videos from DivX® VOD service at www.divx.com/vod. All the downloaded videos from DivX® VOD can only be played back on this unit

Version Info

This is only an information screen that shows the current version of software installed in your recorder. You may require this information for future online software upgrades.

Other Information

Setting up Progressive Scan feature

(for Progressive Scan TV only)

The progressive scan displays twice the number of frames per second than interlaced scanning (ordinary normal TV system). With nearly double the number of lines, progressive scan offers higher picture resolution and quality.

Before you start...

- Ensure that you have connected this recorder to a progressive scan TV using the Y Pb Pr connection.
- Ensure that you have completed the initial installation and set-up.

- 1 Turn on the TV to the correct viewing channel for this unit.
- 2 Turn on this unit and press **OPTIONS** on the remote control.
→ The tools menu appears.
- 3 Move to { **Settings** } and press **OK**.
→ The system settings menu appears.
- 4 Move to { **Video output** } and press **OK**.

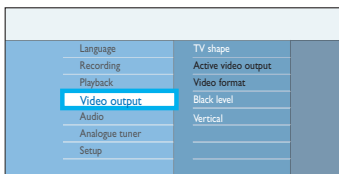

- 5 Move to { **Active video output** } > { **Comp. video (YUV)** } in the menu and press **t** to confirm.

- 6 Move to { **Video format** } > { **Progressive** } in the menu and press **t** to confirm.
- 7 Read the notification message on the TV and confirm your action by selecting the **OK** in the menu and press **OK**.
→ The setup is now completed and you can start to enjoy the high quality picture.
 - Otherwise, select { **Cancel** } and press **OK** to go back to the previous menu.
- 8 To exit the menu, press **OPTIONS**.

If no picture is displayed:

- 1 Disconnect this unit's ~MAINS from the power supply.
- 2 Hold down **◀◀** on this unit whilst reconnecting its ~MAINS to the power supply.

Helpful Hints:

- If a blank/distorted screen appears, wait for 15 seconds for the auto recovery.
- There are some progressive scan TVs that are not fully compatible with this unit, resulting in an unnatural picture when playing back a DVD VIDEO disc in the progressive scan mode. In such a case, turn off the progressive scan feature on both the recorder and your TV.

Copyright notice

The making of unauthorised copies of copy-protected material, including computer programmes, files, broadcasts and sound recordings, may be infringement of copyrights and constitute a criminal offence. This unit should not be used for such purposes.

Other Information (continued)

Installing the latest software

Periodically Philips will issue software upgrades to enhance the user experience. Only upgrading to higher versions of software is possible.

- 1 Get the version information of this unit by pressing **OPTIONS** on the remote control.
→ The tools menu appears.

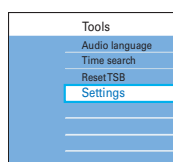

- 2 Move to { **Settings** } and press **OK**.
→ The system settings menu appears.

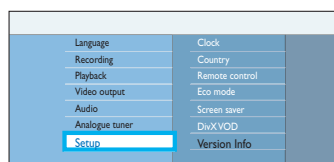

- 3 Move to { **Setup** } and press **OK**.
→ A warning message on clearing the Time Shift Buffer appears.
- 4 Press **OK** to continue.
- 5 Move to { **Version Info** } in the menu to view the version information.
→ Write down the information for your current software version.

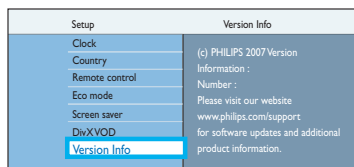

- 6 Visit Philips website 'www.philips.com/support' to check the availability of the latest software upgrade and download the software to a CD-R.
- 7 Insert the CD-R to the disc tray.
→ The software starts to install on this unit automatically.
- 8 When the disc compartment open, remove the CD-R.
→ Do not close the disc compartment or power off the unit.
- 9 Wait until the disc compartment closes automatically, you can now power off and on the unit.

Frequently Asked Questions

What kind of disc should I use for recording?

You can only record on DVD±R, DVD±RW or DVD+R DL discs. DVD±R/±RW is the most compatible recordable DVD format in the market today. They are fully compatible with most of the existing DVD-Video players and DVD-ROM drives in computers.

What is the capacity of a DVD±R and DVD±RW?

4.7GB, or equivalent to six CDs. You can store only one hour of recording on a single disc at the highest quality (DVD standard) and about 8 hours recording at the lowest quality (VHS standard). The recording mode indicates the number of hours that can fit on a single disc.

What is the difference between DVD±R and DVD±RW?

DVD±R is 'recordable' and DVD±RW is "erasable" and "rewritable". With a DVD±R, you can record multiple sessions on the same disc. But when the disc is full, you cannot record any more on the disc. The DVD±RW allows you to record over the same disc repeatedly.

Can I copy a VHS tape or DVD from an external player?

Yes, but only if the VHS tape or DVD is not copy protected.

What is DV?

Using DV, also known as i.LINK, you can connect a DV-equipped camcorder to this recorder using a single DV cable for input and output of audio, video, data and control signals.

- This recorder is only compatible with DV-format (DVC-SD) camcorders. Digital satellite tuners and Digital VHS video recorders are not compatible.
- You cannot connect more than one DV camcorder at a time to this recorder.
- You cannot control this recorder from external equipment connected via the DV IN socket.

What are Titles and Chapters?

A DVD disc contains Titles and Chapters, which are similar to the Titles and Chapters of a book. A Title is often a complete movie and is broken down into Chapters, or individual scenes from the movies.

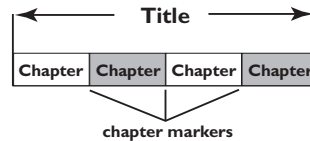

Programmes are recorded as a single title. They may consist of one chapter or a few chapters within a title, depending on the recording settings.

How do I set up Titles and Chapters?

The recorder automatically creates a new Title every time you start a new recording. You can then add Chapters to these recordings manually or have them automatically inserted at a specific intervals.

Frequently Asked Questions (continued)

What does 'finalising' a disc do?

Finalising a disc locks the disc so it can no longer be recorded. This is only required for DVD±R. It will then be compatible with virtually any DVD player. To remove a disc without finalising it, simply stop recording and eject the disc. You can still record on the disc if there is storage space for more recordings.

How good is the quality of the recording?

There are a few picture quality levels to choose from, ranging from 'HQ' (1 hour recording at high quality) to 'SEP' (8 hours recording at VHS quality) on a recordable DVD.

DVDR3570H

Record Mode	Hours of recordings can be stored on the HDD or an empty DVD recordable disc.		
	HDD (160 GB)	DVD±R/ DVD±RW	DVD+R Double Layer
HQ (high quality)	23	1	1 hr 55 mins
SP (standard play)	45	2	3 hrs 40 mins
SPP (standard play plus)	56	2.5	4 hrs 35 mins
LP (long play)	68	3	5 hrs 30 mins
EP (extended play)	90	4	7 hrs 20 mins
SLP (super long play)	135	6	11 hrs 5 mins
SEP (super extended play)	180	8	14 hrs 45 mins

DVDR3590H

Record Mode	Hours of recordings can be stored on the HDD or an empty DVD recordable disc.		
	HDD (250GB)	DVD±R/ DVD±RW	DVD+R Double Layer
HQ (high quality)	40	1	1 hr 55 mins
SP (standard play)	77	2	3 hrs 40 mins
SPP (standard play plus)	96	2.5	4 hrs 35 mins
LP (long play)	115	3	5 hrs 30 mins
EP (extended play)	153	4	7 hrs 20 mins
SLP (super long play)	230	6	11 hrs 5 mins
SEP (super extended play)	300	8	14 hrs 45 mins

Some recordings listed on the HDD menu cannot be played or copied to disc.

Some TV broadcasts or videos from external device that are recorded to this recorder may contain copy protection signals. Such material cannot be played back from the HDD or copied to a recordable DVD.

The copy-protected recordings are marked with the icon © in the HDD menu. They are either fully protected (copy never) or partially protected (copy once). For copy once recording, playback is possible but once copied to a recordable DVD, the recording will be removed from the HDD.

When playing a DivX movie, why the subtitle cannot be displayed properly?

- You have to make sure that the subtitle file has the exact same file name as the movie file. If for example the filename of the movie is "Movie.avi", then you will need to name the text file "Movie.sub" or "Movie.srt".
- You may need to change the 'Character set' or 'DivX subtitle' display of this player to which supports the recorded DivX subtitle.

Character set / DivX Subtitle	Subtitle language
Standard	English, Irish, Danish, Estonian, Finnish, French, German, Italian, Portuguese, Luxembourgish, Norwegian (Bokmål and Nynorsk), Spanish, Swedish, Turkish
Central Europe	Polish, Czech, Slovak, Albanian, Hungarian, Slovene, Croatian, Serbian (Latin script), Romanian,
Cyrillic	Belarusian, Bulgarian, Ukrainian, Macedonian, Russian, Serbian,
Greek	Greek

Frequently Asked Questions (continued)

Why does it take so long to display the contents on my USB device?

- This could be due to the large numbers of files (>500 files/folders) or size of the files (>1MB).
- There could be other non-supported files in the device that this unit is trying to read/display.

What if unsupported devices (e.g. USB mouse, keyboards) are plugged into the unit?

The device may cause this unit to be unstable. Remove the unsupported device and unplug the mains cord. Wait for a few minutes before reconnecting the mains cord and power on this unit again.

What happens when I plug in a USB HDD?

HDD is not supported as the large storage capacity makes navigation very difficult. Transfer the music files (mp3) and photos (jpg) into a flash drive if you want to playback on this recorder.

Why does this unit fail to detect my USB socketable music player?

The portable music player may require propriety software that is bundled with our system in order to access the contents (eg. playlist). MTP class not supported, only can support mass storage class devices.

What types of file does the system support?

We support only FAT16 and FAT32, not NTFS.

Why does the file name appear to be different from what was displayed on my computer (e.g. from 'Good Bye. jpg' to 'Good_B~1.jpg')?

- The length of the file name is restricted by the file system of the device (FAT16), which only supports eight (8) characters.
- The computer may be able to display the full file name as the operating system can convert the file system.

Why can't I rotate the pictures in my device?

In order to rotate the pictures in the USB device, the picture must contain EXIF information, stored by most digital cameras. This EXIF information may have been removed when you edit or copy the picture from other devices using editing programmes.

Why can't this unit play some of my music files, photos or movies?

The music files may not be playable because of different formats and encoding bit-rates. Similarly, the photos may be of low resolution or too high resolution for this unit to support.

Troubleshooting

WARNING!

Under no circumstances should you try to repair the system yourself, as this will invalidate the warranty. Do not open the system as there is a risk of electric shock.

If a fault occurs, first check the points listed below before taking the system for repair. If you are unable to solve a problem by following these hints, consult your dealer or Philips for help.

Problem (General)	Solution
No power.	<ul style="list-style-type: none">– Press the STANDBY-ON button on the front of the unit to turn on the power.– Make sure the mains cord is properly connected and the AC outlet has power.
The message 'IS TV ON?' appears on the display panel.	<ul style="list-style-type: none">– This recorder will not operate until you complete the first installation. See 'Step 3: Installation and Set-up' for details.
The buttons on the recorder do not work.	<ul style="list-style-type: none">– There is a technical problem. Disconnect the recorder from the power outlet for 30 seconds, then connect again. If the recorder still will not operate, then reset it to the default factory settings :<ol style="list-style-type: none">1) Disconnect the recorder from the power outlet.2) Press and hold down STANDBY-ON button on the front of the recorder while reconnecting to the power outlet.3) Release STANDBY-ON button when 'STARTING' appears on the display.4) Wait until the recorder's demo start scrolling on the display, press STANDBY-ON again to turn on the recorder. All the information stored in the memory (programmes, time) will be cleared. The initial installation menu will be displayed on the TV.
Remote control does not work.	<ul style="list-style-type: none">– Aim the remote control directly at the sensor on the front of this recorder (not towards TV).– Remove any obstacles between recorder and the remote control.– Batteries are weak, replace the batteries.

Troubleshooting (continued)

Problem (General)	Solution
No picture.	<ul style="list-style-type: none">– Turn on your TV and set it to the correct Video In channel for the recorder. You may go to Channel 1 on your TV, then press the channel down button on your TV's remote control until you see the recorder's built-in live TV.– Check the video connection between the recorder and the TV.
No sound.	<ul style="list-style-type: none">– Check the recorder audio connection. See 'Basic Recorder Connections - Connecting the audio cables' for details.– Set the Analogue output or Digital output correctly, based on the device you have connected to this recorder. See 'System Menu Options - Audio settings' for details.
No TV signal received from the recorder.	<ul style="list-style-type: none">– Make sure that the antenna cables are correctly connected. See 'Step 1: Basic Recorder Connections - Connecting the antenna cables' for details.– Install the TV channel. See 'System Menu Options - Analogue tuner settings' for details.
The message 'Disc contains unknown data' appears.	<ul style="list-style-type: none">– This message may appear if you insert a disc that contains junk data. DVD±Rs that have not been finalised are very sensitive to fingerprints, dust, or dirt. This may cause problems during recording. To use the disc again, do the following :<ol style="list-style-type: none">1) Make sure that the surface of the disc is clean.2) Press OPEN/CLOSE on this recorder.3) Insert the disc but do not close the tray.4) Hold down button number {5} on the remote control until the tray closes. This recorder starts the repair process.5) If the disc is recovered, the Picture Index screen will appear.
The message 'NO SIGNAL' or 'X' appears.	<ul style="list-style-type: none">– Check that the antenna cable is plugged in firmly.– No aerial signal received for the current channel or no video signal received from the external input channel (EXT1, EXT2, CAM1 or CAM2).– If you connect the recorder to a Cable Box/Satellite Receiver, make sure that it is turned on.

Troubleshooting (continued)

Problem (Playback)	Solution
Disc will not play.	<ul style="list-style-type: none">– Insert the disc with the label facing up.– The child lock is on. See 'System Menu Options - Playback settings - Child lock' for details.– Wrong region code. Check the rear or bottom of the DVD recorder for the supported region code.– There is no recording on the disc or wrong disc type. See 'Playback from Disc - Playable discs' for details.– Make sure the disc is not scratched or warped.
The picture is distorted or black and white during playback.	<ul style="list-style-type: none">– The disc does not match with the TV colour system standard (PAL/NTSC).– The disc is dirty. Clean the disc.– Sometimes a small amount of picture distortion may appear. This is not a malfunction.
There is picture or sound interference with the TV reception.	<ul style="list-style-type: none">– Check that the antenna cable is plugged in firmly.– Fine-tune your TV channel. See 'System Menu Options - Analogue Tuner settings - Manual install - Finetune' for details.
Distorted sound coming from a connected hi-fi amplifier.	<ul style="list-style-type: none">– Do not connect any cables from this recorder to the 'Phono' input of your amplifier.– If you are playing a DTS CD, you must use the COAXIAL or OPTICAL-DIGITAL AUDIO OUTPUT socket of this recorder to connect to the Hi-Fi system or amplifier. If the Hi-Fi system or amplifier does not support DTS, distorted sound might occur.
Unable to display JPEG pictures.	<ul style="list-style-type: none">– This unit only supports pictures in JPEG-Exif file format, using 4:2:2 or 4:2:0 chroma subsampling, with a resolution not exceeding 4096 x 4096 (horizontal/vertical). JPEG pictures that downloaded from the internet or have been modified using computer may not be able to display properly.
Unable to play DivX movies.	<ul style="list-style-type: none">– Ensure that the DivX file is encoded according to the 'Home Theatre Profile' with the DivX encoder.– Check that the DivX movie downloaded is a complete file.

Troubleshooting (continued)

Problem (Recording)	Solution
The message 'Insert recordable disc' appears.	<ul style="list-style-type: none">– Either no disc was inserted or the disc that was inserted cannot be used for recordings. Insert a recordable DVD (DVD±R, DVD±RW, or DVD+R Double Layer).
The message 'Collision' appears.	<ul style="list-style-type: none">– The timer recording overlaps with another timer recording.– If you ignore this warning, the programmed recording with the earlier start time will start first.– Change the information for one of the two recordings.– Delete one of the two recordings
Recordings are not occurring as scheduled. New recordings cannot be made.	<ul style="list-style-type: none">– Make sure that the recorder's time and date are set correctly. See 'System Menu Options - Set up settings - Clock' for details.– Two timer programmes may have overlapped, in which case only the earlier one will record completely.– You cannot use the recorder to duplicate copyright material (DVDs or videotapes) onto a recordable DVD, 'COPY PROTECT' will be displayed.
The index screen flickers when a DVD±R is inserted.	<ul style="list-style-type: none">– You can finalise the disc using the following function:<ol style="list-style-type: none">1) Press OPEN CLOSE on this recorder to open the disc tray.2) Insert the disc but do not close the tray.3) Hold down button number {4} on the remote control until the tray closes. 'FINALIZING DISC' appears on the display panel.4) If finalising has been successful, the Picture Index screen will appear.
Unable to copy DivX file to Hard Disk even though the data partition still has enough free space.	<ul style="list-style-type: none">– All the video files (TV recordings and DivX movies) are stored in the Video partition in the hard disk. Delete some recordings in the Video partition to free up some space before copying additional files.
Music/photo/DivX files copied from the hard disk/USB device to a recordable DVD cannot be played back on other DVD players.	<ul style="list-style-type: none">– Some PC/DVD players do not support the UDF1.50 file system used on the disc. Any PC installed with Windows XP or higher is able to play this DVD.

Troubleshooting (continued)

Problem (Recording)	Solution
Picture is fuzzy and brightness varies when played back your recording.	<ul style="list-style-type: none">– This happens if you try to copy DVDs or video tapes that have been copy-protected. Even though the picture on the TV is fine, the recording on the recordable DVD is faulty. This interference is unavoidable with copy-protected DVDs or video tapes.– The recordable DVD has a limited recording lifetime, use a new disc for recording.
DVD±R/±RW recorded on this DVD recorder cannot be played back on other DVD players.	<ul style="list-style-type: none">– If a recording is too short, it is possible that a DVD player cannot detect it.– You have to finalise the DVD±R. See 'Finalising the DVD±R for playback' for details.– You have to make the DVD±RW compatible. See 'Making the edited DVD±RW compatible' for details.
The DVD±RW cannot be used for recording on this recorder. Even though it has been formatted using the PC drive.	<ul style="list-style-type: none">– You have to re-format the DVD±RW.<ol style="list-style-type: none">1) Press OPEN CLOSE on this recorder to open the disc tray.2) Insert the disc but do not close the tray.3) Hold down button number {0} on the remote control until the disc tray closes.4) Start recording on the DVD±RW before you remove it from the disc tray.
The contents of the USB flash drive cannot be read.	<ul style="list-style-type: none">– The USB flash drive format is not compatible with the system.– Drive is formatted with a different file system which is not supported by this DVD recorder (e.g., NTFS).
Slow operation of the USB flash drive.	<ul style="list-style-type: none">– Large file size or high memory USB flash drive takes longer time to read and display on the TV.
The connected card reader/flash drive is not detected. The message 'USB Hub is not supported' appears.	<ul style="list-style-type: none">– This recorder only supports Mass Storage Class (MSC) devices. Not all card readers/flash drives implement this standard. Please use another device.

Display panel symbols/messages

The following symbols/messages may appear on your recorder display:



- **00:00**
Multifunction display/text line
 - Title/track number
 - Total/elapsed/remaining title/track time
 - Disc/title name
 - Error or warning messages
 - Additional information regarding the disc
 - TV channel number or source of video
 - Clock (This is displayed in Standby mode).
 - TV programme title
- **PRO SCAN**
The video output is in progressive scan quality.
- **⊕ TIMER**
A timer recording has been programmed or is active.
- **SAT**
The recorder is prepared for satellite recording.
- **BLOCKED**
The disc tray cannot be opened or closed due to some mechanical obstruction.
- **BROWSER**
The recorder is currently in media browser mode.
- **CLOSING**
Disc tray is closing.
- **COMPATIBLE**
The recorder is busy making changes to make the disc DVD-compatible.
- **COPY PROTECT**
The DVD/video cassette you are trying to copy is copy-protected.
- **CREATING MENU**
After the first recording has been successfully complete on a new disc, the menu structure is created.
- **DISC ERR**
An error occurred when writing the title. If this happens often, clean the disc or use a new one.
- **DISC FULL**
Disc is full. There is no storage space for new recordings.
- **DISC WARNING**
An error occurred when recording from external device. The recording continues but the error will be skipped.
- **EMPTY DISC**
Inserted disc is new or has been completely erased (no recordings present).
- **FREE TITLE**
An empty title was selected.

Display panel symbols/messages (continued)

- **FINALIZING DISC**
The DVD±R disc is being finalised.
- **INFO DVD**
Information on the inserted DVD is displayed on the TV.
- **INSTALL**
After the automatic channel search, the menu for setting the time/date appears on the TV.
- **IS TV ON?**
The recorder is currently in the first installation mode. Turn on your TV and read the chapter 'Installation and Set-up' in the user manual.
- **MAX CHAP**
The maximum number of chapters per title disc has been reached. The maximum number of chapters per title is 99, and 255 per disc.
- **MAX TITLE**
The maximum number of titles has been reached for the disc. Each disc can have a maximum of 49 titles.
- **UPDATING MENU**
After a successful recording, the list of disc contents is updated.
- **NO DISC**
No disc has been inserted. If a disc has been inserted, then it is possible that the disc cannot be read.
- **NOSIGNAL**
No signal or poor signal strength.
- **NTSC DISC**
A disc with NTSC recordings has been inserted and an attempt was made to record a PAL signal. Insert a new disc or use a disc containing PAL recordings.
- **OPENING**
Disc tray is opening.
- **PAL DISC**
A disc with PAL recordings has been inserted and an attempt was made to record an NTSC signal. Insert a new disc or use a disc containing NTSC recordings.
- **STARTING**
The recorder has been turned on.
- **PHOTO MMM/NNN**
Number of the current photo (for Photo mode). MMM represents the order of the current photo, NNN represents the total number of photos in the album. If the number exceeds 999, '999' will be displayed instead.
- **POST FORMAT**
The disc is being prepared after the menu structure has been created.
- **PROTECTED**
Title is copy-protected and cannot be recorded.
- **READING**
Disc is being recognised by the recorder.
- **STANDBY**
The recorder has been turned off.
- **SYS MENU**
The on-screen menu display is on.
- **BUSY**
Wait until this message disappears. The recorder is busy processing an operation.

Glossary

Analogue audio: Sound that has not been turned into numbers. Analogue sound is available when you use the AUDIO LEFT/RIGHT. These red and white sockets send audio through two channels, the left and right.

Aspect ratio: Aspect ratio refers to the length to height ratio of TV screens. The ratio of a standard TV is 4:3, while the ratio of a high-definition or wide TV is 16:9. The letter box allows you to enjoy a picture with a wider perspective on a standard 4:3 screen.

Composite video (CVBS): A single video signal commonly used in most consumer video products.

Digital audio: Sound signal that has been converted into numerical values. Digital sound is available when you use the DIGITAL AUDIO OUT COAXIAL. These sockets send audio through multiple channels, instead of just two channels as analogue does.

Disc menu: A screen display prepared for allowing a selection of images, sounds, subtitles, multi-angles, etc., recorded on a DVD.

DivX: The DivX code is a patent-pending, MPEG-4 based video compression technology, developed by DivX Networks, Inc., that can shrink digital video to sizes small enough to be transported over the internet, while maintaining high visual quality.

Dolby Digital: A surround sound system developed by Dolby Laboratories containing up to six channels of digital audio (front left and right, surround left and right, centre and subwoofer).

JPEG-EXIF: JPEG-Exchangeable Image File. A file format developed by Fuji Photo Film for digital still cameras. Digital cameras from various manufacturers use this compressed file format which carries date, time and thumbnails information, as well as the picture data.

Finalise: A process that makes playback of a recorded DVD±R or CD-R possible on a device that can play such media. You can finalise DVD±R on this unit. After finalising, the disc becomes play only and you can no longer record or edit on the disc.

Index Picture Screen: A screen that gives an overview of a DVD±RW or DVD±R. An Index Picture represents each recording.

JPEG: A very common digital still picture format. A still-picture data compression system proposed by the Joint Photographic Expert Group, which features small decrease in image quality in spite of its high compression ratio. Files are recognised by their file extension 'JPG or JPEG'.

MP3: A file format with a sound data compression system. 'MP3' is the abbreviation of Motion Picture Experts Group 1 (or MPEG-1) Audio Layer 3. By using the MP3 format, one CD-R or CD-RW can contain about 10 times more data than a regular CD. Files are recognised by their file extension '.MP3'.

MPEG: Motion Picture Experts Group. A collection of compression systems for digital audio and video.

PBC: Playback Control. A system of navigating a Video CD/Super VCD through on-screen menus recorded onto the disc. You can enjoy interactive playback and searching.

PCM: Pulse Code Modulation. A digital audio encoding system.

Progressive Scan: The progressive scan displays twice the number of frames per seconds than ordinary TV system. It offers higher picture resolution and quality.

Region code: A system allowing discs to be played only in the region designated. This unit will only play discs that have compatible region codes. You can find the region code of your unit by looking on the product label. Some discs are compatible with more than one region (or ALL regions).

S-Video: Produces a clear picture by sending separate signals for the luminance and the colour. You can use S-Video only if your TV has an S-Video In socket.

Surround: A system for creating realistic three dimensional sound fields full of realism by arranging multiple speakers around the listener.

WMA: Windows Media™ Audio. Refers to an audio compression technology developed by Microsoft Corporation. WMA data can be encoded by using Windows Media Player version 9 or Windows Media Player for Windows XP. Files are recognised by their file extension 'WMA'.

Specifications

Recording media

- HDD: DVD+R/-R, DVD+RW/-RW, DVD+R Double layer, USB flash drive

Playback media

- DVD-Video, Video CD/SVCD, Audio CD, CD-R/CD-RW, DVD+R/+RW, DVD-R/-RW, Picture CD, MP3-CD, MP3-DVD, WMA-CD, USB flash drive

Picture/Display

- A/D Converter: 10 bit, 54 MHz
- D/A Converter: 13 bit, 162 MHz
- Picture enhancement: Progressive Scan

Sound

- A/D Converter: 16 bit, 48 kHz
- D/A Converter: 24 bit, 96 kHz

Video Recording

- Audio compression: Dolby Digital
- Compression formats: MPEG2
- Recording modes: High Quality (HQ), Standard Play (SP), Standard Play Plus (SPP), Long Play (LP), Super Long Play (SLP), Extended Play (EP), Super Extended Play (SEP)
- Recording system: PAL

Video Playback

- Compression formats: MPEG2, MPEG1
- Video disc playback system: NTSC, PAL

Audio Playback

- Compression formats: Dolby Digital, MPEG2 Multichannel, PCM, MP3, WMA
- MPEG1 bit rates: 64-384 kbps and VBR

Storage Media

- Hard Disk capacity:
DVDR3570H - 160 GB
DVDR3590H - 250 GB

Tuner/Reception/Transmission

- TV system: PAL, SECAM
- Aerial input: 75 Ohm coaxial (IEC75)

Connectivity

- Rear Connections
 - RF antenna in
 - RF TV out
 - Scart 1 (CVBS, RGB out)
 - Scart 2 (CVBS, RGB in)
 - Component Video out (Progressive/Interlaced)
 - S-Video out
 - Video out (CVBS)
 - Audio left/right out
 - Digital Coaxial out
 - Mains
- Front Connections
 - DV in (i.LINK)
 - Video in (CVBS)
 - Audio left/right in
 - USB 2.0

Convenience

- HDD Media Jukebox: DivX, JPEG, MP3, WMA
- Programmable events: 40
- VIDEO Plus+ programming
- Programming/Timer Enhancement:
 - Automatic Satellite Recording
 - Daily/Weekly repeat programme
 - One Touch Recording
 - Manual Timer
 - VPS/PDC recording control
- Ease of installation: Follow TV, Auto install

Power

- Power supply: 220-240V, ~50 Hz
- Power consumption:
 - DVDR3570H - 28 W
 - DVDR3590H - 32 W
- Eco standby power consumption: < 3.7 W

Cabinet

- Dimensions (WxHxD): 435 x 43 x 324 mm
- Net Weight: 3.8 kg

Specification and design are subject to change without notice.



TV System Guide

COUNTRY	VHF	UHF	DVD REGIONS
AFGHANISTAN	PAL/SECAM B		5
ALBANIA	PAL B	PAL G	2
ALGERIA	PAL B	PAL G	5
ANGOLA	PAL I		5
ARGENTINA	PAL N	PAL N	4
AUSTRALIA	PAL B	PAL H	4
AUSTRIA	PAL B	PAL G	2
AZORES	PAL B		
BAHAMAS	NTSC M		4
BAHRAIN	PAL B	PAL G	2
BANGLADESH	PAL B		5
BARBADOS	NTSC M		4
BELGIUM	PAL B	PAL H	2
BERMUDA	NTSC M		
BOLIVIA	NTSC M	NTSC M	4
BOTSWANA	PAL I		5
BRAZIL	PAL M	PAL M	4
BRUNEI	PAL B	PAL B	
BULGARIA	PAL B	PAL G	2
BURKINA FASO	SECAM K1		5
BURMA	NTSC M		
BURUNDI	SECAM K1		5
CAMBODIA	NTSC M		3
CAMEROON	PAL B	PAL G	5
CANADA	NTSC M	NTSC M	1
CANARY ISLANDS	PAL B		2
CHAD	SECAM K1		5
CHILE	NTSC M	NTSC M	4
CHINA	PAL D		6
COLOMBIA	NTSC M	NTSC M	4
COSTA RICA	NTSC M	NTSC M	4
CROATIA	PAL B	PAL G	2
CUBA	NTSC M	NTSC M	4
CYPRUS	PAL B	PAL G	
CZECH REPUBLIC	PAL D	PAL K	2
DAHOMEY	SECAM K1		
DENMARK	PAL B	PAL G	2
DJIBOUTI	SECAM B	SECAM G	5
DOMINICAN REP	NTSC M	NTSC M	4
ECUADOR	NTSC M	NTSC M	4
EGYPT	SECAM B/PAL B	SECAM G/PAL G	2
EL SALVADOR	NTSC M	NTSC M	4
EQUAT. GUINEA	PAL B		5
ESTONIA	PAL B (was SECAM)	PAL D	5
ETHIOPIA	PAL B	PAL G	5
FIJI	PAL B		
FINLAND	PAL B	PAL G	2
FRANCE	SECAM L	SECAM L	2
FRENCH POLYNESIA	SECAM K1		
GABON	SECAM K1		5
GAMBIA	PAL I		5
GERMANY	PAL B	PAL G	2
GHANA	PAL B	PAL G	5
GIBRALTAR	PAL B	PAL H	2
GREECE	PAL B (was SECAM)	PAL G	2
GREENLAND	NTSC/PAL B		2
GUADELOUPE	SECAM K1		
GUAM	NTSC M		1
GUATEMALA	NTSC M	NTSC M	4
GUINEA	PAL K		5
GUYANA (FRENCH)	SECAM K1		4
HONDURAS	NTSC M	NTSC M	4

TV System Guide (continued)

COUNTRY	VHF	UHF	DVD REGIONS
LIBYA	SECAM B	SECAM G	5
LITHUANIA	PAL D (was SECAM)	PAL K	5
LUXEMBOURG	PAL B/SECAM L	PAL G/SEC L	2
MADAGASCAR	SECAM K1		5
MADEIRA	PAL B		
MALAGASY	SECAM K1		
MALAWI	PAL B	PAL G	5
MALAYSIA	PAL B		3
MALI	SECAM K1		5
MALTA	PAL B	PAL H	2
MARTINIQUE	SECAM K1		
MAURITANIA	SECAM B		5
MAURITIUS	SECAM B		5
MEXICO	NTSC M	NTSC M	4
MONACO	SECAM L		2
MONGOLIA	SECAM D		5
MOROCCO	SECAM B		5
MOZAMBIQUE	PAL B		5
NAMIBIA	PAL I		5
NEPAL	PAL B		
NETHERLANDS	PAL B	PAL G	2
NETH. ANTILLES	NTSC M	NTSC M	
NEW CALEDONIA	SECAM K1		
NEW GUINEA	PAL B	PAL G	4
NEW ZEALAND	PAL B	PAL G	4
NICARAGUA	NTSC M	NTSC M	4
NIGER	SECAM K1		5
NIGERIA	PAL B	PAL G	5
NORWAY	PAL B	PAL G	2
OMAN	PAL B	PAL G	2
PAKISTAN	PAL B		5
PANAMA	NTSC M	NTSC M	4
PARAGUAY	PAL N	PAL N	4
PERU	NTSC M	NTSC M	4
PHILIPPINES	NTSC M	NTSC M	3
POLAND	PAL D	PAL K	2
PORTUGAL	PAL B	PAL G	2
PUERTO RICO	NTSC M	NTSC M	1
QATAR	PAL B		2
REUNION	SECAM K1		
RUMANIA	PAL D	PAL K	2
RUSSIA	SECAM D	SECAM K	5
RWANDA	SECAM K1		5
SABAH/SAWARA	PAL B		
ST. KITTS	NTSC M	NTSC M	
SAMOA (US)	NTSC M		1
SAUDI ARABIA	SECAM-B/PAL-B	SECAM G	2
SENEGAL	PAL		5
SEYCHELLES	PAL B	PAL G	5
SIERRA LEONE	PAL B	PAL G	5
SINGAPORE	PAL B	PAL G	
SLOVAK REPUBLIC	PAL	PAL	2
SOMALIA	PAL B	PAL G	5
SOUTH AFRICA	PAL I	PAL I	2
SPAIN	PAL B	PAL G	2
SRI LANKA	PAL B		5
SUDAN	PAL B	PAL G	5
SURINAM	NTSC M	NTSC M	4
SWAZILAND	PAL B	PAL G	
SWEDEN	PAL B	PAL G	2
SWITZERLAND	PAL B	PAL G	2
SYRIA	SECAM B		2

Meet Philips at the Internet
<http://www.philips.com>
<http://www.philips.com/welcome>



Be responsible
Respect copyrights



DVDR3570H
DVDR3590H

**CLASS 1
LASER PRODUCT**

3 139 245 28733

Philips Customer Care phone numbers:

Austria	0810 000205	€ 0.07/ min
Belgium	078 250 145	€ 0.06/ min
Czech Republic	800 142840	free
Denmark	3525 8759	pstn
Finland	09 2311 3415	pstn
France	0821 611655	€ 0.09/ min
Germany	01803 386 852	€ 0.09/ min
Greece	0 0800 3122 1280	free
Ireland	01 601 1777	pstn
Italy	840 320 086	€ 0.08/ min
Hungary	06 80018 189	pstn
Luxembourg	40 6661 5644	pstn
Netherlands	0900 8407	€ 0.10/ min
Norway	2270 8111	pstn
Poland	022 349 15 04	pstn
Portugal	2 1359 1442	pstn
Slovakia	0800 004537	free
Spain	902 888 784	€ 0.10/ min
Sweden	08 5792 9100	pstn
Switzerland	0844 800 544	pstn
United Kingdom	0870 900 9070	pstn



Sgpjp-0808/05-1

Free Manuals Download Website

<http://myh66.com>

<http://usermanuals.us>

<http://www.somanuals.com>

<http://www.4manuals.cc>

<http://www.manual-lib.com>

<http://www.404manual.com>

<http://www.luxmanual.com>

<http://aubethermostatmanual.com>

Golf course search by state

<http://golfingnear.com>

Email search by domain

<http://emailbydomain.com>

Auto manuals search

<http://auto.somanuals.com>

TV manuals search

<http://tv.somanuals.com>