

Cat. No. 43-759 A
OWNER'S MANUAL

Please read before using this equipment.

TAD-759

**Digital Answering System
with 13-Memory Telephone**



RadioShack®

FEATURES

Your RadioShack TAD-759 Digital Answering System combines a high-quality answering system with a multi-feature telephone.

The TAD (telephone answering device) stores all messages on a computer chip. This gives you advanced capabilities over tape-based answering machines. For example, you can delete an individual message while saving the rest. Because your TAD is fully digital, there are no tapes to bother with and no tape mechanisms to wear out.

The TAD-759's 16-minute memory is more than enough to meet most users' needs. And you can operate the TAD-759 remotely from a touch-tone phone. With an optional pocket tone dialer, you can even use it from a rotary phone.

TAD Features

Voice Time/Day Stamp — announces the time and day that each message was recorded.

Memo Recording — lets you leave messages for yourself or others in your home or office.

Call Screening — lets you listen to incoming calls before you decide to answer.

Remote Operation — lets you use a touch-tone phone (or rotary phone and pocket tone dialer) to operate the TAD while you are away from your home or office.

Adjustable Ring Selection — lets you set the TAD-759 to answer the telephone after four or seven rings.

Toll-Saver — lets you avoid unnecessary charges when you call long-distance to check your messages.

Programmable Remote Operation Security Code — lets you set your own three-digit security code for remote operation.

Message Counter — shows the number of messages.

DELETE — lets you quickly erase messages one at a time or all at once.

Memory Backup — protects stored messages in case of a power failure.

Phone Pick-Up Detection — automatically stops the TAD if you answer a call after the TAD answers.

Room Monitor — lets you listen from a remote phone to the room where you installed the TAD.

ANSWER Button — lets you set the TAD to answer or not answer.

© 1998, 1999 Tandy Corporation.
All Rights Reserved.

RadioShack is a registered trademark used by Tandy Corporation.

Telephone Features

Priority Memory Dialing — lets you store three priority memory numbers and call them with the touch of a button.

10 Indirect Memory Locations — let you quickly dial frequently-called numbers.

Tone/Pulse Dialing — lets you use either type of service, and you can easily switch from pulse to tone dialing for long-distance, bank-by-phone, or other special services.

Redial — lets you quickly redial the last number dialed.

Flash — sends an electronic switch-hook signal for use with special phone services such as Call Waiting.

Privacy — prevents the person on the phone from hearing your conversation with someone in the room.



Ringer Volume Switch — lets you adjust the ringer's sound level.

Handset Volume Control — lets you adjust the volume you hear during a call.

Hearing-Aid Compatibility — lets you use the phone with any hearing aid that has a T (telephone) switch.

This TAD has been tested and certified to comply with applicable UL and FCC standards.

WARNING: To reduce the risk of fire or shock hazard, do not expose this product to rain or moisture.

	CAUTION RISK OF ELECTRIC SHOCK. DO NOT OPEN.	
CAUTION: TO REDUCE THE RISK OF ELECTRIC SHOCK, DO NOT REMOVE COVER OR BACK. NO USER-SERVICEABLE PARTS INSIDE. REFER SERVICING TO QUALIFIED PERSONNEL.		



This symbol is intended to alert you to the presence of uninsulated dangerous voltage within the product's enclosure that might be of sufficient magnitude to constitute a risk of electric shock. Do not open the product's case.



This symbol is intended to inform you that important operating and maintenance instructions are included in the literature accompanying this product.

READ THIS BEFORE INSTALLATION

We have designed your TAD-759 to conform to federal regulations, and you can connect it to most telephone lines. However, each device you connect to the phone line draws power from the line. This power draw is the device's *ringer equivalence number*, or REN. The REN is on the bottom of the TAD.

If you use more than one telephone or other device on the line, add up all of the RENs. If the total is more than five, your telephones might not ring. In rural areas, a total REN of three might impair ringer operation. If ringer operation is impaired, remove a device from the line.

FCC STATEMENT

Your TAD complies with Part 68 of *FCC Rules*. You must, upon request, provide the FCC registration number and the REN to your telephone company. Both numbers are marked on the bottom of the TAD.

Note: You must not connect the TAD to:

- coin-operated systems
- party-line systems
- electronic key telephone systems

Your TAD complies with the limits for a Class B digital device as specified in Part 15 of *FCC Rules*. These limits provide reasonable protection against radio and TV interference in a residential area. However, your TAD might cause TV or radio interference even when it is operating properly. To eliminate interference, you can try one or more of the following corrective measures:

- Reorient or relocate the receiving antenna of the radio or TV antenna.
- Increase the distance between the TAD and the radio or TV.
- Use outlets on different electrical circuits for the TAD and the radio or TV.

Consult your local RadioShack store if the problem still exists.

CONTENTS

Preparation	6
Installing a Backup Battery	6
Mounting the TAD	6
On a Desk Top	7
On a Wall Plate or Wall	7
Setting the Dialing Mode	8
Setting the Day and Time	9
Setting the Number of Rings	10
Telephone Operation	11
Setting the Ringer's Volume	11
Using Redial	11
Adjusting the Handset's Volume	11
Using Flash	11
Using Privacy	12
Using Tone Services on a Pulse Line	12
Memory Dialing	12
Storing Numbers in Memory	12
Dialing a Stored Number	13
Testing Stored Emergency Numbers	13
Chain-Dialing Special Service Numbers	13
TAD Operation	14
Recording the Outgoing Message	14
Adjusting the TAD's Volume	14
Setting the TAD to Answer Calls	14
Recording Incoming Messages	15
Screening Calls	15
Playing Messages	15
Deleting Messages	16
Recording a Memo	17
Changing the Remote Operation Security Code	17
Remote Operation	18
Using Toll-Saver	18
Using Remote Commands	18
Remote Commands	19
Troubleshooting	20
Care and Maintenance	21
The FCC Wants You to Know	22
Lightning	22

PREPARATION

INSTALLING A BACKUP BATTERY

The TAD requires AC power to operate. However, if AC power fails or you unplug the TAD-759, a 9-volt battery (not supplied) saves the messages, time and day settings, memory numbers, and the remote operation security code. We recommend a RadioShack alkaline battery.

Note: The telephone operates normally during a power failure; however, the TAD cannot answer and record incoming calls without AC power.

Follow these steps to install the battery.

Warning: If the TAD's modular line cord is connected to a phone line jack, disconnect it before installing a battery. This reduces the risk of electric shock.

Caution: Use only a fresh battery of the required size and recommended type.

1. Use a flat-blade screwdriver to unlatch the battery compartment cover (as shown), then open the cover.

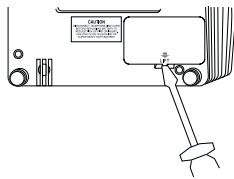

2. Snap the battery's terminals to the connector inside the compartment.
3. Close the cover and press down on the latch to close it.

Replace the battery when **Lo** appears on the message counter. Be sure the AC adapter's cord is plugged in while you replace the battery, so you do not lose any stored information.

Cautions:

- Always remove an old or weak battery. Batteries can leak chemicals that can destroy electronic parts.
- Dispose of old batteries promptly and properly. Do not burn or bury them.

MOUNTING THE TAD

You can place the TAD-759 on a desk, mount it on a standard wall plate, or mount it directly on a wall. Select a location that is near both a modular telephone line jack and an AC outlet.

Notes:

- Your TAD-759 connects directly to a modular telephone line jack. If your telephone wiring does not have a modular jack, you can update it yourself using jacks and adapters available at your local RadioShack store, or have the telephone company update it for you.
- The USOC number of the jack to be installed is RJ11C (or RJ11W for a wall plate jack).

Caution: The supplied AC adapter was designed specifically for your TAD-759. Use only the supplied adapter.

On a Desk Top

1. Plug one end of the supplied long modular cord into the **TEL. LINE** jack on the back of the base.

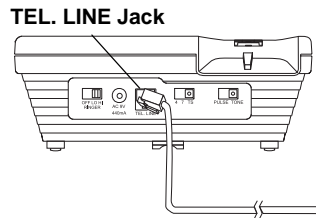

2. Plug the cord's other end into a modular phone line jack.
3. Plug one end of the supplied coiled handset cord into the jack at the left side of the base. Plug the other end into the handset's jack.

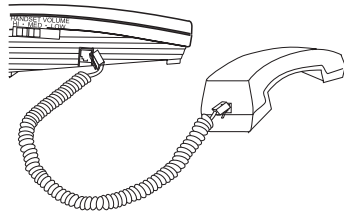

4. Place the handset on the base.
5. Insert the supplied AC adapter's barrel plug into the **AC 9V** jack on the back of the base.

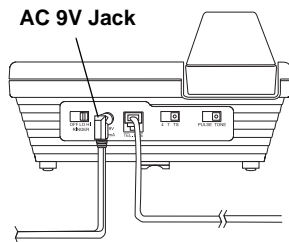

6. Plug the adapter into a standard AC outlet.

When you first connect power, — — flashes on the message counter as the TAD runs a self-test. The TAD beeps and 00 appears when the test is complete.

On a Wall Plate or Wall

Note: To mount the base directly on the wall, you need two screws (not supplied) with heads that fit into the keyhole slots on the bottom of the base. Drill two holes $3^{15}/16$ inches (100 mm) apart. Then thread a screw into each hole, letting the heads extend about $3/16$ inch (5 mm) from the wall.

1. Snap the supplied mounting bracket into the slots on the bottom of the TAD as shown.

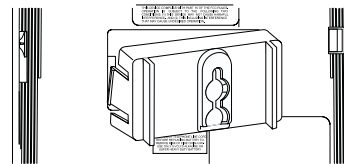

Note: Be sure the keyhole slots on the bracket and the TAD are aligned in the same direction.

2. Plug one end of the supplied short modular line cord into the **TEL. LINE** jack on the back of the TAD.

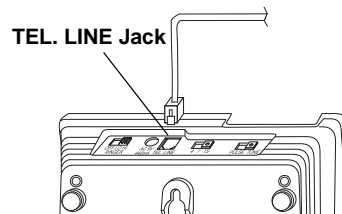

3. Insert the supplied AC adapter's barrel plug into the **AC 9V** jack on the back of the base.

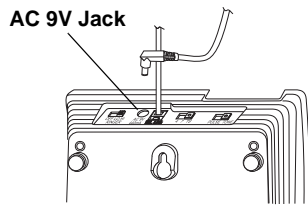

4. To mount the phone on a wall plate, plug the other end of the modular cord into the wall plate jack. Then, with the power cord hanging over the bracket, align the TAD's keyhole slots with the wall plate studs and slide the TAD downward to secure it.

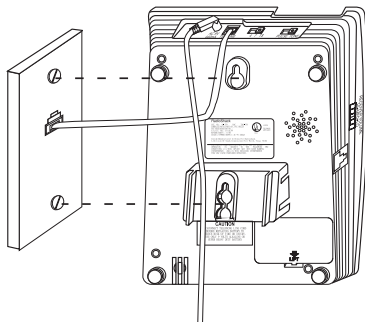

To mount the phone directly on a wall, with the power cord and the modular cord hanging over the bracket, align the TAD's keyhole slots with the screws and slide the TAD downward to secure it.

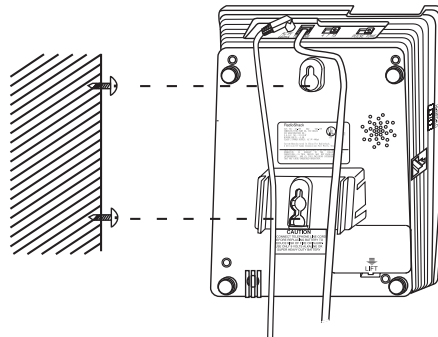

5. Slide the handset clip out of its retaining slot, rotate it 180°, then slide it back into its slot.

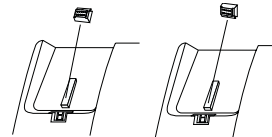

6. Plug one end of the supplied coiled handset cord into the jack at the left side of the base. Plug the other end into the handset's jack.
7. Place the handset on the base.
8. Plug the adapter into a standard AC outlet.

When you first connect power, — — flashes on the message counter as the TAD runs a self-test. The TAD beeps and **00** appears when the test is complete.

SETTING THE DIALING MODE

Set **PULSE/TONE** for the type of service you have. If you are not sure which type you have, follow these steps.

1. Set **PULSE/TONE** on the back of the TAD to **TONE**.

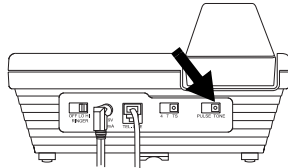

2. Lift the handset and listen for a dial tone.
3. Press any number except **0**.

Note: If your phone system requires that you dial an access code (9, for example) before you dial an outside number, do not dial the access code either.

If the dial tone stops, you have touch-tone service. Leave **PULSE/TONE** set to **TONE**.

If the dial tone continues, you have pulse service. Set **PULSE/TONE** to **PULSE**.

SETTING THE DAY AND TIME

The TAD-759 records the day and time each memo and message is recorded. Follow these steps to set the day and time.

Note: If you do not complete each step within 8 seconds, the TAD sounds three beeps and exits. Start again at Step 1.

1. Hold down **SET** until the TAD beeps. The TAD announces, “Sunday,” and **01** appears on the display.

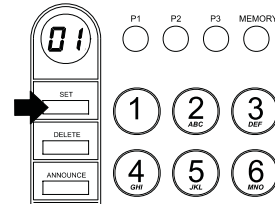

Note: If necessary, adjust **VOLUME** on the right side of the TAD to the desired listening level.

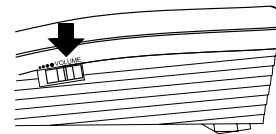

2. To change the day, repeatedly press **SKIP** to move backward or **REPEAT** to move forward until the TAD announces the desired day.

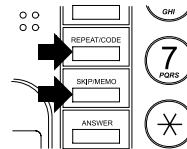

3. Press **STOP**. The TAD shows the currently set hour and announces “AM” or “PM.”

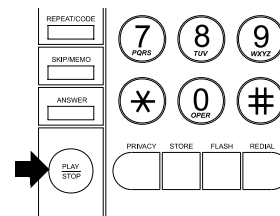

4. To change the hour, repeatedly press **SKIP** or **REPEAT**.

-
5. Press **STOP**. The TAD shows the currently set minute.
 6. To change the minutes, repeatedly press **SKIP** or **REPEAT**.
 7. Press **STOP**. The TAD announces the day and time.

To check the current day and time at any time, press **SET**.

SETTING THE NUMBER OF RINGS

Set the ring select switch on the back of the TAD to **4**, **7**, or **TS** to set how long the TAD waits before it answers a call (4 rings, 7 rings, or toll-saver).

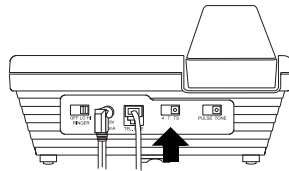

If you plan to check your messages by long distance, set the ring select switch to **TS** (see "Using Toll-Saver" on Page 18).

TELEPHONE OPERATION

Place and answer phone calls with the TAD-759 as you would with any standard phone.

SETTING THE RINGER'S VOLUME

To change the ringer's volume, set the ringer volume switch on the back of the base to **LO** for a normal ringer volume, or **HI** for a louder ring.

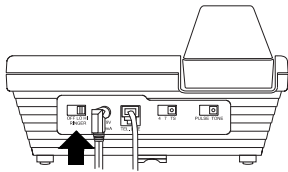

If you do not want the ringer to sound, set the ringer volume switch to **OFF**. You can still make calls with the ringer off, and you can answer calls if you hear another phone on the same line ring.

USING REDIAL

To quickly dial the last number dialed, lift the handset and press **REDIAL**.

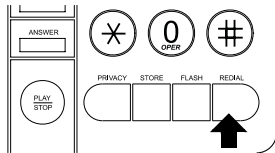

Note: The redial memory stores 31 tone digits or 32 pulse digits.

ADJUSTING THE HANDSET'S VOLUME

The TAD-759 has three volume levels. To adjust the volume you hear through the handset, slide **HANDSET VOLUME HI/MED/LO** to the desired volume during a call.

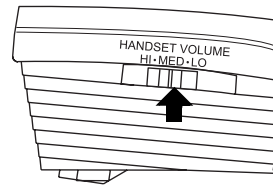

USING FLASH

Use **FLASH** to perform the switchhook operation for special services, such as Call Waiting.

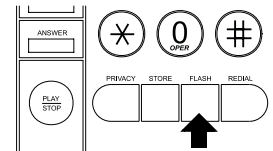

For example, if you have Call Waiting, press **FLASH** to take an incoming call without disconnecting the current call. Press **FLASH** again to return to the first call.

Note: If you do not have special phone services, pressing **FLASH** might disconnect the current call.

USING PRIVACY

To talk to someone else in the room without the person on the other end of the phone line hearing you, hold down **PRIVACY**. Release it to resume your telephone conversation.

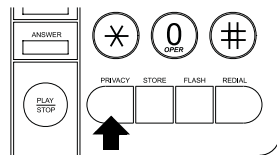

USING TONE SERVICES ON A PULSE LINE

If you have pulse service, you can still use special services that require tone signals, such as bank-by-phone, by following these steps.

1. Be sure **PULSE/TONE** is set to **PULSE**.
2. Dial the service's main number.
3. When the service answers, set **PULSE/TONE** to **TONE**. Any additional numbers dialed are sent as tone signals.
4. When you complete the call, set **PULSE/TONE** back to **PULSE**.

MEMORY DIALING

You can store emergency phone numbers or the phone numbers you call most frequently in the three priority memory locations for one-touch dialing. You can store 10 more phone numbers

in the indirect memory locations, then quickly call each number with a few key presses.

Each memory location can store up to 15 tone digits or 16 pulse digits.

Storing Numbers in Memory

Note: You will hear a dial tone during most steps of this procedure. The phone does not actually dial the number as you store it, but you might also hear a busy tone or recorded operator's voice after a few seconds. This is normal.

1. Lift the handset.
2. Press **STORE**.

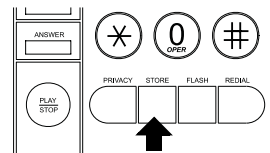

3. Enter the phone number you want to store.

Notes: If you make a mistake, hold down the switchhook for a few seconds, then release it and start over at Step 2.

4. Select the memory location for the number.

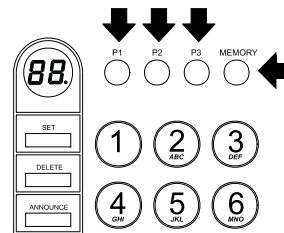

- For a priority memory location, press **P1**, **P2**, or **P3**.
 - For an indirect memory location, press **MEMORY**, then enter a two-digit memory location number (01–10).
5. To keep a record of each stored number, use a straightened paper clip to remove the plastic cover on the memory index card on the lower left of the base and write the name on the card. Use a pencil in case you want to change it later.

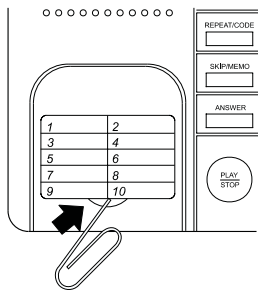

6. Repeat Steps 3–5 (without hanging up) to store more numbers. Then hang up the handset when you finish.

Dialing a Stored Number

To dial a priority memory number, lift the handset and press **P1**, **P2**, or **P3**.

To dial an indirect memory number, lift the handset and press **MEMORY**. Then press the keys for the two-digit memory location number for the number you want to call.

Testing Stored Emergency Numbers

If you store an emergency service's number (police department, fire department, ambulance) and you want to test the stored number, make the test call during the late evening or early morning hours to avoid peak demand periods. Remain on the line to explain the reason for your call.

Chain-Dialing Special Service Numbers

For quick recall of numbers for special services (such as alternate long-distance or bank-by-phone), you can store each group of numbers in its own memory location.

When calling special services, dial the service's main number first. At the appropriate place in the call, dial the appropriate memory number for the additional numbers you want to send (see "Dialing a Stored Number" on Page 13).

TAD OPERATION

RECORDING THE OUTGOING MESSAGE

Before you can set the TAD to answer calls, you must record an outgoing message (OGM). This is what the caller hears when the TAD answers a call. The outgoing message can be up to 60 seconds long.

Hint: Do not tell callers that you are not home. Instead, say that you cannot come to the phone right now.

Note: If memory is full (**FL** appears) when you attempt to record an outgoing message, the TAD announces, "Memory is full."

1. Hold down **ANNOUNCE**. The TAD beeps, and the display begins counting down from 60 seconds.

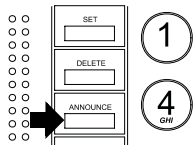

2. Speak your message in a normal voice about 8 inches from the front of the TAD.
3. When you finish, release **ANNOUNCE**. The TAD plays back the outgoing message so you can check it.

To hear your outgoing message at any time, press **ANNOUNCE**. To change your outgoing message, repeat Steps 1–3.

ADJUSTING THE TAD'S VOLUME

To adjust the TAD's volume, rotate **VOLUME** on the right side of the TAD.

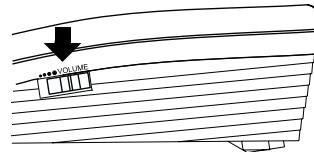

SETTING THE TAD TO ANSWER CALLS

To set the TAD to answer calls, press **ANSWER**. The TAD announces, "Answer on," and the ANSWER indicator appears in the message counter window.

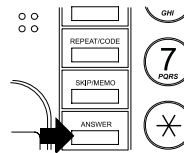

Note: If no outgoing message is recorded, the TAD says, "Answer off, no announcement." Record an outgoing message.

To set the TAD to not answer calls, press **ANSWER** again. The TAD says "Answer off," and the ANSWER indicator turns off.

RECORDING INCOMING MESSAGES

The maximum length for each incoming message is 60 seconds. If a recording reaches 55 seconds, the TAD beeps once to notify the caller that time will be up soon. If a recording reaches 60 seconds, the TAD beeps three times, then disconnects.

The TAD stops recording and resets to answer the next call when:

- the caller hangs up
- there are more than 8 seconds of silence
- you pick up any phone on the same line as the TAD

Note: To bypass the outgoing message, tell the caller to press * when the message begins. The TAD beeps once, and begins recording.

SCREENING CALLS

To screen calls, let the TAD answer, then listen to the caller's message through the TAD's speaker.

If you do not want to take the call, simply let the TAD finish recording the caller's message.

If you decide to answer the call, pick up this phone or any phone on the same phone line as the TAD. The TAD stops recording and resets to answer the next call.

Note: If you pick up the phone just as the TAD answers, the TAD might not stop playing the outgoing message. If this happens, press **STOP**.

PLAYING MESSAGES

The message counter shows the total number of messages, both old (ones you have listened to and saved) and new.

If there are new messages, the message counter flashes until all the new messages have been played.

To play only new messages, hold down **PLAY** for about 2 seconds. If there are no new messages stored, the TAD says, "No new message." If there are no messages stored, the TAD says, "No message."

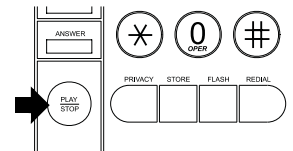

To play all messages, press **PLAY**. The TAD announces the number of messages recorded. Before playing each message, the TAD tells you the message's number and the day and time the message was recorded.

After all messages play, the TAD says, "End of messages."

To replay a message while you are listening to it, press **REPEAT**. The current message replays from the beginning.

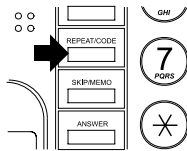

To return to the previous message, hold down **REPEAT** until its number appears. To hear earlier messages, repeat the procedure.

To skip to the next message, press **SKIP**. The next message plays.

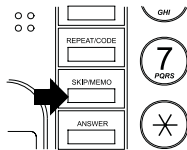

To pause a message, press **STOP**. **PA** (pause) appears. Press **STOP** again to resume playing messages.

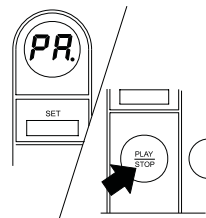

Note: If you do not resume playing messages within 60 seconds, the TAD beeps three times, stops playback, and

resets to answer calls. The total number of messages appears.

To stop playing messages, press **STOP** twice quickly. The TAD beeps and stops playback and resets to answer calls.

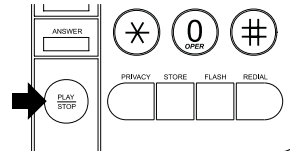

DELETING MESSAGES

To delete a specific message, press **DELETE** while the message is playing. The TAD beeps, then plays the next message.

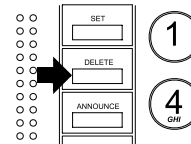

To delete all messages, stop playback, then hold down **DELETE** until the TAD beeps. The TAD erases all the messages you have listened to, and the number of remaining messages appears.

The TAD-759 does not delete new messages. If you have *only* new messages, the TAD announces "New messages" when you hold down **DELETE**.

RECORDING A MEMO

A memo is a message you can record at the TAD, without having to call in on the phone. The TAD-759 can record a memo of up to 60 seconds long.

To record a memo, hold down **MEMO**. The TAD beeps, and the display begins counting down from 60 seconds. Speak in a normal voice about 8 inches from the front of the TAD. When you finish, release **MEMO**.

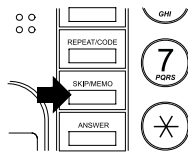

The memo is stored with the incoming messages. To hear the memo, simply play back your messages.

Note: If the TAD's memory is full (**FL** and the number of messages alternately appear on the display), you must erase some messages before you can record a memo.

CHANGING THE REMOTE OPERATION SECURITY CODE

The TAD-759's remote operation security code is preset to 759. Follow these steps to change the code.

Notes:

- Be sure to set each digit within 8 seconds. Otherwise, you must start over at Step 1.
- If AC power fails and the backup battery becomes weak, the remote operation security code automatically resets to 759.

1. Hold down **CODE** for about 2 seconds. The TAD beeps, and the first digit of the preset code flashes on the display.

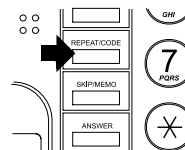

2. Press **SKIP** or **REPEAT** to set the first digit, then press **STOP**. The TAD beeps, and the second digit appears and flashes.

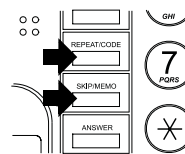

3. Press **SKIP** or **REPEAT** to set the second digit, then press **STOP**. The TAD beeps, and the third digit appears and flashes.
4. Press **SKIP** or **REPEAT** to set the third digit, then press **STOP**. The TAD beeps and shows the new security code in sequence.

To see the currently set code at any time, press **CODE**.

REMOTE OPERATION

While you are away from your home or office, you can use a touch-tone phone or a pulse (rotary) phone with a pocket tone dialer (available at your local RadioShack store) to enter your remote operation security code and do any of the following:

- set the TAD to answer or not answer calls
- listen to your messages
- record a new announcement
- delete messages
- monitor the room where the TAD is located

Note: You cannot remotely operate the TAD from another phone on the same line as your TAD-759.

USING TOLL-SAVER

If the ring select switch is set to **TS** (toll-saver, see “Setting the Number of Rings” on Page 10) the TAD answers after two rings if you have new messages. If there are no new messages, the TAD waits for four rings before it answers. This gives you time to hang up before the TAD answers so you can avoid unnecessary long-distance charges.

USING REMOTE COMMANDS

Follow these steps to operate the TAD from a touch-tone phone or a pulse (rotary) phone with a pocket tone dialer.

1. Dial your phone number.
2. When the TAD answers, enter your remote operation security code. The TAD beeps once to confirm that you entered the correct code.

Notes:

- If you do not enter each digit of the security code within 8 seconds, the TAD hangs up.
 - Even if the TAD is not set to answer calls, it will answer after about 60 seconds.
3. Enter a remote command (see “Remote Commands” on Page 19).
 4. When you finish, simply hang up.

Remote Commands

Press:	To:
0	Stop playback, recording, and room monitoring.
1	Play the outgoing message.
2	Record a new outgoing message.
3	Monitor the room where the TAD is located for 30 seconds.
4	Play all messages.
5	Play only new messages.
6	Delete messages. (The TAD will not delete messages that have not been played.)
#	Set the TAD to answer or not answer calls.

After you press **4** or **5** to play messages, you can:

Press:	To:
6	Delete the current message.
7	Replay the previous message.
8	Replay the current message.
9	Skip forward to the next message.
0	Stop message play.

TROUBLESHOOTING

We do not expect you to have any problems with your TAD-759, but if you do, the following suggestions might help.

Problem	Suggestion
There is no dial tone.	Check all phone line connections, including the handset cord.
The incoming message is incomplete.	Be sure the TAD's memory is not full.
	The caller's message was longer than 60 seconds.
	The caller was silent for more than 8 seconds.
L flashes on the message counter.	The backup battery is weak. Replace the battery (see "Installing a Backup Battery" on Page 6).
TAD does not answer calls.	Make sure the TAD is set to answer calls.
	Check all phone line connections.
	Make sure the AC adapter is properly connected.
TAD does not record callers' messages.	Memory may be full (FL appears). Delete some of your messages.
No messages appear on the message counter.	This could be caused by a power failure. Reset the TAD by removing the AC adapter and the battery from the TAD, then reconnect the adapter and reinstall the battery.
The TAD does not respond to the remote operation security code.	Make sure the phone you used to dial the TAD is a touch-tone phone. (If it is not, you can use a pocket tone dialer to enter the code and commands.)
	Make sure the remote operation security code you entered is correct. Try entering the default code of 759. The TAD may have reset to the default code because of a power failure.
	Re-enter your security code, pressing each button for 2 seconds.

If you still have problems, disconnect the phone. If other phones on the same line work properly, the fault is in this phone or its installation. If you cannot find the problem, take your TAD-759 to your local RadioShack store for assistance.

CARE AND MAINTENANCE

Your RadioShack TAD-759 Digital Answering System is an example of superior design and craftsmanship. The following suggestions will help you care for your TAD so you can enjoy it for years.



Keep the TAD dry. If it gets wet, wipe it dry immediately. Liquids might contain minerals that can corrode the electronic circuits.



Use and store the TAD only in normal temperature environments. Temperature extremes can shorten the life of electronic devices, damage batteries, and distort or melt plastic parts.



Keep the TAD away from dust and dirt, which can cause premature wear of parts.



Handle the TAD gently and carefully. Dropping it can damage circuit boards and cases and can cause the TAD to work improperly.



Use only fresh batteries of the required size and recommended type. Batteries can leak chemicals that damage your TAD's electronic parts.



Wipe the TAD with a damp cloth occasionally to keep it looking new. Do not use harsh chemicals, cleaning solvents, or strong detergents to clean the TAD.

Modifying or tampering with the TAD's internal components can cause a malfunction and might invalidate its warranty and void your FCC authorization to operate it. If your TAD is not performing as it should, take it to your local RadioShack store for assistance. If the trouble is affecting the telephone lines, the phone company can ask you to disconnect your TAD until you have resolved the problem.

THE FCC WANTS YOU TO KNOW

In the unlikely event that your TAD causes problems on the telephone line, the telephone company attempts to notify you in advance. If advance notice is not practical, the telephone company notifies you as soon as possible and advises you of your right to file a complaint with the FCC.

Also, the telephone company can make changes to its lines, equipment, operations, or procedures that could affect the operation of this TAD. The telephone company notifies you of these changes in advance so you can take the necessary steps to prevent interruption of your telephone services.

LIGHTNING

Your TAD has built-in protection circuits to reduce the risk of damage from surges in telephone and power line current. These protection circuits meet or exceed the FCC requirements. However, lightning striking the telephone or power lines can damage your TAD.

Lightning damage is not common. Nevertheless, if you live in an area that has severe electrical storms, we suggest that you unplug the TAD during storms to reduce the possibility of damage.

NOTES

Limited One-Year Warranty

This product is warranted by RadioShack against manufacturing defects in material and workmanship under normal use for one (1) year from the date of purchase from RadioShack company-owned stores and authorized RadioShack franchisees and dealers. EXCEPT AS PROVIDED HEREIN, RadioShack MAKES NO EXPRESS WARRANTIES AND ANY IMPLIED WARRANTIES, INCLUDING THOSE OF MERCHANTABILITY AND FITNESS FOR A PARTICULAR PURPOSE, ARE LIMITED IN DURATION TO THE DURATION OF THE WRITTEN LIMITED WARRANTIES CONTAINED HEREIN. EXCEPT AS PROVIDED HEREIN, RadioShack SHALL HAVE NO LIABILITY OR RESPONSIBILITY TO CUSTOMER OR ANY OTHER PERSON OR ENTITY WITH RESPECT TO ANY LIABILITY, LOSS OR DAMAGE CAUSED DIRECTLY OR INDIRECTLY BY USE OR PERFORMANCE OF THE PRODUCT OR ARISING OUT OF ANY BREACH OF THIS WARRANTY, INCLUDING, BUT NOT LIMITED TO, ANY DAMAGES RESULTING FROM INCONVENIENCE, LOSS OF TIME, DATA, PROPERTY, REVENUE, OR PROFIT OR ANY INDIRECT, SPECIAL, INCIDENTAL, OR CONSEQUENTIAL DAMAGES, EVEN IF RadioShack HAS BEEN ADVISED OF THE POSSIBILITY OF SUCH DAMAGES.

Some states do not allow the limitations on how long an implied warranty lasts or the exclusion of incidental or consequential damages, so the above limitations or exclusions may not apply to you.

In the event of a product defect during the warranty period, take the product and the RadioShack sales receipt as proof of purchase date to any RadioShack store. RadioShack will, at its option, unless otherwise provided by law: (a) correct the defect by product repair without charge for parts and labor; (b) replace the product with one of the same or similar design; or (c) refund the purchase price. All replaced parts and products, and products on which a refund is made, become the property of RadioShack. New or reconditioned parts and products may be used in the performance of warranty service. Repaired or replaced parts and products are warranted for the remainder of the original warranty period. You will be charged for repair or replacement of the product made after the expiration of the warranty period.

This warranty does not cover: (a) damage or failure caused by or attributable to acts of God, abuse, accident, misuse, improper or abnormal usage, failure to follow instructions, improper installation or maintenance, alteration, lightning or other incidence of excess voltage or current; (b) any repairs other than those provided by a RadioShack Authorized Service Facility; (c) consumables such as fuses or batteries; (d) cosmetic damage; (e) transportation, shipping or insurance costs; or (f) costs of product removal, installation, set-up service adjustment or reinstallation.

This warranty gives you specific legal rights, and you may also have other rights which vary from state to state.

RadioShack Customer Relations, 200 Taylor Street, 6th Floor, Fort Worth, TX 76102

We Service What We Sell

04/99

RadioShack
A Division of Tandy Corporation
Fort Worth, Texas 76102

Free Manuals Download Website

<http://myh66.com>

<http://usermanuals.us>

<http://www.somanuals.com>

<http://www.4manuals.cc>

<http://www.manual-lib.com>

<http://www.404manual.com>

<http://www.luxmanual.com>

<http://aubethermostatmanual.com>

Golf course search by state

<http://golfingnear.com>

Email search by domain

<http://emailbydomain.com>

Auto manuals search

<http://auto.somanuals.com>

TV manuals search

<http://tv.somanuals.com>