

Cat. No. 43-779
OWNER'S MANUAL

Please read before using this equipment.

TAD-779

Digital Telephone Answering System with Day/Time Voice Stamp

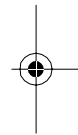
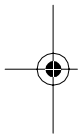

RadioShack®

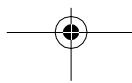

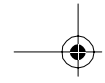

FEATURES



Your RadioShack TAD-779 Digital Telephone Answering System is a high-quality telephone answering device (TAD) that you can also control remotely from any touch-tone phone. With an optional pocket tone dialer, you can even use it from a rotary phone.

The TAD-779 stores messages on a computer chip. This gives you advanced capabilities over tape-based answering machines. For example, you can delete an individual message by using remote commands. Because your TAD is fully digital, there are no tapes to bother with and no tape mechanisms to wear out.

The TAD-779's 16-minute capacity lets you store a lot of messages. And its unique, space-saving design makes it ideal for any office or nightstand.

The TAD-779 has these features:

Digital Message Storage — lets you record up to 16 minutes of messages and memos. Each incoming message can be up to 60 seconds long.

Day/Time Voice Stamp — announces the day and time that each message was recorded.

New Message Indicator — indicates that you have new messages.

Phone Pick-Up Detection — stops recording when you pick up any phone on the same line as the TAD.

Remote Operation — lets you use a touch-tone phone (or rotary phone and pocket tone dialer) to operate the TAD while you are away from your home or office.

Programmable Remote Operation Security Code — lets you set your own security code for remote operation.

Digital Outgoing Message — lets you record a clear outgoing message of up to 60 seconds.

Memory Backup — protects stored messages in case of a power failure.

Adjustable Ring Selection — lets you set the TAD-779 to answer the telephone after four or seven rings.

Toll-Saver — lets you avoid unnecessary long-distance charges when you call to check your messages.

Call Screening — lets you listen to incoming calls so you can decide whether or not to answer.

Memo Recording — lets you leave messages for yourself or others in your home or office.

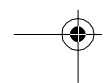
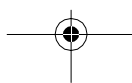



This TAD has been tested and found to comply with all applicable UL and FCC standards.

READ THIS BEFORE INSTALLATION

Your TAD-779 conforms to federal regulations, and you can connect it to most telephone lines. However, each device you connect to the phone line draws power from the phone line. We refer to this power draw as the device's *ringer equivalence number*, or REN. The REN is on the label on the bottom of the TAD.

If you are using more than one device on the line, add up all the RENs. If the total is more than five, your phone might not ring and your TAD might not answer. In rural areas, a total REN of three might impair ringer operation. If ringer operation is impaired, remove one of the devices from the line.

WARNING: To reduce the risk of fire or shock hazard, do not expose this product to rain or moisture.

	CAUTION RISK OF ELECTRIC SHOCK. DO NOT OPEN.	
CAUTION: TO REDUCE THE RISK OF ELECTRIC SHOCK, DO NOT REMOVE COVER OR BACK. NO USER-SERVICEABLE PARTS INSIDE. REFER SERVICING TO QUALIFIED PERSONNEL.		



This symbol is intended to alert you to the presence of uninsulated dangerous voltage within the product's enclosure that might be of sufficient magnitude to constitute a risk of electric shock. Do not open the product's case.



This symbol is intended to inform you that important operating and maintenance instructions are included in the literature accompanying this product.

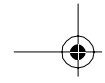

FCC STATEMENT

Your TAD-779 complies with Part 68 of *FCC Rules*. You must, upon request, provide the FCC registration number and the REN to your phone company. Both numbers are on the label on the bottom of the TAD.

Note: You must not connect your TAD to:

- coin-operated systems
- party-line systems
- most electronic key phone systems

Your TAD-779 complies with the limits for a Class B digital device as specified in Part 15 of *FCC Rules*. These limits provide reasonable protection against radio and TV interference in a residential area. However, your TAD might cause TV or radio interference even when it is operating properly.

To eliminate interference, you can try one or more of the following corrective measures:

- Reorient or relocate the receiving radio or TV antenna.
- Increase the distance between the TAD and the radio or TV.
- Use outlets on different electrical circuits for the TAD and the radio or TV.

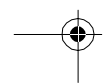
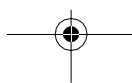

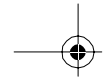

CONTENTS

Preparation	6
Choosing a Location	6
Installing a Backup Battery	6
Connecting the TAD	6
Setting the Day and Time	7
Recording the Outgoing Message	9
Setting the Number of Rings	9
Operation	10
Setting the TAD to Answer Calls	10
Incoming Message Recording	10
Screening Calls	10
Playing Messages	11
Deleting Messages	11
Recording a Memo	11
Changing the Remote Operation Security Code	12
Remote Operation	13
Using the Toll-Saver	13
Using Remote Commands	13
Troubleshooting	15
Resetting the TAD-779	15
Care and Maintenance	16
The FCC Wants You to Know	17
Lightning	17

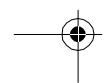
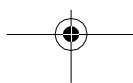

PREPARATION

CHOOSING A LOCATION

Select a location for the TAD that is near a modular telephone line jack and an AC outlet, and is not in the way of normal activities.

INSTALLING A BACKUP BATTERY

If the AC power fails or you unplug the TAD, a 9V backup battery (not supplied) saves the messages and the settings for the day, time, and remote operation security code. We recommend you use an alkaline battery, such as RadioShack Cat. No. 23-553.

Caution: Always use a fresh battery of the required size and recommended type.

1. Use a Phillips screwdriver to remove the battery compartment cover's screw, then slide the cover in the direction of the arrow and lift it off.

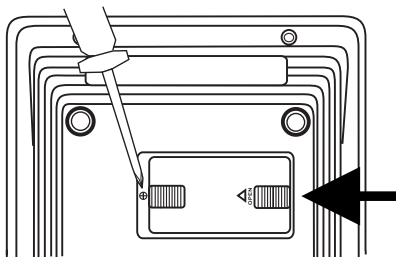

2. Snap the battery's contacts firmly to the battery connector and place the battery in the compartment.

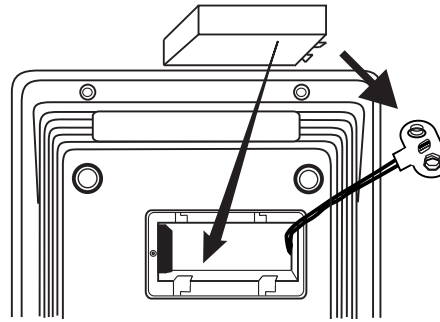

3. Replace the cover.

Replace the battery when the **ANSWER** indicator flashes.

Cautions:

- Always remove an old or weak battery. Batteries can leak chemicals that can destroy electronic parts.
- Dispose of the old battery promptly and properly. Do not bury or burn it.
- To avoid losing stored information, be sure the AC adapter is plugged in and connected to the TAD before you replace the battery.

CONNECTING THE TAD

Notes:

- Your TAD connects directly to a modular phone line jack. If your line jack is not modular, you can update it yourself, using jacks and adapters available at your local RadioShack store. Or, you can let the phone company update it for you.

- The USOC number of the jack to be installed is RJ11C.

Follow these steps to connect your TAD to the telephone line and phone.

Illus. of TO TEL jack and connection to a phone. Show other phone cord already connected.

1. Unplug the telephone's modular cord from the modular phone line jack and plug it into the **TO TEL** jack on the back of the TAD.
2. Plug one end of the supplied modular telephone cord into the **TO LINE** jack on the back of the TAD.
3. Plug the cord's other end into a modular phone line jack.

Note: Adjust **VOLUME** to the middle position before connecting power.

Illus. of VOLUME switch.

Caution: The supplied AC adapter was designed specifically for your TAD-779. Use only the supplied adapter.

4. Insert the supplied AC adapter's barrel plug into the **AC 9V** jack on the back of the TAD-779. Plug the adapter's other end into a standard AC outlet.

Illus. of AC 9V/440mA jack. Show other phone cords already connected.

When you first connect power, the TAD runs a self-test. When the test is complete (about 17 seconds), the TAD beeps and announces, "Answer off."

Note: When you first connect power, the PLAY/SKIP indicator flashes, indicating that you have not recorded an outgoing message. If you have not installed a backup battery, the ANSWER indicator also flashes.

Illus. of ANSWER and PLAY/SKIP indicators.

SETTING THE DAY AND TIME

To avoid losing the day and time settings if AC power fails, we recommend you install a backup battery before you set the day and time (see "Installing a Backup Battery" on Page 6).

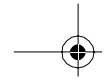

Follow these steps so the TAD can record the correct day and time each message and memo is recorded.

Note: If you do not complete each step within 8 seconds, the TAD-779 sounds three beeps and exits from setup. Start again at Step 1.

1. Use a pointed object such as a straightened paper clip to hold down **CLOCK** until the TAD-779 beeps and announces the currently set day.

Illus. showing CLOCK button.

2. To change the day of the week, repeatedly press **REPEAT** to move backward or **SKIP** to move forward until the TAD announces the desired day of the week.

Illus. showing OGM/REPEAT and PLAY/SKIP.

3. Press **STOP**. The TAD-779 beeps and announces the hour.

Illus. showing ANSWER/STOP/DELETE.

4. To change the hour, repeatedly press **REPEAT** or **SKIP**.

5. Press **STOP**. The TAD-779 beeps and announces the minutes.

6. To change the minutes, repeatedly press **REPEAT** or **SKIP**.

Note: To change the time in 10-minute increments, hold down **REPEAT** or **SKIP**.

7. Press **STOP** to confirm the settings. The TAD beeps and announces the day and time.

To check the current day and time at any time, use a pointed object such as a straightened paper clip to press **CLOCK**.

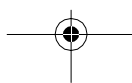

RECORDING THE OUTGOING MESSAGE

Before the TAD can answer calls and record messages, you must record an outgoing message. Your outgoing message can be up to 60 seconds long.

Hint: Do not tell callers you are not home. Instead, say that you cannot come to the phone right now.

Follow these steps to record your outgoing message or to change your current message.

1. Hold down **OGM** (outgoing message) until the TAD beeps.

Note: If you try to record an outgoing message when the TAD's memory is full, the PLAY/SKIP indicator flashes rapidly and the TAD announces, "Memory is full." You must delete some messages to make room in memory (see "Deleting Messages" on Page 11).

2. Speak your message from about 8 inches in front of the TAD.

Illus. showing microphone.

3. When you finish, press **STOP**. The TAD beeps and plays back the outgoing message.

To check your outgoing message at any time, press **OGM**. If no outgoing message is recorded, the TAD-779 says, "No announcement."

SETTING THE NUMBER OF RINGS

Set the ring select switch to **4**, **7**, or **TS** to set how long the TAD waits before it answers a call (4 rings, 7 rings or toll-saver).

Illus. showing 4/7/TS switch.

If you plan to check your messages by long distance, set the ring select switch to **TS** (see "Using the Toll-Saver" on Page 13).

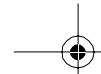

OPERATION



SETTING THE TAD TO ANSWER CALLS

After you have recorded an outgoing message, you can set the TAD to answer calls.

To set the TAD-779 to answer calls, press **ANSWER**. The TAD announces, "Answer on," and the ANSWER indicator lights.

*Illus. flash
on Answer
light.*

- the maximum message length is reached
- there are more than 8 seconds of silence
- you pick up any phone on the same phone line as the TAD

If the TAD's memory becomes full, it answers a call after two rings and announces, "Memory is full." Delete some of the old messages to make room in memory (see "Deleting Messages" on Page 11).

Note: The maximum recording capacity is 16 minutes.



To set the TAD to not answer calls, press **ANSWER** again. The TAD announces, "Answer off," and the ANSWER indicator turns off.

SCREENING CALLS

To screen calls, let the TAD answer them, then listen to the caller's message through the TAD's speaker.

To adjust the volume, slide **VOLUME** on the right side of the TAD.

If you decide to answer the call, pick up any phone on the same phone line as the TAD. The TAD stops recording and resets to answer the next call.

If you do not want to take the call, simply let the TAD finish recording the caller's message.

INCOMING MESSAGE RECORDING

When the TAD is set to answer calls, it plays the outgoing message, then beeps. The caller can then record a message up to 60 seconds long.

The TAD hangs up and resets to answer the next call when:

- the caller hangs up

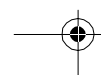
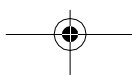

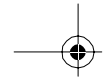

Note: If you answer the phone just as the TAD answers, the TAD might not stop playing the outgoing message. If this happens, press **STOP** on the TAD.

PLAYING MESSAGES

When you have new messages, the **PLAY/SKIP** indicator flashes.

To play all the messages, press **PLAY**. The TAD announces the number of messages. If there are no messages stored, it announces, "No message."

To replay a previous message, press **REPEAT** within 5 seconds after the current message starts playing.

To skip to the next message during playback, press **SKIP**.

To pause during playback, press **STOP**. To resume playback, press **PLAY** within 60 seconds. Otherwise, the TAD sounds three beeps and stops playback.

To stop playback at any time, press **STOP** twice. The TAD beeps and resets to answer calls.

Illus. showing PLAY/SKIP.

DELETING MESSAGES

To delete the messages you have already heard, stop playback (if necessary) then hold down **DELETE** until the TAD sounds a long beep.

Notes:

- If you have played only a portion of a message, the TAD-779 might not delete it.
- Individual messages can only be deleted during remote operation.

Before playing each message, the TAD announces the message number and the day and time the message was recorded. After all messages play, the **PLAY/SKIP** indicator lights steadily and the TAD announces, "End of messages," then resets to answer calls.

To replay the current message, if you have listened to at least 5 seconds of it, press **REPEAT**. The current message starts from the beginning.

RECORDING A MEMO

A memo is a message you can record at the TAD for yourself or others without having to call in on the phone. Each memo can be up to 60 seconds long.

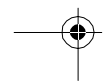
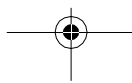

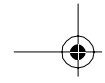

Memos are stored with incoming messages and are replayed the same way (see "Playing Messages").

Follow these steps to record a memo.

1. Hold down **PLAY** until the TAD beeps.
2. Speak your memo from about 8 inches in front of the TAD.
3. When you finish, press **STOP**. The TAD beeps and is ready to answer messages.

1. Use a pointed object, such as a straightened paper clip, to hold down **CODE** until the TAD-779 beeps and announces the first digit of the current security code.

*Illus. showing
CODE switch.*

CHANGING THE REMOTE OPERATION SECURITY CODE

The TAD's remote operation security code is preset to 779. Follow these steps to change it to a number from 000 to 999.

Notes:

- Be sure to complete each step within 8 seconds. Otherwise, the TAD sounds three beeps and exits. Start over at Step 1.
- If AC power fails or if the backup battery becomes weak, the remote operation security code automatically resets to 779.

2. Repeatedly press **SKIP** or **REPEAT** to set the first digit, then press **STOP**. The TAD beeps and announces the second digit.
3. Repeatedly press **SKIP** or **REPEAT** to set the second digit, then press **STOP**. The TAD beeps and announces the third digit.
4. Repeatedly press **SKIP** or **REPEAT** to set the third digit, then press **STOP**. The TAD beeps once and announces the complete remote operation security code.

To check the remote operation security code at any time, press **CODE**. The TAD announces the currently set security code.

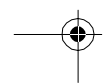
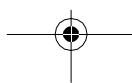
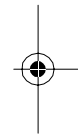
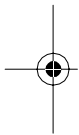

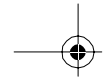

REMOTE OPERATION

While you are away from your home or office, you can use a touch-tone phone or a pulse (rotary) phone with a pocket tone dialer to enter your remote operation security code and do any of the following:

- set the TAD to or not answer calls
- listen to your messages
- record a new outgoing message
- delete messages

Note: You cannot remotely operate the TAD from another phone on the same line as your TAD-779.

USING THE TOLL-SAVER

If the ring select switch is set to **TS** (toll-saver) (see "Setting the Number of Rings" on Page 9), the TAD answers after two rings if you have new messages. If there are no new messages, the TAD waits for four rings before it answers. This gives you time to hang up before the TAD answers so you can avoid unnecessary long-distance charges.

USING REMOTE COMMANDS

Follow these steps to operate the TAD remotely.

1. Dial your phone number.

Note: Even if the TAD is not set to answer calls, it will answer after about 10 rings.

2. When the TAD answers, enter your remote operation security code. The TAD beeps to confirm that you entered the correct code.

Note: If you do not enter each digit of the security code within 8 seconds of the last, the TAD hangs up.

3. Enter the remote command. See "Remote Commands" on Page 14.
4. You can hang up at this point or enter other remote commands.

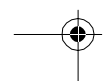
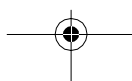

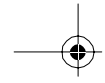

Remote Commands

While playing messages:

Press:	To:
0	Stop message playback and recording.
1	Play the outgoing message.
2	Record a new outgoing message. When the TAD announces "Record announcement," begin speaking. When you finish, press 0 . The TAD repeats the OGM.
4	Play all the recorded messages.
6	Delete all reviewed messages.
#	Set the TAD to answer or not answer calls.

Press:	To:
6	Delete the current message.
7	Replay the previous message.
8	Replay the current message.
9	Skip forward to the next message.
0	Stop message playback.

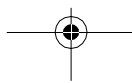

TROUBLESHOOTING

We do not expect you to have any problems with your TAD-779, but if you do, try these suggestions.

Problem	Suggestion
The incoming message is incomplete.	Be sure the TAD's memory is not full.
	Use your outgoing message to tell callers that they have 60 seconds to record their message.
	The caller was silent for more than 8 seconds.
The incoming message is unclear.	Adjust VOLUME .
	Check all phone line connections.
The TAD does not answer after four or seven rings.	Be sure the TAD is set to answer calls.
	Check all phone line connections.
	Be sure the AC adapter is properly connected.
ANSWER indicator flashes.	The backup battery is weak or missing. Replace the battery (see "Installing the Backup Battery" on Page 5).
The TAD-779 does not respond to the remote operation security code.	Make sure the phone you used to dial the TAD is a touch-tone phone. If it is not, you can use a pocket tone dialer to remotely operate the TAD.
	Re-enter your remote operation security code.
	Enter the default remote operation security code (779). The code might have been reset due to a power failure.

If the TAD still does not operate properly, try resetting it (see "Resetting the TAD-779") or take it to your local RadioShack store for assistance.

RESETTING THE TAD-779

If your TAD-779 stops working properly, disconnect the AC adapter, remove the battery, then reinstall the battery and connect the AC adapter.

Note: All information stored in memory is erased when you reset the TAD.

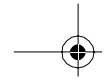

CARE AND MAINTENANCE



Your RadioShack TAD-779 Digital Telephone Answering System is an example of superior design and craftsmanship. The following suggestions will help you care for the TAD-779 so you can enjoy it for years.



Keep the TAD-779 dry. If it gets wet, wipe it dry immediately. Liquids might contain minerals that can corrode the electronic circuits.



Use and store the TAD-779 only in normal temperature environments. Temperature extremes can shorten the life of electronic devices, damage batteries, and distort or melt plastic parts.



Keep the TAD-779 away from dust and dirt, which can cause premature wear of parts.



Handle the TAD-779 gently and carefully. Dropping it can damage circuit boards and cases and can cause the TAD to work improperly.



Use only a fresh battery of the required size and type. Batteries can leak chemicals that damage your TAD-779's electronic parts.



Wipe the TAD-779 with a damp cloth occasionally to keep it looking new. Do not use harsh chemicals, cleaning solvents, or strong detergents to clean the TAD.

Modifying or tampering with the TAD-779's internal components can cause a malfunction and might invalidate your TAD's warranty and void your FCC authorization to operate it. If your TAD-779 is not performing as it should, take it to your local RadioShack store for assistance. If the trouble is affecting the telephone lines, the phone company can ask you to disconnect your TAD until you have resolved the problem.

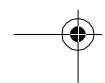
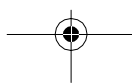

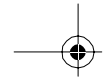

THE FCC WANTS YOU TO KNOW

In the unlikely event that your TAD-779 causes problems on the telephone line, the telephone company can temporarily discontinue your service. If this happens, the telephone company attempts to notify you in advance. If advance notice is not practical, the telephone company notifies you as soon as possible and advises you of your right to file a complaint with the FCC.

Also, the telephone company can make changes to its lines, equipment, operations, or procedures that could affect the operation of this TAD. The telephone company notifies you of these changes in advance so you can take the necessary steps to prevent interruption of your telephone services.

LIGHTNING

Your TAD-779 has built-in protection circuits to reduce the risk of damage from surges in telephone line and power line current. These protection circuits meet or exceed the FCC requirements. However, lightning striking the telephone or power lines can damage your TAD.

Lightning damage is not common. Nevertheless, if you live in an area that has severe electrical storms, we suggest that you unplug the TAD-779 during storms to reduce the possibility of damage.

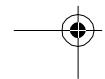
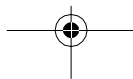

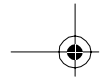

NOTES

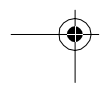
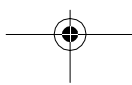
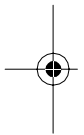

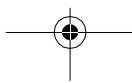
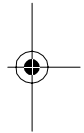

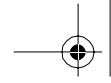

Limited One-Year Warranty

This product is warranted by RadioShack against manufacturing defects in material and workmanship under normal use for one (1) year from the date of purchase from RadioShack company-owned stores and authorized RadioShack franchisees and dealers. EXCEPT AS PROVIDED HEREIN, RadioShack MAKES NO EXPRESS WARRANTIES AND ANY IMPLIED WARRANTIES, INCLUDING THOSE OF MERCHANTABILITY AND FITNESS FOR A PARTICULAR PURPOSE, ARE LIMITED IN DURATION TO THE DURATION OF THE WRITTEN LIMITED WARRANTIES CONTAINED HEREIN. EXCEPT AS PROVIDED HEREIN, RadioShack SHALL HAVE NO LIABILITY OR RESPONSIBILITY TO CUSTOMER OR ANY OTHER PERSON OR ENTITY WITH RESPECT TO ANY LIABILITY, LOSS OR DAMAGE CAUSED DIRECTLY OR INDIRECTLY BY USE OR PERFORMANCE OF THE PRODUCT OR ARISING OUT OF ANY BREACH OF THIS WARRANTY, INCLUDING, BUT NOT LIMITED TO, ANY DAMAGES RESULTING FROM INCONVENIENCE, LOSS OF TIME, DATA, PROPERTY, REVENUE, OR PROFIT OR ANY INDIRECT, SPECIAL, INCIDENTAL, OR CONSEQUENTIAL DAMAGES, EVEN IF RadioShack HAS BEEN ADVISED OF THE POSSIBILITY OF SUCH DAMAGES.

Some states do not allow the limitations on how long an implied warranty lasts or the exclusion of incidental or consequential damages, so the above limitations or exclusions may not apply to you.

In the event of a product defect during the warranty period, take the product and the RadioShack sales receipt as proof of purchase date to any RadioShack store. RadioShack will, at its option, unless otherwise provided by law: (a) correct the defect by product repair without charge for parts and labor; (b) replace the product with one of the same or similar design; or (c) refund the purchase price. All replaced parts and products, and products on which a refund is made, become the property of RadioShack. New or reconditioned parts and products may be used in the performance of warranty service. Repaired or replaced parts and products are warranted for the remainder of the original warranty period. You will be charged for repair or replacement of the product made after the expiration of the warranty period.

This warranty does not cover: (a) damage or failure caused by or attributable to acts of God, abuse, accident, misuse, improper or abnormal usage, failure to follow instructions, improper installation or maintenance, alteration, lightning or other incidence of excess voltage or current; (b) any repairs other than those provided by a RadioShack Authorized Service Facility; (c) consumables such as fuses or batteries; (d) cosmetic damage; (e) transportation, shipping or insurance costs; or (f) costs of product removal, installation, set-up service adjustment or reinstallation.

This warranty gives you specific legal rights, and you may also have other rights which vary from state to state.

RadioShack Customer Relations, Dept. W, 100 Throckmorton St., Suite 600, Fort Worth, TX 76102

We Service What We Sell

3/97

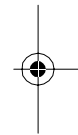
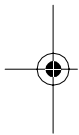

RadioShack
A Division of Tandy Corporation
Fort Worth, Texas 76102

11A98

Printed in China

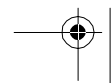
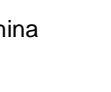
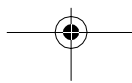

Free Manuals Download Website

<http://myh66.com>

<http://usermanuals.us>

<http://www.somanuals.com>

<http://www.4manuals.cc>

<http://www.manual-lib.com>

<http://www.404manual.com>

<http://www.luxmanual.com>

<http://aubethermostatmanual.com>

Golf course search by state

<http://golfingnear.com>

Email search by domain

<http://emailbydomain.com>

Auto manuals search

<http://auto.somanuals.com>

TV manuals search

<http://tv.somanuals.com>