



## Model V10

# Mobile Satellite TV Antenna with FastFind Remote

## *Installation and Operating Manual*

MADE IN THE U.S.A.

1. INTRODUCTION .....	2
2. BACKGROUND .....	3
3. COMPONENT OVERVIEW and SPECIFICATIONS.....	4
4. FCC USER'S INFORMATION .....	5
5. INSTALLATION .....	6-9
6. OPERATION .....	10-11
7. TROUBLESHOOTING.....	11
8. MAINTENANCE.....	12
9. LIMITED WARRANTY .....	12

## Introduction

Congratulations on your purchase of the Vu Qube V10. The Vu Qube V10 is equipped with a FastFind remote enabling you to quickly position the Vu Qube antenna from inside your vehicle. The Vu Qube V10 is compatible with any service provider including DIRECTV®, DISH Network® or Bell ExpressVu.®

This manual includes:

- Brief background on satellite television
- Components overview
- Installation diagrams and instructions
- Operating Instructions

The satellite broadcast market is continually changing and expanding. The information in this manual was accurate at the time of printing. If the Vu Qube does not operate as shown in this manual, please call Wallace Technologies at 1-866-802-2228 or email us at [info@vuqube.com](mailto:info@vuqube.com).

## Technical Support

**Phone:** (866) 802-2228

**Email:** [info@vuqube.com](mailto:info@vuqube.com)

**Web:** [www.vuqube.com](http://www.vuqube.com)

A Quick Reference guide is included with the Operating Instructions & Elevation information. We suggest you keep this reference guide with the Vu Qube Controller or near your Satellite TV receiver.

## Background

Satellites used for television signals are 22,300 miles (37,000 km) above the earth's equator. The purpose of the Vu Qube is to acquire the signal traveling that great distance and transmit the signal to the digital receiver in your vehicle, so you can watch TV anywhere you park.

Satellite television, like other communications relayed by satellite, starts with a transmitting antenna located at an uplink facility on Earth. The uplink dish is pointed toward a specific satellite and the uplinked signals are transmitted. The signal transmitted to the satellite is within a specific frequency range and is received by one of the transponders tuned to that frequency range aboard that satellite. The transponder then transmits the signals back to Earth but at a different frequency band (to avoid interference with the uplink signal). The leg of the signal path from the satellite to the receiving Earth station, in this case the Vu Qube, is called the downlink.

The downlinked satellite signal, quite weak after traveling a great distance is received by the Vu Qube antenna, which reflects the weak signal to a focal point that gets transferred to a feedhorn. **The receiving antenna must have a clear view, without obstruction, of the southern sky to maximize the signal acquired.** This signal is then amplified and converted by the LNBf (Low-noise block converter feed) to a signal that is sent via a co-axial cable to the receiver. Once the signal is transmitted from the Vu Qube to your receiver, you can enjoy satellite television programming in your vehicle just like at home!

# Vu Qube V10 Component Overview

Manual



Quick Reference Guide



Vu Qube Antenna



Vu Qube FastFind Remote



RG6 Coaxial Cable (20')



## Mounting Kit (Purchased Separately)

Kit shown is Model Number 31100

\*\*\*You will need to supply your own fasteners to attach a Vu Qube bracket to your vehicle. Depending on the cab material, fasteners such as lag screws, well nuts, sheet metal screws, toggle bolts and T anchors may be used; fasteners should always be used in combination with compatible sealant to environmentally seal the holes after installation.\*\*\*



Items needed to watch TV	Tools needed for installation
Satellite TV service Satellite TV receiver Television	Drill and drill bits Tape measure Screwdrivers and wrenches Adhesive sealant (compatible with vehicle material) Fasteners to secure components and wiring

## SPECIFICATIONS

<b>Height:</b>	17.5"
<b>Width:</b>	16"
<b>Weight:</b>	10.5 lbs
<b>Range:</b>	US/Southern Canada
<b>Compatibility:</b>	DIRECTV, Dish Network, Bell ExpressVu, Free-to-air receivers
<b>Operating Temp:</b>	May experience difficulty positioning antenna when temperatures are below 0°F

# FCC User Information

## Main Components

<b>Vu Qube V10 Antenna</b>	<b>Vu Qube V10 Remote</b>
<p>Part #: VQV10 FCC ID: UUM10156V10 IC: 6873A -10156V10</p> 	<p>Part #: VQV10R FCC ID: UUM10157V10 IC: 6873A -10157V10</p> 
<p>This device complies with Part 15 of the FCC rules. Operation is subject to the following two conditions: 1) This device must not cause harmful interference, and 2) This device must accept interference received including interference that may cause undesired operation.</p>	<p>This device complies with Part 15 of the FCC rules. Operation is subject to the following two conditions: 1) This device must not cause harmful interference, and 2) This device must accept interference received including interference that may cause undesired operation.</p>

**Please note that changes or modifications to the Vu Qube V10 or Vu Qube V10 remote not expressly approved by Wallace Technologies could void the purchaser's or user's authority to operate this equipment.**

**This device must not be co-located with other transmitters to ensure compliance with FCC RF exposure requirements.**

The Vu Qube V10 and Vu Qube V10 remote have been tested and found to comply with the limits for a Class B digital device, pursuant to part 15 of the FCC Rules. These limits are designed to provide reasonable protection against harmful interference in a residential installation. This equipment generates, uses, and can radiate radio frequency energy and, if not installed and used in accordance with the instruction, may cause harmful interference to radio communications. However, there is no guarantee that the interference will not occur in a particular installation. If this equipment does cause harmful interference to radio or television reception, which can be determined by turning the equipment off and on, the user is encouraged to try to correct the interference by one or more of the following measures:

- Reorient or relocate the receiving antenna.
- Increase the separation between the equipment and the receiver.
- Connect the equipment into an outlet on a circuit different from that to which the receiver is connected.
- Consult the dealer or an experienced radio/TV technician for help.

# Installation

## Overview of Installation

- The Vu Qube is designed to be mounted to a vehicle (Figure 1).
- Install with coaxial cable connector facing side of vehicle you will run coaxial cable.
- It is recommended to install the Vu Qube with a minimum of 4" of the top cover above the highest point of the cab or air shield (Figure 1) and away from interfering objects like smoke stacks.
- The coaxial cable needs to enter the Cab to be connected to the satellite receiver.

**Figure 1.** It is recommended to have a minimum of 4" of the VuQube above the highest point on the cab, including the air shield. It is also recommended to be as far away as possible from any object that may obstruct direct line of sight of the antenna to the southern sky. Such interfering items may include air-conditioner units, logistic devices and brackets, beacons and smoke stacks.

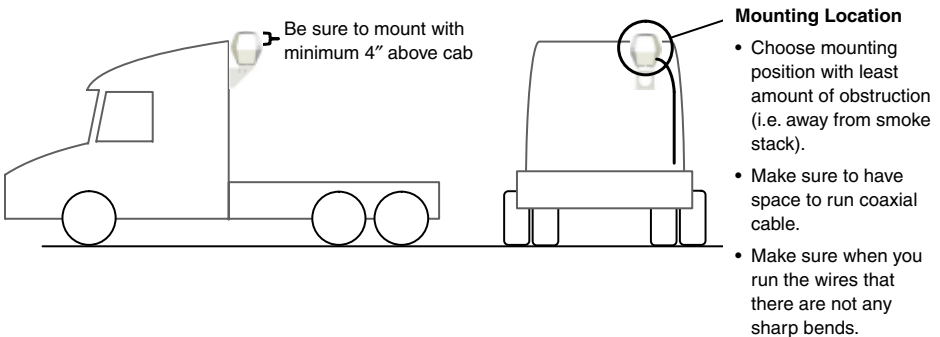

**Figure 2.** Face connections for wiring towards the back of the cab.

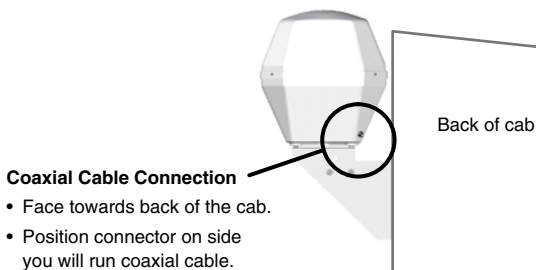

# Installation (continued)

## Mounting the bracket and selecting location to run wiring

NOTE: Instructions for mounting the Vu Qube is illustrated in this manual using Mounting Bracket Kit part number 31100. This Mounting Bracket Kit and others were designed specifically to mount the Vu Qube to the back of a truck cab. Please contact Wallace Technologies, LLC (866-802-2228) regarding other bracket options.

**1. Select and mark both area on back of cab to mount the bracket AND location to run coaxial cable from the Vu Qube to the inside of the cab.**

- Coaxial cable connection should face side of vehicle you will run coaxial cable.
- Be sure at least 4" of Vu Qube is above the highest part of the roof so that the antenna can receive adequate signal. The clearance of the Vu Qube is important because the antenna requires a direct line of sight to the satellite in the southern sky to acquire a clear signal.

NOTE: If you are unable to install the Vu Qube 4" above the cab due to height restriction, install with the maximum available clearance. With less of the Vu Qube top cover above the cab, there may be difficulty acquiring satellite signal in the Northeastern US (Maine, New Hampshire, Vermont and Massachusetts).

- The Vu Qube requires a 16" wide space to be mounted.
- Make sure you allow enough space for the wiring so that the co-axial cable does not have a sharp bend.
- It is best to select a position on the rear of the cab free from obstruction. Obstructions like smoke stacks, brackets, and air-conditioning units may interfere with satellite signal or prevent the satellite signal from reaching the Vu Qube.
- The Vu Qube must be mounted to the cab of the vehicle. Mounting directly to the frame (i.e. Headache Rack) will void the warranty.

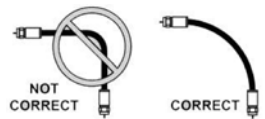

# Installation (continued)

2. **Drill holes for mounting bracket with proper size depending on fasteners used.**

NOTE: The installer is responsible for determining the most appropriate fastener to secure the bracket to the cab. Depending on the cab material, fasteners such as lag screws, well nuts, sheet metal screws, toggle bolts and T anchors may be used. Fasteners should always be used in combination with compatible sealant to environmentally seal the holes after installation.

3. **Mount bracket to cab using fasteners.**
4. **Seal holes with a sealant compatible with cab, faring, or air shield material, depending on where Vu Qube is mounted.**
5. **Drill hole to pass the harnesses inside the vehicle.**

NOTE: It is an option to run the wiring down the back of the cab and up into the cab through an access bay.

## Mounting Antenna to Bracket

1. **Place Vu Qube on bracket.**
  - Coaxial cable connections from the Vu Qube (Figure 2) should be positioned toward the cab (front of the vehicle) and to side where hole is drilled to run wires inside the cab.

Figure 2. Face connections for wiring towards the back of the cab.

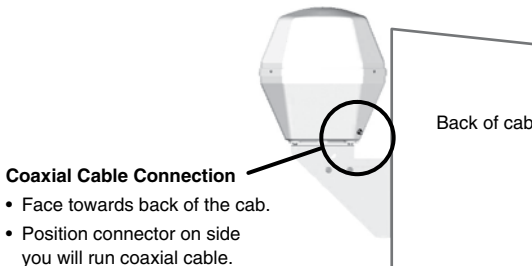

2. **Secure Vu Qube to bracket by fastening with nuts provided. Be sure to tighten nuts adequately to ensure Vu Qube is securely in place.**



# Installation (continued)

## Wiring

1. **Connect 20' coaxial to Vu Qube.**
2. **Pass 20' coaxial cable through hole previously drilled.**

NOTE: It is an option to run the wiring down the back of the cab and up into the cab through an access bay.

3. **Connect coaxial cable from Vu Qube to SATELLITE IN port on satellite receiver.**
4. **Make sure satellite receiver is connected to TV per manufacturer's instructions.**

# Vu Qube V10 Operation

- **IMPORTANT! CLEAR LINE OF SIGHT** for Vu Qube Antenna to the **SOUTHERN SKY REQUIRED**. Physical obstruction (i.e., smoke stacks, buildings, trees, telephone poles, etc.) can block the satellite signal from reaching the antenna.
- **Satellite TV and receiver technology are constantly changing.** If you experience difficulty contact (866) 802-2228.

## Finding the Satellite and Acquiring a Signal

NOTE: Satellite Receiver and TV MUST be ON

### 1. Determine Dish Elevation

Options: Enter Zip Code in System Set-up on receiver

-or-

Use Quick Reference Maps to estimate Elevation

### 2. Position Antenna to proper Elevation using Up/Down arrows on Vu Qube Remote.

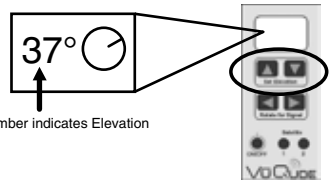

### 3. Go to the signal meter screen on TV.

Choose transponder number:

Dish Network #11

DirecTV #19

### 4. Rotate Antenna using Left/Right arrows on Vu Qube remote until signal appears on Signal Meter screen.

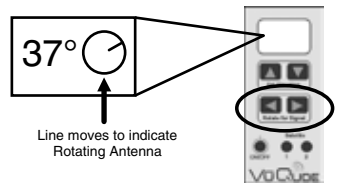

NOTE: Antenna is pointed directly at coaxial cable connector and toward vehicle when rotating line is straight up.

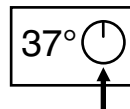

Antenna is pointed toward vehicle when line is straight up.

### 5. Fine tune and maximize signal using all 4 arrows.

## Satellite Position Memory

**TO STORE POSITION:** Hold down either the Satellite 1 or Satellite 2 button for at least 2.5 seconds. The LCD will show “P1” or “P2” when button is released.

**TO RECALL POSITION:** Hold down either the Satellite 1 or Satellite 2 button for less than 2.5 seconds. The LCD will show “r1” or “r2”.

**TO CANCEL RECALL:** Press any arrow button to stop moving to a stored position.

## Troubleshooting

If you cannot lock on to the correct satellite, it is most likely that an object is blocking the signal. If this is the case, move the vehicle to have an unobstructed view of the southern sky.

ERROR CODES	PROBLEM	ACTION
E0	Remote is unable to send commands to antenna	<ul style="list-style-type: none"><li>• Turn remote OFF, wait 5 seconds and turn back ON.</li><li>• Make sure RECEIVER is turned ON</li><li>• Make sure coax from antenna is attached to receiver</li><li>• Move remote closer to antenna</li></ul>
E1	Remote is unable to receive response from antenna	Move remote closer to antenna
E2	Miscommunication between remote and antenna	<i>Call Wallace Technologies @ 866-802-2228</i>

# Maintenance

The Vu Qube has been designed to be maintenance and trouble free. For optimum signal strength, keep the cover clean from dirt, bugs, and other debris. Periodic washing of the top cover with mild soap and water is recommended.

If you plan on storing your vehicle for long periods of time, it is recommended that the system be put through a search procedure on a quarterly basis to keep all moving parts in good working order.

If you have any comments or questions, please contact Wallace Technologies at (866) 802-2228, or email at [info@vuqube.com](mailto:info@vuqube.com).

# Limited Warranty

Every VuQube is thoroughly inspected and tested before leaving the factory and is covered by **a one year limited warranty** against any defects in material or workmanship after the date of original purchase. For one year from the date of purchase, at the option of VuQube, the unit and/or components will be repaired or replaced with a new, repaired, refurbished or comparable product if the unit becomes defective. This limited warranty does not cover replacements or repair for damage, malfunction or inoperability caused by abuse, misuse, accidents, or causes not within the control of VuQube.

Only authorized VuQube technicians can perform repair. Any unauthorized repair will void warranty.

Should any trouble develop during the warranty period, contact VuQube.

## Free Manuals Download Website

<http://myh66.com>

<http://usermanuals.us>

<http://www.somanuals.com>

<http://www.4manuals.cc>

<http://www.manual-lib.com>

<http://www.404manual.com>

<http://www.luxmanual.com>

<http://aubethermostatmanual.com>

Golf course search by state

<http://golfingnear.com>

Email search by domain

<http://emailbydomain.com>

Auto manuals search

<http://auto.somanuals.com>

TV manuals search

<http://tv.somanuals.com>