



RadioShack®

www.radioshack.comSM

2.4 GHz Digital Spread Spectrum Cordless Telephone

with Caller ID/Call Waiting Deluxe





Owner's Manual
Please read before using this equipment.

Read This First

This phone has been tested and found to comply with all applicable UL and FCC standards.

WARNING: To reduce the risk of fire or shock hazard, do not expose this product to rain or moisture.

	CAUTION RISK OF ELECTRIC SHOCK. DO NOT OPEN.	
CAUTION: TO REDUCE THE RISK OF ELECTRIC SHOCK, DO NOT REMOVE COVER OR BACK. NO USER-SERVICEABLE PARTS INSIDE. REFER SERVICING TO QUALIFIED PERSONNEL.		



This symbol is intended to alert you to the presence of uninsulated dangerous voltage within the product's enclosure that might be of sufficient magnitude to constitute a risk of electric shock. Do not open the product's case.



This symbol is intended to inform you that important operating and maintenance instructions are included in the literature accompanying this product.

IMPORTANT CALLER ID INFORMATION

To use the phone's Caller ID and Call Waiting with Caller ID features, you must be in an area where those services are available and you must subscribe to those services through your local phone company.

Where Caller ID is offered, one or more options are generally available:

- caller's number only
- caller's name only
- caller's name and number.

IMPORTANT SAFETY INSTRUCTIONS

When using your telephone equipment, basic safety precautions should always be followed to reduce the risk of fire, electric shock and injury to persons, including the following:

1. Read and understand all instructions.
2. Follow all warnings and instructions marked on the product.
3. Never install telephone wiring during a lightning storm.
4. Never install telephone jacks in wet locations unless the jack is specifically designed for wet locations.
5. Never touch uninsulated telephone wires or terminals unless the telephone line has been disconnected at the network interface.
6. Use caution when installing or modifying telephone lines.
7. Do not affix the AC power supply cord to building surfaces with metal fittings (if the product has an AC power cord).
8. Unplug this product from the wall outlet before cleaning. Do not use liquid clean-

© 2001 RadioShack Corporation.
All Rights Reserved.

RadioShack and RadioShack.com are trademarks used by RadioShack Corporation.

ers or aerosol cleaners. Use a damp cloth for cleaning.

9. Do not use this product near water, for example, near a bath tub, wash bowl, kitchen sink, or laundry tub, in a wet basement, or near a swimming pool.
10. Do not place this product on an unstable cart, stand, or table. The product may fall, causing serious damage to the product.
11. Slots and openings in the telephone's cabinet and the back or bottom are provided for ventilation. To protect the telephone from overheating, these openings must not be blocked or covered. The openings should never be blocked by placing the product on a bed, sofa, rug, or other similar surface. This product should never be placed near or over a radiator or heat register. This product should not be placed in a built-in installation unless proper ventilation is provided.
12. This product should be operated only from the type of power source indicated on the marking label. If you are not sure of the type of power supply to your home, consult your local power company.
13. Do not allow anything to rest on the power cord. Do not locate this product where the cord will be stepped on.
14. Do not overload wall outlets and extension cords as this can result in a risk of fire or electric shock.
15. Never push objects of any kind into this product through cabinet slots as they may touch dangerous voltage points or short out parts that could result in a risk of fire or electric shock. Never spill liquid of any kind on the product.
16. To reduce the risk of electric shock, do not disassemble this product. Take it to a qualified serviceman when service or repair work is required. Opening or removing covers may expose you to dangerous voltages or other risks. Incorrect reassembly can cause electric shock when the product is subsequently used.
17. Unplug this product from the wall outlet and refer servicing to qualified services personnel under the following conditions:
 - When the power cord plug is damaged or frayed.
 - If liquid has been spilled into the product.
 - If the product has been exposed to rain or water.
 - If the product does not operate normally by following the operating instructions. Adjust only those controls that are covered by the operating instructions because improper adjustments of other controls may result in damage and will often require extensive work by a qualified technician to restore the product to normal operation.
 - If the product has been dropped or the cabinet has been damaged.
 - If the product exhibits a distinct change in performance.
18. Avoid using a telephone (other than a cordless type) during an electrical storm. There may be a remote risk of electric shock from lightning.
19. Do not use the telephone to report a gas leak while in the vicinity of the leak.

BATTERY SAFETY INSTRUCTIONS

CAUTION: TO REDUCE THE RISK OF FIRE OR INJURY, READ AND FOLLOW THESE INSTRUCTIONS.

1. Use only the appropriate type and size battery pack specified in the instruction manual provided for this product.
2. Do not dispose of the battery pack in a fire. The cell may explode. Check with local codes for possible special disposal instructions.
3. Do not open or mutilate the battery pack. Released electrolyte is corrosive and may cause damage to the eyes or skin. It may be toxic if swallowed.
4. Exercise care in handling the battery pack in order not to short it with conducting materials such as rings, bracelets and keys. The battery or conductor may overheat and cause burns.
5. Charge the battery pack provided with or identified for use with this product only in accordance with the instructions and limitations specified in the instruction manual provided for this product.
6. Observe proper polarity orientation between the battery pack and battery charger.

SAVE THESE INSTRUCTIONS

READ THIS BEFORE INSTALLATION

We have designed your phone to conform to federal regulations and you can connect it to most phone lines. However, each device that you connect to the telephone line draws power from the line. We refer to this power

draw as the phone's ringer equivalence number, or REN. The REN is on the bottom of your phone.

If you use more than one phone or other device on the line, add up all the RENs. If the total is more than five (three in rural areas), your phones might not ring. If ringer operation is impaired, remove one of the devices from the line.

Important:

- Cordless phones such as this one require AC power to operate. When the AC power is off, you cannot dial out or receive incoming calls using your phone. To be safe, you should also have a phone that does not need AC power to operate (not a cordless phone) so you can still make and receive calls if there is an AC power failure.
- When AC power is lost, the phone loses the security access-protection code connection between the base and the handset. When power is restored, put the handset on the base briefly to restore this connection.

FCC STATEMENT

Your telephone complies with Part 68 of *FCC Rules*. Upon request, you must provide the phone's FCC registration number and REN to your telephone company. These numbers are on the bottom of the base.

Note: You must not connect your telephone to:

- coin-operated systems
- party-line systems
- most electronic key phone systems

THE FCC WANTS YOU TO KNOW

In the unlikely event that your phone causes problems on the phone line, the phone company can temporarily discontinue your service. If this happens, the phone company attempts to notify you in advance. If advance notice is not practical, the phone company notifies you as soon as possible and advises you of your right to file a complaint with the FCC.

Also, the phone company can make changes to its lines, equipment, operations, or procedures that could affect the operation of this telephone. The telephone company notifies you of these changes in advance, so you can take the necessary steps to prevent interruption of your telephone service.

Your phone might cause TV or radio interference even when it is operating properly. To determine whether your phone is causing the interference, turn off your phone. If the interference goes away, your phone is causing it.

Try to eliminate the interference by:

- moving your phone away from the receiver
- connecting your phone to an AC outlet that is on a different electrical circuit from the receiver contacting your local RadioShack store for help

If you cannot eliminate the interference, the FCC requires that you stop using your phone.

Some cordless telephones operate on frequencies that might cause interference to nearby TVs and VCRs. To minimize or prevent such interference, the base of the cordless telephone should not be placed near or on top of a TV or VCR.

Lightning

Your telephone has built-in protection circuits to reduce the risk of damage from surges in telephone line and power line current. These protection circuits meet or exceed the FCC requirements. However, lightning striking the telephone or power lines can damage your telephone.

Lightning damage is not common. Nevertheless, if you live in an area that has severe electrical storms, we suggest that you unplug your phone when storms approach to reduce the possibility of damage.

Contents

Features	7
Installation	8
Mounting the Phone	8
Selecting a Location	8
On a Desk, Shelf, or Table	8
On a Wall Plate or Wall	9
Connecting, Charging, and Replacing the Battery Pack	10
Setting the Dialing Mode	11
Setting the Ringer Tone/Volume	12
Turning Auto Talk On/Off	12
Turning Caller ID/Call Waiting On/Off	12
Storing Your Area Code	12
Operation	14
A Quick Look at Your Phone	14
Using Tone Services on a Pulse Line	15
Paging	15
Memory Dialing	15
Storing a Number and Name in Memory	15
Editing or Deleting a Number in Memory	16
Entering a Pause	16
Reviewing Memory Numbers	17
Dialing a Memory Number	17
Chain-Dialing Service Numbers	17
Testing Stored Emergency Numbers	17
Using a Headset	17
Caller ID Operation	18
Call Waiting Options Service	18
Using Call Waiting Options	18
Using Ask to Hold	19
Using Conference	19
Reviewing Caller ID Records	19
Caller ID Messages	20
Adding/Deleting the Area Code	20
Dialing Numbers from a Caller ID Record	20
Storing a Caller ID Record to Memory	20
Deleting Caller ID Records	21
Troubleshooting	22
Care	23

□ **Features**

Your RadioShack 2.4 GHz Digital Spread Spectrum Cordless Telephone uses advanced technology to give you superior audio quality and extended range.

The phone's Caller ID unit records each caller's telephone number (and name, if available in your area) and the date and time of the call, as provided by your local phone company to Caller ID service subscribers. If you subscribe to Call Waiting with Caller ID, the phone can show you the incoming caller information, even when you are already talking on the phone.

Your phone has these features:

2.4 GHz Operation — provides longer range and less interference than many other cordless phones.

Call Waiting Deluxe — gives you an expanded list of options to choose from when using Call Waiting (you must order Call Waiting Options from your phone company to use this feature).

Spread Spectrum Technology — spreads the signal across several frequencies, providing additional security for your phone conversations.

Lighted Keypad — makes the phone easy to use in any light, even in total darkness. The keypad lights for about 10 seconds after any key operation or when a call is received.

Facedown or Faceup Handset Charging — you can place the handset on the base facedown or faceup (to show the Caller ID display, for example).

3-Line Liquid Crystal Display — lets you view an entire Caller ID record on one screen.

Caller ID Memory — stores up to 50 Caller ID records.

Headset Jack — lets you connect an optional headset (available from your local RadioShack store) for hands-free convenience.

20-Number Memory Dialing — lets you store up to 20 numbers in memory for easy dialing.

35 Channels — automatically selects a clear channel when you make or answer a call. You can also manually change channels during a call.

Page — lets you send a signal from the base to the handset to page someone or to help you locate the handset.

Tone/Pulse Dialing — lets you use your phone with either type of service.

Hearing-Aid Compatibility — lets you use the phone with hearing aids that have a T (telephone) switch.

Volume Control — lets you adjust the volume you hear through the handset.

Adjustable Ringer/Tone Volume — lets you choose between two volumes and tones for the phone's ringer or turn the ringer off.

Ample Talk and Standby Time — the supplied battery (when fully charged) provides about 6 hours of talk time or 7 days of standby time.

Security Access-Protection Code — automatically prevents other cordless phone users from using your phone line.

Auto Talk — lets you set the phone so you can answer a call simply by lifting the handset from the base.

□ Installation

MOUNTING THE PHONE

Selecting a Location

You can place the phone's base on a desk or table, or mount it on a standard wall plate or directly on a wall. Choose a location that is:

- near an AC outlet
- near a telephone line jack
- out of the way of normal activities
- away from electrical machinery, electrical appliances, metal walls or filing cabinets, wireless intercoms, alarms, and room monitors
- away from other cordless phones

The base's location affects the handset's range. If you have a choice of several locations, try each to see which provides the best performance.

You can power the phone using the supplied 9V, 350 mA AC adapter.

Cautions:



You must use a Class 2 power source that supplies 9V DC and delivers at least 350 mA.

Its center tip must be set to positive and its plug must fit the telephone's **DC IN 9V** jack. The supplied adapter meets these specifications. Using an adapter that does not meet these specifications could damage the telephone or the adapter.

- Always connect the AC adapter to the phone before you connect it to AC power. If you disconnect the power, disconnect the adapter from AC power before you disconnect it from the phone.

Your telephone connects directly to a modular telephone line jack. If your telephone wiring does not have a modular jack, you can update the wiring yourself using jacks and adapters (available at your local RadioShack store), or have the telephone company update the wiring for you. You must use compatible modular jacks that are compliant with Part 68 of *FCC Rules*.

Note: The USOC number of the jack to be installed is RJ11C (or RJ11W for a wall plate jack).

On a Desk, Shelf, or Table

Follow these steps when you place the base on a desk, shelf or table.

1. Insert the bracket's tabs into the base's upper tab slots, then press down on the bracket's clips and insert them into the clip slots.

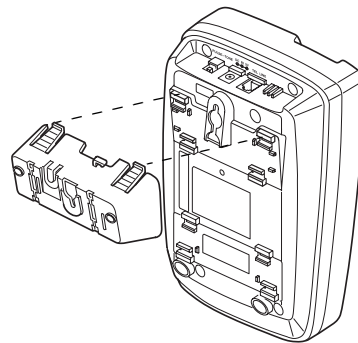

2. Plug one end of the supplied long modular cord into **TEL LINE**.

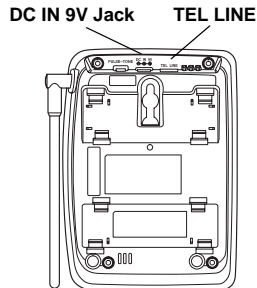

3. Insert the supplied AC adapter's barrel plug into **DC IN 9V**.

4. Route the adapter and modular cords through the strain relief slots on the base.

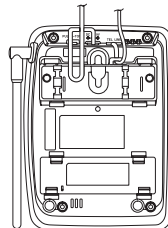

5. Plug the modular cord's other end into the phone jack.
6. Plug the adapter into a standard AC outlet.
7. Lift the base's antenna to a vertical position.

2. Plug one end of the supplied short modular cord into the **TEL LINE** jack on the back of the base.

3. Insert the supplied AC adapter's barrel plug into **DC IN 9V**.

4. Route the adapter's cord through the strain relief slot on the base.

5. Plug the modular cord's other end into the wall plate jack, then align the base's keyhole slots with the wall plate studs and slide the base downward to secure it.

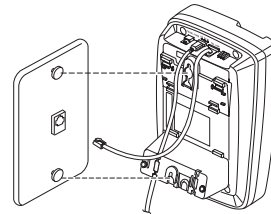

6. Plug the adapter into a standard AC outlet.

7. Press and lift out the handset holder. Rotate it 180°, then snap it back into place so it holds the handset.



8. Lift the base's antenna to a vertical position.

On a Wall Plate or Wall

1. Insert the bracket's tabs into the base's lower tab slots, then press down on the bracket's clips and insert them into the clip slots.

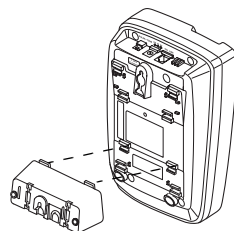

Note: To mount the phone directly on a wall, you need two screws of at least $1\frac{3}{8}$ inch long (not supplied) with heads that fit into the keyhole slots on the bottom of the base.

Follow the steps under “On a Wall Plate or Wall” on Page 9, then apply these additional instructions for placement on a wall.

1. Drill two holes $3\frac{15}{16}$ inches (100 mm) apart. Then thread a screw into each hole, letting the heads extend about $\frac{1}{8}$ inch (3 mm) from the wall.
2. Plug one end of the supplied long modular cord into the **TEL LINE** jack on the back of the base and route the adapter cable and modular cords through the grooves on the base.
3. Align the base's keyhole slots with the mounting screws and slide the base downward to secure it.

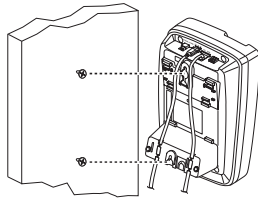
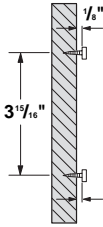

CONNECTING, CHARGING, AND REPLACING THE BATTERY PACK

The telephone comes with a rechargeable nickel-cadmium battery pack installed in the handset, but not connected. Before using your phone, you must connect the battery pack, then charge it for about 24 hours.

Follow these steps to connect the battery pack.

1. Press down and slide off the battery pack compartment cover.
2. Lift the battery pack out of the compartment.
3. Plug the battery pack's connector into the socket in the compartment (the connector fits only one way), replace the battery pack, then replace the cover.

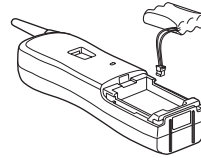

To charge the battery pack, place the handset either up or down on the base. The CHARGE/IN USE indicator on the base lights and **Total:00** appears on the handset.

Recharge the battery pack when **Low Battery** flashes on the handset.

Important: Be sure the battery pack is properly connected before you try to charge it. The CHARGE/IN USE indicator lights when the handset is on the base, even if the battery pack is not properly connected.

Notes:

- When you first use the phone after charging or recharging the battery pack, the phone might not work and the phone might beep several times when you press **TALK**. Return the handset to the base for about 5 seconds to reset the security access-protection code.
- If the handset or the base loses power, the security access-protection code might be lost. To reset the code, return the handset to the base for about 5 seconds.

- Using a pencil eraser, clean the charging contacts on the handset and base about once a month.
- If the battery pack becomes weak during a call, the handset beeps every 3 seconds and **Low Battery** flashes. When this happens, you cannot make a call.
- About once a month, fully discharge the battery by keeping the handset off the base until **Low Battery** flashes. Otherwise, the battery pack loses its ability to fully recharge.
- If the display is blank and the phone does not work, recharge the battery pack. (The battery power might be too low to light the display.)
- If you are not going to use your phone for an extended period of time, disconnect the battery pack. This increases the battery pack's usable life.

The supplied battery pack should last about a year. If the battery pack does not hold a charge for more than 2 hours after an overnight charge, replace it with a new 3.6-volt, 600 mAh battery pack with a connector that fits the socket in the battery compartment. You can order a replacement battery pack through your local RadioShack store. Install the new battery pack and charge it for about 24 hours.

Warning: Dispose of the old battery pack promptly and properly. Do not burn or bury it (see "Battery Safety Instructions" on Page 4 for additional information on proper battery handling).

If you have trouble replacing the battery pack, take the phone to your local RadioShack for assistance.

Important: The EPA certified RBRC® Battery Recycling Seal on the nickel-cadmium (Ni-Cd) battery indicates RadioShack is voluntarily participating in an industry program to collect and recycle these batteries at the end of their useful life, when taken out of service in the United States or Canada. The RBRC program provides a convenient alternative to placing used Ni-Cd batteries into the trash or the municipal waste stream, which may be illegal in your area. Please call 1-800-THE-SHACK (1-800-843-7422) for information on Ni-Cd battery recycling and disposal bans/restrictions in your area. RadioShack's involvement in this program is part of the company's commitment to preserving our environment and conserving our natural resources.



SETTING THE DIALING MODE

To set the dialing mode, set **PULSE TONE** on the back of the base for the type of service you have. If you are not sure which type you have, do this test after you charge the handset's battery pack.

1. Set **PULSE-TONE** to **TONE**.
2. Lift the handset, press **TALK**, and listen for a dial tone.
3. Press any number other than 0.

Note: If your telephone system requires that you dial an access code (9, for example) before you dial an outside number, do not press the access code number either.

*If the dial tone stops, you have touch-tone service. Leave **PULSE-TONE** set to **TONE**.*

*If the dial tone continues, you have pulse service. Set **PULSE-TONE** to **PULSE**.*

4. Press **TALK** or place the handset on the base to hang up.

SETTING THE RINGER TONE/VOLUME

You can select one of four different ringer tone/volume settings on the handset. At any time, except during a call, repeatedly press **VOL/CID** ▲ or ▼ to select the desired ringer setting. Each time you press a button, the phone rings at the selected setting and **Ringer A High**, **Ringer A Low**, **Ringer B High**, or **Ringer B Low** appears.

You can also turn off the ringer. At any time, except during a call, hold down **VOL/CID** ▼ until the phone beeps and **Ringer Off** appears. When you place the handset faceup on the base, <**Ringer Off**> appears.

You can still make or receive a call even when the ringer is turned off. When you have an incoming call, any other phone connected to the same line rings, and **Incoming Call** appears.

To turn the ringer back on, simply press **VOL/CID** ▲ or ▼. The ringer is restored at Ringer A High.

TURNING AUTO TALK ON/OFF

Your phone is preset so you must press **TALK** when you lift the handset from the base to answer a call. With auto talk turned on, you can answer a call by just lifting the handset from the base. If the handset is away from the base, you can answer by pressing any key.

Follow these steps to turn auto talk on or off.

1. Lift the handset and press **FUNC**. A menu appears with **Auto Talk** selected.

2. Press **SELECT/CH** to change the auto talk setting. **On** or **Off** appears.
3. Return the handset to the base or press **FUNC** to store the new setting.

TURNING CALLER ID/ CALL WAITING ON/OFF

If you subscribe to Call Waiting with Caller ID service, you can set the phone to show Caller ID information for an incoming call even while you are using the phone.

Follow these steps to turn the Caller ID/Call Waiting feature on or off.

1. Lift the handset and press **FUNC**.
2. Press **2** or **VOL/CID** ▼ to select **CIDCW** (Caller ID/Call Waiting).
3. Press **SELECT/CH** to change the Caller ID/Call Waiting setting. **On**, **Opt**, or **Off** appears.

With the Opt setting, you can use the advanced Caller ID/Call Waiting options. See "Call Waiting Options Service" on Page 18.

4. Return the handset to the base to store the new setting.

STORING YOUR AREA CODE

You can store your local area code in the phone's Caller ID record so it does not show the area code if the received call is from your local area. If for some reason you need to dial the area code (or store in the memory), you can add it afterwards. See "Adding/Deleting the Area Code" on Page 20.

Note: If your calling area requires 10-digit dialing including area code, do not enter the area code but leave this option blank.

Follow these steps to store your area code.

1. Lift the handset and press **FUNC**.
2. Press **3** or **VOL/CID** ▼ twice to select **Area Code**.
3. Press **SELECT/CH**, then enter your three-digit area code. If you make a mistake, repeatedly press ◀ / ✕ or #/ ▶ to move the cursor over the incorrect digit, then enter the correct number.

Note: If an area code is already stored, it appears on the display. To delete the area code, press **SELECT/CH**, press **DEL** three times, then enter your area code.

4. Press **SELECT/CH** to store the area code, then press **FUNC** or return the handset to the base to clear the display.

□ Operation

A QUICK LOOK AT YOUR PHONE

VOL ▲/▼ — To adjust the handset's volume during a call, press **VOL/CID ▲** or **▼** to select **Volume Maximum**, **Volume High**, **Volume Medium**, or **Volume Low**.

The phone maintains the setting even after you hang up the phone.

Note: When you press **VOL/CID ▲** while the volume is maximum or **VOL/CID ▼** while the volume is low, the handset beeps three times and the setting does not change.

TALK — To make a call, lift the handset and press **TALK**. **Talk** and the current volume setting appear, and the **CHARGE/IN USE** indicator on the base lights. Then enter the number. The number appears as you dial, then (after a few seconds) the call's elapsed time appears.

You can also enter the number before pressing **TALK**. If you make a mistake, press **DEL** until the incorrect entry is erased, then enter the correct number. To delete the entire number, hold down **DEL** for at least 2 seconds. When the number on the display is correct, press **TALK**. **Talk** and the current volume setting appear, and the **CHARGE/IN USE** indicator on the base lights. The number you entered and the call's elapsed time appear.

When you receive a call, **Incoming Call** appears. To answer it, lift the handset from the base and press **TALK**. If auto talk is on, just lift the handset from the base. If the handset is away from the base, press any key. **Talk** and the current volume setting appear.

To end a call, place the handset on the base or press **TALK**.

The handset window has plastic film on it to protect it during shipment. Carefully peel off the film before using your phone for the first time.

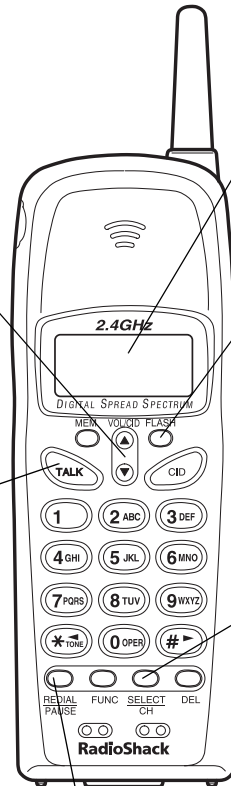

FLASH — **FLASH** performs the electronic equivalent of a switchhook operation for special services, such as Call Waiting.

For example, if you have Call Waiting, press **FLASH** to answer an incoming call without disconnecting the current call. Press **FLASH** again to return to the first call.

Note: If you do not have any special phone services, pressing **FLASH** might disconnect the current call.

SELECT/CH — Normally the phone selects a clear channel. If a call seems to disconnect for no reason, press **SELECT/CH** on the handset to select a different channel. **Scanning** appears as your phone searches for a clear channel.

REDIAL/PAUSE — You can quickly dial any of the last three numbers you dialed. Lift the handset and repeatedly press **REDIAL/PAUSE** until the number you wish to dial displays. Then press **TALK** and the phone dials the number.

Notes:

- You can also press **REDIAL/PAUSE** after pressing **TALK** to dial the last number dialed.
- The redial memory holds up to 32 digits, so you can redial long-distance as well as local numbers.
- The redial memory also holds pause entries. See "Entering a Pause" on Page 16.

USING TONE SERVICES ON A PULSE LINE

Some special services, such as bank-by-phone, require tone signals. If you have pulse service, you can still use these special tone services by following these steps.

1. Be sure **PULSE-TONE** is set to **PULSE**.
2. Dial the service's main number.
3. When the service answers, press **TONE/◀/✕**). Any additional numbers you dial are sent as tone signals.

The phone automatically resets to the pulse mode the next time you make or receive a call.

PAGING

To send a page from the base to the handset or to locate the handset, when the phone is not in use, press **PAGE/FIND** on the base. The handset beeps for 15 seconds.

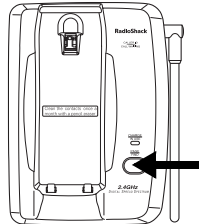

To locate the handset using a continuous beep, press and hold **PAGE/FIND** longer than 2 seconds. The handset beeps for one minute. Press any key or place the handset on the base to stop the page before that.

Note: The phone rings when a call comes in while you are using the page feature.

MEMORY DIALING

You can store up to 20 phone numbers and names in memory, then dial a stored number by entering its memory location number.

Each number can be up to 20 digits, and each name can be up to 13 characters.

Storing a Number and Name in Memory

When you are storing a number in memory, an error tone sounds and the phone exits the storing process if you wait more than 20 seconds between each keypress.

Note: If you receive a call during memory entry, the phone exits the storing process.

Follow these steps to store a number and name in memory.

1. Lift the handset.
2. Hold down **MEM** until **Memory Store** and a list of memory location numbers appears.
3. Press a number (**01–20**) to choose a two-digit memory location. Precede a single digit location number with 0 — 01, 02, 03, and so on.
4. Press **SELECT/CH**. **Store name** appears.

If you do not want to enter a name, skip to Step 6.
5. To enter a name, use the number keys.

Refer to the letters on the number keys to select the desired letter. Press the key once for the first letter in upper case, press twice for the second letter in upper case, and so on. To enter the lower case letter, press four times (or five times) to display the first letter in lower case, five or six times for the second letter, and so on.

For example, to enter John: press **5** once; upper case **J** appears. Then press **6** six times; lower case **o** appears. Press **4** five times; lower case **n** appears.

Finally, press **6** five times; lower case **n** appears.

To enter two letters from the same key in a row, press **#/▶** to move the cursor to the next position. For example to enter **AB**, press **2**; **A** appears. Then press **#/▶**, the cursor moves to the next position, then press **2** twice so **B** appears.

To enter a space, press **#/▶** twice without entering any character.

To enter a number, repeatedly press the corresponding number key until the number appears.

To enter a special character, use **0**. Each time you press **0**, the following characters appear in this order:

*** # - & { } (space) 0**

If you make a mistake, use **TONE/◀/*** or **#/▶** to move the cursor over the error, then enter the correct character, or press **DEL** to delete a character. To delete all characters, hold down **DEL** for at least 1 second.

6. Press **SELECT/CH**. **Store number** appears.
7. Enter the phone number and any tone or pause entries (see “Using Tone Services on a Pulse Line” on Page 15 and “Entering a Pause” on Page 16).
8. Press **SELECT/CH**. The phone beeps and **Memorynn Stored** appears (nn is the location number you selected).

After 2 seconds, **Memory Store** appears. Repeat Steps 3–8 to store more numbers.

9. When you finish, press **MEM**.

To replace a stored number, store a new one in its place.

Editing or Deleting a Number in Memory

Follow these steps to edit or delete a memory number.

1. Lift the handset.
2. Hold down **MEM** until **Memory Store** and a list of memory location numbers appear on the display.
3. Choose a memory location (01–20) by pressing a number or by repeatedly pressing **VOL/CID ▲** or **▼**.
4. Press **SELECT/CH**. A menu appears on the display with these options.

Edit Memorynn — edit the record as described in Steps 5–8 of “Storing a Number and Name in Memory” on Page 15.

Delete Memorynn — the display prompts you to confirm the deletion. Press **VOL/CID ▲** to move the cursor to **Yes**, then press **SELECT/CH** or **DEL**. The phone beeps, and **Memorynn Deleted** appears.

Go Back — returns you to the list of memory numbers.

5. Press **VOL/CID ▲** or **▼** or to highlight the desired option then press **SELECT/CH** to choose it.

Entering a Pause

In some telephone systems, you must dial an access code (9, for example) and wait for a second dial tone before you can dial an outside number. You can store the access code with the phone number. However, you should also store a pause after the access code to allow the outside line time to connect. To enter a 2-second pause, press **REDIAL/PAUSE**. The display shows **P** for pause

entry. You can add more pause entries for a longer pause.

Reviewing Memory Numbers

To review your memory numbers, press **MEM**. The list of memory location numbers (01–20) appears with the name stored with each number (or **<Memorynn>** if you did not store a name).

To see the stored phone numbers, press **#/▶**. An arrow to the right of the number means it is longer than 13 digits. Press **#/▶** again to see the rest of the number. Repeatedly press **TONE/◀/✕** to return to the name display.

To exit the memory number list, press **MEM**.

To see a stored name and phone number at the same time, press **SELECT/CH** when the cursor is by a memory location number. To exit this display, hold down **DEL** until the display clears.

Dialing a Memory Number

To dial a number stored in memory, lift the handset and press **MEM**. The list of memory location numbers appears. Choose a memory location (01–20) by pressing a number or by repeatedly pressing **VOL/CID ▲** or **▼**, then press **TALK**.

You can also dial a memory number after pressing **TALK**. Press **MEM** (the display does not change but the phone's memory recall activates) then enter a memory location number.

Chain-Dialing Service Numbers

For quick recall of numbers for special services (such as bank-by-phone), store each group of numbers in its own memory location. Dial the service's main number first. Then, at the appropriate place in the call,

press **MEM** and enter the number for the location where the additional information is stored.

Testing Stored Emergency Numbers

If you store an emergency service's number (police department, fire department, ambulance) and you choose to test the stored number, make the test call during the late evening or early morning hours to avoid peak demand periods. Also, remain on the line to explain the reason for your call.

USING A HEADSET

You can make or answer calls with hands-free convenience using an optional headset that has a $\frac{3}{32}$ -inch (2.5-mm) plug. Contact your local RadioShack store for a suitable headset.

To connect the headset, pull open the rubber cover marked  on the side of the headset, then insert the headset's plug into the jack.

When you finish using the headset, disconnect it from the handset and close the rubber cover to protect the jack.

Notes:

- Connecting a headset disconnects the handset's earpiece and microphone.
- **VOL/CID ▲** or **▼** on the handset also controls the headset's volume.
- If you place the handset on the base to recharge it while the headset is connected, be sure the handset seats properly.
- With a headset connected, you can make or answer calls as usual using the keys on the handset.

- You can use a handset holder (available from your local RadioShack store) to

hang the handset on your belt for greater convenience.

☐ **Caller ID Operation**

If you subscribe to Caller ID service from your phone company, the phone company sends information about the call, as well as the time and date, between the first and second rings of every call you receive.

The phone displays this information after the second ring, and it stores up to 50 Caller ID records for later review. It also shows if caller information is unavailable or if the name and number were blocked by the caller (see “Caller ID Messages”).

If you subscribe to Call Waiting with Caller ID, you will hear a tone through the handset when a call comes in, then the Caller ID record appears. If you want to answer the incoming call, press **FLASH**. To resume the previous phone conversation, press **FLASH** again.

If the phone’s Caller ID memory becomes full, any new call replaces the oldest call’s record.

CALL WAITING OPTIONS SERVICE

With this phone, you can order Call Waiting Options Service from your phone company. This service provides you with more choices on how to handle a second call when you are already on the phone. You can switch between the callers, have a 3-way conference call with both callers, send the second caller to your voice mail, or answer the second caller with a prerecorded message asking them to hold the line.

Before you can use the Call Waiting Options Services, you must:

- subscribe to the Options service from your telephone company.
- set the Caller ID/Call Waiting feature to Opt (see “Turning Caller ID/ Call Waiting On/Off” on Page 12).

Using Call Waiting Options

Note: An error tone sounds and the phone exits the menu mode if you wait more than 20 seconds between each keypress.

You hear a soft beep when a call comes in while you are already on the phone. The display shows the caller name and phone number.

Follow these steps to use Call Waiting Options Services.

1. Press **FUNC**. A list of several options, beginning with **Ask to Hold** appears.
2. Repeatedly press **VOL/CID ▼** to scroll through the options list. You can also press the number of the desired option.
3. Choose one of the following options, then press **SELECT/CH**.

Ask to Hold — A waiting caller hears a prerecorded message stating that you will be available shortly, and is put on hold. **Call Holding** appears on your phone.

Tell Busy — A prerecorded message indicates you are busy, and the waiting call is disconnected. **Told Busy** appears on your phone.

Take Message — A waiting caller is sent to your phone company’s subscrip-

tion voice mail, if available. **To Voice Mail** appears on your phone.

Note: Voice Mail is a service available from some telephone companies. A call for a subscriber can be kept at the telephone company and retrieved later on by calling the special number and entering the caller's phone number and code number. Check with your telephone company to determine if this service is available.

Answer/Drop 1 — Disconnects the first call, and connects automatically to the new caller. **Answer/Drop 1st** appears.

Conference — Allows you to speak with your first and second callers to have a 3-way conference call. **Conferenced** appears.

Drop First/Drop Last — only use with a conference call (see "Using Conference").

Using Ask to Hold

When you select **Ask to Hold**, you can then use several of the other options as well.

*If you decide you cannot end your first call, and you do not want to continue to leave the second call on hold, press **FUNC**.*

To notify the second caller that you cannot take the call, scroll down to **Tell Busy** or press 2.

To send the second caller to voice mail (if you have voice mail), scroll down to **Take Message** or press 3.

Press **SELECT/CH**.

*If you decide to take the second call, and end the first, scroll down to **Answer/Drop 1st** or press 4. Press **SELECT/CH**.*

*If you decide to include the second caller in your conversation with the first caller, scroll down to **Conference** or press 5. Press **SELECT/CH**.*

Using Conference

You can either begin a conference call as soon as you receive a second call, or after the second caller has been on hold for a while (see "Using Ask to Hold"). Once you have established a conference call, you can end it at any time by dropping one of the calls.

Drop First — hang up on the first caller and continue with the second.

Drop Last — hang up on the second caller and continue with the first.

Follow these steps to drop one of the calls.

1. To end a conference call, press **FUNC**.
2. Scroll down to **Drop First** (or press 6) or **Drop Last** (or press 7) to drop the desired call.
3. Press **SELECT/CH**. **Call Dropped** appears on your phone.

REVIEWING CALLER ID RECORDS

To review the Caller ID records, lift the handset and press **CID**. The number of new Caller ID records, if any, and the total number of records appear.

Note: If the handset is faceup on the base, it shows the number of Caller ID records, so you can see if you have new records to review.

Repeatedly press **VOL/CID** ▼ to scroll through the Caller ID records from the newest to the oldest, or **VOL/CID** ▲ to scroll back

through the records. To scroll quickly through the records, hold down **VOL/CID ▲** or **▼**.

When you scroll past the last record, the total record number appears, then the first record. When you scroll past the first record, the total record number appears, then the last record.

The top line of each record shows the date, time and the number of calls from that number. The second line shows the caller's name, and the third line shows the caller's phone number.

To exit the Caller ID record display, press **CID**.

CALLER ID MESSAGES

Display	Description
New:XX Total:XX	Shows the number of new Caller ID records (records you have not reviewed) and the total number of records.
Private name or Private number	The caller has blocked the Caller ID information.
Unknown name or Unknown number	The caller is not within a Caller ID service area.
Incomplete Data	Appears if there was an error during the transmission of Caller ID information. Occasional errors are normal. If the phone frequently displays Incomplete Data , contact your local telephone company or RadioShack store.

ADDING/DELETING THE AREA CODE

When the area code of the received call is the same as the one you stored (see "Storing Your Area Code" on Page 12), the caller ID

record does not show the area code. If it is different, the record shows the area code. However, you can add or delete the area code on the display. When the record is on the display, press **3** to add or delete the area code. Pressing **3** again deletes or adds the area code.

DIALING NUMBERS FROM A CALLER ID RECORD

To dial a local number stored in a Caller ID record, recall the record, then press **TALK**. If it is a long distance call, press **1** (1 appears before the displayed number) before you press **TALK**. If you want to add or delete the area code, press **3** before you press **TALK**.

Note: If a Caller ID record does not contain a phone number (if it was blocked by the caller, for example) you cannot dial from that record.

STORING A CALLER ID RECORD TO MEMORY

Follow these steps to store the name and number from a Caller ID record into a memory location.

1. Press **CID** then **VOL/CID ▲** or **▼** to recall the record you want to store.

If you want to add or delete the area code, press **3**.

2. Press **MEM**. **Select Location** appears.
3. Choose a memory location (**01–20**) by pressing a number or by repeatedly pressing **VOL/CID ▲** or **▼**, then pressing **SELECT/CH**.

If the selected location is empty, the phone beeps to confirm that it stored the number, then the Caller ID record appears.

If a record exists in the selected location, **Replace memory?** appears, prompting you to

confirm the replacement. Move the cursor to **Yes** or **No**, then press **SELECT/CH**.

DELETING CALLER ID RECORDS

You can delete Caller ID records individually or all at once.

Follow these steps to delete a single Caller ID record.

1. Press **CID** then **VOL/CID ▲** or **▼** to recall the record you want to delete.
2. Press **DEL**. **Delete Message?** appears, prompting you to confirm the deletion.
3. Press **VOL/CID ▲** to move the cursor to **Yes**, then press **SELECT/CH** or **DEL**. The phone beeps once indicating that the record was deleted.

Follow these steps to delete all Caller ID records.

1. Press **CID**. The record totals appear.
2. Press **DEL**. **Delete All?** appears.
3. Press **VOL/CID ▲** to move the cursor to **Yes**, then press **SELECT/CH** or **DEL**. The phone beeps once and **Total:00** appears indicating that all Caller ID records were deleted.

Troubleshooting

We do not expect you to have any problems with your phone, but if you do, these suggestions might help.

Problem	Suggestion
The phone does not work or works poorly.	Be sure the base's phone line cord and AC adapter are correctly and securely connected.
	Be sure the battery pack in the handset is connected and charged.
	Return the handset to the base for about 5 seconds to reset the security access-protection code.
The handset stops working or works poorly during a call.	Move the handset closer to the base.
	Lift the base's antenna to a fully vertical position.
	Be sure the handset's battery pack is charged. (If the battery pack power is too low, the handset cannot display Low Battery .)
Low volume or unusual sounds.	Someone has picked up another phone on the same line. Hang up the other phone.
Dropout or mute.	Keep the handset away from computers, other cordless telephones, remote control toys, wireless microphones, alarm systems, intercoms, room monitors, fluorescent lights, microwave ovens, and electrical appliances.
	Move to another location or turn off the source of interference.
	Press SELECT/CH to change the channel.
	Hang up and redial the number.
The phone cannot be operated at a useful distance from the base because the signal becomes weak or noisy (handset's range has decreased).	Lift the base's antenna to a vertical position.
	Be sure neither the handset's nor base's antenna is touching a metal surface.
	Return the handset to the base and recharge the battery pack.
The handset battery pack does not charge.	Check the charging contacts on the handset and base. If they are dirty, clean them with a pencil eraser.
	Be sure the battery pack is connected correctly.
	Be sure the handset is properly seated on the base.
	Replace the battery pack (see "Connecting, Charging, and Replacing the Battery Pack" on Page 10).

Problem	Suggestion
The handset does not ring or receive a page.	Move the handset closer to the base.
	Lift the base's antenna to a vertical position.
	Be sure the battery pack in the handset is connected and charged.
	Move the base away from other electrical devices.
You have an incoming call, but do not receive any Caller ID information.	Let the phone ring twice before you answer so the phone has time to record the Caller ID information.
	Check that the phone is correctly and securely connected.
	Check with your phone company to verify that your Caller ID service is active.

If you still have problems, disconnect the phone. If other phones on the same line work properly, the fault is in this phone or its installation. If you cannot find the problem, take the phone to your local RadioShack store for assistance.

CARE

Keep the phone dry; if it gets wet, wipe it dry immediately. Use and store the phone only in normal temperature environments. Handle the phone carefully; do not drop it. Keep the phone away from dust and dirt, and wipe it with a damp cloth occasionally to keep it looking new.

Modifying or tampering with the phone's internal components can cause a malfunction and might invalidate its warranty and void your FCC authorization to operate it. If your phone is not performing as it should, take it to your local RadioShack store for assistance. If the trouble is affecting the telephone lines, the phone company can ask you to disconnect your phone until you have resolved the problem.

Limited One-Year Warranty

This product is warranted by RadioShack against manufacturing defects in material and workmanship under normal use for one (1) year from the date of purchase from RadioShack company-owned stores and authorized RadioShack franchisees and dealers. EXCEPT AS PROVIDED HEREIN, RadioShack MAKES NO EXPRESS WARRANTIES AND ANY IMPLIED WARRANTIES, INCLUDING THOSE OF MERCHANTABILITY AND FITNESS FOR A PARTICULAR PURPOSE, ARE LIMITED IN DURATION TO THE DURATION OF THE WRITTEN LIMITED WARRANTIES CONTAINED HEREIN. EXCEPT AS PROVIDED HEREIN, RadioShack SHALL HAVE NO LIABILITY OR RESPONSIBILITY TO CUSTOMER OR ANY OTHER PERSON OR ENTITY WITH RESPECT TO ANY LIABILITY, LOSS OR DAMAGE CAUSED DIRECTLY OR INDIRECTLY BY USE OR PERFORMANCE OF THE PRODUCT OR ARISING OUT OF ANY BREACH OF THIS WARRANTY, INCLUDING, BUT NOT LIMITED TO, ANY DAMAGES RESULTING FROM INCONVENIENCE, LOSS OF TIME, DATA, PROPERTY, REVENUE, OR PROFIT OR ANY INDIRECT, SPECIAL, INCIDENTAL, OR CONSEQUENTIAL DAMAGES, EVEN IF RadioShack HAS BEEN ADVISED OF THE POSSIBILITY OF SUCH DAMAGES.

Some states do not allow limitations on how long an implied warranty lasts or the exclusion or limitation of incidental or consequential damages, so the above limitations or exclusions may not apply to you.

In the event of a product defect during the warranty period, take the product and the RadioShack sales receipt as proof of purchase date to any RadioShack store. RadioShack will, at its option, unless otherwise provided by law: (a) correct the defect by product repair without charge for parts and labor; (b) replace the product with one of the same or similar design; or (c) refund the purchase price. All replaced parts and products, and products on which a refund is made, become the property of RadioShack. New or reconditioned parts and products may be used in the performance of warranty service. Repaired or replaced parts and products are warranted for the remainder of the original warranty period. You will be charged for repair or replacement of the product made after the expiration of the warranty period.

This warranty does not cover: (a) damage or failure caused by or attributable to acts of God, abuse, accident, misuse, improper or abnormal usage, failure to follow instructions, improper installation or maintenance, alteration, lightning or other incidence of excess voltage or current; (b) any repairs other than those provided by a RadioShack Authorized Service Facility; (c) consumables such as fuses or batteries; (d) cosmetic damage; (e) transportation, shipping or insurance costs; or (f) costs of product removal, installation, set-up service adjustment or reinstallation.

This warranty gives you specific legal rights, and you may also have other rights which vary from state to state.

RadioShack Customer Relations, 200 Taylor Street, 6th Floor, Fort Worth, TX 76102

We Service What We Sell

12/99

RadioShack Corporation
Fort Worth, Texas 76102

43-1129

A

UCZZ01727BZ
05A01
Printed in China

Free Manuals Download Website

<http://myh66.com>

<http://usermanuals.us>

<http://www.somanuals.com>

<http://www.4manuals.cc>

<http://www.manual-lib.com>

<http://www.404manual.com>

<http://www.luxmanual.com>

<http://aubethermostatmanual.com>

Golf course search by state

<http://golfingnear.com>

Email search by domain

<http://emailbydomain.com>

Auto manuals search

<http://auto.somanuals.com>

TV manuals search

<http://tv.somanuals.com>