





Two Bell Wireless Door Chime

63-1124

OWNER'S MANUAL — Please read before using this equipment.

! IMPORTANT !

If an icon appears at the end of a paragraph, go to the box on that page with the corresponding icon for pertinent information.

-  — Warning
-  — Caution
-  — Important
-  — Hint
-  — Note

Receiver

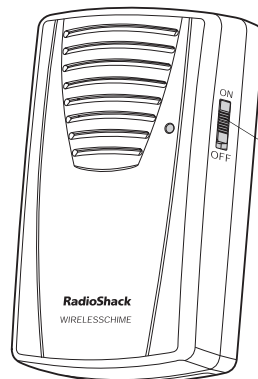

Slide ON/OFF to ON so that when BELL is pressed on one of the transmitters, a door chime sounds.

Transmitter (two included)

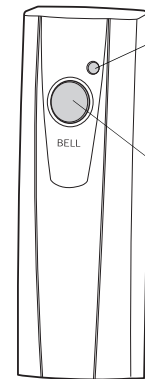

Indicator — Lights when BELL is pressed.

BELL — Press BELL to hear the door chime.

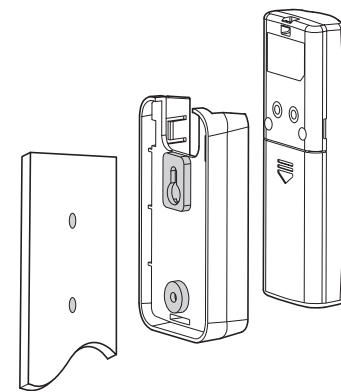

Thank you for purchasing the RadioShack Two Bell Wireless Door Chime. It works as a doorbell, a remote pager, or an alert. You can add an optional external sensor to have a chime that alerts you when someone walks into a room. The wireless door chime's three-position channel switch prevents other transmitters or radio devices from sounding the chime.

MOUNTING THE RECEIVER

ON A FLAT SURFACE

Pull out the wire stand on the back of the receiver and set it on a table or other flat surface.

ON A WALL

1. Drill one $\frac{3}{16}$ -inch diameter hole and insert one of the supplied anchors.
2. Drive the supplied M3.5 screw into the hole until the screw's head extends about $\frac{1}{8}$ inch from the wall.
3. Align the keyhole slot on the bottom of the receiver with the screw in the wall, then slide it down to secure it.

MOUNTING THE TRANSMITTER

1. Remove the transmitter from the holder.
2. Use the holder as a template to mark two screw holes on the wall.
3. Remove the holder from the mounting surface and drill two $\frac{3}{16}$ inch diameter holes. Insert one of the supplied anchors into each hole.

4. Drive a screw through the holders.

5. The transmitter can be slid in and out of the holder. To lock the transmitter in the holder, fix it with a size M2.6 screw at the bottom of the holder.

INSTALLING BATTERIES AND SELECTING CHANNELS

The wireless door chime requires three AAA size batteries in both transmitters and three C size batteries in the receiver. For best performance and longest life, we recommend RadioShack alkaline batteries.



IN THE TRANSMITTER

1. Slide the transmitter's battery compartment door in the direction of the arrow to remove it.
2. Use a small flat-blade screwdriver to slide the switch inside the battery compartment to the desired channel for the transmitter.

CAUTION

- Use only fresh batteries of the required size and type. Always remove old or weak batteries. They can leak chemicals that destroy electronic circuits
- Do not mix old and new batteries, different types of batteries (standard, alkaline, or rechargeable), or rechargeable batteries of different capacities.



RadioShack
www.radioshack.com

© 2002 RadioShack Corporation.
All Rights Reserved.
RadioShack and RadioShack.com are trademarks
used by RadioShack Corporation.

NOTE

The transmitter's channel setting must be the same as the receiver setting. If the door chime occasionally sounds without anyone pressing **BELL**, this indicates that the channel settings are different. Change the channel settings so both the transmitter and the receiver match.

NOTE

- Press **BELL** until the indicator lights. Otherwise, the receiver may not work properly.
- If you don't want to be bothered by the door chime, slide **ON/OFF** on the receiver to **OFF**.

Limited One-Year Warranty

This product is warranted by RadioShack against manufacturing defects in material and workmanship under normal use for one (1) year from the date of purchase from RadioShack company-owned stores and authorized RadioShack franchisees and dealers. EXCEPT AS PROVIDED HEREIN, RadioShack MAKES NO EXPRESS WARRANTIES AND ANY IMPLIED WARRANTIES, INCLUDING THOSE OF MERCHANTABILITY AND FITNESS FOR A PARTICULAR PURPOSE, ARE LIMITED IN DURATION TO THE DURATION OF THE WRITTEN LIMITED WARRANTIES CONTAINED HEREIN. EXCEPT AS PROVIDED HEREIN, RadioShack SHALL HAVE NO LIABILITY OR RESPONSIBILITY TO CUSTOMER OR ANY OTHER PERSON OR ENTITY WITH RESPECT TO ANY LIABILITY, LOSS OR DAMAGE CAUSED DIRECTLY OR INDIRECTLY BY USE OR PERFORMANCE OF THE PRODUCT OR ARISING OUT OF ANY BREACH OF THIS WARRANTY, INCLUDING, BUT NOT LIMITED TO, ANY DAMAGES RESULTING FROM INCONVENIENCE, LOSS OF TIME, DATA, PROPERTY, REVENUE, OR PROFIT OR ANY INDIRECT, SPECIAL, INCIDENTAL, OR CONSEQUENTIAL DAMAGES, EVEN IF RadioShack HAS BEEN ADVISED OF THE POSSIBILITY OF SUCH DAMAGES.

Some states do not allow limitations on how long an implied warranty lasts or the exclusion or limitation of incidental or consequential damages, so the above limitations or exclusions may not apply to you.

In the event of a product defect during the warranty period, take the product and the RadioShack sales receipt as proof of purchase date to any RadioShack store. RadioShack will, at its option, unless otherwise provided by law: (a) correct the defect by product repair without charge for parts and labor; (b) replace the product with one of the same or similar design; or (c) refund the purchase price. All replaced parts and products, and products on which a refund is made, become the property of RadioShack. New or reconditioned parts and products may be used in the performance of warranty service. Repaired or replaced parts and products are warranted for the remainder of the original warranty period. You will be charged for repair or replacement of the product made after the expiration of the warranty period.

This warranty does not cover: (a) damage or failure caused by or attributable to acts of God, abuse, accident, misuse, improper or abnormal usage, failure to follow instructions, improper installation or maintenance, alteration, lightning or other incidence of excess voltage or current; (b) any repairs other than those provided by a RadioShack Authorized Service Facility; (c) consumables such as fuses or batteries; (d) cosmetic damage; (e) transportation, shipping or insurance costs; or (f) costs of product removal, installation, set-up service adjustment or reinstallation.

This warranty gives you specific legal rights, and you may also have other rights which vary from state to state.
RadioShack Customer Relations, 200 Taylor Street, 6th Floor, Fort Worth, TX 76102

12/99

3. Install three AAA batteries as indicated by the polarity symbols (+ and -) marked inside.
4. Replace the compartment door.
5. Repeat Steps 1-4 for the other transmitter. If the transmitter's LED indicator dims, replace its batteries.

IN THE RECEIVER

1. Slide the receiver's battery compartment door in the direction of the arrow to remove it.
2. There are two channel switches inside the battery compartment — **BELL 1** and **BELL 2**. Slide the channel switches so that they are on the same channel as the transmitter.
3. Install three C size batteries as indicated by the polarity symbols (+ and -) marked inside the compartment.
4. Replace the compartment door. If the receiver's LED flashes with a short beep tone, replace its batteries.

OPERATION

1. Slide **ON/OFF** on the receiver to **ON**.
2. Press and hold down **BELL** on the BELL 1 transmitter. Transmit begins, the indicator lights, and the receiver sounds the door chime twice.
3. When **BELL** is pressed on the BELL 2 transmitter, it's indicator lights and the door chime sounds "Home sweet home".

USING THE CHIME AS AN ENTRY CHIME

1. Connect the transmitter to a normally open alarm sensor. You need 2-conductor wire (not supplied) to make this connection.
2. Split the ends of the wire, then connect the wire from the sensor's switch to the screw holes on the back of the transmitter, using the two supplied machine screws. If the sensor you are using has both normally open and normally closed contacts, be sure to connect to the sensor's normally open contacts.
3. Slide **ON/OFF** on the receiver to **ON**.

THE FCC WANTS YOU TO KNOW

This equipment has been tested and found to comply with the limits for a Class B digital device, pursuant to Part 15 of the *FCC Rules*. These limits are designed to provide reasonable protection against harmful interference in a residential installation. This equipment generates, uses and can radiate radio frequency energy and, if not installed and used in accordance with the instructions, may cause harmful interference to radio communications.

However, there is no guarantee that interference will not occur in a particular installation. If this equipment does cause harmful interference to radio or television reception, which can be determined by turning the equipment off and on, the user is encouraged to try to correct the interference by one or more of the following measures:

- Reorient or relocate the receiving antenna.
- Increase the separation between the equipment and receiver.
- Consult your local RadioShack store or an experienced radio/TV technician for help.
- If you cannot eliminate the interference, the FCC requires that you stop using your door chime.

Changes or modifications not expressly approved by RadioShack may cause interference and void the user's authority to operate the equipment.

This device complies with Part 15 of the *FCC Rules*. Operation is subject to the following two conditions: (1) this device may not cause harmful interference, and (2) this device must accept any interference received, including interference that may cause undesired operation.

SPECIFICATIONS

Frequency 433.92 MHz ± 600KHz
 Transmitter current consumption..... <10mA
 Receiver current consumption...<2mA @ standby
 < 130mA @ sound playing
 Receiver battery low..... 2.4V ± 0.1V
 Receiver audio power..... > 80dBA @ 25cm
 Transmitter operating
 temperature -20°C to 60 °C
 (-4°F to 140°F)

Specifications are typical; individual units might vary. Specifications are subject to change without notice.

Free Manuals Download Website

<http://myh66.com>

<http://usermanuals.us>

<http://www.somanuals.com>

<http://www.4manuals.cc>

<http://www.manual-lib.com>

<http://www.404manual.com>

<http://www.luxmanual.com>

<http://aubethermostatmanual.com>

Golf course search by state

<http://golfingnear.com>

Email search by domain

<http://emailbydomain.com>

Auto manuals search

<http://auto.somanuals.com>

TV manuals search

<http://tv.somanuals.com>