

Cat. No. 49-351

OWNER'S MANUAL

CENTRAL 2000
Easy Installation Monitored Motion Detector
Security System

Please read before using this equipment.

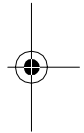
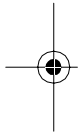
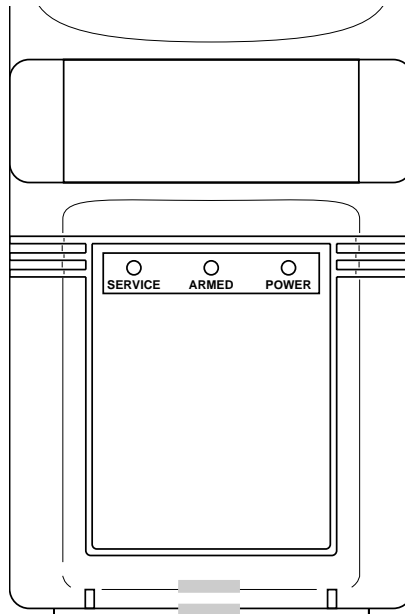

Radio Shack

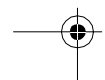
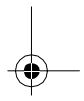
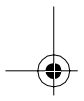

FEATURES

Your Radio Shack Central 2000 Easy Installation Monitored Motion Detector Security System brings a new level of protection to your home. Its PIR (Passive InfraRed) motion sensor gives a full 180 degrees of coverage. Once armed, it reports movement to ORCA[®] Monitoring Service's trained staff of security professionals who call you to verify the problem and then call the police and up to three other people you designate.

Your system includes these features:

Simple Installation—lets you start using the system by simply connecting it to power and a telephone line and setting up your account with ORCA Monitoring Services.

Built-In 100 dB Alarm—sounds when the system is armed and detects motion.

Warning Stickers—discourage potential burglars by alerting them to the presence of an alarm system.

Easy Arming and Disarming—uses the telephones in your home for quick arming and disarming.

ORCA-Monitored Security—means you get 24-hour monitoring, which alerts the police, neighbors, or you at work if the system detects unauthorized motion.

Radio Shack and ORCA, the security monitoring company, are independent of one another. No warranty or guarantee of performance of the ORCA Monitoring Services Agreement is provided by Radio Shack.
© 1995 Tandy Corporation.
All Rights Reserved.

Radio Shack is a registered trademark used by Tandy Corporation.
ORCA is a registered trademark of ORCA Technology, Inc.

INCLUDED ITEMS

Your Central 2000 includes the following accessories. Be sure you remove all accessories before you dispose of the packing materials.

- Central 2000 Motion Sensor
- Modular Telephone Cord
- Duplex Telephone Adapter
- AC Power Adapter
- Quick Reference Card
- ORCA Monitoring Service Agreement and Preprinted Envelope
- Four Window Stickers
- Wall Mounting Bracket with Screws



In addition, you need one 9-volt battery (Radio Shack Cat. No. 23-553, not supplied) to power your system during a power failure.

LOCAL PERMIT REQUIREMENTS

Some cities and municipalities require you to fill out a registration form and get a permit for monitored alarm service.

We recommend that you contact your local police or sheriff's department and inquire about local permit requirements.

Warning: To prevent fire or shock hazard, do not expose this product to rain or moisture.

	CAUTION RISK OF ELECTRIC SHOCK. DO NOT OPEN.	
CAUTION: TO REDUCE THE RISK OF ELECTRIC SHOCK, DO NOT REMOVE COVER OR BACK. NO USER-SERVICEABLE PARTS INSIDE. REFER SERVICING TO QUALIFIED PERSONNEL.		



This symbol is intended to alert you to the presence of uninsulated dangerous voltage within the product's enclosure that might be of sufficient magnitude to constitute a risk of electric shock. Do not open the product's case.



This symbol is intended to inform you that important operating and maintenance instructions are included in the literature accompanying this product.

Note: The security functions of this system have not been tested by UL.

READ THIS BEFORE INSTALLATION

We have designed your security system to conform to federal regulations, and you can connect it to most telephone lines. However, each device that you connect to the phone line draws power from the phone line. We refer to this power draw as the device's Ringer Equivalence Number, or REN (shown on the back of your system).

If you are using more than one phone or other device on the line, add up all the RENs. If the total is more than five, your phones might not ring. In rural areas, a total REN of three might impair ringer operation. If ringer operation is impaired, disconnect one of the devices from the line.

This security system complies with Part 68 of *FCC Rules*. You must, upon request, provide the FCC registration number and the REN to your phone company. Both numbers are shown on the back of the system.

Note: You must not connect this system to:

- Coin-operated systems
- Party-line systems
- Most electronic key telephone systems

CONTENTS

How the System Works	5
Setting Up Monitored Service	5
Preparation	7
Selecting a Location	7
Testing the Location	8
Mounting the System	9
Installing a Backup Battery	9
Connecting to Power	10
Connecting to the Telephone Line	10
Using the Warning Stickers	11
Operation	12
Arming the System	12
Disarming the System	12
Remote Arm/Disarming	13
Alarm Conditions	13
Understanding System Indicators	14
Clearing the Service Indicator	14
Testing the System	15
Testing Coverage	15
Testing the Siren	15
Testing the Monitoring Service	15
Care and Maintenance	16
The FCC Wants You to Know	17
Lightning	17
Troubleshooting	18

HOW THE SYSTEM WORKS

Your security system detects movement within a 180° arc up to 36 feet away. Once your system is armed, any movement within this range automatically triggers the alarm.

After you set up your account with ORCA Monitoring Services, your system calls and reports alarms to their trained staff of security professionals.

The ORCA Monitoring Services staff first tries to contact you to verify that it is not a false alarm. By calling you first, ORCA Monitoring Services ensures that the police are not contacted if you accidentally set off your alarm.

In alarm situations, the monitoring center dispatches the police to your address and tries to contact someone you listed on your emergency call list. (You might want to list your work phone number as the first number.)

ORCA Monitoring Services tries each number once in the order that you listed them on your monitoring agreement. If ORCA Monitoring Services contacts one of the people listed, they do not disturb the other people on the list.

SETTING UP MONITORED SERVICE

To set up service, you need to:

- Fill out the enclosed monitoring agreement and mail or fax it to ORCA Monitoring Services.

Monitored service does not begin until ORCA Monitoring Services receives and processes your monitoring agreement. Allow 24 hours for faxed requests and 5 days for mailed requests.

- Install the system
- Call ORCA Monitoring Services at 1-800-FOR-ORCA (1-800-367-6722) from a telephone on the same line as your system to have the system initialized.

During the call, ORCA Monitoring Services programs the PIN and other settings (listed on Page 6) into the system. The preferred settings work best for most situations. However, you can ask ORCA Monitoring Services to change these settings to make the system work best for you.

Place a check mark next to any settings you want to discuss with ORCA Monitoring Services, and refer to this page when you call them to set up service.

O Your Personal Identification Number (PIN)

Preferred setting: You select the 4-digit PIN you use to control your system.

Note: Do not select a PIN that starts with 0, 911, or 411.

Your PIN: _____

O Entry and Exit Delays

Preferred setting: 60-second exit delay; 30-second entry delay.

Each can be set from 20 to 275 seconds.

O Entry Delay Warning Beeps

Preferred setting: Beeping during the entry delay.

Can be set to sound only one beep at the beginning of the entry delay.

O Alarm Delay

Preferred setting: Delay siren until ORCA Monitoring Services is notified.

Can also be set to sound immediately after the alarm is triggered.

O Touch Tone Dialing

Preferred setting: Touch-tone dialing.

Can be set to use rotary dialing if you do not subscribe to touch-tone service from your local telephone company.

O Silent Alarm

Preferred setting: Audible alarm.

Can be set to only call ORCA Monitoring Services and not sound the siren at all.

O Security System Answer

Preferred setting: The system answers the phone in 8 rings.

Can be set not to answer or to answer in 1 to 10 rings.

PREPARATION

SELECTING A LOCATION

For your security system to be most effective, you need to install it in a location that meets all of the following conditions:

- Is near an AC outlet.

Note: If your best location is not near an AC outlet, you can have an electrician install an outlet for you.

- Is near a modular telephone jack.

Note: If your best location is not near a modular telephone jack, you can install a modular jack yourself or have the telephone company install one for you.

- Radio Shack stores sell jacks, adapters, and telephone wiring.
- The telephone company charges to install the necessary jacks.
- The USOC number of the jack to be installed is RJ-11C (or RJ-11W for a wall plate jack).

- Overlooks an area that an intruder would most likely cross when entering or moving through your home.

You can place the system on a shelf or table, or mount it on a wall or in the corner of a room. The system detects movement by sensing a change in temperature within its field of view. When someone walks past the system, it detects the temperature change and triggers the alarm.

Also, note that the system is more sensitive to movement across its coverage area than to movement directly toward or away from it.

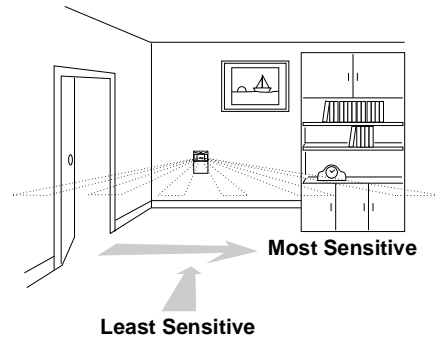

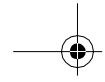

- Does not directly face a window, heating or air conditioning vent, appliance, outside wall, or other heat source.

These sources could produce rapid temperature changes that the system might incorrectly identify as an intruder.

- Is high enough not to be triggered by pets, yet is low enough to be triggered by someone of average height walking across the area.

To help prevent false alarms caused by pets, the system senses motion at or above its mounted location. It does not sense motion below where you mount it. In most installations, a location about 3½ feet off the floor provides the best security.

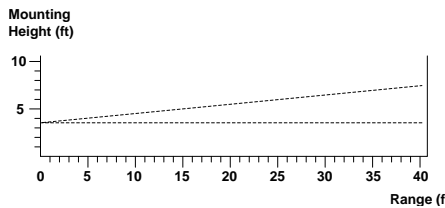

TESTING THE LOCATION

Once you select a location and before you mount it, follow these steps to test the system's coverage.

Note: To test the location, you do not need to connect the system to the phone line, install a backup battery, or set up service.

1. Plug the power adapter's barrel plug into the jack on the back of the system as shown on Page 10.
2. Plug the power adapter into an AC outlet as shown on Page 10.

Notes:

- If you have not installed a backup battery, the POWER indicator flashes.
 - If you have not connected the system to the phone line, the system chirps once per second.
3. Place the system at the selected location. If you selected a location on a wall, place the system on a stepladder or something similar to position it as close as possible to its final mounting location.
 4. Walk around the area you want to protect. When the system detects your movement, its ARMED indicator flashes.
 5. Adjust the system's position until you are satisfied with its coverage.

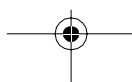

MOUNTING THE SYSTEM

You can mount the system on a wall or simply place it on a desk, table, or shelf.

To mount the system on a wall, use the supplied screws, or screws suitable to the mounting surface, to secure the mounting bracket at the selected location.

Mounting on a Wall Mounting in the Corner

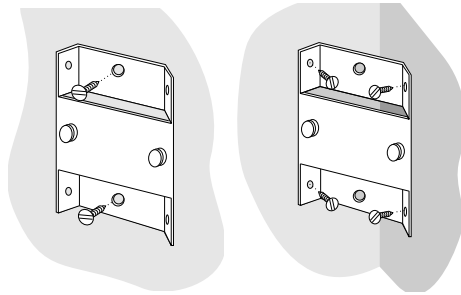

After you connect the system to power, install a battery, and connect it to the telephone line, you will simply hang the system on the bracket.

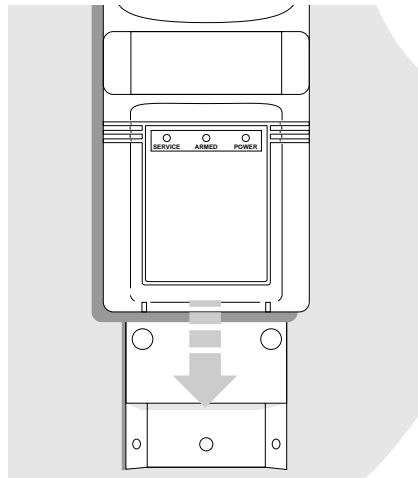

INSTALLING A BACKUP BATTERY

If AC power is disconnected or fails, your system operates for up to 24 hours from a 9-volt alkaline battery (Radio Shack Cat. No. 23-553, not supplied).

Warning: To prevent a possible electric shock, always disconnect the system from the phone line before you install or replace the battery.

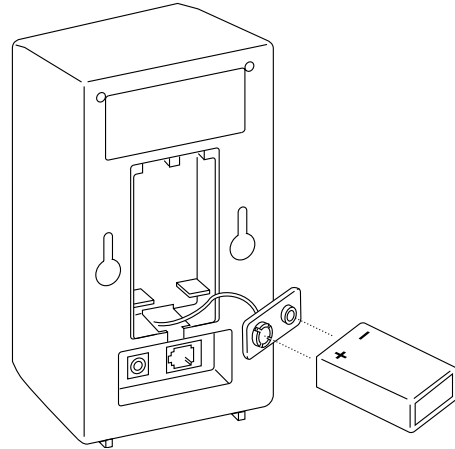

Follow these steps to install the battery.

1. Lift off the battery compartment cover.
2. Clip a 9-volt alkaline battery onto the battery contacts, then place the battery into the compartment.
3. Replace the cover.

When the battery becomes low, the POWER indicator blinks. Replace the battery immediately.

CONNECTING TO POWER

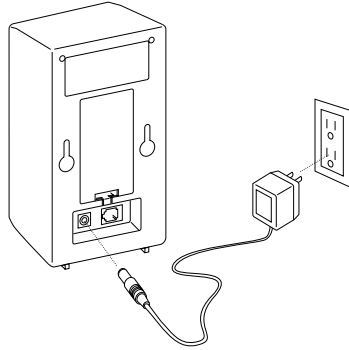

1. Plug the power adapter's barrel plug into the jack on the back of the system.
2. Plug the power adapter into an AC outlet.

Follow these steps to use the supplied duplex adapter to connect the alarm system and a telephone to the same jack.

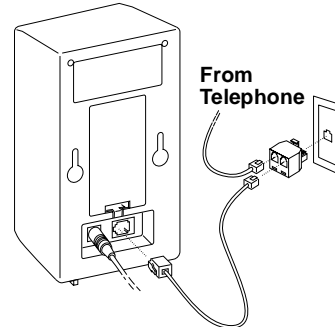

1. Unplug the telephone's cord from the jack.
2. Plug the duplex adapter into the jack.
3. Plug the telephone's cord into one of the adapter's jacks.
4. Plug one end of the supplied modular telephone cord into the jack on the back of the system.
5. Plug the other end of the cord into the other jack on the adapter.

CONNECTING TO THE TELEPHONE LINE

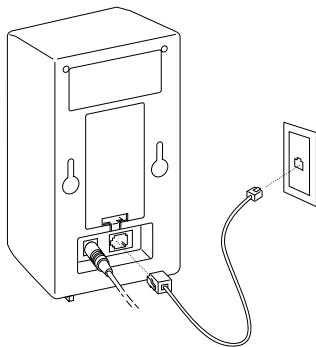

1. Plug one end of the supplied modular telephone cord into the jack on the back of the system.
2. Plug the other end of the cord into a modular telephone jack.

If the phone line is disconnected while the system has power, the system chirps once per second.

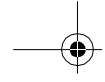

USING THE WARNING STICKERS

The four enclosed warning stickers are an important part of your security system. Statistics show that homes with a security system are 15 times less likely to be burglarized than homes that do not have a security system. The stickers are a first line of defense, warning a potential burglar that you have a system installed.

Place a sticker at areas where intruders would most likely enter your home, such as:

- The front door (most burglars enter this way)
- The back door
- Front and rear windows
- Fire escape windows (in apartment buildings)
- Side windows

Radio Shack stores sell additional stickers if you need more than the four supplied.

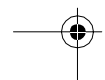
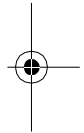
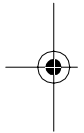

OPERATION

ARMING THE SYSTEM

You can arm your system for either delayed or instant alert.

When you arm the system for delayed alert, the system waits for the entry delay before sounding the alarm. The default entry delay is 30 seconds, but you can have ORCA Monitoring Services set it to be from 20 to 275 seconds. The system beeps once per second during the entry delay, unless you have selected to have it beep only once.

When you arm the system for instant alert, the alarm sounds instantly when it detects motion. If you select instant alert, be sure you can get to a telephone to disarm the system without moving through the protected area.

The system provides an exit delay for both delayed and instant alert arming. The default exit delay is 60 seconds, but you can have ORCA Monitoring Services set this to be from 20 to 275 seconds.

Follow these steps to arm the system.

1. Lift your phone's handset and dial 1-800-YOUR PIN. For example, if your PIN is 6864, dial 1-800-6864.
2. Press A (2) on your phone's keypad to arm the system for delayed alert or I (4) to arm the system for instant alert.

You hear one beep through the phone.

Note: If the system beeps three descending tones when you arm it, it has detected a fault with the system—either the AC power is disconnected, the backup battery is dead, or the SERVICE indicator is flashing. Disarm the system. Then correct the problem and try again.

3. Hang up the handset within 60 seconds of entering the command. The system beeps once and the ARMED indicator turns on. After the exit delay (60 seconds default), the system responds to motion.

DISARMING THE SYSTEM

To disarm the system, lift your phone's handset and dial 1-800-YOUR PIN and D (3). The system beeps twice through the phone. Hang up the phone within 60 seconds. The system beeps twice to confirm, then disarms.

Notes:

- If the system beeps three steady tones, the alarm sounded while you were away. Call ORCA Monitoring Services to get details about the alarm.
- If the system beeps three descending tones, it has detected a fault with the system—either the AC power is disconnected, the backup battery is dead, or the SERVICE indicator is flashing. Correct the problem as soon as possible.

- If you armed the system for instant alert, you must disarm the system from a phone you can reach without setting off the alarm.
- If the entry delay has elapsed, you must wait for the system to contact ORCA Monitoring Services and begin sounding the siren before you can disarm the system.

REMOTE ARM/DISARM

You can arm and disarm your system by calling your home. If you have an answering machine, wait for the answering machine to answer, then enter the arm or disarm code (1-800-YOUR PIN + A (2) to arm with an entry delay, I (4) to arm for instant alert, or D (3) to disarm). The system sounds one tone to verify arming, two tones to verify disarming, or three tones if there is a problem.

If you do not have an answering machine, ORCA Monitoring Services can have your system answer the phone after a specified number (the preferred setting is 8 rings). Enter the arm or disarm sequence when ringing stops.

Notes: Remote arming and disarming does not work if you have voice mail, call forwarding, another telephone service that routes unanswered calls to another number, or an answering machine that holds the line for more than 60 seconds after you hang up, and might not work with all remote-controlled answering machines.

ALARM CONDITIONS

When the system detects a violation, it calls ORCA Monitoring Services then starts a 5-minute alert siren. ORCA Monitoring Services first calls your home to try to confirm the alarm. If no one answers, or if the person who answers does not know your password, ORCA Monitoring Services notifies the police and also tries to contact at least one person you listed on your monitoring service agreement.

After 5 minutes, the system stops sounding the siren and rearms. The next time you disarm the system, it sounds three tones to let you know that the system was violated.

Note: If your system has repeated false alarms, ORCA Monitoring Services might temporarily disarm your system until the problem is resolved.

CLEARING THE SERVICE INDICATOR

After you start service with ORCA Monitoring Services, the yellow indicator flashes when ORCA Monitoring Services needs to contact you. If the SERVICE indicator flashes, call 1-800-FOR-ORCA to find out how to clear the indicator. The system still functions as a stand alone alarm when the indicator is flashing, but it does not call ORCA Monitoring Services during an alert.

UNDERSTANDING SYSTEM INDICATORS

Your system has three indicators and five alert tone patterns. The following tables describe each.

Indicator	On	Off	Flashing
Service (Yellow)	N/A	All Ok.	Call ORCA Monitoring Services.
Power (Green)	Power OK.	No power.	Battery problem.
Armed (Red)	System armed.	System disarmed.	System disarmed, motion detected.

Beep Pattern	Meaning
One beep	You armed the system. The entry delay warning beeps are disabled, and the system started the entry delay.
Two beeps	You disarmed the system and there were no alerts since it was last armed.
Three steady beeps	You disarmed the system and there has been an alert since it was last armed.
Three descending beeps	You armed or disarmed the system, and there is an AC power or backup battery problem. You armed or disarmed the system, and the SERVICE indicator is flashing.
Continuous beeps	The system is sounding entry delay warning beeps or the phone line is disconnected.

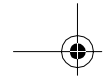

TESTING THE SYSTEM



There are three ways to test your system:

- Testing Coverage
- Testing the Siren
- Testing the Monitoring Service

TESTING COVERAGE

Periodically test the coverage to be sure your system will detect intruders. To do this, disarm the system. Then walk around the covered area. When the system detects your movement, the red ARMED indicator flashes. If the system does not sense your movement, reread "Installation" to be sure it is properly installed.

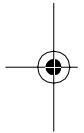

TESTING THE SIREN

Periodically test the siren to be sure it will sound when triggered. To do this, lift the handset of any phone connected to the same line as the system. Then dial 1-800-YOUR PIN and T (8) then hang up within 60 seconds. The system waits for the exit delay. Then, when it detects motion, it sounds the siren for 3 seconds.

TESTING THE MONITORING SERVICE

Periodically have the system call the monitoring service to confirm they are properly receiving its signals during an alert. Before you do this, have your password handy. First call ORCA Monitoring Services at 1-800-FOR-ORCA to let them know you are going to test the system. Then arm the system, wait for the exit delay to expire, and walk through the covered area.

ORCA Monitoring Services should call you within a few minutes of the alert. Give them the password and advise them again that you were testing the system.

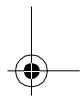
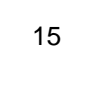
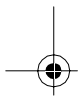
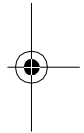



CARE AND MAINTENANCE

Your Radio Shack Central 2000 Easy Installation Monitored Motion Detector Security System is an example of superior design and craftsmanship. Follow these guidelines to keep it working properly for years.



Keep the system dry. If it gets wet, wipe it dry immediately. Liquids can contain minerals that corrode electronic circuits.



Use and store the system only in normal temperature environments. Temperature extremes can shorten the life of electronic devices and distort or melt plastic parts.



Handle the system gently and carefully. Dropping it can damage circuit boards and cases and can cause the system to work improperly.



Keep the system away from dust and dirt, which can cause premature wear of parts.



Use only a fresh 9V alkaline battery in the system. An old or weak battery can leak chemicals that could damage electronic circuits.



Wipe the system with a damp cloth occasionally to keep it looking new. Do not use harsh chemicals, cleaning solvents, or strong detergents to clean your system.

Modifying or tampering with the system's internal components can cause a malfunction and invalidate your system's warranty and void your FCC authorization to operate it. If your system is not performing as it should, take it to your local Radio Shack store or contact ORCA Monitoring Services at 1-800-FOR-ORCA for assistance. If the trouble is harming the phone lines, the telephone company might ask you to disconnect the system until you resolve the problem.



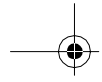

THE FCC WANTS YOU TO KNOW

In the unlikely event that your system causes problems on the phone line, the phone company can disconnect your service. The phone company attempts to notify you in advance. If advance notice is not practical, the phone company notifies you of your right to file a complaint with the FCC.

Also, the phone company can make changes to its lines, equipment, operations, or procedures that could affect the operation of your system. The phone company notifies you in advance, so you can take steps to prevent interruption of your phone service.

LIGHTNING

Your system has built-in protection circuits to reduce the risk of damage from surges in phone and power line current. These protection circuits meet or exceed FCC requirements. However, lightning striking the phone or power lines can damage your system.

Lightning damage is not common. However, if you live in an area that has frequent electrical storms, we suggest that you unplug your system during storms to reduce the possibility of damage.

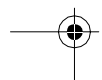
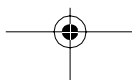
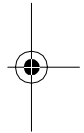
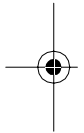

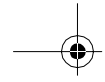

TROUBLESHOOTING

We do not expect you to have any problems with your system. However, if you do, try the suggestions in this section first. If you still cannot solve the problem, call 1-800-FOR-ORCA or contact any Radio Shack store for assistance.

Frequent False Alarms

- Always disarm the system as soon as you get home.
- Do not let children arm and disarm the system.
- If you are not sure whether the system is armed or disarmed, disarm it.
- Be sure everyone authorized to be in your home knows both the PIN and your password.
- Periodically test your system. See “Testing the System” on Page 15.

Three Tones When You Arm or Disarm the System

- Be sure the system is properly connected to AC power and a backup battery is installed.
- If the yellow SERVICE indicator is flashing, call 1-800-FOR-ORCA for instructions. The system does not call ORCA Monitoring Services during an alert if the SERVICE indicator is flashing.

Cannot Arm or Disarm the System

- Be sure you are using the correct PIN.
- Be sure the system is properly connected to the phone line and that either AC power or the backup battery is connected (or both).
- Slow down. Even if the system is sounding the alarm, you have plenty of time to enter the PIN.

Indicators are Flashing

- See “Understanding System Indicators” on Page 14 for a complete description of all indicators.

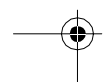
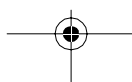



NOTES

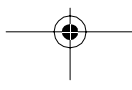
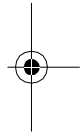
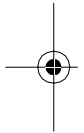

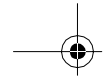

RADIO SHACK LIMITED WARRANTY

This security product is warranted against manufacturing defects in material and workmanship for ninety (90) days from the date of purchase from Radio Shack company owned stores and authorized Radio Shack franchisees and dealers. Within this period Radio Shack will repair the security product without charge for parts and labor. Simply **bring your Radio Shack sales slip** as proof-of-purchase date to any Radio Shack store.

This warranty does not cover damage or failure caused by or attributable to Acts of God, abuse, misuse, improper or abnormal usage, faulty installation, improper maintenance, lightning or other incidence of excess voltage, or any repairs other than those provided by a Radio Shack Authorized Service Facility, or transportation costs. **Radio Shack is not responsible or liable for indirect, special, or consequential damages arising out of or in connection with the use or performance of the product or other damages with respect to loss of property, loss of revenues or profit, or costs of removal, installation or reinstatement.**

EXCEPT AS PROVIDED HEREIN, RADIO SHACK MAKES NO EXPRESS WARRANTIES AND ANY IMPLIED WARRANTIES ARE LIMITED IN DURATION TO THE DURATION OF THE WRITTEN LIMITED WARRANTIES CONTAINED HEREIN. Some states do not allow the limitation or exclusion of incidental or consequential damages and some states do not allow limitation or exclusion of implied warranties; therefore, the aforesaid limitation(s) or exclusion(s) may not apply to the purchaser. There will be charges rendered for repairs to the product made after the expiration of the aforesaid ninety (90) day warranty period.

This warranty gives you specific legal rights and you may have other rights which vary from state to state.

We Service What We Sell

9/94

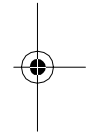

RADIO SHACK
A Division of Tandy Corporation
Fort Worth, Texas 76102

10A5

Printed in Hong Kong

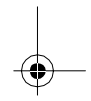
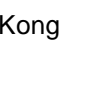
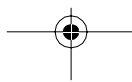
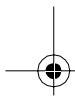

Free Manuals Download Website

<http://myh66.com>

<http://usermanuals.us>

<http://www.somanuals.com>

<http://www.4manuals.cc>

<http://www.manual-lib.com>

<http://www.404manual.com>

<http://www.luxmanual.com>

<http://aubethermostatmanual.com>

Golf course search by state

<http://golfingnear.com>

Email search by domain

<http://emailbydomain.com>

Auto manuals search

<http://auto.somanuals.com>

TV manuals search

<http://tv.somanuals.com>