

# OWNER'S MANUAL

## Mobile Audio System

---

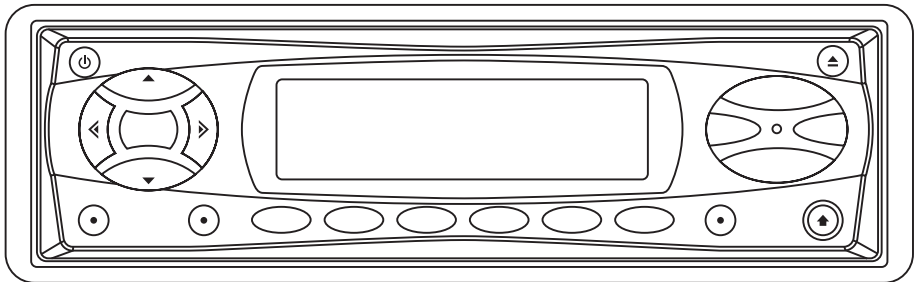

- **PLL Synthesizer Stereo Radio**
- **Digital Compact Disc Player**
- **Automatically Memory Storing**
- **Full Detachable Panel**
- **Program CD Tracks**
- **CD Changer Control**
- **Auxiliary Input Function**

# CONTENTS

---

- Installation .....3**
  - DIN Front-Mount.....3
  - Installing the unit.....3
  - Removing the unit.....4
- Using the Detachable Front Panel .....5**
- Wiring Connection .....6**
  - 4 x 40 system .....6
- Operation .....7**
  - General Operation .....7
  - Radio Operation .....9
  - CD Operation .....10
  - CD Changer Operation .....11
- Specification.....12**
- Trouble Shooting .....13**

# INSTALLATION

## Notes:

- The unit can be installed on the vehicle or the ships.
- Choose the mounting location where the unit will not interfere with the normal driving function of the driver.
- Before finally installing the unit, connect the wiring temporarily and make sure it is all connected up properly and the unit and the system work properly.
- Use only the parts included with the unit to ensure proper installation. The use of unauthorized parts can cause malfunctions.
- Consult with your nearest dealer if installation requires the drilling of holes or other modifications of the vehicle or the ship.
- Install the unit where it does not get in the driver's way and cannot injure the passenger if there is a sudden stop, like an emergency stop.
- If installation angel exceeds 30° from horizontal, the unit might not give its optimum performance.

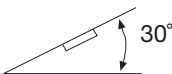

- Avoid installing the unit where it would be subject to high temperature, such as from direct sunlight, or from hot air, from the heater, or where it would be subject to dust, dirt or excessive vibration.

## TAKE OUT SCREW BEFORE INSTALL

Before install the unit, please remove the two screws.

Take out screw before installation

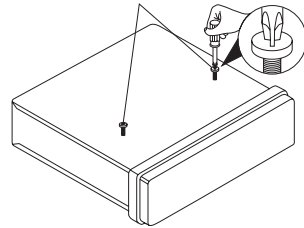

NOTE: If this unit is installed on the ship, you should use two pieces of plastic film (30mmx20mm) supplied with the unit to seal the two holes after remove the screws. And this will be waterproof.

## DIN FRONT-MOUNT

### Installing the unit

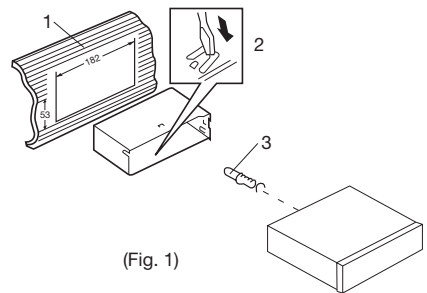

(Fig. 1)

1. Dashboard
2. Holder  
After inserting the holder into the dashboard, select the appropriate tab according to the thickness of the dashboard material and bend them inwards to secure the holder in place.
3. Screw

# INSTALLATION

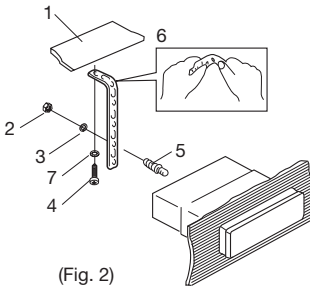

(Fig. 2)

1. Dashboard
2. Nut (5mm)
3. Spring washer
4. Screw (5x25mm)
5. Screw
6. Strap

Be sure to use the strap to secure the back of the unit in place. The strap can be bent by hand to the desired angle.

7. Plain washer

## Removing the unit

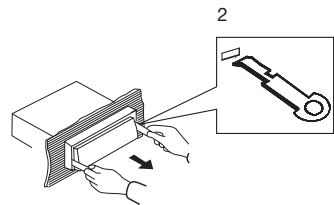
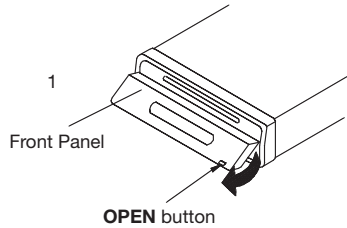

1. Before removing the unit, press the **OPEN** button to slide down the front panel.
2. Lever  
Insert the levers supplied with the unit into the grooves in the housing as shown in figure until they click. Pulling the levers makes it possible to remove the unit from the dashboard.

# USING THE DETACHABLE FRONT PANEL

## To Detach the Front Panel

1. Press the **OPEN** button, the front panel will slide down.

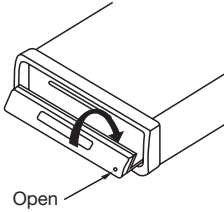

2. When the front panel slides down, press the bottom button of the front panel upward and pull it out from the panel bracket.

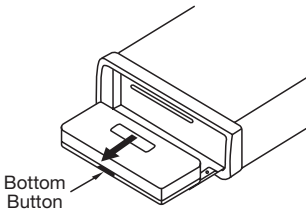

3. For safekeeping, store the front panel in the supplied protective case immediately after being removed.

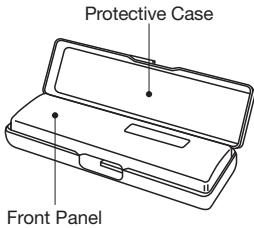

## To Reinstall the Front Panel

1. When the panel bracket is in slide down position, insert the front panel into the panel bracket and push the front panel from the middle to slide it up.

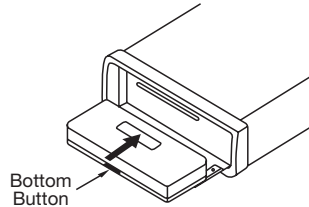

2. When the panel bracket is in slide up position, insert a side of the front panel to its proper position and push another side into the panel bracket, a 'click' sound should be heard.

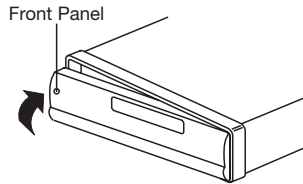

3. Note that if the front panel fails to lock in position properly, pressing control button may not function and LCD display may be missing some segments. Press the **OPEN** button and then re-install the front panel again.

# WIRING CONNECTION

For 4 x 40W System

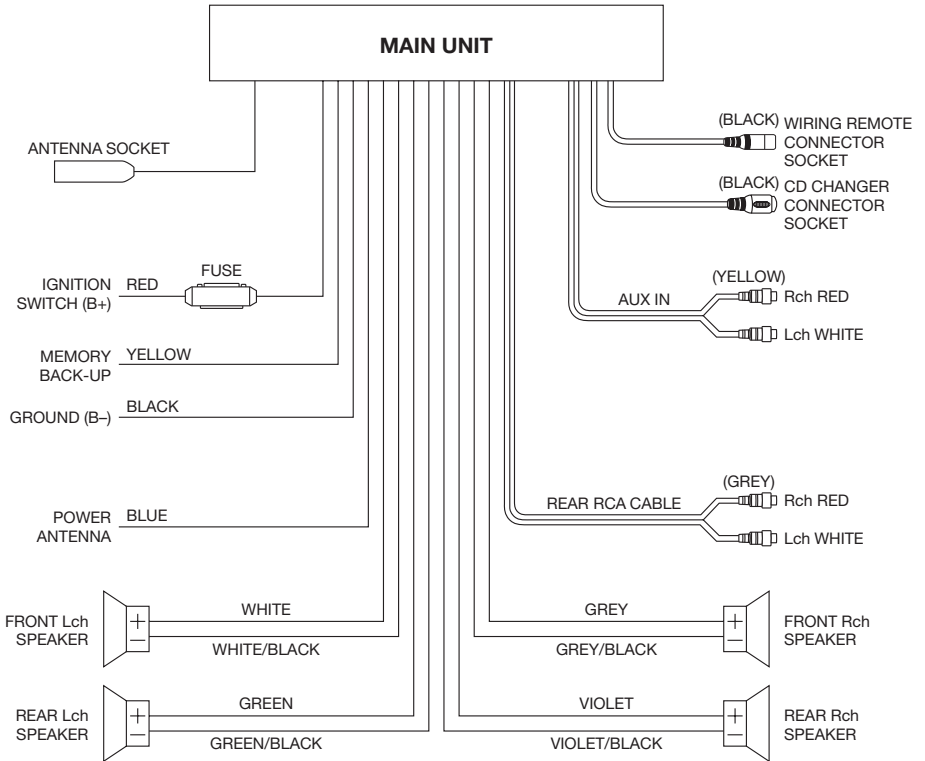

## OPERATION

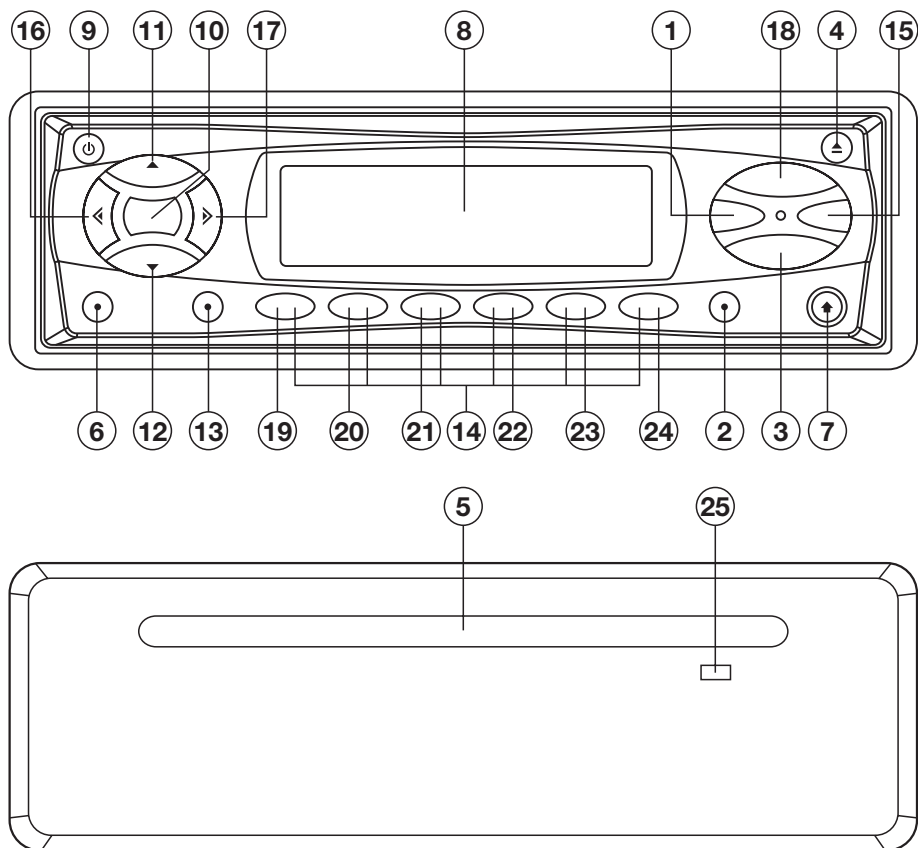

### GENERAL OPERATION

#### • ON/OFF

Switch on the unit by pressing **PWR** button (9). When system is on, press **PWR** button (9) again to turn off the unit.

Press **PWR** button (9) for more than 2 seconds, the button is operated to initial volume control button. When system power turns on, the volume is set to initial volume level.

#### • FACEPLATE RELEASE

Press **OPEN** button (7) to detach the removable faceplate.

#### • SOUND ADJUSTMENT

Press **SEL** button (10) to select desired audio mode.

The adjustment mode will change in the following order.

► Volume → Bass → Treble → Balance → Fader

By pressing **VOL ▲** button (11) or **VOL ▼** (12), it is possible to adjust the desired sound quality.

#### • AUDIO BEEP

Press **SEL** button (10) for more than 2 seconds to turn beep on/off. When beep is on, “(Ⓜ)” icon appears in the

# OPERATION

---

display. If you select beep sound on, whenever press any button, beep sound output.

- **LOUDNESS**

Press **LOUD (DIM)** button (15) shortly to reinforce the bass output and display will show "LOUD". Press it again to release this function.

- **ILLUMINATION**

Press **LOUD (DIM)** button (15) for more than 2 seconds to adjust the brightness of the LCD display backlight.

- **MUTE**

In radio/AUX IN mode, press **▶/II /MUTE** button (3) to mute audio level. Press the button again to release mute function.

- **SELECT MODE**

Press **MODE** button (6) to choose desired listening mode. (e.g. radio mode to CD mode to CDC mode to AUX IN mode).

- **SET THE CLOCK**

Press **DISP** button (1) for more than 2 seconds until the clock is shown on the display and flashes. Then press the **▶** button (17) to change minutes or button **◀** (16) to change hours.

- **DISPLAY PRIORITY**

### **Clock Priority**

Press and hold **DISP** button (1) while pressing **◀** button (16) to select Clock Priority.

Pressing **DISP** button (1) while in Clock Priority will temporarily display selected station frequency (in RADIO mode) or track number (in CD/CDC mode) or state information (in AUX IN mode).

### **Frequency Priority**

Press and hold **DISP** button (1) while

pressing **▶** button (17) to select Frequency Priority.

Pressing **DISP** button (1) while in Frequency Priority will temporarily display clock.

- **SELECTABLE CLOCK DISPLAY**

Programs the unit to display the clock (selectable on/off) when the unit is turned off. While the unit is turned on, pressing and holding **MODE** button (6) and then pressing M2 button (20) toggles the selectable clock display.

- **LIQUID CRYSTAL DISPLAY**

Exhibit current frequency and activated functions on the display (8).

- **RESET**

Reset button (25) must be activated with either a ballpoint pen or thin metal object. The reset button is to be activated for the following reasons:

- Initial installation of the unit when all wiring is completed.
- All the function buttons do not operate.
- Error symbol on the display.

**Note:** If press reset button (25), the unit can't work yet, please use a cotton swab soaked in isopropyl alcohol to clean the socket on the front panel.



# OPERATION

---

## RADIO OPERATION

### • BAND SELECTION

At tuner mode, press **BAND** button (18) shortly to select the desired band. The reception band will change in the following order:

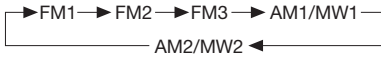

### • STATION SELECTION

Press ◀ button (16) or ▶ button (17) shortly to activate automatic seek function. Press for more than 3 seconds until “**MAN**” appeared on the display, the manual tuning mode is selected. If both buttons have not pressed for several seconds, they will return to seek tuning mode and “**AUTO**” appeared on the display.

### • AUTOMATICALLY MEMORY STORING & PROGRAM SCANNING

- Automatic memory storing  
Press **AS/PS (ELAPSE)** button (2) for more than 2 seconds, the radio searches from the current frequency and checks the signal strength until 6 strongest stations are stored into the corresponding preset number button. When all completed, it will change to scan preset station automatically.
- Program scanning  
Press **AS/PS (ELAPSE)** button (2) shortly to scan preset station. The radio is holding at that preset number for several seconds, and then searches again. Press **AS/PS (ELAPSE)** button (2) again to stop scanning when desired station is reached.

### • STATION STORING

Press any one of the preset buttons (14) (M1 to M6) (i.e.19~24) to select a station which had been stored in the memory. Press this button for several seconds, current station is stored into the number button.

### • SCAN

Press **SCAN** button (13) to scan through strong stations in the current band. Radio pauses for five seconds at each strong station. At each time the frequency is flashing on the display. Press **SCAN** button (13) again to listen to current station.

### • SELECTABLE FREQUENCY SPACING (FOR USA VERSION ONLY)

Programs the unit for USA or European radio frequency spacing. While in radio mode, pressing and holding **BAND** button (18) and then pressing button (17) or button (16) toggles between USA or European frequency spacing.

- Pressing and holding **BAND** button (18) and then pressing button (17) selects USA frequency spacing.
- Pressing and holding **BAND** button (18) and then pressing button (16) selects European frequency spacing.
  - \* USA radio spacing is 200k for FM and 10k for AM. This is the default frequency spacing.
  - \* European radio spacing is 50k for FM and 9k for AM.

# OPERATION

---

## CD OPERATION

### • SELECT TRACKS

Press ◀ button (16) or ▶ button (17) to move to the previous track or the following track. Track number shows on display.

Hold press ◀ button (16) or ▶ button (17) to fast reverse or fast forward. Disc play starts from when you release the button.

### • PAUSE PLAYING

Press ▶/II/MUTE button (3) to pause CD player. Press it again to resume play.

### • REPEAT THE SAME TRACK

Press RPT button (22) to continuously repeat the same track. Press it again to stop repeat.

### • PREVIEW ALL TRACKS

Press INT button (24) to play first several seconds of each track on current disc. Press it again to stop intro scan and listen to track.

### • PLAY ALL TRACKS IN RANDOM

Press RDM button (23) to play all tracks on the current disc in random. Press it again to cancel the function.

### • PROGRAM CD TRACKS

Use Program function to select up to 32 tracks to play in any order. Program works by allowing you to select a track number for each spot in the playing sequence. A CD must be inserted and in CD playing mode to use Program.

- How to program CD tracks
- 1. Press **MEM** button (20) to enter Program mode, then “PGM” starts flashing and “P-01” icon appear on the display.
- 2. Press button (16) or button (17) to choose track number. For example,

select track 6, then press **MEM** button (20) to memorize it and “P-02” will appear on the display. So track 6 will be played first. Thus, you can also press / buttons (17) and (16) to choose track number 10 and press **MEM** button, then “P-03” will appear. So track 10 will be secondly played. Repeat these operations, and you can program CD tracks to your need. If you completed program setting, press **PGM** button (21) to play CD in programmed order.

Note: Using Program function can only select up to 32 tracks to play in any order. When you have selected 32 tracks to be programmed. “FULL” will appear on the display.

- When the CD is played in programmed order by pressing **PGM** button (21), pressing it again will exit PGM mode.
- When the disc is playing in programmed order, pressing **MEM** button (20) will cancel the all programmed content and “CLR” appears on the display.
- If you don't press **MEM** button (20) to carry out program setting, then press **PGM** button (21), “NO-P” will appear.

### • TRACK/TIME DISPLAY

Press AS/PS (ELAPSE) button (2) to show running time/remain time of track.

### • EJECT

When the front panel is sliding down, press **EJ** button (4) to eject the disc.

# OPERATION

---

## CD CHANGER OPERATION

### • SELECT TRACKS

Press ◀ button (16) or ▶ button (17) to move to the previous track or the following track. Track number shows on display.

Hold press ◀ button (16) or ▶ button (17) to fast reverse or fast forward. Disc play starts from when you release the button.

### • PAUSE PLAYING

Press ▶/II/MUTE button (3) to pause CDC player. Press it again to resume play.

### • REPEAT THE SAME TRACK

Press RPT button (22) to continuously repeat the same track. Press it again to stop repeat.

### • PREVIEW ALL TRACKS

Press INT button (24) to play first several seconds of each track on current disc. Press it again to stop intro scan and listen to track.

### • PLAY ALL TRACKS IN RANDOM

Press RDM button (23) to play all tracks on the current disc in random. Press it again to cancel the function.

### • TRACK/TIME DISPLAY

Press AS/PS (ELAPSE) button (2) to show running time of track.

### • SELECT DISC

Press SACN(SHIFT) button (13) to shift mode and then "SHIFT" will appear on the display. At shift mode, press ◀ button (16) or ▶ button (17) to select previous disc or next disc. If there isn't any operation for several seconds, it will exit shift mode automatically.

## Note:

### A. Notes on discs:

1. Attempting to use non-standard shape discs (e.g. square, start, heart) may damage the unit. Be sure to use round shape CD discs only for this unit.
2. Do not stick paper or tape, etc, onto the label side or the recording side of any discs, as it may cause a malfunction.
3. Dirt, dust, scratches and warping discs will cause misoperation.

### B. Notes on CD-Rs (recordable CDs)/CD-RWs (rewritable CDs):

1. Be sure to use discs with following marks only for the unit to play:



2. The unit cannot play a CD-R and CD-RW that is not finalized. (Please refer to the manual of your CD-R/CD-RW recorder or CD-R/CD-RW software for more information on finalization process).
  3. Depending on the recording status, conditions of the disc and the equipment used for the recording, some CD-Rs/CD-RWs may not be played on this unit. (see \*1)
- \*1: To have more reliable play back, please see following recommendations:
- a: Use CD-RWs with speed 1x to 4x and write with speed 1x to 2x.
  - b. Use CD-Rs with speed 1x to 8x and write with speed 1x to 2x.
  - c. Do not play a CD-RW which has been written for more than 5 times.

# SPECIFICATION

---

## GENERAL

Power Supply Requirements	: DC 12 Volts, Negative Ground
Chassis Dimensions	: 178 (W) x 178 (D) x 50 (H) mm
Tone Controls	
- Bass (at 100 Hz)	: $\pm 10$ dB
- Treble (at 10 KHz)	: $\pm 10$ dB
Maximum Output Power	: 4 x 40 Watts
Current Drain	: 15 Ampere (max.)

## CD PLAYER

Signal to Noise Ratio	: More than 55 dB
Channel Separation	: More than 50 dB
Frequency Response	: 40 Hz - 18 KHz

## RADIO

### FM

Frequency Coverage	: 87.5 to 107.9 MHz
IF	: 10.7 MHz
Sensitivity (S/N = 30 dB)	: 3 $\mu$ V
Stereo Separation	: > 30 dB

### AM

Frequency Coverage	: 530 to 1720 KHz
IF	: 450 KHz
Sensitivity (S/N = 20 dB)	: 32 dBu

# TROUBLE SHOOTING

Before going through the check list, check wiring connection. If any of the problems persist after check list has been made, consult your nearest service dealer.

Symptom	Cause	Solution
No power.	The car ignition switch is not on.	If the power supply is properly connected to the car accessory circuits, but the engine is not moving, switch the ignition key to "ACC".
	The fuse is blown.	Replace the fuse.
Disc cannot be loaded or ejected.	Presence of CD disc inside the player.	Remove the disc in the player, then put a new one.
	Inserting the disc in reverse direction.	Insert the compact disc with the label facing upward.
	Compact disc is extremely dirty or defective disc.	Clean the disc or try to play a new one.
	Temperature inside the car is too high.	Cool off or until the ambient temperature return to normal.
	Condensation.	Leave the player off for an hour or so, then try again.
No sound.	Volume is in minimum.	Adjust volume to a desired level.
	Wiring is not properly connected.	Check wiring connection.
Sound skips.	The installation angle is more than 30 degrees.	Adjust the installation angle less than 30 degrees.
	The disc is extremely dirty or defective disc.	Clean the compact disc, then try to play a new one.
The operation keys do not work.	The built-in microcomputer is not operating properly due to noise.	Press the RESET button. Front panel is not properly fixed into its place.
The radio does not work. The radio station automatic selection does not work.	The antenna cable is not connected.	Insert the antenna cable firmly.
	The signals are too weak.	Select a station manually.

[www.pyleaudio.com](http://www.pyleaudio.com)

## Free Manuals Download Website

<http://myh66.com>

<http://usermanuals.us>

<http://www.somanuals.com>

<http://www.4manuals.cc>

<http://www.manual-lib.com>

<http://www.404manual.com>

<http://www.luxmanual.com>

<http://aubethermostatmanual.com>

Golf course search by state

<http://golfingnear.com>

Email search by domain

<http://emailbydomain.com>

Auto manuals search

<http://auto.somanuals.com>

TV manuals search

<http://tv.somanuals.com>