

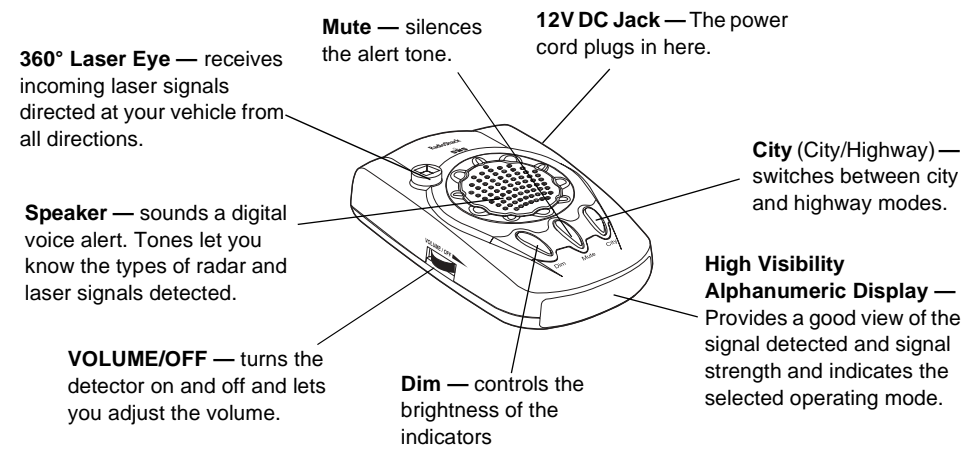

**CONTROLS**



**CONNECTING POWER**

Plug the supplied power cord's barrel plug into the detector's 12V DC jack. Then plug the cord's cigarette-lighter plug into your vehicle's cigarette-lighter socket.

**Note**

- To prevent the detector from draining your vehicle's battery if you leave the detector on when you turn off the ignition, unplug the power cord from your vehicle's cigarette lighter socket.
- If the detector does not operate when you turn it on, remove the cigarette-lighter plug from your vehicle's socket and check the socket for debris. Also, check the fuse in the detector's plug and your vehicle's cigarette lighter fuse.

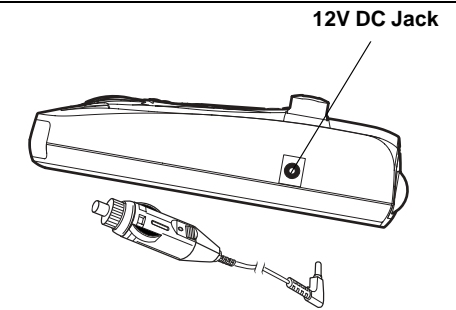

**CAUTION**

- Use only the supplied 12V DC, Positive (+) Tip power cord.
- Before plugging the power cord's cigarette-lighter plug into your vehicle's cigarette-lighter socket, make sure the plug's tip is screwed firmly onto the plug.

Thank you for purchasing a RadioShack Voice/Text Radar Detector. Your radar detector can alert you to many traffic radar and laser systems with its distinct visual and audio alerts. It receives X-, K-, and Ka-band radar signals, and detects both the instant-on and laser systems many law enforcement agencies use to measure vehicle speed. Plus, your detector can give you advance warning of potential road hazards by detecting signals from transmitters that broadcast Safety Warning System™ (SWS) alerts.

**INSTALLATION**

**SELECTING A MOUNTING LOCATION**

For the best performance, select a location where the detector has a direct view of the road. The detector's radar antenna is at the opposite end of the indicators.

**Mounting Guidelines**

- Choose a location that does not block the driver's view of the road.
- Mount the detector in a level position with a clear view of both the front and rear of your vehicle.
- Choose a location that gives the detector a view unobstructed by metal objects.
- Some vehicles have InstaClear® or ElectriClear® defogging windshields, which have metal coatings that block signals. Check your vehicle's owner's manual to see if your vehicle has one of these features. A detector installed in a vehicle with one of these features might not detect a signal.
- Since window tinting reduces the received strength of laser signals, you should not mount the detector behind heavily tinted glass.
- Do not mount the detector where the driver or a passenger might hit it in a sudden stop or accident.

**CAUTION**

Do not use the mounting bracket in a vehicle that has a plastic safety coating on the inside of the windshield designed to protect passengers during an accident. If you use the bracket on this type of windshield, you might permanently mar the windshield's surface. Mount the radar detector on the dashboard instead.

**Note**

Though the detector has a 360° laser and radar detection range, the radar detection is most sensitive in the front range.

**DASHBOARD MOUNTING**

In some vehicles, the dashboard may be the best location to mount the detector. Use the supplied hook-and-loop tape to mount your radar detector to the dash.

- Use a damp cloth to clean the bottom of the detector and the dashboard. Let both surfaces dry.
- Remove the tape's paper backing and stick the tape to the bottom of the detector.
- Remove the backing from the other side of the tape and firmly press your detector onto the dashboard.

**Dashboard Mounting Notes**

- The tape's adhesive might not stick to a surface treated with vinyl cleaner or protectant.
- Do not place the hook-and-loop tape over the detector's serial number.
- On a curved dashboard, cut the supplied strip in half and use one strip on each side of the bottom of the detector.
- Be sure to place the detector out of view when you leave the vehicle. This keeps the detector out of sight of thieves and prevents exposure to extremely high temperatures, which can temporarily impair your detector's performance.

**PACKAGE CONTENTS**

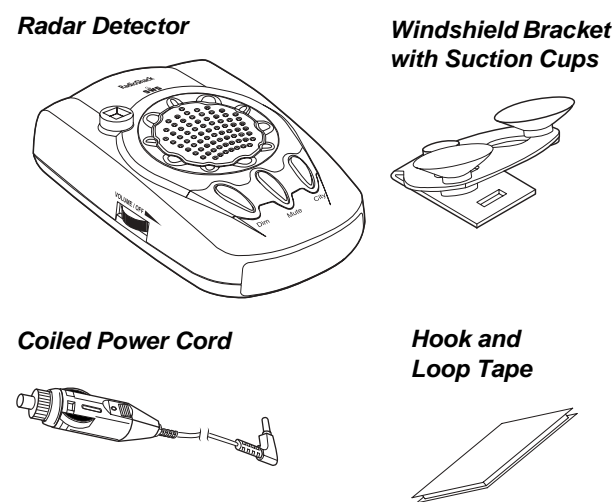

**Question and Answer About Vehicle Speed Detection**

**Note**

Before reading this Owner's Manual, read the supplied booklet *Questions and Answers About Vehicle Speed Detection* to familiarize yourself with the terms and uses associated with your detector.

**WINDSHIELD MOUNTING**

- Clean the selected windshield area, position the bracket on the windshield. Press firmly on each suction cup to secure the bracket.
- Slide the detector's bracket slot onto the bracket until it snaps into place.

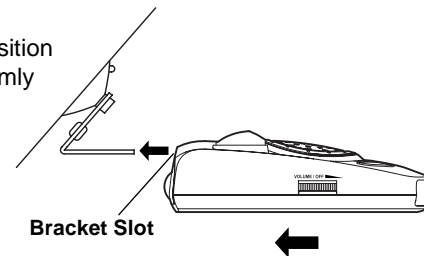

**Adjusting the Bracket**

If the mounted detector is not at the optimum viewing angle, you can adjust the mounting bracket for better viewing. Carefully bend the bracket in or out to adjust it to the desired angle.

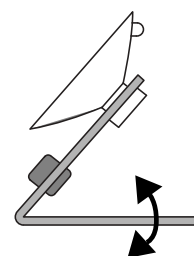

**OPERATION**

**TURNING ON THE DETECTOR**

To turn on the detector, rotate **VOLUME/OFF** toward **VOLUME** until it clicks. You hear a tone and the detector announces "Welcome! Buckle your seat belt," and a test message of "WELCOME!" appears.

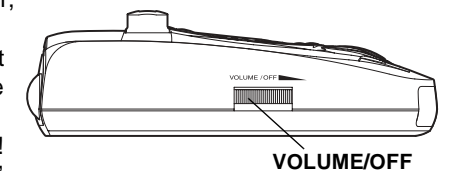

After self-testing, **HWY** appears.

To turn off the detector, rotate **VOLUME/OFF** toward **OFF** until it clicks.

**ADJUSTING THE VOLUME**

Rotate **VOLUME/OFF** toward **VOLUME** to increase the detector's volume. Rotate it toward **OFF** to reduce the volume.

**OPERATION SETTINGS**  
**SELECTING CITY AND HIGHWAY MODES**

Your detector has two operating modes: City and Highway.

- City mode requires a stronger X-band signal before the detector sounds, or visually indicates, an alert.
- Highway mode provides maximum sensitivity for open-road driving. The detector is preset to Highway mode and **HWY** appears when you turn it on.

**Note**

- City mode helps prevent false alerts in tightly populated areas where radar signals can bounce off surrounding structures.
- City mode has no effect on K/Ka-band alerts, laser alerts, or instant-on radar.

- To select City mode, press **City**. **CTY** appears and the detector says "City Mode."
- To return to Highway mode, press **City** again. **HWY** appears and the detector says "Highway Mode."

## OPERATION (continued)

### SELECTING DISPLAY BRIGHTNESS

Your detector has three levels of display brightness: Bright, Dim, and Dark. Once you set the display brightness, the detector retains the setting until you change it.

1. Press **Dim** once to reduce brightness to Dim (50% darker). The detector announces "Display Dim."
2. Press **Dim** again to reduce brightness to Dark (10% darker). The detector announces "Display Dark."
3. Press **Dim** a third time to return to Bright. The detector announces "Display Bright."

### MUTING THE AUDIO ALERT

While the detector sounds an alert signal, press **Mute** to temporarily silence the detector. The detector announces "Mute On" and **m** appears.

The detector automatically turns Mute off 20 seconds after the alert signal stops. To return the detector to normal operation sooner, press **Mute** before the detector resets itself. The detector announces "Mute Off" and **m** disappears.

### AUTO MUTE MODE

Your detector has Auto Mute Mode which automatically reduces the audio volume of all alerts after 4 seconds for as long as the signal is detected. If the same radar signal is encountered within 10 seconds, the detector maintains a reduced audio-volume.

### AUTO MUTE ON/OFF

When the detector is on standby, press **Mute** when no alert is occurring. Auto mute turns off and **A** disappears. If auto mute is set to off, press **Mute** again. The auto mute turns on and **A** appears.

### SELECTING VG-2 MODES

VG-2 mode is preset to on. To turn off VG-2, hold down **Mute** until the voice alert says "VG-2 Off" and **VG2-OFF** appears. To turn VG-2 back on, hold down **Mute** until the voice alert says "VG-2 On" and **VG2-ON** appears.

### RECEIVING AND IDENTIFYING SIGNALS

When your detector senses a radar signal, it responds with different audible and visual alarms to indicate the signal type for X-, K-, and Ka-band (newly included Ka-PoP) signals. The detector indicates the signal strength by increasing the number you see on the display.

#### Note

- If there is another detector in the vicinity, you may receive false signals.
- When the auto mute is on, if the same radar signal is detected within 10 seconds, reduced audio volume is maintained.

### CARE

Keep the radar detector dry; if it gets wet, wipe it dry immediately. Handle the radar detector carefully; do not drop it. Keep the radar detector away from dust and dirt, and wipe it with a damp cloth occasionally to keep it looking new.

- If your detector senses a n X-band, K-band, Ka-band radar signal, it announces "X-Band Detected," "K-Band Detected," or "Ka-Band Detected" respectively.
- If your detector senses a laser signal, "PRO LASER." PRO LASER 3," LTI-2020," or ULTRALYTE LASER" scrolls and the detector announces "Laser Detected."
- If VG-2 is detected, VG-2 flashes and the detector sounds a distinctive tone. The detector announces "VG-2 Detected."
- If your detector senses a SWS signal, a message appears depending on which SWS signal is detected, the detector sounds a distinctive tone, and the detector announces the message.

### TUTORIAL MODE

Your detector has a tutorial mode to demonstrate all of its alphanumeric display.

1. To enter Tutorial mode, turn on the detector while holding down **Dim** and **City**. The detector sounds 3 beeps and **TUTORIAL** and **MODE** flash alternately.
2. To select the demonstration for each alert, press **Dim**. The detector displays each alert with its corresponding audio alert. The detector demonstrates the alerts in the following order.

- X-Band Alert
- K-Band Alert
- Ka-Band Alert
- Pro-Laser Alert
- Pro-Laser3 Alert
- LTI2020 Laser Alert
- Ultralyte Laser Alert
- VG-2 Alert
- Rock Slide Area Ahead
- School Zone Ahead
- Road Narrows Ahead
- Sharp Curve Ahead
- Pedestrian Crossing Ahead

When the demonstration finishes, **TUTORIAL** and **MODE** flash alternately.

3. To exit Tutorial mode, press **City**.

See "Safety Warning System (SWS) Categories and Messages" for a listing of SWS categories and messages.

### SERVICE AND REPAIR

If your radar detector is not performing as it should, take it to your local RadioShack store for assistance. To locate your nearest RadioShack, use the store locator feature on RadioShack's website ([www.radioshack.com](http://www.radioshack.com)), or call 1-800-The Shack (843-7422) and follow the menu options. Modifying or tampering with the radar detector's internal components can cause a malfunction and might invalidate its warranty and void your FCC authorization to operate it.

### REPLACING THE FUSE

If the detector stops operating, follow these steps to check the fuse in the power cord's cigarette lighter plug and, if necessary, replace it with a 2 amp, 1<sup>1</sup>/<sub>4</sub> × 1<sup>1</sup>/<sub>4</sub>-inch, fast-acting fuse (supplied).

1. Carefully turn the knurled ring on the cigarette lighter plug counterclockwise to unscrew it.  
Take care not to lose the ring, tip, or the spring inside the plug when removing the ring.
2. Remove the ring and tip from the cigarette lighter plug, then remove the old fuse.
3. Check the fuse. If it has blown, replace it.
4. Replace the metal tip inside the ring. Make sure the spring is intact. Then place the fuse inside the cigarette lighter plug and screw the ring back onto the plug. Make sure the tip is visible when you reassemble the cigarette lighter plug.

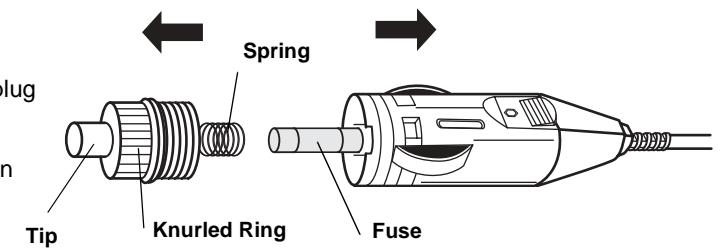

#### CAUTION

- Using a fuse that does not meet the requirements listed above can damage your detector, the power cable, or the vehicle's electrical system.
- If you must use pliers to loosen the ring, be careful not to crush the ring or the metal tip inside the ring.
- Never use pliers or other tools to retighten the ring on the cigarette lighter plug.

### TROUBLESHOOTING

If you have problems operating your detector, the suggestions in this section might help. If you cannot solve the problem after trying these suggestions, take your detector to your local RadioShack store for assistance.

Problem	Suggestion
<i>The detector does not turn on</i>	<p>Be sure all power connections are secure.</p> <p>The cigarette lighter socket might be dirty. Clean it with fine emery cloth to ensure a good, clean connection.</p> <p>Check the fuse in the power cord's cigarette lighter plug. See "Replacing the Fuse".</p> <p>Check the fuse that controls power to your vehicle's cigarette-lighter socket. See your vehicle's owner's manual.</p>
<i>The detector gives a false alert when you use vehicle accessories such as power windows, motorized mirror, brakes, and so on</i>	<p>Check the vehicle's electrical system for a loose connection, including the main battery cable and alternator connections.</p> <p>Install a filter capacitor (1000 <math>\mu</math>F 35 volts) on the back of the cigarette lighter socket, across the power connections.</p>
<i>The detector performs the self-test, but does not respond to radar signals when you see a police car.</i>	<p>A police car might not be equipped with radar (see the supplied booklet, "Questions and Answers About Vehicle Speed Detection").</p> <p>Police might be using VASCAR type speed detection (see the supplied booklet, "Questions and Answers About Vehicle Speed Detection").</p>
<i>The detector has poor laser detection range</i>	<p>Be sure the laser detection lens is not blocked.</p> <p>Be sure the detector is properly mounted.</p> <p>Use lens cleaning solution to clean the laser detection lens.</p>

### THE FCC WANTS YOU TO KNOW

This equipment has been tested and found to comply with the limits for a Class B digital device, pursuant to Part 15 of the *FCC Rules*. These limits are designed to provide reasonable protection against harmful interference in a residential installation. This equipment generates, uses, and can radiate radio frequency energy and, if not installed and used in accordance with the instructions, may cause harmful interference to radio communications.

However, there is no guarantee that interference will not occur in a particular installation. If this equipment does cause harmful interference to radio or television reception, which can be determined by turning the equipment off and on, the user is encouraged to try to correct the interference by one or more of the following measures:

- Reorient or relocate the receiving antenna.
- Increase the separation between the equipment and receiver.
- Connect the equipment into an outlet on a circuit different from that to which the receiver is connected.
- Consult your local RadioShack store or an experienced radio/TV technician for help.
- If you cannot eliminate the interference, the FCC requires that you stop using your radar detector.

Changes or modifications not expressly approved by RadioShack may cause interference and void the user's authority to operate the equipment.

## SAFETY WARNING SYSTEM (SWS) CATEGORIES AND MESSAGES

### SAFETY WARNING SYSTEM

The Safety Warning System (SWS) employs low-powered transmitters used by some emergency services and road crews to alert drivers to hazardous road conditions. The SWS can indicate stationary, moving, or railroad hazards.

The system has the potential to dramatically decrease the occurrence of traffic accidents by increasing drivers' awareness of local road hazards. Having this safety warning compatible radar/laser detector will ensure that you are ready to benefit from this system wherever it is in use.

### CATEGORY 1: HIGHWAY CONSTRUCTION MAINTENANCE

1. WORK ZONE AHEAD
2. ROAD CLOSED AHEAD/FOLLOW DETOUR
3. BRIDGE CLOSED AHEAD/FOLLOW DETOUR
4. HIGHWAY WORK CREW AHEAD
5. UTILITY WORK CREW AHEAD
6. ALL TRAFFIC FOLLOW DETOUR AHEAD
7. ALL TRUCKS FOLLOW DETOUR AHEAD
8. ALL TRAFFIC EXIT AHEAD
9. RIGHT LANE CLOSED AHEAD
10. CENTER LANE CLOSED
11. LEFT LANE CLOSED AHEAD
12. For future use

### CATEGORY 4: WEATHER RELATED HAZARDS

33. HIGH WIND AHEAD
34. SEVERE WEATHER AHEAD
35. HEAVY FOG AHEAD
36. HIGH WATER/FLOODING AHEAD
37. ICE ON BRIDGE AHEAD
38. ICE ON ROAD AHEAD
39. BLOWING DUST AHEAD
40. BLOWING SAND AHEAD
41. BLOWING SNOW WHITE OUT AHEAD
42. For future use

### CATEGORY 2: HIGHWAY HAZARD ZONE ADVISORY I

13. STATIONARY POLICE VEHICLE AHEAD
14. TRAIN APPROACHING/AT CROSSING
15. LOW OVERPASS AHEAD
16. DRAW BRIDGE UP
17. OBSERVE BRIDGE WEIGHT LIMIT
18. ROCK SLIDE AHEAD
19. SCHOOL ZONE AHEAD
20. ROAD NARROWS AHEAD
21. SHARP CURVE AHEAD
22. PEDESTRIAN CROSSING AHEAD

### CATEGORY 5: TRAVEL INFORMATION/CONVENIENCE I

43. REST AREA AHEAD
44. REST AREA WITH SERVICE AHEAD
45. 24 HOUR FUEL SERVICE AHEAD
46. INSPECTION STATION OPEN
47. INSPECTION STATION CLOSED
48. REDUCE SPEED AREA AHEAD
49. SPEED LIMIT ENFORCED
50. HAZARDOUS MATERIALS/EXIT AHEAD
51. CONGESTION AHEAD/EXPECT DELAY
52. EXPECT 10 MINUTE DELAY

### CATEGORY 3: HIGHWAY HAZARD ZONE ADVISORY II

23. DEER/MOOSE CROSSING
24. BLIND/DEAF CHILD AHEAD
25. STEEP GRADE AHEAD/TRUCK USE LOW GEAR
26. ACCIDENT AHEAD
27. POOR ROAD SURFACE AHEAD
28. SCHOOL BUS LOADING/UNLOADING
29. NO PASSING ZONE
30. DANGEROUS INTERSECTION AHEAD
31. STATIONARY EMERGENCY VEHICLE AHEAD
32. For future use

### CATEGORY 6: TRAVEL INFORMATION/CONVENIENCE II

53. EXPECT 20 MINUTE DELAY
  54. EXPECT 30 MINUTE DELAY
  55. EXPECT 1 HOUR DELAY
  56. TRAFFIC ALERT/TURN AM RADIO
  57. PAY TOLL AHEAD
  58. TRUCKS EXIT RIGHT
  59. TRUCKS EXIT LEFT
  60. For future use
- Fast/Slow Moving Vehicles**
61. EMERGENCY VEHICLE IN TRANSIT
  62. POLICE IN PURSUIT
  63. OVERSIZED VEHICLE IN TRANSIT
  64. SLOW MOVING VEHICLE

### ARE RADAR DETECTORS LEGAL?

*Federal law lets you install and use a radar detector in automobiles and light trucks under 10,000 pounds in the United States. Presently, Virginia and the District of Columbia have some laws regulating or prohibiting the use of radar detectors in all vehicles.*

#### Limited One-Year Warranty

This product is warranted by RadioShack against manufacturing defects in material and workmanship under normal use for one (1) year from the date of purchase from RadioShack company-owned stores and authorized RadioShack franchisees and dealers. EXCEPT AS PROVIDED HEREIN, RadioShack MAKES NO EXPRESS WARRANTIES AND ANY IMPLIED WARRANTIES, INCLUDING THOSE OF MERCHANTABILITY AND FITNESS FOR A PARTICULAR PURPOSE, ARE LIMITED IN DURATION TO THE DURATION OF THE WRITTEN LIMITED WARRANTIES CONTAINED HEREIN. EXCEPT AS PROVIDED HEREIN, RadioShack SHALL HAVE NO LIABILITY OR RESPONSIBILITY TO CUSTOMER OR ANY OTHER PERSON OR ENTITY WITH RESPECT TO ANY LIABILITY, LOSS OR DAMAGE CAUSED DIRECTLY OR INDIRECTLY BY USE OR PERFORMANCE OF THE PRODUCT OR ARISING OUT OF ANY BREACH OF THIS WARRANTY, INCLUDING, BUT NOT LIMITED TO, ANY DAMAGES RESULTING FROM INCONVENIENCE, LOSS OF TIME, DATA, PROPERTY, REVENUE, OR PROFIT OR ANY INDIRECT, SPECIAL, INCIDENTAL, OR CONSEQUENTIAL DAMAGES, EVEN IF RadioShack HAS BEEN ADVISED OF THE POSSIBILITY OF SUCH DAMAGES.

Some states do not allow limitations on how long an implied warranty lasts or the exclusion or limitation of incidental or consequential damages, so the above limitations or exclusions may not apply to you.

In the event of a product defect during the warranty period, take the product and the RadioShack sales receipt as proof of purchase date to any RadioShack store. RadioShack will, at its option, unless otherwise provided by law: (a) correct the defect by product repair without charge for parts and labor; (b) replace the product with one of the same or similar design; or (c) refund the purchase price. All replaced parts and products, and products on which a refund is made, become the property of RadioShack. New or reconditioned parts and products may be used in the performance of warranty service. Repaired or replaced parts and products are warranted for the remainder of the original warranty period. You will be charged for repair or replacement of the product made after the expiration of the warranty period.

This warranty does not cover: (a) damage or failure caused by or attributable to acts of God, abuse, accident, misuse, improper or abnormal usage, failure to follow instructions, improper installation or maintenance, alteration, lightning or other incidence of excess voltage or current; (b) any repairs other than those provided by a RadioShack Authorized Service Facility; (c) consumables such as fuses or batteries; (d) cosmetic damage; (e) transportation, shipping or insurance costs; or (f) costs of product removal, installation, set-up service adjustment or reinstallation.

This warranty gives you specific legal rights, and you may also have other rights which vary from state to state.

RadioShack Customer Relations, 200 Taylor Street, 6th Floor, Fort Worth, TX 76102

12/99

## Free Manuals Download Website

<http://myh66.com>

<http://usermanuals.us>

<http://www.somanuals.com>

<http://www.4manuals.cc>

<http://www.manual-lib.com>

<http://www.404manual.com>

<http://www.luxmanual.com>

<http://aubethermostatmanual.com>

Golf course search by state

<http://golfingnear.com>

Email search by domain

<http://emailbydomain.com>

Auto manuals search

<http://auto.somanuals.com>

TV manuals search

<http://tv.somanuals.com>