

OWNER'S MANUAL

PRO-2032

Desk-Top Programmable Scanner

Please read before using this equipment.

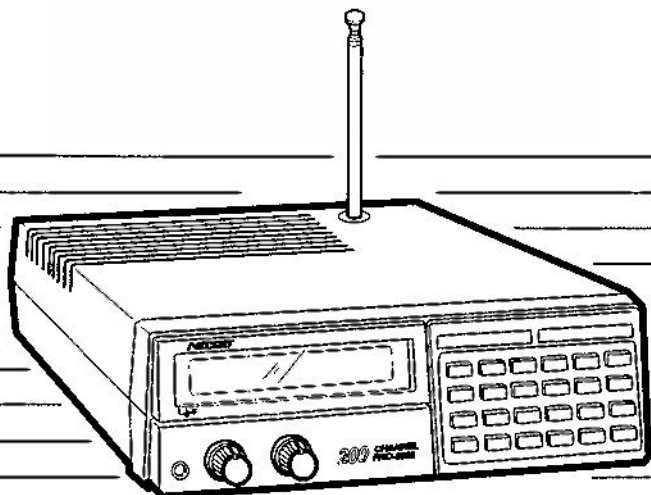

Cat. No. 20-409

Radio Shack®

INTRODUCTION

Your new Radio Shack PRO-2032 Desk Top Programmable Scanner lets you in on all the action! This scanner gives you direct access to over 31,000 frequencies in ten exciting radio bands, including those used by the police department, the fire department, ambulance services, aircraft, amateur radio operators, and transportation services. You can select up to 200 channels for your scanner to scan and you can change your channel selections at any time.

The secret to your scanner's ability to scan so many frequencies is its custom-designed microprocessor—a tiny, built-in computer. Your scanner also has these special features:

Hyperscan – to search through frequencies at up to 50 channels per second or scan stored channels at 25 channels per second.

Liquid Crystal Display – shows the selected channel, frequency, and other information.

2-Second Scan Delay – delays the scanning mode for 2 seconds before moving to another channel, so you can hear more replies.

Memory Backup – keeps the channel frequencies stored in your scanner's memory if a power failure occurs.

Lock-Out Function – keeps channels you select from being scanned.

Ten Channel-Storage Banks – lets you group frequencies so you can easily identify calls.

Priority Channel – helps keep you from missing important calls on a channel you specify.

Direct Search – scans for new and unlisted frequencies to find interesting broadcasts.

Monitor Memories – for temporarily saving up to ten additional channels you locate during a frequency search.

Your PRO-2032 scanner covers all of these bands:

30 – 50 MHz (VHF Lo)

50 – 54 MHz (6-Meter Ham Band)

108 – 136.975 MHz (Aircraft)

137 – 144 MHz (Government)

144 – 148 MHz (2-Meter Ham Band)

148 – 174 MHz (VHF Hi)

380 – 450 MHz (Ham Radio and Government)

450 – 470 MHz (UHF Lo)

470 – 512 MHz (UHF T)

806 – 823.9375 MHz (UHF Hi)

851 – 868.9375 MHz (UHF Hi)

896 – 960 MHz (UHF Hi)

© 1993 Tandy Corporation.
All Rights Reserved.

Radio Shack is a registered trademark used by Tandy Corporation.

	CAUTION RISK OF ELECTRIC SHOCK DO NOT OPEN	
CAUTION: TO REDUCE THE RISK OF ELECTRIC SHOCK, DO NOT REMOVE COVER (OR BACK). NO USER-SERVICEABLE PARTS INSIDE. REFER SERVICING TO QUALIFIED SERVICE PERSONNEL.		



This symbol is intended to alert you to dangerous voltage inside this unit that can cause shock. Do not open enclosure.



This symbol is intended to alert you to important operating and maintenance instructions in this owner's manual.

WARNING: TO PREVENT FIRE OR SHOCK HAZARD, DO NOT EXPOSE THIS RECEIVER TO RAIN OR MOISTURE.

Use of this unit for reception of radio communications not intended for direct reception by the general public may be subject to licensing requirements under the Radio Act of Canada and its regulations. For licensing information consult the Department of Communications.

Caution: To prevent electrical shock, match wide blade of plug to wide slot, fully insert.

Warning: In some areas, mobile use of a scanner is unlawful or requires a permit. Check the laws in your area. Radio Shack assumes no responsibility for the use of this scanner in such areas.

DOC NOTICE

Your scanner might cause radio or TV interference, even when it is operating properly. To determine whether your scanner is causing the interference, turn off your scanner. If the interference goes away, your scanner is causing the interference. Try to eliminate the interference by:

- Moving your scanner away from the receiver.
- Connecting your scanner to an outlet that is on a different electrical circuit from the receiver.
- Contacting your local Radio Shack store for help.

If you cannot eliminate the interference, the DOC requires that you stop using your scanner.

For your records, record your scanner's serial number in the space provided. The serial number is located on the back of the scanner.

Serial Number: _____

CONTENTS

PREPARATION	6
Connecting the Antenna	6
Connecting an Optional Antenna	6
Power Sources	7
Connecting to AC Power	7
Connecting to Vehicle Battery Power	7
Using the Feet	8
Connecting Headphones	8
Listening Safely	8
Traffic Safety	8
Connecting an External Speaker	9
Resetting and Initializing the Scanner	9
UNDERSTANDING YOUR SCANNER	10
A Look at the Display	10
A Look at the Keyboard	11
UNDERSTANDING CHANNEL-STORAGE BANKS	12
Channel-Storage Banks	12
Monitor Memories	12
OPERATION	13
Setting the Volume and Squelch	13
Storing Frequencies	13
Searching for and Temporarily Storing Active Frequencies	14
Limit Search	14
Direct Search	15
Listening to Monitor Memories	16
Moving a Frequency From a Monitor Memory to a Channel	16
Scanning Channels	16
SPECIAL FEATURES	17
Delay	17
Scanning and Search Speeds	17
Locking Out Channels	17
Turning Channel-Storage Banks On and Off	18
Priority	18
Manually Selecting A Channel	18

A GENERAL GUIDE TO SCANNING	19
Birdies	19
Reception Notes	19
Guide to the Action Bands	19
TROUBLESHOOTING	21
CARE AND MAINTENANCE	22
SPECIFICATIONS	23

PREPARATION

CONNECTING THE ANTENNA

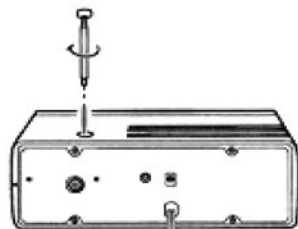

To attach the supplied telescoping antenna, simply screw it into the hole on the top of the scanner.

Antenna length controls the sensitivity of the scanner. The table below shows how to adjust the length of the antenna to specific frequencies.

30 – 174 MHz	Extend Fully
380 – 512 MHz	Extend 2 segments
806 – 960 MHz	Collapse Fully (1 segment only)

CONNECTING AN OPTIONAL ANTENNA

The telescoping antenna is adequate for strong local signals. For best results, attach a multi-band outdoor antenna (not supplied) to the scanner. Your local Radio Shack store sells a complete line of outdoor antennas.

Follow these steps to install an outdoor antenna.

1. Select a location as high as possible.
2. Mount the antenna following the instructions that come with the antenna and its mounting hardware.
3. Plug the antenna cable into the scanner's **ANT** (antenna) jack on the rear of the scanner using 50-ohm coaxial cable (RG-58, RG-8/M or RG-8 not supplied). For lengths over 50 feet, use RG-8/M or RG-8 low-loss, coaxial cable.

Note: This scanner uses a BNC antenna connector. You may need an antenna adapter to use another antenna.

Warning: When installing or removing an outdoor antenna, use extreme caution. If the antenna starts to fall, let it go! It could contact overhead power lines. IF THE ANTENNA TOUCHES THE POWER LINE, CONTACT WITH THE ANTENNA, MAST, CABLE, OR GUY WIRES CAN CAUSE ELECTROCUTION AND DEATH! Call the power company to remove the antenna. Do not attempt to do so yourself.

POWER SOURCES

You can power your scanner from these sources:

- A standard AC outlet
- Your vehicle's battery (using an optional DC adapter)

Connecting to AC Power

Connect the scanner's AC power cord to a standard AC outlet.

Caution: The power cord is equipped with a polarized AC plug (one blade is wider than the other). The plug fits into an outlet in only one way. Do not attempt to defeat this safety feature.

The memory backup circuit begins to function a few minutes after you plug in the scanner. If a power failure occurs or if the power cord is disconnected, this circuit holds information in the scanner's memory for about 3 months.

Connecting to Vehicle Battery Power

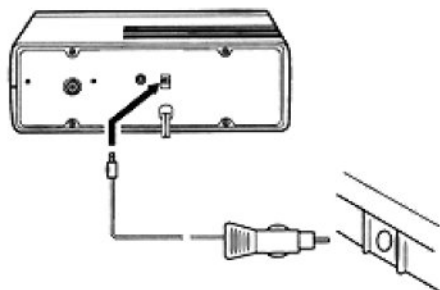

You can power your scanner from your vehicle's cigarette lighter socket by using a DC Adapter (not supplied). The vehicle must have a 12-volt, negative ground electrical system.

Connect the DC power cable's small barrel plug into the DC 13.8V jack on the scanner's back panel. Then plug the other end of the DC power cable into your vehicle's cigarette lighter socket.

Note: Mobile use of scanners might be unlawful or require a special permit in certain areas. Check with your local authorities for current regulations.

USING THE FEET

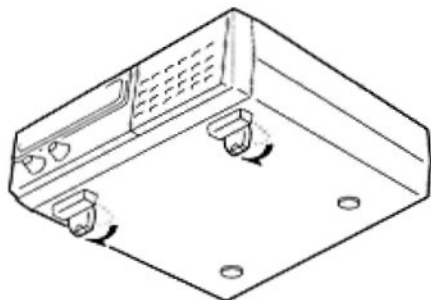

To more easily view the keyboard and display, elevate the front of the scanner by unfolding the front feet.

CONNECTING HEADPHONES

For private listening or in a noisy environment, plug headphones with a 1/8-inch 3.5 mm plug (not supplied) into the jack on the front of your scanner.

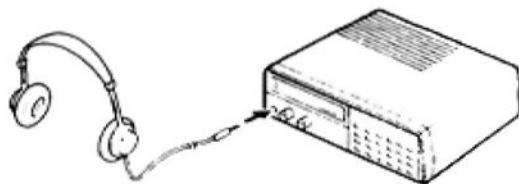

Note: Plugging in headphones automatically disconnects the internal speaker.

Listening Safely

To protect your hearing, follow these guidelines when you use headphones.

- Do not listen at extremely high volume levels. Extended high-volume listening can lead to permanent hearing loss.
- Set the volume to its lowest level before you begin listening. After you put on the headphones, adjust the volume to a comfortable listening level.
- Do not increase the volume once you establish a comfortable listening level. Over time, your ears adapt to the volume level, so a volume level that does not cause discomfort might still damage your hearing.

Traffic Safety

Do not wear earphones while operating a motor vehicle or riding a bicycle. This can cause a traffic hazard and is illegal in some areas. Even though some earphones are designed to let you hear some outside sounds when you listen at normal volume levels, they still present a traffic hazard.

CONNECTING AN EXTERNAL SPEAKER

In a noisy area, an extension speaker positioned in the right place might provide more comfortable listening.

Plug the speaker cable's 1/8-inch (3.5 mm) mini plug into the **EXT SPKR** jack on the back of the scanner. This automatically disconnects the internal speaker.

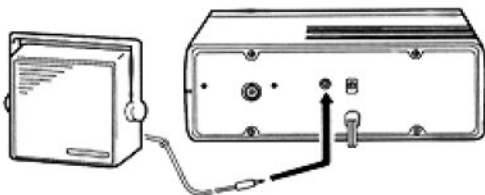

RESETTING AND INITIALIZING THE SCANNER

If the scanner's display locks up or does not work properly after you connect the power source, you might have to reset the scanner's display or initialize the scanner.

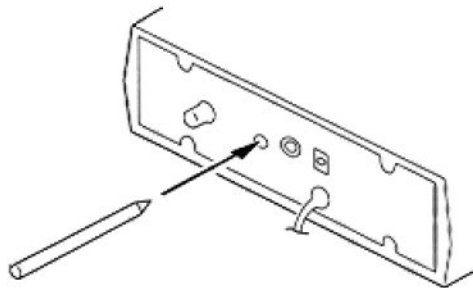

Follow these steps to reset the scanner.

1. Push **VOLUME** to turn on the scanner.
2. Press **RESET** at the rear of the scanner using a pointed object, such as a ball-point pen. If this is not effective, initialize the scanner as directed below.

Follow these steps to initialize the scanner.

Caution: Initialize the scanner only when you are sure the scanner is not working properly. This procedure clears all information in the scanner's memory.

1. Push **VOLUME** to turn on the scanner.
2. Press and hold **CLEAR**. Press **RESET** at the rear of the scanner using a pointed object such as a ball-point pen. Release **RESET** and then release **CLEAR** after the display reappears.

Note: You must release **RESET** before releasing **CLEAR** in order to clear the memory.

UNDERSTANDING YOUR SCANNER

A LOOK AT THE DISPLAY

The display has several indicators that show the scanner's current operating mode. A quick look at the display will help you understand how to operate your scanner.

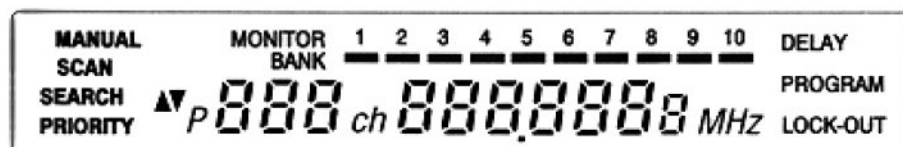

MANUAL – comes on when the scanner is in the manual channel-selection mode.

MONITOR – appears when you listen to a monitor memory.

Numbers 1–10 – represent the ten memory banks and the ten monitor memories.

DELAY – appears when the scanner is set to a channel programmed with the delay feature. See “Delay”.

BANK – appears with bars to the right to show which channel-storage banks are turned on for the scan mode. See “Understanding Channel-Storage Banks.”

SCAN – appears when you scan channels.

SEARCH – appears during a limit search (when **-L-** also appears) or a direct frequency search (when **-d-** also appears).

PROGRAM – appears while you program frequencies into the scanner's channels.

PRIORITY – appears when you turn on the priority channel feature.

P – appears when you listen to the priority channel.

ch – digits that precede this indicator show which of the 200 channels the scanner is tuned to.

MHz – digits that precede this indicator show which of the 31,000 possible frequencies the scanner is tuned to.

LOCK-OUT – appears when you manually select a locked-out channel.

A LOOK AT THE KEYBOARD

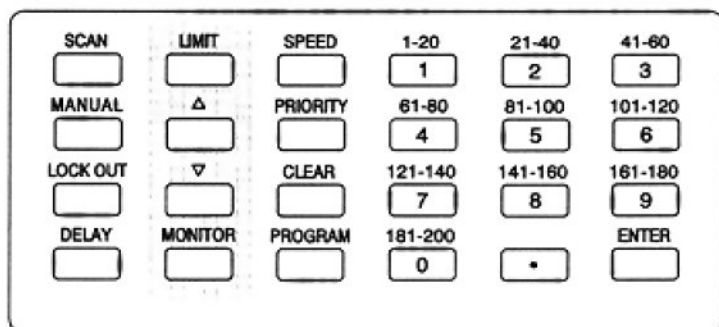

Your scanner's keys might seem confusing at first, but a quick glance at this page should help you understand each key's function.

SCAN – scans through the programmed channels.

MANUAL – stops scanning and lets you directly enter a channel number.

LOCK OUT – lets you lock out a selected channel.

DELAY – programs a two second delay for the selected channel.

LIMIT – used during frequency searches. See "Searching For and Temporarily Storing Active Frequencies."

▲ – searches up from the currently displayed frequency.

▼ – searches down from the currently displayed frequency.

MONITOR – accesses the 10 monitor memories. See "Moving a Frequency from a Monitor Memory to a Channel."

SPEED – changes the scanning or search speed from low to high or high to low.

PRIORITY – sets and turns on and off priority for a particular channel.

CLEAR – clears an incorrect entry.

PROGRAM – programs frequencies into channels.

Number Keys – each key has a single-digit label and a range of numbers. The single digit is the number entered when you enter a channel number or a frequency. The range of numbers (21-40, for example) indicates the channels that make up a channel storage bank. See "Understanding Channel-Storage Banks."

ENTER – enters program frequencies into channels.

UNDERSTANDING CHANNEL-STORAGE BANKS

You can store up to 210 frequencies into your scanner's memory. You store each frequency into either a permanent memory, called a channel, or a temporary memory, called a monitor memory. There are 200 channel memories and 10 monitor memories.

CHANNEL-STORAGE BANKS

To make it easier to identify and select the channels you want to listen to, channels are divided into 10 channel-storage banks of 20 channels each. Use each channel-storage bank to group frequencies, such as the fire department, ambulance services, or aircraft (see "A Guide to the Action Bands").

For example, the fire department might use four frequencies, one for each side of town. You could program the fire frequencies starting with Channel 1 (Bank 1) and program the ambulance services starting with Channel 21 (Bank 2). When you want to listen to only fire calls, you can turn off the other banks.

MONITOR MEMORIES

The scanner also has 10 monitor memories. You can use these memories to temporarily store frequencies while you decide whether or not to save them in channels. This is handy for quickly storing an active frequency when you search through an entire band. You can manually select these memories, but you cannot scan them. See "Searching for and Temporarily Storing Active Frequencies."

When you are in the monitor mode, the 10 numbers at the top of the display indicate the 10 monitor memories. **MONITOR** appears on the display when you are using monitor memories and the bar indicates the currently active monitor memory.

OPERATION

SETTING THE VOLUME AND SQUELCH

1. Push **VOLUME** to turn on the scanner.
 2. Turn **VOLUME** to about 2 and **SQUELCH** to 10.
 3. Slowly turn **SQUELCH** counter-clockwise until you hear a hissing sound.
 4. Adjust **VOLUME** to a comfortable sound level.
 5. Slowly rotate **SQUELCH** clockwise until the hissing stops.
- Note:** If the scanner picks up unwanted, partial, or very weak transmissions, rotate **SQUELCH** clockwise to decrease the scanner's sensitivity to these signals.

STORING FREQUENCIES

Follow these steps to store frequencies into channels.

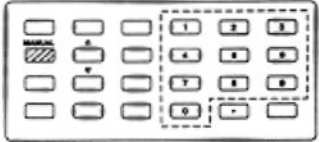
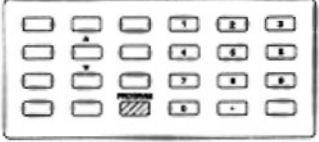
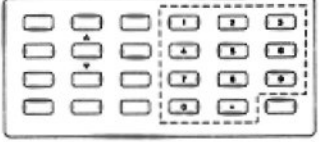
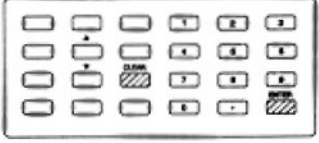
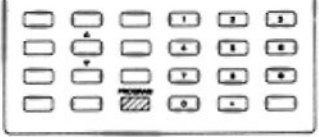
1. Press MANUAL . Enter the channel number you want to program.	
2. Press PROGRAM . PROGRAM appears on the display.	
3. Enter a frequency.	
4. Press ENTER to store the frequency. If you made a mistake in Step 3, Error appears on the display. Press CLEAR and repeat Step 3.	
5. Repeat Steps 1-4 to program more channels. If you want to program the next channel in sequence, repeat Steps 2-4.	



SEARCHING FOR AND TEMPORARILY STORING ACTIVE FREQUENCIES

If you do not have a reference to frequencies in your area, use these procedures to search for a transmission. See also "Guide to the Action Bands" in this manual.

Note: Press **DELAY** to make the scanner pause 2 seconds after a transmission ends before proceeding to the next frequency.

Limit Search

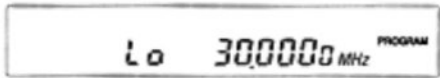
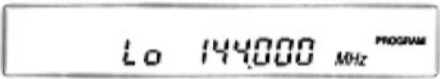
Limit search lets you search within a range of frequencies you select. **-L-** appears on the display during a limit search.

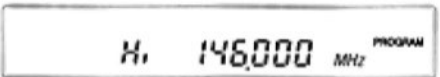
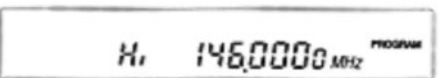

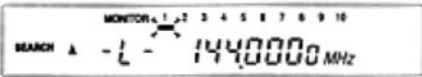
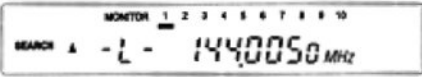
1.	Press PROGRAM , then LIMIT . L_o will appear on the display.	
2.	Enter the lower limit of the frequency range.	
3.	Press ENTER , then LIMIT . H_i will appear on the display.	
4.	Enter the upper limit of the frequency range.	
5.	Press ENTER .	

6. Press ▲ to search up from the lower limit, or press ▼ to search down from the upper limit.	
7. When the scanner stops on a transmission, press MONITOR to store the frequency in the current monitor memory, or press ▼ or ▲ to continue the search.	

Note: As you store frequencies in monitor memories, the bar under the memory number indicates the current monitor memory.

Direct Search

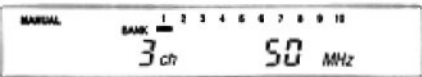
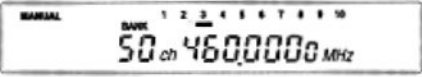
When you are listening to a channel, you can search up or down from the current displayed frequency. **-d-** appears on the display during a direct search.

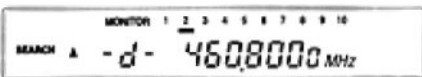
1. To select a channel into which you have programmed a frequency, press MANUAL and the channel number.	
2. Press MANUAL or PROGRAM to enter the channel number.	
3. Press ▲ to search up from the channel's frequency or press ▼ to search down.	
4. When the scanner stops on a transmission, press MONITOR to store that frequency into the current monitor memory.	

LISTENING TO MONITOR MEMORIES

To listen to a monitor memory, press **MANUAL**, **MONITOR**, and then the number of the monitor memory you want to listen to.

MOVING A FREQUENCY FROM A MONITOR MEMORY TO A CHANNEL

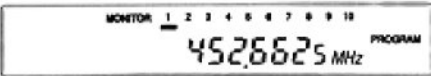
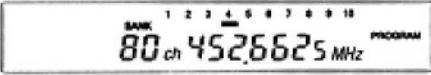
1. Press MANUAL . Enter the channel number you want to store the frequency in; then press PROGRAM .	 The display shows 'BANK' at the top with numbers 1-10 above it. Below that, '80 ch 0000000 MHz' is displayed. 'PROGRAM' is on the right.
2. Press MONITOR and the number of the monitor memory that has the frequency you want to store.	 The display shows 'MONITOR' at the top with numbers 1-10 above it. Below that, '4526625 MHz' is displayed. 'PROGRAM' is on the right.
3. Press ENTER . The scanner stores the frequency into the channel.	 The display shows 'BANK' at the top with numbers 1-10 above it. Below that, '80 ch 4526625 MHz' is displayed. 'PROGRAM' is on the right.

If you want to return to a limit search after this procedure, press **LIMIT** and either ▼ or ▲ to continue.

SCANNING CHANNELS

To begin scanning, press **SCAN**. The scanner scans through all non-locked channels in the activated banks. Set **SQUELCH** so you do not hear the hissing sound between transmissions.

SPECIAL FEATURES

DELAY

Many agencies use a two-way radio system that might have a pause of several seconds between a query and a reply. To program a delay into that channel to keep from missing a reply, select the channel and press **DELAY** so **DELAY** appears on the display. The scanner pauses for two seconds on a channel programmed with a delay.

When your scanner pauses at an active channel which has been programmed with a delay, it waits for two seconds after the completion of each transmission on that channel before it resumes scanning.

SCANNING AND SEARCH SPEEDS

Your PRO-2032 has 2 different scanning speeds:

- 8 channels per second
- 25 channels per second (Hyperscan)

It also has 2 different search speeds:

- 8 steps per second
- 50 steps per second (Hyperscan)

While you are in the scan mode, press **SPEED** to select the scanning speed. While you are in the search mode, press **SPEED** to select the search speed.

Whenever the unit is turned on, the speed is automatically set to high.

LOCKING OUT CHANNELS

You can increase the effective scanning speed by locking out specific channels that you have not yet programmed. To do so, manually select the empty channel and press **LOCK OUT** so **LOCK-OUT** appears on the display. This is also handy for locking out channels you have programmed that have a continuous transmission. You can still manually select locked-out channels.

To unlock a channel, manually select the channel and press **LOCK OUT** so **LOCK-OUT** disappears from the display.

Note: There must be at least one active channel in each bank. You cannot lock out all channels.

TURNING CHANNEL-STORAGE BANKS ON AND OFF

You can turn each channel-storage bank on and off. When you turn off a bank, the scanner does not scan any of the 20 channels in the bank.

While scanning, press the number key corresponding to the bank you want to turn on or off. If the memory bank indicator is on, the bank is turned on and the scanner scans all channels within that bank that are not locked out. If the indicator is off, the scanner does not scan any of the channels within that bank.

You can manually select any channel in a bank, even if the bank is turned off. You cannot turn off all banks. One bank is always active.

PRIORITY

You can scan through the programmed channels and still not miss an important or interesting call on a specific channel. To program a stored channel as the priority channel, press **PROGRAM**, the desired channel number, and then **PRIORITY**. You can only select one channel as the priority channel.

To turn on the priority feature, press **PRIORITY** during scanning. **PRIORITY** appears on the display. The scanner now checks the priority channel every two seconds, and stays on the channel if there is activity. **P** appears to the left of the display whenever the scanner is set to the priority channel.

To turn off the priority feature, press **PRIORITY** until **PRIORITY** disappears from the display.

MANUALLY SELECTING A CHANNEL

You can continuously monitor a specific channel without scanning. This is useful if you hear an emergency broadcast on a channel and do not want to miss any details — even though there might be periods of silence — or if you want to monitor only a locked-out channel.

To select a channel, just press **MANUAL**. Enter the channel number, and press **MANUAL** again. Or, if the scanner is scanning and stops at the desired channel, just press **MANUAL** one time. Pressing **MANUAL** additional times makes the scanner step through the channels.

A GENERAL GUIDE TO SCANNING

BIRDIES

Birdies are frequencies your scanner uses when it operates. These operating frequencies might interfere with broadcasts on the same frequencies. If you program one of these frequencies, the scanner locks up and you hear only noise on that frequency.

If the interference is not severe, you might be able to turn **SQUELCH** clockwise to cut out the interference. The most common birdies to watch for are listed below.

Birdies Frequencies:

Low Band (MHz)	Air Band (MHz)	High Band (MHz)	UHF Low/T (MHz)
30.735	108.800	138.945	409.800
31.255	112.725	140.800	415.400
32.000	115.200	143.430	419.975
32.265	117.800	143.725	424.000
33.275	121.600	144.935	430.925
35.290	121.825	145.195	436.2125
36.295	128.000	146.195	443.0375
37.305	134.400	147.200	447.0625
38.400		148.960	452.350
40.980		150.230	463.425
41.460		152.990	476.5125
44.365		153.255	480.3625
44.800		153.600	492.050
51.200		154.260	512.000
		155.270	
		156.280	
		160.000	
		161.325	
		163.920	
		165.840	
		166.400	
		169.095	
		172.800	

RECEPTION NOTES

Reception on the frequencies covered on your scanner is mainly line-of-sight. That means you usually won't be able to hear stations that are located beyond the horizon.

During summer months, you might be able to hear stations in the 30–50 MHz range located several hundreds or even thousands of miles away. This is due to summer atmospheric conditions. This type of reception is unpredictable, but often very interesting.

GUIDE TO THE ACTION BANDS

With a little investigation, you can find active frequencies in your community to monitor exciting events. We can give you some general pointers, and you can take it from there. Please use caution and common sense when you hear an emergency call. Never go to the scene of an emergency. It could be very dangerous.

Find out if there is a local club that monitors your community's frequencies. Perhaps a local electronics repair shop that works on equipment similar to your scanner can give you channel frequencies used by local radio services.

As a general rule on VHF, most activity is concentrated between 153.785 and 155.98 MHz and then again from 158.73 to 159.46 MHz. Here you find local government, police, fire, and most emergency services. If you are near a railroad or major railroad tracks, look around 160.0 to 161.9 for signals.

One very useful service is the Environment Canada Weather Radio's continuous weather broadcasts. These broadcasts contain weather forecasts and data for the area around the station, plus bulletins on any threatening weather conditions. These stations use three frequencies—162.40, 162.475, and 162.55 MHz. In most areas of the country, you can receive one or more of these frequencies.

You can hear commercial aircraft transmissions between 118 and 136.975 MHz. Military aircraft operate between 225 and 400 MHz.

In some large cities, the UHF bands are used for emergency services. Here, most of the activity is between 453.025 and 453.95 MHz and between 456.025 and 467.925 MHz.

In the UHF band, frequencies between 456.025 and 459.95 MHz and between 465.025 and 469.975 MHz are used for mobile units and control stations associated with base and repeater units that operate 5 MHz lower (that is, between 451.025 and 454.95 MHz and between 460.025 and 464.975 MHz). This means if you find

an active frequency inside one of these spreads, you can look 5 MHz lower (or higher) to find the base station/repeater for that service.

A newer technology is now available that uses the 800 MHz band for many services. Trunked radio, introduced to business systems in 1975, is now used by public safety agencies. With up to twenty channels available, the transmitter automatically selects an unused frequency each time it is activated. Several agencies can share such a system without interfering with each other. This system can provide secure communications for selected units, with unselected units unable to hear the message.

Frequencies in different bands are accessible only at specific intervals. In the VHF-Lo, HAM, Government, and VHF-Hi bands, frequencies are available in 5 kHz steps. In the aircraft band, frequencies are available in 25 kHz steps. In all other bands, frequencies are available in 12.5 kHz steps. Your scanner rounds the entered frequency down to the nearest valid frequency. For example, if you try to enter 151.473, the scanner accepts this as 151.470 MHz.

TROUBLESHOOTING

We hope you don't have any problems with your scanner, but if you do, the following suggestions might help.

Problem	Cause and Solution
Scanner does not function.	Check to see that the scanner is plugged into a working AC outlet or DC power source.
Scanner is on but will not scan.	SQUELCH control is not correctly adjusted. Adjust SQUELCH clockwise.
No or poor reception.	<ul style="list-style-type: none">• Antenna is not correctly installed.• The area is not suitable for the scanner—relocate the scanner and try again.• Frequencies are not properly programmed—check and reprogram.
In the scanning mode, the scanner locks on frequencies that have an unclear transmission.	Avoid programming frequencies "Birdies" listed on Page 19, or only listen to them manually.
The keys are inoperative or the LCD display is random.	The CPU is locked up. Reset the scanner. See "Resetting and Initializing the Scanner."

If none of the above suggestions help, take your scanner to your local Radio Shack store for assistance.

CARE AND MAINTENANCE

Your PRO-2032 Programmable Scanner is an example of superior design and craftsmanship. The following suggestions will help you care for your scanner so you can enjoy it for years.



Keep the scanner dry. If it gets wet, wipe it dry immediately. Liquids can contain minerals that can corrode the electronic circuits.



Handle the scanner gently and carefully. Dropping it can damage circuit boards and cases and can cause the scanner to work improperly.



Use and store the scanner only in normal temperature environments. Temperature extremes can shorten the life of electronic devices, and distort or melt plastic parts.



Keep the scanner away from dust and dirt, which can cause premature wear of parts.



Wipe the scanner with a damp cloth occasionally to keep it looking new. Do not use harsh chemicals, cleaning solvents, or strong detergents to clean the scanner.

Modifying or tampering with your scanner's internal components can invalidate the scanner's warranty and might void your DOC authorization to operate it. If your scanner is not operating as it should, take it to your local Radio Shack store for assistance.

SPECIFICATIONS

Frequency Coverage:

VHF-Lo	30–50 MHz (in 5 kHz steps)
Ham	50–54 MHz (in 5 kHz steps)
VHF Aircraft	108–136.975 MHz (in 25 kHz steps)
Government	137–144 MHz (in 5 kHz steps)
Ham	144–148 MHz (in 5 kHz steps)
VHF-Hi	148–174 MHz (in 5 kHz steps)
Ham/Government	380–450 MHz (in 12.5 kHz steps)
UHF-Lo	450–470 MHz (in 12.5 kHz steps)
UHF-TV	470–512 MHz (in 12.5 kHz steps)
UHF-Hi	806–823.9375 MHz (in 12.5 kHz steps)
	851–868.9375 MHz (in 12.5 kHz steps)
	896–960 MHz (in 12.5 kHz steps)

Channels of Operation Any 200 Channels in Any Band Combinations.
(20 channels per bank, 10 banks) and 10 monitor channels.

Sensitivity: (20 dB(S+N)/N with 60% modulation at 1 kHz)

30–54 MHz	1 μ V
108–136.975 MHz	2 μ V
137–174 MHz	1 μ V
380–512 MHz	1 μ V
806–960 MHz	2 μ V

Spurious Response Rejection: (except primary image)

30–54 MHz	50 dB at 40 MHz
108–136.975 MHz	50 dB at 124 MHz
137–174 MHz	50 dB at 154 MHz
380–512 MHz	Not specified
806–960 MHz	Not specified

Selectivity:

± 10 kHz	-6 dB
± 20 kHz	-50 dB

IF Interference Ratio:

10.7 MHz	70 dB at 154 MHz
----------------	------------------

Squelch Sensitivity:	
Threshold	1.0 μ V
Tight (VHF Lo, Hi, UHF)	(S+N)/N 25 dB
Tight (Aircraft)	(S+N)/N 20 dB
Scanning Rate:	
Fast	25 channels/second
Slow	8 channels/second
Search Rate:	
Fast	50 steps/second
Slow	8 steps/second
Priority Sampling	2 seconds
Delay Time	2 seconds
IF Frequencies:	
1st	10.7 MHz
2nd	455 kHz
Antenna Impedance	50 ohms
Audio Power	1.2 watts nominal
Power Requirement	AC 120 volts, 60 Hz, 15 watts or DC 13.8 volts, 8 watts
Dimension	2 7/8" x 8 5/8" x 8 1/4" HWD (75 mm x 220 mm x 210 mm)
Weight	3 lbs. 10 oz. (1.65 kg) without antenna

Features and specifications are of typical units and subject to change for improvement without notice.

INTERTAN WARRANTY

INTERTAN warrants that this product will be free from defects for a period of **one (1) year** from the date of its purchase from any of INTERTAN's company owned stores and authorized dealers. Within this period, the product will be repaired without charge for parts and labour. There may be a slight charge for transportation. **Simply bring in your proof of purchase** to any of INTERTAN's stores or dealers. Any product which has been subjected to misuse or accidental damage is excluded from this warranty.

Except as stated above, INTERTAN makes no promises or warranties either expressed or implied including warranties of merchantability or that the product is fit for any particular purpose.

This warranty is only applicable to products purchased through INTERTAN's company owned stores and dealers that operate in the country where the products are offered for sale. The warranty gives you specific legal rights and you may have other rights which will vary under the laws of the various countries, states, provinces, etc., in which INTERTAN operates.

WE SERVICE WHAT WE SELL!

GARANTIE INTERTAN

Cet appareil est garanti par INTERTAN contre toute défectuosité pendant **un (1) an** à compter de sa date d'achat dans n'importe quel magasin de la société, auprès d'un franchisé ou d'un distributeur agréé. Durant cette période, nous prenons en charge toutes les réparations y compris les frais de pièces et de main d'oeuvre. **Ramenez simplement votre appareil, accompagné du reçu d'achat, dans le magasin de votre choix.** Cette garantie ne couvre pas les frais de transport éventuels, ni le matériel qui aurait été mal utilisé ou qui aurait subi des dégâts tortueux.

À l'exception de ce qui précède, INTERTAN ne fait de promesse ni ne donne de garantie ni explicitement, ni implicitement, en ce y compris les garanties marchandes ou le fait que l'appareil convienne pour n'importe quelle application particulière.

Cette garantie ne s'applique qu'aux seuls produits achetés dans les magasins d'Inter-TAN, auprès des franchisés et distributeurs agréés en activité dans le pays où ces produits sont vendus. Elle vous confère certains droits légaux spécifiques et d'autres encore qui varient selon la législation en vigueur dans les différents pays, états, départements, provinces... dans lesquels INTERTAN est représenté.

NOUS ASSURONS LE SERVICE DE NOS PRODUITS!

INTERTAN GARANTIE

De INTERTAN garantie op dit artikel geldt voor alle defecten gedurende **een (1) jaar** vanaf de datum van ophaling van het artikel in een winkel van de maatschappij, in een franchise-winkel of bij een erkende dealer. Tijdens deze periode voeren wij alle herstellingen uit zonder de eigenaar onderdelen of werkuren aan te rekenen. **Breng het artikel samen met de kasabon eenvoudig** naar de winkel van uw keuze. De garantie geldt niet voor eventuele transportkosten, noch voor artikelen die verkeerd werden gebruikt of beschadigd door eigen schuld.

Behoudens het voorgaande, gaat INTERTAN geen beloften of garantiebepalingen aan, noch uitdrukkelijk noch stilzwijgend, met inbegrip van garantiebepalingen inzake verkoopbaarheid of het feit dat een artikel al dan niet geschikt is voor een welbepaalde toepassing.

Deze garantie is enkel geldig voor artikelen aangeschaft in de winkels van INTERTAN, bij de franchisenemers of erkende dealers, die werkzaam zijn in het land waar deze producten worden verkocht. De garantie verleent U welbepaalde wettelijke en andere rechten, die kunnen variëren naargelang van de wetgeving van kracht in de verschillende landen, staten, departementen, provincies... waar INTERTAN vertegenwoordigd is.

EEN ZEKERE SERVICEVERLENING NA DE VERKOOP!

CUSTOM MANUFACTURED FOR TANDY/INTERTAN FABRIQUÉ POUR TANDY/INTERTAN

AUSTRALIA

INTERTAN AUSTRALIA LIMITED (INC. IN N.S.W.)
91 KURRAJONG AVE., MT. DRUITT, 2770

BELGIUM

RUE DES PIEDS D'ALOUETTE 39, 5140 NANINNE

FRANCE

BP 147-95022 CERGY PONTOISE CEDEX

U.K.

BILSTON ROAD WEDNESBURY, WEST MIDLANDS WS10 7JN

Free Manuals Download Website

<http://myh66.com>

<http://usermanuals.us>

<http://www.somanuals.com>

<http://www.4manuals.cc>

<http://www.manual-lib.com>

<http://www.404manual.com>

<http://www.luxmanual.com>

<http://aubethermostatmanual.com>

Golf course search by state

<http://golfingnear.com>

Email search by domain

<http://emailbydomain.com>

Auto manuals search

<http://auto.somanuals.com>

TV manuals search

<http://tv.somanuals.com>