

OWNER'S MANUAL

Audio/Video System

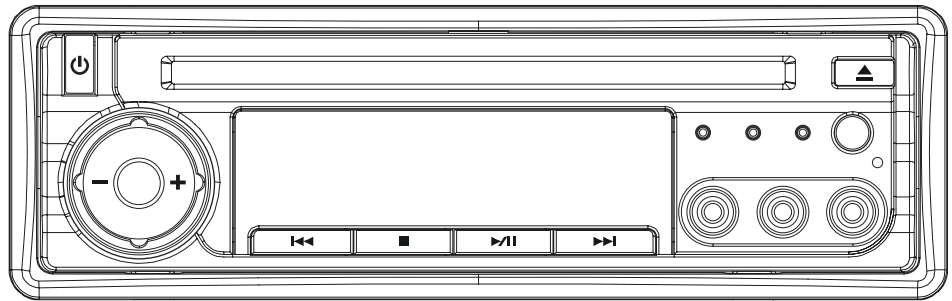
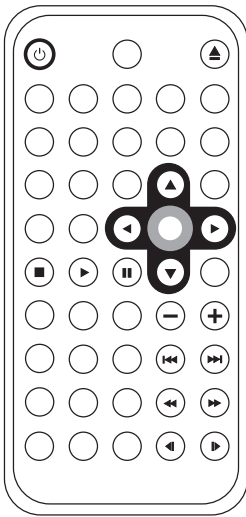

- Slot load DVD player
- ISO Din Mounting or portable
- Audio CD/CD-R/CD-RW/MP3 compatible
- DVD/CD resume function
- TV mode (16:9/4:3 PAN & SCAN or 4:3 Letter Box)
- Default regional code
- On-screen user friendly setup menu
- Parental lock with security lock
- Full function remote control
- Included cigarette lighter plug
- Audio/Video out x 2
- Front AV In x 1
- Rear Audio/Video IN x 1
- Digital / S-Video Out
- DC In & DC out
- Remote repeater for monitor to control DVD unit

FEATURES

Compatible with PAL DVD (Video CD) and NTSC DVD (Video CD)

This player can play discs recorded in either PAL or NTSC format.

- A single LSI chip now integrates all major DVD playback circuit functions including MPEG2 decoder, video D/A converter, and audio decoders.
- L/R stereo analog audio outputs for connection to existing head unit aux inputs. Video output is composite video.
- Supplied remote handles multi-function software (multi-language audio-track/subtitle, multi-angle, multi-story, etc.), plus all basic functions.

USE THIS PRODUCT SAFELY

Use the Proper Power Supply

This product is designed to operate with a 12 volt DC, negative ground battery system.

Protect the Disc Mechanism

Avoid inserting any foreign objects into the disc driver of this player. Failure to observe this may cause malfunction due to the precise mechanism of this unit.

Use Authorized Service Centres

Do not attempt to disassemble or adjust this precision product. Please refer to the Service Centre list included with this product for service assistance.

CONTENTS

Safety Information	4
Disc Notes	5
The Player	6
Front View.....	6
Back View	7
Remote Control	8
Location and Function of Keys.....	8
Preparing the Remote Control.....	10
General Operation	11
Turn the unit On/Off	11
Basic Play	11
Mode Selection.....	11
Last Play Memory	11
Menu function.....	12
Advanced Operation	13
Repeat Play/Paragraph Repeat Play	13
PBC Menu Playback of VCD/SVCD	13
On-screen Display Function	13
Goto Function.....	14
Zoom Function	14
Special Function for DVD	14
Special Function for VCD and CD	16
Data Disc Play Operation	16
Setup	17
System Setup	17
Language Setup	17
Audio Setup	17
TV Operation	18
Trouble Shooting	19
Specifications	20

SAFETY INFORMATION

CAUTION:

MOBILE DVD PLAYER IS A CLASS I LASER PRODUCT. HOWEVER THIS MOBILE DVD PLAYER USES A VISIBLE/INVISIBLE LASER BEAM WHICH COULD CAUSE HAZARDOUS RADIATION EXPOSURE IF DIRECTED. BE SURE TO OPERATE THE MOBILE DVD PLAYER CORRECTLY AS INSTRUCTED.

USE OF CONTROLS OR ADJUSTMENTS OR PERFORMANCE OF PROCEDURES OTHER THAN THOSE SPECIFIED HEREIN MAY RESULT IN HAZARDOUS RADIATION EXPOSURE. DO NOT OPEN COVERS AND - DO NOT REPAIR YOURSELF. REFER SERVICING TO QUALIFIED PERSONNEL.

WARNING:

- TO REDUCE THE RISK OF FIRE OR ELECTRIC SHOCK, DO NOT EXPOSE THIS EQUIPMENT TO RAIN OR MOISTURE.
- TO REDUCE THE RISK OF FIRE OR ELECTRIC SHOCK, AND ANNOYING INTERFERENCE, USE ONLY THE RECOMMENDED ACCESSORIES.
- THIS DEVICE IS INTENDED FOR CONTINUOUS OPERATION.

This product incorporates copyright protection technology that is protected by method claims of certain U.S. patents and other intellectual property rights owned by Macrovision Corporation and other rights owners. Use of this copyright protection technology must be authorized by Macrovision Corporation, and is intended for home and other limited viewing uses only unless otherwise authorized by Macrovision Corporation. Reverse engineering or disassembly is prohibited.

Region Management Information

Region Management Information:

This Mobile DVD Player is designed and manufactured to respond to the Region Management Information that is recorded on a DVD disc. If the Region number described on the DVD disc does not correspond to the Region number of this Mobile DVD Player, this Mobile DVD Player cannot play this disc.

DISC NOTES

Disc formats supported by this player



DVD
12 cm disc



Video CD
12 cm disc



CD
12 cm disc



MP3
12 cm disc

Handling and Cleaning

- Dirt, dust, scratches and warping disc will cause misoperation.
- Do not place stickers or make scratches on discs.
- Do not warp discs.
- A disc should always be kept in its case when not in use to prevent from damage.
- Do not place discs in the following places:
 1. Direct sunlight
 2. Dirty, dusty and damp areas
 3. Near car heaters
 4. On the seats or dashboard

Disc Cleaning

Use a dry soft cloth to wipe the surface. If the disc is quite dirty, use a soft cloth slightly moistured with isopropyl (rubbing) alcohol. Never use solvents such as benzine, thinner or conventional record cleaners as they may mar the surface of the disc.

Note:

A disc may become somewhat scratched (although not enough to make it unusable) depending on your handle it and conditions in the usage environment.

Note these scratches are not an indication of any problem with the player.

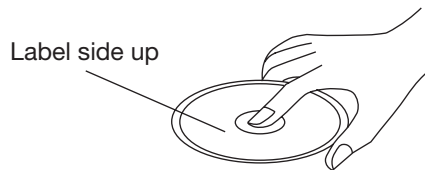

Do not touch the underside of the disc

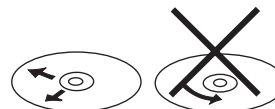

Wipe the disc from center toward the outside edge

Preparing New Discs with Rough Spots

A new disc may have rough edges on its inside and outside edges. If a disc with rough edges is used, the proper setting will not be performed and the player will not play the disc. Therefore, remove the rough edges in advance by using a ball point pen or pencil as shown on the right. To remove the rough edges, press the side of the pen or pencil against the inside and outside edges of the disc.

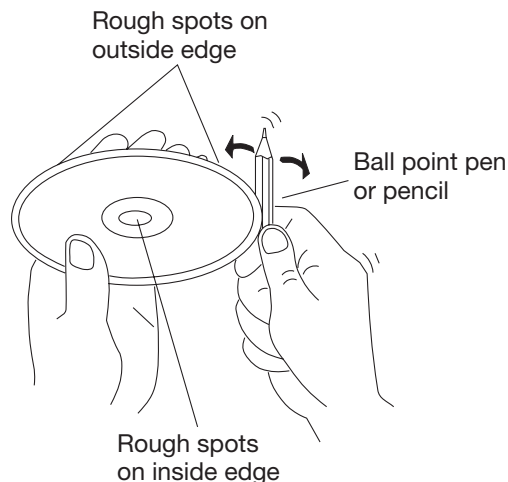

THE PLAYER

FRONT VIEW

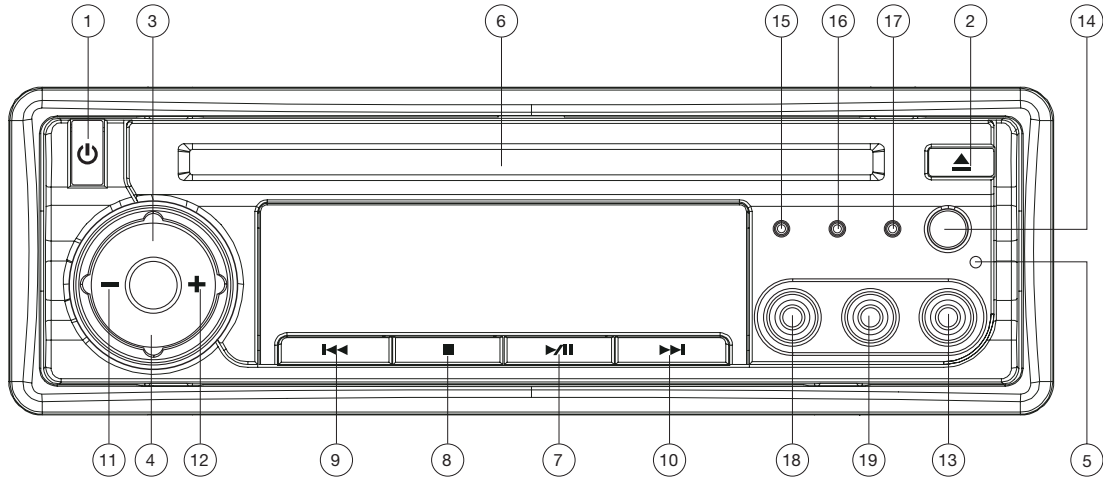

- | | |
|---------------------|-----------------------------|
| 1. ⏻ (POWER) | 11. VOL- |
| 2. ▲ (Eject Button) | 12. VOL+ |
| 3. MODE | 13. AUDIO IN R |
| 4. TV SCAN/MENU | 14. IR |
| 5. Reset Button | 15. Indicator Light for DVD |
| 6. Disc Slot | 16. Indicator Light for TV |
| 7. ▶ (PLAY/PAUSE) | 17. Indicator Light for AV |
| 8. ■(Stop) | 18. VIDEO IN |
| 9. PREV (◀◀)/CH- | 19. AUDIO IN L |
| 10. NEXT (▶▶)/CH+ | |

THE PLAYER

BACK VIEW

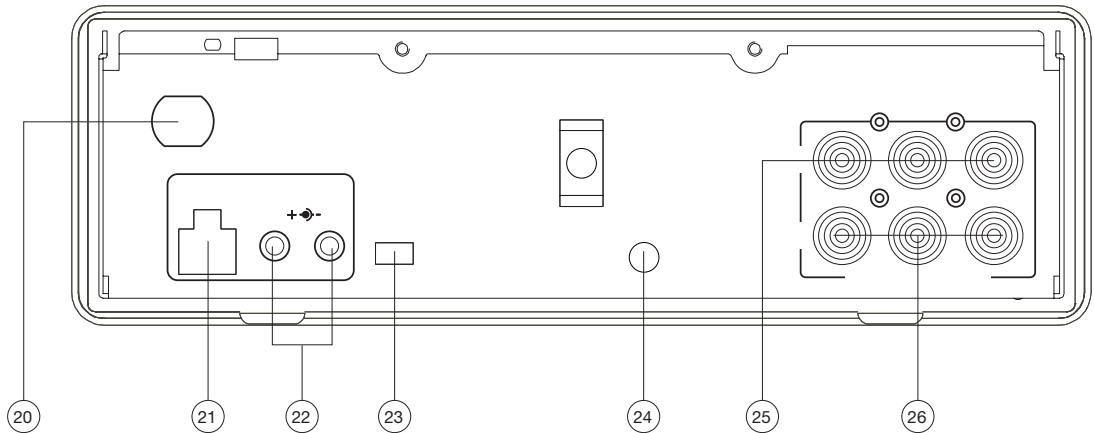

- 20. ANT IN
- 21. DC 12V INPUT Socket
- 22. DC 12V OUTPUT Socket
- 23. AV OUTPUT TYPE Switch







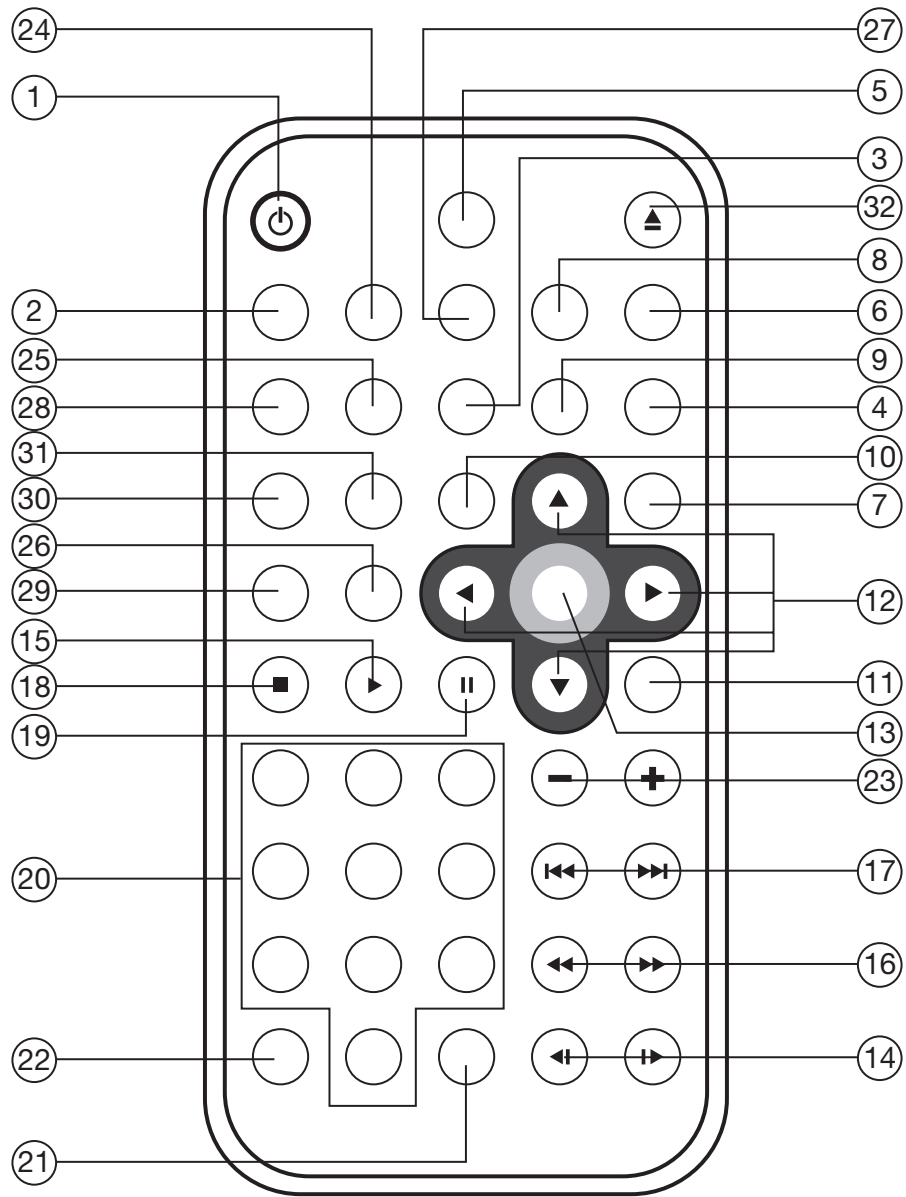











- 24. REMOTE Socket
- 25. AUDIO/VIDEO OUTPUT 1
- 26. AUDIO/VIDEO OUTPUT 2

REMOTE CONTROL

Location and Function of Keys



REMOTE CONTROL

1.  POWER Press POWER to turn the unit ON or OFF.
2. MUTE Press to mute the sound.
3. SUB-T Changing of the SUBTITLE language on multi-subtitle language DVD disc.
4. ANGLE Changing of the view angle on multi-angle DVD disc.
5. DISPLAY Display statistical disc information during playback.
6. MODE Changing between DVD mode, TV mode and AV mode.
7. SETUP Display the SETUP menu.
8. P/N Switch between PAL mode and NTSC mode.
9. AUDIO Changing of the AUDIO soundtrack on multi-audio soundtrack DVD disc. Changing of the sound mode of the VCD/CD disc.
10. TITLE Display the TITLE menu that is stored in DVD disc.
11. MENU Display the adjustment items, such as Bright, Contrast, Color, Tint, Transmit, Scree, Search and etc.
12.  ,  In case of SETUP Menu mode,  ,  buttons served as cursor buttons to select item left/right, ahead/back.
13. OK Confirm the Track/Chapter selected with the numeric buttons or selected with the cursor buttons on screen display.
14.  Changing for slow forward/reverse playback motion.
15.  Press to play the disc.
16.  Press  to search forward rapidly &  to search reverse rapidly.
17.  (CH-) /  (CH+) Press  to skip to the next track & press  to skip back one track.
In TV mode, press  (CH+) button or  (CH-) button to choose channel upward or downward.
18.  Press it to stop playback.
19.  Press it to pause playback.
20. 0 - 9 Numeric buttons
21. 10+ (-/--) Digital selecting button, cooperatively used with numeric buttons.
22. CLEAR When you input a number in error, press the button to clear it.
23. VOLUME+/- Press VOLUME+/- button to increase or decrease the volume level. Adjust the corresponding item when press MENU to select.
24. ZOOM Allows the picture to be increased in size.
25. RESUME When in pre-stop mode, press the button, the play can be resumed from the stop point.
26. GOTO Disc search button, cooperatively used with numeric button.
27. PBC Changing between PBC ON and PBC OFF on the VCD/DVD disc.
28. SHUFFLE Allows the track played in random order.
29. PROGRAM Allows the track played in the order you programmed.
30. REPEAT Switch the Repeat mode of discs.
31. A-B A-B repeat allows a passage to be repeated continuously.
32.  (EJECT) Press to eject the disc.

REMOTE CONTROL

Preparing the Remote Control

Inserting the Batteries

1. Open the battery compartment cover.
2. Insert the new battery. Make sure that the positive and negative terminals of the battery are oriented as indicated.
3. Close the cover.
 - Battery: a button cell lithium battery (CR2025 3V)

Using the Remote Control

Face the remote control towards the player front face **IR** mark (remote control signal receiver).

Operation angle: About \square 30 degree in each the direction of the front of the IR mark.

GENERAL OPERATION

TURNING THE UNIT ON/OFF

Turning on the Player

After all connections are completed correctly, Press  power button on the front panel to turn on the power. When the unit is on, it will search the disc automatically. If there is a disc in the disc slot, the unit will start playback automatically.

Turning off the Player

When the power is on press  power button on the front panel or on the remote control to turn off the power.

AV output Type Selection

Slide **AV OUTPUT TYPE** switch on the back of the unit left or right to select A or B.

When the switch is slid to **A** side, the AV OUTPUT 1 and AV OUTPUT 2 are both under the control of the **MODE** button on the remote control or on the front panel of the unit, i.e. the signal output may be any one of the DVD, AV INPUT 1 and AV INPUT 2 signal source.

When the switch is slid to **B** side, the AV OUTPUT 1 just outputs the AV INPUT 1 signal and it doesn't under the control of the **MODE** button or **SOURCE** button. But the signal output from the AV OUTPUT 2 is under the control of the **MODE** button on the remote control or on the front panel of the unit.

Remote Sensor (IR)

Point the remote handset to the remote sensor **IR** on the DVD unit. Receive the signal from remote handset.

Loading a Disc



Insert the disc into the disc slot with the printed side facing up, the player will play the disc automatically.

Removing a Disc

When the disc stops playing, press  eject button on the front panel to eject the disc.

BASIC PLAY





Stopping Playback



- Shortly press  button on the front panel or on the remote control one time to pre-stop the unit playback. When  button on the front panel or on the remote control is pressed, normal

playback will continue.



- Press  button twice to stop the playback and go back to the DVD LOGO.

Pausing Play/Step Play

Pressing  on the front panel or  on the remote control during playback will stop playback temporarily. To return to normal playback, press  on the remote control or  on the front panel.

If you play a DVD/VCD/SVCD, press  on the remote control again to stop at the next picture (step function). If you play a CD/MP3/Picture CD, pressing  on the remote control again is ineffective.

Rapid Forward / Rapid Reverse

Press  &  during playback.

Each time the button is pressed, the speed of rapid forward/reverse changes according to the disc as follows.

DVD/VCD/CD/MP3:

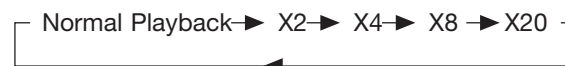



Slow Motion Playback (For DVD Only)

Press  /  during play.

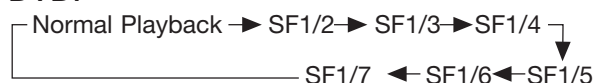

Each time the button is pressed, the speed of slow forward/reverse changes according to the disc as follows.



DVD:





In slow motion state, press  on the remote control to recover normal playback.

Skipping Track

Press  /  buttons on the remote control or on the front panel during playback.

Press  to skip to the next track, and press  to skip to the previous track.

Note:

For some VCD2.0 discs (PBC-playback control),  /  buttons may be unavailable.

Volume Level Adjustment

Rotating **VOL+/-** button on the DVD unit or **VOLUME +/-** on the remote control to increase or decrease the volume level.

GENERAL OPERATION

DVD VIDEO MENU PLAY

When playing a DVD disc in the DVD player:

- 1) The disc will be played automatically and stop at menu picture.
- 2) Use ◀/▶, ▲/▼ cursor buttons on the remote control to move between the highlight bars in the menu.
- 3) Press **OK** button on the remote control to confirm the selected item.

MODE SELECTION

Press **MODE** button on the front panel to select among DVD ,TV ,AV mode.

LAST PLAY MEMORY

- ◆ During disc playback, if you hold ⏻ power on the DVD unit for several seconds or press ⏻ power button on the remote control to turn off the unit and then press the ⏻ power button on the DVD unit again to turn on the unit, the DVD unit will resume playing from the point that just interrupted.
- ◆ During disc playback, if you press **MODE** button to switch to TV mode or AV mode, then return to DVD mode again, the unit will resume playing from the point that just interrupted.

MENU FUNCTION

Shortly press the **MENU** button on the DVD unit or on the remote control during DVD, AV mode to display the adjustment items on the screen.

(For the unit with PAL system)

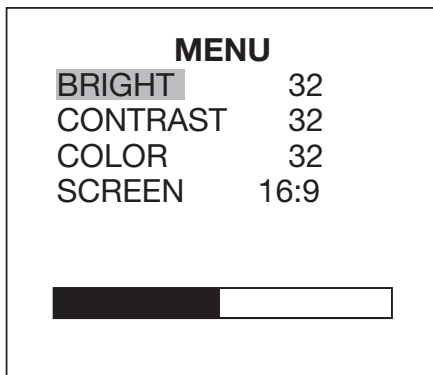

(For the unit with NTSC system)

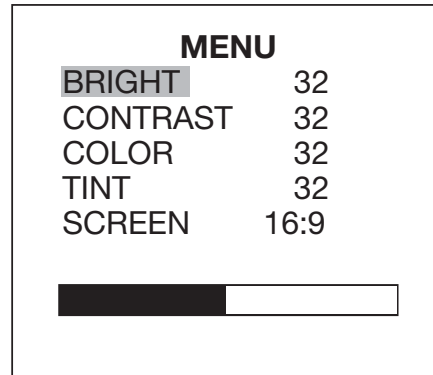

Press ▲/▼ buttons to select among Bright, Contrast, Color and Tint (For the unit with NTSC system) items and etc.

Then press ◀/▶ buttons to adjust the corresponding item.

In Screen item, you can select appropriate TV aspect ratio (4:3 or 16:9) using the ◀/▶ buttons.

Note: Only in TV mode, there is a “Search” item to be selected (For details, see the TV OPERATION). In DVD or AV mode, the Search item will not display on the screen.

ADVANCED OPERATION

REPEAT PLAY/ PARAGRAPH REPEAT PLAY

Repeat play: When you want to repeat playing the whole disc or a track or a chapter in the disc.

- 1) Press **REPEAT** button repeatedly to select different repeat modes.
- 2) For different kinds of disc, pressing **REPEAT** button has different effects.
For DVD:



For VCD/SVCD/CD/MP3/WMA:



Note: REPEAT feature does not support VCD2.0 (with PBC ON).

Paragraph Repeat Play: When you want to repeat playing a desired paragraph.

A-B repeat allows a passage to be repeated continuously.

- 1) Press **A-B** button first at the start of the required passage.

REPEAT A -

- 2) Press **A-B** button secondly at the end of the passage.

REPEAT A - B

- 3) Then the unit will repeat playing the passage you just set from A to B.
- 4) To revert to normal playback, press **A-B** button again.

REPEAT CANCEL

PBC MENU PLAYBACK OF VCD/SVCD

For some VCD or SVCD discs, there is a menu in order to select the desired contents. This menu is called PBC (Playback Control) menu.

Press **PBC** button on the remote control to change between PBC ON and PBC OFF on the disc.

In PBC ON mode, REPEAT, RANDOM, BOOKMARK, A-B, PROGRAM and GOTO functions are unavailable.

ON-SCREEN DISPLAY FUNCTION

Press the **DISPLAY** button during playback to display the console information of the current disc on the screen.

For DVD:

Once you press DISPLAY button you will see the information as the following order.

DVD TT 1/2 CH 1/1 ⌚ 00:00:01

DVD TT 1/2 CH 1/1 C- 00:13:53

⏮ 1/1 ENG ⏪ 5.1CH ⏭ 1/4 ENG ⏸ OFF

DVD TT 1/2 CH 1/1 T 00:00:03

DVD TT 1/2 CH 1/1 T- 00:29:27

DVD TT 1/2 CH 1/1 C 00:01:02

- 1) Item: TT
Function: Display the current title number and total title number.
- 2) Item: CH
Function: Display the current chapter number and total chapter number.
- 3) Item: ⌚
Function: Display the played time of the whole disc.
- 4) C-: Display the remaining time of the current chapter.
- 5) T: Display the player time of time current title.
- 6) T-: Display the remaining time of the current title.
- 7) C: Display the played time of the current chapter.
- 8) ⏮ 1/1 ENG ⏪ 5.1CH ⏭ 1/4 ENG ⏸ OFF
Display the current disc's LANGUAGE, AUDIO TYPE, SUBTITLE LANGUAGE and PLAY ANGLE.

For VCD:

VCD TT 1/2 CH 1/1 ⌚ 00:03:15

VCD TT 1/2 CH 1/ C- 00:13:53

VCD TT 1/2 CH 1/1 T 00:00:03

VCD TT 1/2 CH 1/1 T- 00:29:27

DVD TT 1/2 CH 1/1 C 00:01:02

ADVANCED OPERATION

The meaning of the menu is the same with the DVD menu above.

GOTO FUNCTION

FOR DVD:

Press **GOTO** button, the screen will display the following message:



Use the number keys to input the desired Title, Chapter or Time, then press **OK** key to confirm.

FOR VCD (WITH PBC OFF)/CD:



You can input the Track and Time then press **ENTER** key to confirm.

ZOOM FUNCTION

Allows the picture to be increased in size. Press **ZOOM** button on the remote control to toggle among 2 scale, 3 scale and 4 scale, 1/2 scale, 1/3 scale, 1/4 scale. When the scale is 1/4 times, press **ZOOM** button again to cancel the zoom function.

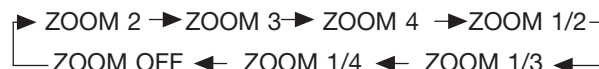

During Zoom mode, press **◀/▶**, **▲/▼** buttons to move pictures up, down, left, or right direction.

SPECIAL FUNCTIONS FOR DVD

Multi-subtitle Language Function

Press **SUB-T** during playback. The following information will be shown on the screen.



Each time the button is pressed, the subtitle language changes in sequential order.

Notes:

- The language number is different according to the disc.
- Some discs only contain one subtitle language.

Multi-audio Language Function

Press **AUDIO** during playback. The following information will be shown on the screen.



Each time the button is pressed, the

audio soundtrack language changes in sequential order.

Notes:

- The language number is different according to the disc.
- Some discs only contain one soundtrack language.

Multi-angle Function

Press **ANGLE** during playback. The following information will be shown on the screen.

ANGLE 1



Each time the button is pressed, the angle changes in sequential order.

Notes:

- The angle number is different according to the disc.
- The function only works for discs having scenes recorded at different angles.

FREQUENTLY ASKED QUESTIONS

- When inserting a DVD disc, why it can't be played, just showing "region error"? It is because that the DVD player and the discs all have the "REGION CODE". If the region number described on the DVD disc does not correspond to the region number of this DVD player, the unit cannot play the disc.

- When inserting a DVD disc, there is a window shown on the screen that requires entering 4 characters password, why? It is because that the current disc has "Parental Control" level, and the player's parental level is set below the level of the disc, you should enter the correct password to play the disc normally.

NOTE:

- For how to set the "Parental Control" level, please refer to "SETUP\LOCK" in the following page.

ATTACHMENT: PARENTAL CONTROL
DVD discs have a parental level assigned to the disc.

The range of parental controls is from 1

ADVANCED OPERATION

to 8. The player can be set in a similar way. If the player's parental level is set to 8 it will play all discs. If the player's parental level is set below 8, only discs with a lower or equal parental level will play.

For example if the player is set to 5, only discs with parental control ratings of 5, 4, 3, 2, & 1 will play. To play a higher rated disc you must change the player's rating to a higher number.

For example, consider a disc that generally is suitable for most audiences, and is rated as level 2 for the most part. However in the middle there are also scenes rated at 5 & 7 (not suitable for children).

Alternative scenes with lower rating are included.

The player plays the highest rated scene that the parental setting allows.

A section of the disc can have several different sequences that vary in parental control level. In the above example of a disc with parental control, the player will show a different section depending on the parental control level set in the player's menu. In this way parents can control the content of films and there is no indication that any censorship has occurred.

The meaning of the levels 1 to 8 varies depending upon the country and the type of content on the disc.

The parental control levels are:

- Unlock
- 1 G
- 2
- 3 PG
- 4 PG 13
- 5
- 6 R
- 7 NC 17
- 8

ADVANCED OPERATION

SPECIAL FUNCTIONS FOR VCD AND CD

For VCD and CD discs, there is one special function “Program Play” which makes it different from DVD discs.

- The function is effective in PBC OFF mode. Press **PROGRAM** button can activate program edit interface.

Prog-			
1 []	5 []	9 []	13 []
2 []	6 []	10 []	14 []
3 []	7 []	11 []	15 []
4 []	8 []	12 []	16 []
Play		Clear	

- For how to set the program menu, please refer to the operation of the audio files in the media player below.

Note:

- After you have programmed the tracks, press **PROGRAM** button can switch between program play and normal play.
- Press **OK** button to exit the edit interface.

DATA DISC PLAY OPERATION

When you insert a data disc including audio (MP3, WMA), movie (MPEG), picture (JPG) files into the disc slot, the following media play window will be shown on the screen:

Prog-							
T	C	T	C	T	C	T	C
1__:	5__:	9__:	13__:				
2__:	6__:	10__:	14__:				
3__:	7__:	11__:	15__:				
4__:	8__:	12__:	16__:				
Play				Clear			

- 1) Use ◀ / ▶ or ▲ / ▼ cursor button to select the items you want to program.
- 2) The items you selected will become

- highlight.
- 3) Input the sequence number you want to program by numeric buttons (0-9,10+) on the remote control.
- 4) Press **OK** or select “play” operation button on the bottom area to program playback.

NOTE:

For audio CD, the play interface and operation is similar with the Music page operation. For details, please refer to the description of Music page above.

SETUP

In DVD mode, when the disc is playing or in the stop mode, press **SETUP** on the remote control to enter setup menu.

- When the cursor is on the topside, use ◀/▶ buttons to move between the different pages.
- Press ▼ button to move the cursor to the setup page below and then you can use ▲/▼ buttons to move between the different setup options.
- Press ▶ button to display the choice list for each setup option and then use ▲/▼ buttons and **OK** button to change your selection.

SYSTEM SETUP

When you open the setup menu, you will see the system setup page at first, see below:

SYSTEM SETUP

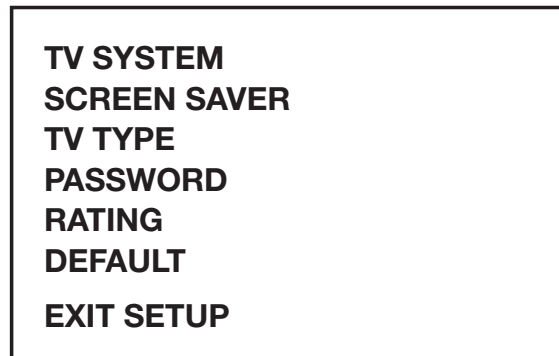

- 1) TV SYSTEM: Change the TV mode among NTSC, PAL and AUTO.
- 2) SCREEN SAVER: Change the SCREEN SAVER on or off.
- 3) TV TYPE: Change the TV TYPE among 4:3PS, 4:3LB and 16:9.
- 4) PASSWORD: Change the PASSWORD lock or unlock, the default PASSWORD is "0000".
- 5) RATING: Change the parental RATING among 1KID SAFE, 2G, 3PG, 4PG13, 5PG-R, 6R, 7NC-17, 8ADULT.
- 6) DEFAULT: Restore the system setup to the default setup.

LANGUAGE SETUP

- When you open the setup menu, you will see the language setup page :

LANGUAGE SETUP



You can change the OSD/ AUDIO/ SUBTITLE/ MENU language between ENGLISH/GERMAN/SPANISH/FRENCH/ PORTUGUESE/ITALIAN/(RUSSIAN)(RUSSIAN only for MENU LANG).

AUDIO SETUP

- When you open the AUDIO menu, you will see the following picture:

AUDIO SETUP

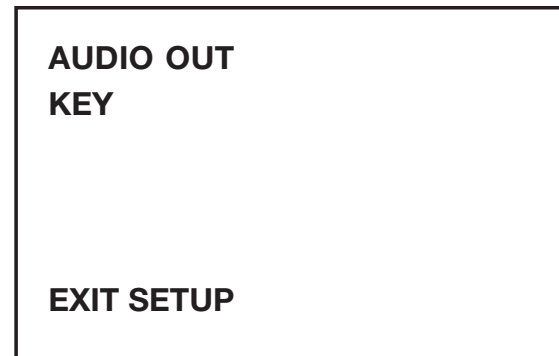

- 1) AUDIO OUT: Change among SPDIF/OFF, SPDIF/RAW and SPDIF/PCM.
- 2) KEY: Change among -4, -2, 0, +2, +4.

TV OPERATION

Press the **MODE** button on front panel to switch among TV mode.

When in TV mode, the function of the buttons served in DVD mode is locked.

Menu function in TV mode

Press the **MENU** button on the unit during DVD, TV and AV mode to display the adjustment items on the screen.

(For the unit with PAL system)

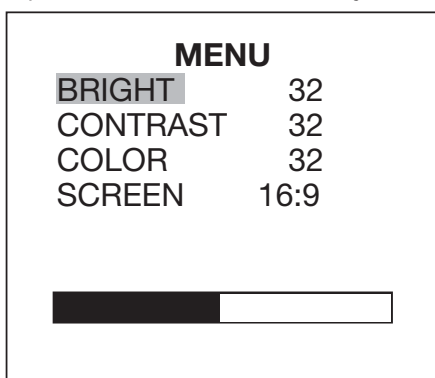

(For the unit with NTSC system)

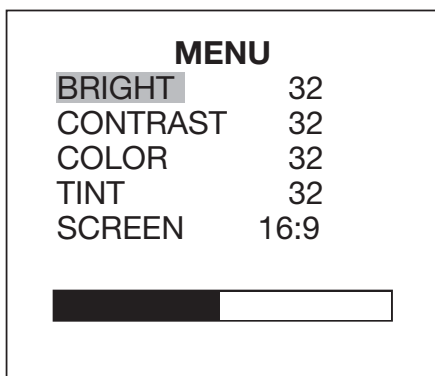

Press **▲/▼** buttons to select among Bright, Contrast, Color and Tint (For the unit with NTSC system) items and etc.

Then press **◀/▶** buttons to adjust the corresponding item.

In Screen item, you can select appropriate TV aspect ratio (4:3 or 16:9) using the **◀/▶** buttons.

Selecting Channels

- Press **▶▶/◀◀** on the remote control or **CH+/CH-** button on the front panel to choose channel up or down.
- The numeric buttons (0,1~9) allow you to select the corresponding channel directly.
- Press digital select button **-/-- (10+)** cooperatively used with numeric buttons to select channel desired.

Volume Adjustment

Rotating **VOL+/-** on the DVD unit or **VOLUME +/-** on the remote control to adjust volume level.

Auto searching TV channels

Press **MENU** button on the remote control or press and hold **TV SCAN** button on the front panel for several seconds, "**SEARCH...**" will appear on the screen display, then press **CH+** on the remote control to start search channel automatically.

In the course of searching, press **CH-** button on the remote control to stop searching.

TROUBLE SHOOTING

If it appears that your DVD unit is faulty, first consult this checklist. It may be that something simple has been overlooked.

Under no circumstances should you try to repair the player yourself, as this will invalidate the warranty. Only qualified service personnel can remove the cover or service this player.

NO POWER

- Check if the POWER button on the front of the player is set to ON.
- Check if AC or DC power plug of the mains unit is properly connected.
- Check if there is power at the AC or DC outlet.
- Check if the voltage of the battery is too low.

NO PICTURE

- Select the correct TV or AV input.
- Check the video connection.

DISTORTED PICTURE

- Check the disc for fingerprints and clean with soft cloth, wiping from centre to edge.
- Sometimes a small amount of picture distortion may appear. This is not a malfunction.

COMPLETELY DISTORTED PICTURE

- The disc format is not according to the TV-set used (PAL/NTSC).

NO COLOR IN PICTURE

- The disc format is not according to the TV-set used (PAL/NTSC).

DISC DOES NOT PLAY

- Ensure the disc label is upwards.
- Clean the disc.
- Check if the disc is defective by trying another disc.

NO SOUND

- Check audio connections.
- If using a HIFI amplifier, try another sound source.

NO RETURN TO START-UP SCREEN WHEN DISC IS REMOVED

- Press  **power** to turn off the unit, then press it again to turn on the unit.

THE PLAYER DOES NOT RESPOND TO THE REMOTE CONTROL

- Aim the remote control directly at the sensor on the front of the player.
- Avoid all obstacles which may interfere with the signal path.
- Inspect or replace the remote control batteries.

DISTORTED OR B/W PICTURE

- The disc format is not according to the TV-set used (PAL/NTSC).

NO AUDIO AT DIGITAL OUTPUT

- Check the digital connections
- Check the Audio menu to make sure that the digital output is correctly set.
- Check if the audio format of the selected audio language matches your receiver's capabilities.

BUTTONS DO NOT WORK

- Turn the player off and on with the power on/off button on the side of the player.

SPECIFICATIONS

Supply Voltage	: 12V DC (11V-15V), test voltage 14.4V, negative ground
Current Consumption	: Less than 2A
Signal System	: Compositive video 1.0Vp-p 75Ω
Discs Played	: (1) DVD-VIDEO Disc (2) Compact Disc (CD-DA/CD-R/CD-RW/MP3) (3) VIDEO CD
Audio Output Level	: 10KΩ (2 ch 1.3Vrms)
Audio Signal Output Characteristics	: (1) Frequency Response : 20 Hz - 20 KHz (2) S/N Ratio : 80 dB (JIS) (3) Wow and Flutter : Below measurement limits

Note:

Specifications and design are subject to modification, without notice, due to improvements in technology.

This product incorporates copyright protection technology that is protected by method claims of certain U.S. patents and other intellectual property rights owned by Macrovision Corporation and other rights owners. Use of this copyright protection technology must be authorized by Macrovision Corporation, and is intended for home and other limited viewing uses only unless otherwise authorized by Macrovision Corporation. Reverse engineering or disassembly is prohibited.

Free Manuals Download Website

<http://myh66.com>

<http://usermanuals.us>

<http://www.somanuals.com>

<http://www.4manuals.cc>

<http://www.manual-lib.com>

<http://www.404manual.com>

<http://www.luxmanual.com>

<http://aubethermostatmanual.com>

Golf course search by state

<http://golfingnear.com>

Email search by domain

<http://emailbydomain.com>

Auto manuals search

<http://auto.somanuals.com>

TV manuals search

<http://tv.somanuals.com>