

SHARP

MD/CD STEREO

MODEL
MD-X8

OPERATION MANUAL

Thank you for purchasing this SHARP product.
For the best performance, read this manual carefully.
It will guide you in operating your SHARP product.

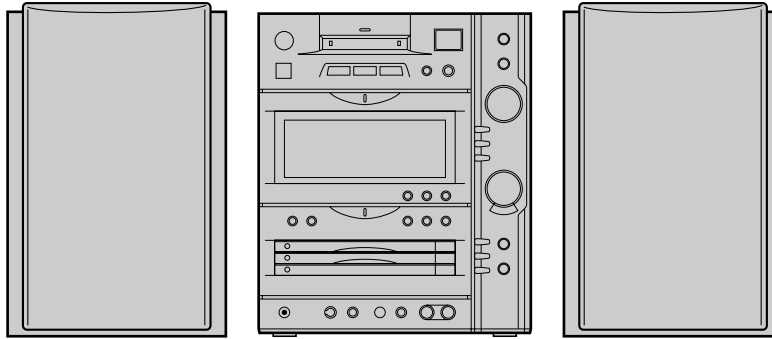

MD-X8 MD/CD stereo consisting of
MD-X8 MD/CD stereo
CP-X8 2 way speaker system.



CONTENTS

	Page		Page
IMPORTANT SAFEGUARDS	1	BASIC INFORMATION ON MINIDISCS	26
SPECIAL NOTES	1-2	RECORDING	27-30
PRECAUTIONS	2	EDITING	31-37
NAMES OF CONTROLS AND INDICATORS	3-4	HOW TO USE THE BUILT-IN TIMER	38-43
PREPARATION FOR USE	5-7	USING EXTERNAL UNITS	44-48
DISPLAY SECTION	8	CHANGING THE MESSAGES DISPLAYED WHEN THE POWER IS TURNED ON/OFF	49-51
MULTI CONTROL BUTTON	9	WHAT IS A MINIDISC?	52
SETTING THE CLOCK	10	MINIDISC SYSTEM LIMITATIONS	53
SOUND CONTROL	11-12	TROUBLESHOOTING	54-55
HOW TO ENTER CHARACTERS	13-16	RESETTING THE MICROCOMPUTER	56
COMPACT DISC OPERATION	17	MAINTENANCE	57
MINIDISC OPERATION	18	SPECIFICATIONS	57
RADIO OPERATION	19-20	CALLING FOR SERVICE	Back cover
PROGRAMMING RADIO STATION NAMES	21	LIMITED WARRANTY	Back cover
VARIOUS CD AND MD OPERATIONS	22-25		

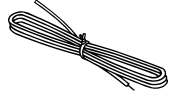
ACCESSORIES

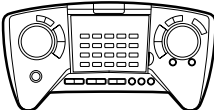
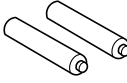
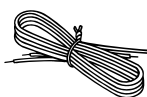
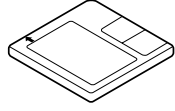
					
FM antenna x 1 [92LF-ANT1533A]	AM loop antenna x 1 [92LL-ANT1676A]	Remote control x 1 [RRMCG0101AWSA]	"AA" size battery (UM/SUM-3, R6, HP-7 or similar) x 2 [UBATU0001AWZZ]	Speaker wire x 2 [92L291-0055]	Blank (Recordable) miniDisc (60 minutes recording length) x 1 [UDSKM0001AFZZ]

Note:

Parts and equipment mentioned in this operation manual other than those shown on the above are not included.



The lightning flash with arrowhead symbol, within an equilateral triangle, is intended to alert the user to the presence of uninsulated "dangerous voltage" within the product's enclosure that may be of sufficient magnitude to constitute a risk of electric shock to persons.

CAUTION

RISK OF ELECTRIC SHOCK
DO NOT OPEN

CAUTION: TO REDUCE THE RISK OF ELECTRIC SHOCK, DO NOT REMOVE COVER (OR BACK). NO USER-SERVICEABLE PARTS INSIDE. REFER SERVICING TO QUALIFIED SERVICE PERSONNEL.



The exclamation point within an equilateral triangle is intended to alert the user to the presence of important operating and maintenance (servicing) instructions in the literature accompanying the appliance.

IMPORTANT SAFEGUARDS

CAUTION

All the safety and operating instructions should be read before the appliance is operated, and should be retained for future reference. Electrical energy can perform many useful functions. This unit has been engineered and manufactured to assure your personal safety. Improper use can result in potential electrical shock or fire hazards. In order not to defeat the safeguards, observe the following basic rules for its installation, use and servicing.

- 1 Heed Warnings - All warnings on the appliance and in the operating instructions should be adhered to.
- 2 Follow Instructions - All operating and use instructions should be followed.
- 3 Water and Moisture - The appliance should not be used near water - for example, near a bathtub, washbowl, kitchen sink, laundry tub, in a wet basement, or near a swimming pool, etc.
- 4 Carts and Stands - The appliance should be used only with a cart or stand that is recommended by the manufacturer.
 - An appliance and cart combination should be moved with care.
 

Quick stops, excessive force, and uneven surfaces may cause the appliance and cart combination to overturn.
- 5 Wall or Ceiling Mounting - The appliance should be mounted to a wall or ceiling only as recommended by the manufacturer.
- 6 Ventilation - The appliance should be situated so that its location or position does not interfere with its proper ventilation. For example, the appliance should not be situated on a bed, sofa, rug, or similar surface that may block the ventilation openings; or, placed in a built-in installation, such as a bookcase or cabinet that may impede the flow of air through the ventilation openings.
- 7 Heat - The appliance should be situated away from heat sources such as radiators, heat registers, stoves, or other appliances (including amplifiers) that produce heat.
- 8 Power Sources - The appliance should be connected to a power supply only of the type described in the operating instructions or as marked on the appliance.
- 9 Power-Cord Protection - Power-supply cords should be routed so that they are not likely to be walked on or pinched by items placed upon or against them, paying particular attention to cords at plugs, convenience receptacles, and the point where they exit from the appliance.
- 10 Do not use liquid cleaners or aerosol cleaners. Use a damp cloth for cleaning.
- 11 Power Lines - An outdoor antenna should be located away from power lines.

- 12 Outdoor Antenna Grounding - If an outside antenna is connected to the receiver, be sure the antenna system is grounded so as to provide some protection against voltage surges and built-up static charges. Article 810 of the National Electrical Code, ANSI/NFPA 70, provides information with regard to proper grounding of the mast and supporting structure, grounding of the lead-in wire to an antenna discharge unit, size of grounding conductors, location of antenna-discharge unit, connection to grounding electrodes, and requirements for the grounding electrode.

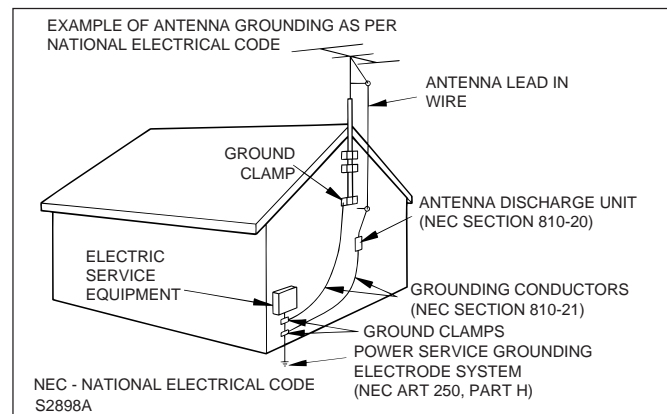

- 13 Non use Periods - The power cord of the appliance should be unplugged from the outlet when left unused for a long period of time.
- 14 Object and Liquid Entry - Care should be taken so that objects do not fall and liquids are not spilled into the enclosure through openings.
- 15 Damage Requiring Service - The appliance should be serviced by qualified service personnel when:
 - A The power-supply cord or the plug has been damaged; or
 - B Objects have fallen, or liquid has been spilled into the appliance; or
 - C The appliance has been exposed to rain; or
 - D The appliance does not appear to operate normally or exhibits a marked change in performance; or
 - E The appliance has been dropped, or the enclosure damaged.
- 16 Servicing - The user should not attempt to service the appliance beyond that described in the operating instructions. All other servicing should be referred to qualified service personnel.
- 17 Grounding or Polarization - Precautions should be taken so that the grounding or polarization means of an appliance is not defeated.

SPECIAL NOTES

FOR YOUR RECORDS

For your assistance in reporting this unit in case of loss or theft, please record below the model number and serial number which are located on the rear of the unit.

Please retain this information.

Model number _____

Serial number _____

Date of purchase _____

Place of purchase _____



(Continued)

Caution - use of controls or adjustments or performance of procedures other than those specified herein may result in hazardous radiation exposure.

Note:

This equipment has been tested and found to comply with the limits for a Class B digital device, pursuant to Part 15 of the FCC Rules. These limits are designed to provide reasonable protection against harmful interference in a residential installation.

This equipment generates, uses, and can radiate radio frequency energy and, if not installed and used in accordance with the instructions, may cause harmful interference to radio communications.

However, there is no guarantee that interference will not occur in a particular installation. If this equipment does cause harmful interference to radio or television reception, which can be determined by turning the equipment off and on, the user is encouraged to try to correct the interference by one or more of the following measures:

- Reorient or relocate the receiving antenna.
- Increase the separation between the equipment and receiver.
- Connect the equipment into an outlet on a circuit different from that to which the receiver is connected.
- Consult the dealer or an experienced radio/TV technician for help.

WARNING: TO REDUCE THE RISK OF FIRE OR ELECTRIC SHOCK, DO NOT EXPOSE THIS APPLIANCE TO RAIN OR MOISTURE.

WARNING

FCC Regulations state that any unauthorized changes or modifications to this equipment not expressly approved by the manufacturer could void the user's authority to operate this equipment.

SPECIAL NOTES FOR FCC COMPOSITE DEVICE:

This device is a composite system. The digital device component may not cause harmful interference.

- It is the intent of Sharp that this product be used in full compliance with the copyright laws of the United States and that prior permission be obtained from copyright owners whenever necessary.
- US and foreign patents licensed from Dolby Laboratories Licensing Corporation.
- SRS technology licensed from SRS Labs. SRS technology holds the following patents: U.S. Patent No. 4,748,669, U.S. Patent No. 4,841,572.
- **SRS**, the SRS Logo (●) and the **SOUND RETRIEVAL SYSTEM** are registered trademarks of SRS Labs, Inc.

PRECAUTIONS

General

- Please ensure that the equipment is positioned in a well ventilated area and ensure that there is at least 5 cm of free space along the sides, top and back of the equipment.
- Do not use oil, solvents, gasoline, paint thinner or insecticides on the unit.
- Do not expose the unit to moisture, to temperatures higher than 140°F (60°C) or to extreme low temperatures.
- Keep the unit away from direct sunlight, strong magnetic fields, excessive dust, humidity and electronic/electrical equipment (home computers, facsimiles, etc.) which generates electrical noise.
- Hold the AC power plug by the head when removing it from the AC outlet, since pulling the cord can damage internal wires.
- Remove the AC power plug from the AC outlet before cleaning. This unit contains dangerous voltages. Do not remove the outer cover, as this may result in electric shock. Refer internal service to your local SHARP service facility.
- Use the unit on a firm, level surface free from vibration, and do not place anything on the top of the unit.
- If the unit does not work properly while in use, press the POWER button to turn the power off, then disconnect the AC power cord from the AC outlet. Plug the AC power cord back in, and then press the POWER button to turn the power on.
- If an electrical storm is taking place near you, it is suggested that you disconnect the AC power cord from the AC outlet for safety.
- Before moving the unit, be sure to remove all CDs and MDs from the unit. Then, turn the power off and unplug the AC power cord. If you move the unit with CDs or MDs left in it, they may jam inside the unit, leading to damage.

Warning:

The voltage used must be the same as that specified on this unit. Using this product with a higher voltage than that which is specified is dangerous and may result in a fire or other type of accident causing damage. SHARP will not be held responsible for any damage resulting from use of this unit with a voltage other than that which is specified.

Volume control

The sound level at a given volume setting depends on a combination of speaker efficiency, location and many other factors.

It is advisable to avoid exposure to high volume levels, which occur while turning the unit on with the volume control setting up high, or while continually listening at high volumes.

Condensation

Sudden temperature changes and storage or operation in an extremely humid environment may cause condensation inside the cabinet.

Condensation can cause the unit to malfunction.

Follow the procedure below to eliminate condensation.

CD and MD pickups

Leave the power on with no disc in the unit until normal playback is possible (about 1 hour).

Remote control

Wipe off any condensation on the transmitter window with a soft cloth before operating the unit.

Care of compact discs

Compact discs are fairly resistant to damage, however mistracking can occur due to an accumulation of dirt on the disc surface.

Follow the guidelines below for maximum enjoyment from your CD collection and player.

- Do not write on either side of the disc, particularly the non-label side. Signals are read from the non-label side. Do not mark on this surface.
- Keep your discs away from direct sunlight, heat, and excessive moisture.
- Always hold CDs by the edges. Fingerprints, dirt, or water on the CDs can cause noise or mistracking. If a CD is dirty or does not play properly, clean it with a soft, dry cloth, wiping straight out from the center, along the radius.

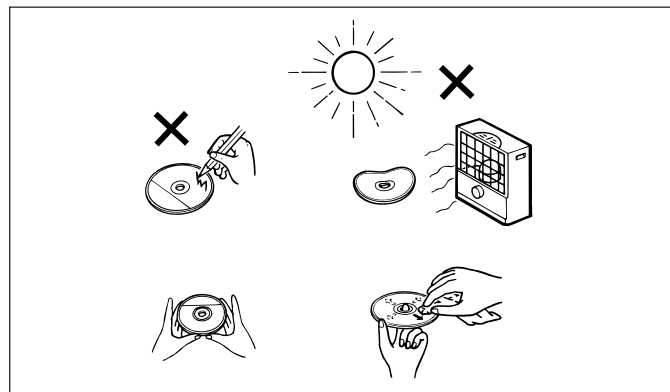



NAMES OF CONTROLS AND INDICATORS

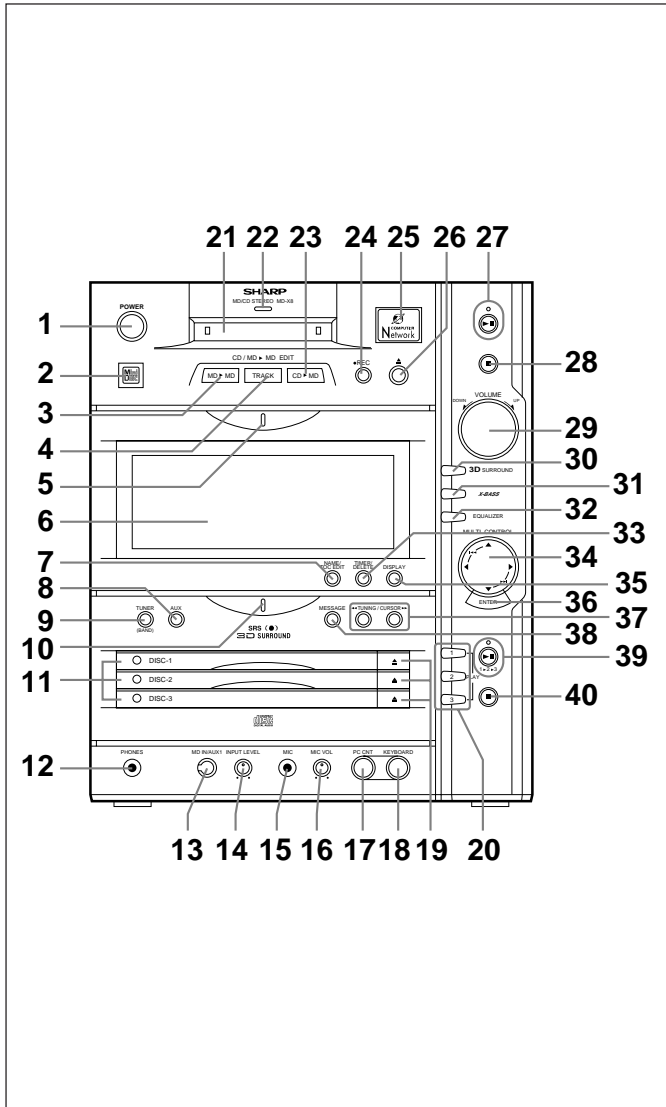

● FRONT PANEL

1. Power Button: POWER
2. Remote Control Sensor
3. MD ► MD Edit Button: MD ► MD
4. CD Track Select Button: TRACK
5. Personal Computer Mode Indicator
6. LCD Display
7. Name / TOC-Edit Button: NAME/TOC EDIT
8. Auxiliary Input (Digital/Analog / Phono) Button: AUX
9. Tuner Call (Band Select) Button: TUNER (BAND)
10. 3D Surround Indicator
11. CD Disc Trays
12. Headphones Jack: PHONES
13. MD Edit/Auxiliary 1 (Analog) Input Jack: MD IN/AUX1
14. Auxiliary Input Level (Analog) Control: INPUT LEVEL
15. Microphone Jack: MIC
16. Microphone Input Level Control: MIC VOL
17. Personal Computer Connect Jack: PC CNT
18. Keyboard Connect Jack: KEYBOARD
19. CD Open / Close Buttons: ▲
20. CD Play Buttons: PLAY 1-3
21. MD Compartment
22. MD Indicator
23. CD Edit Button: CD ► MD
24. Record Button and Indicator: ■
25. Computer Network Button
26. MD Eject Button: ▲
27. MD Play/Pause Button and Indicator: ►||
28. MD Stop Button : ■
29. Volume Control: VOLUME
30. 3D Surround Button: 3D SURROUND
31. Extra Bass Button: X-BASS
32. Equalizer Button: EQUALIZER
33. Timer/Delete Button: TIMER / DELETE
34. Multi Control Button: MULTI CONTROL
35. Display Button: DISPLAY
36. Enter Button: ENTER
37. Tuning Up-Down/Cursor Buttons: ◀◀ / ▶▶
38. Message Button: MESSAGE
39. CD Play/Pause Button and Indicator: ►||
40. CD Stop Button: ■

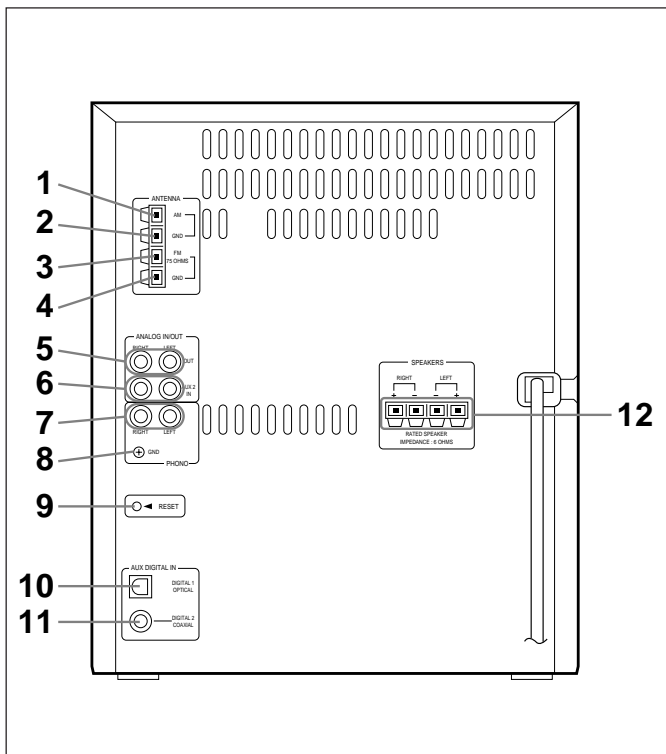

● REAR PANEL

1. AM Antenna Terminal
2. AM Antenna Ground Terminal
3. FM Antenna Terminal
4. FM Antenna Ground Terminal
5. Analog Output Jacks
6. AUX2 (Analog) Input Jacks
7. Phono Input Jacks
8. Phono Ground Terminal
9. Reset Button
10. Auxiliary Digital 1 Input Jack (Optical)
11. Auxiliary Digital 2 Input Jack (Coaxial)
12. Speaker Terminals



(Continued)

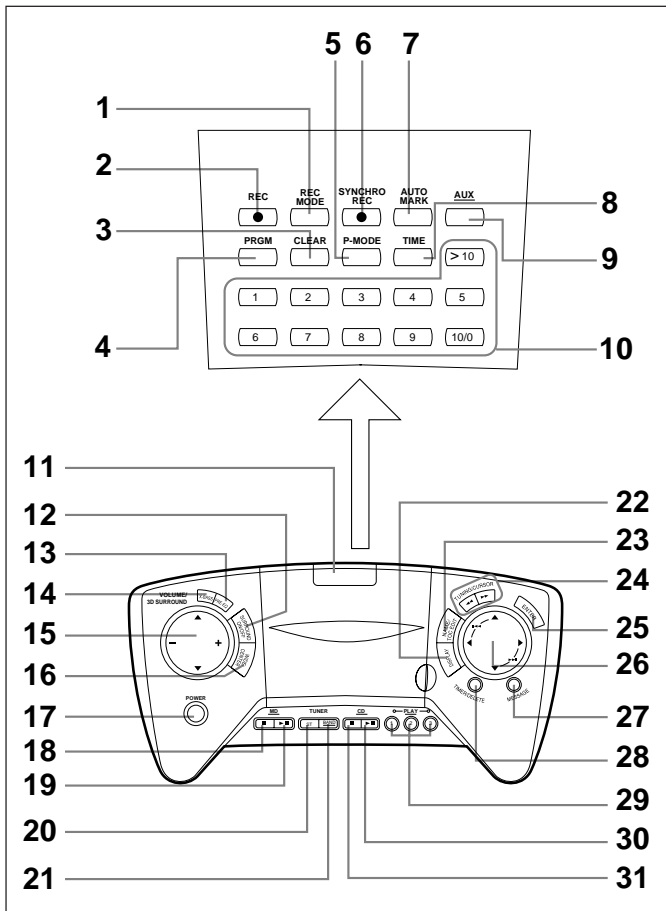

● REMOTE CONTROL

- 1. Record Mode Button: REC MODE
- 2. Record Button: ●
- 3. Clear Button: CLEAR
- 4. Program Button: PRGM
- 5. Play Mode Button: P-MODE
- 6. Synchro Record Button: SYNCHRO REC ●
- 7. Auto Mark Button: AUTO MARK
- 8. Time Display Select Button: TIME
- 9. Auxiliary Input (Digital/Analog / Phono) Button: AUX
- 10. Tuner Preset/CD/MD Track Number Input Buttons
- 11. Remote Control Transmitter Window
- 12. 3D Surround On/Off Button: SURROUND ON/OFF
- 13. Pre-Equalizer Button: PRE-EQ
- 14. Extra Bass Button: X-BASS
- 15. Volume / 3D Surround Button: VOLUME / 3D SURROUND
- 16. Wide/Center Button: WIDE/CENTER
- 17. Power Button: POWER
- 18. MD Stop Button: ■
- 19. MD Play/Pause Button: ►||
- 20. Tuner Stereo Button: ST
- 21. Tuner Band Button: BAND
- 22. Display Button: DISPLAY
- 23. Name/TOC-Edit Button: NAME/TOC EDIT
- 24. Tuning Up-Down/Cursor Buttons: ◀ / ▶
- 25. Enter Button: ENTER
- 26. Multi Control Button
- 27. Message Button: MESSAGE
- 28. Timer/Delete Button: TIMER/DELETE
- 29. CD Play Buttons: Play ① - ③
- 30. CD Play/Pause Button: ►||
- 31. CD Stop Button: ■

● SPEAKER

- 1. Dome Tweeter
- 2. Woofer
- 3. Speaker Terminals
- 4. Speaker Duct

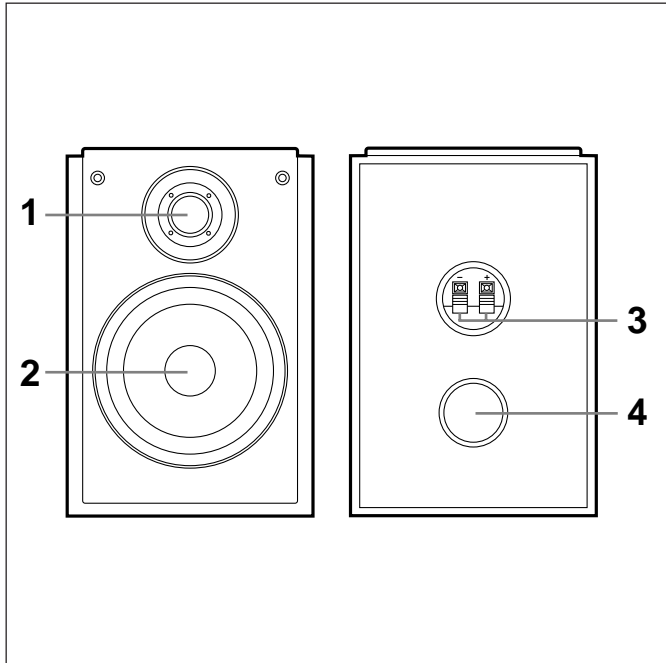

PREPARATION FOR USE

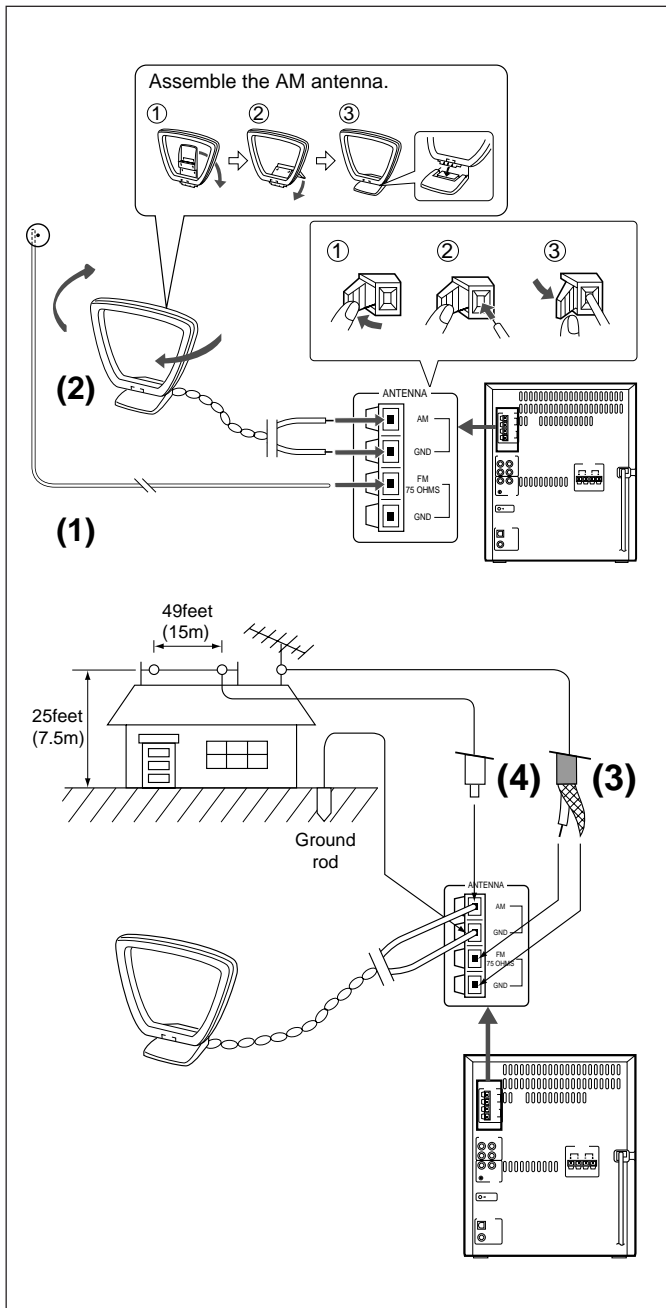

- Unplug the AC power cord from the AC outlet before connecting or disconnecting any component.

Antenna connection

(1) Supplied FM antenna

Connect the FM antenna wire to the FM 75 OHMS terminal and position the FM antenna wire in the direction where the strongest signal can be received.

(2) Supplied AM loop antenna

Connect the AM loop antenna wire to the AM LOOP and GND terminals. Position the AM loop antenna for optimum reception. Place the AM loop antenna on a shelf, etc., or attach it to a stand or a wall with screws (not supplied).

Notes:

- If static is still heard even after adjusting the position of the AM loop antenna, try reversing the wires.
- Do not place the AM loop antenna and the FM antenna wire on the unit. It may result in noise generation, since the unit is equipped with digital electronics. Place the AM loop antenna and the FM antenna wire away from the unit for better reception.
- If the AM loop antenna and the FM antenna wire are placed near the AC power cord, interference may result.

(3) Outdoor FM antenna

To connect a 75 ohm coaxial cable antenna, use the terminals marked FM 75 OHMS and GND. To connect an outdoor antenna to the unit, it is recommended that a 75 ohm coaxial cable be used. Its shielded construction resists most types of electrical interference that can cause reception noise. Consult your SHARP audio dealer for suggestions on the type of antenna best suited for your area.

Note:

When an outdoor FM antenna is used, disconnect the supplied FM antenna wire from the FM 75 OHMS terminal.

(4) Outdoor AM antenna

Use an outdoor AM antenna if you need better reception. Consult your dealer.

Note:

When using an outdoor AM antenna, be sure to keep the wire of the AM loop antenna connected.

Speaker connection

Connect each speaker wire to the SPEAKER terminals as shown.

- Connect the black wire to the minus (-) terminal and the red wire to the plus (+) terminal.

Cautions:

- Do not let the bare speaker wires touch each other as this may damage the amplifier and/or speakers.
- When connecting the speakers to the unit, connect the wires to the speakers first, and then to the terminals on the unit.
- When connecting the speakers to the unit, be sure to connect the speaker wires properly. Do not mistake the right channel for the left channel and the plus (+) terminal for the minus (-) terminal.
- Use these SPEAKER terminals for CP-X8 only, do not connect them to speakers other than CP-X8s.
- Do not allow any objects to fall into or to be placed in the bass reflex ducts.



(Continued)

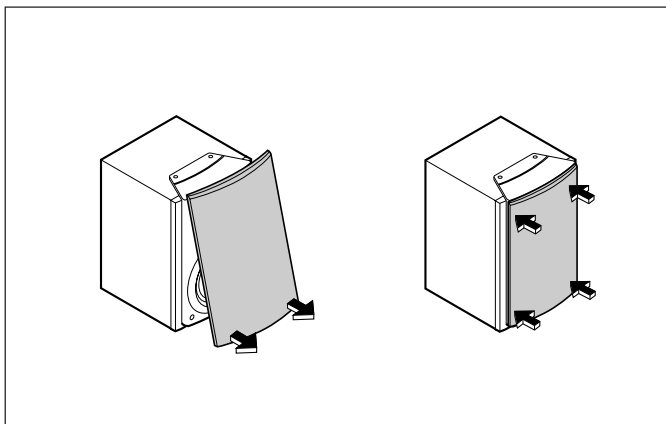

■ Removing the speaker grilles

- 1 Remove the lower part of the speaker grille first.
- 2 Remove the upper part of the speaker grille.

Caution:

When the speaker grilles are removed, the speaker diaphragms are exposed. Make sure nothing comes into contact with the speaker diaphragms.

■ Mounting the speaker grilles

Fit the four posts on the speaker grille into the mounting holes and push them lightly with the palm of your hand to secure.

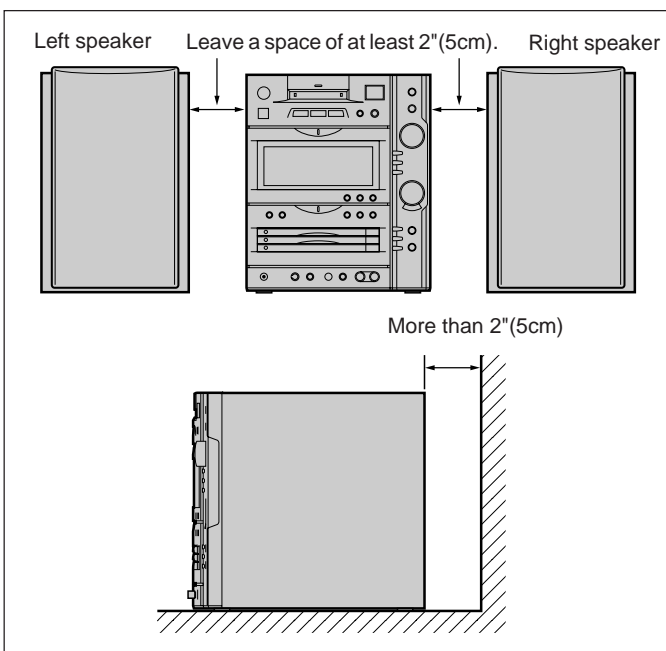

■ Placing the system

- Be sure to keep space between the units for ventilation.
- Keep the back and sides of this unit at least 2"(5cm) away from the wall.
- If any kind of magnet or an electromagnet is placed too close to the TV set and the system, irregular color may be seen.

TV set location

- Depending on the particular location of a TV set, color variations may be seen on the TV screen. If this happens, move the system and its speakers away from the TV and turn off the TV set. After 15 - 30 minutes, turn on the TV again.

The TV's own demagnetizing function should eliminate the variations. However, if the color still does not look right, move the system further away from the TV set.

Note:

- A cooling fan is built into this product to avoid heat buildup. When the power is turned on, the cooling fan will run. When the volume is increased, the cooling fan will run at high speed.

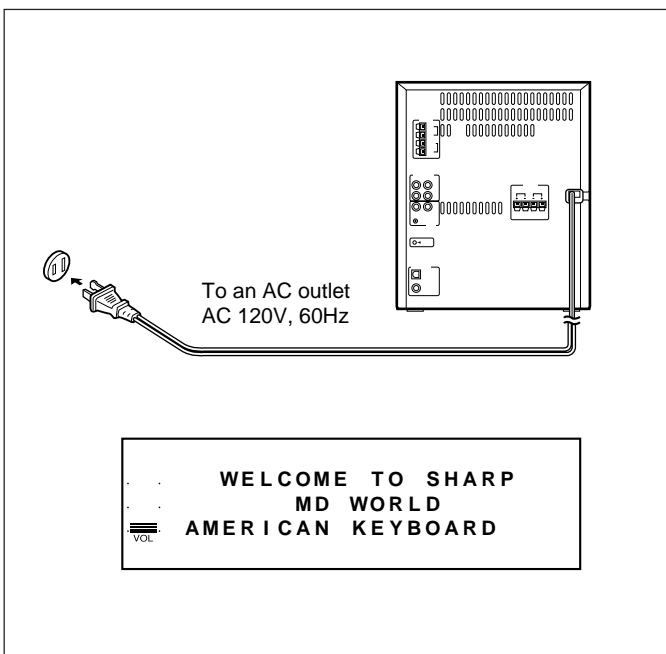

■ Connecting the AC power cord

- After connecting the speakers, plug the AC power cord into a convenient AC outlet. The LCD will present a demonstration display.
- Unplug the AC power cord from the AC outlet if the unit is not to be used for a prolonged period of time.

Note:

- If the lead wires of a speaker wire are short-circuited while connecting a speaker with the power on, the protection circuit will activate resulting in no sound. Disconnect the AC power cord from the AC outlet, and connect it again.

■ Demonstration display

- After the power cord is unplugged or a power failure occurs, when the power is turned back on, the LCD will present a demonstration display. If this happens, set the clock (see page 10) to cancel the demonstration display on the LCD.



(Continued)

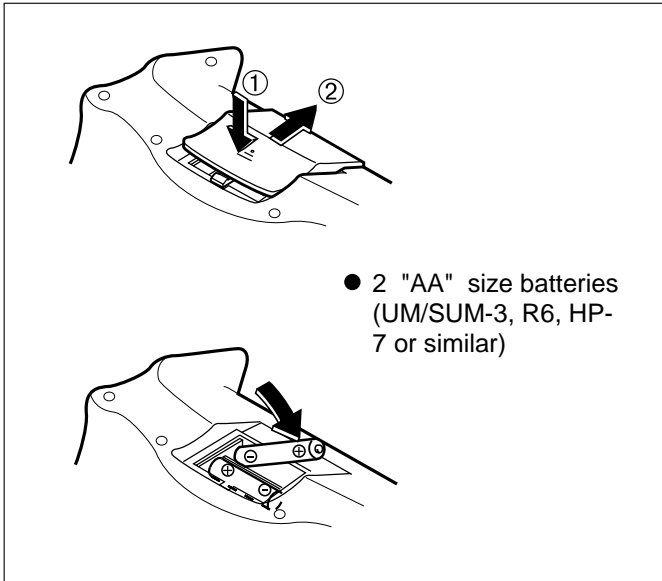

Remote control

- When inserting or removing the batteries, push them towards the ⊖ battery terminals.
- Installing the batteries incorrectly may cause the unit to malfunction.

Precautions for battery use:

- Insert the batteries according to the direction indicated in the battery compartment.
- Replace all old batteries with new ones at the same time.
- Do not mix old and new batteries.
- Remove the batteries if they are weak or if the unit is not in use for long periods to prevent potential damage due to battery leakage.

Caution:

Do not use rechargeable batteries (nickel-cadmium battery, etc.)

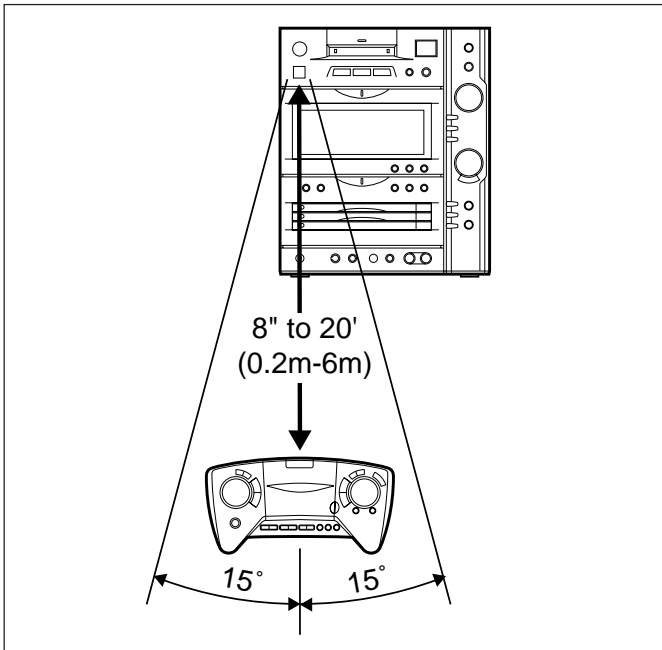

Notes concerning use:

- Replace the battery if control distance decreases or operation becomes erratic.
- Periodically clean the transmitter window on the remote control and the sensor on the main unit with a soft cloth.
- Exposing the sensor on the main unit to strong light may interfere with operation. Change the lighting or the direction of the unit.
- Keep the remote control away from moisture, excessive heat, shock, and vibrations.



DISPLAY SECTION

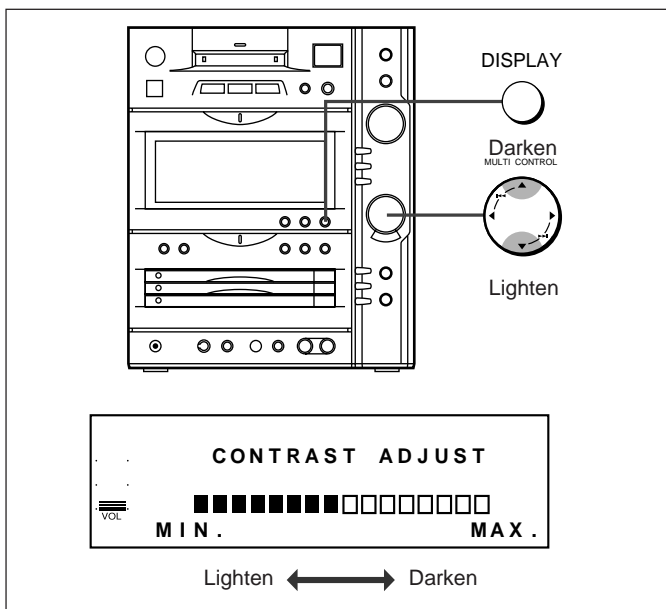

To change the contrast of the display

- 1 Turn the power on, and hold down the DISPLAY button for more than 0.5 seconds.
- 2 Press the MULTI CONTROL button to change the contrast.
 - The contrast is adjustable in 16 steps.
 - If no operation is performed for 10 seconds or more, the unit will return to the original screen.
 - If you operate your personal computer using a separately available sound card, you cannot adjust the contrast.

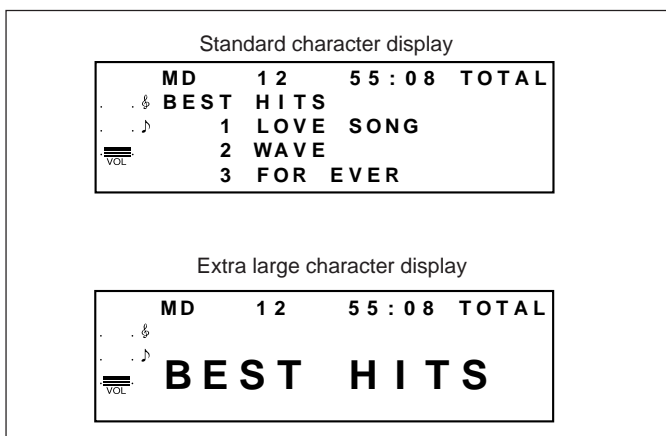

Character display

You can select a standard character display or an extra large character display for the display on this product.

- Standard character display
The default display mode set at the factory.
Track names are displayed on 4 lines so that you can check several track names at the same time.
- Extra large character display
When track names are displayed using extra large characters, you can read the names at a distance.

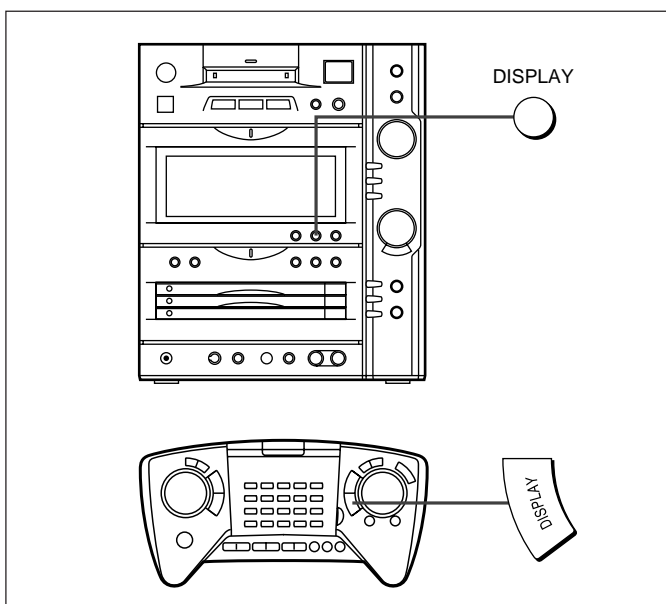

To change the size of the characters (extra large character display)

- Turn the power on while the MD is in the stop mode, and press the DISPLAY button.
- If the DISPLAY button is pressed again, the characters will return to their original size.



MULTI CONTROL BUTTON

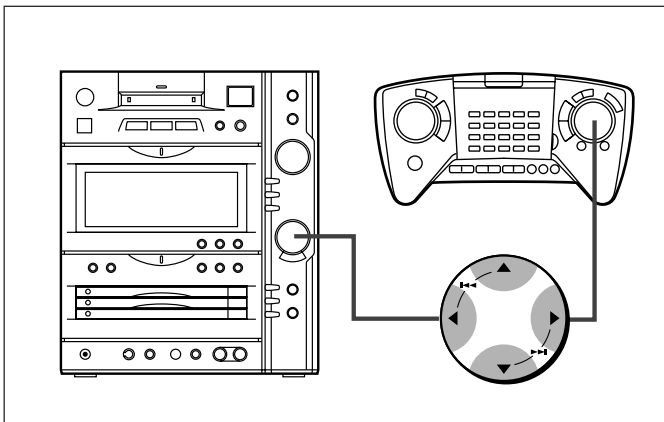

The MULTI CONTROL button is used to select CD or MD track numbers (page 22) , select programmed radio stations (page 21) and to enter characters (page 13) .

- The MULTI CONTROL button has different functions depending on the mode or the position you select.

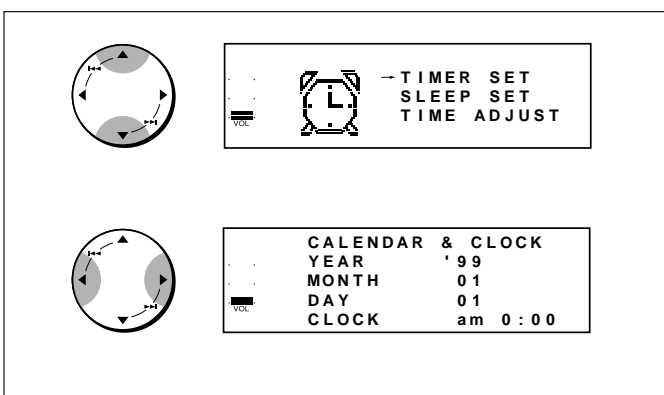

■ Menus for the timer and MD editing

- When you press the upper or lower position on the MULTI CONTROL button, you can scroll through the menus to select the one you want.
- When you press the left or right position on the MULTI CONTROL button while looking at the timer menu, you can select the value for each item.

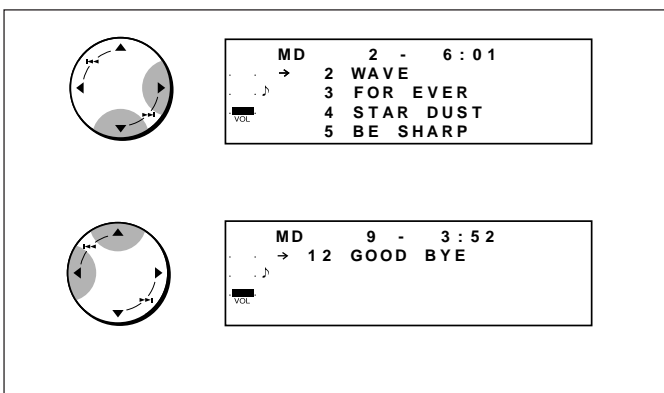

■ To select CD or MD track numbers

- When you press the right or lower position on the MULTI CONTROL button, the track number will be increased by one.
- When you press the left or upper position on the MULTI CONTROL button, the track number will be decreased by one.

SETTING THE CLOCK

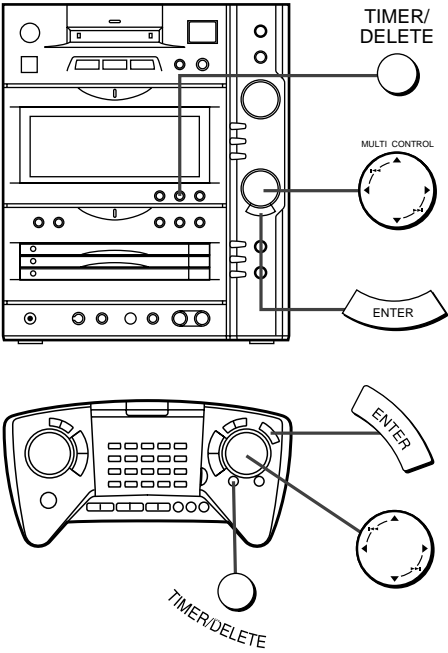

2

	+TIMER SET SLEEP SET TIME ADJUST
--	--

3

	TIMER SET SLEEP SET TIME ADJUST
--	---------------------------------------

4

CALENDAR & CLOCK	
YEAR	'98
MONTH	01
DAY	01
CLOCK	am 0:00

5

CALENDAR & CLOCK	
YEAR	'98
MONTH	01
DAY	01
CLOCK	am 0:00

6

CALENDAR & CLOCK	
YEAR	'98
MONTH	01
DAY	01
CLOCK	am 0:00

7

CALENDAR & CLOCK	
YEAR	'98
MONTH	01
DAY	01
CLOCK	am 0:00

8

CALENDAR & CLOCK	
YEAR	'98
MONTH	09
DAY	01
CLOCK	am 0:00

9

CALENDAR & CLOCK	
YEAR	'98
MONTH	09
DAY	27
CLOCK	am 0:00

10

CALENDAR & CLOCK	
YEAR	'98
MONTH	09
DAY	27
CLOCK	am 0:00

11

CALENDAR & CLOCK	
YEAR	'98
MONTH	09
DAY	27
CLOCK	am 9:00

12

CALENDAR & CLOCK	
YEAR	'98
MONTH	09
DAY	27
CLOCK	am 9:00

13

CALENDAR & CLOCK	
YEAR	'98
MONTH	09
DAY	27
CLOCK	am 9:35

14

MD NO DISC	

When you have set the date and time, this unit can be used as a clock. It can be used for timer recording or for timer playback. It is also used to store the MD recording date in memory.

- Turn the power on.
- Press the TIMER/DELETE button.
- Within 10 seconds, press the ▲ or ▼ on the MULTI CONTROL button to select TIME ADJUST.
 - The unit will enter the date setting mode.
- Within 10 seconds, press the ENTER button.
 - Press the button once to increase or decrease the year by one. Keep pressing it to advance continuously.
 - For any year after 2000, use "00" for 2000, "01" for 2001, and so on.
- Press the ◀ or ▶ on the MULTI CONTROL button to adjust the year.
- Press the ▼ on the MULTI CONTROL button to select the month.
- Press the ◀ or ▶ on the MULTI CONTROL button to adjust the month.
- Press the ▼ on the MULTI CONTROL button to select the day.
- Press the ◀ or ▶ on the MULTI CONTROL button to adjust the day.

- Press the ▼ on the MULTI CONTROL button to select the hour.
- Press the ◀ or ▶ on the MULTI CONTROL button to adjust the hour.
 - On the display, midnight is shown as "AM 12:00" and noon is shown as "PM 12:00". When setting the time, be careful to set AM or PM according to the current time.
- Press the ▼ on the MULTI CONTROL button to select the minute.
- Press the ◀ or ▶ on the MULTI CONTROL button to adjust the minute.
- Press the ENTER button to start the clock at the top of the minute.
 - The clock starts operating.

Notes:

- In the event of a power failure or when the AC power cord is disconnected, the clock setting will be lost. Reset the time.
- While recording an MD, you cannot set the date and clock. Be sure to set the date and clock before recording.
- The range of dates that can be entered is from July 1, 1997 to December 31, 2049.

To change the setting

- After performing steps 1 - 4 above,
 - Press the ▲ or ▼ on the MULTI CONTROL button to select the item (YEAR, MONTH, DAY or CLOCK) you want to change.
 - Press the ◀ or ▶ on the MULTI CONTROL button to change the setting.
 - Press the ENTER button.

To check the time

When the power is off, the time appears on the display. When the power is on and you press the TIMER/DELETE button, the time will appear for about 10 seconds on the display.

- The year, month and day will not be displayed.

SOUND CONTROL

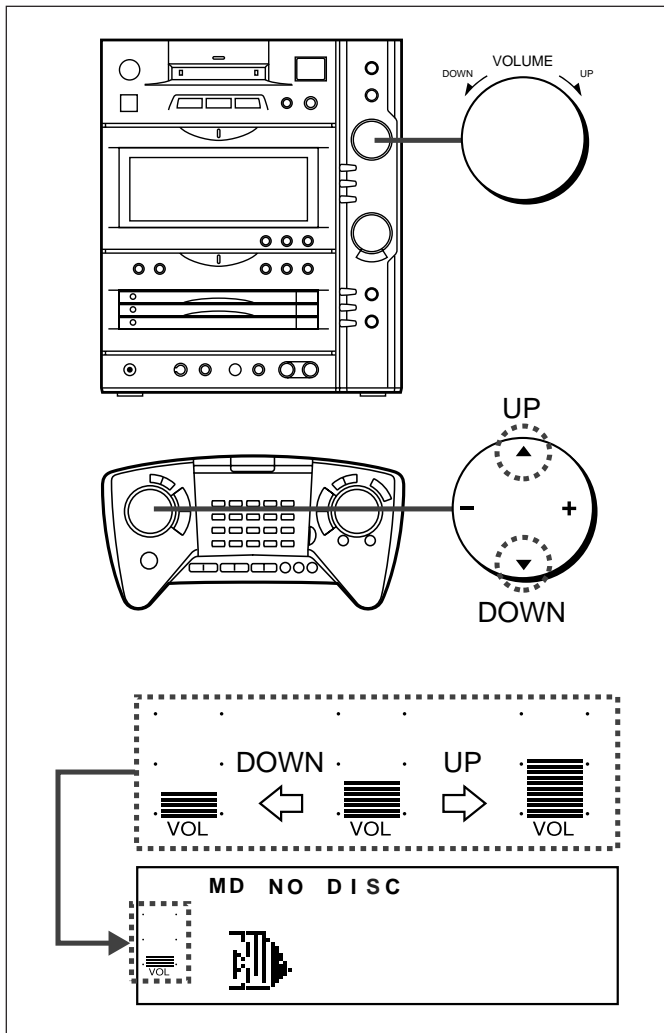

Volume

Main unit operation

When you turn the VOLUME control toward the UP position, the volume will increase. When you turn it toward the DOWN position, the volume will decrease.

Remote control operation

When you press the ▲ position on the VOLUME/3D SURROUND button, the volume will increase. When you press the ▼ position on the VOLUME/3D SURROUND button, it will decrease.

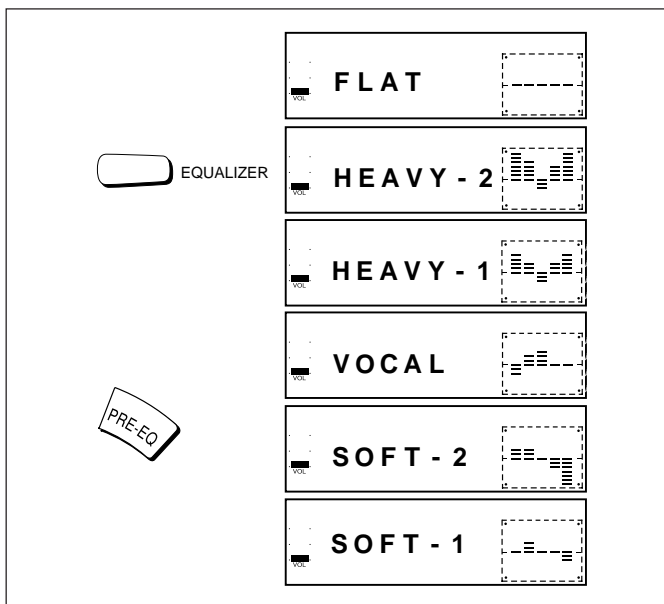

Pre-programmed equalizer

When the EQUALIZER (PRE-EQ) button is pressed, the current mode setting will be displayed. To change to a different mode, press the EQUALIZER (PRE-EQ) button repeatedly.

- FLAT : The sound is not modified.
- HEAVY-2 : Bass and treble are emphasized a lot.
- HEAVY-1 : Bass and treble are slightly emphasized.
- VOCAL : Vocals (midrange tones) are emphasized.
- SOFT-2 : Treble is reduced a lot.
- SOFT-1 : Treble is cut a little.

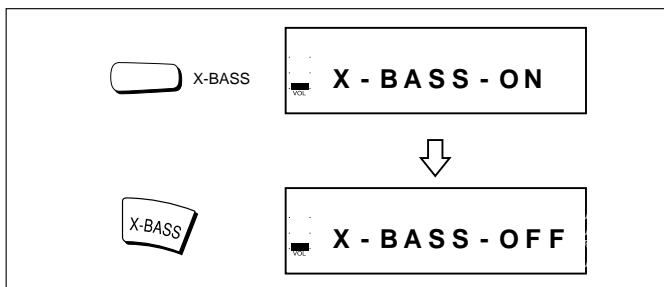

Extra bass (X-BASS)

Press the X-BASS button to emphasize the bass region of the frequency spectrum. "X-BASS ON" will appear. Press the X-BASS button again to cancel the extra bass mode. "X-BASS OFF" will appear.



(Continued)

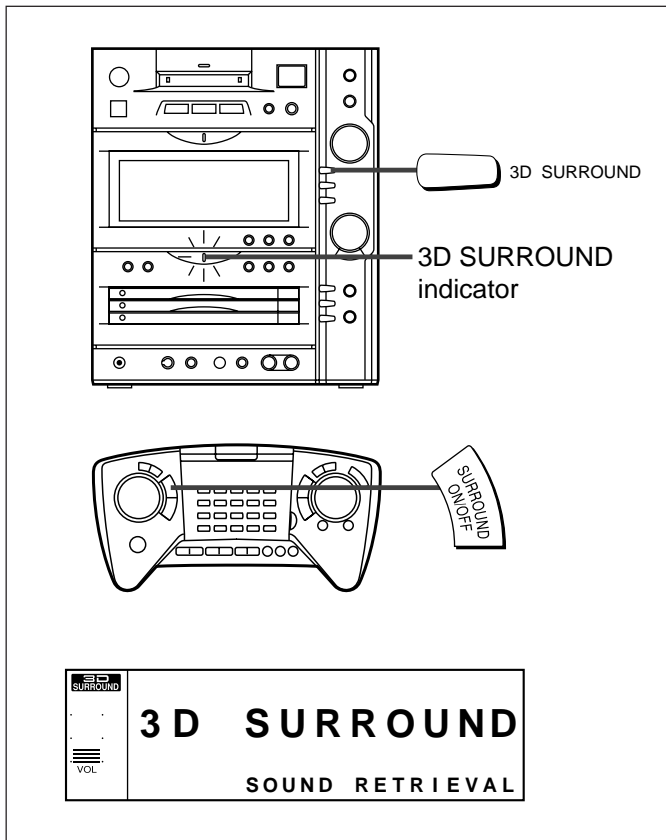

■ SRS (●) 3D SURROUND

About SRS (●) 3D surround:

SRS is a breakthrough technology that creates 3-dimensional sound by processing sound signals based on the human auditory system. It produces real depth and localization of the sound image which cannot be accomplished by ordinary stereo. SRS only requires two speakers.

- You can also adjust the sense of width or the sense of depth.

When the 3D SURROUND button on the main unit, or the SURROUND ON/OFF button on the remote control is pressed, the 3D SURROUND indicator will light and "3D SURROUND" will be displayed on the LCD. When the button is pressed again, the 3D surround mode will be canceled.

■ Adjusting the sense of width or depth

Remote control operation

1 Press the WIDE/CENTER button in the 3D surround mode to select "WIDE" or "CENTER".

2 When WIDE is selected:

When the + side on the VOLUME/3D SURROUND button is pressed, the sound will grow wider. When the - side on the VOLUME/3D SURROUND button is pressed, the sound width will be reduced.

- By adjusting the WIDE level, the apparent distance between the left and the right speakers will seem to change. (The wider the setting, the more distance there will seem to be between the speakers.)

When CENTER is selected:

When the + side on the VOLUME/3D SURROUND button is pressed, the sense of depth will increase. When the - side on the VOLUME/3D SURROUND button is pressed, the sense of depth will decrease.

- By adjusting the CENTER level, the sense of depth will change. (The higher the center level, the greater the sense of depth.)

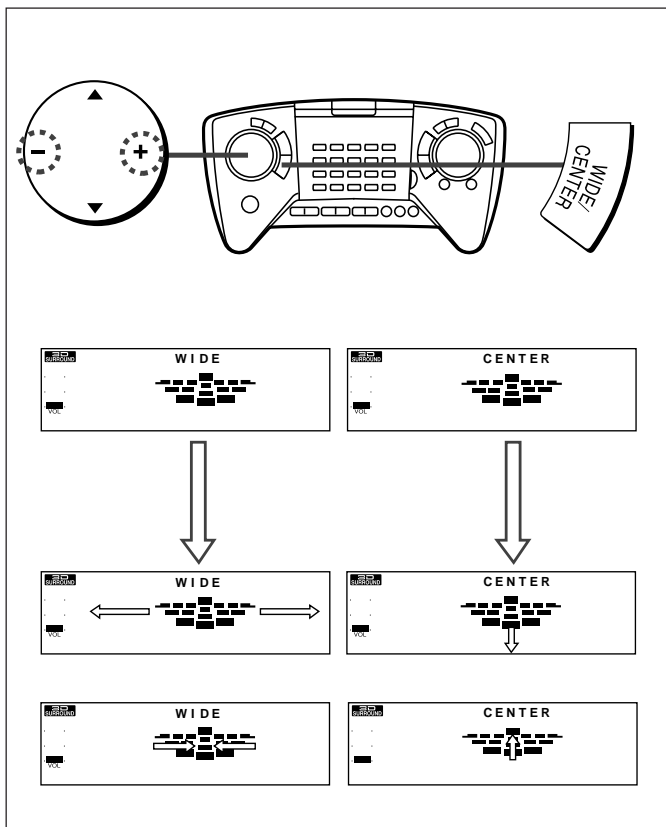



HOW TO ENTER CHARACTERS

MD disc names or track names(pages 36 and 37)

	MD	12	55:08	TOTAL
	BEST HITS			
	1	LOVE SONG		
	2	WAVE		
	3	FOR EVER		

Radio station names (page 21)

	FM ST	87.6	MHz
	→ P01	0000	
	P02	000	
	P03	00000	
	P04	0000	

Message displayed when the power is on or off (pages 49-51)

HAPPY BIRT			
-------------------	--	--	--

■ Entering characters

Characters are used for the MD disc names and track names, radio station names, and messages displayed when the power is on or off.

Standard character display

	▶	◀
	ABCDEFGHIJKLM123+-/=	◀
	NOPQRSTUVWXYZ456! ?&%\$	
	abcdefghijklmnop789' " () @	
	nopqrstuvwxyz*0# , . ; : _	

Extra large character display

	ABCDEFGHIJ									

Characters can be entered in the standard character size or the extra large character size. (The method for entering characters depends on the size.)

- Radio station names cannot be entered as extra large characters.



(Continued)

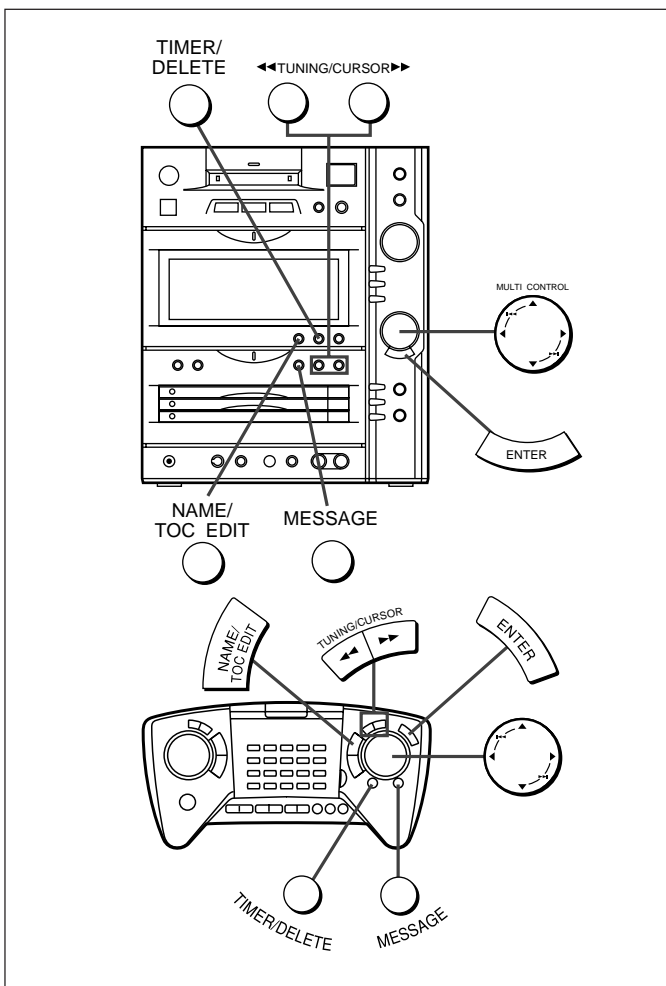

■ Entering standard size characters

Preparation

Put the unit in the mode in which characters can be entered.

- To store radio station names in memory, perform steps 1 - 3 on page 21.
- To create a disc name on an MD, perform steps 1 - 3 on page 36.
- To change the messages displayed when the power is turned on or off, perform steps 1 - 3 on page 49 or on page 51.

1 Press the ▲, ▼, ◀ or ▶ on the MULTI CONTROL button to make the character you want to enter start flashing.

- Each time the button is pressed, the character which is flashing will be changed by one in the direction printed on the button. When the button is held down, the selection will move continuously in that direction.

- To enter a space, make the _ symbol flash.

2 Press the ENTER button.

- The selected character will appear in the character entry column. Then, perform steps 1 - 2 repeatedly to enter the other characters you need.

3 After entering all the characters

For a radio station name, MD disc name, or MD track name:

Press the NAME/TOC EDIT button.

For the messages displayed when the power is turned on or off:

Press the MESSAGE button.

- The characters will be stored in memory.

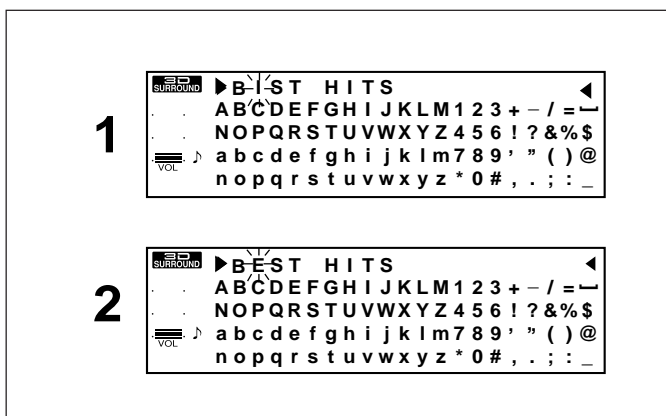
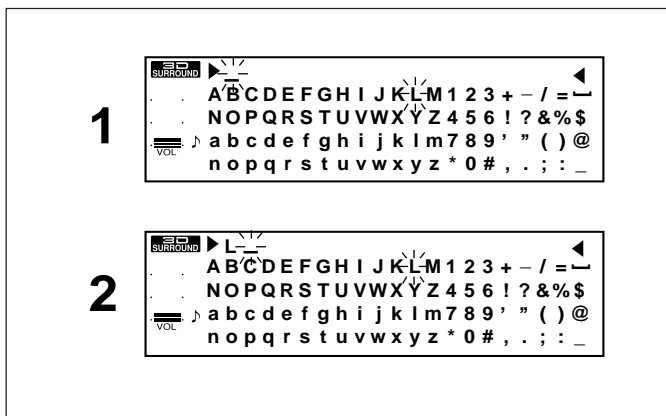

■ To correct, add, or delete a character

1 Press the ◀◀ TUNING/CURSOR ▶▶ button to move to the position of the character you want to delete, correct, or add. It will flash when selected.

2 When you want to delete or correct a character:

Press the TIMER/DELETE button.

- The character will be erased.
- If you want to correct a character, then, enter the correct character.

When you want to add a character:

Press the MULTI CONTROL button to select the position where you want to add a character, select the new character and then press the ENTER button.

3 Finally, perform step 3 above.



(Continued)

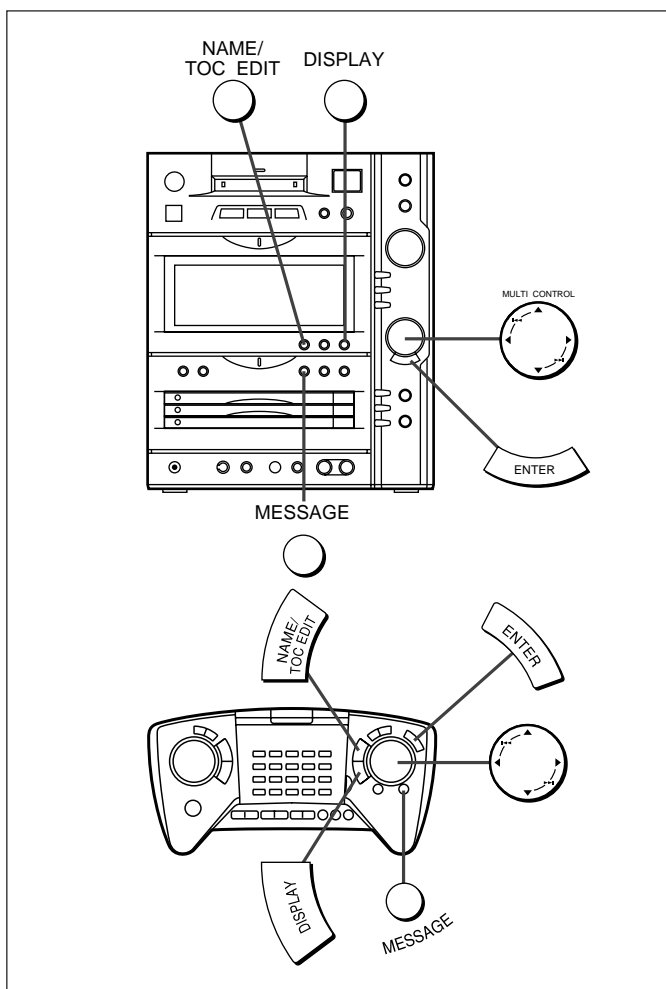

■ Entering extra large characters

In the case of the extra large characters, the characters you can choose from are as follows:



Each time the DISPLAY button is pressed, the character type will change.

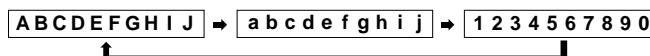

Each time the ▲ or ▼ on the MULTI CONTROL button is pressed, a different series of characters will appear.

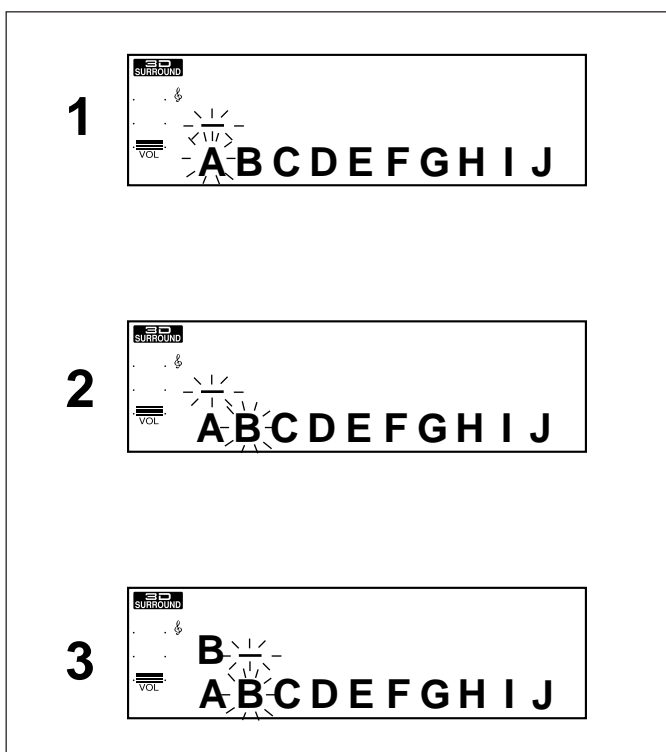
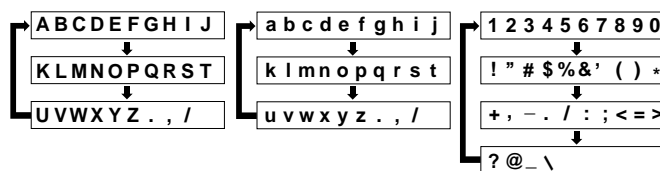

Preparation

Put the unit in the mode in which characters can be entered.

- To create an MD disc name, perform steps 1 - 3 of the "To create a disc name" section on page 36.
- To create an MD track name, perform steps 1 - 2 of the "To create a track name" section on page 36.
- To change the messages displayed when the power is turned on or off, perform steps 1 - 3 on page 49 or on page 51.

1 Press the DISPLAY button to select the type of character you want to enter.

- Each time the button is pressed, the type of character will change.

2 Press the ◀ or ▶ on the MULTI CONTROL button to move the cursor to the character you want to enter.

3 Press the ENTER button.

4 Perform steps 1 - 3 repeatedly to enter the characters you need.

5 After entering all the characters

For a radio station name, MD disc name, or MD track name:

Press the NAME/TOC EDIT button.

For the messages displayed when the power is turned on or off:

Press the MESSAGE button.

- The characters will be stored in memory.



(Continued)

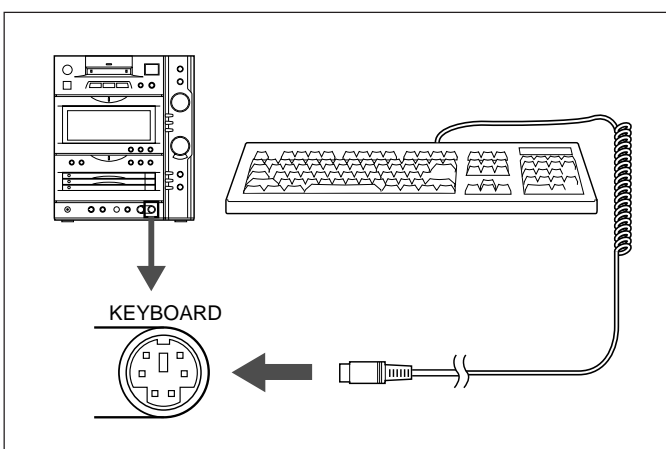
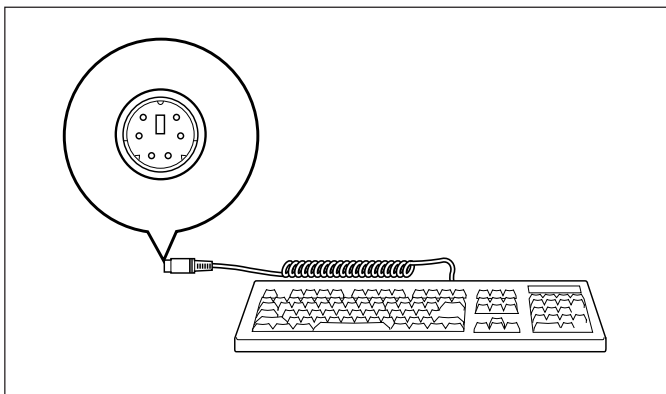

To enter characters from a computer keyboard

You can enter characters by connecting a keyboard.

Keyboard you can use:

You can use any keyboard which can be connected to a Windows personal computer and has the plug shape shown to the left. (Macintosh keyboards cannot be used.)

- You must use a DC 5V keyboard(maximum 300 mA).

- 1 When the power to the main unit is off, connect a keyboard to the KEYBOARD terminal.
- 2 Turn the power to the main unit on.
- 3 Put the unit in the mode which characters can be entered.
 - To store radio station names in memory:
Perform steps 1 - 3 on page 21.
 - To create a disc name on an MD:
Perform steps 1 - 3 of the "To create a disc name" section on page 36.
 - To create a track name on a MD:
Perform steps 1 - 2 of the "To create a track name" section on page 36.
 - To change the messages displayed when the power is turned on or off:
Perform steps 1 - 3 on page 49 or on page 51.
- 4 Enter the characters from the keyboard.

Note:

Do not plug in or unplug the keyboard plug while the power is on, as this may lead to damage.

Keys you can use

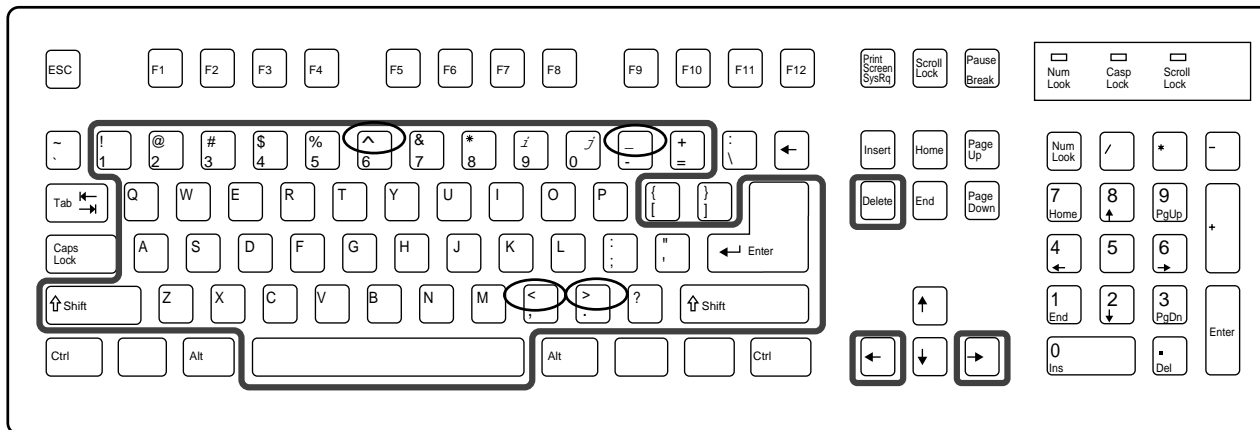

Characters shown with the mark cannot be entered.

How to enter lower-case or upper-case letters:

Normally, lower-case letters are entered. Hold down the Shift key and press any letter key. An upper-case letter will be entered.

Space key:

Enters a space and moves the cursor one character to the right.

Delete key:

This key has the same function as the TIMER/DELETE button on the main unit. The letter under the cursor will be erased, and the letters to the right will move one character to the left.

Enter key:

This key has the same function as the NAME/TOC EDIT button on the main unit. However, although the letters you enter can be checked after they are entered, the unit cannot be put in the stand-by state for entering letters.

< key:

This key has the same function as the ◀◀ button on the main unit. The cursor will move one character to the left.

> key:

This key has the same function as the ▶▶ button on the main unit. The cursor will move one character to the right.

The other keys on the keyboard are disabled.



COMPACT DISC OPERATION

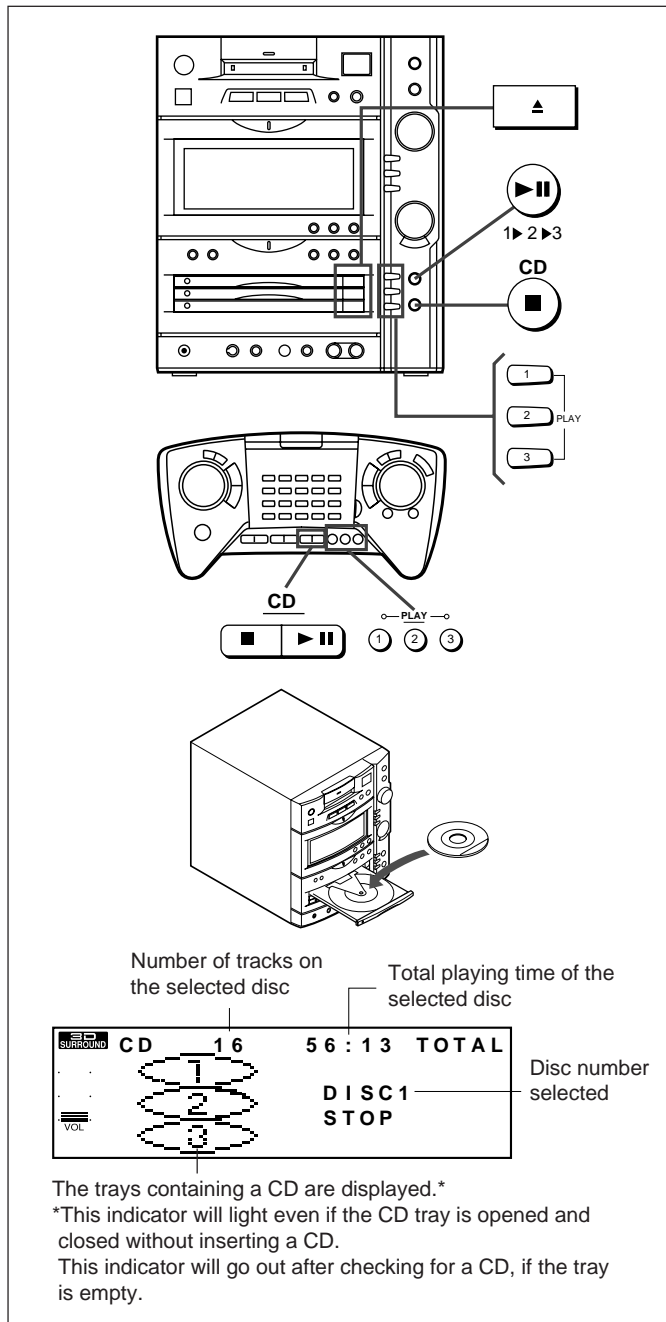

■ Loading and playing CD

- 1** Press the CD ■ button.
 - The power will be turned on automatically, and the unit will enter the CD playback mode.
- 2** Press the ▲ button to open the disc tray.
 - It is impossible to open multiple disc trays at a time.
- 3** Place the CD (s) on the disc tray, with the labeled side facing up.
 - Be sure to place 8 cm (3") CDs in the middle of the disc holders.
- Caution:**
 Do not stack CDs in the tray.
 This can damage the player and the CDs.
- 4** Press the ▲ button to close the disc tray.
 - The total number of tracks and the total disc playing time will be displayed.
- 5** Press the CD ►|| button.
 - Playback will begin from track 1 on DISC -1.
 - DISC-1, DISC-2 and DISC-3 will be played continuously in that order.
 - If you press the CD PLAY 2 button after pressing the CD ►|| button, DISC-2 and DISC-3 will be played continuously.
 - If you press the CD PLAY 3 button after pressing the CD ►|| button, only DISC-3 will be played.
 - When all of the tracks on the CDs completed playing, it stops automatically.
 - After the disc finishes playing, the next disc will be automatically played.
 - When there is no CD in one of the disc trays, that tray will be skipped, and the next CD will be played.

Direct playback:

When a CD is loaded in the disc tray, simply pressing any of the CD ►|| button or one of the CD PLAY buttons (1-3) on the main unit or on the remote control will turn the power on and start playback.

Note:

- If the disc tray is open when you press one of these buttons, it will close automatically.

To interrupt playback:

Press the CD ►|| button.
 Press the CD ►|| button to resume playback from the same point.

To stop playback:

Press the CD ■ button.

To remove the CDs:

While in the stop mode, press the ▲ button.

To switch the unit off after use:

Press the POWER button to turn the power off.

To play a specific CD:

Press the button number for the CD you want from the CD PLAY buttons (1-3) on the main unit or on the remote control.

- Only the selected CD will be played.

Note:

- If you press the CD ►|| button on the main unit or remote control even though you have selected DISC-2 or DISC-3 previously, continuous playback will start from the track 1 on DISC-1.



(Continued)

Cautions:

- Do not carry the unit with a disc left in a disc tray. The disc may come loose inside the unit and be damaged or cause damage to the unit. This may also cause malfunctions.
- If you press the CD ►|| button, one of the CD PLAY buttons (1-3) on the main unit or remote control, or any of the CD ▲ buttons while the disc tray is open, the disc tray will close automatically. Therefore, be careful not to get your fingers caught in the disc tray.
- Do not place two CDs in one disc position.
- Do not push the disc tray while it is moving.
- If the power fails while the tray is open, wait until the power is restored before trying to close it.
- If the disc tray is stopped forcibly, "ERROR" will appear on the display and the unit will not function. If this occurs, turn the power off, and turn it on again.

- If TV or radio interference occurs during CD operation, move the unit away from the TV or radio.
- If the disc is damaged, dirty, or loaded upside down, the disc will be skipped and the next disc will be automatically played.
- If the main unit is subjected to a sharp jolt or it is used where vibrations are present, sound dropouts may occur. Use the unit in a stable environment.
- If the volume is set to too high, a dropout may occur due to vibrations from the speakers. If this happens, move the main unit away from the speakers or turn down the volume.
- Do not use CDs with loose cellphone tape or stickers or CDs which have glue left on the surface from tape or stickers. If such a CD is inserted, you may not be able to remove the CD or the unit may cause malfunction.

MINIDISC OPERATION

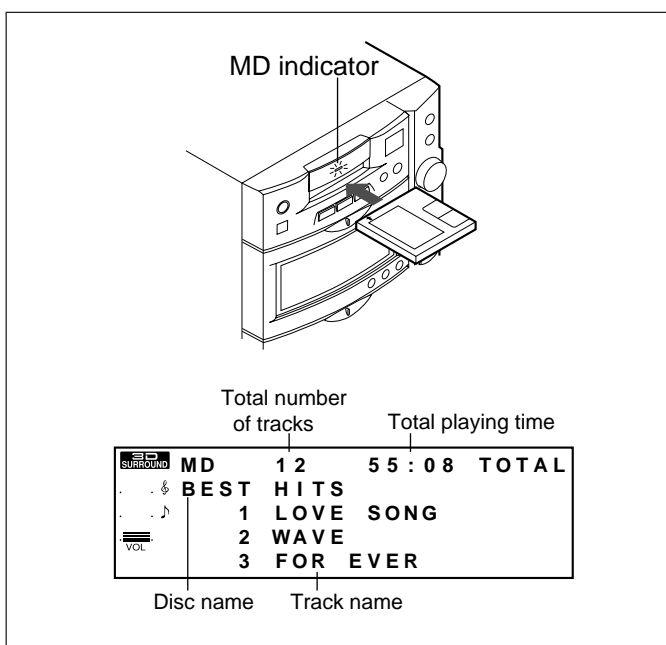
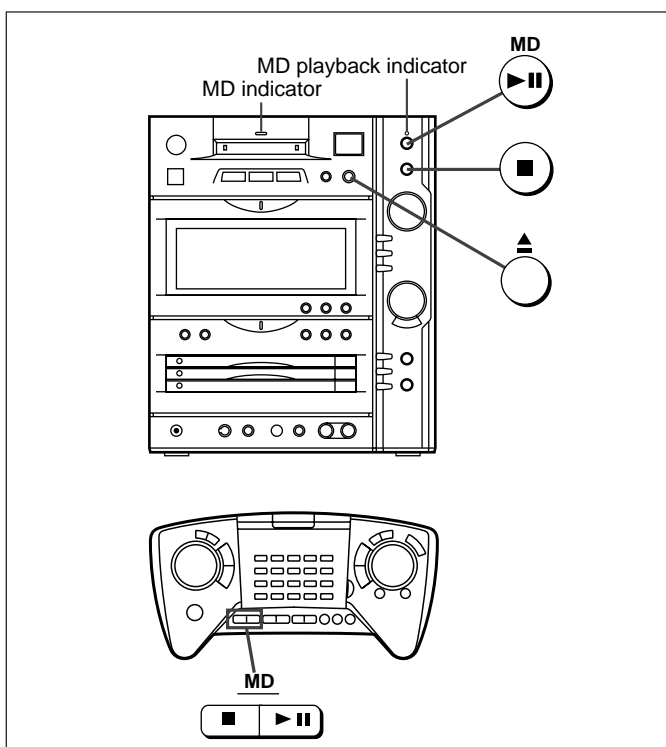

Loading and playing MiniDiscs

- 1 Press the MD ■ button.
 - The power will be turned on automatically, and the unit will enter the MD playback mode.
- 2 Load a recorded MiniDisc in the direction indicated by the arrow on the MiniDisc, with the labeled side facing up.
 - The total number of tracks and the total disc playing time will be displayed. At this time, the MD indicator will light.
- 3 Press the MD ►|| button.
 - The MD playback indicator will light and playback will begin from track 1 on the disc you have specified.
 - When the last track has been played back, this unit will stop automatically.

To interrupt playback:

Press the MD ►|| button.

- The MD playback indicator will flash.
- Press the MD ►|| button to resume playback from the same point.

To stop playback

Press the MD ■ button.

To remove a MiniDisc:

Press the ▲ button.

- The MiniDisc will be ejected.

Notes:

- Although vibration will not normally cause a MiniDisc to skip, you may hear a skip in the sound if there is continuous vibration.
- When you listen to MiniDiscs near a radio or a TV set, the radio or the TV set may pick up noise. Keep the unit as far away as possible from tuners.
- When an optionally available sound card is used, an MD inserted in this product can be played from a personal computer.

Direct playback

If a MiniDisc is loaded in the unit, pressing the MD ►|| button turns the power on, and begins playback.

After use:

Press the POWER button to turn the power off.

Note:

- The power cannot be turned off while reading the information on a MiniDisc.
- If no disc and track names have been recorded on a MiniDisc, they will not appear on the display.

RADIO OPERATION

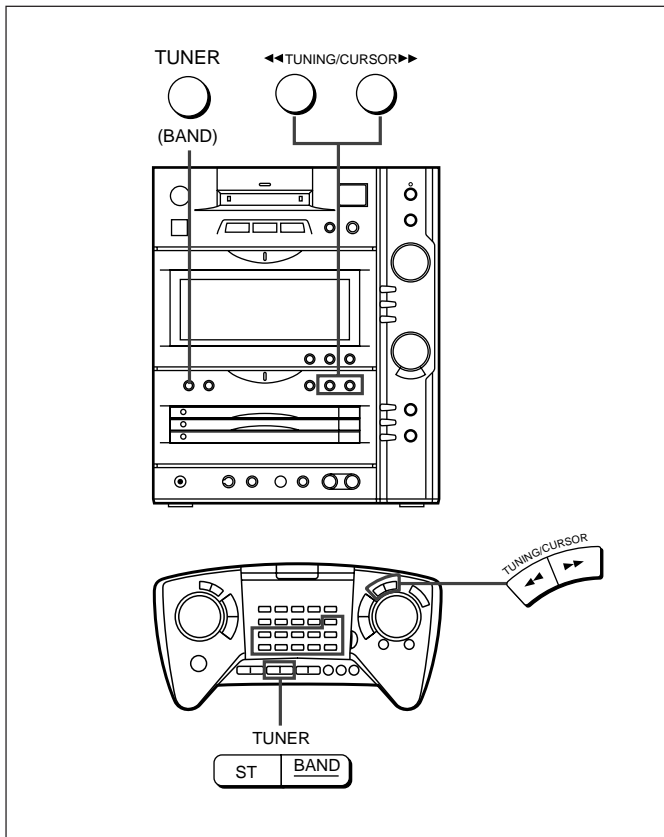

Tuning

- 1 Press the TUNER (BAND) button.
 - The power is turned on, and the tuner is selected.
- 2 Press the TUNER (BAND) button to select the desired frequency band (FM or AM) .
- 3 Tune in to the desired station using the ◀◀ TUNING/CURSOR ▶▶ button.

Auto tuning:

When the ◀◀ TUNING/CURSOR ▶▶ button is pressed for more than 0.5 seconds and then released, the tuning stops at the first receivable broadcast station.

Notes:

- When radio interference occurs during auto tuning, auto tuning may stop automatically at that point.
- If a weak station signal is found during auto tuning, the station will be skipped.
- To stop auto tuning, press the ◀◀ TUNING/CURSOR ▶▶ button again.

Manual tuning:

Press the ◀◀ TUNING/CURSOR ▶▶ button as many times as necessary to adjust the frequency display to the frequency of the desired station.

- 4 To receive FM stereo, press the ST button on the remote control so that the "FM ST" indicator appears.
 - "∞" will appear when an FM broadcast is in stereo.
- 5 If the FM stereo reception is weak, press the ST button so that the "FM ST" indicator goes out.
 - Although the reception changes to monaural, the sound becomes clearer.

After use:

Press the POWER button to turn the power off.

Direct playback:

Just pressing the TUNER (BAND) button will turn on the power automatically. The radio station you were listening to last will be tuned in.

Notes:

- The memory recalls the last station received even after changing the TUNER (BAND) button or function selector buttons, or pressing the POWER button to turn the power off.
- If you are listening to the radio near personal computers, radios, or TV sets, various noise or interference may be heard. Keep this unit as far away as possible from these products.

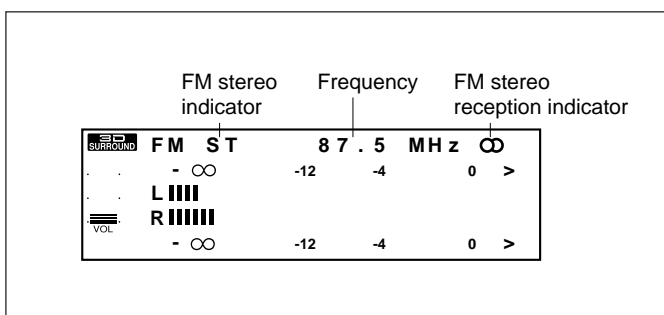

(Continued)

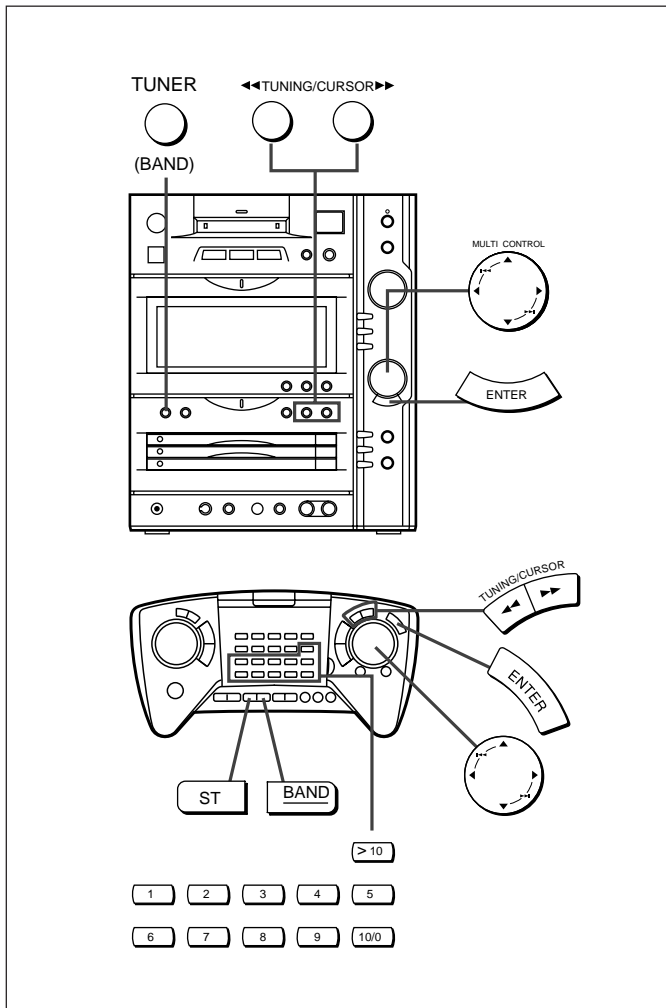

■ Preset tuning

You can store up to 40 stations in memory (40 stations consisting of any combination of the FM and AM stations you like) and recall them at the push of the button.

- 1 Perform steps 1-5 of the "Tuning" section.
 - 2 To receive FM stereo, press the ST button so that the "FM ST" indicator on the display lights up for FM stereo reception, then press the ENTER button.
 - 3 Within 10 seconds, select the desired preset number with the MULTI CONTROL button.
 - 4 Within 10 seconds, press the ENTER button.
 - 5 Repeat steps 1-4 to preset the other stations, or to change a preset station.
- When a new station is stored in a preset number location, the previous contents of that location will be erased.

Note:

- After a prolonged power failure, the contents of the memory will be lost. When power is restored, enter your selections in memory again. (For power failures of just a few hours or less, the contents of memory will not be lost.)

■ To recall a preset station

Press the direct button on the remote control or MULTI CONTROL button to recall the preset channel number.

- The contents (preset channel number, frequency and frequency band) which have been stored in memory will appear in the display, irrespective of the frequency bands.
- If there are no stations memorized, this operation can not be performed.

To select preset numbers 11 to 40 using the remote control

Press the >10 button first, then press the number.

For example to select 35:

- ① Press the >10 button.
- ② Within 5 seconds, press the "3" button.
- ③ Within 5 seconds, press the "5" button.

Note:

- You can create names for radio stations that have been stored in memory. (Page 21)

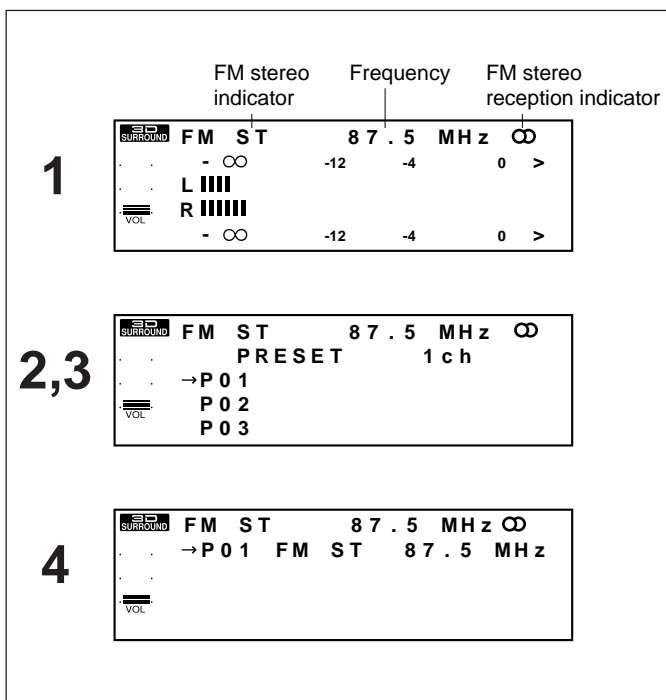



PROGRAMMING RADIO STATION NAMES

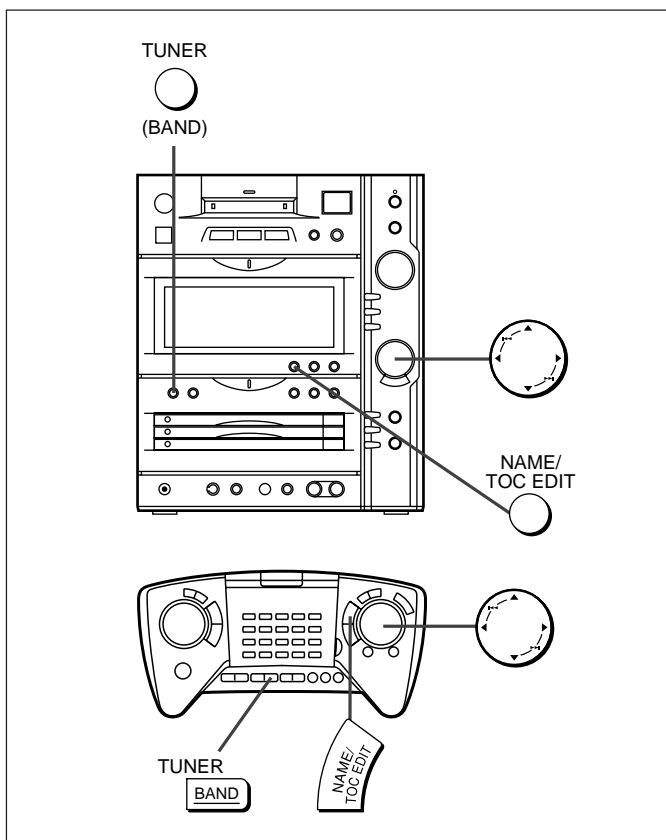

You can create names for radio stations that have been stored in memory (up to 16 characters).

- 1 Press the TUNER (BAND) button.
- 2 Press the ▲ or ▼ on the MULTI CONTROL button to select the location number you want to create a name for.
 - Names cannot be created for locations that do not have a radio station stored in them.
- 3 Press the NAME/TOC EDIT button.
- 4 Enter a radio station name.
 - For details about entering characters, see pages 13-16.
- 5 Then, press the NAME/TOC EDIT button.

If you make a mistake while entering a radio station name:

- Perform steps 1 - 4 above, and then correct the character (s) you entered by mistake. For details about how to make corrections, see pages 13-16.

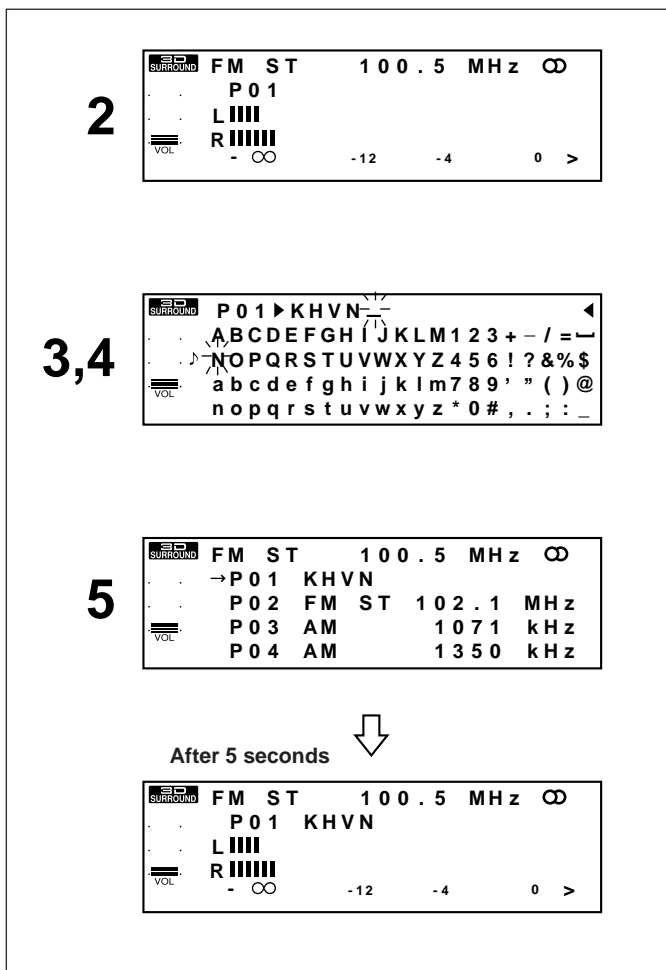



VARIOUS CD AND MD OPERATIONS

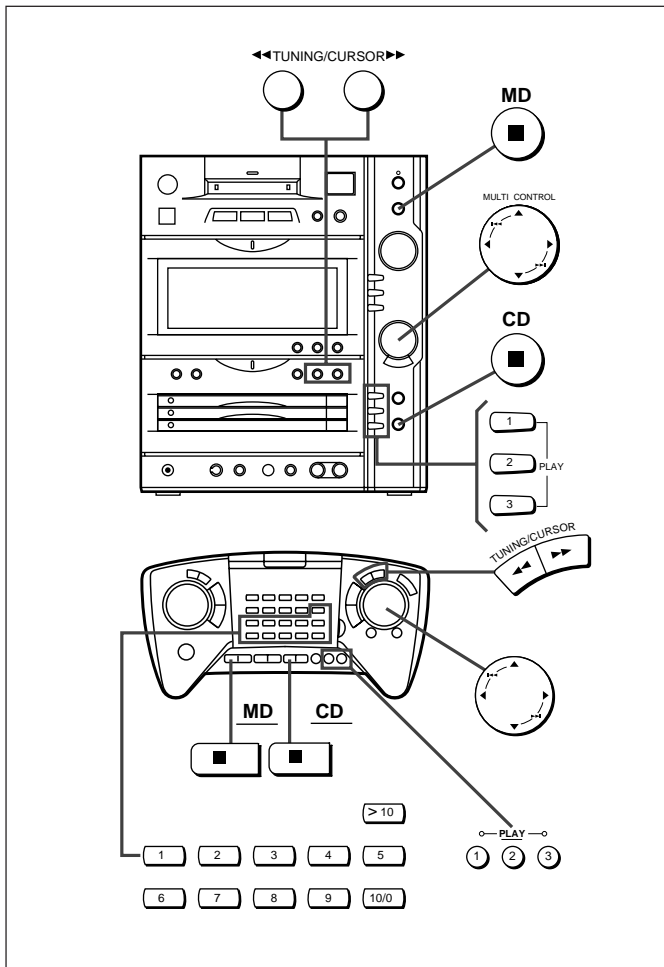

Direct-selection play

By using the track number input buttons on the remote control, you can play any track directly, by entering its number.

- 1 Select the disc to be played by pressing one of the CD PLAY buttons (1-3). (Only for CD playback)
- 2 Select the desired program source, CD or MD, by pressing the CD ■ or MD ■ button.
- 3 Use the track number input buttons to select the desired track number.

A. To select track numbers 11 to 99

Press the >10 button first, then press the track number.
For example to select 28:

- 1 Press the >10 button.
- 2 Within 5 seconds, press the "2" button.
- 3 Within 5 seconds, press the "8" button.

B. To select track number 100 or higher (only for MD)

Press the >10 button twice, then press the track number.
For example to select 105:

- 1 Press the >10 button.
- 2 Within 5 seconds, press the >10 button.
- 3 Within 5 seconds, press the "1" button.
- 4 Within 5 seconds, press the "10/0" button.
- 5 Within 5 seconds, press the "5" button.

The beginning of the selected track will be found, and play will begin automatically.

Notes:

- A track number higher than the number of tracks on the disc cannot be selected.
- During APMS play or random play, track number selection play is not possible.

Cue and review

- 1 Load a disc and begin playback.
- 2 Hold down the ►► button for audible fast forward, and hold down the ◀◀ button for audible fast reverse.
- 3 Normal playback will resume when the ►► or ◀◀ button is released.

Notes:

- If the end of the disc is reached while cueing, "DISC END" will appear, and operation will pause. Press the CD ■ or MD ■ button to stop operation. When you want to listen to the disc again, press the ◀◀ button to locate the desired track. Normal playback will start from that point.
- When the beginning of the first track is reached, normal playback will start.

To search very quickly

When fast forward or fast reverse is used while in the pause mode, the playback point will move more quickly than when using audible fast forward or audible fast reverse in the playback mode.

- In this mode, no sound is heard. Therefore, you must refer to the time display.
- When you lift your finger, the unit will re-enter the pause mode.

APSS (Auto Program Search System)

APSS automatically locates the beginning of each track.

To move to the beginning of the next track:

During playback ... Press ► on the MULTI CONTROL button.

To restart the track being played:

During playback ... Press ◀ on the MULTI CONTROL button.

When using the MULTI CONTROL button while in the stop mode:

Each time the ◀ or ► on the MULTI CONTROL button is pressed, the track number will go up or down by one. If you press the ►|| button, playback will begin from the track being displayed.



(Continued)

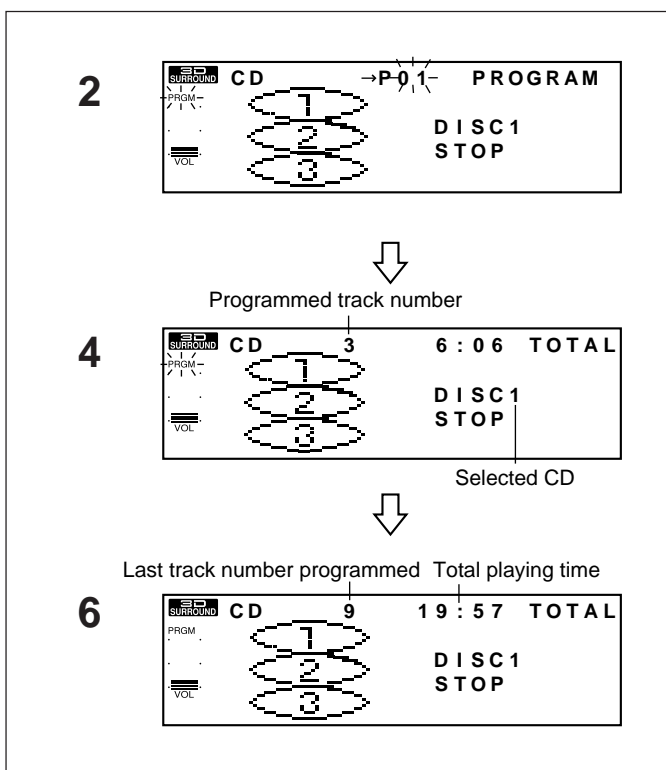
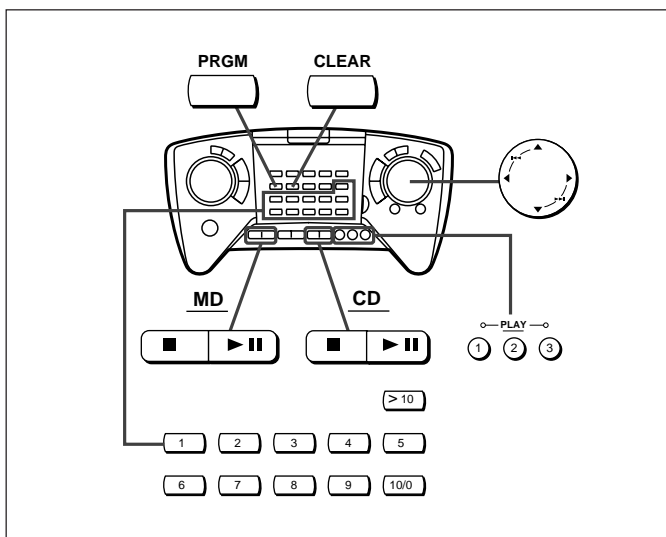

[To program selections with the main unit (for CDs only)]

- ① Press the CD ■ button.
- ② Press the TRACK button for at least 2 seconds.
- ③ Press the CD PLAY buttons (1-3) to select the disc to be played.
- ④ Select the track number you want using the MULTI CONTROL button.
- ⑤ Press the TRACK button.
- ⑥ Repeat steps 3-5 for any other tracks.
- ⑦ Press the CD ■ button.
- ⑧ Press the CD ►|| button to start playback of the programmed selections.

**■ APMS
(Automatic Programmable Music Selector)**

Remote control operation

- 1 Select the desired program source, CD or MD, by pressing the CD ■ or MD ■ button.
- 2 Press the PRGM button.
 - "PRGM" will flash.
- 3 If you have selected CD, press one of the CD PLAY buttons (1-3) to select the disc to be played.
- 4 Use the track number input buttons to designate the desired track number.
- 5 Repeat steps 3-4 for any other tracks. Up to 20 tracks for MD or 32 tracks for CD can be programmed.
 - To select the track on an MD or on the same CD, skip step 3.
 - The last track number programmed and the total playing time of the programmed tracks will be displayed automatically.
 - If the total playing time of the programmed tracks on a CD exceeds 999 minutes 59 seconds or that on an MD exceeds 255 minutes 59 seconds, "--:--" will be displayed. In such a case, the programmed tracks are stored.
- 6 Press the CD ■ or MD ■ button.
- 7 Press the CD ►|| or MD ►|| button to start playback of the programmed selections.
 - After all of the programmed tracks have finished playback, the unit will automatically stop.

To add tracks to the APMS:

When a program has been entered ("PRGM" is flashing), perform step 2. Additional tracks can be selected, and they will be stored after the last track you entered.

To clear the programmed selections:

Press the CLEAR button while "PRGM" is flashing.

- Each time the button is pressed, one track will be cleared, beginning with the last track programmed.

To cancel the APMS:

While the unit is stopped in the APMS mode, press the CLEAR button.

- The program contents will be erased.
- When you open the disc tray or a MiniDisc is removed, the APMS mode will be canceled.

To check which tracks are programmed:

While the unit is stopped in the APMS mode, press the ▼ or ▲ on the MULTI CONTROL button.

- When the ▼ on the MULTI CONTROL button is pressed, the next track number will appear. When ▲ is pressed, the previous track number will appear.

Notes:

- It is not possible to insert an additional track between programmed tracks that have already been entered.
- Programming and canceling are not possible during playback or in the pause mode.

[To record a set of programmed tracks]

- ① Press the CD ■ button.
- ② Load a recordable MiniDisc.
- ③ Press the REC● button.
- ④ Press the CD ►|| button.
 - The programmed tracks will be recorded in order. When the last track is recorded, the unit will stop automatically.



(Continued)

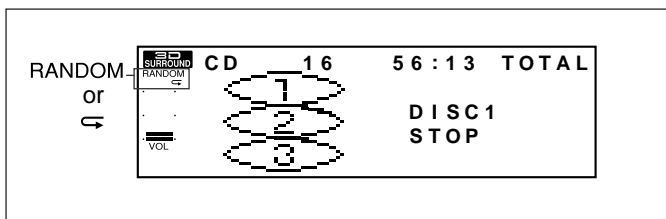
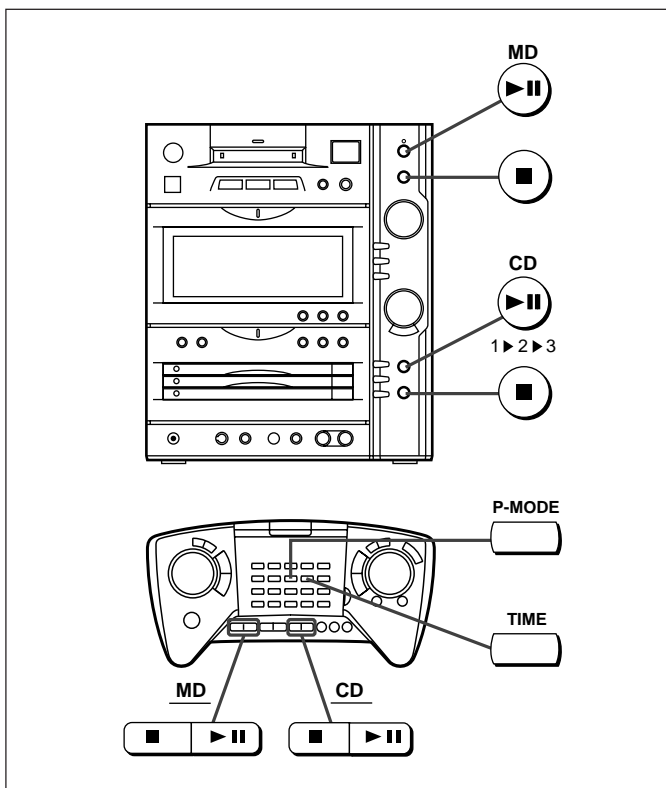

Repeat and random play

An entire disc, a single track, or a programmed sequence can be continuously repeated.

1 Select the desired program source, CD or MD, by pressing the CD ■ or MD ■ button.

2 Press the P-MODE button.

● Each time this button is pressed, the mode will change in the following order:

Repeat play → Random play → Normal play

3 Press the ►|| button to start playback.

● When all of the tracks have played in random order, the unit will stop automatically.

To stop playback:

Press the CD ■ or MD ■ button.

To cancel repeat playback or random play:

Press the P-MODE button until the ◀ or "RANDOM" display disappears.

● When you open the disc tray or a MiniDisc is removed, repeat play or random play mode will be canceled.

To repeat playback of selected tracks:

Enter the program for the tracks you want and start repeat play. You can program a single track and play it repeatedly.

Note:

● During APMS play, random play is not possible.

When more than one CD is inserted:

When you press the CD PLAY ►|| button ...

● All of the CDs in the unit will be played repeatedly or randomly. (Playback will continue until the unit is stopped.)

When you press the CD PLAY buttons (1 - 3) :

Only tracks from the selected CD will be played repeatedly or randomly.

● When all of the tracks have been played in random order, the unit will stop. (None of the tracks is played twice.)



(Continued)

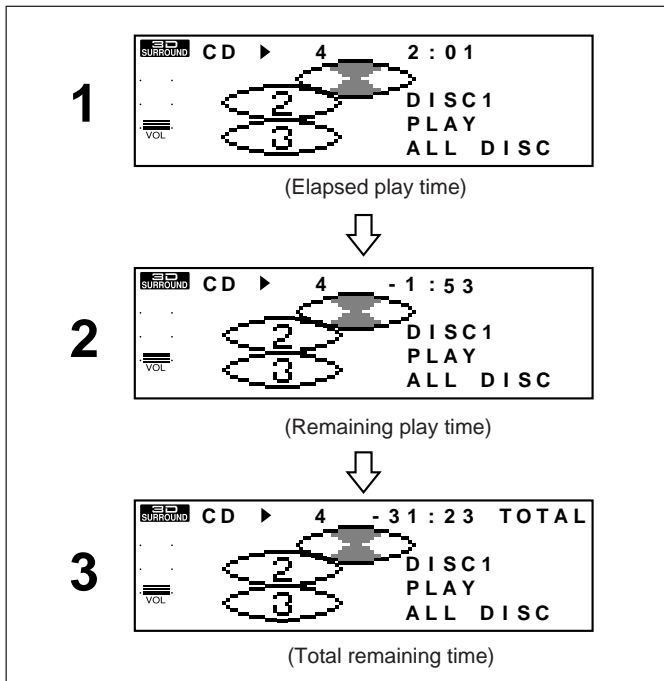

Switching the time display

To check the elapsed play time and the remaining play time:
Each time the **TIME** button is pressed during playback or pause, the display will change as described below.

See the diagram to the left.

- 1 The elapsed play time for each track will be displayed.
- 2 The remaining play time for the current track will be displayed.
- 3 The total remaining play time for the disc from the point being played at that time will be displayed.

Notes:

- During random play, only the elapsed play time for each track will be displayed. The display cannot be switched.
- Depending on a CD or MD to be played, the play time display may not match the play time which is indicated on the CD or MD jacket, because the time between the tracks is not included.

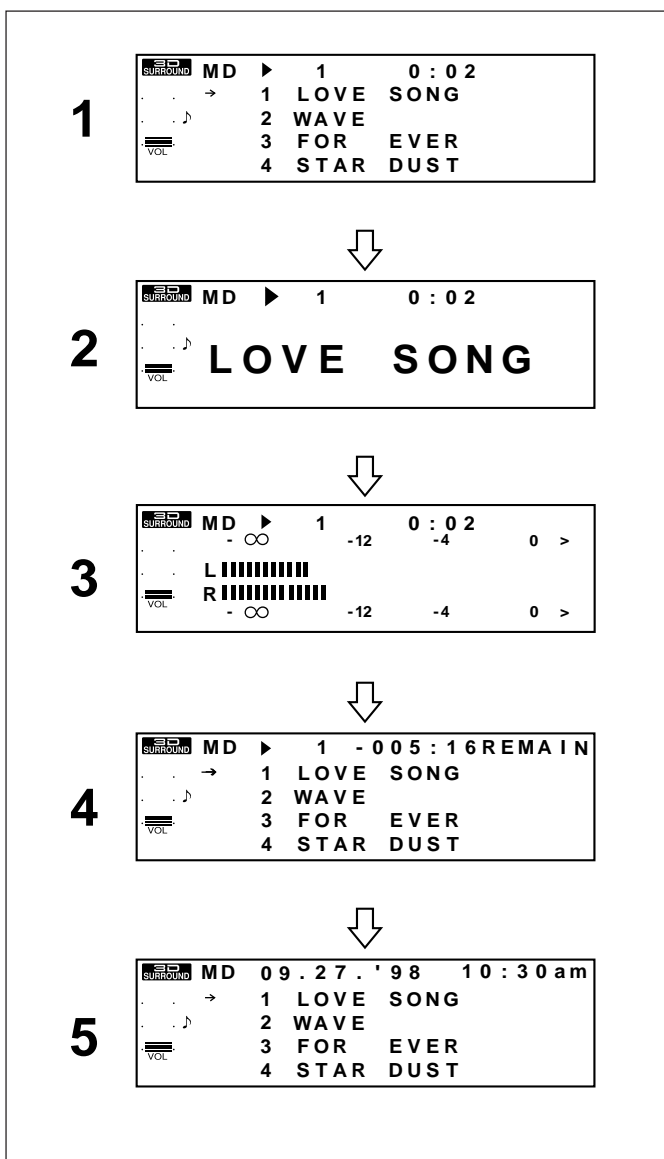

To check the remaining amount of MD recording time and the recording date:

Each time the **DISPLAY** button is pressed during playback, the display will change as described below.

See the diagram to the left.

- 1 Track names are displayed using standard size characters.
- 2 One track name is displayed using extra large characters.
- 3 The level meter is displayed.
- 4 The remaining amount of recording time is displayed.
- 5 The recording date is displayed.

Notes:

- If an MD does not contain disc name or any track names, no names will be displayed.
- For playback-only MDs or MDs recorded with a unit which cannot record the recording date, the number of recorded tracks, the remaining recording time and the recording date will not be displayed.



BASIC INFORMATION ON MINIDISCS

Differences from tape recordings

You cannot record music on the back side of a MiniDisc.

MiniDiscs cannot be inserted when they are turned over. (Page 18)

You don't need to search for the starting point at which to record.

The unit automatically finds the point at which recording can start. Recording will start from that point.

You can check the total or remaining recordable time (possible recording) before recording.

This lets you plan a recording session so that the last song will not come to an abrupt end before it has finished. (Page 30)

The date and time of a recording are automatically saved with the recording.

If you have set the date and time, they will be automatically recorded when a recording is made. (Page 25)

Information (TOC) to be recored on an MD

The TOC (Table of Contents) is information on track numbers and recording areas to allow the unit to recognize musical selections or sounds.

The entire MD is controlled depending on this TOC, which enables the unit to find the beginning of a track quickly or to automatically record in a vacant area.

- The TOC is recorded in a specific area on a MiniDisc, which is not used for sound recording.

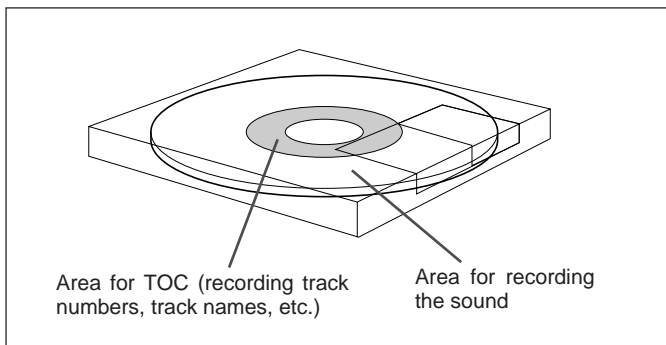

When you start recording or editing, "TOC" will appear in the display window.

This indicates that information in the TOC is now being changed according to recording or editing being performed. (The changed TOC is not yet recorded on the MiniDisc at this time.)

The TOC is recorded when

- you stop recording.
- you switch to another input source.
- you eject the MiniDisc.
- you turn the power off.

Do NOT unplug the power cord while the TOC is being recorded ("TOC" is flashing) Also, donot subject the unit any shocks or sharp jolts. Otherwise, the TOC will not be correctly recorded, and consequently proper playback may not be possible.

Note about making digital copies

MiniDiscs are designed so that further copies cannot be made from digitally recorded MiniDisc tracks. This is a specification of the SCMS (Serial Copy Management System).

About track numbers

When you make a recording on a MiniDisc, track numbers are created automatically.

When recording from CDs inserted in this unit or making a digital recording from an external unit (CD or MD)

New track numbers will be created automatically according to the original tracks (Synchro mark function).

- When you record from a CD to a MiniDisc, the track numbers recorded on the MiniDisc may not match the track numbers on the CD.

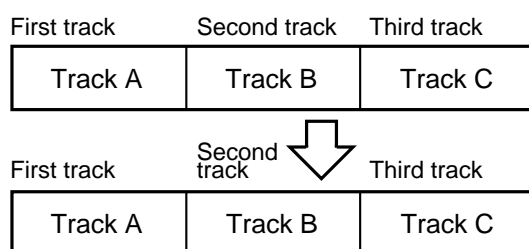

When recording from this unit's radio

One continuous recording is regarded as a single track.

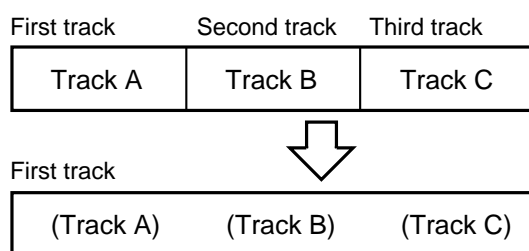

When recording from external analog equipment

If there is 1.5 seconds or more of silence, the blank space is assumed to be the space between tracks, and a new track number is created automatically (Auto mark function).

- If the signal to be recorded contains some noise, the track numbers may not be properly created.
- You can also record musical selections as a single track without using the Auto mark function.

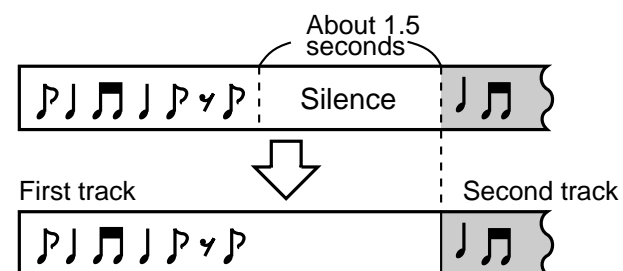

Note:

- When an external unit, such as a DAT, is connected and a recording is made, the Auto mark function will work properly.



RECORDING

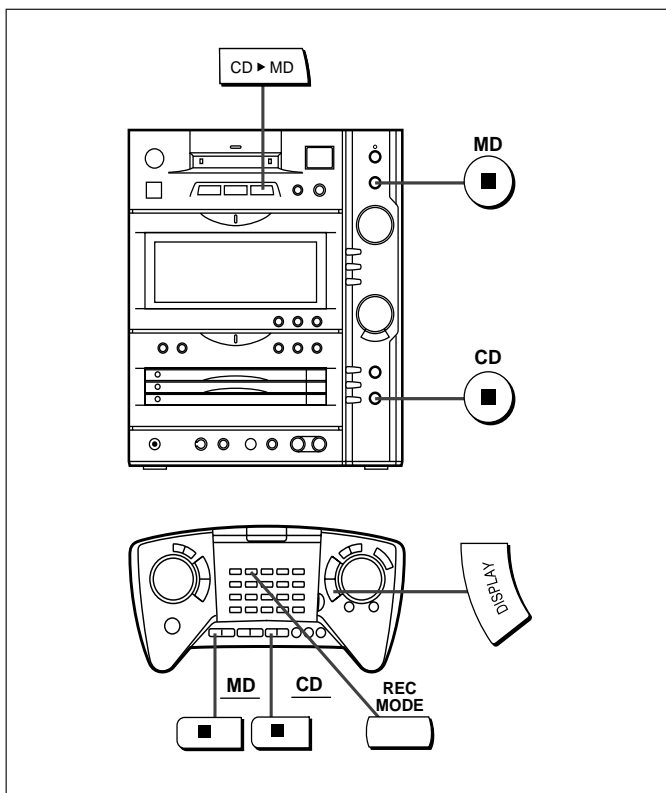

Recording from a CD onto a MiniDisc (One-Touch Editing)

You can make a recording that starts from the first track on a CD with a simple, one-touch operation.

If several CDs have been inserted in this unit, you can record all of them in succession.

- 1 Press the CD ■ button, and load the compact discs.
 - 2 Load a recordable MiniDisc.
 - 3 Check the record mode by pressing the REC MODE button.
 - 4 Press the CD ▶ MD button.
- Playback of the first track of the selected disc and recording begin.
 - When all discs are recorded, recording automatically stops.

Note:

- You can program a series of tracks and record them. (Page 23)

To cancel operation:

Before pressing the CD ▶ MD button, press the CD ■ or MD ■ button.

To stop recording:

Press the CD ■ button. After recording the track number, playback and recording will stop. It is not possible to pause recording.

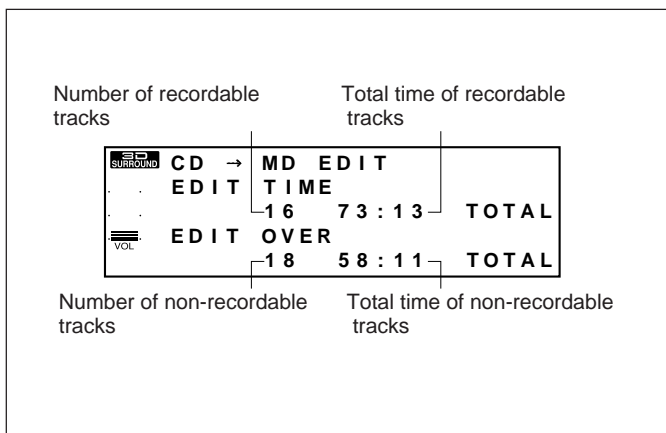

If recording does not begin:

If an MD does not have enough space to record all of the tracks from a CD, "EDIT OVER" will appear and the unit will enter the recording stand-by mode. When the CD ▶ MD button is pressed, a recording will be made. However, some tracks may not be recorded.

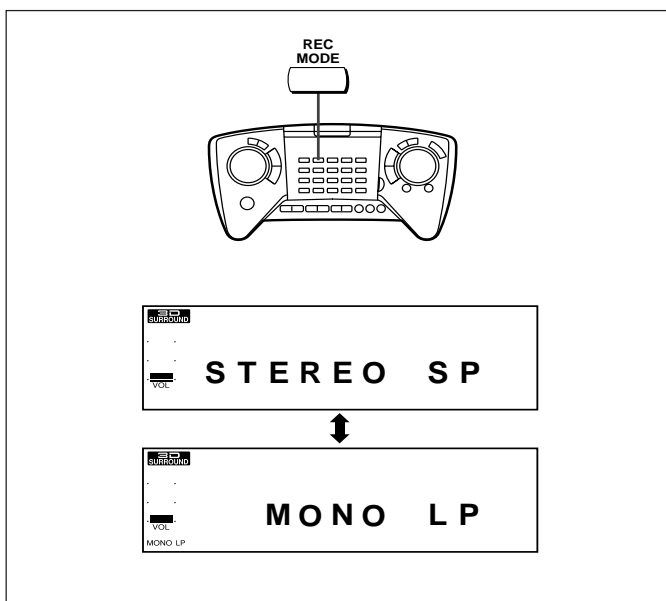

About monaural long-play mode

When a recording is made in the monaural long-play mode, the length of the recording can be double that of a stereo recording for the same amount of space on the MD. The monaural long-play mode is very useful for recording songs that were originally recorded in monaural, or for recording talk programs.

Press the REC MODE button on the remote control.

- Each time the button is pressed, the display will switch between the stereo mode and the monaural long-play mode.
- This mode cannot be changed while recording.
- The level meter shows stereo indication even when the mode is the monaural long-play mode.
- The recording mode will not change back until you change it manually. After you have made a recording in the monaural long-play mode, it is recommended that you return the unit to the stereo mode so that you won't forget to do so later.





(Continued)

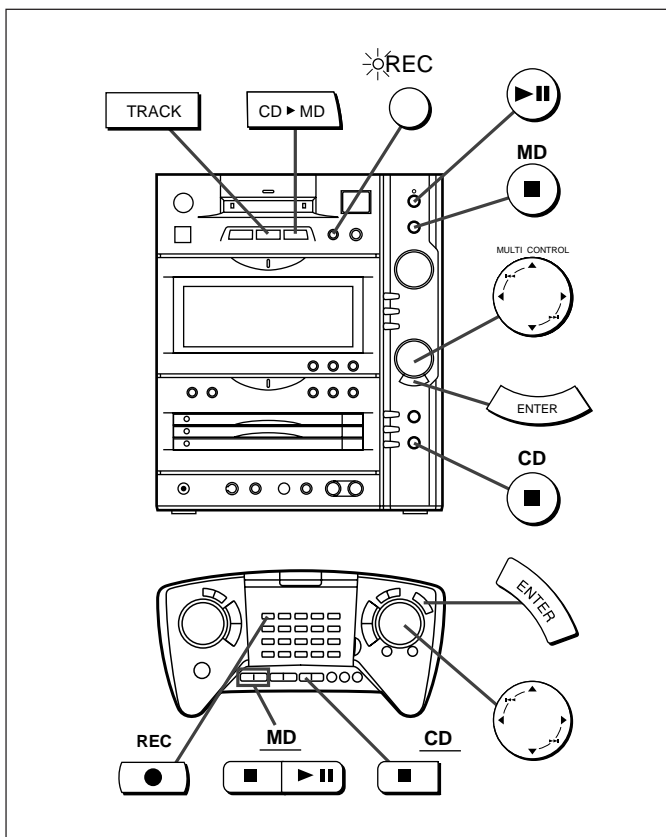

■ Recording desired tracks from a CD onto a MiniDisc (Track Editing)

You can record one track or a series of several tracks from a CD onto an MD. You can select one track and record it. (If the track numbers are not in succession, you cannot select a series of tracks.)

- 1 Press the CD ■ button, and load compact discs.
- 2 Load a recordable MiniDisc.
- 3 Press the ▲ or ▼ on the MULTI CONTROL button to select the track number you want to start recording from.
 - The selected track number appears.
- 4 Press the TRACK button.
 - To record a single track, skip to step 6.
- 5 Select the last track to be recorded recording by pressing the TRACK button.
- 6 Press the CD ▶ MD button.
 - When all tracks are recorded, recording automatically stops.

If recording does not begin:

If an MD does not have enough space to record all of the tracks from a CD, "EDIT OVER" will appear and the unit will enter the recording stand-by mode. When the CD ▶ MD button is pressed, a recording will be made. However, some tracks may not be recorded.

To cancel operation:

Before pressing the CD ▶ MD button, press the CD ■ or MD ■ button.

To stop recording:

Press the CD ■ button. After recording the track number, playback and recording will stop. It is not possible to pause recording.

To rerecord:

If you wish to rerecord, you can erase a track that is already recorded, starting from any point in the old track, to begin a new recording. Be aware that when you do this, all of the tracks and track names that had been previously recorded after the newly recorded track will be erased.

- 1 During playback, press the MD ▶|| button at the point where you wish to begin rerecording.
 - The unit will pause.
- 2 Press the REC ● button.
 - "RECORD & ERASE OK?" will appear.
- 3 Press the ENTER button.
 - The unit will enter the record stand-by mode.
- 4 Select the recording source and start recording.

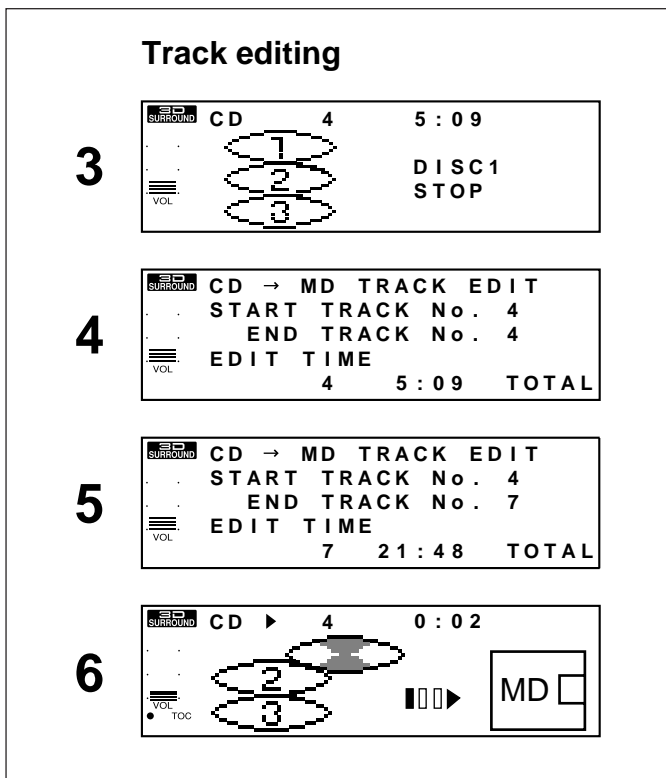

(Continued)

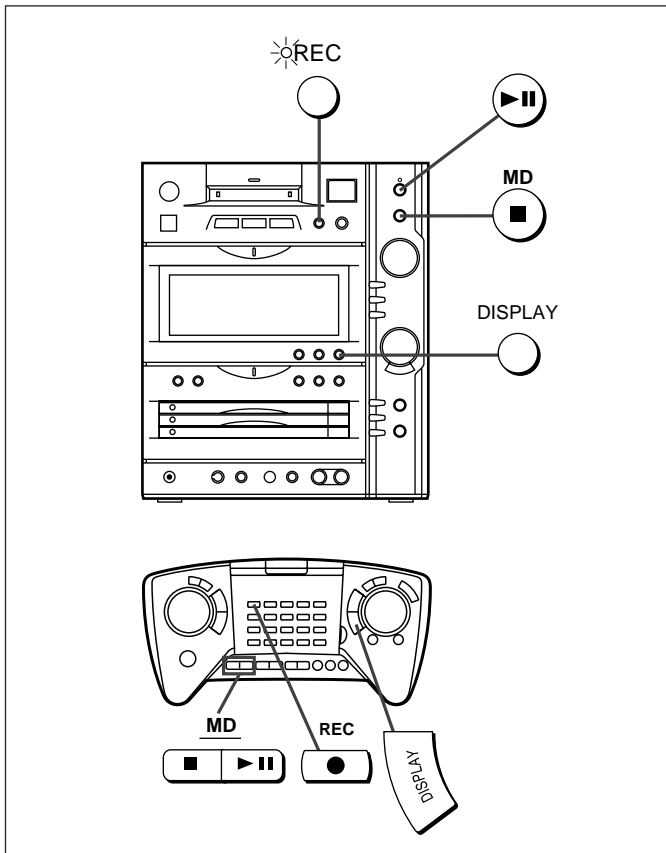

■ Recording from the built-in radio onto a MiniDisc

- 1 Tune in the radio station to be recorded.
- 2 Load a recordable MiniDisc.
- 3 Press the REC ● button.
 - The unit will enter the record stand-by mode.
 - Automatic tuning is impossible while in the recording stand-by mode.
- 4 Check the recordable time by pressing the DISPLAY button on the remote control.
- 5 Press the MD ► button.
 - During recording, you cannot change the station.

Note:

- When recording from the AM band, put the unit in the recording stand-by mode. Then, before recording, separate the AM loop antenna from the main unit, and adjust the radio reception so that the AM station is tuned in clearly.

To interrupt recording:

Press the MD ► button during recording.
Press the MD ► button again to resume recording.
The track number increases.

To record the track number during recording:

Press the REC ● button.

To stop recording:

Press the MD ■ button.
After recording the track number, recording stops.

Notes:

- The contents of a single recording are recorded under a single track number as a series of tracks.
- If you use the monaural extended recording mode, you can make recordings that are about twice as long as stereo recordings. This is convenient for recording monaural broadcasts or talk programs. (Page 27)

Recording from the built-in radio onto a MiniDisc

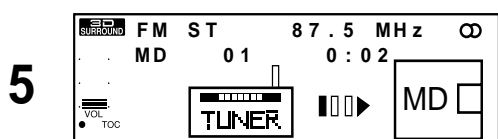
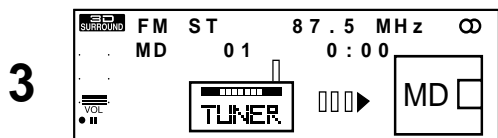



(Continued)

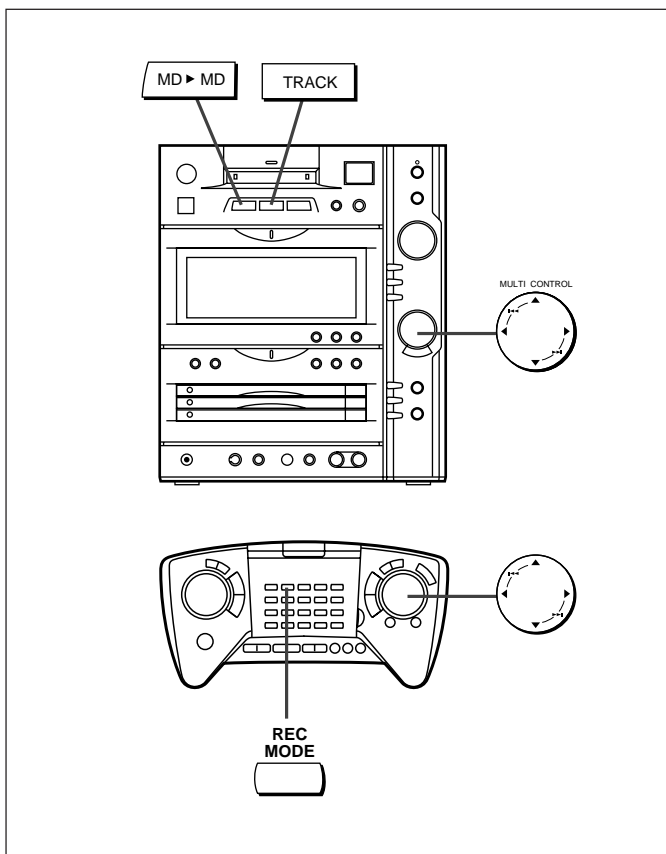

■ Recording from a portable MD player onto a MiniDisc (MD ▶ MD EDIT)

By connecting a portable MD player which has an MD ▶ MD EDIT function, you can easily record the sound and the character information at the same time.

- 1 Connect the unit to a portable MD player. (Page 45).
 - Connect the MD IN/AUX1 jack on the main unit to the headphone/remote control jack on the portable MD player using the proprietary cable. (AD-M4 AC, available separately).
- 2 Load a recordable MiniDisc in the main unit, and load the MiniDisc you want to record from into the portable MD player.
- 3 Check the record mode by pressing the REC MODE button on the remote control.
- 4 Check the number of recordable tracks and the amount of time by pressing the MD ▶ MD button on the main unit.
 - The disc name will be displayed along with the recordable number of tracks and time. Any extra time on the disc will also be displayed.
- 5 Press the MD ▶ MD button on the main unit.
 - If the MiniDisc to be recorded from has track names, "NAME READING" will flash and then the track names will be lit and recorded.
 - If the playback MiniDisc has a disc name, "disc name" will be displayed and record. After all of the tracks are recorded, the unit will stop automatically.

To record from a track in the middle of an MD to the last track on the disc:

Select the track number to start recording from, after performing step 4. Then press the MD ▶ MD button on the main unit.

To record a particular track:

- 1 Select the track number to record from after performing step 4.
 - If you start recording from a track in the middle, or if you only record a few tracks, the disc name cannot be recorded.
- 2 Press the TRACK button on the main unit.
- 3 Press the MD ▶ MD button on the main unit.

Notes:

Before using the MD ▶ MD button, the following precautions should be noted.

- By using the MD ▶ MD EDIT function, the analog recording mode will be used.
- If the MiniDisc to be recorded on already has a disc name, the disc name cannot be recorded over. If you want to record a new disc name, you must erase the existing disc name before entering a new disc name. (Page 37)
- When a playback-only MiniDisc is played, "Can't COPY NAME" will be displayed, and the sound will be recorded but the disc name and the track names will not be recorded.
- If a track is very short, it may be impossible to record all of the track name.
- Both the disc name and each of the track names, you contain up to 100 characters (including spaces).
- The volume, equalizer, and signal level will be adjusted automatically.
- It is better to use the AC adaptor for the portable MD player. The recording may be stopped if the batteries run down while recording.
- If you only want to record a particular track, or if you start recording from a track in the middle of the disc, the recordable time will not be displayed. If the recordable time on the target MiniDisc is insufficient, the recording will stop in the middle of a track.
- The shorter the track names are, the shorter the period of time that "NAME READING" will flash.
- If the MiniDisc has a scratch or is dirty, the disc name and the track names may not be recorded. In such a case, restart the recording again, or add the disc and track names using the DISC NAME function and the TRACK NAME function, after you are through recording. (Page 36)

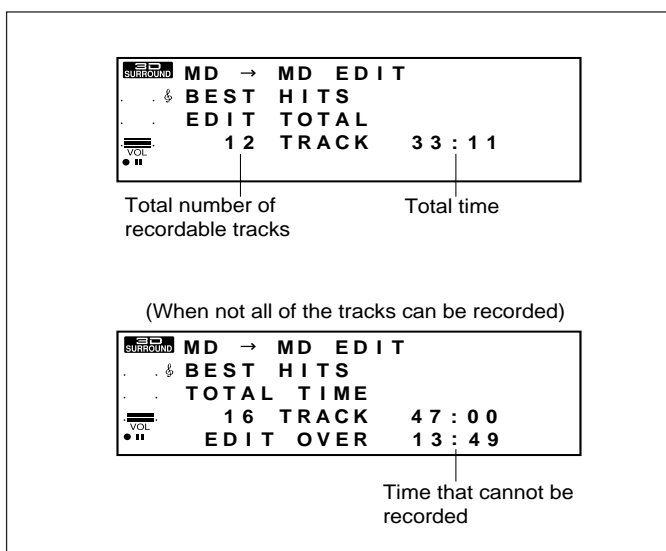



EDITING

We will explain the 5 editing functions you can use to create your own recorded MiniDiscs.

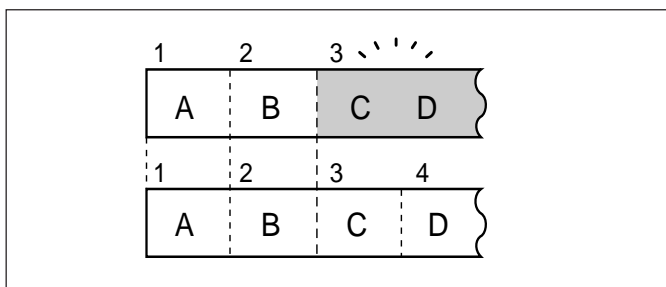

Divide

A track can be divided into two tracks. If two selections were recorded as a single track because there was not enough silent space between the tracks, you can use the DIVIDE function to separate the selections.

This feature is also convenient for identifying specific points with one selection so that you can locate those points easily whenever you like.

(Page 33)

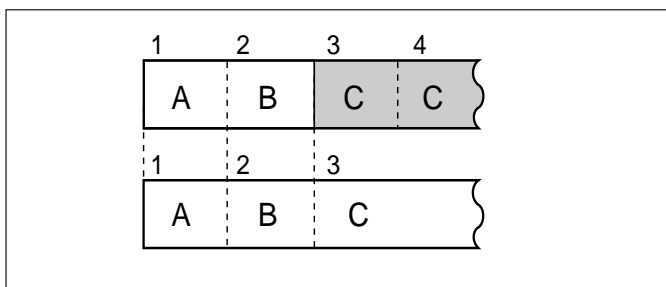

Combine

Two adjacent tracks (for example, the third and fourth tracks) can be combined.

If there is a prolonged silence in the middle of a selection that is recorded, a single piece of music may be recorded as two tracks. If this happens, these two tracks can be combined into a single track.

(Page 33)

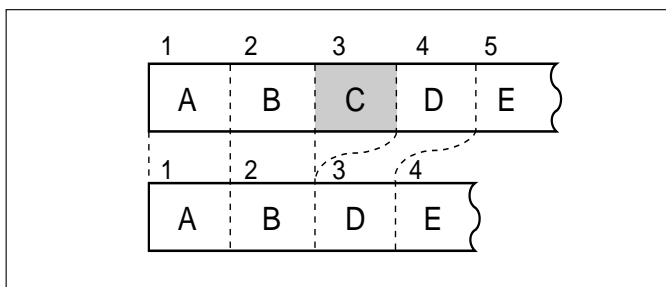

Erase

Tracks you want to erase can be erased one at a time or all at once.

Once a track has been erased, it cannot be recovered.

Double-check the track number before erasing it.

(Page 35)

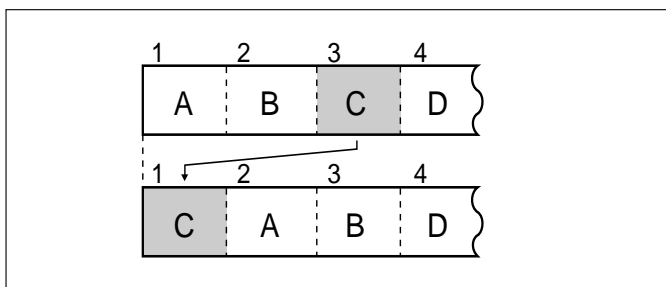

Move

The order of the recorded tracks can be changed. This feature is different from program play. A new track order can be recorded directly on the disc. When the power is turned off, the revised order will not be changed.

(Page 34)

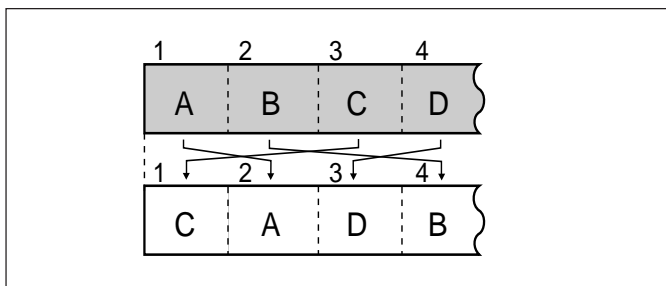

Program move function

This function allows the track numbers to be automatically rearranged in the order specified for programmed playback. The track numbers will be adjusted as needed, automatically.

(The tracks that are not included in the programmed selections will be put at the end of the new track number sequence.)

(Page 34)

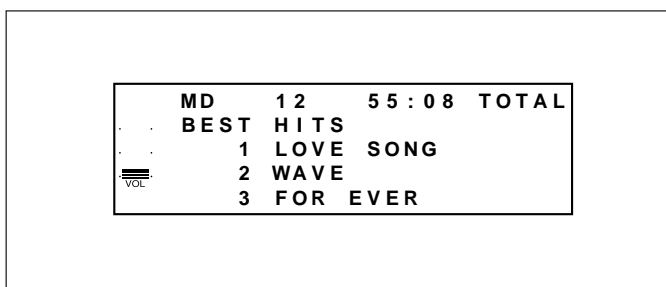

Track/Disc name

You can assign titles to recorded tracks and to discs. The characters must be capital and lowercase letters, or symbols. Track and disc names can use up to 100 characters per name.

(Page 36)



(Continued)

Using the editing function

We will show you some examples of how to use the editing functions. You can create a disc of your favorite selections by recording tracks from a variety of input sources such as CDs and radio broadcasts.

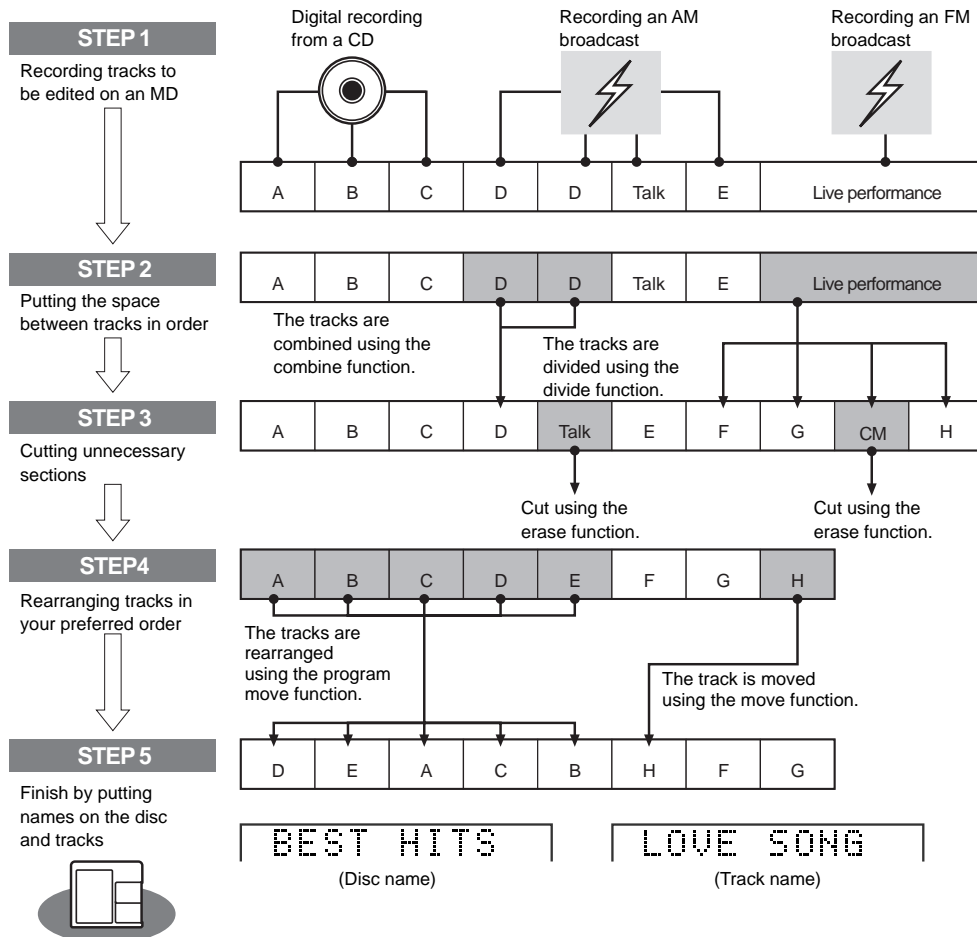

Edit Menu

The editing functions are selected from the edit menu. The functions which can be selected from the edit menu will vary, depending on the state which an editing operation is started.

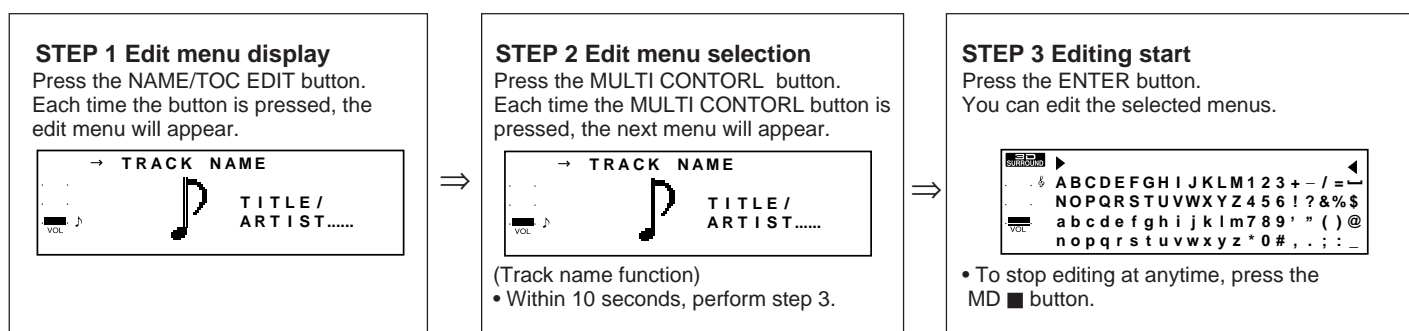

Recording the editing results

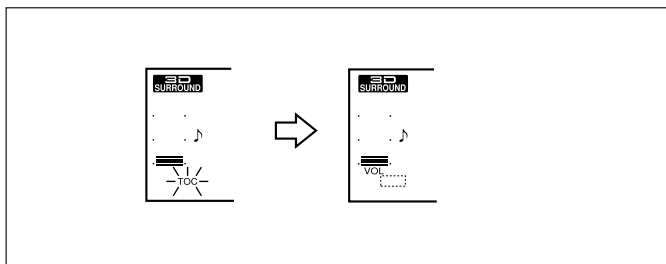

While editing, the "TOC" indicator is displayed. This means the edit results have not been recorded on the MiniDisc. To record the results, select another input or turn the power off. During writing, the "TOC" display will flash. Once the "TOC" goes out, all editing has been recorded to the disc.

Note:

- Storing the edited contents on the disc can be done after several pieces of editing have been finished.



(Continued)

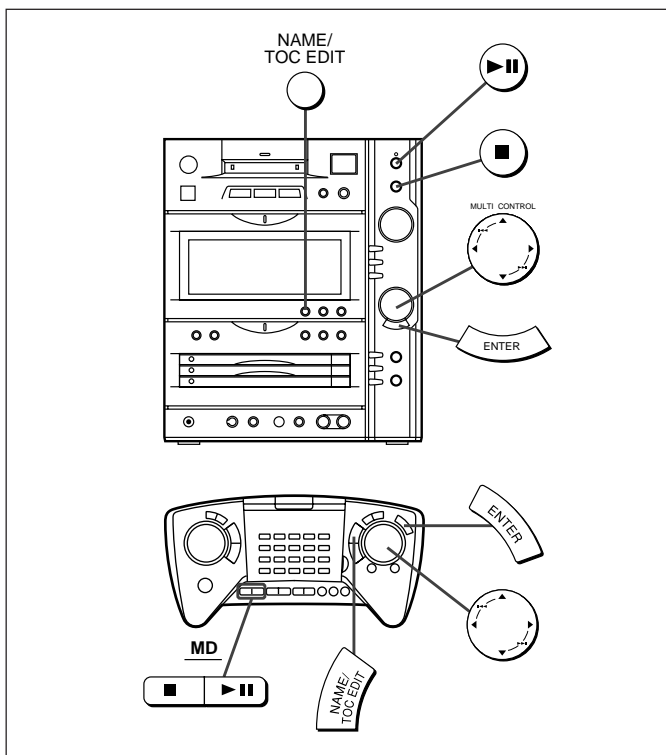

■ Divide

- 1 Play the track which you wish to divide into two and press the **PAUSE** button at the point where you wish to divide the track.
 - The unit will enter the pause mode.
- 2 Press the **NAME/TOC EDIT** button, and then select "DIVIDE" using the **MULTI CONTROL** button.
- 3 Within 10 seconds, press the **ENTER** button.
 - To cancel the operation, press the **MD** button.
- 4 Press the **ENTER** button again.
 - The tracks are divided, and the unit is stopped at the beginning of the second of the two tracks.
 - The numbers of the tracks which come after the divided track are automatically increased by one.
 - When a track which has been given a name is divided, the two new tracks will have the same name and date. If the "TOC FULL" message is displayed, the second track may not be given a name.

Notes:

- This unit can hold up to 255 tracks. However, even if the number of tracks assigned has not reached 255, it might not be possible to make any further divisions of tracks. (Page 53)
- This function cannot be used while in the program ("PRGM" is lit) or while in the random play modes ("RANDOM" is lit). First, cancel the program or random play mode before trying to use this function.

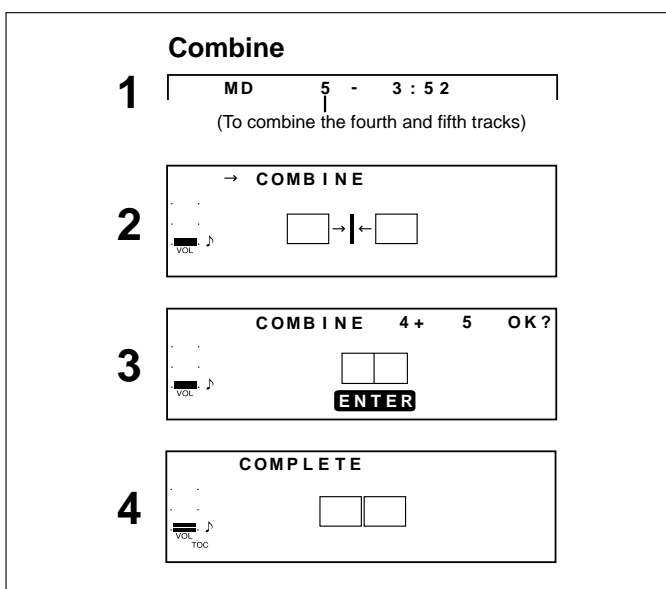
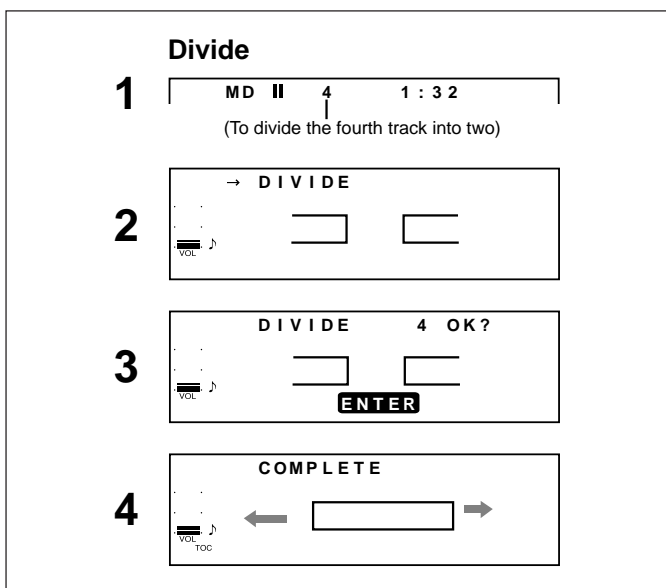

■ Combine

- 1 While in the stop mode, select the second of the two tracks you wish to combine using the **MULTI CONTROL** button.
Or start playing the second of the two tracks you wish to combine, and then press the **MD PAUSE** button.
 - The unit will enter the pause mode.
- 2 Press the **NAME/TOC EDIT** button, and then select "COMBINE" using the **MULTI CONTROL** button.
- 3 Within 10 seconds, press the **ENTER** button.
 - To cancel the operation, press the **MD** button.
- 4 Press the **ENTER** button again.
 - The two tracks are combined, and the unit is stopped at the beginning of the combined track.
 - The numbers assigned to the tracks following the combined track are automatically decreased by one.

When both tracks have a name:

- When only the first track has a name → That name will be used.
- When only the second of the two tracks has a name → That name will be used.
- When both tracks have a name → The name of the first track will be used.

To combine two noncontiguous tracks:

(Example: the first and third tracks)
Move the third track to the second track using the **MOVE** function. (Page 34)
Then, combine the first and second tracks using the **COMBINE** function.

Notes:

- Tracks recorded from the analog inputs cannot be combined with tracks recorded from CDs or MDs using the digital inputs.
- Tracks recorded in the stereo mode cannot be combined with tracks recorded in the monaural long-play mode.
- Tracks where either track's recording time is less than 15 seconds may not be combined.

(Continued)

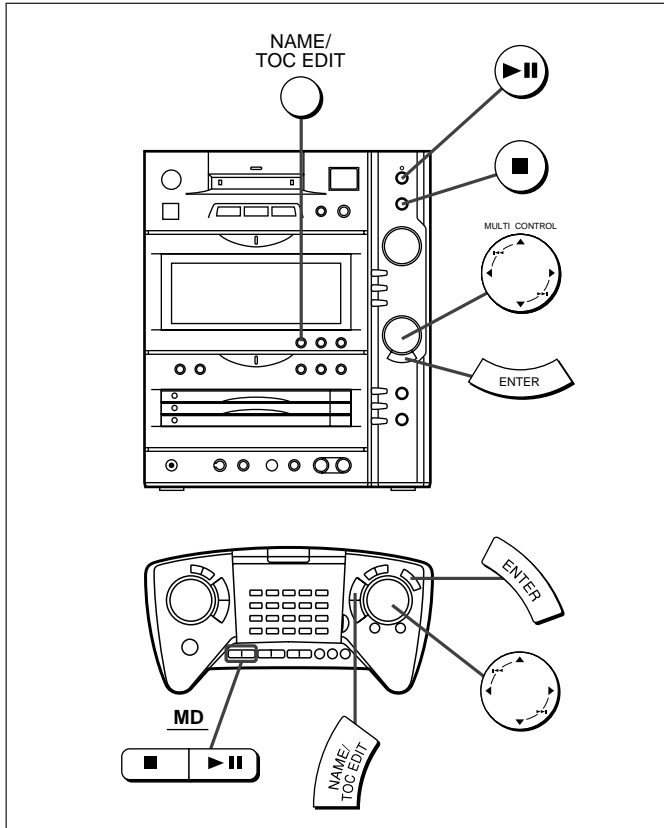

Move

- 1 While in the stop mode, select the track you wish to move using the multicontrol button.
Or start playing the track to be moved, and then press the MD ►|| button.
 - The unit will enter the pause mode.
- 2 Press the NAME/TOC EDIT button, and then select "MOVE" using the MULTI CONTROL button.
- 3 Within 10 seconds, press the ENTER button.
- 4 Select the direction to move the track using the MULTI CONTROL button.
 - To increase the track number ... ▲
 - To decrease the track number ... ▼
 - To cancel the operation, press the MD ■ button.
- 5 Press the ENTER button again.
 - The track is moved, and the unit is stopped at the beginning of the track.

Note:

- When a track has been moved, the other tracks which are affected will be assigned new track numbers automatically.

Example:

When moving the fifth track to the third track, the old third track will become the new fourth track, and the old fourth track will become the new fifth track.

- This function cannot be used while in the program ("PRGM" is lit) or the random play modes ("RANDOM" is lit). First, cancel the program or random play modes before trying to use this function.

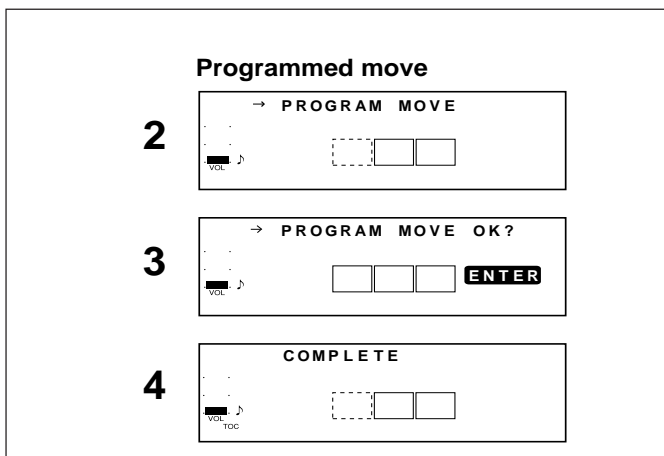
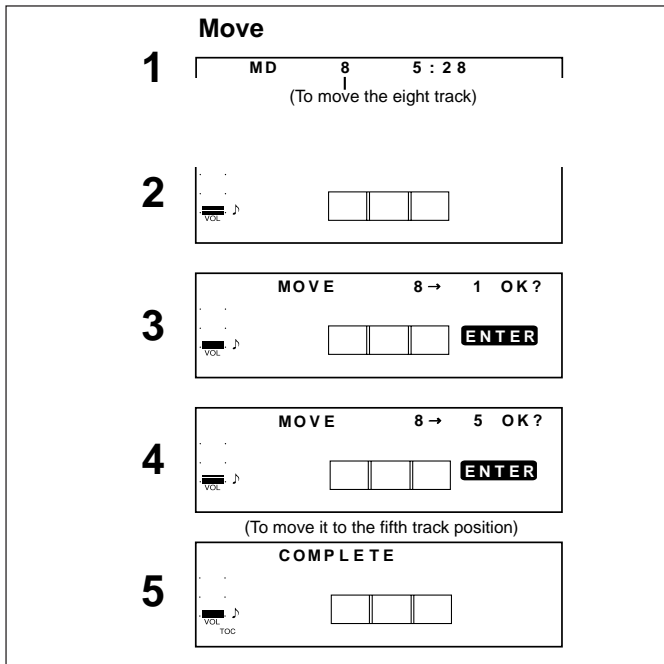

Programmed move

- 1 Select the tracks you want to move and enter them into a program. (Page 23)
- 2 Make sure that the "PRGM" indicator is lit, and then press the NAME/TOC EDIT button.
- 3 Within 10 seconds, press the ENTER button.
 - To cancel the operation, press the MD ■ button.
- 4 Press the ENTER button again.
 - The tracks will be moved, and the programmed move mode will end.

Notes:

- The track numbers that are not included in the programmed selections will be put at the end of the new sequence.
- When the same track has been entered into the program twice or more, the last programmed position will have priority.



(Continued)

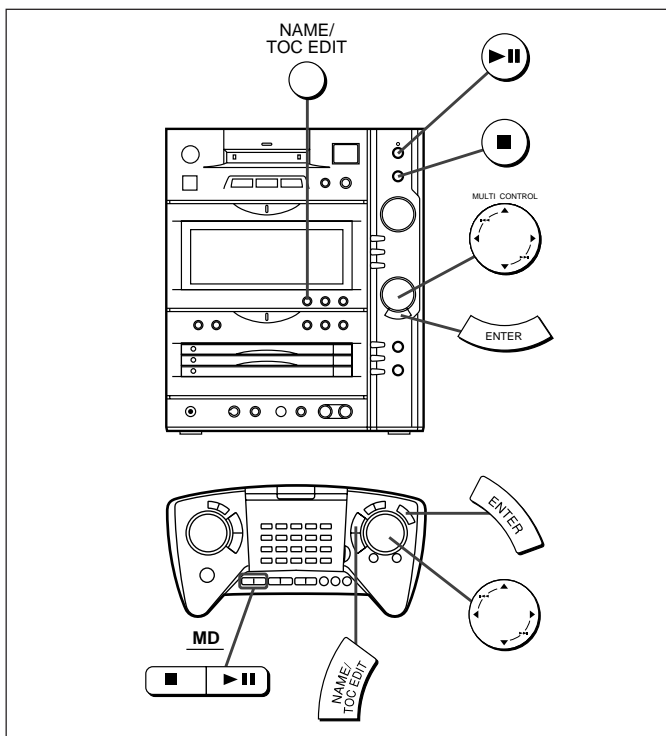

■ Erase

To erase tracks one at a time:

- 1 While in the stop mode, select the track to be erased using the MULTI CONTROL button.
Or start playing the track you wish to erase, and press the MD ►|| button.
- The unit will enter the pause mode.
- 2 Press the NAME/TOC EDIT button, and then select "ERASE" using the MULTI CONTROL button.
- 3 Within 10 seconds, press the ENTER button.
- To cancel the operation, press the MD ■ button.
- 4 Press the ENTER button again.
- The track is erased, and the unit is stopped at the beginning of the previous track.

Notes:

- Once a track has been erased, it cannot be recovered. Double-check the track number before erasing it.
- When a track is erased, the numbers assigned to the tracks following the erased track will be automatically decreased by one.
- When a track is erased, the track name will be erased at the same time.

To erase tracks one at a time

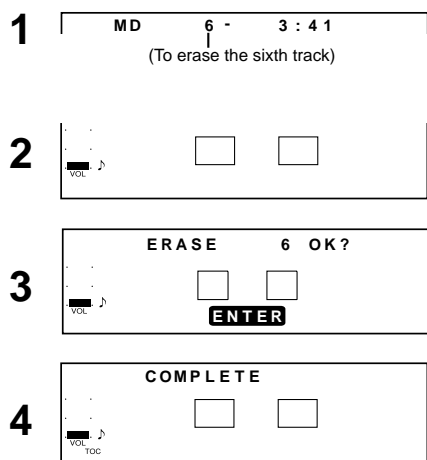

To erase all of the tracks at once

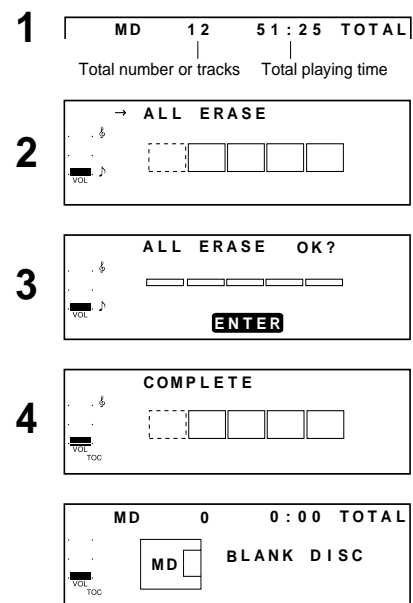

To erase all of the tracks at once:

- 1 Press the MD ■ button.
- The total number of tracks and the total playing time for the MD will be displayed.
- 2 Press the NAME/TOC EDIT button, and then select "ALL ERASE" using the MULTI CONTROL button.
- 3 Within 10 seconds, press the ENTER button.
- To cancel the operation, press the MD ■ button.
- 4 Press the ENTER button again.
- All of the track numbers and track names will be erased.

Note:

- This function cannot be used while in the program ("PRGM" is lit) or the random play modes ("RANDOM" is lit). First, cancel the program or random play modes before trying to use this function.





(Continued)

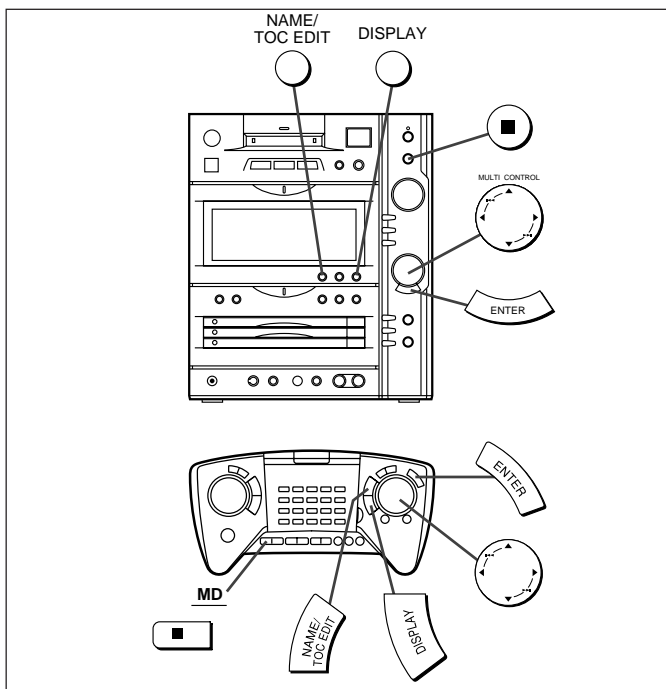

To create a disc name

1 MD 12 51:25 TOTAL
Total number of tracks Total playing time

2 → DISC NAME
TITLE/
ARTIST.....

3 ABCDEFGHIJKLM123+ - / =
NOPQRSTUVWXYZ456! ? & % \$
abcdefghijklmnop789' " () @
nopqrstuvwxyz*0# , . ; : -

4 → DISC NAME
TITLE/
ARTIST.....

MD	12	51:25	TOTAL
→	BEST HITS		
1	NO NAME		
2	NO NAME		
3	NO NAME		

To create a track name

1 → TRACK NAME
TITLE/
ARTIST.....

2 ABCDEFGHIJKLM123+ - / =
NOPQRSTUVWXYZ456! ? & % \$
abcdefghijklmnop789' " () @
nopqrstuvwxyz*0# , . ; : -

3 → TRACK NAME
TITLE/
ARTIST.....

MD	1	1:38
→	1	LOVE SONG
2	NO NAME	
3	NO NAME	
4	NO NAME	

Track/disc name

Up to 255 tracks can be named on each disc, and each disc can be given a disc name.

- Up to 100 characters (including spaces) can be entered for each name. If more than 100 characters are entered, "NAME FULL" will appear.
- A total of approximately 1700 characters can be used for all of the disc and track names. If more than 1700 characters are entered, "TOC FULL" will appear.

To create a disc name

Create name for the whole disc. The disc name is displayed when an MD is inserted.

- 1 Press the MD button.
 - The total number of tracks and the total playing time for the MD will appear.
 - 2 Press the NAME/TOC EDIT button, and then select "DISC NAME" using the MULTI CONTROL button.
 - To enter a disc name using extra large characters
Within 10 seconds, press the DISPLAY button to make the extra large character display appear.
 - 3 Within 10 seconds, press the ENTER button.
 - The unit will enter the character input mode.
 - 4 Enter the characters in the name.
 - For details about entering characters and how to make corrections, see pages 13 - 16.
 - 5 After entering all of the characters in the name, press the NAME/TOC EDIT button.
 - The disc name will be recorded.
- Note:**
- This function cannot be used while in the program ("PRGM" is lit) or the random play modes ("RANDOM" is lit). First, cancel the program or random play modes before trying to use this function.

To create a track name

Name each track. The track name will be displayed whenever you select it and during playback.

- 1 During playback, press the NAME/TOC EDIT button.
 - "TRACK NAME" will appear.
 - To enter a track name using extra large characters
Within 10 seconds, press the DISPLAY button to make the extra large character display appear.
- 2 Within 10 seconds, press the ENTER button.
 - The unit will enter the character input mode.
 - The track you are listening to will be played repeatedly.
- 3 Enter the characters in the name.
 - For details about entering characters and how to make corrections, see pages 13 - 16.
- 4 After entering all of the characters in the name, press the NAME/TOC EDIT button.
 - The track name will be recorded.
 - The unit will return to normal playback.

(Continued)

Notes:

- This function cannot be used while in the program ("PRGM" is lit) or the random play modes ("RANDOM" is lit). First, cancel the program or random play modes before trying to use this function.
- The track name function can be used while in the stop mode (when selecting a track), in the pause mode, or in the recording mode. (Select "TRACK NAME" from the edit menu.)
- If you create a track name while recording the track, make sure you finish entering the name before you finish recording the track. If the end of the recording is reached before you have entered the complete name, only the characters entered before the recording ended will be recorded.

To erase disc names or track names

1 Disc name:

Perform steps 1-3 of "To create a disc name", on page 36.

Track name:

Perform steps 1-2 of "To create a track name", on page 36.

2 Press the TIMER/DELETE button for at least 2 seconds.

- The "NAME CLEAR OK? / DISC CLEAR OK?" display will appear.

3 Press the ENTER button.

- The disc or track name will be erased.

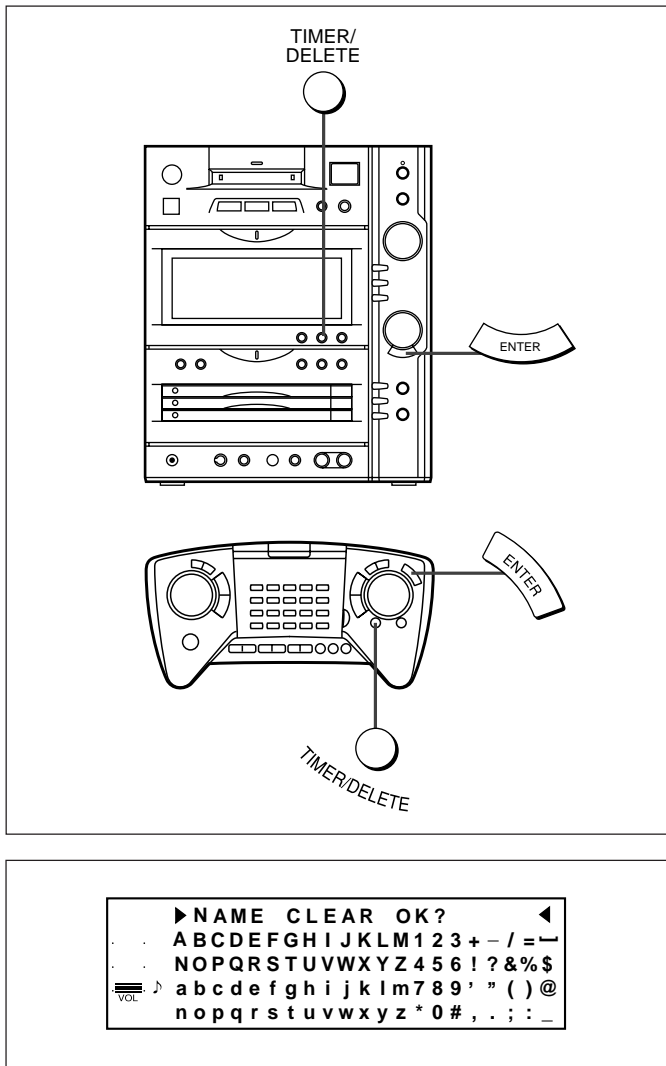



HOW TO USE THE BUILT-IN TIMER

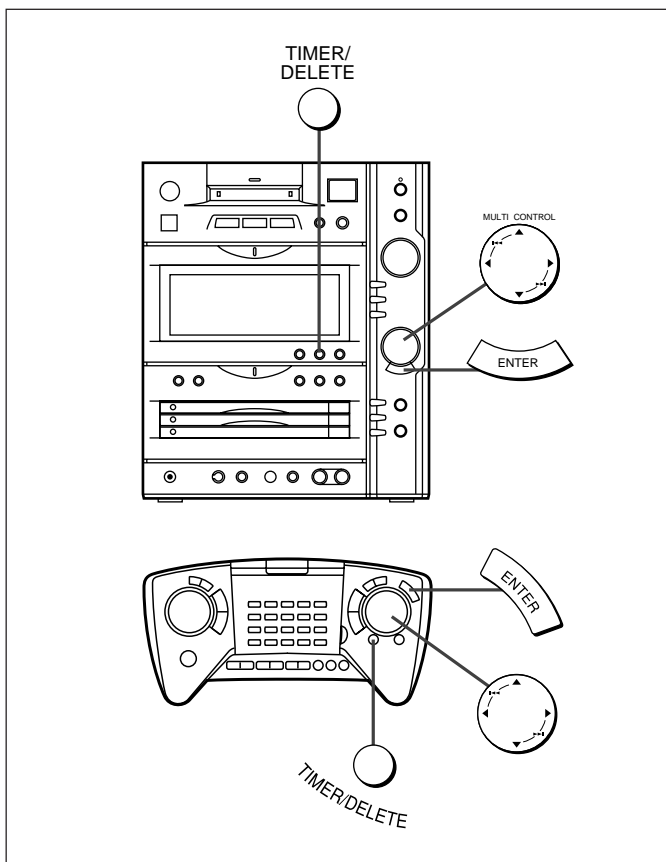

What the timer can do

The timer in this product can do the following:

- To use the timer, be sure to adjust the clock. (page 10)

Timer playback:

Music (CDs, MDs, radio, sound from an external unit) can be played automatically at a preset time. The playback ending time can also be set.

Timer recording:

You can record the sound from a radio or an external unit on an MD while you are out or when you are asleep.

Sleep operation:

When the preset amount of time has elapsed, the music will stop automatically, and the power will be turned off. This is convenient for going to sleep.

To set up the timer for playback

Before starting timer playback, the following preparations are required.

- Load a CD or an MD.
- Select the CD to be played.
- Preset the radio station.

- While in the stop mode, press the TIMER/DELETE button.
 - Within 10 seconds, press the ▲ or ▼ on the MULTI CONTROL button to select "TIMER SET". Then, press the ENTER button.
 - Within 10 seconds, press the ◀ or ▶ on the MULTI CONTROL button to select "PLAY".
 - Each time the button is pressed, the display will alternate between "PLAY" and "REC".
 - Within 10 seconds, press the ▼ on the MULTI CONTROL button to select the position where the start time hour ("ON") flashes. Then, press the ▲ or ▼ on the MULTI CONTROL button to adjust the hour.
 - Press the ▼ on the MULTI CONTROL button to select the position where the start time minutes flash. Then, press the ◀ or ▶ on the MULTI CONTROL button to adjust the minutes.
 - When the button is held down, the time will change in increments of 5 minutes.
 - Adjust the hour and minute for the stop time ("OFF") using the same procedure as described in steps 4 - 5 above.
 - Press the ▲ or ▼ on the MULTI CONTROL button to select the position where the sound source flashes. Then, press the ◀ or ▶ on the MULTI CONTROL button to select the sound source you want to listen to.
 - Each time the button is pressed, the source will change as follows:
MD → CD → TUNER → AUX1 → AUX2 → AUX OPT → AUX COAX → PHONO
 - When no radio stations have been stored in memory, "TUNER" will not appear.
- When "TUNER" has been selected**
- "P-01" will appear to the right of "TUNER". After pressing the ▼ on the MULTI CONTROL button (the flashing area moves), press the ◀ or ▶ on the MULTI CONTROL button to select the location number of the radio station you want to listen to.

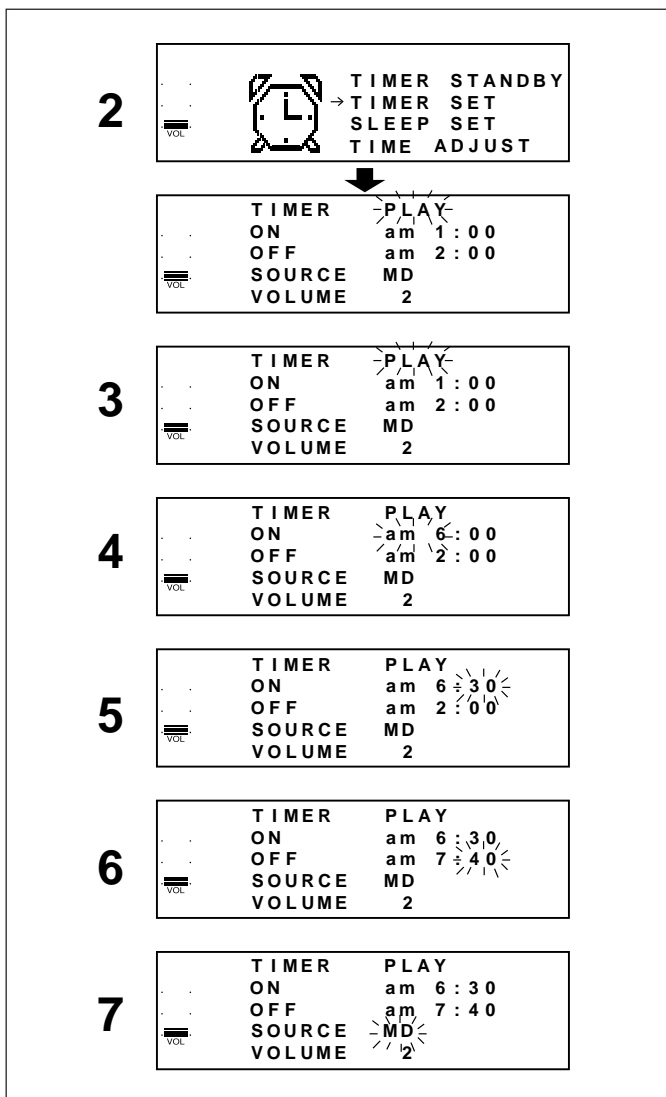



(Continued)

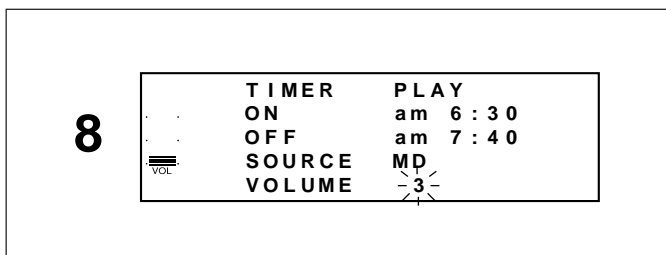

8 Press the ▼ on the MULTI CONTROL button to select the VOLUME position on the LCD.

The current volume level (0 - 10) will flash. Then, press the ◀ or ▶ on the MULTI CONTROL button to adjust the volume level (0 - 10) as required.

● When the preset time is reached, the volume will increase gradually to the preset volume level.

9 After making all required settings, press the ENTER button.

● The timer playback settings are now complete. These settings will be stored in memory until changed.

Then, set all items as required. For details on settings, see "Performing timer playback" below.

Stopping timer playback in the middle:

Press any button other than the MULTI CONTROL button or the ENTER button.

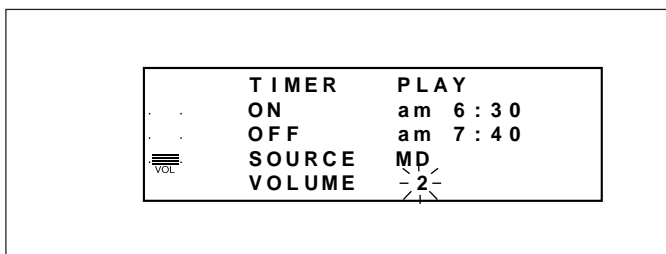

To change a setting:

1 Turn the power on, and perform steps 1 - 2 on page 38. Then, select the item you want to change, and set its value as required.

2 After completing the changes, press the ENTER button.

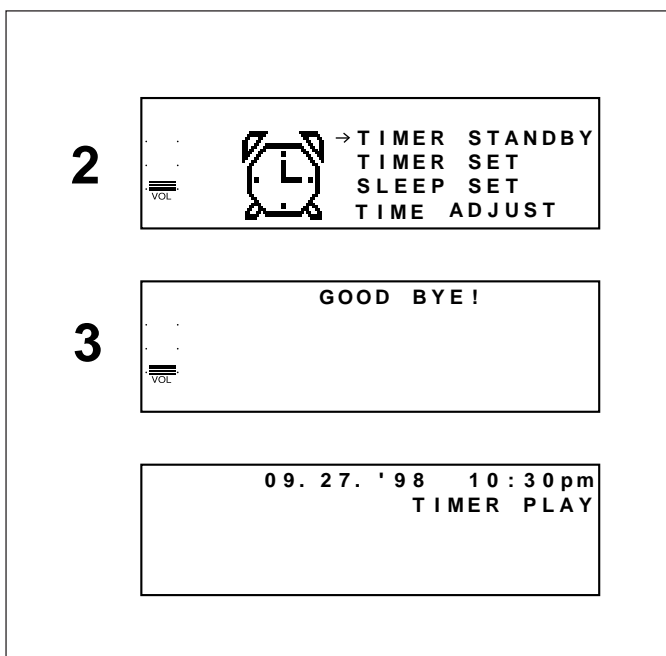

Performing timer playback

1 After all timer playback settings have been stored, press the TIMER/DELETE button.

2 Press the ▲ or ▼ on the MULTI CONTROL button to select "TIMER STANDBY".

● If a time has not been set, this will not appear on the display. Set the time.

3 Then, within 10 seconds, press the ENTER button.

● The unit will enter the timer playback stand-by mode. (Power will be turned off.)

Notes

● When the CD or MD is played to the end, playback will stop before the stop time.

If you wish to play to the stop time, set repeat play for the CD or MD.

● The timer playback and timer recording with this unit cannot be used to control equipment connected to this unit. You must use the timer of the other equipment, if it has one.

● The timer playback and timer recording functions cannot be used at the same time.



(Continued)

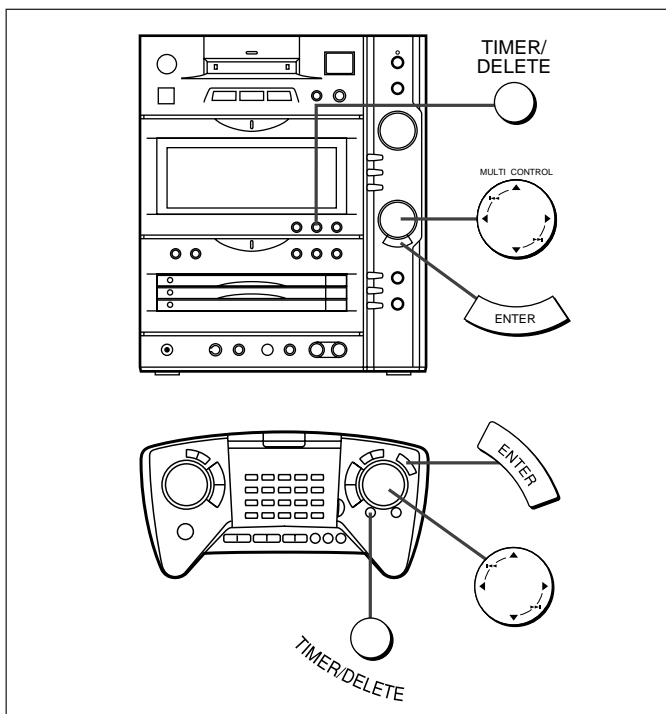

To set up the timer for recording

- 1 While in the stop mode, press the TIMER/DELETE button.
- 2 Within 10 seconds, press the ▲ or ▼ on the MULTI CONTROL button to select "TIMER SET". Then, press the ENTER button.
- 3 Within 10 seconds, press the ◀ or ▶ on the MULTI CONTROL button to select "REC".
 - Each time the button is pressed, the display will alternate between "PLAY" and "REC".
 - If a radio station has been stored in memory when "REC" is selected, "TUNER P-01" will appear automatically as the SOURCE setting.
- 4 Within 10 seconds, press the ▼ on the MULTI CONTROL button to select the position where the start time hour ("ON") flashes. Then, press the ▲ or ▼ on the MULTI CONTROL button to adjust the hour.
- 5 Press the ▼ on the MULTI CONTROL button to select the position where the start time minutes flash. Then, press the ◀ or ▶ on the MULTI CONTROL button to adjust the minutes.
 - When the button is held down, the time will change in increments of 5 minutes.
- 6 Adjust the hour and minute for the stop time ("OFF") using the same procedure as described in steps 5 - 8 above.
- 7 Press the ▲ or ▼ on the MULTI CONTROL button to select the position where the sound source flashes. Then, press the ◀ or ▶ on the MULTI CONTROL button to select the sound source you want to record from.
 - If no radio stations have been stored in memory, "TUNER" will not appear. When "TUNER" has been selected:
 - "P-01" will appear to the right of "TUNER". After pressing the ▼ on the MULTI CONTROL button (the flashing area moves), press the ◀ or ▶ on the MULTI CONTROL button to select the location number of the radio station you want to record from.
- 8 Press the ▼ on the MULTI CONTROL button to select the VOLUME position on the LCD. The current volume level (0 - 10) will flash. Then, press the ◀ or ▶ on the MULTI CONTROL button to adjust the volume level (0 - 10) as required.
 - When the preset time is reached, the volume will increase gradually up to the preset volume level.
- 9 After making all required settings, press the ENTER button.
 - The timer recording settings are now complete. These settings will be stored in memory until changed. Then, set all items as required. For details on settings, see "Performing timer recording" on page 41.

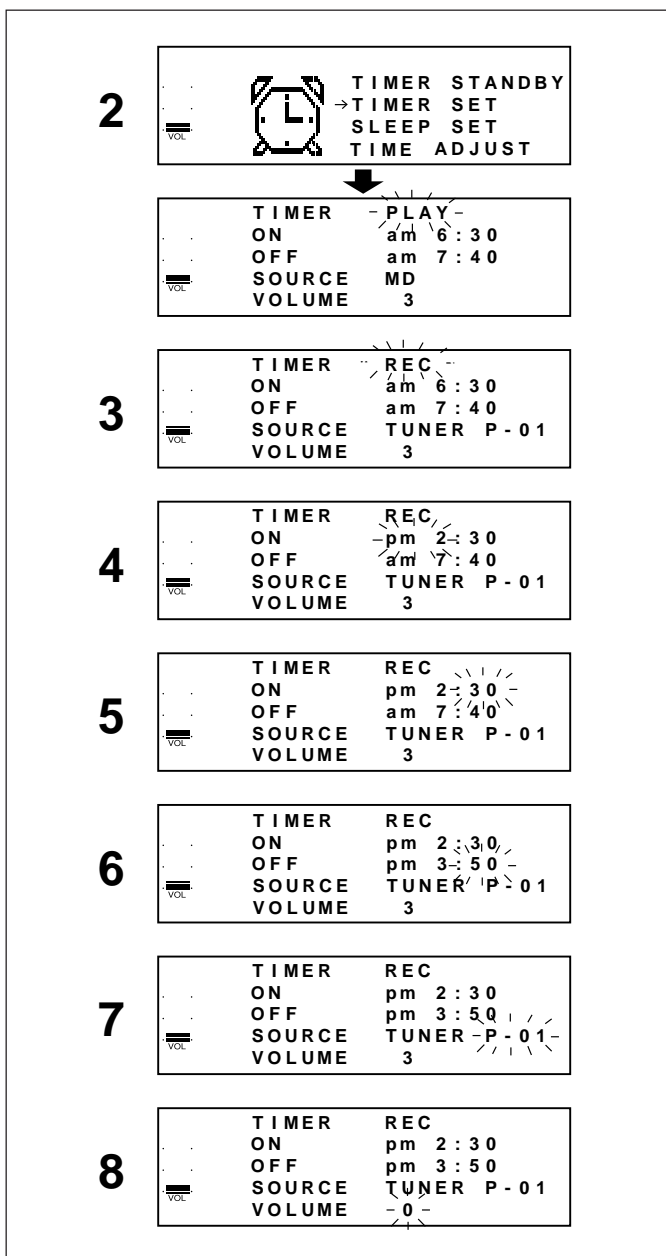

Stopping timer recording in the middle:

Press any button other than the MULTI CONTROL button or the ENTER button.



(Continued)

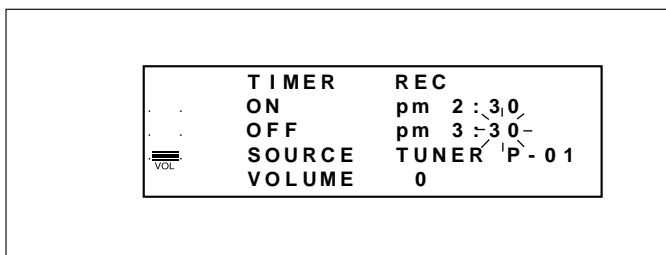

Performing timer recording

2  → TIMER STANDBY
TIMER SET
SLEEP SET
TIME ADJUST

3 GOOD BYE!

09.27.'98 10:30pm
TIMER REC

To check the timer setting

2  → TIMER CANCEL
→ TIMER CALL
SLEEP SET
TIME ADJUST

3

TIMER	PLAY
ON	am 6:30
OFF	am 7:40
SOURCE	MD
VOLUME	0

To cancel the timer operation

2  → TIMER CANCEL
TIMER CALL
SLEEP SET
TIME ADJUST

3 09.27.'98 10:35am

To change a setting:

- 1 Turn the power on, and perform steps 1 - 2 on page 40. Then, select the item you want to change, and set its value as required.
- 2 After completing the changes, press the ENTER button.

Performing timer recording

- 1 After timer recording settings have been stored, press the TIMER/DELETE button.
- 2 Press the ▲ or ▼ on the MULTI CONTROL button to select "TIMER STANDBY".
 - If a time has not been set, this will not appear on the display. Set the time.
- 3 Then, within 10 seconds, press the ENTER button.
 - The unit will enter the timer recording stand-by mode. (Power will be turned off.)

Note:

In the following cases, the timer recording function will not work

- When a MiniDisc has not been inserted
- When a playback-only MiniDisc is inserted
- When the MiniDisc you inserted is protected against accidental erasure
- When there is no recording space left on the MiniDisc you have inserted (when the "TOC FULL" or "DISC FULL" message appears)

To check the timer setting:

- 1 While in the timer standby mode, press the TIMER/DELETE button.
- 2 Press the ▲ or ▼ on the MULTI CONTROL button to select "TIMER CALL".
- 3 Within 10 seconds, press the ENTER button.
 - The timer settings will appear in order. Then, after 5 seconds, the original display will reappear.

To cancel the timer operation:

If the power is turned on, the timer will be canceled. The timer operation can also be canceled as follows.

- 1 While in the timer standby mode, press the TIMER/DELETE button.
- 2 Press the ▲ or ▼ on the MULTI CONTROL button to select "TIMER CANCEL".
- 3 Within 10 seconds, press the ENTER button.
 - The timer operation will be canceled. ("TIMER" or "TIMER PLAY" will disappear.) The start and stop times will be stored.

(Continued)

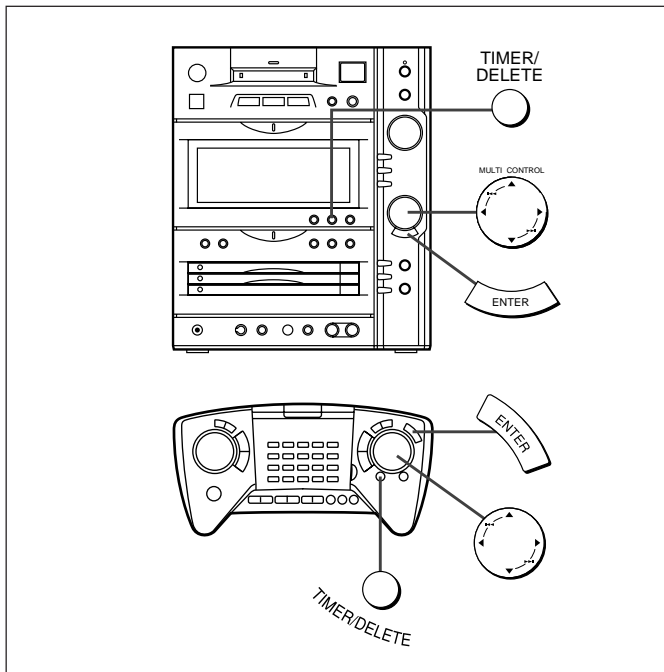

■ Sleep operation

The radio, compact disc and MiniDisc can all be turned off automatically.

- 1 Play the desired sound source.
- 2 Press the TIMER/DELETE button.
- 3 Press the ▲ or ▼ on the MULTI CONTROL button to select "SLEEP SET".
- 4 Within 10 seconds, press the ENTER button.
 - The time last stored in memory will appear.
 - If you wish to use the displayed time, press the ENTER button. The unit will be turned off automatically after the preset sleep time has elapsed.
- 5 Within 10 seconds, set the sleep time using the MULTI CONTROL button.
 - The setting time is changed in 5-minute increments between 2 hours and 5 minutes, or 1 minute increments between 5 minutes and 1 minute.
- 6 Press the ENTER button.

Notes:

- Once the sleep time is set, it will remain the same until the setting is changed.
- This sleep functions of this unit cannot be used to control equipment connected to this unit. You must use the sleep functions of the other equipment, if it has them.

Sleep operation

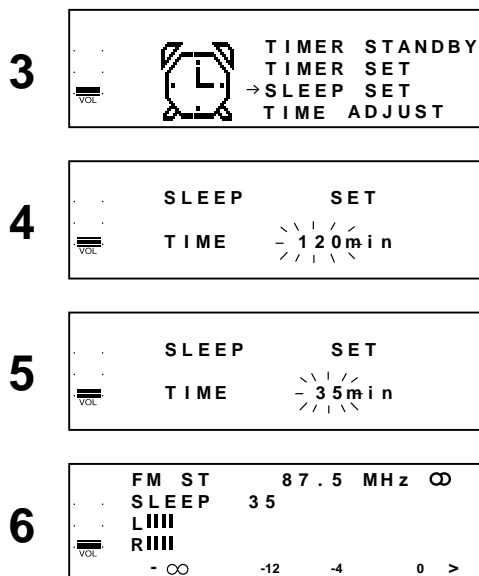

To confirm or change the sleep timer setting

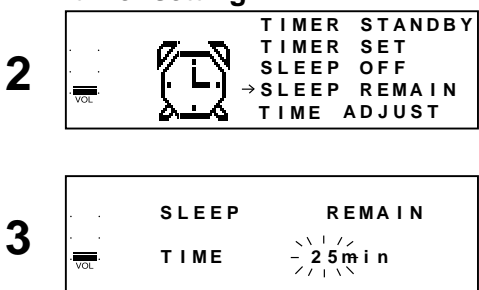

To cancel the sleep operation

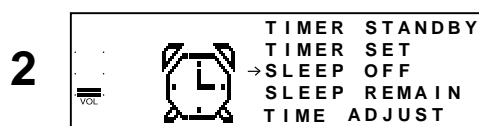

To confirm or change the sleep timer setting:

- 1 While in the sleep mode, press the TIMER/DELETE button.
- 2 Press the ▲ or ▼ on the MULTI CONTROL button to select "SLEEP REMAIN".
- 3 Within 10 seconds, press the ENTER button.
 - The current remaining time will appear, then after 5 seconds the display will return to its original appearance.

To change the remaining sleep time:

- 1 Perform steps 1 - 2 above.
- 2 Change the time using the MULTI CONTROL button.
- 3 Within 10 seconds, press the ENTER button.

To cancel the sleep operation:

If the power is turned on, the sleep will be canceled. The timer operation can also be canceled as follows if the power cannot be turned off during recording.

- 1 While in the sleep mode, press the TIMER/DELETE button.
- 2 Press the ▲ or ▼ on the MULTI CONTROL button to select "SLEEP OFF".
- 3 Within 10 seconds, press the ENTER button.
 - The sleep operation will be canceled. ("SLEEP" will disappear.)



(Continued)

1

TIMER	PLAY
ON	am 6:30
OFF	am 7:40
SOURCE	MD
VOLUME	2

2

SLEEP	SET
TIME	35min

3

FM ST	87.5 MHz	∞
SLEEP	35 / TIMER PLAY	
L		
R		
-	∞	-12 -4 0 >

■ Using timer playback and sleep operation in combination

When the sleep time has elapsed, the power will be turned off automatically. When the timer playback time is reached, the power will be turned on automatically to start playback.

- 1 Adjust timer playback settings. (See page 38.)
- 2 Perform sleep operation. (See page 42.)
- 3 Perform timer playback while in the sleep mode. (See page 39.)

1

TIMER	REC
ON	am 1:30
OFF	am 2:40
SOURCE	TUNER P-01
VOLUME	0

2

SLEEP	SET
TIME	35min

3

FM ST	87.5 MHz	∞
SLEEP	35 / TIMER REC	
L		
R		
-	∞	-12 -4 0 >

■ Using timer recording and sleep operation in combination

When the sleep time has elapsed, the power will be turned off automatically. When the timer record time is reached, the power will be turned on automatically to start recording.

- 1 Adjust timer recording settings. (See page 40.)
- 2 Perform sleep operation. (See page 42.)
- 3 Perform timer recording. (See page 41.)



USING EXTERNAL UNITS

- Before connecting external units, turn the power to this unit and external units off.

■ Connecting a personal computer

With a optionally available Digital sound card (AD-AJ1), you can use a personal computer to control the playing, editing, or recording of MDs inserted in this unit.

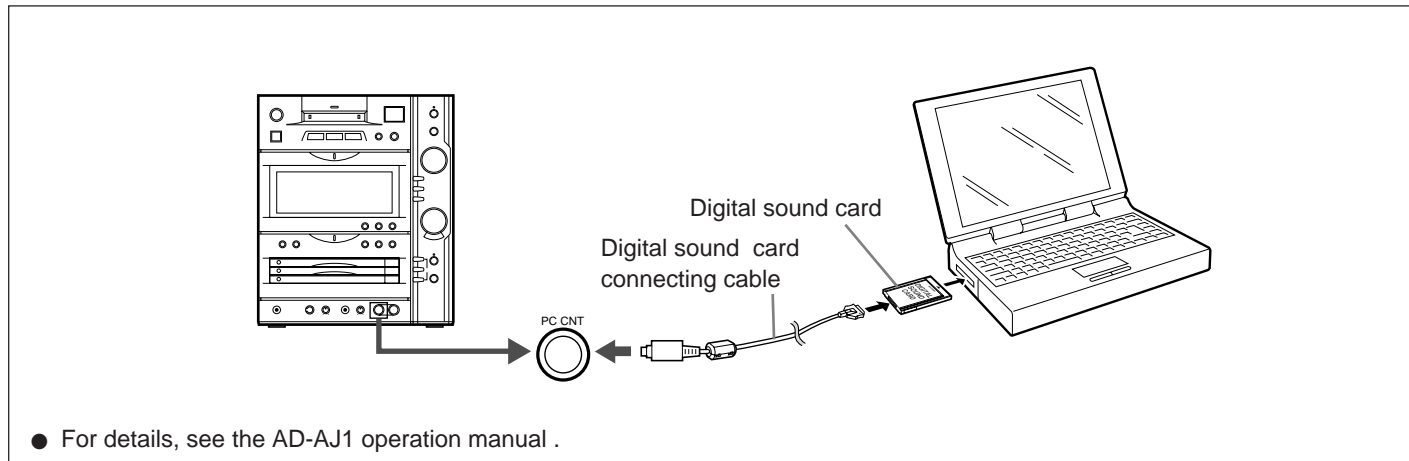

■ Connecting to digital audio sources

If a digital audio source is connected to this unit, you can make digital recordings.

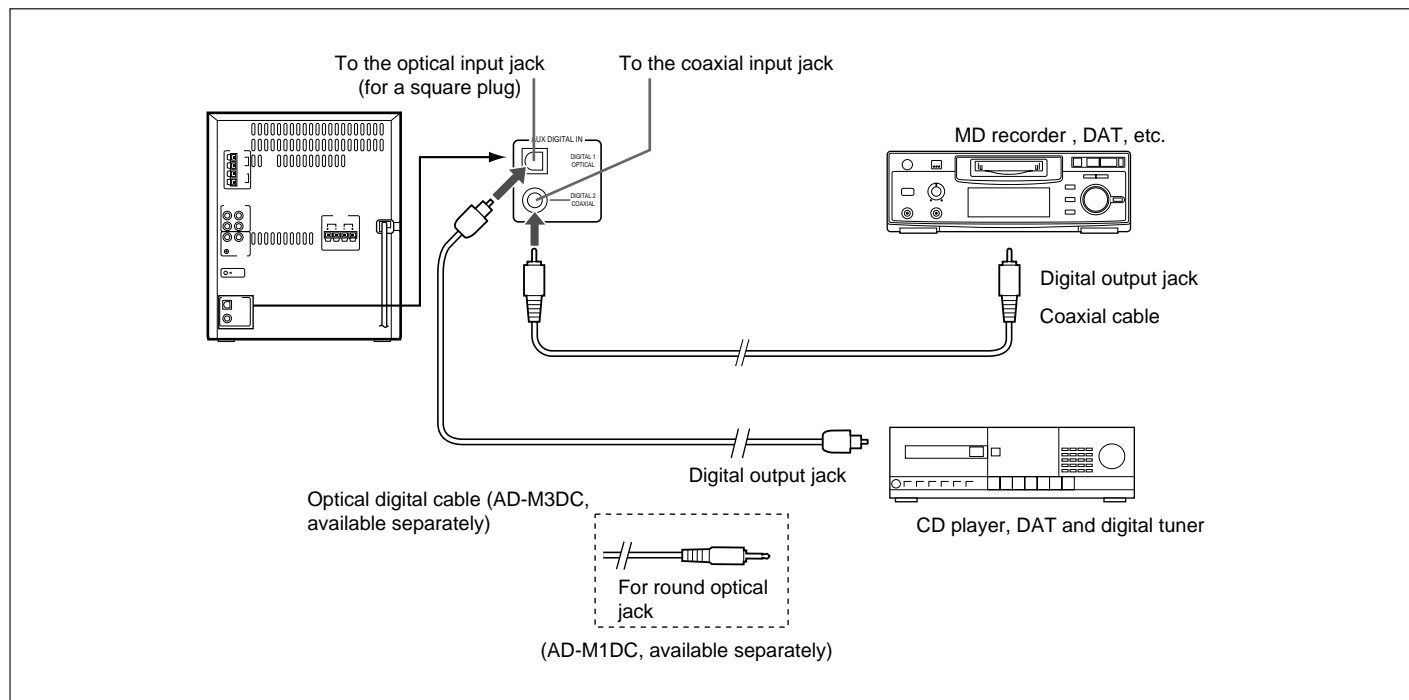

Note:

With a built-in sampling rate converter, you can enjoy high quality digital recording from CD players, DATs and digital tuners.





(Continued)

■ Connecting analog units

If any of a variety of analog audio sources are connected to this unit, you can make analog recordings.

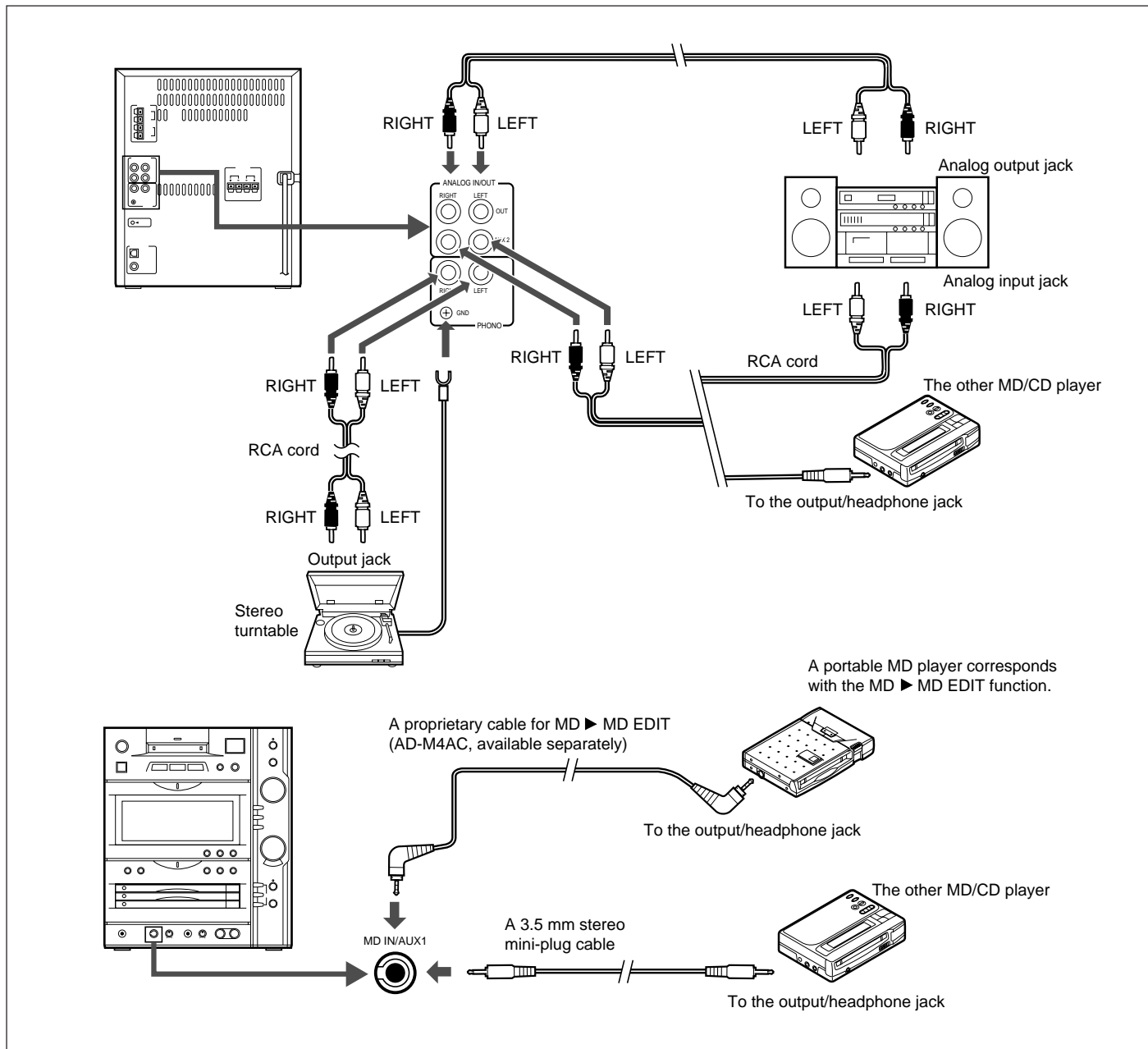

Notes

- When audio input and output signals of an external unit are connected to this unit, oscillation may occur. In such a case, disconnect either the input or output connection.
- When you use the MD ► MD EDIT function, the analog signal is recorded.

■ Headphones

- Be sure that your headphones have a 1/8" (3.5-mm) diameter plug and between 16 ohms and 50 ohms impedance. The recommended impedance is 32 ohms.
- When headphones are connected, the speakers are disabled automatically. Adjust the VOLUME control for the desired volume.

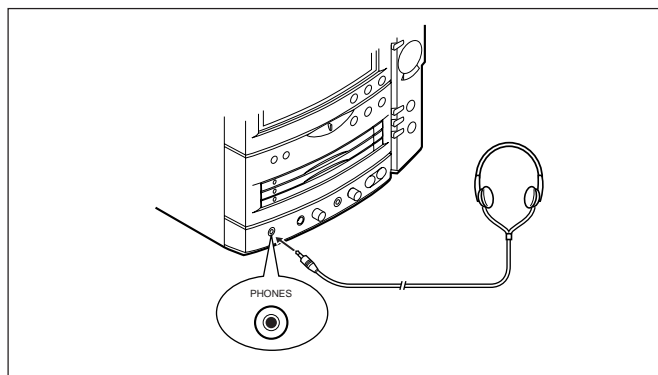



(Continued)

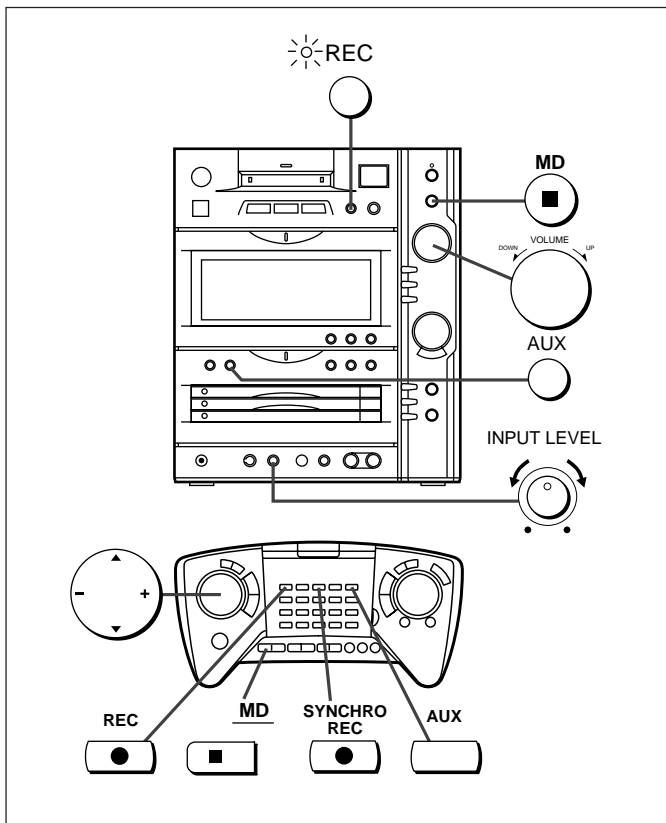

■ Listening to sound from an external unit

To listen to digital sound

- 1 Press the AUX button so that the AUX OPT. or AUX COAX display appears.
 - Each time the button is pressed, the display will change as follows: AUX1 → AUX2 → AUX OPT. → AUX COAX → PHONO
- 2 Start playback on the external unit.
- 3 Adjust the sound level using the VOLUME control of this unit.

Note:

In the following cases, "DIN UNLOCK" appears and playback sound is muted:

- When the external digital unit is off.
- When there is no digital input from the digital input jack.

To listen to analog sound

- 1 Press the AUX button so that the AUX 1 or AUX 2 display appears.
 - When connecting an external unit to the "MD IN/AUX1" terminal at the front of the main unit, select "AUX1". When connecting to the "AUX2" terminal at the rear of the main unit, select "AUX2".
- 2 Adjust the input sound level using the INPUT LEVEL control.
 - When the INPUT LEVEL control is turned counterclockwise, no sound is obtained.
- 3 Start playback on the external unit.
- 4 Adjust the volume using the INPUT LEVEL control and VOLUME control on this unit.

■ Synchro recording

MD recording will start automatically as soon as playback is started on the external unit. This applies to both digital inputs and analog inputs.

- The space-cut function will work automatically during synchro recording.
- Synchro recording is available only for recordings from an external unit.

- 1 Load a recordable MiniDisc.
- 2 Press the AUX button to select the auxiliary input.
 - Select the input that corresponds to the terminals where the external unit you want to record from is connected.
 - Each time the button is pressed, the display will change as follows: AUX1 → AUX2 → AUX OPT. → AUX COAX → PHONO
 - To record analog signals, perform steps 3 - 8.
 - To record digital signals, perform steps 6 - 8.
- 3 Press the REC button, then start playback on the external unit.
- 4 Adjust the recording level using the INPUT LEVEL control.
 - The maximum level should not exceed 0 dB.
- 5 Stop playback on the external unit.
- 6 Press the MD button.
- 7 Press the SYNCHRO REC button.
- 8 Start playback on the external unit.
 - Recording will start automatically.
 - To stop recording halfway, press the MD button.

Synchro recording

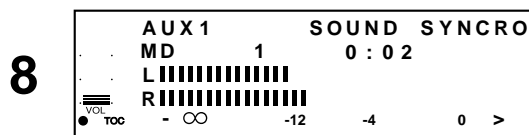
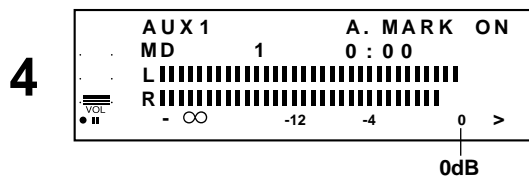
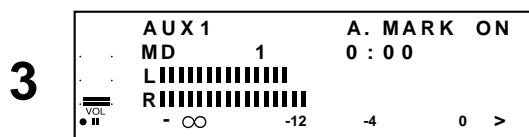
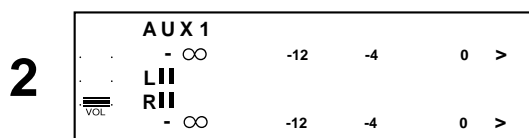



(Continued)

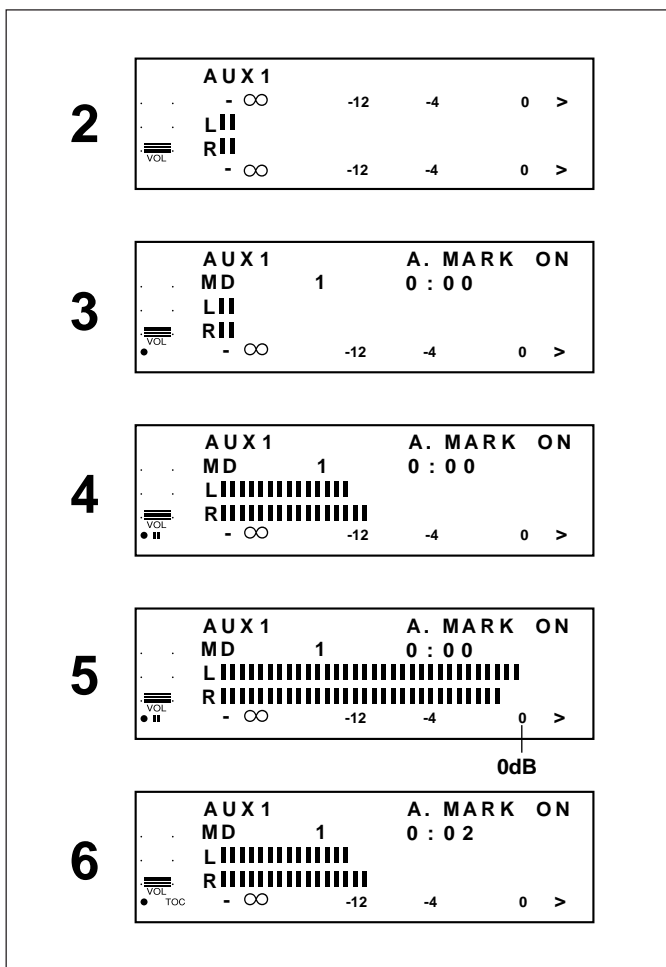
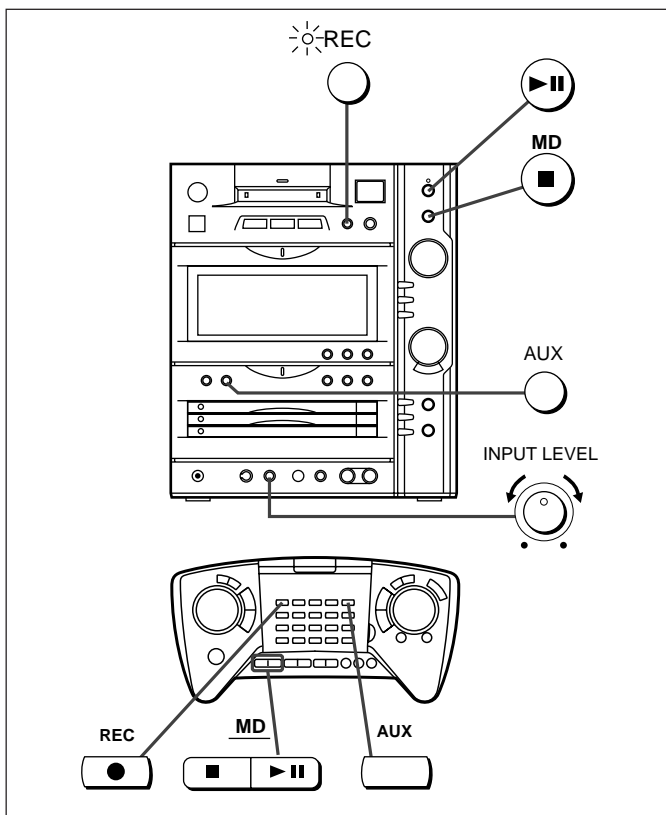

After finishing playback on an external unit:

The unit will automatically enter the recording stand-by mode. Press the MD button to cancel this mode.

- Pressing the MD button allows the unit to record the TOC. When performing other operations at the same time, perform them only after this is cleared from the display.

Space-cut function:

If there is silence lasting 4 seconds or longer in the playback signal during a synchro recording, recording will stop automatically and the unit will enter the recording stand-by mode.

Then, when playback resumes, recording will automatically restart. (A space of 4 seconds is placed between tracks.)

- If there is noise between tracks, the synchro recording or the space-cut function may not work properly. If this happens, record manually.
- When you need to record tracks or audio that include very weak sounds lasting 4 seconds or more, manual recording is recommended.

Manual recording

- 1 Load a recordable MiniDisc.
- 2 Press the AUX button to select the auxiliary input.
 - Select the input that corresponds to the terminals where the external unit you want to record from is connected.
 - Each time the button is pressed, the display will change as follows: AUX1 → AUX2 → AUX OPT. → AUX COAX → PHONO
- 3 Press the REC button.
 - When a CD is recorded from a digital source, "AUTO MARK" will not appear.

To turn off the auto mark function:

- Press the AUTO MARK button on the remote control.
- 4 Start playback on the external unit.
 - To record analog signals, perform steps 5 - 6.
 - To record digital signals, perform step 6.
 - 5 Adjust the recording level using the INPUT LEVEL control.
 - The maximum level should not exceed 0 dB.
 - 6 Press the MD button.

Track numbers

Recording CDs from a digital source:

Track numbers are automatically created to mark the beginning of each track in the signal being recorded.

- When making digital recordings from using a CD player as the source, track numbers may not be created automatically, depending on the CD player used.

Other considerations:

When there is a period of silence of 1.5 seconds or longer in the playback signal, a track number will be automatically created. If there is no silence, tracks will be recorded as one track.

- If there is a lot of noise in the playback signal, track numbers may not be created.
- Recordings can be made without using the auto mark function.

(Continued)

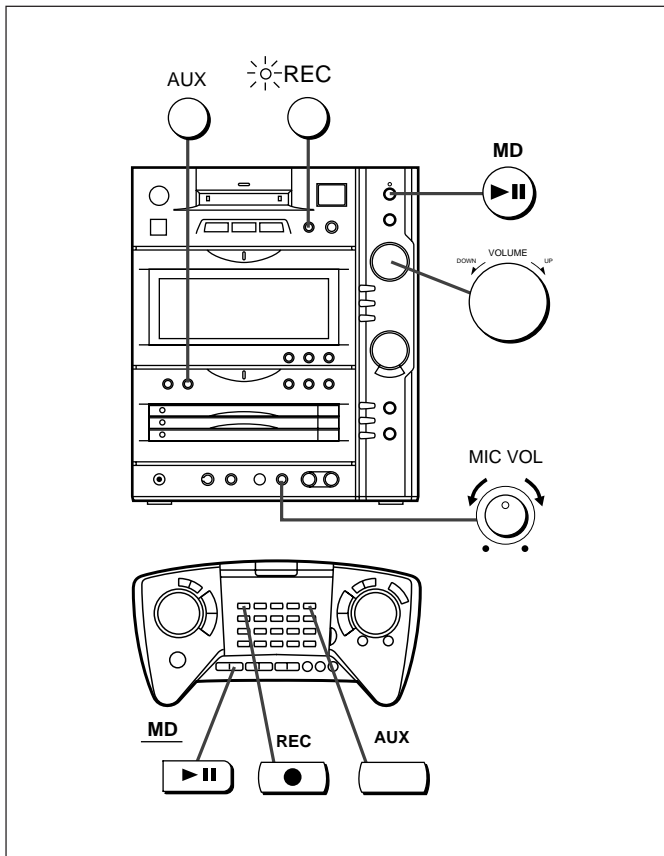

■ Listening to stereo turntable

- 1 Connect the output cables of the stereo turntable to the PHONO jack . (red → right channel, white → left channel)
- 2 Press the POWER button to turn the power on.
- 3 Press the AUX button so that the PHONO display appears.
- 4 Start the stereo turntable.
- 5 Start recording with this unit, and perform steps 2-5 of the "Recording from the built-in radio onto a MiniDisc" procedure. (See page 29.)

Note:

- The turntable must be outfitted with a magnetic type cartridge.

■ Using the microphone

You can record voices from the microphone to an MD or enjoy singing karaoke to the accompaniment of the playback sound from this product. (Mic mixing)

■ Using the microphone as a loudspeaker

- 1 Plug the microphone into the MIC jack.
- Set the MIC VOL control to the minimum position.
- 2 Speak into the microphone.
- 3 Adjust the volume using the MIC VOL control and the VOLUME control.

To record sound from the microphone:

- 4 Load a recordable MiniDisc.
 - 5 Press the AUX button so that the AUX 1 AUX 2 display appears.
 - 6 Press the REC button.
 - 7 Press the MD ►|| button.
- The sound from the microphone will be mono. (When using a stereo microphone, only the left channel will be effective.)
 - If the volume of the MIC VOL control is set too high, feedback may occur.
If this happens, take one or more of the following steps.
 - Decrease the MIC VOL control level.
 - Keep the microphone away from the speaker.
 - Change the orientation of the microphone.
 - Turn down the volume.

■ Mixing with music

- 1 Plug the microphone into the MIC jack.
- Set the MIC VOL control to the minimum position.
- 2 Speak into the microphone.
- 3 Adjust the microphone level using the MIC VOL control.
- 4 Select the sound source you want to play, and start playback.

To make a mixed recording:

- 1 Load a recordable MiniDisc.
 - 2 Perform steps 1-4 above.
 - 3 Press the REC button.
 - 4 Press the MD ►|| button.
- Make sure to connect the microphone first. If it is connected later, it will not be possible to make a mixed recording.

Notes:

- When not using the microphone, make sure to unplug it. Otherwise undesirable sounds may be heard, or recorded.
- When plugging in or unplugging the microphone, set the MIC VOL control to the minimum position.
- It is possible to record sound from an external analog source connected to the MD IN/AUX 1 or AUX 2 input terminals, mixed together with sound from the microphone.

However, when an external digital unit is connected to the AUX DIGITAL IN terminal, the sound picked up by the microphone will not be recorded on the MD, even though it can be heard through the speakers.



CHANGING THE MESSAGES DISPLAYED WHEN THE POWER IS TURNED ON/OFF

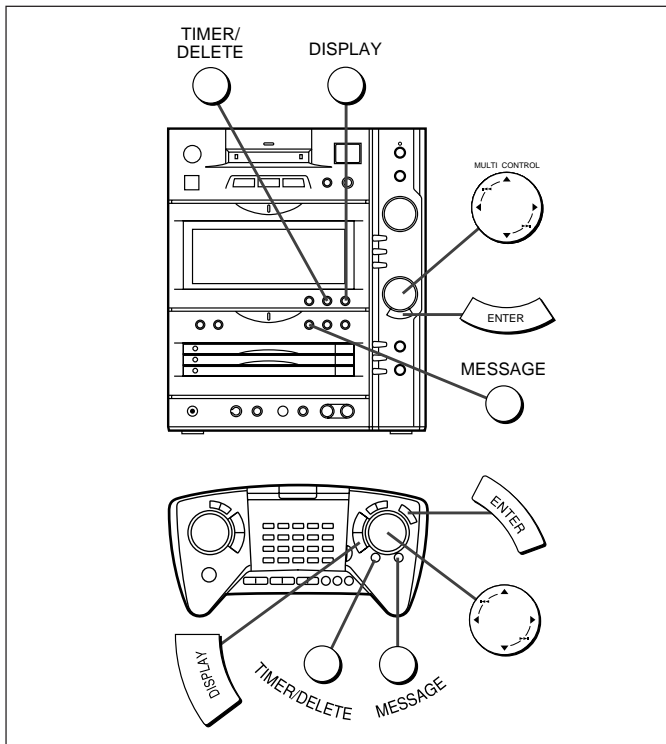

It is possible to change the message displayed on the LCD when the power is off, to suit your preference. It is also possible to select a previously stored message for display on a specified day when the power is turned on.

● COMMON MESSAGE

This is the message displayed on the LCD when the unit is powered off. The default message is "LET'S ENJOY MUSIC", but this can be changed to any other message you choose, up to 20 characters in length.

● SPECIAL MESSAGE

This is the message displayed when the power is turned on. You can even set the unit to display a special message only on a specified day. There are two ways to set a message: One is to select from one of the messages that came stored in the player's memory; the other is to enter a message of your own, up to 32 characters long, and store it in memory.

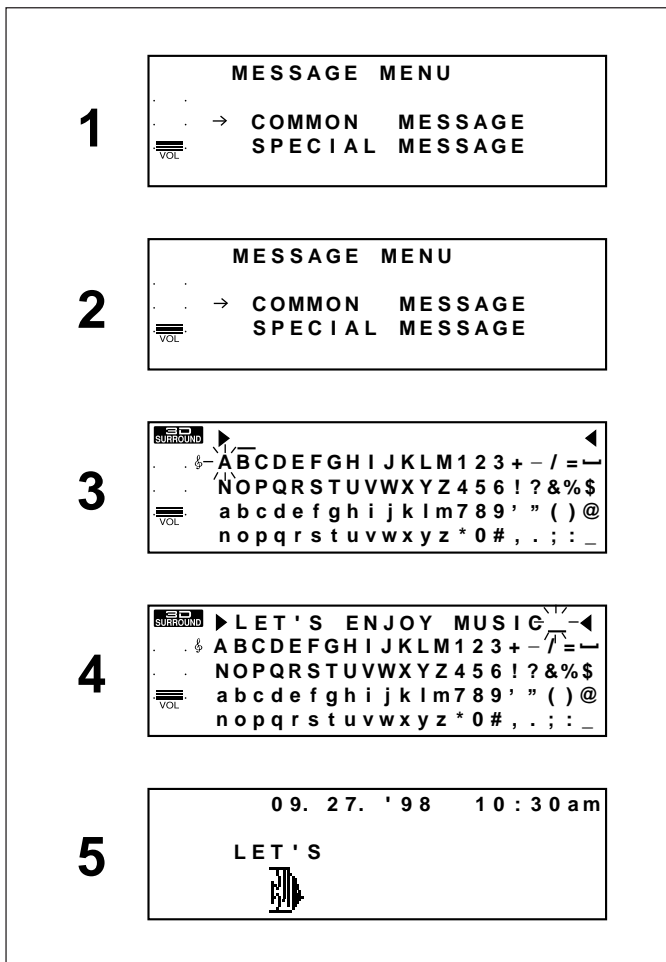

■ To change the common message

- 1 While in the stop mode, press the MESSAGE button.
 - This can be done even when the power is off.
 - To enter a message in extra large characters: Press the DISPLAY button to select the extra large character display.
- 2 Press the ▲ or ▼ on the MULTI CONTROL button to select "COMMON MESSAGE".
- 3 Press the ENTER button.
- 4 Enter the message you want to display.
 - Enter any message up to 20 characters long.
 - For details about entering characters and how to make corrections, see pages 13 - 16.
- 5 Press the MESSAGE button.
 - The common message will be changed. The next time the power is turned off, the new message will appear.

To return to the default common message:

- ① Press the TIMER/DELETE button in step 4 above to erase all message characters.
- ② Press the MESSAGE button.
 - The common message will return to "LET'S ENJOY MUSIC".

(Continued)

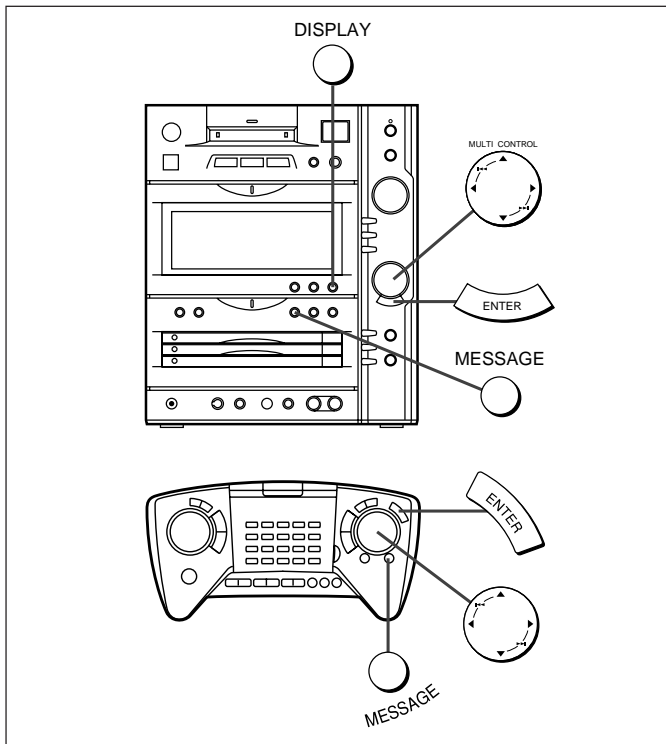

■ Storing a special message in memory

Selecting and storing a built-in message:

- 1 While in the stop mode, press the MESSAGE button.
 - You can do this even when the power is off.
 - To enter a message in extra large characters: Press the DISPLAY button.
- 2 Press the ▲ or ▼ on the MULTI CONTROL button to select "SPECIAL MESSAGE".
 - If the clock is not set, you cannot select "SPECIAL MESSAGE". Adjust the clock, and then try selecting again.
- 3 Press the ENTER button.
- 4 Enter the month and day that you want to display the special message, using the MULTI CONTROL button.
 - For details on how to enter the month and day, see page 10.
- 5 Press the ENTER button.
 - The built-in messages stored in memory will appear.
- 6 Press the ▲ or ▼ on the MULTI CONTROL button to select the message you want to display.

Types of fixed messages stored in memory

- 1 NEW MESSAGE for creating a custom message by yourself
 - 2 LAST MESSAGE ... for checking or changing a message
 - 3 HAPPY BIRTHDAY
 - 4 A MEMORABLE DAY
 - 5 CONGRATULATIONS
 - 6 HAPPY HOLIDAYS
 - 7 TIME TO PARTY
 - 8 HAPPY ANNIVERSARY
- } ... built-in messages

- 7 Press the MESSAGE button.

- A special message will be stored in memory. When the power is turned on when the specified day comes, the set special message will appear.

Note:

- You can store up to 12 special messages in memory. After this, each subsequent new message stored in memory will cause the earliest message to be erased.

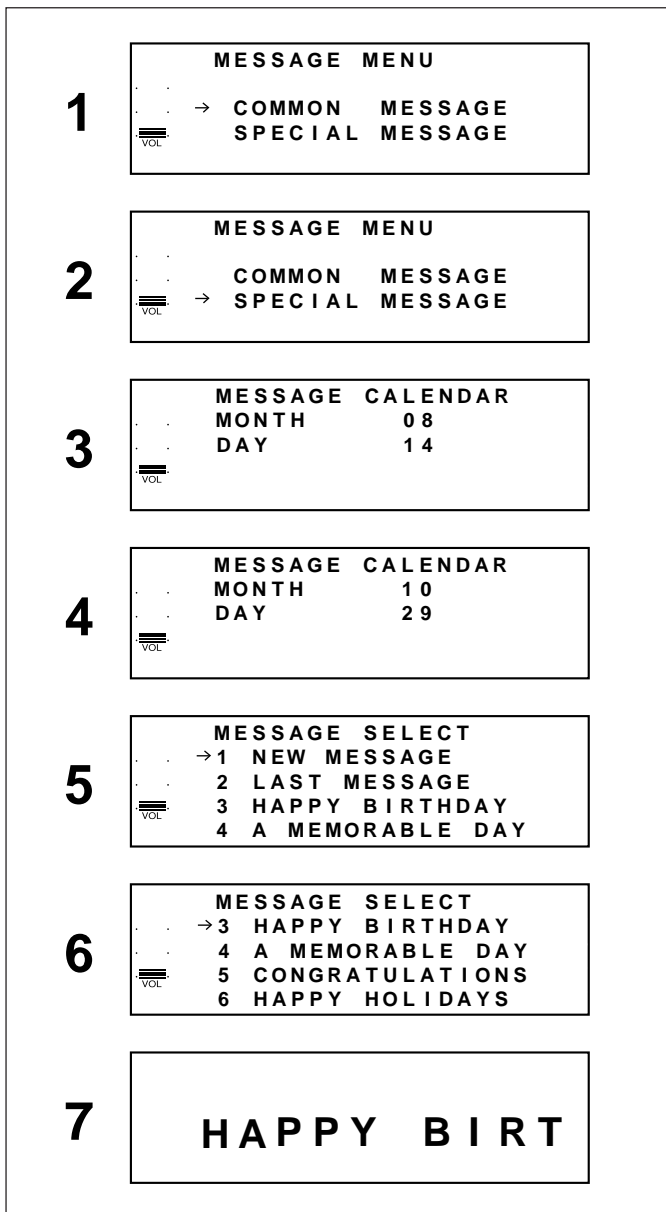

(Continued)

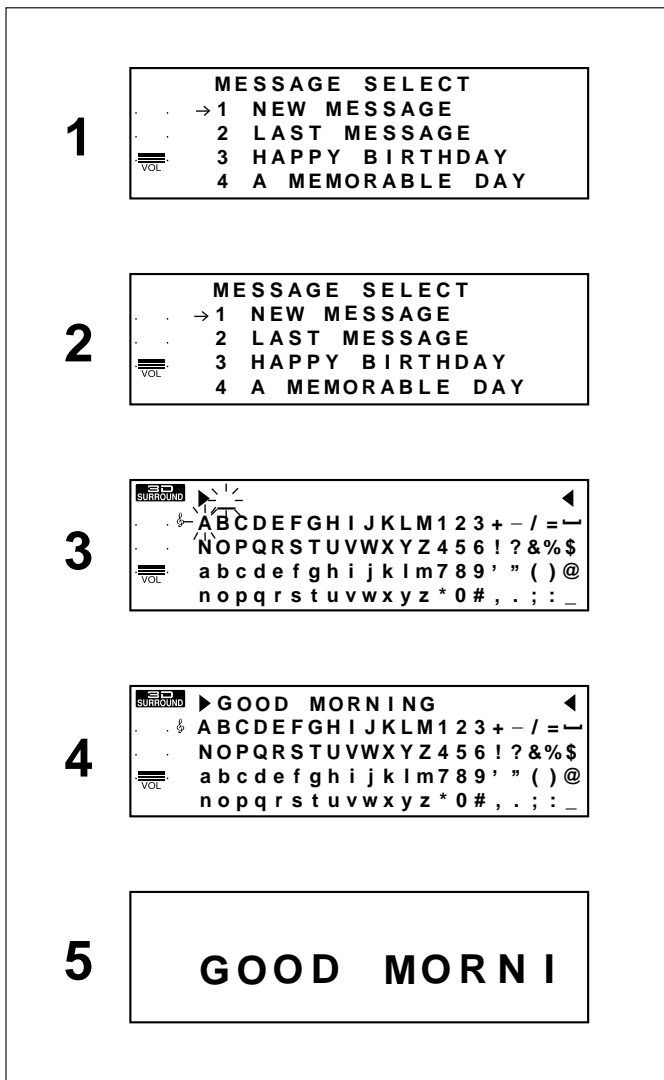
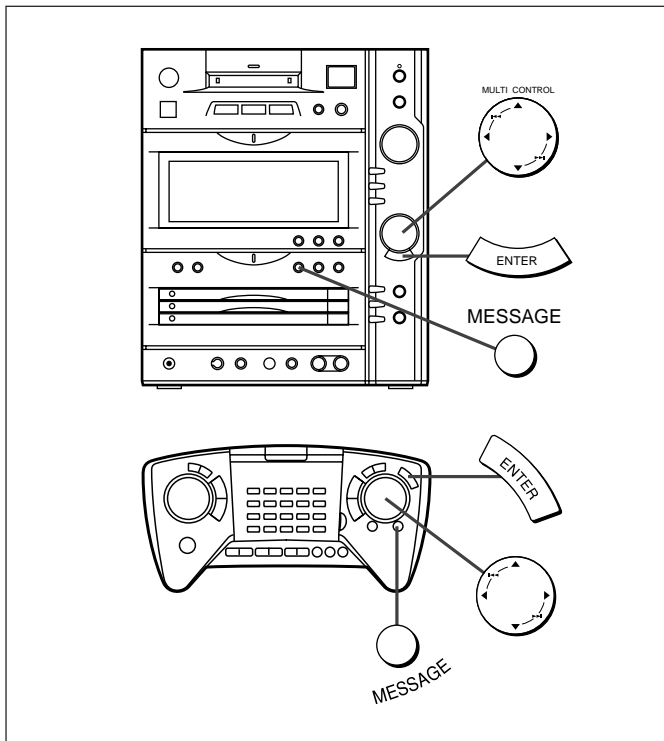

When creating your own message:

- 1 Perform steps 1 - 5 of "Selecting and storing a built-in message" (page 50).
- 2 Press the ▲ or ▼ on the MULTI CONTROL button to select "NEW MESSAGE".
- 3 Press the ENTER button.
- 4 Enter the message you want to display.
 - The message can be up to 32 characters long.
 - For details on entering characters and how to make corrections, see pages 13 - 16.
- 5 Press the MESSAGE button.
 - The message you created will be stored in memory. When the power is turned on on the specified day, your special message will appear.

To create a new message based on a built-in message:

By selecting one of the built-in messages, for example, "HAPPY BIRTHDAY", you can create another message by modifying it.

- ① Perform steps 1 - 6 of "Selecting and storing a built-in message" (page 50) to select the message you want to use.
- ② Press the ENTER button.
- ③ Add to the message being displayed or change it, as you like.
 - The final message must be no longer than 32 characters.
- ④ Finally, press the MESSAGE button.

To check or change a message:

- ① Perform steps 1 - 4 of "Selecting and storing a built-in message" (page 50). Then, specify the month and day on which the message you want to check or change is set to be displayed.
- ② Press the ENTER button.
- ③ Select "LAST MESSAGE".
- ④ Press the ENTER button.
- ⑤ Check or change the message.
 - To change the message, see pages 13 - 16.
- ⑥ Finally, press the MESSAGE button.

To cancel the special message setting:

- ① Perform steps 1 - 4 of "Selecting and storing a built-in message" (page 50). Then, specify the month and day on which the special message you want to cancel is set to be displayed.
- ② Press the ENTER button.
- ③ Select "LAST MESSAGE".
- ④ Press the ENTER button.
- ⑤ Press the TIMER/DELETE button to delete all the characters displayed.
- ⑥ Finally, press the MESSAGE button.
 - The display will return to "WELCOME TO SHARP MD WORLD".



WHAT IS A MINIDISC?

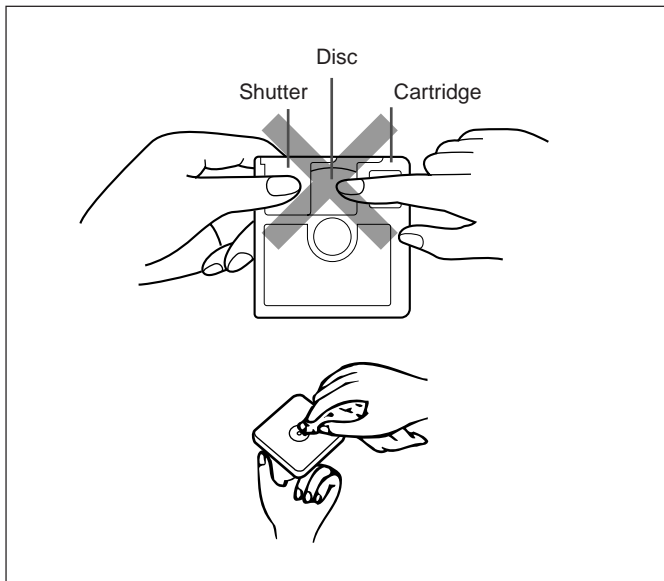

The disc is stored in a cartridge. You can handle it easily without worrying about dust, fingerprints, etc. However, dust entering the opening of the cartridge, dirt on the cartridge, etc. may cause malfunctions. Please note the following.

■ Handling MiniDiscs

Do not touch the disc directly!

Do not open the shutter or touch the disc directly. If the shutter is opened forcibly, it may break.

Where not to store discs:

Do not store discs in places with high temperatures or humidity. Specifically, do not leave discs in places exposed to direct sunlight or in cars with doors and windows closed. Do not leave discs in places where sand can get into the cartridge easily (e.g., a beach).

Regular cleaning:

If the surface of the cartridge becomes dusty or dirty, clean it with a soft, dry cloth.

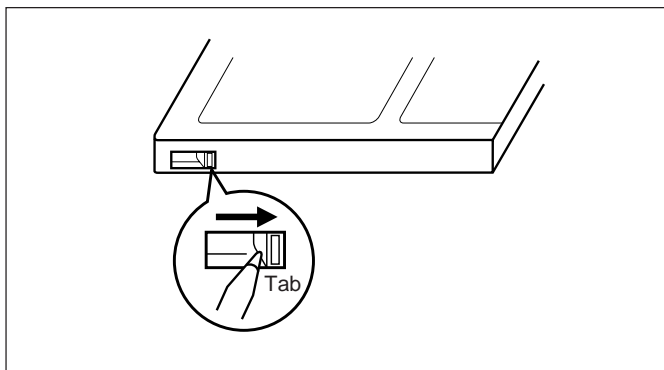

■ To prevent recorded discs from being erased accidentally (accidental erasure prevention)

Slide the accidental erasure prevention tab, located on the side of the disc, in the direction indicated by the arrow.

- The disc will then be protected against accidental erasure.
- To add a recording to such a disc, slide the accidental erasure prevention tab back to its original position.

■ What is a MiniDisc?

- A MiniDisc is a 2-1/2" (64-mm) diameter disc which is stored in a cartridge. MiniDiscs are easy to handle, compared with compact discs, because they are protected against dust and scratches.
- Recording and playback use a digital system with a sound quality that is similar to that with compact discs.
MiniDiscs cannot twist or stretch like tapes. The quality of sound will not deteriorate. MiniDiscs are extremely durable.
- Never disassemble a MiniDisc.

■ Adaptive Transform Acoustic Coding [ATRAC]

ATRAC (Adaptive TRansform Acoustic Coding) is a new technology that is designed to eliminate the information in sounds which you can not hear and to compress the remaining sound data so that the recording uses about 1/5 of the original sound information.

Sound data is analyzed and filtered to take advantage of psychoacoustic masking. The acoustic quality of the sound is not impaired.



(Continued)

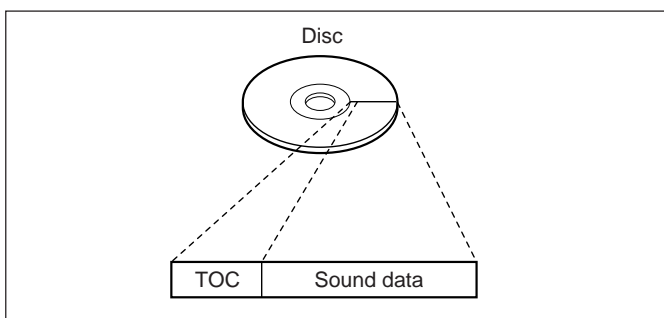
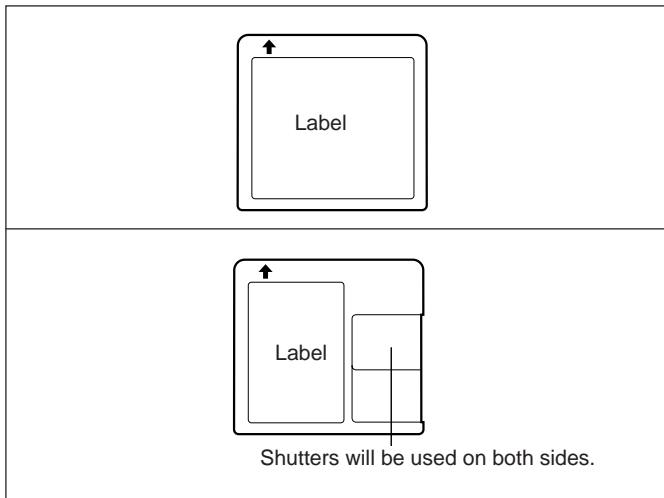

Types of discs

There are two types of MiniDiscs: playback-only and recordable type.

● Playback-only MiniDisc:

This type of MiniDisc is used for commercially available pre-recorded music. This is the same kind of optical disc as a CD. Playback is performed using an optical pickup. (Recording and editing are not possible.)

A shutter is used on only one side (back).

● Recordable MiniDisc:

This is a "blank disc" which recording can be performed. A magneto optical disc is used. Recordings are made using a laser and a magnet. Repeated recording is possible.

High-speed access

A unique feature of the MiniDisc is the ability to locate the beginning of a desired track at high speed.

This is because the track number and track name data are stored in a TOC (Table of Contents).

Shock-Resistant Memory

During playback, approximately 10 seconds of information is stored in the semiconductor memory. Therefore, even when the pickup cannot read information for a second or two because of external shock, the sound continues without interruption because the information stored in memory is output.

MINIDISC SYSTEM LIMITATIONS

Even if the maximum recording time of a MiniDisc is not reached, "DISC FULL" or "TOC FULL" may be displayed.

When the number of tracks used reaches the limit, regardless of the remainder being recording time, further recording will be impossible. (Maximum number of tracks: 255)

Even if the number of tracks and the recording time have reached the limit, "DISC FULL" may be displayed.

When emphasis information (equalizer treatment in the treble section) in a track switches on/off many times, each change is assumed to be the beginning of a new track, which will quickly use up all available track numbers, making further recording impossible, regardless of the remaining time, recording time or the number of tracks on the original.

Even if several short tracks are erased, the remaining recording time may not show an increase.

When the remaining recording time of a disc is displayed, short tracks less than 12 seconds long may not be included in the total.

Two tracks may not be combined in editing.

For MiniDiscs which repeated recording and editing operations were performed, the COMBINE function may not work.

The total of the recorded time and time remaining on a disc may not add up to the maximum possible recording time.

A cluster (about 2 seconds) is normally the minimum unit of recording. So, even if a track is less than 2 seconds long, it will use about 2 seconds of space on the disc. Therefore, the time actually available for recording may be less than the remaining time displayed.
If there are scratches on a disc, those sections will be automatically avoided (no recording will be placed in those sections). Therefore, recording time will be reduced.



TROUBLESHOOTING

■ If a problem occurs

If this unit functions abnormally during operation, first check the following items. If the unit continues to function abnormally, or if an abnormality appears other than listed below, turn off the player's power and disconnect the AC power plug, then consult your SHARP dealer or service personnel.

General

SYMPTOM	POSSIBLE CAUSE	REMEDY
• The clock is wrong.	• Did a power failure occur?	• Try setting it again.
• When a button is pressed, the unit does not respond.	—	• Turn the power off and on again, and then retry the operation.
• No sound is heard.	• Are the speaker wires disconnected? • Are the speaker wires shorted? • Is the volume level set to "0" ? • Are the headphones connected?	• Connect the wires securely. • Disconnect the AC power cord, and connect it again. • Increase the volume level. • Disconnect the headphones.
• Radios make unusual noise or the picture on the TV screen is distorted.	• When a radio or TV which uses an indoor antenna is placed near the unit, the picture on the TV screen may be distorted or the radio may not function properly.	• It is recommended that you use an outdoor antenna.

CD playback

SYMPTOM	POSSIBLE CAUSE	REMEDY
• Even though a disc has been loaded, "NODISC" or "ERROR" is displayed.	• The disc is loaded upside down. • The disc is very dirty.	• Load the disc with the correct side up. • Clean the disc.
• Playback stops in the middle of a track, or playback is not performed properly.	• The disc which does not satisfy the standards. • Is the unit located near excessive vibrations?	• Load the correct disc. • Place the unit on a firm, level surface free from vibration.
• Playback sounds are skipped.	• Has condensation formed inside the unit?	• Remove the disc and leave the power turned on. The unit should function properly in about 1 hour.

MD recording and playback

SYMPTOM	POSSIBLE CAUSE	REMEDY
• A recording cannot be made.	• Is the MiniDisc protected against accidental erasure? • Did you try to record on a playback-only MiniDisc? • Can you see the "TOC FULL" message in the display?	• Slide the accidental erase prevention tab back to its original position. • Replace it with a recordable disc. • Put in another recordable disc with recording space on it.
• Even though a disc has been loaded, "NODISC" or "ERROR" is displayed.	• The disc is very dirty. • Is the unit located near excessive vibrations?	• Clean the disc. • Place the unit on a firm, level surface free from vibration.
• Playback sounds are skipped.	• Has condensation formed inside the unit?	• Remove the disc and leave the power turned on. The unit should function properly in about 1 hour.

Radio reception

SYMPTOM	POSSIBLE CAUSE	REMEDY
• Radios make unusual noise consecutively.	• The unit is placed near the TV or computer. • The antenna direction is not placed properly.	• Place the unit apart from the noise. • Correct the antenna direction.
• The preset channel cannot be called.	• Did a power failure occur?	• Preset the channel again.

Remote control

SYMPTOM	POSSIBLE CAUSE	REMEDY
• The remote control does not function or does not operate properly.	• The batteries (polarity) are not inserted properly. • The batteries inside the remote control are dead. • The remote control is operated from an incorrect distance or angle.	• Insert properly. • Replace the batteries. • Operate it within a range of 8" (0.2 m) to 20' (6 m) and within an angle of 15° to either side of center.
• The power cannot be turned on from the remote control.	• Is the AC power cord plugged in?	• Connect the AC power cord.





(Continued)

When an error message is displayed, proceed as follows:

Error messages	Meaning	Remedy
BLANK MD	• Nothing is recorded.	• Replace the disc with a recorded disc.
Can't ACCESS	• The unit cannot access the personal computer. • While MD ► MEDIT, incorrect digital signals are input from the portable MD.	• Make sure the sound card is plugged in correctly. • Make sure the personal computer is operating normally. • Make sure the cable is connected correctly and the portable MDs power is on.
Can't COPY	• No copy can be made because of the SCMS copyright system.	• Record using the analog cable.
Can't EDIT	• A track cannot be edited.	• Change the stop position of the track and then try editing it.
Can't REC	• Recording cannot be performed correctly due to vibration.	• Rerecord or replace it.
DEFECT	• Since this disc has scratches on it, the recording operation was skipped.	• Replace the disc with another recordable disc.
CH ERROR	• The CD changer doesn't work well.	• Turn off the power, and disconnect the AC power cord from the AC outlet. Then connect the AC power cord, and turn on the power again.
CONNECT ERR	• While MD ► MD EDIT, incorrect digital signals are input from the portable MD player.	• Make sure the cable is connected correctly and the portable MD turns on the power.
Din UNLOCK	• Incorrect digital signals are input.	• Connect correct digital signals. • Use the analog input jack.
DISC ERR*	• The disc is damaged. • The TOC information is not recorded on the disc.	• Reload the disc or replace it.
DISC FULL	• The disc is out of recording space.	• Replace the disc with another recordable disc.
EDIT OVER	• There is no space left for recording CD.	• Replace it with another recordable disc.
FOCUS ERROR	• A disc has not been loaded. • The disc data cannot be read.	• Reload the MiniDisc.
MD ERROR	• Trouble is found.	• Contact a Sharp Authorized Servicing Dealer or Sharp Authorized Service station.
MECHA ERR*	• There is a mechanical problem and the disc is not working properly.	• Turn off the power, and press the ▲ button.
NAME FULL	• The number of characters for the disc name or track name exceeds 40.	• Shorten the disc or track name.
NO DISC	• A MiniDisc has not been loaded. • MiniDisc data cannot be read.	• Load a MiniDisc. • Reload the MiniDisc.
NOT AUDIO	• The data recorded on this disc is not audio data.	• Select another track. • Replace the MiniDisc.
PLAYBACK MD	• You tried to record on a playback-only disc. • The disc and track names cannot be moved on playback discs.	• Replace it with a recordable MiniDisc. • Edit only the sound.
PROTECT	• Trouble is found.	• Restart the unit. If the unit doesn't work, contact a Sharp Authorized Servicing Dealer or Sharp Authorized Service station.
PROTECTED	• The MiniDisc is write protected.	• Move the write protection tab back to its original position.
TEMP OVER	• The temperature is too high.	• Turn off the power, and wait for a while.
TOC ERR*	• The disc has a large amount of damage.	• Replace the disc with another disc.
TOC FULL*	• There is no space left for recording character information (track names, disc names, etc.).	• Replace it with another recordable disc.
TOC W ERROR	• Trouble is found.	• Contact a Sharp Authorized Servicing Dealer or Sharp Authorized Service station.
TRAY ERROR	• The disc tray for CD doesn't work well.	• Turn off the power, and disconnect the AC power cord from the AC outlet. Then connect the AC power cord, and turn on the power again.
U TOC ERR*	• The TOC information on this disc does not meet the MD specifications or it cannot be read.	• Replace it with another disc. • Erase all the data, and try recording.
U TOC W ERR	• The TOC information could not be created properly due to a mechanical shock or to scratches on the disc.	• Turn off the power, and try to write the TOC again. (Remove any source of shock or vibration while writing.)
? DISC	• The data contains an error.	• Replace the disc with another disc.
00:00	• Music is not recorded.	• Replace the disc with a recorded disc.

* Number or symbol





(Continued)

■ Moisture condensation

In the following cases, condensation may form inside the unit.

- Shortly after turning on a heater.
- When the unit is placed in a room where there is excessive steam or moisture.
- When the unit is moved from a cool place to a warm place.

When the unit has condensation inside, the disc signals cannot be read, and the product may not function properly.

- If this happens, remove the disc. The condensation should evaporate in approximately 1 hour. The unit will then function properly.

■ If a power failure occurs during recording

If the AC power plug is disconnected from the AC outlet or a power failure occurs during recording (before the TOC information has been recorded on the disc), the audio portion being recorded at that time will be erased.

When a recording is being added to a MiniDisc which already has a recording on it, if the TOC is not updated before the power failure, the added recording will be erased.

RESETTING THE MICROCOMPUTER

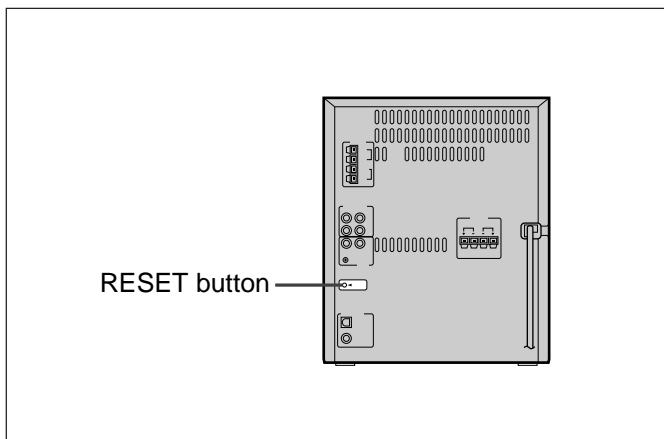

■ If a problem occurs

If subjected to any strong external interference (mechanical shock, excessive static electricity, abnormal supply voltage due to lightning, etc.), or if it is operated incorrectly, or if an MD cannot be removed, this product or the display may become damaged.

- 1 Unplug the AC power cord from the AC outlet.
 - 2 Press the RESET button on the back of the unit for at least 10 seconds.
 - 3 Plug the AC power cord back into the AC outlet.
- When the RESET button is pressed, all of the settings in memory will be erased.
 - If strange sounds, smells or smoke come out of the unit, or if a foreign object falls into the unit, turn off the power, unplug the AC power cord from the AC outlet immediately. Contact an authorized sharp services.



MAINTENANCE

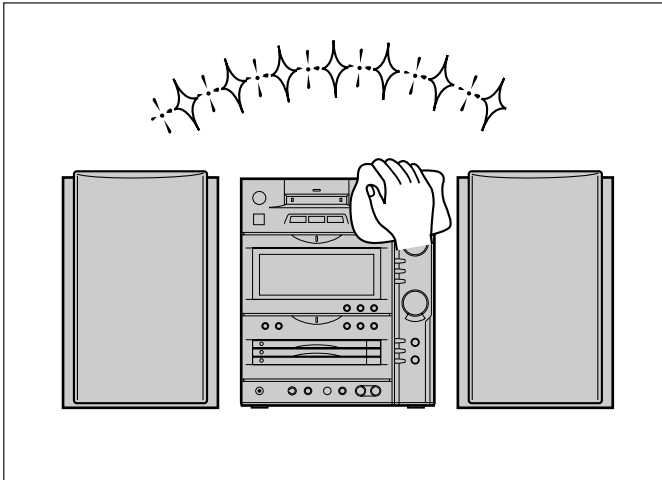

Internal care

- In order to ensure proper operation of the CD player, preventative maintenance (cleaning of the Laser Pick-up lens) should be performed periodically in order to keep the lens dust-free. Lens cleaners are commercially available. Contact your local CD software dealer for options.

External care

- Periodically wipe the cabinet with a soft cloth and dilute soap solution, then wipe with a dry cloth.
- Do not use chemically treated cleaning cloths or other chemicals.

SPECIFICATIONS

As a part of our policy of continuous improvement, SHARP reserves the right to make design and specification changes for product improvement without prior notice. The performance specification figures indicated are nominal values of production units. There may be some deviations from these values in individual units.

Main unit section

(MiniDisc recorder section)

Type:	MiniDisc recorder
Signal readout:	Non-contact, 3-beam semi-conductor laser pick-up
Audio channels:	Stereo 2 channels/monaural (long-play mode) 1 channel
Frequency response:	20 - 20,000 Hz (+1/-3 dB)
Rotational speed:	400 - 900 rpm CLV, Approx.
Quantization:	16-bit linear
Filter:	8-times oversampling digital filter
Error correction:	ACIRC (Advanced Cross Interleave Reed-Solomon Code)
Coding:	ATRAC (Adaptive Transform Acoustic Coding)
Recording method:	Magnetic modulation overwrite method
D/A converter:	1-bit
Sampling frequency:	44.1 kHz
Wow and flutter:	Unmeasurable (less than 0.001% W. peak)
Signal/noise ratio:	95 dB (1 kHz)
Dynamic range:	90 dB (1 kHz)

(Compact disc player)

Type:	3 disc multi-play compact disc player
Signal readout:	Non-contact, 3-beam semi-conductor laser pickup
Rotational speed:	200 - 500 rpm CLV, Approx.
Error correction:	CIRC (Cross Interleave Reed-Solomon Code)
Quantization:	16-bit linear
D/A converter:	1-bit
Filter:	4-times oversampling digital filter
Frequency response:	20 - 20,000 Hz (+1/-3 dB)
Signal/noise ratio:	95 dB (1 kHz)
Dynamic range:	90 dB (1 kHz)
Wow and flutter:	Unmeasurable (less than 0.001% W. peak)

(Tuner section)

Frequency range:	FM; 87.5 - 108 MHz AM; 530 - 1,720 kHz
Sensitivity:	FM; 2.5 μ V (75 ohms, unbalanced) AM; 650 μ V/m

(General)

Power source:	AC 120 V, 60 Hz
Power consumption:	135 W
Output power:	40 watts minimum RMS per channel into 6 ohms from 60 Hz to 20 kHz, 10 % total harmonic distortion
Input terminals:	AUX 1 (Analog); 500 mV/47 kohms AUX 2 (Analog); 500 mV/47 kohms AUX DIGITAL 1 (Optical) AUX DIGITAL 2 (Coaxial) PHONO; 3 mV/47 kohms
Output terminals:	Headphones; 16- 50 ohms (recommended; 32 ohms) Speakers; 6 ohms AUX (Analog); 2.0 V (1 kohm)
Dimensions:	Width; 9-1/2" (240 mm) Height; 11-7/16" (290 mm) Depth; 12-1/2" (317 mm)
Weight:	18.1lbs. (8.2 kg)

Speaker section

Type:	2-way 6" (150 mm) woofer and 1" (25 mm) dome tweeter type
Maximum input power:	100 W
Rated input power:	50 W
Impedance:	6 ohms
Dimensions:	Width; 7-13/16" (197 mm) Height; 11-3/4" (297 mm) Depth; 11-1/16" (281 mm)
Weight:	9.7lbs. (4.4 kg)/each

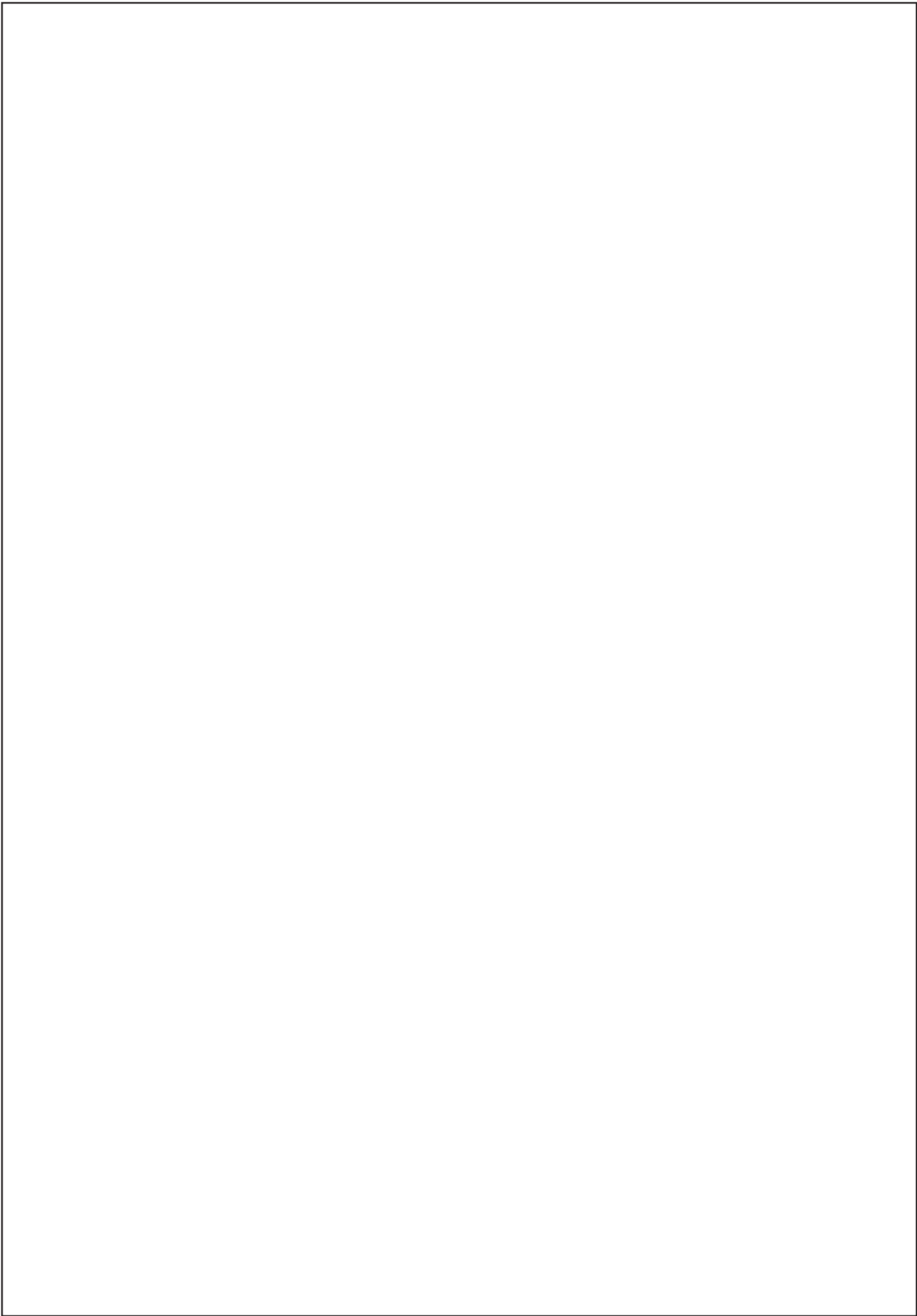



CALLING FOR SERVICE

For location of the nearest Sharp Authorized Service Center, or to obtain product literature, accessories, supplies or customer assistance, please call **1-800-BE SHARP**.

LIMITED WARRANTY

SHARP ELECTRONICS CORPORATION warrants to the first consumer purchaser that this Sharp brand product (the "Product"), when shipped in its original container, will be free from defective workmanship and materials, and agrees that it will at its option, either repair the defect or replace the defective Product or part thereof with a new or re-manufactured equivalent at no charge to the purchaser for parts or labor for the period(s) set forth below. This warranty does not apply to any appearance items of the Product nor to the additional excluded item(s) set forth below nor to any Product the exterior of which has been damaged or defaced, which has been subjected to misuse, abnormal service or handling, or which has been altered or modified in design or construction.

In order to enforce the rights under this limited warranty, the purchaser should follow the steps set forth below and provide proof of purchase to the servicer.

The limited warranty described above is in addition to whatever implied warranties may be granted to purchasers by law. ALL IMPLIED WARRANTIES INCLUDING THE WARRANTIES OF MERCHANTABILITY AND FITNESS FOR USE ARE LIMITED TO THE PERIOD(S) FROM THE DATE OF PURCHASE SET FORTH BELOW. Some states do not allow limitations on how long an implied warranty lasts, so the above limitation may not apply to you.

Neither the sales personnel of the seller nor any other person is authorized to make any warranties other than those described above, or extend the duration of any warranties beyond the time period described below on behalf of Sharp. The warranties described above shall be the sole and exclusive warranties granted by Sharp and shall be the sole and exclusive remedy available to the purchaser. Correction of defects, in the manner and for the period of time described herein, shall constitute complete fulfillment of all liabilities and responsibilities of Sharp to the purchaser with respect to the Product, and shall constitute full satisfaction of all claims, whether based on contract, negligence, strict liability or otherwise. In no event shall Sharp be liable, or in any way responsible, for any damages or defects in the Product which were caused by repairs or attempted repairs performed by anyone other than an authorized servicer. Nor shall Sharp be liable or in any way responsible for any incidental or consequential economic or property damage. Some states do not allow the exclusion of incidental or consequential damages, so the above exclusion may not apply to you. THIS WARRANTY GIVES YOU SPECIFIC LEGAL RIGHTS. YOU MAY ALSO HAVE OTHER RIGHTS WHICH VARY FROM STATE TO STATE.

Product Model Number: See your product for specific model number and have it available when requesting service for your Product.

Warranty Period for this Product: 1 year parts and labor from the date of purchase.

Exclusions from Warranty Coverage: non-functional accessories, supplies and consumable items.

How to Obtain Service: Contact a Servicer. To find the location of the nearest authorized Servicer, call Sharp toll free at 1-800-BE SHARP. Then, ship prepaid or carry in your Product with proof of purchase to the Servicer. If you ship the Product, be sure it is insured and packaged securely.

SHARP ELECTRONICS CORPORATION
Sharp Plaza, Mahwah, New Jersey 07430-2135

SHARP

SHARP ELECTRONICS CORPORATION
Sharp Plaza, Mahwah, New Jersey 07430-2135

SHARP CORPORATION

TINSE0182AWZZ

Printed in Malaysia
B9710.YO

Free Manuals Download Website

<http://myh66.com>

<http://usermanuals.us>

<http://www.somanuals.com>

<http://www.4manuals.cc>

<http://www.manual-lib.com>

<http://www.404manual.com>

<http://www.luxmanual.com>

<http://aubethermostatmanual.com>

Golf course search by state

<http://golfingnear.com>

Email search by domain

<http://emailbydomain.com>

Auto manuals search

<http://auto.somanuals.com>

TV manuals search

<http://tv.somanuals.com>