

Safety Information

EN

For UK Only

CONNECT THE MAIN LEAD INTO A MAINS POWER SOCKET

POWER SUPPLY **230V**. It must not be connected to D.C. mains.

Note: The mains lead of the set is fitted with a molded plug. If the mains socket are not compatible or if for any reason the plug is removed please follow the directions below. The molded plug cannot be rewired and if removed must be disposed of safely.

DO NOT under any circumstances plug the severed plug into any mains socket as this could result in electric shock.

Important: If the plug is removed, rewire the new plug as follow:
The wires in the mains plug are colored in accordance to the following code:

BLUE = NEUTRAL / BROWN = LIVE

If the colors of the wires in the mains lead of this apparatus may not correspond with the colored markings identifying the terminals in your plug, proceed as follows:

BLUE wire to the terminal coded N (Neutral) or colored black.

BROWN wire to the terminal coded L (Live) or colored red.

DO NOT make any connection to the terminal in the plug which is marked by the letter E or by the earth symbol or colored green or green and yellow.

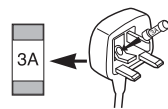

A fused plug must be fitted with a 3A fuse approved by ASTA or BS1362 and fuse covers must be always be securely replaced. If you set does not work, the fuse may be blown.

The descriptions and characteristics given in this document are given as a general indication and not as a guarantee. In order to provide the highest quality product possible, we reserve the right to make any improvement or modification without prior notice. The English version serves as the final reference on all products and operational details should any discrepancies arise in other languages.

Safety Information

CAUTION!

Invisible laser radiation when open. Avoid exposure to beam. Class 1 laser product. This system must be opened only by qualified technicians to prevent accidents caused by the laser beam.

LASER $\lambda = 780 \text{ nm}$, $P_{\text{max}} = 5 \text{ mW}$

Rating Information: At bottom/rear of the unit.

This unit comply with the existing requirements



In accordance with the rating plate of the unit, this unit complies with current standards concerning electrical safety and electromagnetic compatibility.



Please respect the environment Before throwing any batteries away, consult your distributor who may be able to take them back for specific recycling.



Have a Blast- Just Not in Your Eardrums Make sure you turn down the volume on the unit before you put on headphones. Increase the volume to the desired level only after headphone are in place.

EN

ADVARSEL!
 USYNLIG LASERSTRÅLING VED ÅBNING NÅR SIKKERHEDSAFBRYDERE ER UDE AF FUNKTION. UNGDÅ UDSÆTTELSE FOR STRÅLING.
VORSICHT!
 UNSICHTBARE LASERSTRALUNG WENN ABDECKUNG GEÖFFNET UND SICHERHEITS-VERRIEGELUNG ÜBERBRÜCKT. NICHT DEM LASERSTRAHL AUSSETZEN!

CAUTION – INVISIBLE LASER RADIATION
 WHEN OPEN AND INTERLOCKS FAILED OR DEFEATED. AVOID EXPOSURE TO BEAM.
ATTENTION – RAYONNEMENT LASER INVISIBLE
 DANGEREUX EN CAS D'OUVERTURE ET LORSQUE LA SECURITE EST NEUTRALISEE.
 EXPOSITION DANGEREUSE AU FAISCEAU.



CLASS 1 LASER PRODUCT
 LASER KLASSE 1
 APPAREIL A LASER DE CLASSE 1
 LUOKAN 1 LASERLAITE
 KLASSE 1 LASERAPPARAT

VARNING-
 OSYNLIG LASERSTRÅLING NÅR DENNA DEL ÄR ÖPPNAD OCH SPÄRRAN ÄR URKOPPLADE. BETRAKTA EJ STRÅLEN.
VARO!
 AVATTAESSA JA SOJALUKITUSOHITETTAESSA OLET ALTTIINA NÄKYMÄTTÖMÄLLE. LASERSÄTEILYLLE ÄLÄ KATSO SÄTEESEEN.

	CAUTION RISK OF ELECTRIC SHOCK DO NOT OPEN	
THE LIGHTNING FLASH AND ARROW-HEAD WITHIN THE TRIANGLE IS A WARNING SIGN ALERTING YOU OF "DANGEROUS VOLTAGE" INSIDE THE PRODUCT.	CAUTION: TO REDUCE THE RISK OF ELECTRIC SHOCK, DO NOT REMOVE COVER (OR BACK). NO USER-SERVICEABLE PARTS INSIDE. REFER SERVICING TO QUALIFIED SERVICE PERSONNEL.	THE EXCLAMATION POINT WITHIN THE TRIANGLE IS A WARNING SIGN ALERTING YOU OF IMPORTANT INSTRUCTIONS ACCOMPANYING THE PRODUCT.
SEE MARKING ON BOTTOM / BACK OF PRODUCT		

WARNING: TO PREVENT FIRE OR ELECTRICAL SHOCK HAZARD, DO NOT EXPOSE THIS PRODUCT TO RAIN OR MOISTURE.

Table of Contents

EN

Safety Information

Table of Contents1

Getting Started3

- Unpacking the system3
- Thomson multimedia Pack3
- Computer System Requirements3
- Back View4
 - Using the FM and Am Antennas4
 - Connecting the Speakers4
- Installation4

Music Management Software5

- Insert the Included CD-ROM into CD-ROM Drive5
- Installing Software Components5
 - Install System Applications5
 - Install MusicMatch Jukebox6
 - Launch the MusicMatch Software6
- Connecting the Audio System to the Computer7
 - Establishing USB Connection7

General Controls8

- Main Unit8
 - Front View8
 - Top View9
- Remote Control10
 - Installing Batteries11

Display12

Settings13

- Showing Demonstration13
- Setting the Clock13
- Setting the Timer13
 - Activating the Timer13
- Adjusting the Display Brightness14
- Sleep Mode14
 - View Remaining Sleep Time14
 - Adjust Sleep Time14

Sound Features15

- Volume Control15
- X-Bass15
- Muting Audio15
- Preset Equalizer Curves15
 - Creating Custom curves15

CD and mp3 Player16

- Important CD and mp3 Information16
 - Notes on CD-R/RW Discs16
 - The MusicMatch Jukebox16
 - Notes on mp3 Discs16
- Loading Discs17
- Play and Pause Discs17
 - Play and Load Simultaneously17
- Stop Playback17
- Selecting a Disc17
- Searching Through a CD17
- Repeat18
- Random Playback18
- Sampling Tracks18
- Track Information18
- Setting Up a CD Program (For Single Audio CDs)18
 - Playing a Program List19
 - Displaying the Program List19
 - Edit Program List19
 - Clear Program Location19

Table of Contents

File Navigation19
 mp3 Format20
 SmartTrax20
 Playing a mp3 disc21
 Track Information21
 Additional SmartTrax Features21
 Mode23
 Playlist (For SmartTrax CDs only)23
 My Selection (For SmartTrax CDs only)23
 Selecting Titles to be Placed into My
 Selection23
 View My Selection24
 Deleting Titles from My Selection24
 Delete All Titles from My Selection24

USB Mode25
 Selecting USB Mode25
 Selecting PC CD-ROM25
 Selecting File Source25
 USB Playback Features25
 Start and Pause Playback25
 Stop Playback25
 Skipping Files25
 Searching Files25
 Repeating Files25
 Selecting Internet Radio25

Radio26
 Selecting Tuner Band26
 Tuning to a Station26
 Using Presets26
 Auto Preset Programming26
 Manually Setting Presets26
 Suppressing Stereo Signal26
 Tuning to an RDS Station27
 Displaying RDS Station Information27
 Searching by Program Type (PTY)27

Tape Player28
 Selecting Tape Player28
 Playing a Tape28
 Tape Counter28
 Recording28
 From Tuner28
 From CD28
 From AUX28
 From USB28

Troubleshooting Tips29

Maintenance30
 Cleaning30
 CD Player30
 Tape Player30
 Handling CDs30
 Cleaning CDs30
 CD Lens Care30

Important Information31
 Safety Precautions31
 Headset Safety32
 Important Battery Information32
 Don't Infringe32
 Technical Specification32

EN

Getting Started

EN

Unpacking the system

You should have the following:

- one main unit (with 2 main speakers);
- one remote control;
- one FM antenna;
- one AM loop antenna;
- one MusicMatch Jukebox software CD;
- one USB cable;
- one user's guide;
- one Thomson Warranty Card

Thomson multimedia Pack

The Thomson multimedia Pack is an offer that includes the MusicMatch jukebox Music Management software, to be installed on your PC. Thanks to this software, you will enter the digital music world and benefit from numerous features :

- MusicMatch Jukebox allows to compress music files into mp3, mp3 PRO & WMA* (Windows Media Audio) formats recorded from your audio CDs, and to keep them on your PC. You could also use other audio sources for your
- It makes the search and download of internet music easier,
- It allows the management of your compressed music and the creation of your own playlists,
- The Jukebox is a true audio player installed on your PC,
- It gives access to thousands of net radios today available on the web.

You can listen and share the compressed music files played by MusicMatch jukebox directly on your Thomson audio system, and thus to enjoy the digital music with your system's rich features.

- Simply plug the 3.5mm PC-pin end of the cable into the speaker or headphone jack of your PC, and insert the twin RCA ends to the @/AUX connection of your Thomson audio system.
- Select the audio source on your system with the switch located on @ AUX.

For more information on MusicMatch Jukebox, go to www.musicmatch.com.

Computer System Requirements

- Pentium III 500MHz or higher recommended
Macintosh iMac G3 or higher
- Windows ®98SE, Me, 2000, or XP
Mac OS X Version 10.1.5 or higher
- Internet Explorer 4.0 or higher
- Internet access
- 100MB free hard disk space for the software
- 64MB RAM (128 MB recommended)
- CD-ROM drive capable of digital audio extraction
- USB port (2.0 recommended)
- Sound card

* Windows Media is a registered trademark of Microsoft Corporation.

Getting Started

Back View

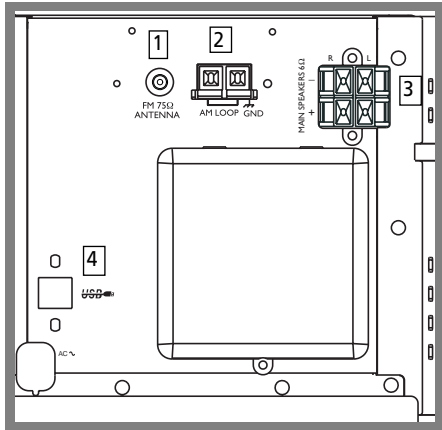

1. FM Antenna Connector.
2. AM Loop antenna Jacks.
3. Main Speaker Jacks.
4. USB port.

Using the FM and AM Antennas

Before you use your audio system, you'll want to make sure both the FM and AM antennas are positioned properly. Connect the FM antenna to the FM connector on the back of the unit. Uncoil it, making sure it is fully extended. (you may even want to tape it to the wall behind the unit if possible. The higher the better.)

You'll also need to connect the AM antenna loop to the back of the unit if you listen to AM stations. Rotate the AM loop antenna for better reception.

Connecting the Speakers

Match the red wire (on the left speaker) to red terminal for the left speaker (L) on the back of the unit and the black wire (on the left speaker) to the black terminal for left speaker (L). Follow the same procedure to connect the right (R) speaker.

EN

Speaker Wire Connection

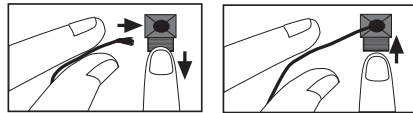

Push Speaker terminal tab down to insert wire. Release tab to lock wire in the terminal.

NOTE: Make sure the insulation is completely removed from the ends of the speaker wires at all connection points.

Installation

To ensure sufficient ventilation, keep the spacings shown below free from other surfaces:

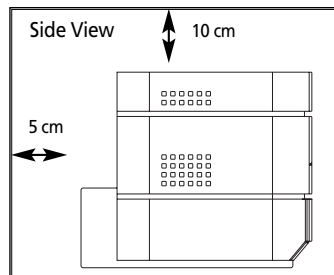
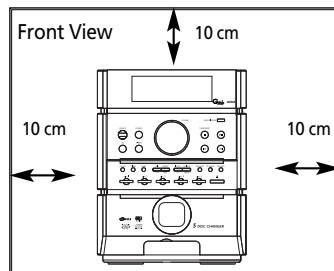

Music Management Software

EN

Insert the Included CD-ROM into CD-ROM Drive

1. Turn on your computer and place the Music Management CD that came with your audio system into your computer.



Note:

Don't connect the USB cable to the PC or the audio system before or during the driver installation.

2. If the setup screen does not appear, double click *My Computer*, double click your CD-ROM drive icon, and double click *Install* to run the installer.
The MusicMatch Jukebox quick start program runs.
3. Click on the software component you want to install. See next Section for details.



Installing Software Components

Install System Applications

1. Click *Install USB Audio System App* to install applications that will help you better manage your audio system.

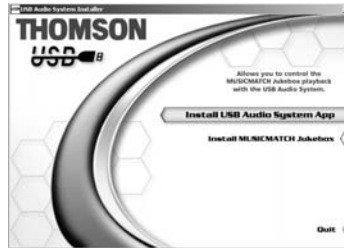

2. Follow the on-screen instructions to install all necessary files.
3. Click *Finish* to complete installation and return to the startup screen.

The USB icon appears on the system tray once the USB Audio System application installation is successful.

Music Management Software

Install MusicMatch Jukebox

MusicMatch Jukebox is a music management software used to organize and manage digital audio files and can be used to transfer the music to your audio system.



Note:

It is recommended to uninstall any previous installations of the MusicMatch Jukebox software before proceeding.

After the uninstall process has been completed, delete the MusicMatch folder found under C:\Program Files.

1. Click *Install MusicMatch Jukebox* to run the MusicMatch setup program. Wait while the installation program begins. It may take up to 20 seconds for the installer to start.

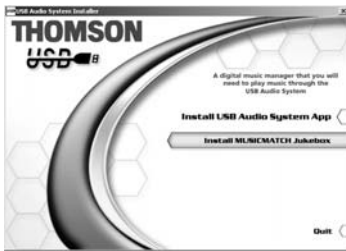

2. Follow the on-screen instructions to setup and install MusicMatch Jukebox.

For more information on MusicMatch Jukebox, go to www.musicmatch.com.

Launch the MusicMatch software

EN

The MusicMatch software converts audio files to the mp3, mp3PRO and WMA formats so you can play them on your audio system.

1. Remove the Music Management CD from your computer.
2. Start the MusicMatch Jukebox software (double click on the MusicMatch icon in your system tray or on your desktop).



The MusicMatch icon found in your computer's system tray.

For more information on MusicMatch Jukebox, go to www.musicmatch.com.

Music Management Software

EN

Connecting the Audio System to the Computer

Connect the audio system to your computer with the USB cable provided. Connect the smaller end of the USB cable to the USB port (**USB**) on the back of the audio system and the larger end to the USB port on the computer.

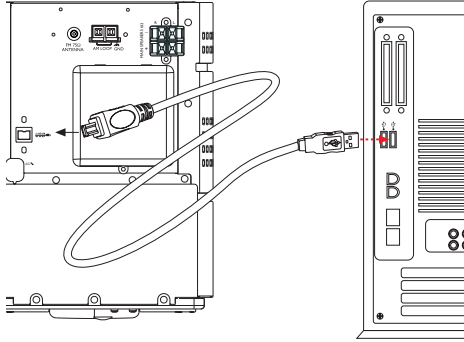

CONNECTED is displayed when USB connection is detected.

USB
CONNECTED

NO CONNECT is displayed when no USB connection is detected.

USB
NO CONNECT



Note:

When USB source is selected, music playback can be controlled using MusicMatch Jukebox.

For more information on MusicMatch Jukebox, go to www.musicmatch.com.

Establishing USB Connection

1. Open MusicMatch Jukebox on your PC (Refer to "Launch MusicMatch Software" on page 8)
2. Turn on the unit by pressing the **ON/ECO** button.
3. Select USB source on the audio system by pressing **SOURCE** on the main unit or **USB** on the remote control.

General Controls

Main Unit

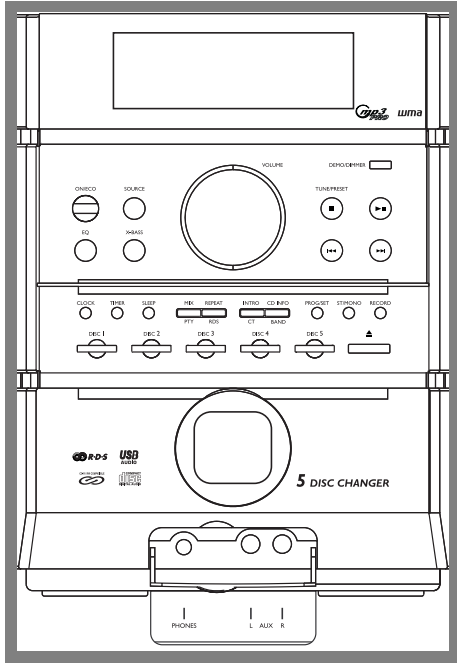

Front View

ON / ECO - Press and hold in standby mode to enter ECO (power saving, without clock display) mode. Press briefly to turn the unit on and off.



Tips:

In **STANDBY** mode (press **ON/ECO** off), the system displays the time. Press **ON/ECO** to turn the system on in the previously used mode. Press **SOURCE** on the main unit or **SOURCE** or **USB** on the remote control to select the corresponding mode. Look at the display icons to identify the current mode.

SOURCE - Selects CD player / tuner / tape player/ external source (AUX) / USB.

VOLUME - Adjusts volume.

EQ - Selects among different EQ options.

X-BASS - Turns X-Bass on/off.

DEMO/DIMMER - Turns the feature demonstration on or off; adjusts display contrasts.

TUNE/PRESET ■ - Stops CD, USB and tape operations, selects tune or preset mode.

PLAY/PAUSE ►|| - Plays or pauses CD, USB and tape operations.

SKIP FORWARD ►| - *In CD mode* - Goes to the next CD track; selects the next program location.

In USB mode - Skips to the next file;

In Tuner mode - Tunes up radio frequency; selects the next preset station.

In Tape mode - Fast forwards tape.

In Clock or Timer mode - Increases hour and minute digit.

EN

General Controls

EN

SKIP BACKWARD ⏮ - *In CD mode* - Goes to the previous CD track; selects the previous program location.

In USB mode - Skips to the previous file;

In Tuner mode - Tunes down radio frequency; selects the previous preset station.

In Tape mode - Rewinds tape.

In Clock or Timer mode - Decreases hour and minute digit.

CLOCK - Enters clock setting mode; shows clock time.

TIMER - Enters timer setting mode; Turns the timer on / off.

SLEEP - Selects sleep duration.

MIX/PTY - *In CD mode* - Selects random playback.

In Tuner mode - Selects search by program type.

REPEAT/RDS - *In CD mode* - Selects among repeat options.

In USB mode - Selects repeat all files;

In Tuner mode - Displays RDS information.

INTRO/CT - *In CD mode* - Selects intro playback.

In tuner mode - shows RDS time.

CD INFO/BAND - *In CD mode* - Selects display options to show track elapse time, track remain time or disc remain time.

In Tuner mode - selects radio band.

PROG/SET - *In CD and Tuner mode* - Enters program mode;

In Clock and Timer mode - applies new settings.

ST/MONO - Selects stereo and mono sound in tuner mode.

RECORD - Starts tape recording.

DISC 1 / DISC 2 / DISC 3 / DISC 4 / DISC 5 - Direct access to the corresponding disc tray for playback.

OPEN/CLOSE ▲ - Opens and closes disc compartment.

PHONES - Jack for connecting headphones.

AUX L/R - Jack for auxiliary connection.

Top Panel

OPEN/CLOSE ▲ - Press down on the door to open and close cassette deck door.

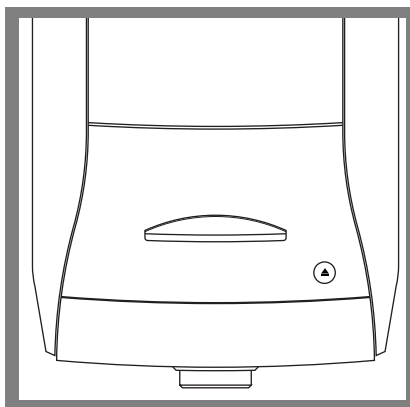

General Controls

Remote Control

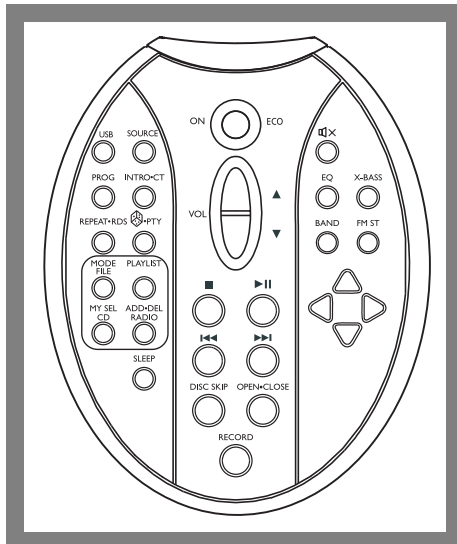

ON/ECO - Press and hold in STANDBY mode to enter ECO (power saving, without clock display) mode. Press briefly to turn the unit on and off.

USB - Selects USB source.

PROG - In CD and Tuner mode - Enters program mode;

In Clock and Timer mode - applies new settings.

INTRO•CT - In CD mode - Turns intro mode on or off to play the first 10 seconds of each track.

In tuner mode - shows RDS time.

REPEAT•RDS - In CD mode - Repeats a track, CD or all CDs.

In Tuner mode - displays RDS information.

In USB mode - Selects repeats all files mode.

PTTY - In CD mode - Turns on/off random listening.

In Tuner mode - Selects search by program type.

MODE / FILE - For mp3 disc with SmartTrax - Selects between SmartTrax mode and normal mp3 mode.

In USB mode - Selects file source mode.

PLAYLIST - For mp3 disc with SmartTrax - Activates playlist operation.

MY SEL / CD - For mp3 disc with SmartTrax - Access My Selection folder in Smart Trax.

In USB mode - Selects PC CD-ROM.

ADD•DEL / RADIO - For mp3 disc with SmartTrax - Adds and deletes mp3 songs or folder to /from My Selection.

In USB mode - Selects internet radio.

SLEEP - Press to select the time interval in minutes before the unit turns off.

VOL ▼ or ▲ - Decreases or Increases volume level.

STOP ■ - In CD and USB mode - Stops playback;

In program mode - Clears program;

In Tape mode - Stops tape playback.

PLAY/PAUSE ► II - In CD and USB mode - Plays and pauses CD or file;

In Tape mode - Plays and pauses tape playback.

EN

General Controls

EN

SKIP BACKWARD ◀◀ - *In CD mode* - Goes to the previous CD track and setting options; searches backward through CD;

In USB mode - Skips to the previous file;

In Tape mode - Rewinds tape;

In Tuner mode - Tunes down radio frequency.

SKIP FORWARD ▶▶ - *In CD mode* - Goes to the next CD track and setting options; searches forward through CD;

In USB mode - Skips to the next file;

In Tape mode - Fast forwards tape;

In Tuner mode - Tunes up radio frequency.

DISC SKIP - Skips to the next disc in CD mode.

OPEN•CLOSE - Opens and closes disc compartment.

RECORD - Starts tape recording.

MUTE - Mutes audio output.

EQ - Selects equalizer presets.

X-BASS - Turns on or off Bass Boost.

BAND - *In Tuner mode* - Selects radio band.

FM ST - Selects between stereo and mono sound in FM tuner mode.

UP ▲ - *In mp3 mode* - Selects the previous mp3 title.

In USB mode - searches backward files.

DOWN ▼ - *In mp3 mode* - Selects the next mp3 title.

In USB mode - searching forward files.

LEFT/BACK ◀ - *In mp3 mode* - Goes up one folder from current folder.

RIGHT /ENTER ▶ - *In mp3 mode* - enters current folder and show the first title from current folder.

Installing Batteries

The remote control must be inserted with 2 "AAA" or "UM-4" or "R03" batteries prior to use. Follow the steps below to ensure correct installation.

1. Remove the battery compartment door (located at the back of the remote control) by sliding the compartment door in the direction of the arrow and then lifting the door out and off the cabinet.
2. Before inserting the batteries, observe the polarities (that is, + and -) of the battery, then relate the polarities to the engraved diagram inside the battery compartment. Now insert the batteries.
3. After installation of the batteries, replace the battery compartment door in place by sliding it in the opposite direction of the arrow (the reverse of step 1).

Display

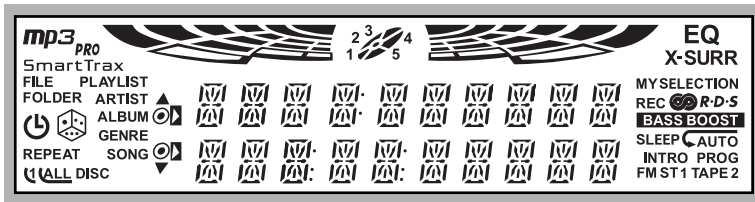

EN

DISC 1, 2, 3, 4, 5 - The corresponding disc number is displayed to Indicates which disc tray is loaded. The number will flash during playback to show which CD is currently playing.

mp3 / mp3 PRO / SmartTrax - Indicates the CD format.

FILE / FOLDER - Indicates the format of the current title for a mp3 CD.

PLAYLIST - On a SmartTrax CD, the icon indicates the current titles are from additional playlists on the CD.

ARTIST / ALBUM / GENRE / SONG - On a SmartTrax CD, these icons indicate the folder you are in after entering from the root directory.

- The timer is activated.

- Random playback feature is activated in CD mode.

REPEAT 1 / REPEAT ALL DISC / REPEAT 1 DISC -

In CD mode, the corresponding icons are displayed to Indicates the repeat option that is selected.

REPEAT 1 - repeat current track.

REPEAT ALL DISC - repeat all discs.

REPEAT 1 DISC - repeat current disc.

- When in SmartTrax CD mode, the icon indicates the title you are currently at is bookmarked into My Selection folder. If the icon appears in front of a folder, it indicates that all titles in that folder is bookmarked into My Selection.

- When in SmartTrax CD mode, the icon indicates some items in the current folder are selected into My Selection folder.

- When in mp3 CD mode, the arrow indicates your current position.

EQ - Indicates one of the preset equalizer is activated.

MY SELECTION - On a SmartTrax CD, the icon indicates you are currently in My Selection folder.

REC - Indicates recording is activated in tape mode.

RDS - RDS signal detected in tuner mode.

BASS BOOST - Indicates Bass Boost is activated.

SLEEP - Indicates sleep is activated.

INTRO - Indicates the Intro feature is activated in CD playback mode.

PROG - In Tuner mode, the icon is displayed when in preset mode. In CD mode, the icon is displayed when playing a CD program.

FM ST - In Tuner mode, the icon indicates the radio station is playing with FM stereo sound.

TAPE - Indicates the tape deck you are currently playing.

Settings

EN

Showing Demonstration

Press **DEMO/DIMMER** to turn on/off demonstration mode. The demonstration scrolls through all display operations.

Setting the Clock

1. Press and hold **CLOCK** until the hour flashes on the display.



0:00
CLOCK SET

2. Press **SKIP BACKWARD** \leftarrow or **SKIP FORWARD** \rightarrow to select the hour.
3. Press **CLOCK** to shift to minute digits.
4. Follow step 2 to set the minute digits.
5. Press **PROG/SET** to confirm and save settings. Press **STOP** \blacksquare to quit setting.



Note:

When system is ON, you can press **CLOCK** to display the current time (CURR TIME) for about 2 seconds.

Setting the Timer

1. Press and hold **TIMER** until ON 0:00 appears with the hour flashing (ON - timer on time).



ON 0:00
ALARM SET

2. Press **SKIP BACKWARD** \leftarrow or **SKIP FORWARD** \rightarrow to select the hour.
3. Press **TIMER** to shift to minute digits.
4. Repeat step 2 to select minute digits.
5. Press **TIMER** to shift to timer off time setting. 0F 0:00 (timer off time) will show on the display with the hour flashing.
6. Repeat steps 2 to 4 for timer off time setting.
7. Press **TIMER** to select source.
8. Press **SKIP BACKWARD** \leftarrow or **SKIP FORWARD** \rightarrow to select among TUNER / TAPE / CD MODE / REC TUNER.
9. Press **TIMER** to set volume.
10. Rotate the **VOLUME** knob to set the desired volume level.
11. Press **PROG/SET** to confirm and save settings. Press **STOP** \blacksquare to quit setting.

Activating the Timer

Press and release **TIMER** to activate and deactivate the timer. \odot lights when the timer is activated.

Settings

Adjusting the Display Brightness

1. Press and hold **DEMO/DIMMER** for more than 2 seconds.
2. The display will show the current dimmer level on the first row and **DIMMER SET** on the second row to indicate you are currently in dimmer setting mode.

LEVEL 1
DIMMER SET

While the dimmer level is displayed (e.g. LEVEL 1), press and release **DEMO/DIMMER** to select the desired display brightness level (DIMMER 1 - 3).



Note:

Dimmer level can only be adjusted when the unit is in **ON** mode.

In Standby mode, the dimmer level remains at level 3, while in magic demo mode, the dimmer level will be at level 1.

Sleep Mode

You can select the time interval in minutes before the unit turns off automatically. Press **SLEEP** to select among OFF, 120, 90, 60, 45, 30, 15 and 5 minutes. The "SLEEP" icon lights on the display when sleep mode is activated.

OFF
SLEEP TIME

View Remaining Sleep Time

When sleep is activated, press **SLEEP** once to view remaining sleep time.

Adjust Sleep Time

Press **SLEEP** again when the remaining sleep time is displayed to change sleep time.



Note:

Sleep is automatically de-activated when the unit is turned off.

EN

Sound Features

EN

Volume Control

Turn the **VOLUME** knob on the main unit or press **VOL** ▲ or ▼ on the remote control to adjust the volume level. The display briefly shows the change in volume level.

VOLUME 07
VOLUME SET

X-Bass

Press **X-BASS** to turn on/off boosting the bass frequency. The BASS BOOST icon lights on the display when it is activated.

Muting Audio

Press **MUTE** on the remote to cut the sound (Remote Only). MUTE flashes on the display.

Using Preset Equalizer Curves

Press **EQ** to toggle among FLAT, ROCK, POP, JAZZ, CLASSIC and CUSTOM. The current selection displays briefly.

FLAT
EQ MODE

Creating a Custom Curve

1. Press **EQ** to select CUSTOM mode.
2. While CUSTOM is displayed, press **SKIP BACKWARD** ◀ or **SKIP FORWARD** ▶ to select between BAS and TRE range levels.

BAS +02
EQ SET

3. While BAS or TRE is displayed, turn the **VOLUME** knob or press **VOL** ▲ or ▼ on the remote control to set the associated gain between -10 and 10.

CD and mp3 Playback

Important CD and mp3 Information

You can download music files encoded in mp3 from several Internet sites like www.mp3.com.

EN



This unit is compatible with CD-RW/ CD-R discs for playback.



Notes on CD-R/RW Disc:

- Do not affix any type of labels to either side (recordable or labeled side) of a CD-R/RW disc as this may result in the unit malfunctioning.
- To avoid damages to the CD-R/RW disc, do not open the disc compartment door while the disc is being read.
- Do not load an unrecorded CD-R/RW disc into the unit. This may take a longer time to read the disc.
- **Playback capability for CD-RW discs may vary due to variations in the quality of the CD-RW disc and the recorder used to create the disc.**



Notes on mp3 Disc:

- This unit supports mp3, mp3PRO and WMA format.
- Use .mp3 as the extension when converting audio files into mp3 for saving onto CD-R(W) or CD-ROM, e.g. Rocky08.mp3. Do not use any other extension e.g. .doc, .pdf.
- Do not use the .mp3 extension for other text or non-audio data files as this may result in serious malfunction and harmful noise interference.
- For better quality in mp3 disc playback, the CD quality should be recorded 128kbps or above.
- For UDF format (e.g. disc by Direct CD), please enable CDROM access after burning the disc when using CDR.
- Disc data size > 650MB is not recommended.
- Playback capability for CD-RW discs may vary due to variations in the quality of the CD-RW disc and the recorder used to create the disc.
- For mixed mode discs, only one mode will be selected for playback depending on the recording format.
- To ensure good performance, wait until the disc changer completely reads the disc before proceeding.
- mp3 files in CD ROM EXTRA format disc cannot be recognized.

The MusicMatch Jukebox



This music management software, to be installed on your PC, allows you to compress music files recorded from your audio CDs into mp3 format and stores them on your PC.

- It makes the search and download of Internet music easier,
- It allows for the management of compressed music and the creation of your own playlist,
- The Jukebox is a true audio player installed on your PC,
- It gives access to thousands of net radios available on the web today.

CD and mp3 Playback

EN

Loading Discs

1. Press **SOURCE** repeatedly to select CD mode.
2. Press **OPEN/CLOSE**  to open the disc compartment.
3. Insert up to 5 discs with label face up.
4. Press **OPEN/CLOSE**  again to close the disc compartment.

The occupied disc tray icons light and the current disc number shows on the display.

If the disc is a mp3 CD, the *mp3* icon lights on the display.



Attention:



Do not push to force closing of the tray during CD playback or tray opening.





Note:

Be sure to remove all discs from the disc compartment before moving or transporting the unit!

Play and Pause Discs

- Press **PLAY/PAUSE**  in stop mode to begin playback.
- Press **PLAY/PAUSE**  during playback to to pause disc. Press again to resume.

Play and load simultaneously by:

1. Press **OPEN/CLOSE**  to open the disc tray while a CD is playing.
2. Load/change discs for available trays.
3. Press **OPEN/CLOSE**  again to close the tray.





Stop Playback

During playback, press **STOP**  to stop playback.

Selecting a Disc

- Press **DISC 1**, **DISC 2**, **DISC 3**, **DISC 4**, or **DISC 5** on the main unit to directly access the corresponding disc.
- Press **DISC SKIP** on the remote control to skip discs.

Searching Through a CD

- Press **SKIP BACKWARD**  / **SKIP FORWARD**  to skip to the previous or next track.
- Press and hold **SKIP BACKWARD**  / **SKIP FORWARD**  to search through a CD while it is playing.

CD and mp3 Playback

Repeat

Press **REPEAT/RDS** to repeat the current track (REPEAT 1), current disc (REPEAT 1 DISC), all discs (REPEAT ALL DISC), or turn repeat mode off (ALL DISC).

Random Playback

Press **MIX/PTY** to activate and de-activate random playback.

The random icon  is displayed when it is activated.



Tips:

Random playback can be activated simultaneously with repeat 1 disc (randomly play tracks from one disc repeatedly) or repeat all discs (randomly play tracks from all discs repeatedly).

- For mp3 CD track information, press **CD INFO** repeatedly during playback to view Title, Album, Artist, Genre, Year and Bit rate. The information will scroll along the display and the corresponding indicator will light on the left of the display.

EN

Setting Up a CD Program (For Single Audio CDs only)





Tips:

You can create a program of up to 32 tracks.

- While the CD player is stopped, press **PROG/SET** to enter program mode. The system displays the next available program number.

-- PR0G01

- Press **SKIP BACKWARD**  / **SKIP FORWARD**  to select track to enter into memory.
- Press **PROG/SET** to save your settings.
- Repeat steps 2 and 3 to store more tracks into program memory.

Sampling Tracks

Press **INTRO/CT** to play the first 10 seconds of each track on the current disc, all discs in the tray, or turn INTRO mode off. INTRO is displayed when sampling is activated.

Track Information

- For audio CD track information, press **CD INFO** on the main unit to select among different CD display options: Track remaining time, Track elapsed time and disc elapsed time.

CD and mp3 Playback

EN

Playing a Program List

While in PROGRAM mode, press **PLAY/PAUSE** .

If you are not currently in program mode, press **PROG/SET** to enter program mode before pressing **PLAY/PAUSE** .

Display Program List

1. While the CD player is stopped, press **PROG/SET** to enter PROGRAM mode.
2. Press **PROG/SET** repeatedly to view each track assignment in the program list.



04 PR0G01

Edit Program List

1. Follow "Display Program List" steps until the location to be edited is displayed.
2. Repeat steps 2 to 4 under "Setting Up a CD Program" to edit the track to store into memory.

Deleting Program List

While in PROGRAM mode, press and hold **STOP** for 3 seconds. The system displays the message CLEAR.

File Navigation

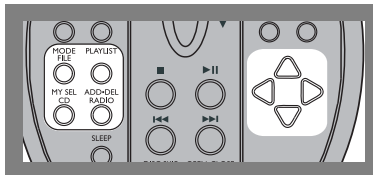

File navigation buttons are found on the remote control.

LEFT / BACK  - Goes up one folder from current folder.

RIGHT / ENTER  - Enters current folder and shows the first file/folder from current folder.

UP  - Selects previous file/folder.

DOWN  - Selects next file/folder.

MODE - Selects between SmartTrax mode and normal mp3 mode.

PLAYLIST - For mp3 CDs with SmartTrax, accesses additional CD playlists.

MY SEL - For mp3 CDs with SmartTrax, access My Selection folder.



Note:

The unit can access a maximum of 8 playlists.

ADD•DEL - For mp3 CDs with SmartTrax, adds and remove songs from My Selection

CD and mp3 Playback

EN



Note:

The display can show up to 10 characters per line at one time. If the item has more than 10 characters, it will scroll from left to right to show the entire item.

The number of characters available on the display varies among different items.

ITEM	MAXIMUM NUMBER OF CHARACTERS
Artist	16
Album	16
Song	16
Genre	12



Note:

The arrow cursor on the left side of the title indicates your current position.

SmartTrax

SmartTrax is a music management system that allows for the organization of mp3 or WMA files into 6 standardized categories. The categories include My Selection, Playlist, Artist, Album, Genre and Song.

This systematic arrangement shortens the initiation time for mp3 discs. Navigation also becomes easier as files are placed into folders. If the mp3 disc is formatted with the Smart Trax feature, the SmartTrax icon lights on the display. The items in the root directory consist of 4 categories: ARTIST, GENRE, ALBUM and SONG.

mp3 Format

When a mp3 audio disc is read, the mp3 icon will light on the display. The titles in the home directory will be displayed.

FOLDER will light on the display if the current title is a folder.



FILE will light if the current title is a file.







Note:

SmartTrax CDs can only be created using the MusicMatch Jukebox software. Go to www.musicmatch.com for MusicMatch Jukebox details.

CD and mp3 Playback

EN

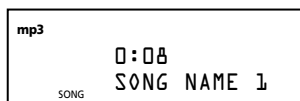

Playing a mp3 disc

1. Insert a mp3 CD into the CD tray, you will see the name of the first two folder (or root directory) displayed on the screen.
2. Press the **UP**  / **DOWN**  button to scroll up and down and select the title you want to access.
3. If the selected title is a folder, press **RIGHT** / **ENTER**  to enter into the folder selected. Press **LEFT** / **BACK**  to return to the previous folder.
4. Once the title you want to play is selected, press **PLAY/PAUSE**  button to start playback.



If a folder is selected for playback, all the songs in the folder will be played starting from the first title.

If a song is selected for playback, the selected song becomes the starting point. Playback continues until all songs after the selected one is played.

5. During playback, press **SKIP BACKWARD**  / **SKIP FORWARD**  to skip songs.
6. Press **Stop**  to end playback and resume navigation.

Additional SmartTrax Features

Navigating through SmartTrax CDs is similar to that of a normal mp3 CD. Additional features are available for Smart Trax CDs that make it more preferable.



CD and mp3 Playback

For a SmartTrax CD, when you enter into one of the folders in the root directory, the corresponding icon lights on the left side of the title to show your location. For example, if you enter into the Artist category, the ARTIST icon will light.

If you press **RIGHT / ENTER**  to enter further into a folder where all the songs are listed, Song icon will light.

EN

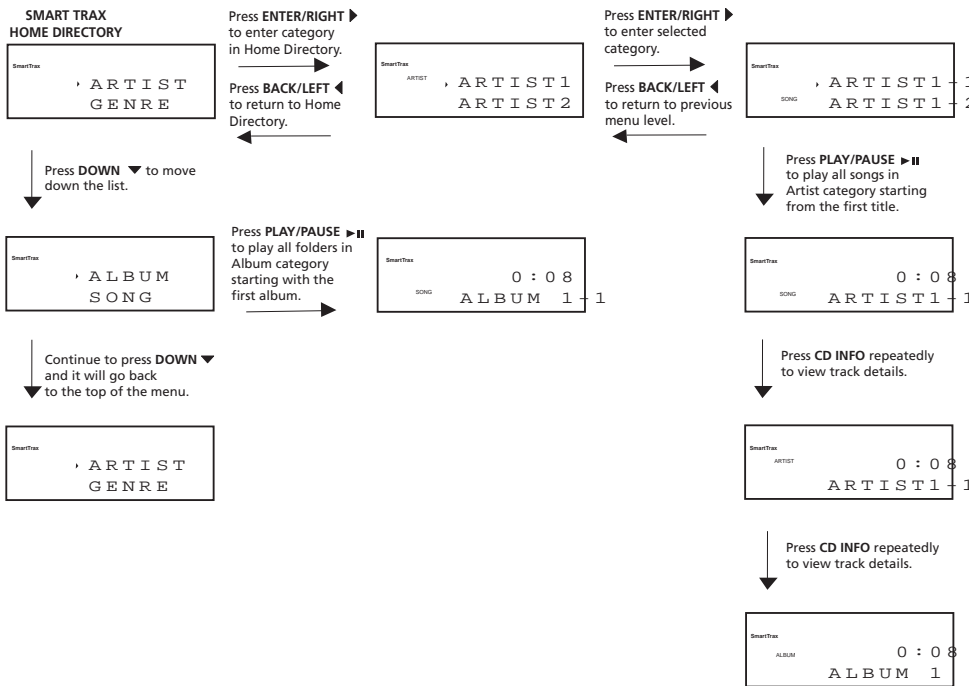

CD and mp3 Playback

EN Mode

With a SmartTrax CD, press **MODE** to select between SmartTrax mode and normal mp3 mode.

Playlist (For Smart Trax CDs only)

Press **PLAYLIST** to access additional playlists that are available on the CD.

My Selection (For Smart Trax CDs only)

Selected titles can be bookmarked and placed into My Selection folder.

Selecting Titles to be Placed into My Selection

1. Use the navigation buttons to select the title you want to place into My Selection.

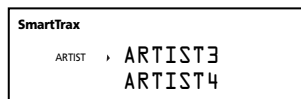

2. Press **ADD•DEL** to select the title. **ADD TO MY SELECT** will show on the display for a few seconds.

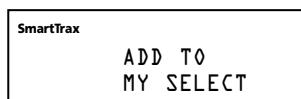

◉ icon will show on the left side of the title to indicate the item is selected.

If this icon appears in front of a folder, it indicates all items in the folder are selected.

○ icon indicates that certain items in the selected folder are selected.



If My Selection playlist is full, the display will show **MY SELECT IS FULL** and no additional titles can be added until space becomes available. Refer to "Deleting Titles from My Selection" to delete titles.

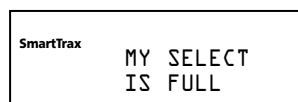

CD and mp3 Playback

View My Selection

Press the **MY SEL** button on the remote control to view items in My Selection folder. All titles in My Selection folder are listed as songs.

If there are no songs in My Selection, the below screen is displayed.



Delete All Titles from My Selection

EN

1. View titles in My Selection folder.
2. Press and hold **ADD•DEL**. The display will show as below.

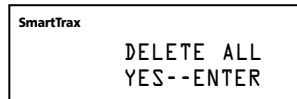

Press **RIGHT/ENTER**  while the message is still on display to confirm action.

Deleting Titles from My Selection

1. View titles in My Selection folder.
2. Use the navigation buttons to select the title you want to delete from My Selection.
3. Press **ADD•DEL** to delete the title. The display will show as below.

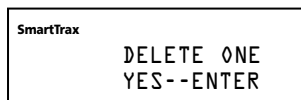

Press **RIGHT/ENTER**  while the message is still on display to delete the title.

USB Mode

EN

Selecting USB Mode

Press **SOURCE** repeatedly on the main unit or press **SOURCE** or **USB** on the remote control to select USB mode.



Note:

Make sure you have connected the audio system to your computer using the USB cable provided and MusicMatch Jukebox has been launched on your PC. (Refer to page 6 for more information)

Skipping Files

- Press **SKIP BACKWARD** ⏮ to skip to the previous file.
- Press **SKIP FORWARD** ⏭ to skip to the next file.

Searching Files

- Press **UP** ⬆ to search backward in a file.
- Press **DOWN** ⬇ to search forward in a file.

Repeating Files

In USB mode, press **REPEAT•RDS** to select repeat all files.

Selecting PC CD-ROM

1. Insert a CD into the PC CD-ROM drive.
2. In USB mode, press **MY SEL / CD** on the remote control to select PC CD-ROM source.

Selecting File Source

In USB mode, press **MODE / FILE** on the remote control to select file source mode.

USB Playback Features

Start and Pause Playback

Press **PLAY / PAUSE** ▶■ to start and pause playback.

Stop Playback

Press **TUNE / PRESET** ■ to stop playback operations.



Tips:

You can also use MusicMatch Jukebox to operate USB features.

For more information on MusicMatch Jukebox, go to www.musicmatch.com.

Radio

Selecting Tuner Band

1. Press **SOURCE** repeatedly to enter Tuner mode.
2. Press **CD INFO / BAND** to select between MW, LW or FM Radio band.



Tips:

Your audio system has 32 preset stations.

Tuning to a Station

Press **SKIP BACKWARD** \ll or **SKIP FORWARD** \gg to select frequency.

Using Presets

The tuner can be in either TUNE or PRESET mode. When in PRESET mode, the PROG light is on.

- Press **TUNE/PRESET** to toggle TUNE and PRESET mode.
- Press **SKIP BACKWARD** \ll or **SKIP FORWARD** \gg to access the previous or next preset station. The display first shows the preset program number and after a few seconds, the frequency will be displayed. (FMPR:01 is FM preset 1)

Auto Preset Programming

Press and hold the **CD INFO / BAND** button for 2 seconds to scan stations in FM band. The stations will then be stored as preset channels. A maximum of 32 stations can be stored. Beware of your preset channels being erased accidentally because the scanning and storing process is automatic upon pressing the button. You can stop the automatic scan by pressing any button, but the erased stations cannot be recovered.

Manually Setting Presets

1. Press the **TUNE/PRESET** button to enter TUNE mode.
2. Press **SKIP BACKWARD** \ll or **SKIP FORWARD** \gg to access the desired frequency.
3. Press the **PROG/SET** button once.
4. The most recently accessed program location will be displayed with the preset location flashing.

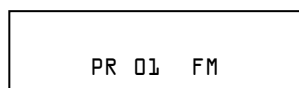

5. If a different program location is preferred, press **SKIP BACKWARD** \ll or **SKIP FORWARD** \gg to move to the desired preset number (1-32).
6. Press **PROG/SET** to store the selected frequency at that preset.

Suppressing Stereo Signal

Press **FM ST** to toggle between FM mono and stereo mode. (Remote Only) "ST" is displayed in stereo mode.

EN

Radio

EN

Tuning to a RDS Station



Note:

RDS stations broadcast on FM only. When the tuner detects an RDS signal, the RDS icons turn on.

1. Press **TUNE/PRESET** to access preset station or press **SKIP BACKWARD** or **SKIP FORWARD** to select desired frequency.
2. If RDS station found, **R•D•S** lights on display with station name shown.

Displaying RDS Station Information

Press **REPEAT / RDS** repeatedly to display the following:

- frequency,
- station name (PS),
- station type (PTY),
- clock time (CT), or
- radio text (RT).

In CT mode, press the **INTRO•CT** key to replace the displayed time with RDS station time.

Searching by Program Type (PTY)

1. Press **MIX/PTY** to enter PTY selection
2. Press **MIX/PTY** repeatedly to select a PTY mode.
3. Within 5 seconds, press **SKIP BACKWARD** or **SKIP FORWARD** to search for a station broadcasting the selected type of program.

You can search for stations using one of the following program types:





- NEWS (news),
- AFFAIR (news and documentaries),
- INFO (weather, medical),
- SPORT (sports),
- EDUCAT (education),
- DRAMA (series and plays),
- CULTUR (religion),
- SCIENC (science and technology),
- VARIED (miscellaneous),
- POP M (pop music),
- ROCK M (rock music),
- MOR M (middle-of-the road music),
- LIGHTM (light music),
- CLASS (classical music),
- OTHERM (unclassified music),
- WEATHE (weather, medical),
- FINANC (stock market reports),
- CHILD (children's programs),
- SOCIAL (sociology, history, geography, psychology, society),
- RELIGI (any aspect of beliefs, faith and God or Gods),
- PHONE (public forum b phone),
- TRAVEL (feature and programs concerning travelling),
- HOBBY (recreational activities and leisure),
- JAZZ (jazz music),
- COUNTR (country music),
- NATION (national music),
- OLDIES (oldies music),
- FOLK M (folk music),
- DOCUME (documentaries),
- TEST,
- ALARM (alarm).

Tape Player

Selecting Tape Player

Press **SOURCE** repeatedly to select tape mode.

Playing a Tape



1. In tape mode, press on the cassette door to open it.
2. Insert a tape into the door and push the door closed.
3. Press **SKIP BACKWARD**  / **SKIP FORWARD**  to position the tape to the desired starting position.
4. Press **PLAY**  to begin playback.
5. Press **PAUSE**  to pause playback.

Tape Counter



You can keep track of tape position with the tape counter. Press **PROG/SET** to reset.

Recording

From Tuner

1. Insert a tape into deck.
2. Press **SOURCE** repeatedly to select Tuner mode .
3. Press **BAND** to access the desired radio band.
4. Press **SKIP BACKWARD**  or **SKIP FORWARD**  to tune to the station to be recorded.
5. Press **RECORD** to begin recording.
6. press **STOP**  to end recording.



From CD

1. Insert a tape into deck .
2. Press **SOURCE** repeatedly on the main unit to select CD then press **DISC SKIP** on the remote control or **DISC 1 / DISC 2 / DISC 3 / DISC 4 / DISC 5** on the main unit to select the disc to be recorded.
3. Press **SKIP BACKWARD**  or **SKIP FORWARD**  to select the track to be recorded.
or
Press **PROG/SET** to enter program mode.
4. Press **RECORD** to begin recording.
5. press **STOP**  to end recording.

From AUX

1. Insert a tape into tape deck.
2. Check that the auxiliary device has been connected correctly to the AUX connector on the front of the system.
3. Press **SOURCE** repeatedly to select AUX mode.
4. Start playback on the auxiliary device.
5. Press **RECORD** to begin recording.
6. Press **STOP**  to end recording.

From USB

1. Insert a tape into deck.
2. Press **SOURCE** repeatedly to select USB mode.
3. Press **SKIP BACKWARD**  or **SKIP FORWARD**  to select the track to be recorded.
You can also use MusicMatch Jukebox to select the desired track.
4. Press **RECORD** to begin recording.
5. press **STOP**  to end recording.

EN

Troubleshooting Tips

EN

Problem	Solution	Problem	Solution
<i>System will not turn on</i>	<ul style="list-style-type: none"> • Check power cord for a secure connection. • Unplug the unit for a moment, and then plug into power source again. • Check the outlet by plugging in another device. 	<i>CD sound skips</i>	<ul style="list-style-type: none"> • Clean the disc. • Check disc for warping, scratches, or other damage. • Check if something is causing the system to vibrate. If so, move the system. • Make sure the speakers are at least 3 feet away or on a different surface from the main unit.
<i>No sound</i>	<ul style="list-style-type: none"> • Increase the volume setting. • Check connection to speakers. • Check that you have selected the appropriate function: CD, TAPE, Tuner. • Make sure mute is off. • Make sure headphones are not plugged in. 	<i>CD button will not respond, or does not change discs when you press DISC SKIP</i>	<ul style="list-style-type: none"> • Switch to another function (TAPE, Tuner) and then back to CD.
<i>Poor radio reception</i>	<ul style="list-style-type: none"> • Check antenna connection. • Move antenna. • Turn off nearby electrical appliances, such as hair dryer, vacuum cleaner, microwave, fluorescent lights. 	<i>Remote control does not work</i>	<ul style="list-style-type: none"> • Check that the batteries are properly installed. • Replace weak batteries. • Check the system is plugged into power source. • Point the remote directly at the system's front panel. • Move closer to the system. • Remove any obstacles between the remote and the system.
<i>CD does not play</i>	<ul style="list-style-type: none"> • Check that CD is in the tray. • Check that CD label is facing up. • Check that PAUSE mode is not on. • Check that CD function is selected. • Use CD lens cleaner. • Clean the disc. • Try another CD. 		
<i>Distorted or noisy tape recordings</i>	<ul style="list-style-type: none"> • Inspect the tape heads, clean it if necessary. 		

Maintenance

Disconnect the audio system from the power source before performing any maintenance.

Cleaning

Clean the exterior of the system using a soft dust cloth.

CD Player

CAUTION! This system operates with a laser. It must be opened by only a qualified technician.

Tape Player

To prevent deterioration of sound quality, periodically open the door of each deck and clean the magnetic heads, pinch roller, and capstan with a cotton bud dipped in alcohol. Also, demagnetize the head by playing a demagnetizing cassette (available through an audio equipment store).

To protect recordings one or both sides of a tape, remove the corresponding tab. If you later want to record on the tape, affix a piece of adhesive tape over the hole.

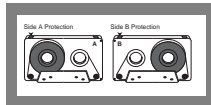

Quit Slacking - A little bit of slack in your tapes can cause scratches on the tape, or worse yet, the tape could break. If you notice some slack in the tape, use a pencil to tighten it up before you insert it.

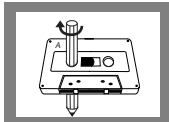

Handling CDs

EN

- Do not touch the signal surfaces. Hold CDs by the edges, or by one edge and the hole.
- Do not affix labels or adhesive tapes to the label surfaces.
- Do not scratch or damage the label. CDs rotate at high speeds inside the player.
- Do not use damaged (cracked or warped) CDs

Cleaning CDs

- Dirty CDs can cause poor sound quality. Always keep CDs clean by wiping them gently with a soft cloth from the inner edge toward the outer perimeter.
- If a CD becomes dirty, wet a soft cloth in water, wring it out well, wipe the dirt away gently, and then remove any water drops with dry cloth.
- Do not use record cleaning sprays or antistatic agents on CDs. Also, never clean CDs with benzene, thinner, or other volatile solvents which may cause damage to disc surface

CD Lens Care

When your CD lens gets dirty it can also cause the system to output poor sound quality. To clean the lens you will need to purchase a CD lens cleaner which can maintain the output sound quality of your system. For instructions on cleaning the CD lens, refer to the ones accompanying the lens cleaner.

Important Information

EN

Safety Precautions

- Never open the cabinet under any circumstances. Any repairs or internal adjustments should be made only by a trained technician.
- Never operate this product with the cabinet removed.
- Do not use your System immediately after transporting it from a cold place to a warm place, as condensation may cause the system to malfunction.
- Keep your unit away from humid areas and abnormally hot places.
- Do not touch the player with wet hands. If any liquid enters the player cabinet, take the player to a trained technician for inspection.
- This compact disc player uses a laser to read the music on the disc. The laser mechanism corresponds to the cartridge and stylus of a record player. Although this product incorporates a laser pick-up lens, it is completely safe when operated according to directions.
- Discs rotate at high speed inside the player. Do not use damaged, warped, or cracked discs.
- Do not touch the pick-up lens which is located inside the disc compartment. To keep dust from collecting on the pick-up lens, do not leave the compartment door open for an extended period of time. If the lens becomes dirty, clean it with a soft brush, or use an air blower brush designed for camera lenses.
- The apparatus shall not be exposed to dripping or splashing and that no objects filled with liquids, such as vases, shall be placed on the apparatus.
- Minimum distances around the apparatus for sufficient ventilation.
- The ventilation should not be impeded by covering the ventilation opening with items, such as newspaper, table-cloths, curtains, etc.
- No naked flame sources, such as lighted candles, should be placed on the apparatus.
- Attention should be drawn to the environmental aspects of battery disposal.

Important Information

Important Battery Information

- Remove the batteries to avoid leakage if you do not use your remote control for more than one month.
- Discard leaky batteries immediately as leaking batteries may cause skin burns or other personal injuries. Dispose of batteries in the proper manner, according to provincial and local regulations.
- Any battery may leak electrolyte under the following circumstances:
 - if mixed with a different battery type,
 - if inserted incorrectly,
 - if all batteries are not replaced at the same time,
 - if disposed of in fire, or
 - if an attempt is made to charge a battery not intended to be recharged.

Headset Safety

- Do not play your headset at high volume. Hearing experts warn against extended high-volume play.
- If you experience ringing in your ears, reduce volume or discontinue use.
- You should use with extreme caution or temporarily discontinue use in potentially hazardous situations.
Even if your headset is an open-air designed to let you to hear outside sounds, do not turn up the volume so high that you are unable to hear what is around you.

Don't Infringe

This product should only be used for the purposes for which it is sold, that is, entertainment, violating no copyright law. Any attempts to use this product for which it is not intended is unlawful and therefore not condoned by Thomson.

Technical Specification

Power supply: 230V~50Hz

Dimensions (H x W x D mm):

Unit size - 265 x 205 x 305

Speaker - 335 x 230 x 255

Tape deck: Response curve: 125Hz-8kHz (-5dB)

CD player: Response curve (+/- 2dB): 60Hz to 5kHz

Rating Plate: Look for it at the bottom / rear of the set.

EN

Free Manuals Download Website

<http://myh66.com>

<http://usermanuals.us>

<http://www.somanuals.com>

<http://www.4manuals.cc>

<http://www.manual-lib.com>

<http://www.404manual.com>

<http://www.luxmanual.com>

<http://aubethermostatmanual.com>

Golf course search by state

<http://golfingnear.com>

Email search by domain

<http://emailbydomain.com>

Auto manuals search

<http://auto.somanuals.com>

TV manuals search

<http://tv.somanuals.com>