

Technics®

AV Control Stereo Receiver

Operating Instructions

Model No. **SA-AX540**

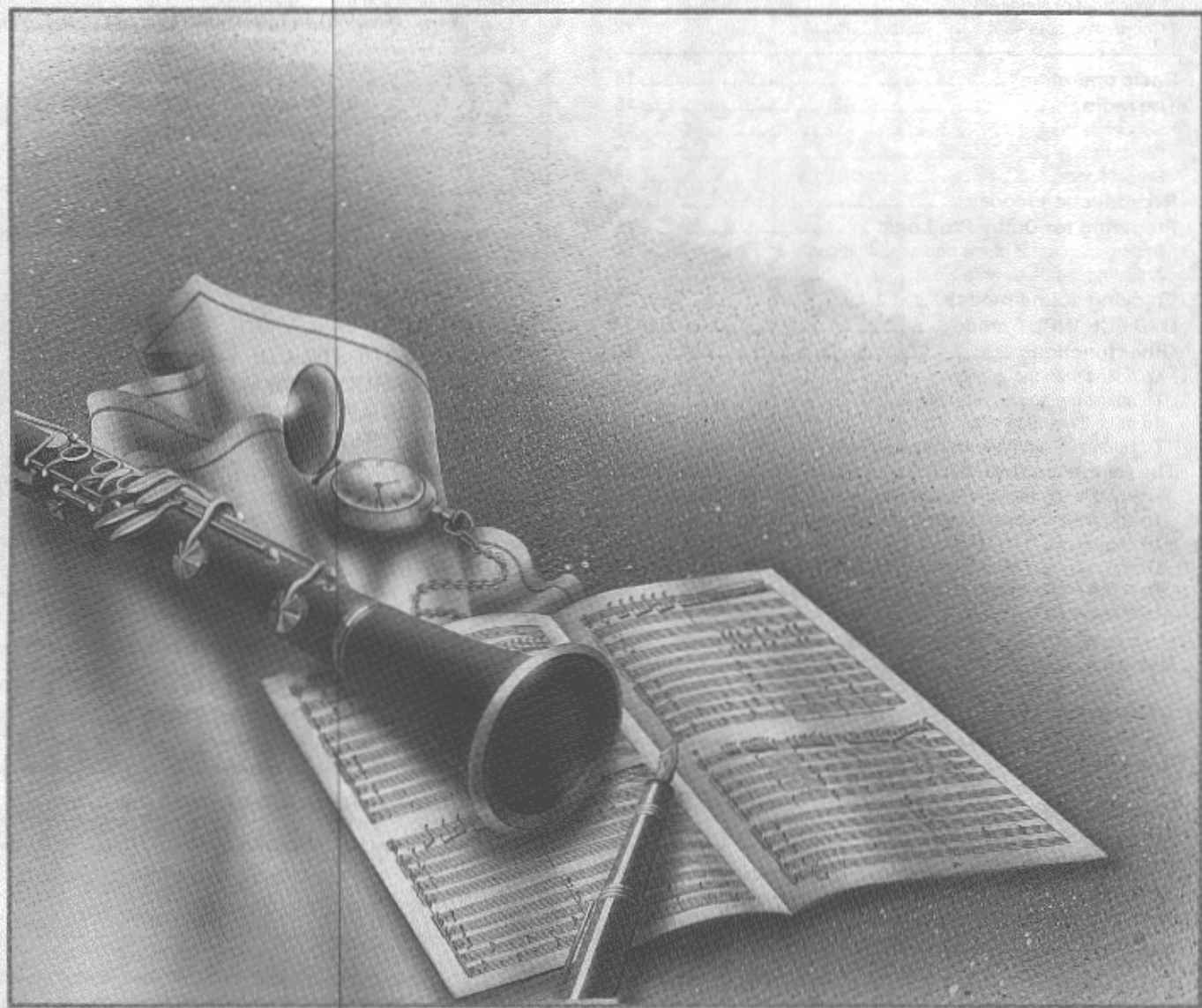

Before connecting, operating or adjusting this product, please read these instructions completely.

Please keep this manual for future reference.

Dear customer

Thank you for purchasing this product.
For optimum performance and safety, please read these instructions carefully.

Table of contents

Precautions	3
Supplied accessories	4
Concerning the remote control	4
To enjoy surround sound	5
Front panel controls	6
Connections	8
Connecting audio equipment	8
Connecting video equipment	8
Connecting a DVD player	9
Antenna connections	10
Connecting the AC power supply cord and other information ..	11
Speaker connections	12
Placement of speakers	12
Connecting speakers	12
Basic operations	14
The radio	16
Sequential tuning	16
Direct tuning	17
Preset tuning	18
Reproduction modes	20
Preparing for Dolby Pro Logic	21
Setting the center mode and adjusting speaker output level	21
Adjusting the delay time	22
Enjoying sound modes	23
DVD 6CH INPUT mode	24
Other functions	25
To adjust the tone quality	25
To adjust the sound balance	25
To mute the sound level	25
To listen through headphones	25
The remote control	26
To operate the receiver	26
To operate a cassette deck	27
To operate a CD player	28
To watch TV broadcasts	29
To watch video tapes	30
To operate a DVD player	31
Making a recording	32
Recording on a tape deck	32
Recording on a VCR	32
Specifications	33
Maintenance	33
Product Service	33
Troubleshooting guide	34
About the HELP function	35
Listening caution	35
Servicenter List (US)	Back cover

User memo:

DATE OF PURCHASE _____
DEALER NAME _____
DEALER ADDRESS _____
TELEPHONE NUMBER _____

The model number and serial number of this product can be found on either the back or the bottom of the unit. Please note them in the space provided below and keep for future reference.	
MODEL NUMBER _____	SA-AX540
SERIAL NUMBER _____	

CAUTION:

This equipment has been tested and found to comply with the limits for a Class B digital device, pursuant to Part 15 of the FCC Rules.

These limits are designed to provide reasonable protection against harmful interference in a residential installation. This equipment generates, uses and can radiate radio frequency energy and, if not installed and used in accordance with the instructions, may cause harmful interference to radio communications. However, there is no guarantee that interference will not occur in a particular installation. If this equipment does cause harmful interference to radio or television reception, which can be determined by turning the equipment off and on, the user is encouraged to try to correct the interference by one of the following measures:

- Reorient or relocate the receiving antenna.
- Increase the separation between the equipment and receiver.
- Connect the equipment into an outlet on a circuit different from that to which the receiver is connected.
- Consult the dealer or an experienced radio/TV technician for help.

Any unauthorized changes or modifications to this equipment would void the user's authority to operate this device.

This device complies with Part 15 of the FCC Rules. Operation is subject to the following two conditions: (1) This device may not cause harmful interference, and (2) this device must accept any interference received, including interference that may cause undesired operation.

WARNING:

TO REDUCE THE RISK OF FIRE, ELECTRIC SHOCK OR PRODUCT DAMAGE, DO NOT EXPOSE THIS APPLIANCE TO RAIN, SPLASHING, DRIPPING OR MOISTURE.

CAUTION:

TO PREVENT ELECTRIC SHOCK MATCH WIDE BLADE OF PLUG TO WIDE SLOT, FULLY INSERT.



CAUTION: TO REDUCE THE RISK OF ELECTRIC SHOCK, DO NOT REMOVE SCREWS. NO USER-SERVICEABLE PARTS INSIDE. REFER SERVICING TO QUALIFIED SERVICE PERSONNEL.



The lightning flash with arrowhead symbol, within an equilateral triangle, is intended to alert the user to the presence of uninsulated "dangerous voltage" within the product's enclosure that may be of sufficient magnitude to constitute a risk of electric shock to persons.



The exclamation point within an equilateral triangle is intended to alert the user to the presence of important operating and maintenance (servicing) instructions in the literature accompanying the appliance.

Precautions

Before using this unit please read these operating instructions carefully. Take special care to follow the warnings indicated on the unit itself as well as the safety suggestions listed below.

Afterwards keep them handy for future reference.

Safety

- 1. Power Source**—The unit should be connected to power supply only of the type described in the operating instructions or as marked on the unit.
- 2. Polarization**—If the unit is equipped with a polarized AC power plug (a plug having one blade wider than the other), that plug will fit into the AC outlet only one way. This is a safety feature. If you are unable to insert the plug fully into the outlet, try reversing the plug. If the plug should still fail to fit, contact your electrician to replace your obsolete outlet. Do not defeat the safety purpose of the polarized plug.
- 3. Power Cord Protection**—AC power supply cords should be routed so that they are not likely to be walked on or pinched by items placed upon or against them. Never take hold of the plug or cord if your hand is wet, and always grasp the plug body when connecting or disconnecting it.
- 4. Nonuse Periods**—When the unit is not used, turn the power off. When left unused for a long period of time, the unit should be unplugged from the household AC outlet.

Installation

Environment

- 1. Outdoor Antenna Grounding**—If an outside antenna is connected to the receiver, be sure the antenna system is grounded so as to provide some protection against voltage surges and built-up static charges. Section 810 of the National Electrical Code, ANSI/NFPA No. 70-1990, provides information with respect to proper grounding of the mast and supporting structure, grounding of the lead-in wire to an antenna discharge unit, size of grounding conductors, location of antenna-discharge unit, connection to grounding electrodes, and requirements for the grounding electrode. See figure below.

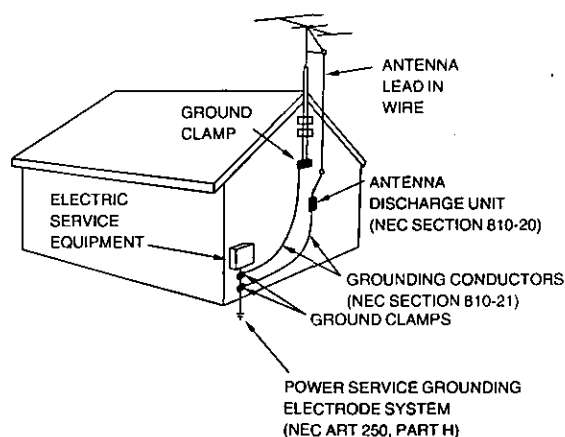

NEC—NATIONAL ELECTRICAL CODE

- 2. Water and Moisture**—Do not use this unit near water—for example, near a bathtub, washbowl, swimming pool, or the like. Damp basements should also be avoided.
- 3. Heat**—The unit should be situated away from heat sources such as radiators and the like. It also should not be placed in temperatures less than 5°C (41°F) or greater than 35°C (95°F).

Placement

- 1. Ventilation**—The unit should be situated so that its location or position does not interfere with its proper ventilation. Allow 10 cm (4") clearance from the rear of the unit.
- 2. Foreign Material**—Care should be taken so that objects do not fall into and liquids are not spilled into the unit. Do not subject this unit to excessive smoke, dust, mechanical vibration, or shock.
- 3. Magnetism**—The unit should be situated away from equipment or devices that generate strong magnetic fields.
- 4. Stacking**—Do not place heavy objects, other than system components, on top of the unit.
- 5. Surface**—Place the unit on a flat, level surface.
- 6. Carts and Stands**—The unit should be used only with a cart or stand that is recommended by the manufacturer. The unit and cart combination should be moved with care. Quick stops, excessive force, and uneven surfaces may cause the unit and cart combination to overturn.
- 7. Wall or Ceiling Mounting**—The unit should not be mounted to a wall or ceiling, unless specified in this operating instructions.



Maintenance

Clean the cabinet, panel and controls with a soft cloth lightly moistened with mild detergent solution. Do not use any type of abrasive pad, scouring powder or solvent such as alcohol or benzine.

Service

- 1. Damage Requiring Service**—The unit should be serviced by qualified service personnel when:
 - (a) The AC power supply cord or the plug has been damaged; or
 - (b) Objects have fallen or liquid has been spilled into the unit; or
 - (c) The unit has been exposed to rain; or
 - (d) The unit does not appear to operate normally or exhibits a marked change in performance; or
 - (e) The unit has been dropped, or the enclosure damaged.
- 2. Servicing**—The user should not attempt to service the unit beyond that described in the operating instructions. All other servicing should be referred to an authorized service personnel.

For the address of an authorized servicenter:

In the U.S.A. 1-800-211-7262 or web site

(<http://www.panasonic.com>)

In Canada 905-624-5505 or web site

(www.panasonic.ca)

Before use

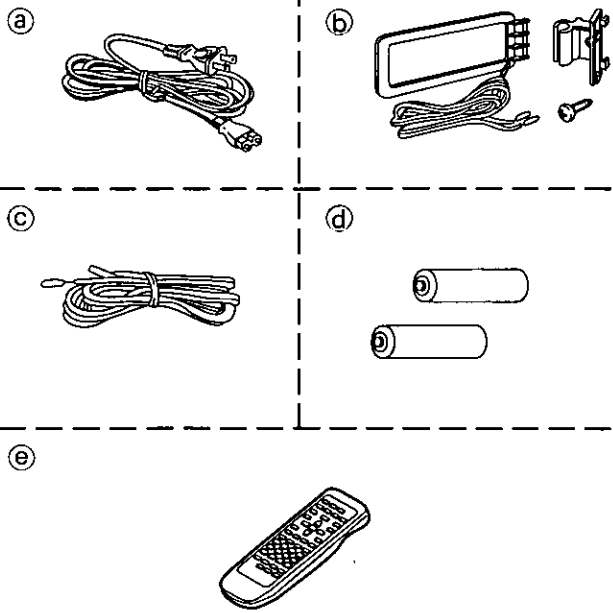
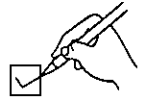
A**A Supplied accessories**

Please check and identify the supplied accessories.

- (a) AC power supply cord (RJA0065-A) 1 pc.
- (b) AM loop antenna set (RSA0012)
 - AM loop antenna 1 pc.
 - AM loop antenna holder 1 pc.
 - Screw 1 pc.
- (c) FM indoor antenna (RSA0006) 1 pc.
- (d) Batteries 2 pcs.
- (e) Remote control (EUR647130) 1 pc.

Use numbers indicated in parentheses when asking for replacement parts.

*(Only for U.S.A.)
To order accessories contact 1-800-332-5368 or web site
(<http://www.panasonic.com>).*

Concerning the remote control**B Battery installation****Use of batteries**

- Align the poles (+ and -) properly when inserting the batteries. Press in and down towards the minus end.
- Do not mix old and new batteries or different types of batteries.
- Do not recharge ordinary dry cell batteries.
- Do not heat or disassemble the batteries. Do not allow them to contact flame or water.
- Remove the batteries if the unit is not to be used for a long time.
- Do not keep together with metallic objects such as necklaces.
- Do not use rechargeable type batteries.
- Do not use batteries if the covering has been peeled off.

Mishandling of batteries can cause electrolyte leakage which can damage items the fluid contacts and may cause a fire. If electrolyte leaks from the batteries, consult your dealer. Wash thoroughly with water if electrolyte comes in contact with any part of your body.

C Correct method of use**Operation notes**

- Do not place obstacles between the remote control signal sensor and remote control unit.
- Do not expose the remote control signal sensor to direct sunlight or to the bright light of a fluorescent light.
- Take care to keep the remote control signal sensor and end of the remote control unit free from dust.
- If the unit is installed in a rack with glass doors, the glass doors' thickness or color might make it necessary to use the remote control a shorter distance from the unit.

To prevent damage

- Never place heavy items on top of the unit.
- Do not disassemble or reconstruct the unit.
- Do not spill water or other liquids into the unit.

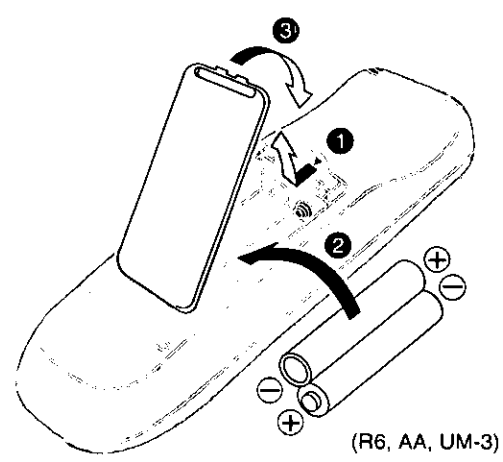
B

(R6, AA, UM-3)

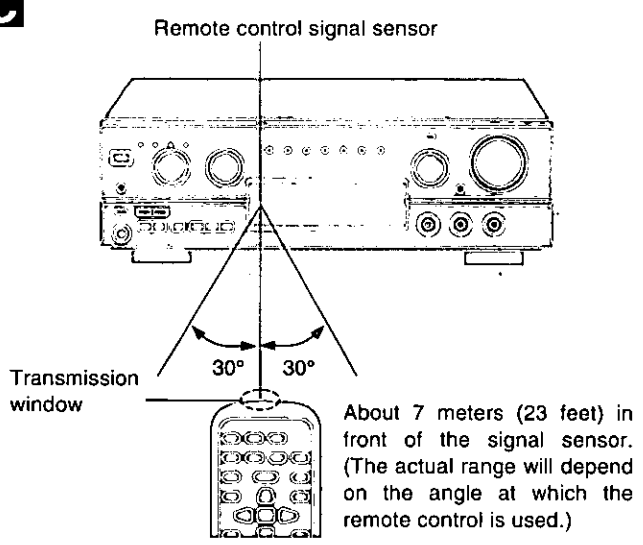
C

To enjoy surround sound

Do the connections, settings, and adjustments in the order shown to enjoy surround sound with this unit's Dolby Pro Logic or SFC features, or with Dolby Digital or DTS played on a DVD player connected to this unit's DVD 6CH INPUT terminals.

Connect the equipment

(⇒ Page 8–11.)

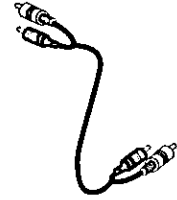

Position and connect the speakers

(⇒ Page 12–13.)

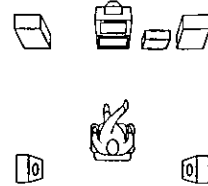

When using Dolby Pro Logic and SFC

(⇒ Page 20–23.)

When using DVD 6CH INPUT

(⇒ Page 24.)

For Dolby Pro Logic

Select the center mode
Adjust the speaker level
Set the delay time

(⇒ Page 21–22.)

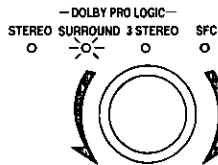

Switch input to DVD 6CH INPUT

(⇒ Page 24.)



On the DVD player or surround processor
Set the presence and type (small/large) of the speakers you have connected

Adjust the level and delay time for the speakers

Sit back and enjoy the experience

Before use

Front panel controls

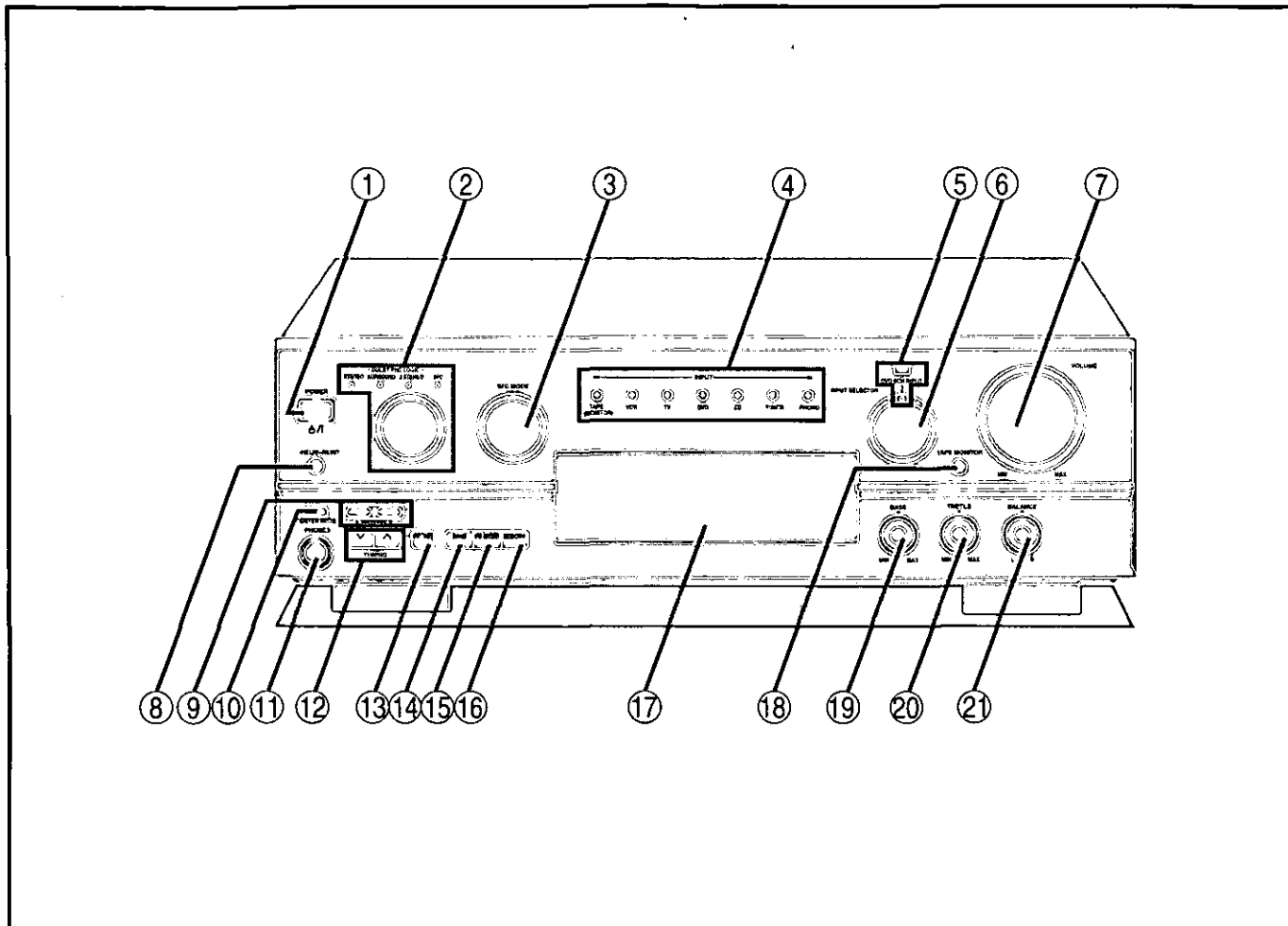

Main unit

No.	Name	Ref.page
①	Power “ ϕ /I” switch (POWER, ϕ /I)	14
	Press to switch the unit from on to standby mode or vice versa. In standby mode, the unit is still consuming a small amount of power.	
②	Sound mode selector/indicators	20
③	SFC mode selector (SFC MODE)	20
④	Input indicators (INPUT)	14
⑤	DVD 6ch input select button/indicator (DVD 6CH INPUT)	24
⑥	Input selector (INPUT SELECTOR)	14
⑦	Volume control (VOLUME)	14
⑧	Help/reset button (-HELP/-RESET)	35
⑨	Speaker select buttons (SPEAKERS A, B)	14

No.	Name	Ref.page
⑩	Center mode select button (CENTER MODE)	21
⑪	Headphones jack (PHONES)	25
⑫	Tuning buttons (TUNING ∇ , \wedge)	16
⑬	Preset channel button (PRESET)	19
⑭	Band select button (BAND)	16
⑮	FM mode select button (FM MODE)	16
⑯	Memory button (MEMORY)	18
⑰	Display	
⑱	Tape monitor button (TAPE MONITOR)	15
⑲	Bass control (BASS)	25
⑳	Treble control (TREBLE)	25
㉑	Balance control (BALANCE)	25

Front panel controls

Remote control

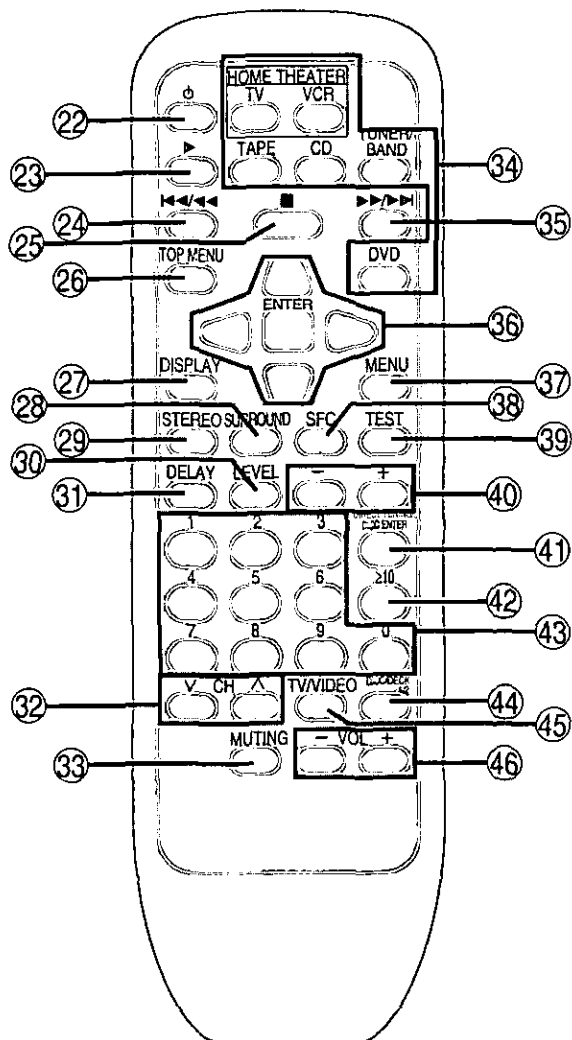

No.	Name	Ref. page
22	Power button (⏻)	26
23	▶ button (▶)	27
24	◀◀/◀◀ button (◀◀/◀◀)	27
25	■ button (■)	27
26	Top menu button (TOP MENU)	31
27	Display button (DISPLAY)	31
28	Dolby Pro Logic SURROUND select button (SURROUND)	26
29	Dolby Pro Logic/SFC off button (STEREO)	26
30	Speaker channel select button (LEVEL)	22, 26
31	Delay time button (DELAY)	22, 26
32	Channel up/down buttons (V CH ^)	27
33	Muting button (MUTING)	25, 26
34	Input select buttons (TV, VCR, TAPE, CD, TUNER/BAND, DVD)	26
35	▶▶/▶▶ button (▶▶/▶▶)	27
36	Cursor/enter buttons	31
37	Menu button (MENU)	31
38	SFC mode select button (SFC)	26
39	Test button (TEST)	21, 26
40	Delay time/level adjust buttons (-, +)	22, 26
41	Direct tuning/disc enter button (DIRECT TUNING/DISC ENTER)	17, 27
42	≥10 button (≥10)	27
43	Numbered buttons	17, 27
44	Disc/deck 1/2 select button (DISC/DECK 1/2)	27
45	TV/video select button (TV/VIDEO)	29
46	Volume buttons (-VOL+)	21, 26

Before use



Connections

Stereo connection cable (not included)



Video connection cable (not included)

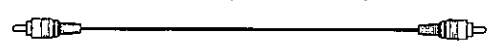

Make sure that the power supply for all components has been turned off before making any connections.

To connect equipment, refer to the appropriate operating instructions.

Connecting audio equipment

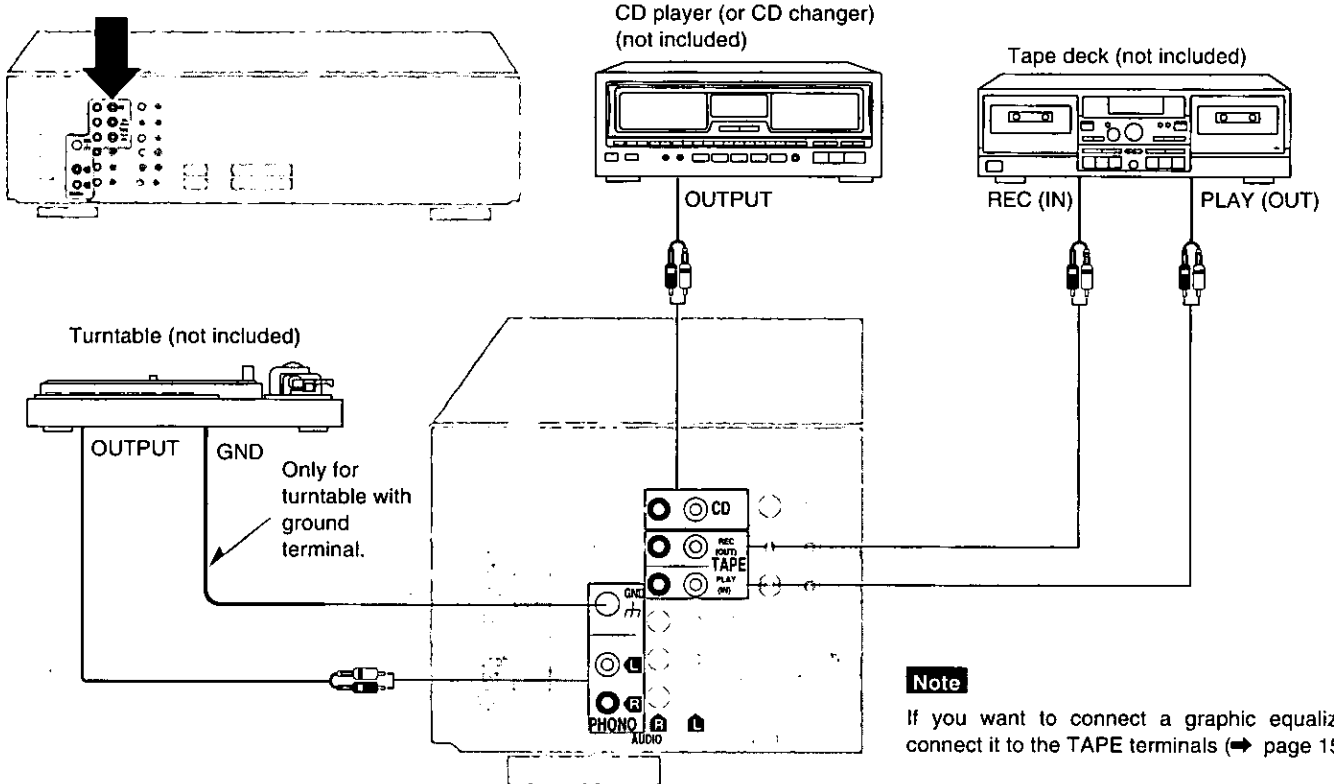

Note

If you want to connect a graphic equalizer, connect it to the TAPE terminals (➔ page 15).

Connecting video equipment

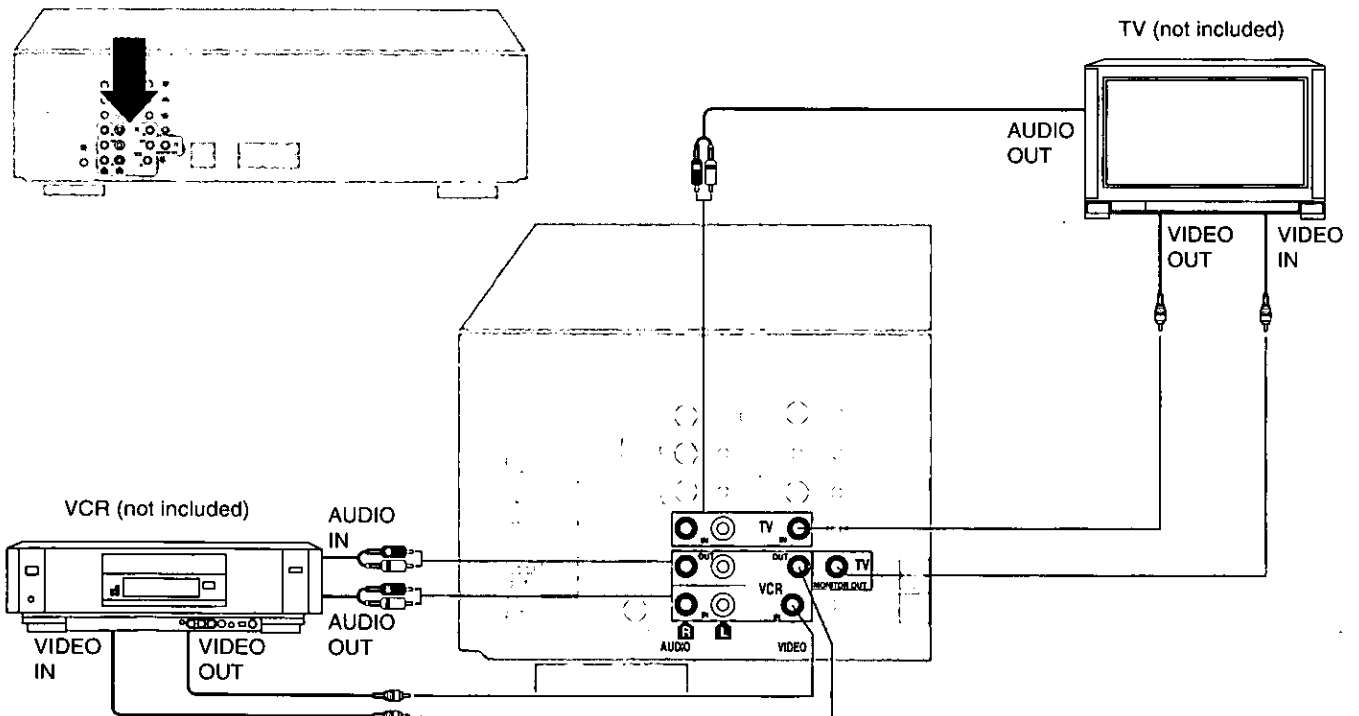

Monaural connection cable (not included)

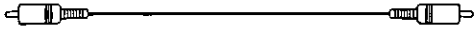

Optical fiber cable (not included)



Connecting a DVD player

• Direct connection of the DVD player

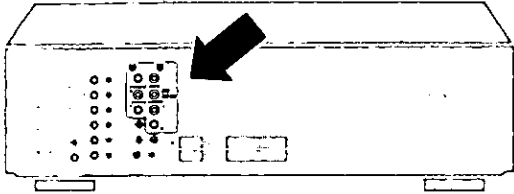

DVD player with 6ch output
(not included)

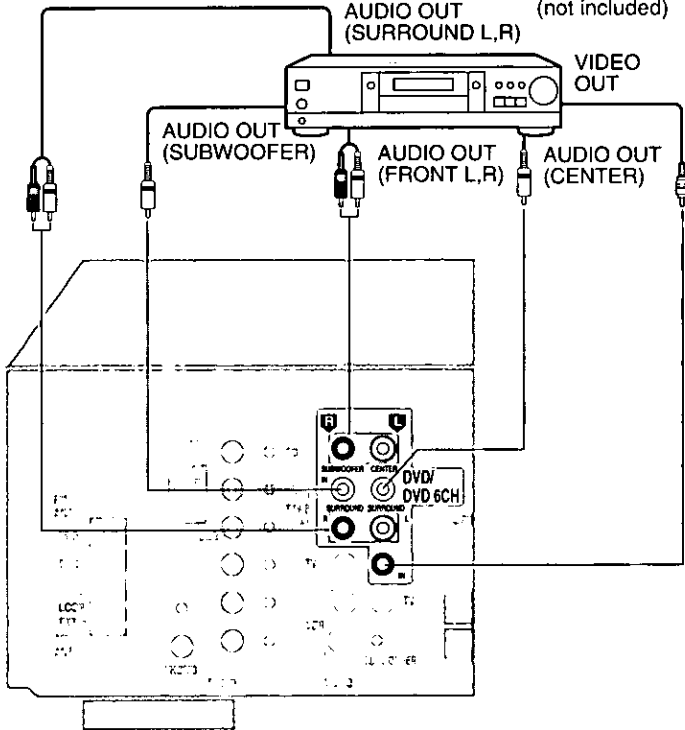

DVD player with 2ch output
(not included)

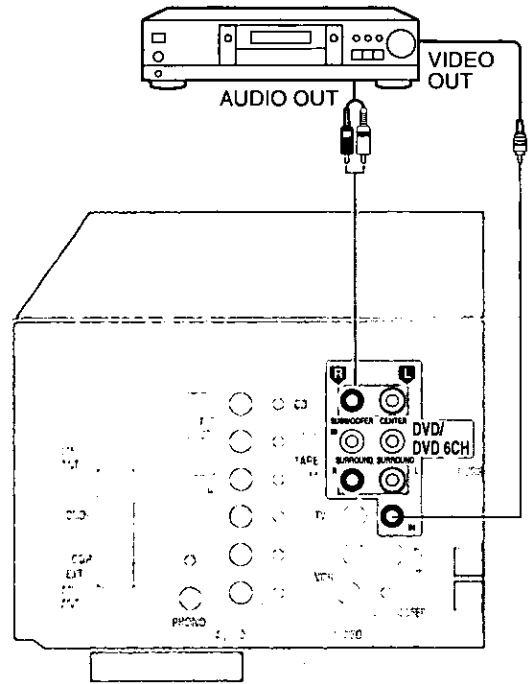

• Connection through a digital surround processor

Digital surround processor
(not included)

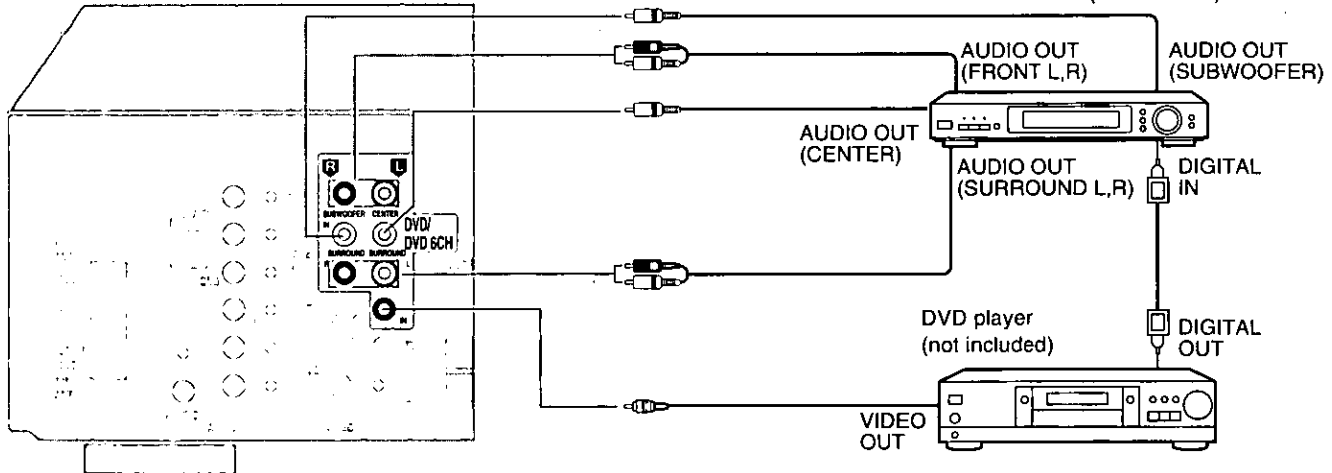

CAUTION

Do not place anything on top of this unit or block the heat radiation vents in any way. In particular, do not place tape decks or CD/DVD players on this unit as heat radiated from it can damage your software.

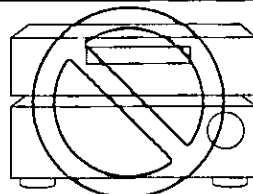

NO

Antenna connections

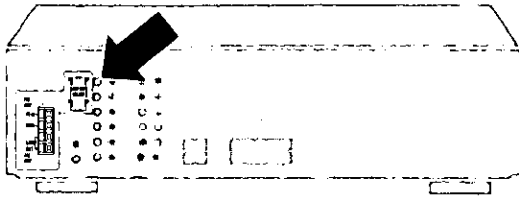

AM loop antenna

Fit the AM loop antenna holder (included) onto the rear panel of this unit and then attach the AM loop antenna to the AM loop antenna holder (facing in the direction of best reception).
Keep loose antenna cord away from other wire cords or a tape deck.

FM antenna

Fix the other end of the antenna where reception is best.

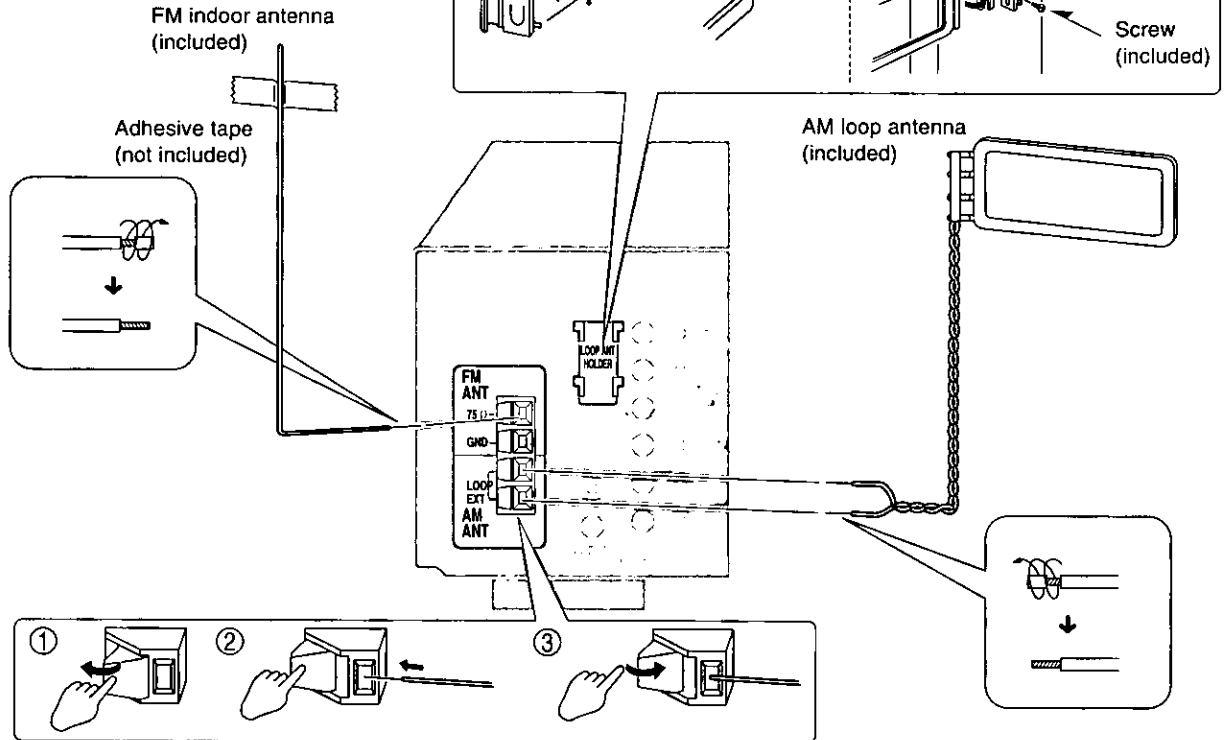

To connect an outdoor antenna

FM outdoor antenna

- Disconnect the FM indoor antenna.
- The antenna should be installed by a competent technician.
- Twist the coaxial cable's shield braid firmly and connect it to the GND terminal.

AM outdoor antenna

- Run a piece of vinyl wire horizontally across a window or other convenient location.
- Leave the loop antenna connected.
- Disconnect the antenna when the unit is not in use. Do not use the antenna during an electrical storm.

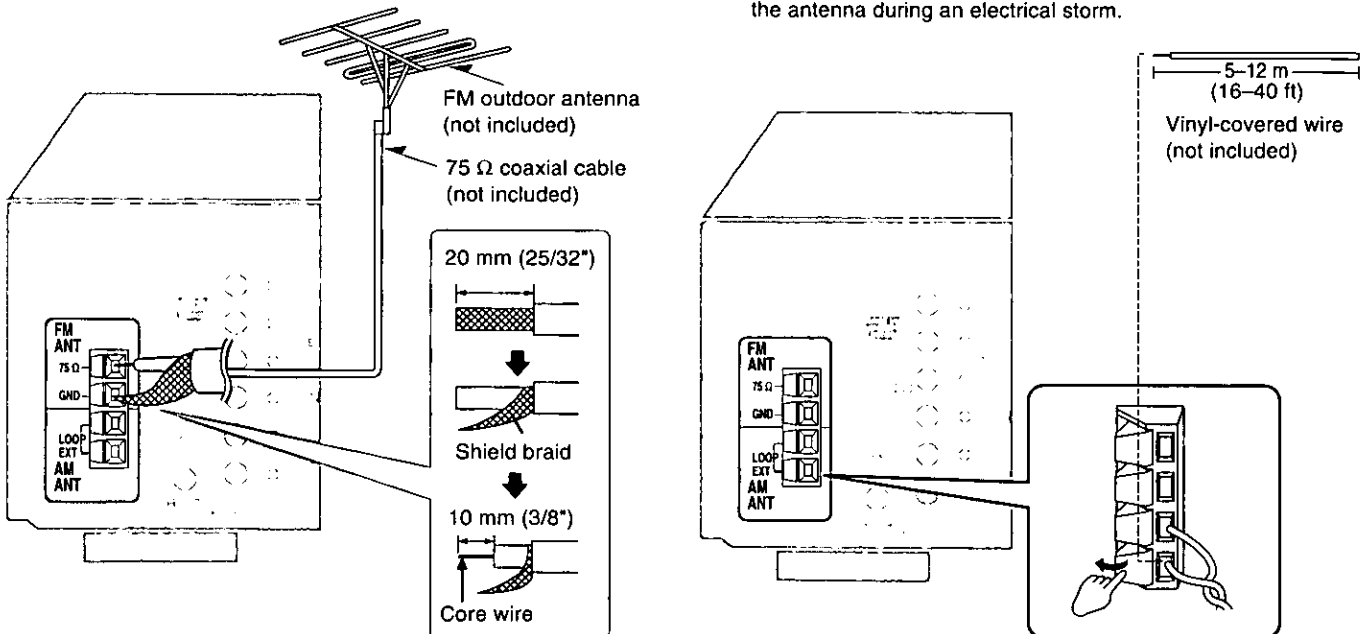

Connecting the AC power supply cord and other information

Cooling fan

The cooling fan operates at high power output levels only.

"SWITCHED" AC outlet

Power to the outlet is controlled by the power switch of this unit. Audio equipment rated up to MAX 80 W can be connected here.

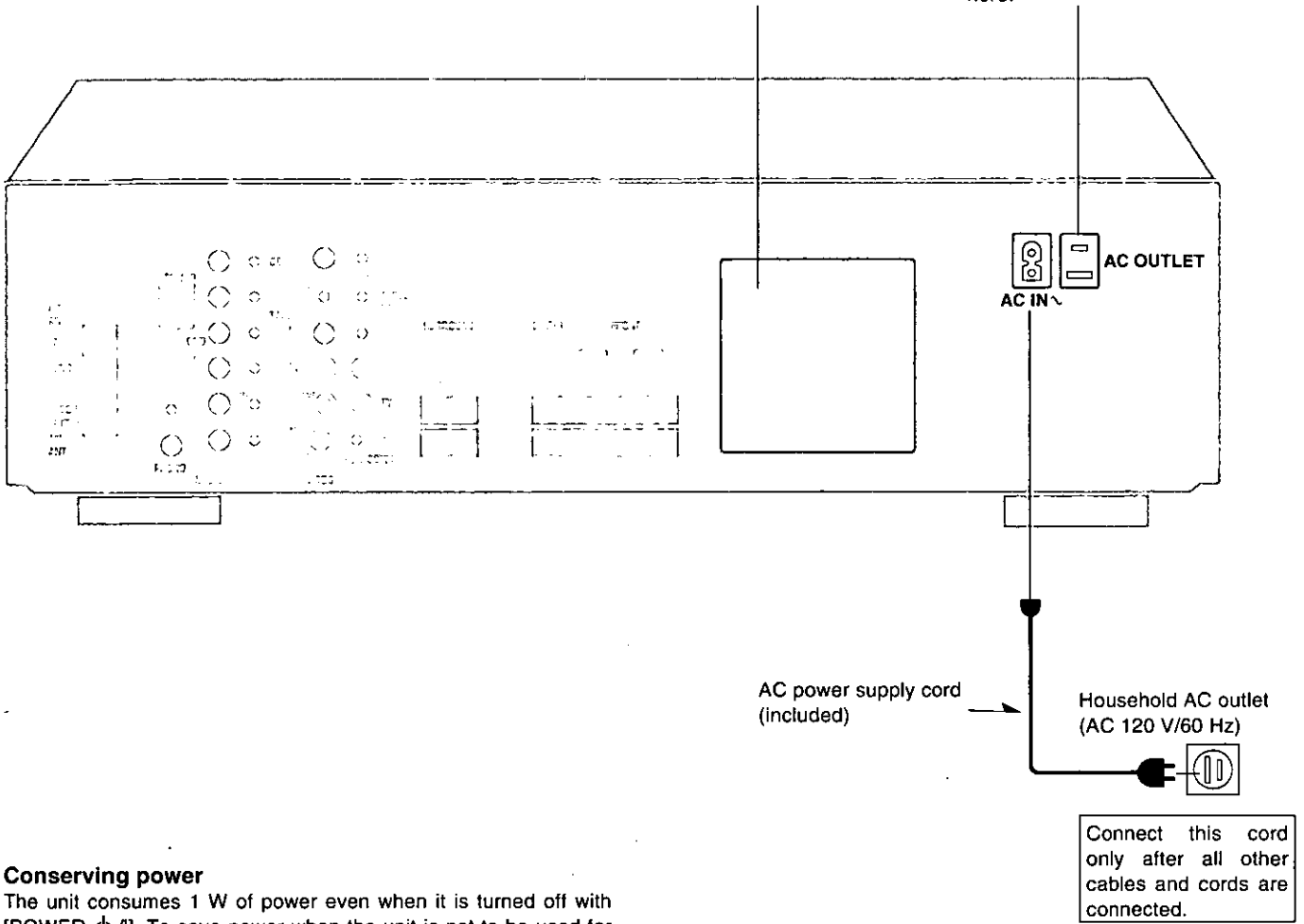

Conserving power

The unit consumes 1 W of power even when it is turned off with [POWER, ⏻]. To save power when the unit is not to be used for a long time, unplug it from the household AC outlet.

If the unit is left unplugged for longer than a few weeks, all settings will revert to the factory settings. Do the settings again if this occurs.

Note

The included AC power supply cord is for use with this unit only. Do not use it with other equipment.

Speaker connections

Placement of speakers

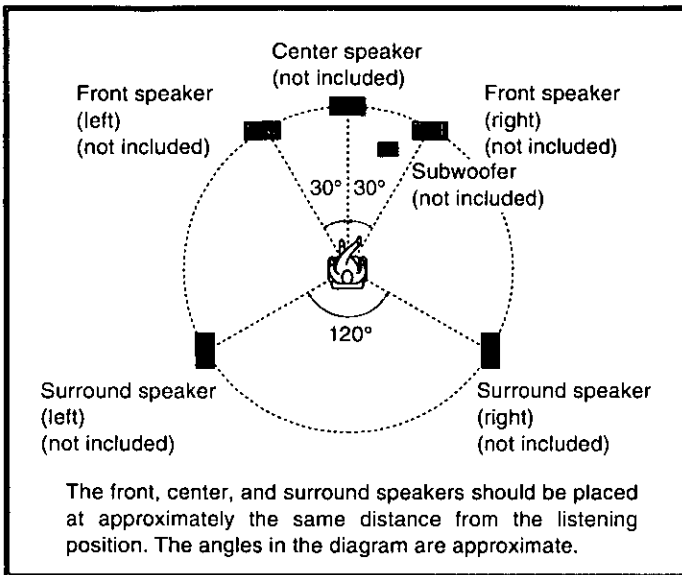

Front speakers

Place on the left and right of the TV at seated ear height so that there is good coherency between the picture and sound.

Center speaker

Place underneath or above the center of the TV. Aim the speaker at the seating area.

Surround speakers

Place on the side of or slightly behind the listening position, about one meter higher than ear level.

Subwoofer

The subwoofer can be placed in any position as long as it is at a reasonable distance from the TV.

Note that some experimentation can yield the smoothest low frequency performance. Placement near a corner can increase the apparent output level, but can result in unnatural bass.

Connecting speakers

Other connections are possible depending on your speaker system. See your speaker system's operating instructions for details.

Front speakers

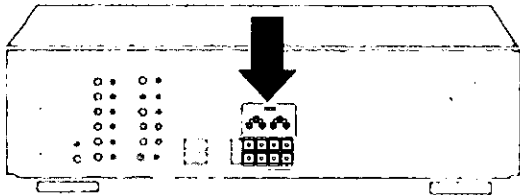

Speaker impedance:

A or B: 4-8 Ω
A and B: 8 Ω

Note

If you connect speakers with an impedance under 8 Ω , switch on "LOW IMP" (\rightarrow page 15).

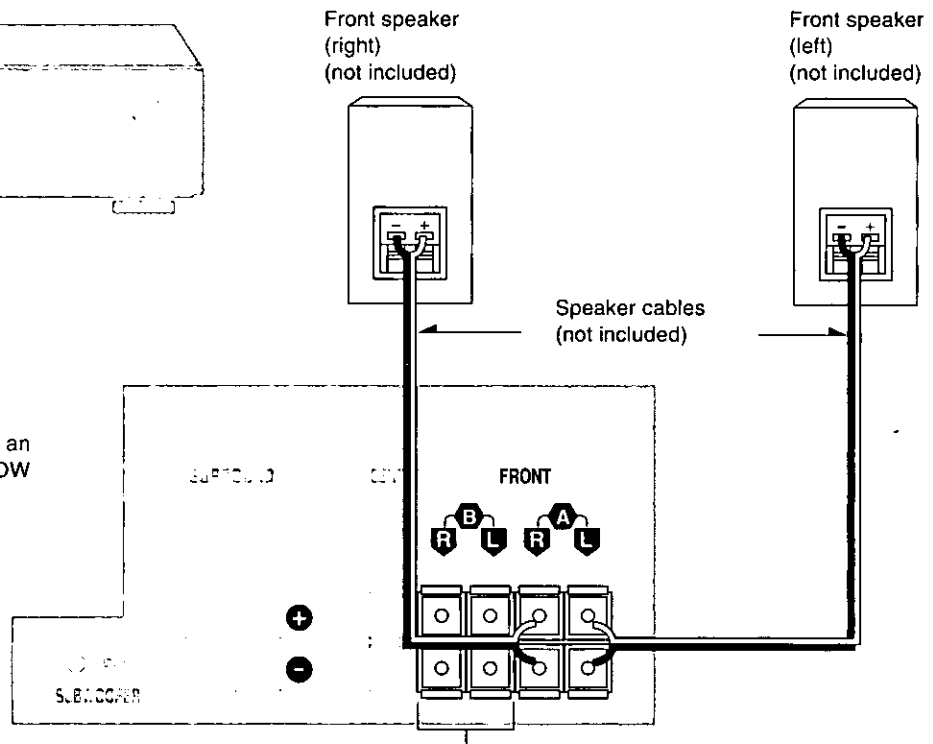

"B" terminals

For connection to a second pair of speakers.

Note

Use the A terminals to enjoy Dolby Pro Logic, SFC, and DVD 6CH INPUT.

Connecting the cables

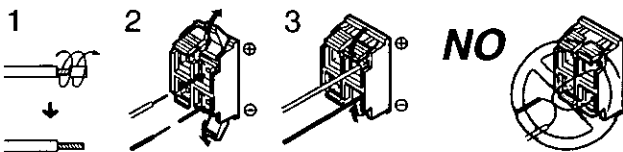

Center speaker

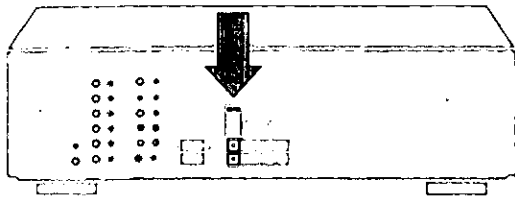

Center speaker
(not included)

Speaker cable
(not included)

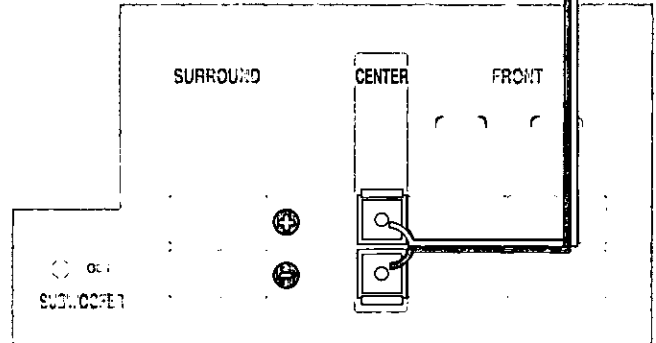

Speaker impedance: 8 Ω

Surround speakers

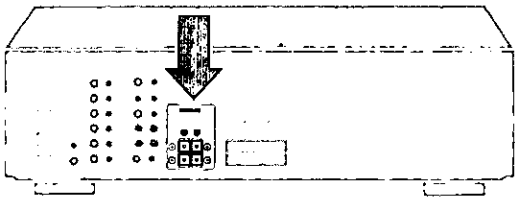

Surround speaker
(right)
(not included)

Surround speaker
(left)
(not included)

Speaker cables
(not included)

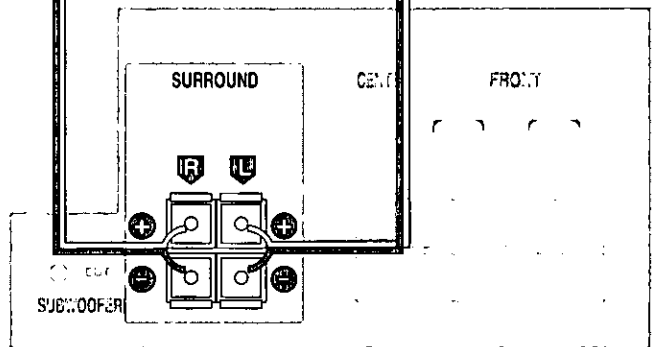

Speaker impedance: 8 Ω

Subwoofer

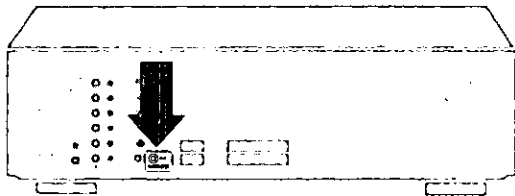

Active subwoofer
(not included)

Monaural connection cable
(not included)

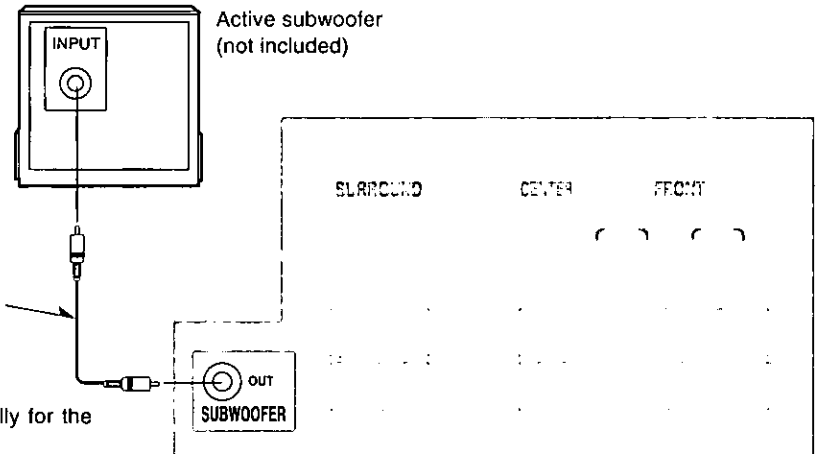

Note:

This receiver has no amplifier section designed especially for the subwoofer.

To connect a passive subwoofer

- You can connect another amplifier and connect a passive subwoofer to it.
- Connection to a passive subwoofer that has front speaker terminals is also possible.
(See the operating instructions of the speaker system for details.)

Basic operations

Before operation, set [VOLUME] to the "MIN" position.

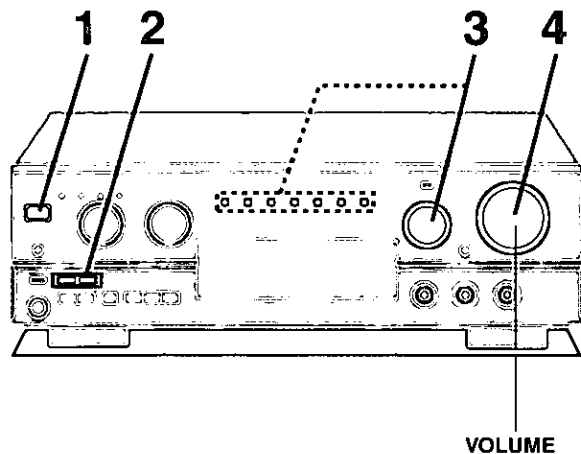

- 1 Press [POWER, .**
- 2 Press [A] and/or [B] to select the speaker system(s) to be used.**
A and B refer to the speaker terminals at the rear of the unit.

If the button is pressed once more, the indicator will switch off and no sound will be heard from the speakers.
- 3 Turn [INPUT SELECTOR] to select and start the desired source.**

(Refer to the appropriate operating instructions for details.)

The indicator corresponding to the selected source lights and the source is shown on the display.

- TAPE:** To listen to cassette tapes
- VCR:** To watch video tapes
- TV:** To watch TV
- DVD:** To enjoy DVD
- CD:** To listen to compact discs
- TUNER:** To listen to radio broadcasts
- PHONO:** To listen to phono discs

Note

To watch a video (or DVD) or the TV, set the TV to either the TV mode or VIDEO mode.

- 4 Adjust the volume.**

For your reference

- **If the Dolby Pro Logic or SFC mode has been selected**
After displaying the selected source, the display will then change to show the Dolby Pro Logic or SFC mode.
(→ page 20)
If the source chosen was TUNER then the display will change again to show the frequency.
- **If you are using VCR and you select TAPE, CD, TUNER, or PHONO**
The picture will remain on the screen.

When you finish listening

Be sure to reduce the volume, and switch the power to the standby condition by pressing [POWER, .

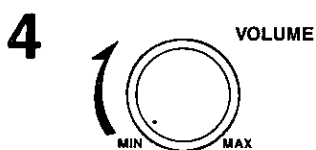
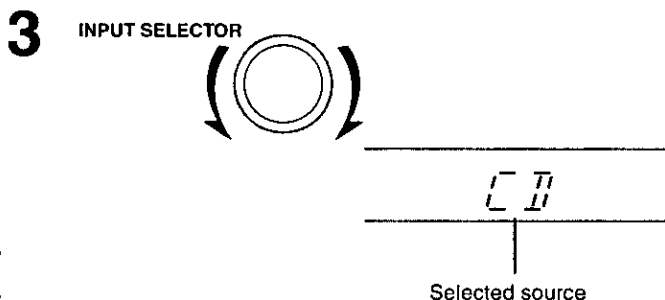
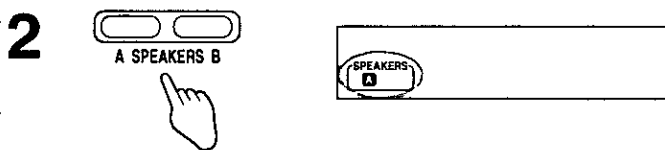
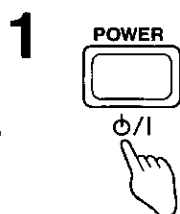

Basic operations

A For front speakers with an impedance under $8\ \Omega$

Press and hold [A] or [B] until "LOW IMP" lights up on the display.

If even one of the speakers being used has an impedance under $8\ \Omega$, press and hold down either [A] or [B] for 4 seconds or more to set the impedance on the main unit to LOW.

(Press and hold down once again for 4 seconds or more to turn it off.)

Note that when "LOW IMP" is illuminated, SPEAKERS A and B cannot both be used at the same time.

To change speakers:

e.g. To use SPEAKERS B, press [A] ("A" goes out), and then press [B] to activate SPEAKERS B.

B The TAPE (MONITOR) indicator

This indicator lights in the following two situations:

1. While TAPE is selected.
2. While TAPE MONITOR is in use.

To use the tape monitor

(For use when you have connected a graphic equalizer to the TAPE terminals.)

If [TAPE MONITOR] is pressed while a source other than TAPE is selected, the "TAPE (MONITOR)" indicator lights and the tape monitor comes on.

Sources other than tape can be selected with [INPUT SELECTOR] while the "TAPE (MONITOR)" indicator is on.

Press [TAPE MONITOR] again to turn the tape monitor off.

(⇒ See "Making a recording" on page 32 for details on how to use the tape monitor during recording.)

SPEAKERS A, B

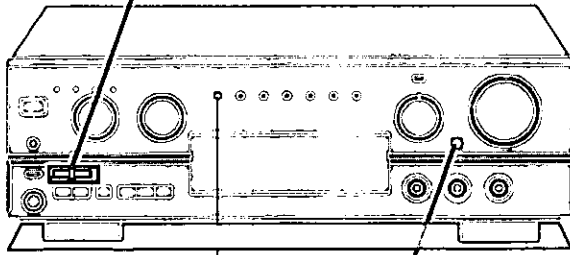

TAPE
(MONITOR)

TAPE MONITOR

A



A SPEAKERS B

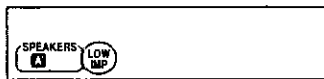

B

TAPE MONITOR



The radio

Sequential tuning

Use the tuning buttons to tune-in radio stations.

- 1 Turn [INPUT SELECTOR] to select "TUNER".
- 2 Press [BAND] to select "FM" or "AM".
- 3 Press [TUNING (∇ or ▲)] to tune to the desired frequency.

"QUARTZ LOCK" lights up when tuned.

"STEREO" lights up when an FM stereo broadcast is received.

To make an automatic search for stations

If [TUNING (∇ or ▲)] is held down for an instant until the frequency begins to scroll, the broadcast stations are tuned in automatically when one is found.

Note

Tuning may stop automatically if any jamming is encountered.

If noise is excessive in the FM stereo mode

Press [FM MODE].

("STEREO" will go out, and "MONO" will light up).

The broadcast will be monaural, but noise will be reduced.

If the button is pressed once more, the stereo mode resumes.

For your reference

The tuner can pick up interference from DVD players. If this occurs turn the DVD player off.

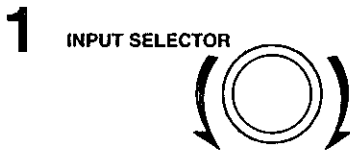
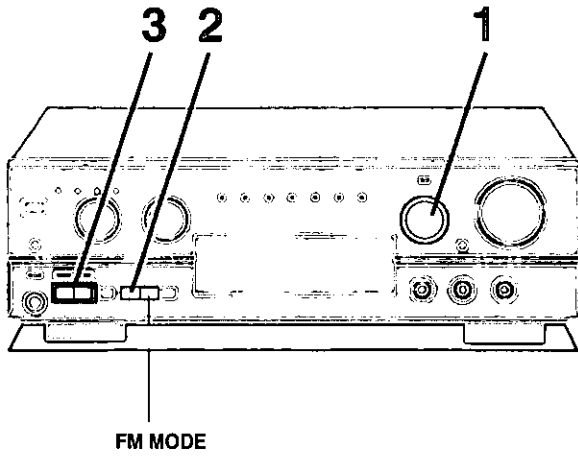

TUNER

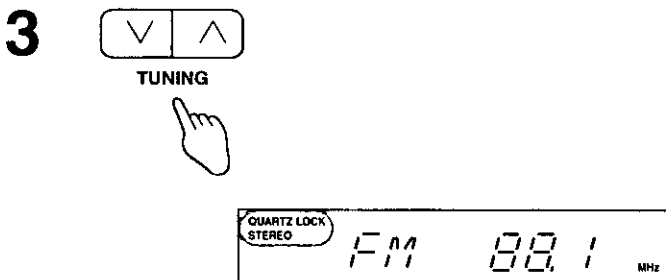
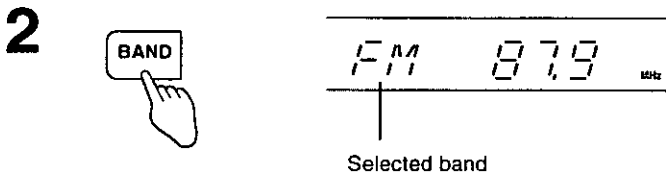

The radio

Direct tuning

by remote control only:

Specify the frequency using the numbered buttons on the remote control to directly tune to the station.

1 Press [TUNER/BAND].

This will set the remote control to operate the tuner. The selector on the receiver will change to "TUNER". Each time the button is pressed, the band will change as follows,
FM \rightleftarrows AM.

2 Press [DIRECT TUNING/DISC ENTER].

3 While cursor display is flashing (approx. 10 seconds) Press the numbered buttons to enter the frequency.

If the desired FM frequency is 107.9 MHz, press
[1] \rightarrow [0] \rightarrow [7] \rightarrow [9].

If the frequency has been input correctly, the displayed frequency will blink once.

Note

1. If no button is pressed while the cursor display is flashing, the display will return to the frequency which is currently being received. To re-specify the frequency, repeat the procedure from step 2.
2. If the frequency has not been input correctly, "ERROR" will be displayed. In this case, re-enter the frequency.

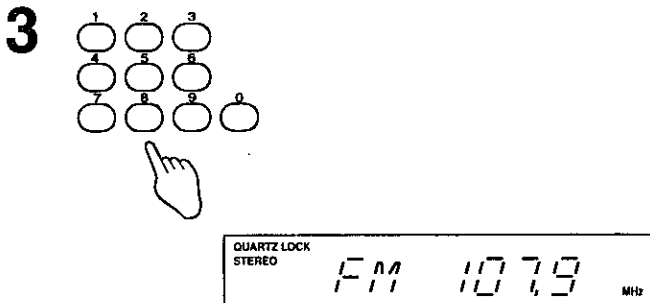
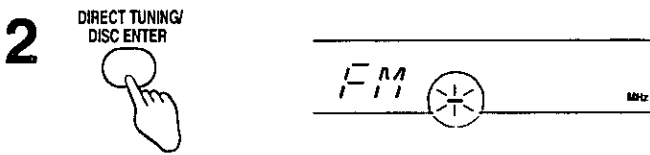
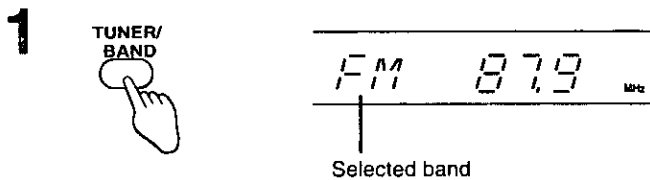
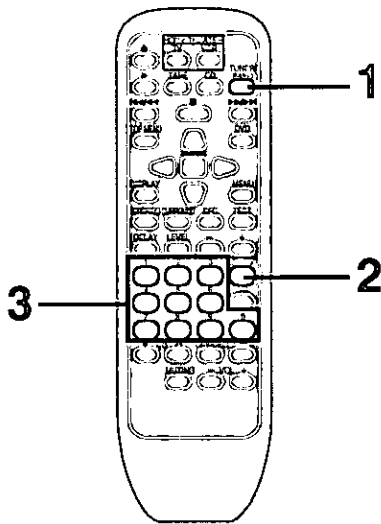

The radio

Preset tuning

Presetting radio stations into the memory channels of this unit makes selecting stations simple.

A total of 30 FM and AM stations can be preset.

Please remember this

If a new station is preset into a channel, the setting for the station which was previously entered in that channel will be automatically erased.

Automatic memory presetting

Automatic memory presetting allows this unit to search for stations and then preset them into memory.

1 Tune to the lowest frequency in FM.

(⇒ Page 16–17.)

2 Press and hold [MEMORY].

Automatic memory presetting will start.

All the FM stations the unit can receive are preset in channels 1 to 30.

3 Tune to the lowest frequency in AM.

(⇒ Page 16–17.)

4 Press and hold [MEMORY].

Automatic memory presetting will start.

All the AM stations the unit can receive are preset in channels 21 to 30. (Any FM stations in these channels will be replaced.)

During automatic memory presetting, the memory indicator will flash while the frequency scrolls.

When a station is preset

The memory indicator and the preset channel number will be displayed for approximately 1 second. (A)

When presetting is completed

The last station to be preset will be displayed.

Note

Frequencies may not be preset correctly in cases where the broadcast waves are too strong or too weak. In such cases, carry out presetting manually (⇒ Page 19).

2, 4

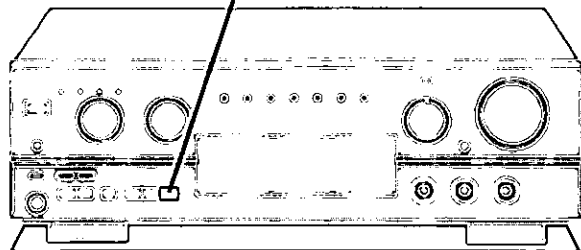

2

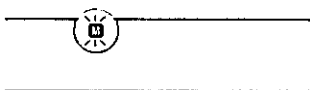

4

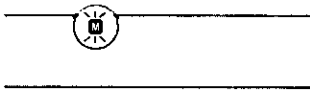

A

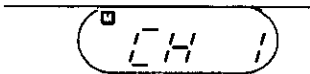

The radio

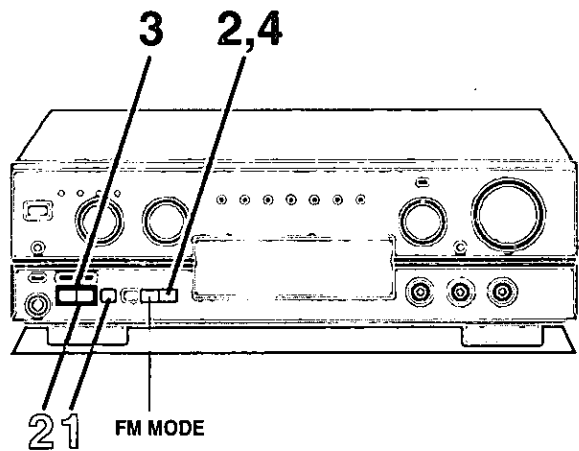

A Manual memory presetting

The desired stations can be preset into the desired channels by the user.

1 Set to the desired frequency.

(⇒ Page 16–17.)

If interference or static is keeping you from enjoying an FM broadcast, press [FM MODE] and change to monaural. You can preset the station in monaural just as in stereo.

2 Press [MEMORY].

To cancel the memory function, press [MEMORY] again.

3 Press [TUNING (∨ or ∧)] to select the desired channel.

Holding the buttons down lets you scroll through channels faster.

4 Press [MEMORY].

The channel will blink on the display.

To continue presetting

Repeat steps 1 through 4.

B To listen to preset channels

1 Press [PRESET].

2 Press [TUNING (∨ or ∧)].

Holding down the buttons lets you scroll through channels faster.

The channel number flashes for approximately 5 seconds. Select the desired channel number during that time.

After 5 seconds, the display will change from the channel number to the frequency.

Note

If you press [PRESET] while the channel number is displayed, the display will change to the frequency.

To confirm the channel number of the station being received

Press [PRESET].

(The channel number flashes for approximately 5 second.)

Note

The channel number is not displayed if you change the frequency or FM mode setting.

For your reference

Even if the power supply cord is disconnected from the household AC outlet, the memory will retain its contents for approximately one month.

If frequency presettings are accidentally erased

Program the presettings once again.

The power supply cord should remain connected for one hour or more for the memory back-up to be effective.

A

2

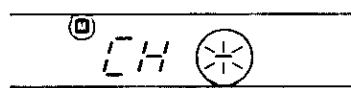

3

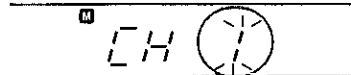
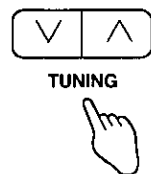

4

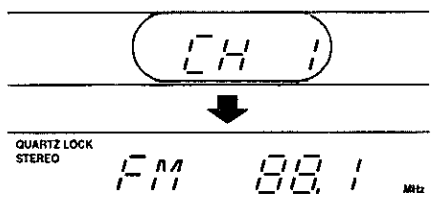

B

1



2

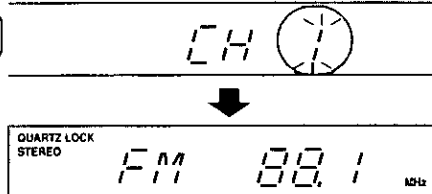
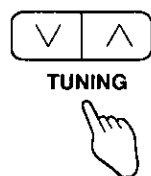

Reproduction modes

You can take advantage of the following modes with this unit.

A Dolby Pro Logic SURROUND mode

By reproducing the feeling of depth and movement of sound, video software or compact discs recorded with Dolby Surround provide the listener with a feeling of presence like that of a movie theater.

B Dolby Pro Logic 3 STEREO mode

You can enjoy audio/video sources with clear sound, more presence and a good feeling of orientation. 3 STEREO can be used with stereo sources not encoded with Dolby Surround.

C SFC modes

The SFC (Sound Field Control) function gives presence and spread thereby enhancing and enriching the music or movie. Read the following explanations to better understand how to make your selection.

Note

- SFC is designed to add surround-like effects to stereo sources. Select the Dolby Pro Logic SURROUND mode when playing back Dolby Surround sources.
- The center speaker is not used in the HALL and SIM SURR mode.

HALL

This mode imparts a reflection and spread which will make you feel as if you are in a large concert hall.

CLUB

Like a jazz club, this mode provides an exciting and intimate atmosphere. It simulates the sound field of a relatively small room having a low ceiling and hard reflective surfaces, for a "live" sound with enhanced presence to bring the performers up close.

LIVE

Primarily for vocal pieces, this mode adds gloss to the vocals and you'll feel as though you were hearing a live stage performance.

THEATER

You can clearly perceive the directions and source of the movie. Real ambience of sound can also be recreated naturally using this mode.

SIM SURR (SIMULATED)

Choose this mode if little or no sound will be heard from the surround speakers.

You can feel as if you were in a more expanded space adding to the actual sound from the source.

This mode also adds effect to monaural sources by outputting sound from surround speakers.

STEREO, SURROUND, 3 STEREO, SFC

SFC MODE

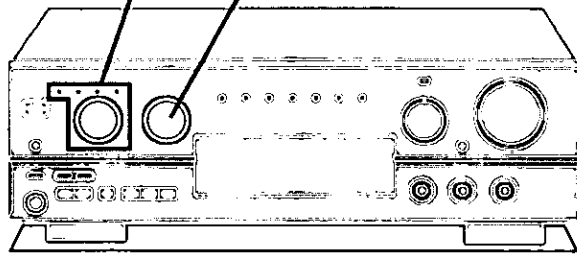

A

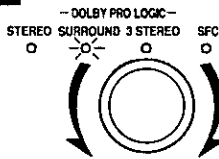

SURROUND

B

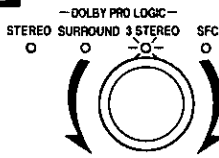

3 STEREO

C

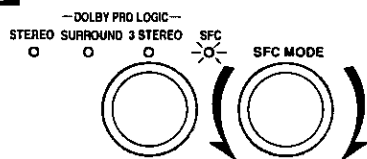

HALL

CLUB

LIVE

THEATER

SIM SURR

Manufactured under license from Dolby Laboratories Licensing Corporation.

Dolby, the double-D symbol  and "PRO LOGIC" are trademarks of Dolby Laboratories Licensing Corporation.

Preparing for Dolby Pro Logic

Setting the center mode and adjusting speaker output level

Adjust speaker level so the output from the center and surround speakers is the same apparent level when sitting where you would normally enjoy a source.

Ensure you have your speakers set up in the following way.

- The front speakers are connected to the A terminals (⇒ page 12) and "SPEAKERS A" is selected.

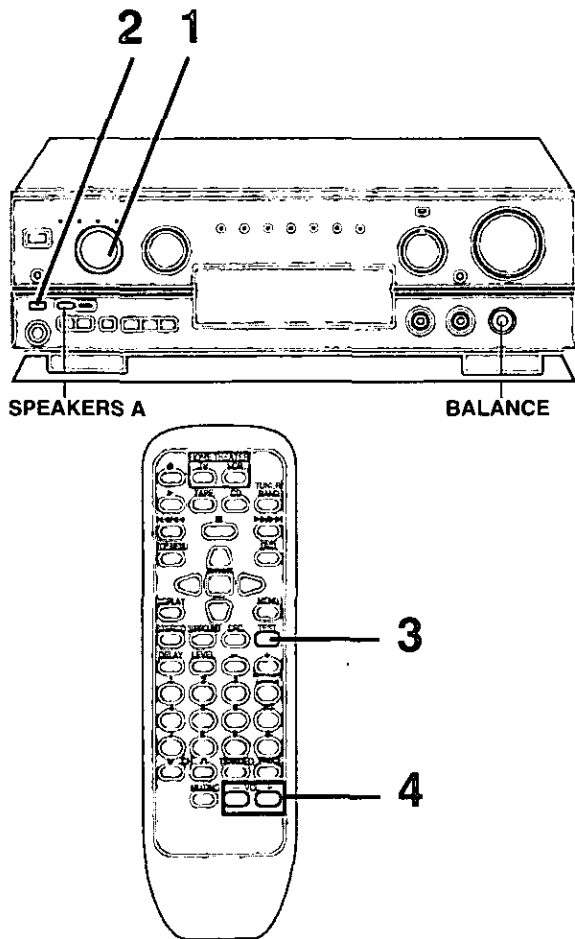

1 Turn the sound mode selector to select "SURROUND."

Note

1. Select "3 STEREO" if surround speakers have not been connected.
2. Remember, you cannot adjust the output level of the surround speakers if you select "3 STEREO" mode.

2 Press [CENTER MODE] to select the correct center mode.

When the button is pressed, the current center mode is displayed. Pressing it again changes the center mode.

NORMAL

When the center speaker is smaller than the front speakers.

WIDEBAND

When the center speaker is the same size as or larger than the front speakers.

PHANTOM **SURROUND mode only**

When center speaker is not connected.

The sound for the center speaker is sent to the front left and right speakers.

3 **by remote control only** Press [TEST] to output a test signal.

The speaker outputting the test signal is displayed while the test is running.

- L: Front speaker (left)
- C: Center speaker (not displayed in PHANTOM mode)
- R: Front speaker (right)
- S: Surround speakers

There is no test signal for subwoofer.

4 **by remote control** Press [VOL (-) or (+)] to set the volume level normally used for enjoying the source.

Note

Use [BALANCE] if the left right balance of the front speakers is off.

(Continued on next page)

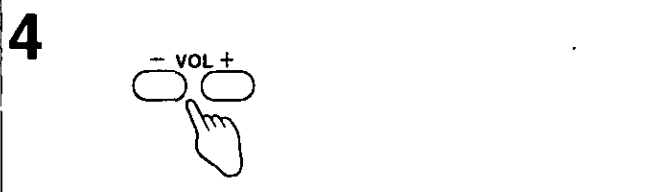
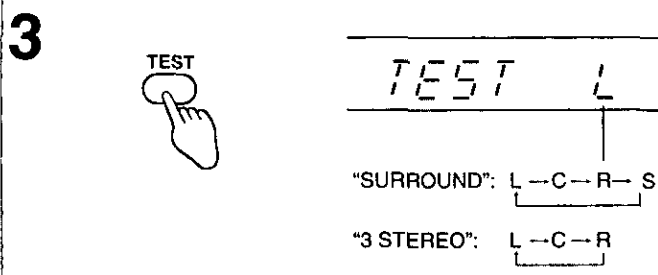
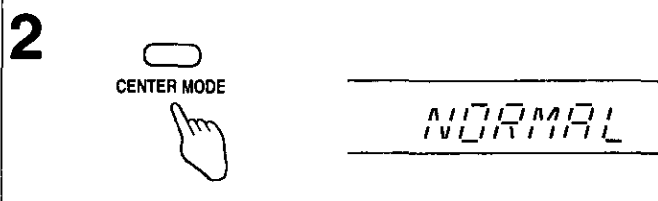
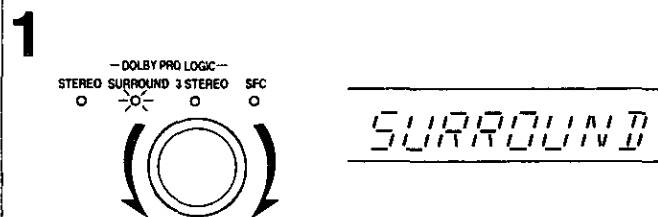

Preparing for Dolby Pro Logic

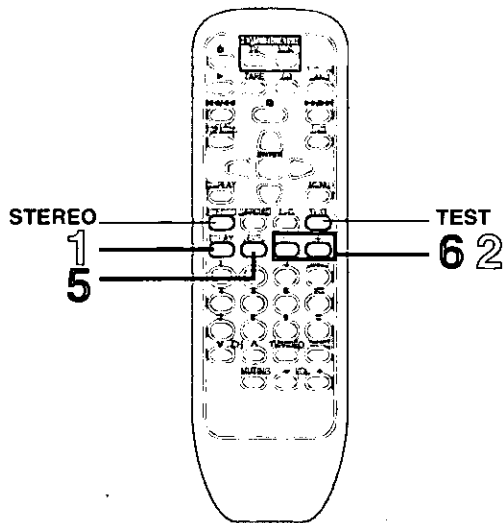

5

by remote control only

Press [LEVEL] to select the center or surround speakers.

6

by remote control only

Press [-] or [+] to adjust the output level to the same apparent level as the front speakers.

-: Decrease the output level.

+: Increase the output level.

Output level can be varied within a range of -12 dB to +12 dB with front speaker output level serving as the zero point.

Note

During steps 5 and 6 above, the test signal sequence is interrupted and the signal will only come from the selected speaker.

The sequence will resume when adjustments are stopped.

7

Repeat step 5 and 6 for each speaker channel.

To stop the test signal

Press [TEST].

To turn off the Dolby Pro Logic systems

Press [STEREO].

5

LEVEL



Selected channel

6

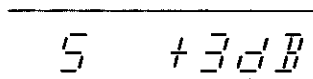
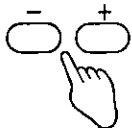

Output level

A Adjusting the delay time

Adjust the delay time of the sound from the surround speakers to produce the proper effect.

Preparation

Select the SURROUND mode.

Note

This procedure can be done only in the SURROUND mode.

A

1

DELAY

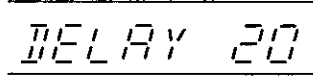

2

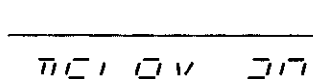
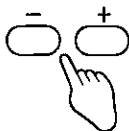

B

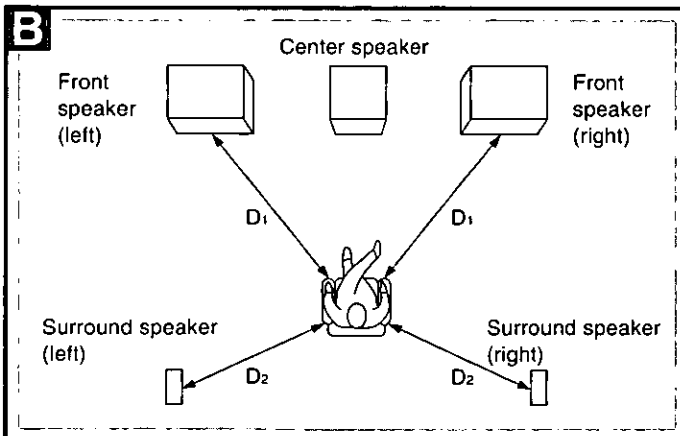

1

by remote control only

Press [DELAY].

When the button is pressed, the current delay time is displayed.

2

by remote control only

Press [-] or [+] to set the time.

The delay time changes by 5 ms with each press, between 15 ms and 30 ms.

The standard setting is 20 ms.

B To calculate the delay time

D_1 : Distance from front speakers

D_2 : Distance from surround speakers

• If D_1 is equal to or less than D_2

Set to 15 ms.

• If D_2 is less than D_1

Start at 15 ms and increase by 5 ms for every 1.5 m (5 feet) of difference between D_1 and D_2 .

Enjoying sound modes

Ensure you have your speakers set up in the following way.

- The front speakers are connected to the A terminals (➔ page 12) and "SPEAKERS A" is selected.

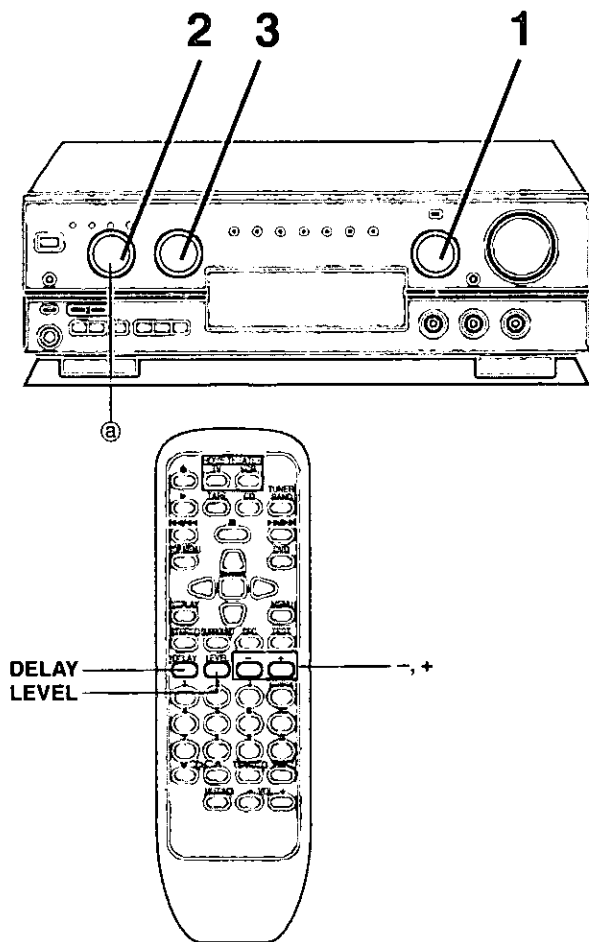

1 Turn [INPUT SELECTOR] to select the source.

2 Turn the sound mode selector to select the desired mode.

The selected reproduction mode appears on the display.
(➔ Page 20 for descriptions of the modes.)

3 (only if you select SFC in the above step)
Select the mode.

4 Start the source.

.....
To turn off the Dolby Pro Logic or SFC functions
Turn the sound mode selector (Ⓐ) to select "STEREO".

For your reference

You can set the sound mode for each source.
Each source will retain the selected mode.

Note

These modes cannot be turned on while SPEAKERS B is on. These modes are automatically switched to STEREO if SPEAKERS B is selected or both speakers are turned off. When SPEAKERS B is turned off or SPEAKERS A is selected, the mode is switched back to the last mode.

While using the SFC modes

To adjust speaker level **by remote control only**

① Press [LEVEL] to select the speaker channel to adjust.
The output level appears on the display.

Note

You can adjust center speaker volume only in THEATER mode

② Press [-] or [+] to adjust the output level.
Channels C and S can be adjusted between -12 dB and +12 dB.

To adjust delay time **by remote control only**

You can adjust the surround channel only.

① Press [DELAY].

When the button is pressed, the current delay time is displayed.

② Press [-] or [+] to set the time.

Each press changes the delay time.

Increments depend on the mode.

Select a delay time setting to accommodate to your individual needs.

SFC modes	Available delay time setting (ms)
HALL	20, 25, 30, 40 , 50
CLUB	0, 15 , 20, 25, 30
LIVE	15, 20, 30, 40, 50
THEATER	15, 20 , 25, 30, 40
SIM SURR	15 , 20, 25, 30, 40

The figures in bold italics are the factory settings.

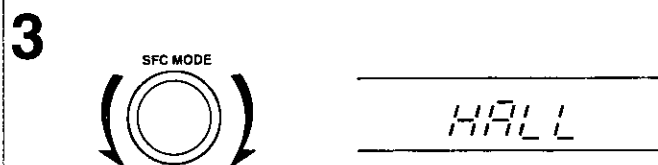
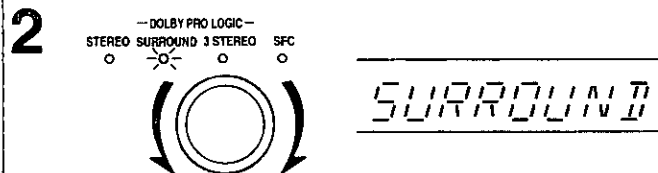
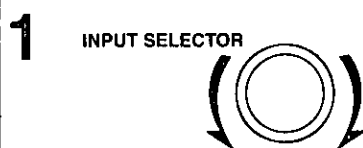

DVD 6CH INPUT mode

Use this mode when playing back 6 channel discrete sources such as Dolby Digital and DTS. To use this mode connect a DVD player, digital surround processor or any other component that has 6 channel discrete output capabilities (➔ page 9).

Dolby Digital, DTS and other 6 channel discrete sources are recorded with each speaker channel discrete from the other. Depth, movement, position and other characteristics are maintained, so using this mode will make you feel as if you were at a movie theater.

Ensure you have your speakers set up in the following way.

- The front speakers are connected to the A terminals (➔ page 12) and "SPEAKERS A" is selected.

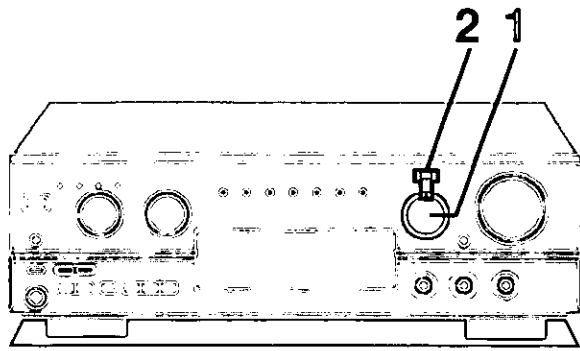

1

INPUT SELECTOR



DV D

2

DVD 6CH INPUT



DV D 6CH

1 Turn [INPUT SELECTOR] to select "DVD."

2 Press [DVD 6CH INPUT] to select "DVD 6CH."

Changes as follows, each time the button is pressed.
DVD 6CH ⇌ DVD (2CH)

Note

- If you press this button while another source (CD, PHONO, etc.) is selected, the receiver switches the source to DVD and engages the DVD 6CH INPUT mode.
- All sound mode indicators are turned off when DVD 6CH INPUT is turned on. The STEREO mode and indicator comes on when DVD 6CH INPUT is turned off.

3 Start the desired source.

Follow your equipment's operating instructions.

Note

- This mode cannot be turned on while SPEAKERS B is on. If SPEAKERS B is selected or both speakers are turned off when this mode is selected, this mode is automatically cancelled. When SPEAKERS B is turned off again or SPEAKERS A is selected, the mode is automatically turned on.
- You cannot select Dolby Pro Logic or any of the SFC modes while in the DVD 6CH INPUT mode.

Other functions

A To adjust the tone quality

Turn [BASS] to adjust the low frequency sound.

Turn [TREBLE] to adjust the high frequency sound.

B To adjust the sound balance

Turn [BALANCE] to adjust the left/right sound balance.

C To mute the sound level

by remote control only

Press [MUTING].

The message "MUTING ON NOW" runs repeatedly from right to left across the display as long as the muting function is on.

Press once again to return to the previous volume level.

Note

Muting is cancelled when the receiver is turned off.

D To listen through headphones

- 1 Reduce the volume.
- 2 Connect the headphones.
Plug type: 6.3 mm (1/4 in.) stereo
- 3 Adjust the volume.

Turn the speakers off when using headphones. Turning the speakers off automatically engages STEREO mode. When SPEAKERS A is turned on, last sound mode is automatically selected again. If SPEAKERS A is still selected when either SURROUND or 3 STEREO is used, the sound heard through the headphones will seem unusual.

Be sure to also turn off the subwoofer or reduce its volume to minimum.

Note

Avoid listening for prolonged periods of time to prevent hearing damage.

VOLUME

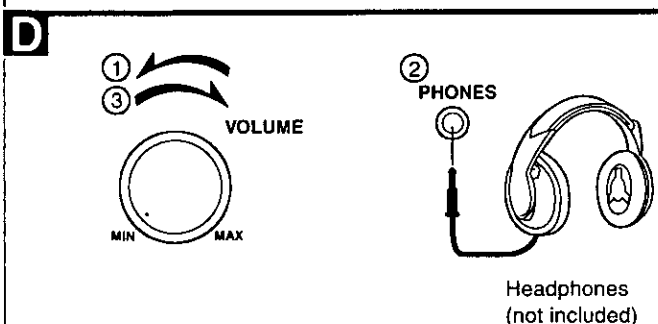
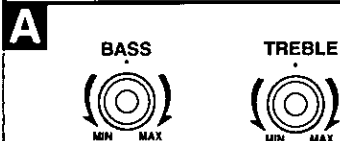
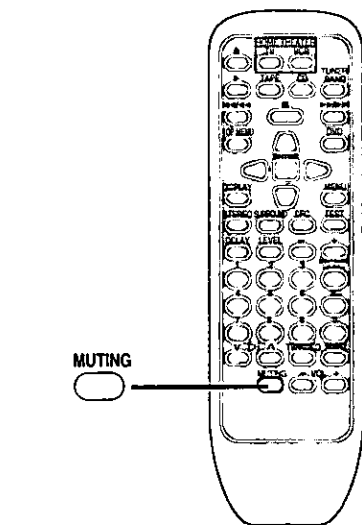
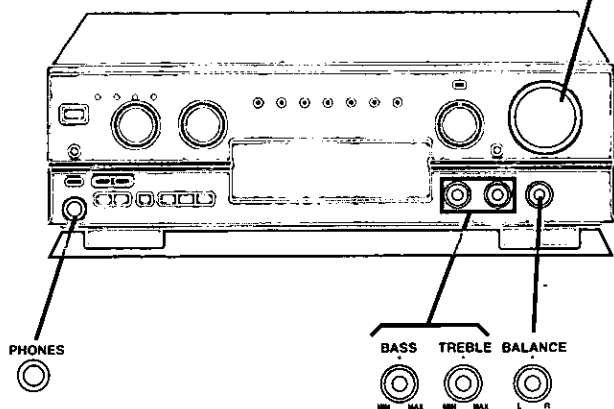

The remote control

This remote control can be used to operate this unit and some other Panasonic and Technics cassette decks, CD players, TVs, VCRs and DVD players, provided they are equipped with a remote control sensor.

To operate the receiver

Point the remote control toward the receiver

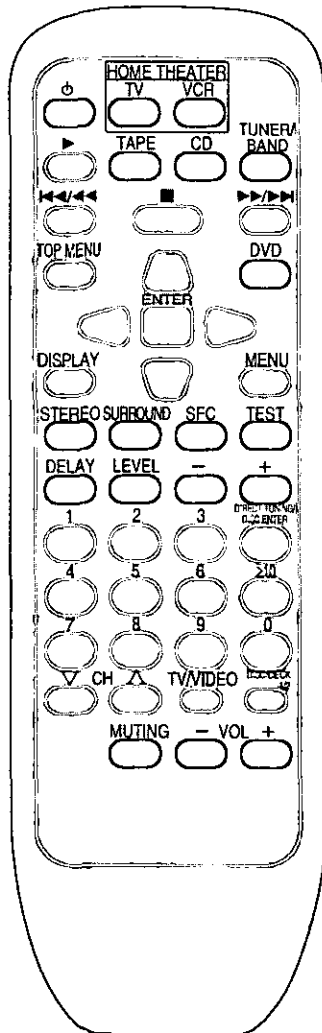

Basic operations

To turn the unit ON/OFF

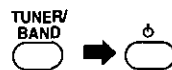

To select an input source and switch the remote control to each operation mode

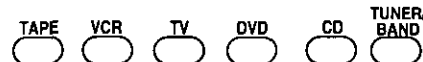

Note

- PHONO can not be selected with this remote control.
- TAPE MONITOR cannot be controlled with the [TAPE] button.

To turn off the Dolby Pro Logic and SFC mode



To turn on the Dolby Pro Logic SURROUND mode



Note

3 STEREO can not be selected with this remote control.

To turn SFC on and select the mode



Changes as follows each time the button is pressed.

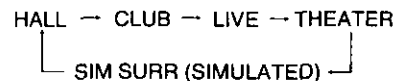

To output a test signal

When the SURROUND or 3 STEREO mode is ON



Press once more to stop the test signal.

To adjust the output level of the center speaker and/or surround speakers

When the SURROUND, 3 STEREO or SFC mode is ON

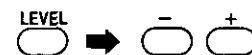

- ① Select center (C) or surround (S).
- ② Adjust output level.

- When the SURROUND mode is ON and the center mode is on PHANTOM, you cannot select the center channel.
- When SFC is used, the center channel can be changed only if THEATER is on.
- When the 3 STEREO mode is ON, you cannot select the surround channel.

To adjust the delay time

When the SURROUND or SFC modes are on



To mute the sound level







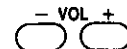



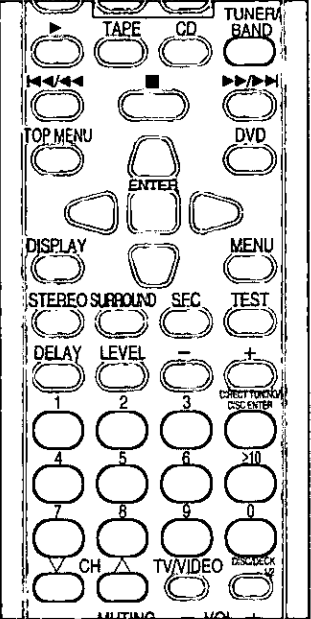

The message "MUTING ON NOW" runs repeatedly from right to left across the display as long as the muting function is on. Press once more to return to the original volume.

To adjust the volume level

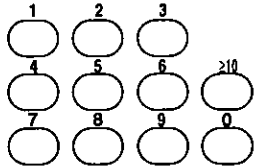

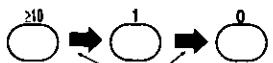
To operate the receiver (continued)

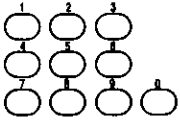
Make sure the remote control is in the tuner operation mode. (⇒ Page 26.)







<p>Point the remote control toward the receiver</p>  	<h3>To listen to radio broadcasts</h3>	
	<p>To select "FM" or "AM"</p>	<p>TUNER/BAND </p> <p>Changes as follows each time the button is pressed. FM ⇄ AM</p>
	<p>To select the desired channel sequentially (Preset tuning)</p>	<p> CH </p>
	<p>To select the desired channel directly (Preset tuning)</p>	<p>  (Example: Channel 1)  (Example: Channel 10)  within 10 seconds </p>
<p>To select radio stations by frequency (Direct tuning)</p>	<p>  →  (Example: 107.9MHz)  within 10 seconds </p>	

To operate a cassette deck

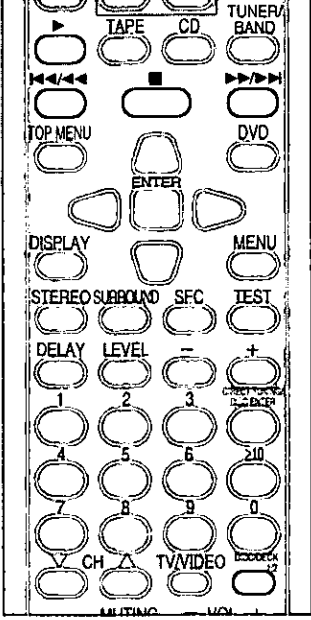
Turn the cassette deck ON before trying to operate it by remote control.

Make sure the remote control is in the cassette deck operation mode. (⇒ Page 26.)

It may not be possible to operate some cassette decks with this unit.







<p>Point the remote control toward the cassette deck</p>  	<p>Only when using a double cassette deck</p> <p>To select the tape deck (DECK 1/DECK 2)</p>	<p>DISC/DECK </p>
	<p>To start playback</p>	<p></p>
	<p>To fast-forward or rewind the tape</p>	<p>While the tape is stopped</p> <p> </p> <p>With TPS-equipped cassette decks, you can move to the beginning or end of a track by pressing these buttons while the tape is playing.</p>
	<p>To stop playback</p>	<p></p>

To operate a CD player

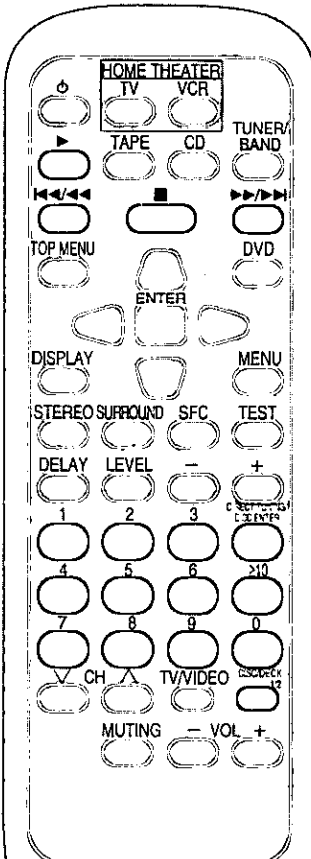
Turn the CD player ON before trying to operate it by remote control.

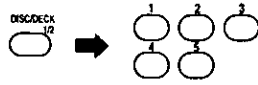
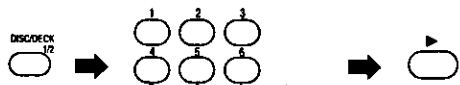
Make sure the remote control is in the CD player operation mode. (⇒ Page 26.)

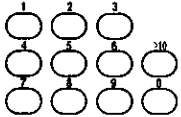
It may not be possible to operate some CD players with this unit.

<p>Point the remote control toward the CD player</p>  	<p>To start play</p> 		
	<p>To start play from the desired disc</p> <p>[CD changer only]</p>	<p>For 5 CD changer</p>  <p>Select disc number.</p>	<p>For MEGA CD changer ※</p>  <p>Select the disc number. (When selecting discs, [≥10] does not respond to touch.)</p>
		<p>For your reference</p>  <p>If you press this button instead of [▶] shown in the above procedure, the CD changer will stop and display the disc number. To start the disc, press [▶].</p>	
	<p>To start play from the desired track</p>	 <p>Select the track number. (Example: Track 1) 1 (Example: Track 10) ≥10 → 1 → 0</p>	
	<p>To skip a track</p>		
<p>To stop play</p>			

※ "MEGA CD changer" means any Technics CD changer that takes more than 50 discs.

To watch TV broadcasts

The procedures below are examples for when a TV and VCR are connected to the receiver as shown in this manual. This remote control transmitter is designed for use with a home theater system. If you press [TV] (or [VCR]) and [⏻] in succession, the TV (or VCR) and receiver will be turned on and the selector on the receiver will change to TV (or VCR). Press [⏻] within 3 seconds of pressing [TV] (or [VCR]).

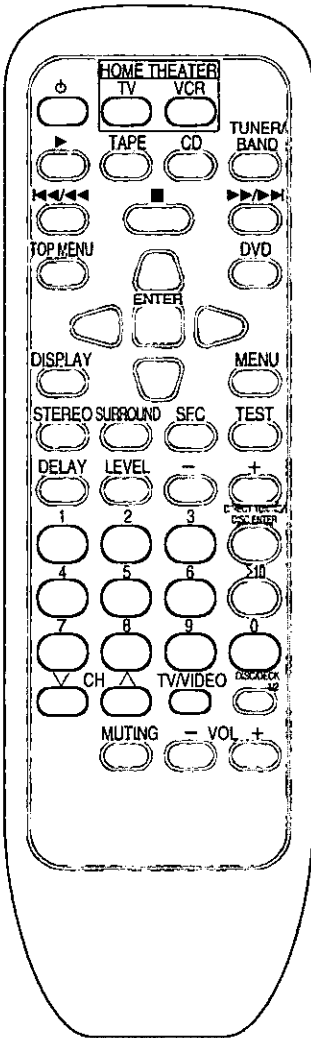

To watch TV broadcasts

Point the remote control toward the TV and the receiver



Switch ON the TV and the receiver.

The receiver will switch to TV input.

Point the remote control toward the TV



Set the TV/VIDEO mode on the TV to "TV".

Point the remote control toward the TV

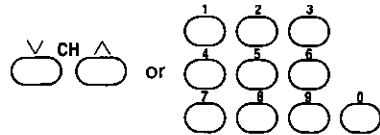

Select the desired channel.

Note

If you allow more than 3 seconds to pass between pressing [TV] and [⏻], only the TV will be operated.

Do not use this remote control to turn the TV ON and OFF if you are not using the receiver.

To watch TV broadcasts with a VCR tuner

Point the remote control toward the TV and the receiver



Switch ON the TV and the receiver.

Point the remote control toward the VCR and the receiver



Switch ON the VCR.

The receiver will switch to VCR input.

Set the input selector on the VCR to the "TUNER" position



Point the remote control toward the VCR

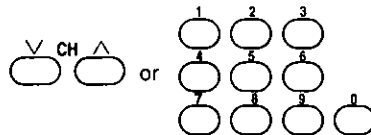

Select the desired channel.

Point the remote control toward the TV



Set the TV/VIDEO mode on the TV to "VIDEO".

Note

If you allow more than 3 seconds to pass between pressing [VCR] and [⏻], only the VCR will be operated.

Do not use this remote control to turn the VCR ON and OFF if you are not using the receiver.

To switch OFF the TV



To switch OFF the VCR



Note

Turn the receiver OFF last.

To watch video tapes

The procedures below are examples for when a TV and VCR are connected to the receiver as shown in this manual.

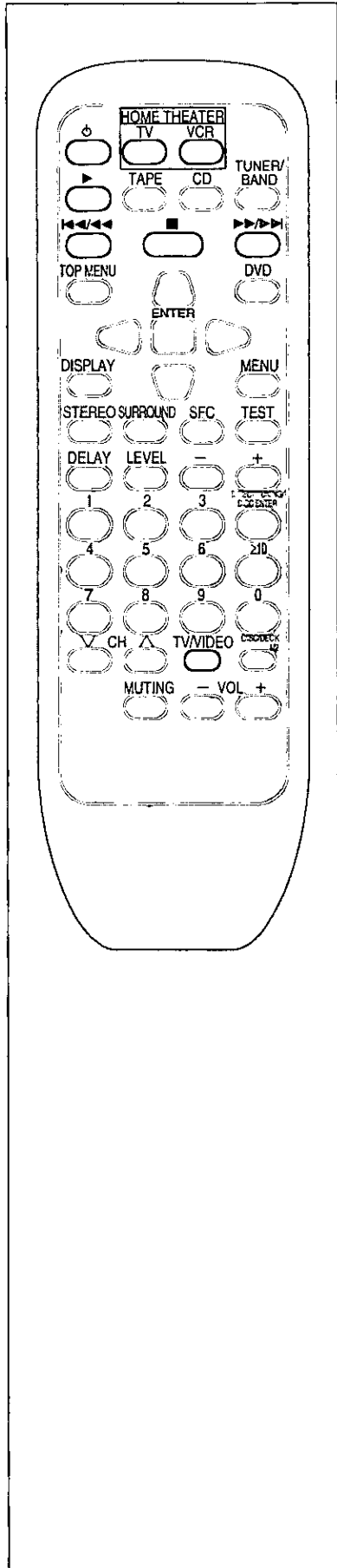

To watch video tapes

<p>Point the remote control toward the TV and the receiver</p> <p>TV → [TV] → [TV]</p> <p>Switch ON the TV and the receiver.</p>	<p>Point the remote control toward the VCR and the receiver</p> <p>VCR → [VCR] → [VCR]</p> <p>Switch ON the VCR.</p> <p>The receiver will switch to VCR input.</p>	<p>Point the remote control toward the TV</p> <p>TV → [TV/VIDEO] → [TV/VIDEO]</p> <p>Set the TV/VIDEO mode on the TV to "VIDEO".</p>
<p>Point the remote control toward the VCR</p> <p>[VCR]</p> <p>Playback will begin.</p>		

To fast-forward or rewind the video tape

VCR → [FF] [REW]

In the stop mode

VCR → [STOP]

To stop playback

VCR → [STOP]

VCR → [STOP]

To switch OFF the TV

TV → [TV]

To switch OFF the VCR

VCR → [VCR]

Note
Turn the receiver OFF last.

To operate a DVD player

The procedures below are examples for when a TV and DVD player are connected to the receiver as shown in this manual.

Make sure the remote control is in the DVD player operation mode. (→ Page 26.)

Actual operations depend on your equipment and software.

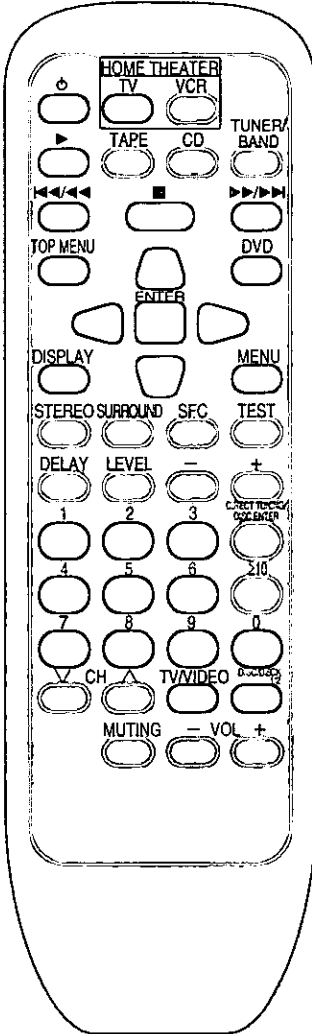

To watch DVDs

Point the remote control toward the TV and the receiver



Switch ON the TV and the receiver.

Point the remote control toward the DVD player and receiver

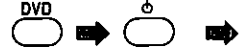

Switch ON the DVD player.

The receiver will switch to DVD input.

Point the remote control toward the TV



Set the TV/VIDEO mode on the TV to "VIDEO".

Point the remote control toward the DVD player.



Play will begin.

[DVD changer only]
To start play from the desired disc

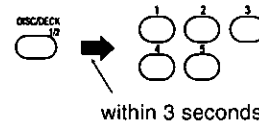

Select disc number.

within 3 seconds

To select the top menu

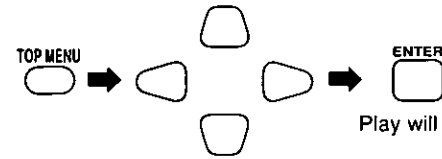

Play will begin.

To use the DVD menu

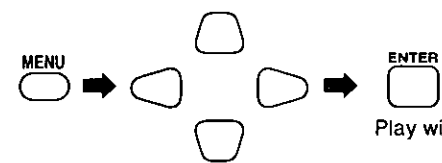

Play will begin.

To use on-screen graphic controls
(Graphic user interfaces, GUI, are a feature of some DVD players. See your player's manual for details.)

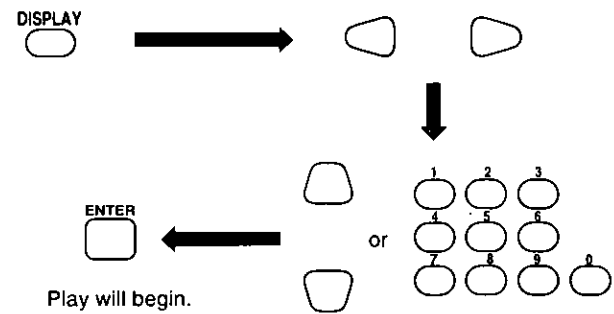

Play will begin.

To skip to the beginning of a track or chapter



To stop play



To switch OFF the TV



To switch OFF the DVD player



Note

Turn the receiver OFF last.

Making a recording

Note

When you select DVD 6CH INPUT mode, only sound from the front left and right channels is recorded.

To record all 6 channels

Set the playback mode on your DVD player or decoder to two channel (stereo) mode. For details, see the equipment's operating instructions.

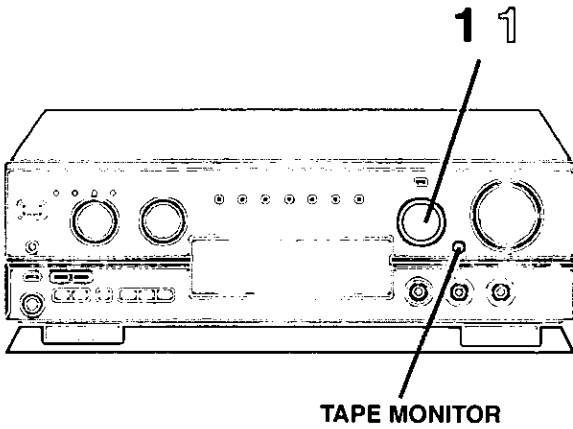

TAPE MONITOR

A

1

INPUT SELECTOR



B

TAPE MONITOR



C

1

INPUT SELECTOR



A Recording on a tape deck

Before recording, prepare the tape deck.
See the tape deck's operating instructions for details.

1 Turn [INPUT SELECTOR] to select the source to be recorded.

Any source can be selected except TAPE.

2 Begin recording on the tape deck.

Follow your tape deck's operating instructions.

3 Begin the source to be recorded.

Follow your equipment's operating instructions.

B To monitor the recorded sound

It is possible to check the sound being recorded if your tape deck is a 3 head system.

Press [TAPE MONITOR] on this unit and set the monitor button on the tape deck to "TAPE".

Press [TAPE MONITOR] once again to turn it off.

C Recording on a VCR

Before recording, prepare the VCR.
See the VCR's operating instructions for details.

1 Turn [INPUT SELECTOR] to select the source to be recorded.

Any source can be selected except VCR and TAPE.

Note

Recording from the tape deck is not possible.

2 Begin recording on the VCR.

Follow your VCR's operating instructions.

3 Begin the source to be recorded.

Follow your equipment's operating instructions.

Specifications (IHF'78)

■ AMPLIFIER SECTION

Rated minimum sine wave RMS power output	
40 Hz–20 kHz both channels driven	100 W per channel (8 Ω)
0.8 % total harmonic distortion	
1 kHz continuous power output both channels driven	
0.05 % total harmonic distortion	105 W per channel (8 Ω)
Total harmonic distortion	
rated power at 40 Hz–20 kHz	0.8 % (8 Ω)
half power at 1 kHz	0.07 % (8 Ω)
Power output at the Dolby Pro Logic operation	
0.9 % at 1 kHz,	
Front	2 x 100 W (8 Ω)
Center	100 W (8 Ω)
Surround	2 x 100 W (8 Ω)
Low frequency damping factor	
	30 (8 Ω)
Load impedance	
Front	
A or B	4–8 Ω
A and B	8 Ω
Center	8 Ω
Surround	8 Ω
Frequency response	
PHONO	RIAA standard curve (30 Hz–15 kHz) ±0.8 dB
CD, TAPE, DVD, VCR, TV	10 Hz–70 kHz, ±3 dB
Input sensitivity	
PHONO	0.4 mV (3 mV, IHF '66)
CD, TAPE, DVD, VCR, TV	27 mV (200 mV, IHF '66)
S/N (IHF A)	
PHONO	70 dB (80 dB, IHF '66)
CD, TAPE, DVD, VCR, TV	75 dB (85 dB, IHF '66)
Input impedance	
PHONO	47 kΩ
CD, TAPE, DVD, VCR, TV	22 kΩ
Tone controls	
BASS	50 Hz, +10 to –10 dB
TREBLE	20 kHz, +10 to –10 dB
Subwoofer frequency response	
	7–100 Hz, ±3 dB

■ FM TUNER SECTION

Frequency range	87.9–107.9 MHz
Sensitivity	11.2 dBf (2 μV, IHF '58)
50 dB quieting sensitivity	
MONO	18.3 dBf (4.5 μV, IHF '58)
STEREO	38.3 dBf (45 μV, IHF '58)
Total harmonic distortion	
MONO	0.2 %
STEREO	0.3 %
S/N	
MONO	73 dB
STEREO	67 dB
Frequency response	20 Hz–15 kHz, +1 dB, –2 dB
Alternate channel selectivity	65 dB
Capture ratio	1.5 dB
Image rejection at 98 MHz	40 dB
Spurious response rejection at 98 MHz	75 dB
AM suppression	50 dB
Stereo separation	
1 kHz	40 dB
10 kHz	30 dB
Antenna terminal	75 Ω (unbalanced)

■ AM TUNER SECTION

Frequency range	530–1710 kHz
Sensitivity	20 μV, 330 μV/m
Selectivity	55 dB
IF rejection (at 1000 kHz)	50 dB

■ VIDEO SECTION

Output voltage at 1 V input (unbalanced)	1±0.1 Vp-p
Maximum input voltage	1.5 Vp-p
Input/output impedance	75 Ω (unbalanced)

■ GENERAL

Power supply	AC 120 V, 60 Hz
Power consumption	450 VA, 350 W
Dimensions (W x H x D)	430 x 136 x 320.6 mm (16-15/16" x 5-11/32" x 12-5/8")
Weight	8.8 kg (19.54 lb.)

Power consumption in standby mode: 1 W

Notes:

- Specifications are subject to change without notice. Weight and dimensions are approximate.
- Total harmonic distortion is measured by the digital spectrum analyzer.

Maintenance

If the surfaces are dirty

To clean this unit, wipe with a soft, dry cloth.

If the surfaces are extremely dirty, use a soft cloth dipped in a soap-and-water solution or a weak detergent solution.

- Never use alcohol, paint thinner or benzene to clean this unit.
- Before using chemically treated cloth, read the instructions that came with the cloth carefully.

Product Service

Do not attempt to remove the cover(s) or repair the unit yourself. Refer servicing to qualified personnel only.

Product information

For product service, product information or assistance with product operation, refer to the servicenter directory.

Troubleshooting guide

Before requesting service for this unit, check the chart below for a possible cause of the problem you are experiencing. Some simple checks or a minor adjustment on your part may eliminate the problem and restore proper operation.

If you are in doubt about some of the check points, or if the remedies indicated in the chart do not solve the problem, refer to the directory of Authorized Service Centers to locate a convenient service center, or consult your dealer for instructions.

For detailed instructions, contact an authorized servicer in the U.S.A. and Panasonic Canada Inc. Customer Care Centre in Canada.

In the U.S.A. 1-800-211-7262 or web site (<http://www.panasonic.com>)

In Canada 905-624-5505 or web site (www.panasonic.ca)

Problem	Probable cause(s)	Suggested remedy	Page(s)
While listening to FM broadcasts			
Hiss is heard during stereo broadcasts, but not during monaural ones.	Modulation for the two types is different so some noise may be heard during stereo broadcasts.	<ul style="list-style-type: none"> • Reduce the treble. • Change the location and direction of the antenna. • Use an outdoor antenna. • Use an antenna with more elements. 	25
			10
Excessive noise in both stereo and monaural broadcasts.	Antenna location and direction poor.	<ul style="list-style-type: none"> • Use an antenna with more elements. 	–
	Station is distant.		
“STEREO” and “QUARTZ LOCK” indicators flicker.	Antenna location and direction poor.	<ul style="list-style-type: none"> • Change the location and direction of the antenna. • Use an outdoor antenna. • Use an antenna with more elements. 	10
	Station is distant.		10
Stereo broadcasts highly distorted.	Building or mountain nearby.	<ul style="list-style-type: none"> • Use an antenna with more elements. 	–

While listening to AM broadcasts			
Unusual “beat” sound is heard.	A television is on nearby.	• Separate the two or turn the television off.	–
	Adjacent signal is interfering.	• Reduce the treble.	25
Low-pitched “hum” is heard when a station is tuned.	Power cord is near the antenna wires.	• Separate the power cord from the wires.	–
	Electronic interference from the power cord is fed to the speakers.	• Use an outdoor antenna.	10
A continuous or intermittent hiss is heard.	Interference from other appliances.	• Separate this unit from such appliances.	–

While enjoying sound modes			
Sound doesn't come from the center speaker while using Dolby Pro Logic.	PHANTOM is selected.	• Select NORMAL or WIDEBAND.	21
Sound doesn't come from the center speaker, surround speakers, or subwoofer while using DVD 6CH INPUT.	Speaker settings are incorrect.	• Check speaker setting of the DVD player or digital surround processor.	–

Problem	Probable cause(s)	Suggested remedy	Page(s)
Common Problems			
Unit doesn't come on.	The power cord plug is not fully inserted.	<ul style="list-style-type: none"> • Confirm the plug is fully inserted. 	-
Sound is not heard.	The speaker indicators are off.	<ul style="list-style-type: none"> • Turn on the speaker indicators. 	14
	The tape monitor function is on.	<ul style="list-style-type: none"> • Press the tape monitor button. 	15
	The muting function is on.	<ul style="list-style-type: none"> • Press the muting button on the remote control. 	25
	Incomplete or incorrect connection to speakers and external equipment.	<ul style="list-style-type: none"> • Check all connections. 	8-13
	The incorrect input source has been selected.	<ul style="list-style-type: none"> • Select the correct source. 	14
Sound suddenly stops or none is heard when the unit is switched on. "OVERLOAD" appears on the display.	The protection circuitry has functioned because: the positive and negative speaker wires have shorted; speakers with a lower impedance than this unit's rated impedance are being used; the speakers are under strain through excessive volume, excessive power, or by being used in a high temperature environment.	<ul style="list-style-type: none"> • Switch off the unit, determine and correct the cause, then switch the unit on. • Use speakers with the right impedance rating. 	- 12-13

About the HELP function

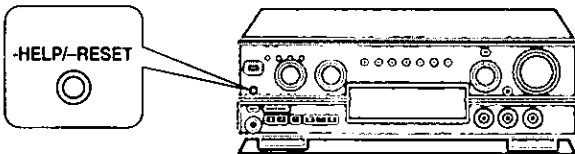

If you make a mistake in operation or if sound output stops due to some operation which was performed, the HELP function displays information which can be useful for indicating the method by which this condition can be remedied.

If "ERROR" or scrolling characters (for instance, "SPEAKER OFF NOW") appear on the display during operation, carry out the following operation.

Press [-HELP/-RESET].

The method for remedying this situation will be displayed.

For your reference

If the above button is pressed for 2 seconds or more until "RESET" appears on the display, the operation settings for the unit will be initialized to the settings made at the time of shipment.

However, any stations which have been preset into memory will not be erased at this time.

Listening caution



Selecting fine audio equipment such as the unit you've just purchased is only the start of your musical enjoyment. Now it's time to consider how you can maximize the fun and excitement your equipment offers. This manufacturer and the Electronic Industries Association's Consumer Electronics Group want you to get the most out of your equipment by playing it at a safe level. One that lets the sound come through loud and clear without annoying blaring or distortion—and, most importantly, without affecting your sensitive hearing.

We recommend you to avoid prolonged exposure to excessive noise.

Sound can be deceiving. Over time your hearing "comfort level" adapts to higher volumes of sound. So what sounds "normal" can actually be loud and harmful to your hearing.

Guard against this by setting your equipment at a safe level BEFORE your hearing adapts.

To establish a safe level:

- Start your volume control at a low setting.
- Slowly increase the sound until you can hear it comfortably and clearly, and without distortion.

Once you have established a comfortable sound level:

- Set the dial and leave it there.

Taking a minute to do this now will help to prevent hearing damage or loss in the future. After all, we want you listening for a lifetime.

Panasonic

Technics

Quasar

*For Product Information, Operating Assistance, Literature Request, Dealer Locations, and all Customer Service inquiries please contact:
1-800-211-PANA (7262), Monday-Friday 9 am-9 pm; Saturday-Sunday 9 am-7 pm, EST.*

*Web Site: <http://www.panasonic.com>
You can purchase parts, accessories or locate your nearest servicenter by visiting our Web Site.*

Accessory Purchases:

1-800-332-5368 (Customer Orders Only)
Panasonic Services Company 20421 84th Avenue South, Kent, WA 98032
(6 am to 5 pm Monday-Friday; 6 am to 10:30 am Saturday; PST)
(Visa, MasterCard, Discover Card, American Express, Check)

Factory Servicenters Locations

CALIFORNIA
6550 Katella Avenue
Cypress, CA 90630

800 Dubuque Avenue
S. San Francisco
CA 94080

20201 Sherman Way
Suite 102
Canoga Park, CA 91306

3878 Ruffin Road
Suite A
San Diego, CA 92123

COLORADO
1640 South Abilene Street
Suite D
Aurora, CO 80012

FLORIDA
3700 North 29th Avenue
Suite 102
Hollywood, FL 33020

GEORGIA
8655 Roswell Road
Suite 100
Atlanta, GA 30350

ILLINOIS
9060 Golf Road
Niles, IL 60714

1703 North Randall Road
Elgin, IL 60123
(Pick-up/Drop-off only)

MARYLAND
62 Mountain Road
Glen Burnie, MD 21061

MASSACHUSETTS
60 Glacier Drive
Suite G
Westwood, MA 02090

MICHIGAN
37048 Van Dyke Avenue
Sterling Heights, MI 48312

MINNESOTA
7850-12th Avenue South
Airport Business Center
Bloomington, MN 55425

OHIO
2236 Waycross Road
Civic Center Plaza
Forest Park, OH 45240

PENNSYLVANIA
2221 Cabot Blvd. West
Suite B
Langhorne, PA 19047

Chartiers Valley
Shopping Center
1025 Washington Pike
Bridgeville, PA 15017

TENNESSEE
3800 Ezell Road
Suite 806
Nashville, TN 37211

TEXAS
7482 Harwin Drive
Houston, TX 77036

13615 Welch Road
Suite 101
Farmers Branch
TX 75244

WASHINGTON
20425-84th Avenue South
Kent, WA 98032

HAWAII
99-859 Iwaiwa Street
Aiea, Hawaii 96701
Phone (808) 488-1996
Fax (808) 486-4369

Service in Puerto Rico

*Matsushita Electric of Puerto Rico, Inc. Panasonic Sales Company/Factory Servicenter:
Ave. 65 de Infantería, Km. 9.5, San Gabriel Industrial Park, Carolina, Puerto Rico 00985
Phone (787) 750-4300 Fax (787) 768-2910*

Panasonic Consumer Electronics Company, Division of Matsushita Electric Corporation of America
One Panasonic Way Secaucus,
New Jersey 07094
<http://www.panasonic.com>

Panasonic Sales Company, Division of Matsushita Electric of Puerto Rico, Inc. ("PSC")
Ave. 65 de Infantería, Km. 9.5
San Gabriel Industrial Park, Carolina,
Puerto Rico 00985

Panasonic Canada Inc.
5770 Ambler Drive
Mississauga, Ontario
L4W 2T3
www.panasonic.ca



Free Manuals Download Website

<http://myh66.com>

<http://usermanuals.us>

<http://www.somanuals.com>

<http://www.4manuals.cc>

<http://www.manual-lib.com>

<http://www.404manual.com>

<http://www.luxmanual.com>

<http://aubethermostatmanual.com>

Golf course search by state

<http://golfingnear.com>

Email search by domain

<http://emailbydomain.com>

Auto manuals search

<http://auto.somanuals.com>

TV manuals search

<http://tv.somanuals.com>