

AV Control Stereo Receiver SA-AX910/SA-AX810 SA-AX710/SA-AX610

Operating Instructions



The photographs show SA-AX910.



Technics®

Before connecting, operating or adjusting this product, please read these instructions completely. Please save this manual.

P PC

RQT3815-1P

Dear Customer

Thank you for purchasing this Technics product. For optimum performance and safety, please read these instructions carefully.

These operating instructions are applicable to models SA-AX910, SA-AX810, SA-AX710 and SA-AX610, however, are intended primarily for model SA-AX910.

Table of contents

Precautions	3
Accessories	4
Concerning the remote control	4
Front panel controls	5
Equipment connections	6
Antenna connections	9
Speaker connections	11
Basic operations	13
To adjust the tone quality	14
To adjust the sound balance	14
To mute the sound level	14
To listen through headphones	14
To correct sound in case of low volume	14
When using the VCR 2 terminal (front side)	
SA-AX910/AX810 only	14
Listening to radio broadcasts	15
Sequential tuning	15
Direct tuning	15
Preset tuning	16
Enjoying sound with DOLBY PRO LOGIC	18
Setting the center mode and adjusting speakers output level	18
Adjusting the delay time	20
Enjoying with SURROUND or 3 STEREO	20
Enjoying sound with SFC	21
Adjusting field of sound	22
Enjoying sound with 6 channel discrete	23
Making a recording	24
Recording on the tape deck	24
Recording on the VCR	24
Sleep timer function SA-AX910/AX810 only	25
About the HELP function	25
About the On-Screen Display function	
SA-AX910/AX810 only	26
Product service	26
Listening caution	26
Troubleshooting guide	27
Technical specifications	Back cover

User memo:

DATE OF PURCHASE _____
 DEALER NAME _____
 DEALER ADDRESS _____

 TELEPHONE NUMBER _____

The model number and serial number of this product can be found on either the back or the bottom of the unit. Please note them in the space provided below and keep for future reference.

MODEL NUMBER

SERIAL NUMBER

THIS PHRASE IS APPLIED ONLY FOR U.S.A.

CAUTION:

Any unauthorized changes or modifications to this equipment would void the user's authority to operate this device.

WARNING:

TO REDUCE THE RISK OF FIRE, ELECTRIC SHOCK OR PRODUCT DAMAGE, DO NOT EXPOSE THIS APPLIANCE TO RAIN, SPLASHING, DRIPPING OR MOISTURE.

CAUTION:

TO PREVENT ELECTRIC SHOCK MATCH WIDE BLADE OF PLUG TO WIDE SLOT, FULLY INSERT.



CAUTION

RISK OF ELECTRIC SHOCK

DO NOT OPEN



CAUTION: TO REDUCE THE RISK OF ELECTRIC SHOCK, DO NOT REMOVE SCREWS. NO USER-SERVICEABLE PARTS INSIDE. REFER SERVICING TO QUALIFIED SERVICE PERSONNEL.



The lightning flash with arrowhead symbol, within an equilateral triangle, is intended to alert the user to the presence of uninsulated "dangerous voltage" within the product's enclosure that may be of sufficient magnitude to constitute a risk of electric shock to persons.



The exclamation point within an equilateral triangle is intended to alert the user to the presence of important operating and maintenance (servicing) instructions in the literature accompanying the appliance.

Precautions

Before using this unit please read these operating instructions carefully. Take special care to follow the warnings indicated on the unit itself as well as the safety suggestions listed below. Afterwards keep them handy for future reference.

Safety

- 1. Power Source** -- The unit should be connected to power supply only of the type described in the operating instructions or as marked on the unit.
- 2. Polarization** -- If the unit is equipped with a polarized AC power plug (a plug having one blade wider than the other), that plug will fit into the AC outlet only one way. This is a safety feature. If you are unable to insert the plug fully into the outlet, try reversing the plug. If the plug should still fail to fit, contact your electrician to replace your obsolete outlet. Do not defeat the safety purpose of the polarized plug.
- 3. Power Cord Protection** -- AC power supply cords should be routed so that they are not likely to be walked on or pinched by items placed upon or against them. Never take hold of the plug or cord if your hand is wet, and always grasp the plug body when connecting or disconnecting it.
- 4. Nonuse Periods** -- When the unit is not used, turn the power off. When left unused for a long period of time, the unit should be unplugged from the household AC outlet.

Installation

Environment

- 1. Outdoor Antenna Grounding** -- If an outside antenna is connected to the receiver, be sure the antenna system is grounded so as to provide some protection against voltage surges and built-up static charges. Section 810 of the National Electrical Code, ANSI/NFPA No. 70-1990, provides information with respect to proper grounding of the mast and supporting structure, grounding of the lead-in wire to an antenna discharge unit, size of grounding conductors, location of antenna-discharge unit, connection to grounding electrodes, and requirements for the grounding electrode. See figure below.

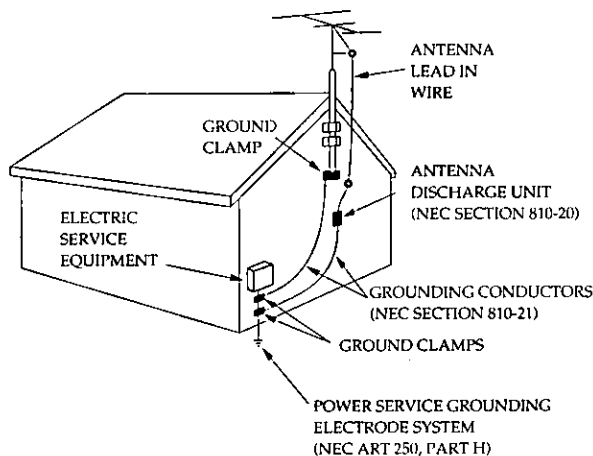

NEC-NATIONAL ELECTRICAL CODE

- 2. Water and Moisture** -- Do not use this unit near water-for example, near a bathtub, washbowl, swimming pool, or the like. Damp basements should also be avoided.
- 3. Heat** -- The unit should be situated away from heat sources such as radiators and the like. It also should not be placed in temperatures less than 5°C (41°F) or greater than 35°C (95°F).

Placement

- 1. Ventilation** -- The unit should be situated so that its location or position does not interfere with its proper ventilation. Allow 10 cm (4") clearance from the rear of the unit.
- 2. Foreign Material** -- Care should be taken so that objects do not fall into and liquids are not spilled into the unit. Do not subject this unit to excessive smoke, dust, mechanical vibration, or shock.
- 3. Magnetism** -- The unit should be situated away from equipment or devices that generate strong magnetic fields.
- 4. Stacking** -- Do not place heavy objects, other than system components, on top of the unit.
- 5. Surface** -- Place the unit on a flat, level surface.
- 6. Carts and Stands** -- The unit should be used only with a cart or stand that is recommended by the manufacturer. The unit and cart combination should be moved with care. Quick stops, excessive force, and uneven surfaces may cause the unit and cart combination to overturn.
- 7. Wall or Ceiling Mounting** -- The unit should not be mounted to a wall or ceiling, unless specified in this operating instructions.



Maintenance

Clean the cabinet, panel and controls with a soft cloth lightly moistened with mild detergent solution. Do not use any type of abrasive pad, scouring powder or solvent such as alcohol or benzine.

Service

- 1. Damage Requiring Service** -- The unit should be serviced by qualified service personnel when:
(a) The AC power supply cord or the plug has been damaged; or
(b) Objects have fallen or liquid has been spilled into the unit; or
(c) The unit has been exposed to rain; or
(d) The unit does not appear to operate normally or exhibits a marked change in performance; or
(e) The unit has been dropped, or the enclosure damaged.
- 2. Servicing** -- The user should not attempt to service the unit beyond that described in the operating instructions. All other servicing should be referred to an authorized service personnel. (Only for U.S.A.)
Call 1-800-545-2672 for the address of an authorized factory servicer.

CAUTION

Do not place a tape deck or CD player on top of this unit. Heat radiated from the top of this unit may cause damage to the tape or CD software.

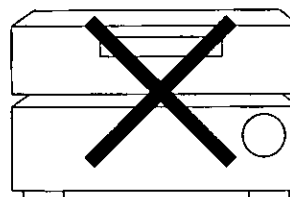

NO

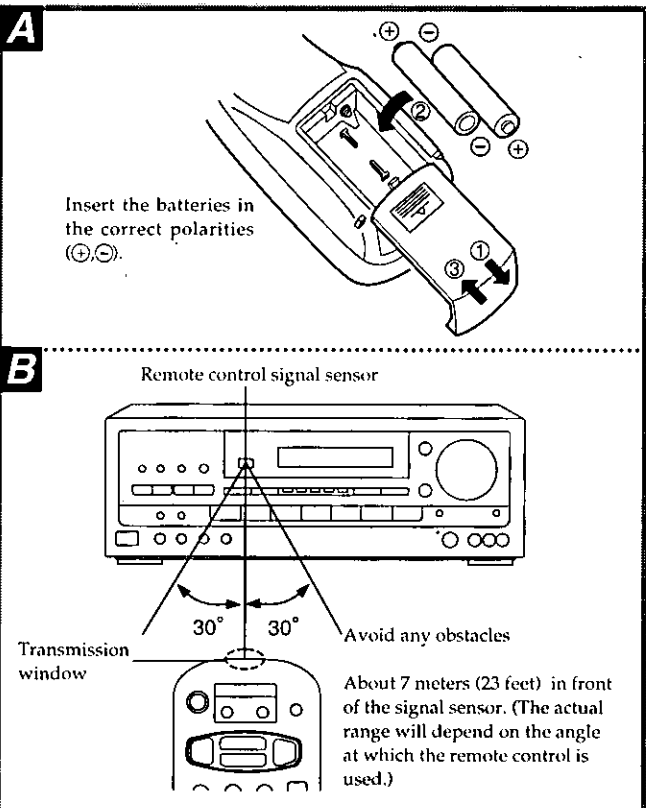
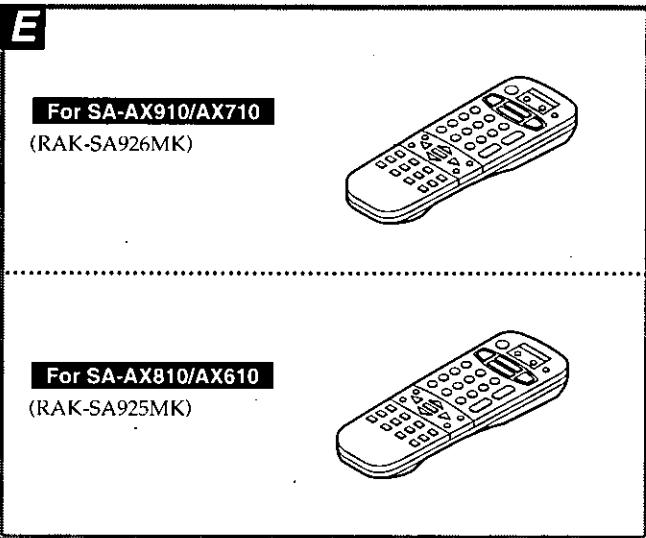
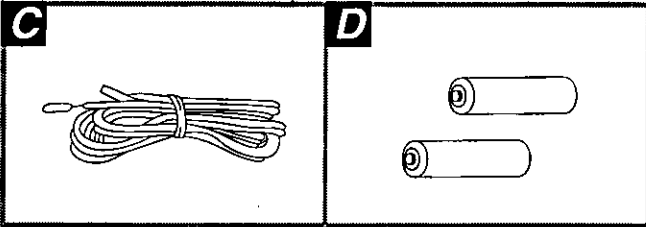
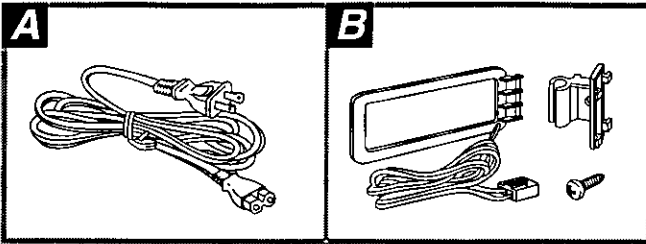

Accessories

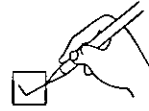

Please check and identify the supplied accessories.

- A** AC power supply cord (SJA 172).....1 pc.
- B** AM loop antenna set (RSA0010)
 - AM loop antenna.....1 pc.
 - AM loop antenna holder.....1 pc.
 - Screw.....1 pc.
- C** FM indoor antenna (RSA0006).....1 pc.
- D** Batteries.....2 pcs.
- E** Remote control transmitter.....1 pc.

Use numbers indicated in parentheses when asking for replacement parts.

(Only for U.S.A.)

To order accessories call PASC Accessory Dept. 1-800-332-5368.

Concerning the remote control

Battery installation

- Thoroughly clean the battery compartment before inserting new batteries.
- Do not mix old and new batteries, or batteries of different types (carbon and alkaline, etc.).
- If you will not use the remote control for a long period of time, remove the batteries and store them in a cool, dark place.
- Do not use rechargeable type batteries.
- Do not attempt to recharge alkaline or carbon batteries.
- Always remove old, weak or worn-out batteries promptly and dispose of them properly.
- Never subject batteries to excessive heat or flame; do not attempt to disassemble them; and be sure they are not short-circuited.
- If the leaking electrolyte comes into contact with skin or clothes, flush with water immediately.

Battery life

Battery life is about one year.

The batteries should be replaced if the system fails to respond to commands from the remote control transmitter even when held close to the remote control signal sensor.

When you need to replace these batteries

Use two R6/LR6, AA size, UM-3

Method for use

Note

Be sure the transmission window and the signal sensor are free from dust. Excessive dust might affect performance.

The operation may not be correct if direct sunlight or another strong light source strikes the signal sensor of this unit. If there is a problem, place the unit away from the light source.

Front panel controls

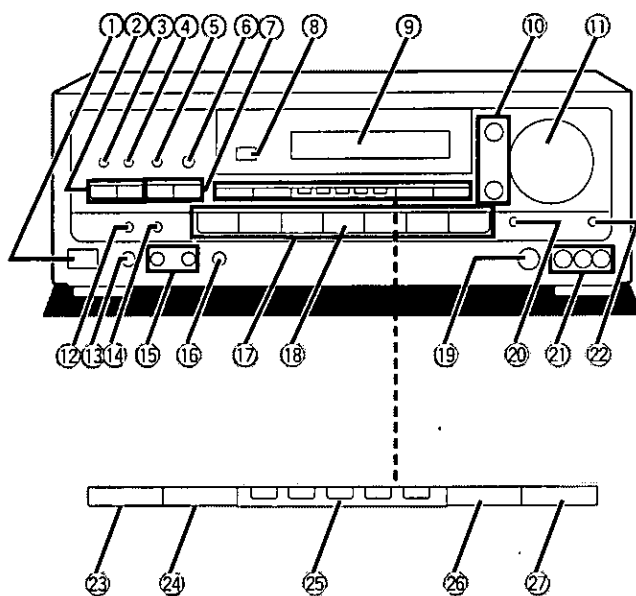

- ① Power "STANDBY \odot /ON" switch
(POWER, STANDBY \odot /ON)
Press to switch the unit from on to standby mode or vice versa. In standby mode, the unit is still consuming a small amount of power.
- ② Tuning buttons (TUNING)
- ③ Band select button (BAND)
- ④ FM mode select button (FM AUTO/MONO)
- ⑤ Memory button (MEMORY)
- ⑥ Help/reset button (-HELP —RESET)
- ⑦ Preset channel buttons (PRESET)
- ⑧ Remote control signal sensor (SENSOR)
- ⑨ Display
- ⑩ Tone controls (BASS, TREBLE)
- ⑪ Volume control (VOLUME)
- ⑫ SA-AX910/AX810 only
Sleep timer button (SLEEP)
- ⑬ Headphones jack (PHONES)
- ⑭ 6ch discrete input select button
(6CH DISCRETE INPUT)
- ⑮ Speakers select buttons (SPEAKERS A, B)
- ⑯ Loudness ON/OFF button (LOUDNESS)
- ⑰ Input select buttons
- ⑱ Tape monitor button (TAPE MONITOR)
- ⑲ Balance control (BALANCE)
- ⑳ Muting button (MUTING)
- ㉑ SA-AX910/AX810 only
VCR 2 front input terminals (VCR 2)
- ㉒ SA-AX910/AX810 only
TV/VCR 2 select button (TV/VCR 2)
- ㉓ DOLBY PRO LOGIC/SFC OFF ON button
(OFF/ON)
- ㉔ DOLBY PRO LOGIC mode select button
(\square PRO LOGIC)
- ㉕ Sound field control select buttons
(SOUND FIELD CONTROL)
- ㉖ Delay time adjust button (DELAY TIME)
- ㉗ Center mode select button (CENTER MODE)

Equipment connections

Connecting audio equipment

Stereo connection cable (not included)

White (L) 
 Red (R) 

Note

Do not place books, etc., on top of this unit or block the heat radiation vents in any way.

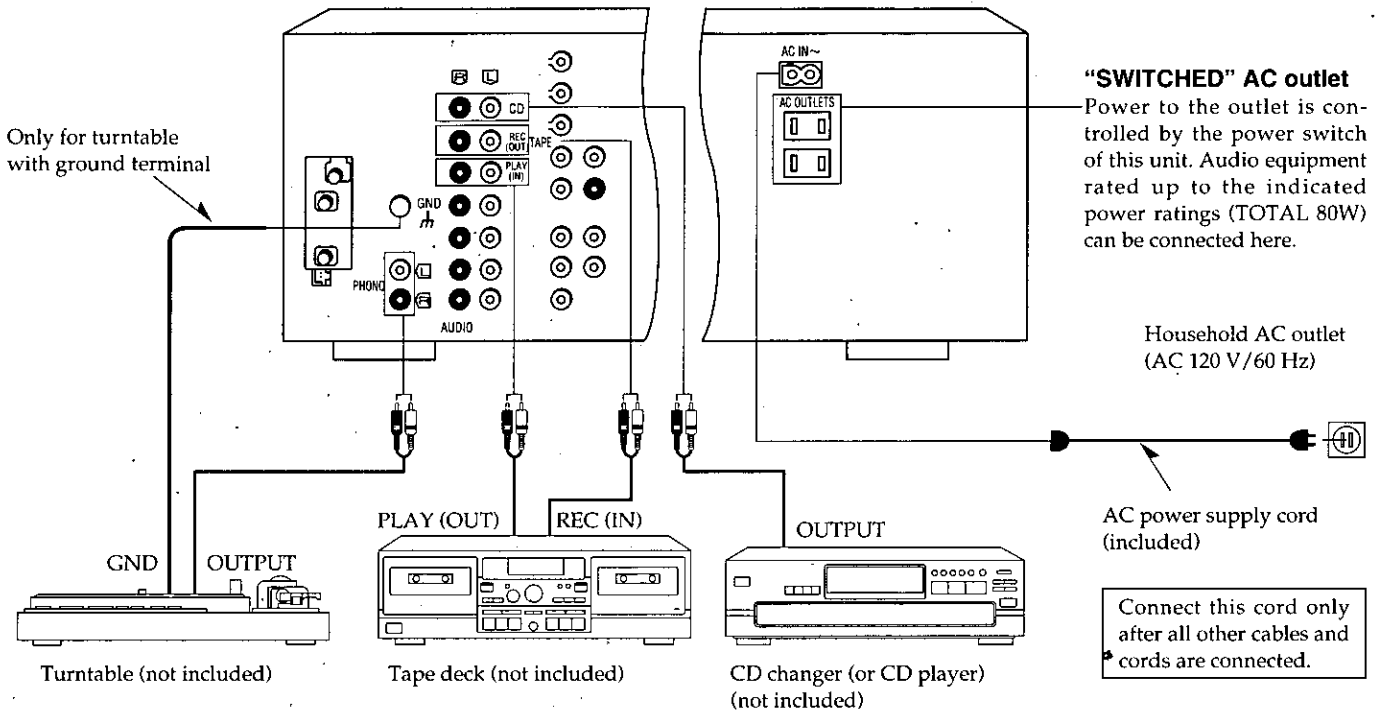

Connecting video equipment For SA-AX710/AX610

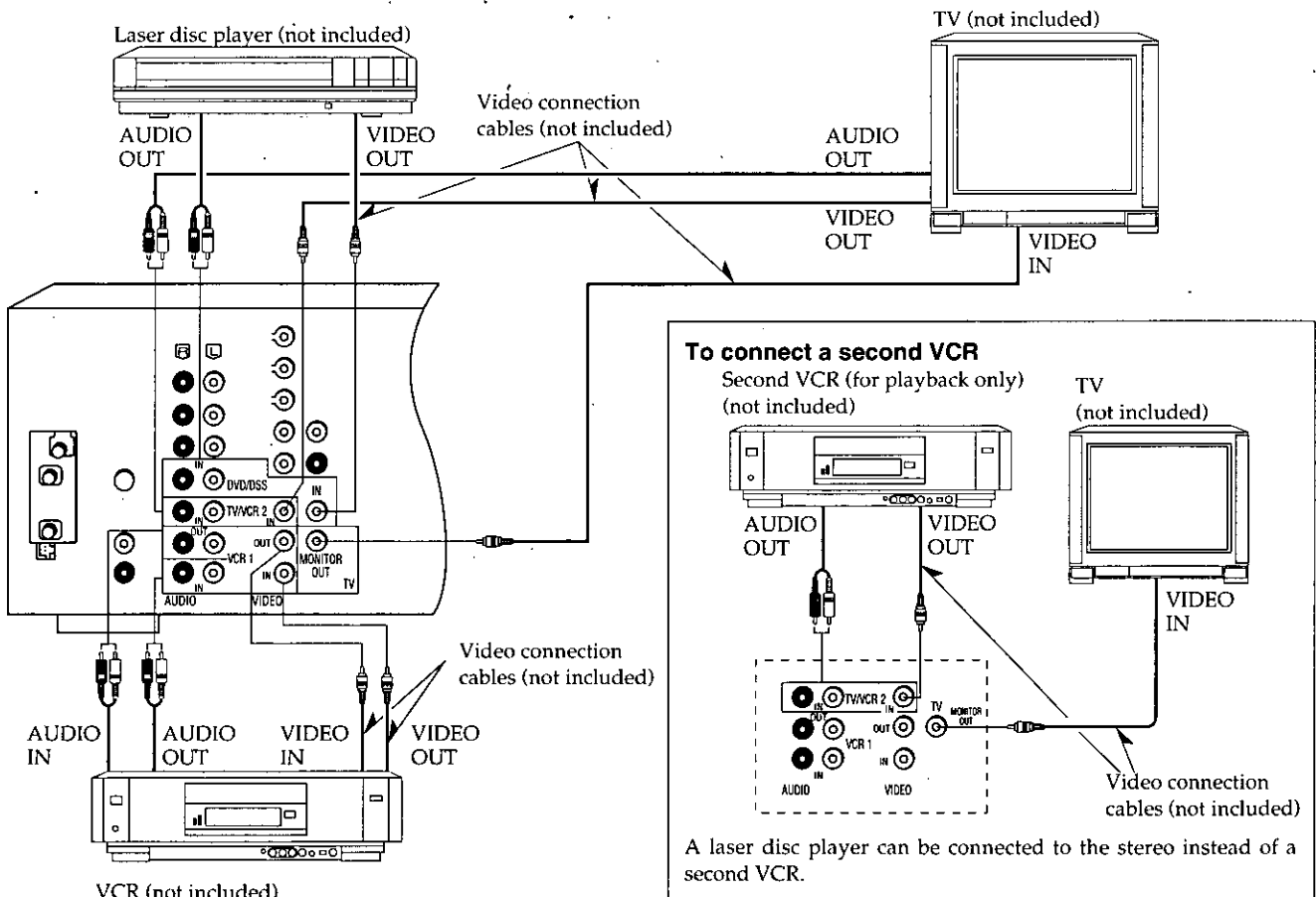

Before use

Connecting video equipment For SA-AX910/AX810

Stereo connection cable (not included)



Laser disc player (not included)

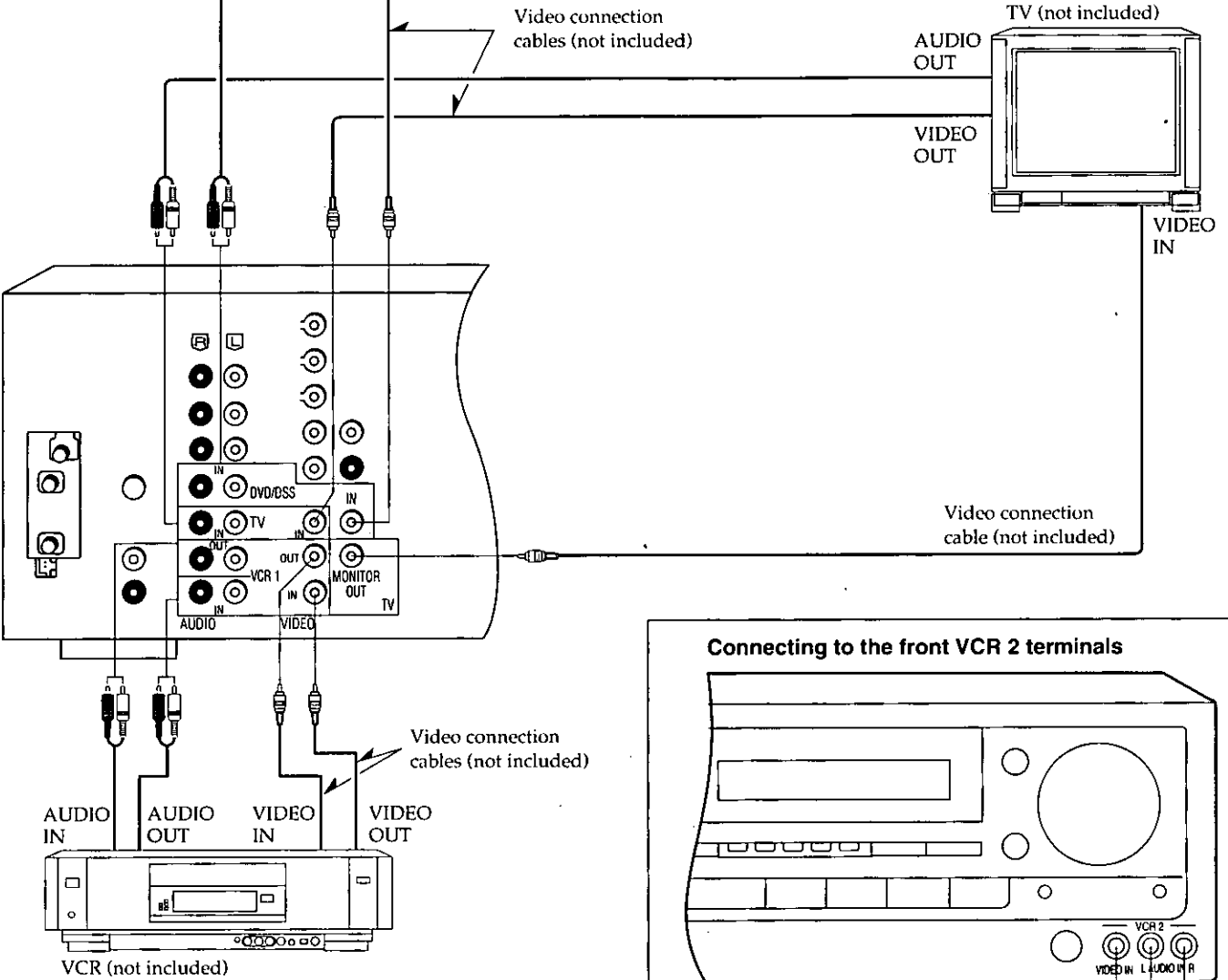

Connecting to the front VCR 2 terminals

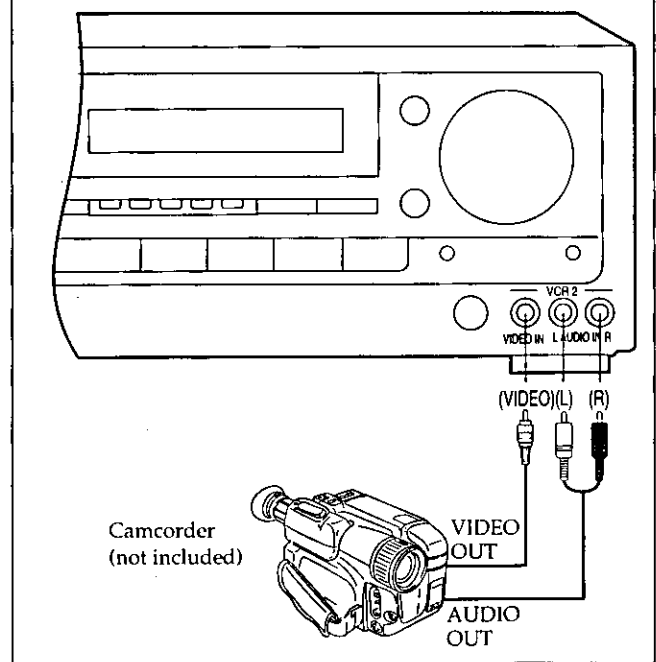

Before use

Connecting a DVD player

Stereo connection cable (not included)



Before use

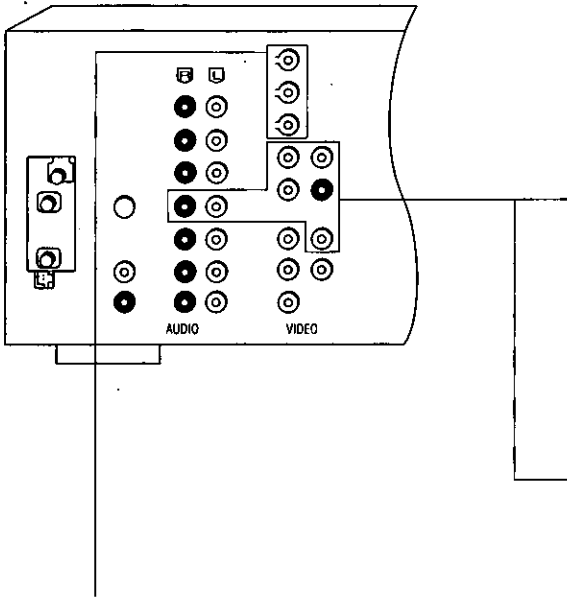

Connecting a DVD player with 6 channel discrete output

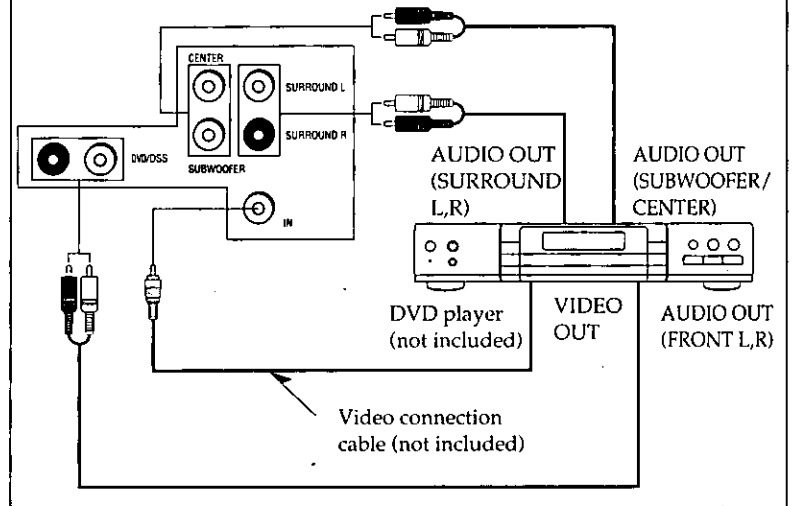

Connecting a DVD player with 2 channel output

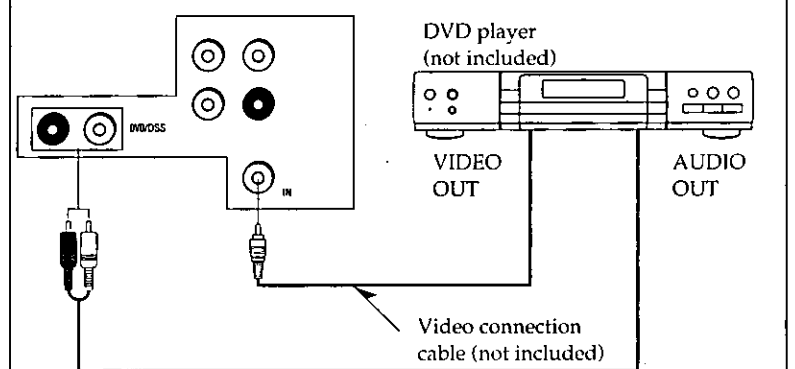

To adjust the input level (CENTER LEVEL/SURROUND L LEVEL/SURROUND R LEVEL)

When connected to a DVD player or other component with 6 channel discrete output, you can adjust input level for the center and surround (L) and (R) channels from these controls.



Turn CENTER LEVEL to adjust the input level of the center channel.



Turn SURROUND L LEVEL to adjust the input level of the surround (L) channel.



Turn SURROUND R LEVEL to adjust the input level of the surround (R) channel.

You can enjoy 6 channel discrete sound by making the below connections.

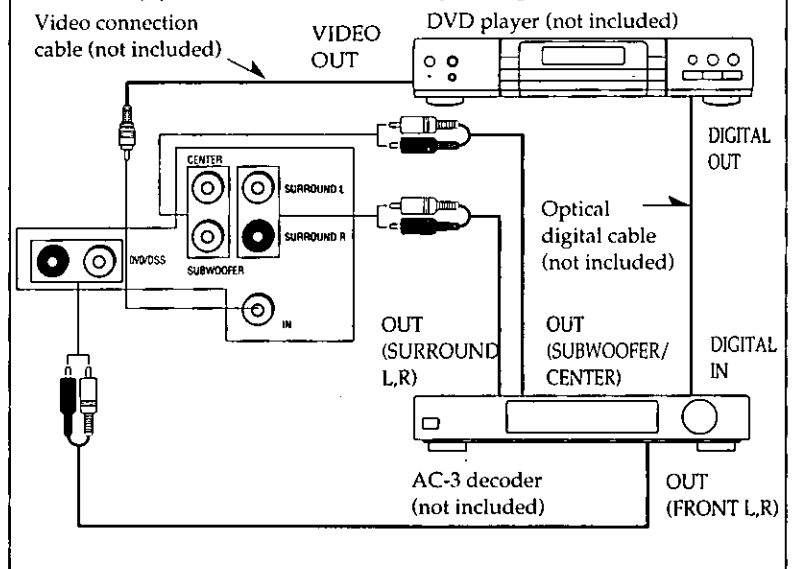

To connect equipment, refer to the appropriate operation instructions.

Antenna connections

FM indoor antenna (included)

This antenna is normally sufficient for reception of FM broadcasts.

Attach to a wall (using a tape) facing in the direction of best reception.

For best reception sound quality

An FM outdoor antenna is recommended.

AM loop antenna (included)

This antenna is normally sufficient for reception of AM broadcasts.

Install the AM loop antenna holder (included) at the rear panel of this unit and then attach the AM loop antenna to the AM loop antenna holder (facing in the direction of best reception).

Pay attention to the following points when mounting the antenna.

- Do not mount it horizontally (Doing so will impair reception).
- Do not mount it close to power cords, speaker wires or metal surfaces (Doing so will result in noise).
- Do not mount it close to a tape deck. When the tape deck is being used, chirping or beeping sounds may result.

When mounting the antenna to a column, a wall or rack

Mount it vertically.

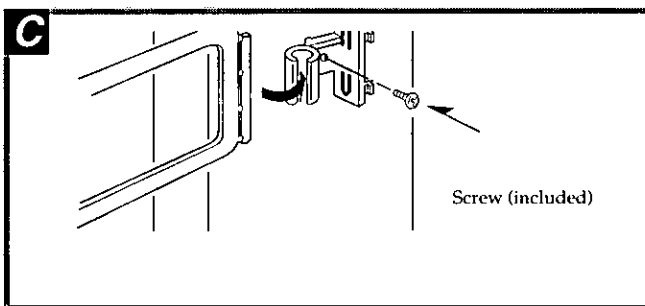
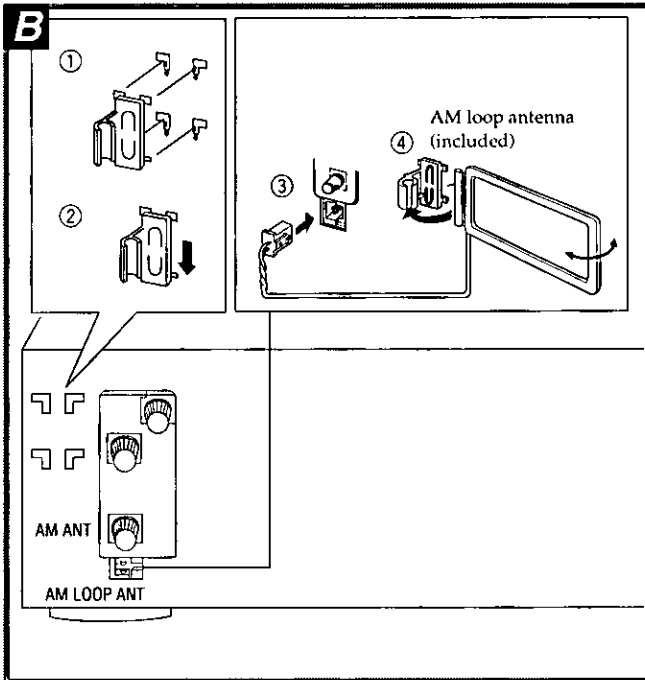
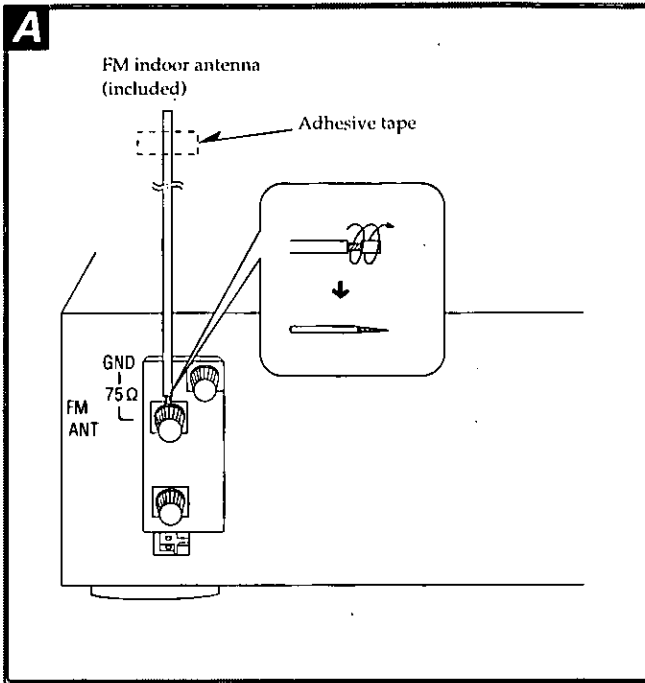

Antenna connections

A

FM outdoor antenna (not included)

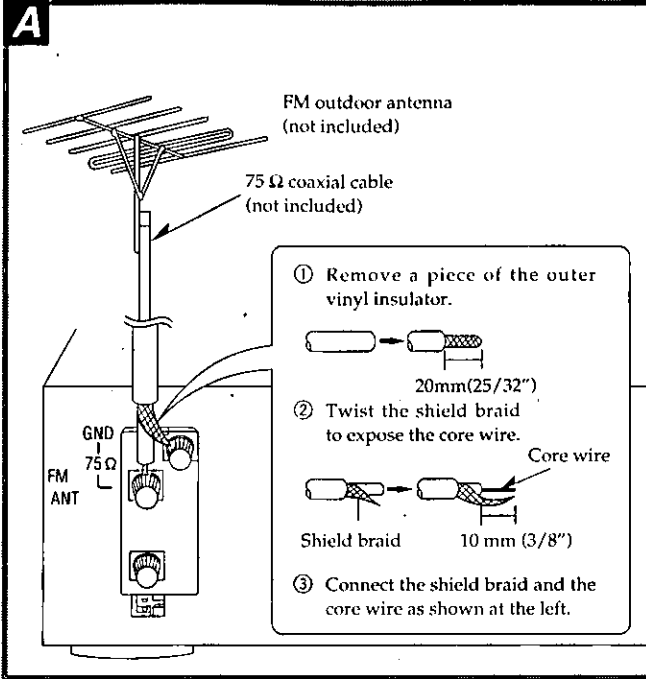

The outdoor antenna should be used when using this unit in mountainous areas or in spaces enclosed by reinforced concrete where the FM indoor antenna (included) does not provide satisfactory reception. Disconnect the FM indoor antenna if an FM outdoor antenna is installed.

Note

An outdoor antenna should be installed by a qualified technician only.

B

AM outdoor antenna (not included)

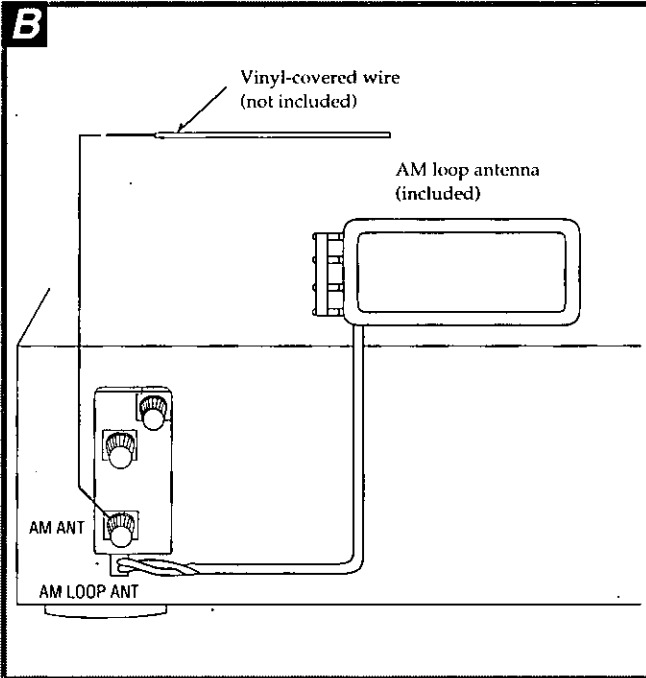

The outdoor antenna should be used when using this unit in mountainous areas or in spaces enclosed by reinforced concrete where the AM loop antenna (included) does not provide satisfactory reception.

Stretch 5–12 m (16–40 ft.) of vinyl-covered wire horizontally across a window frame or other convenient location, keeping it as high as possible from the ground.

When the unit is not in use, disconnect the outdoor antenna to prevent possible damage that may be caused by lightning. Never use an outdoor antenna during an electrical storm.

Note

Be sure to connect the AM loop antenna even when an outdoor antenna is used.

Speaker connections

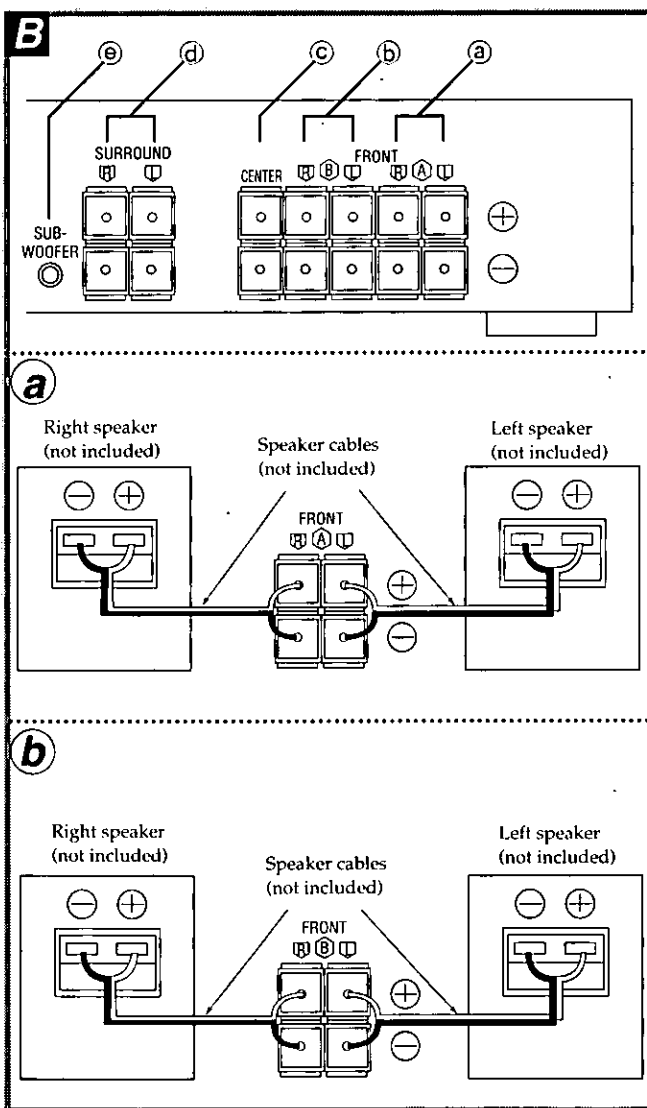
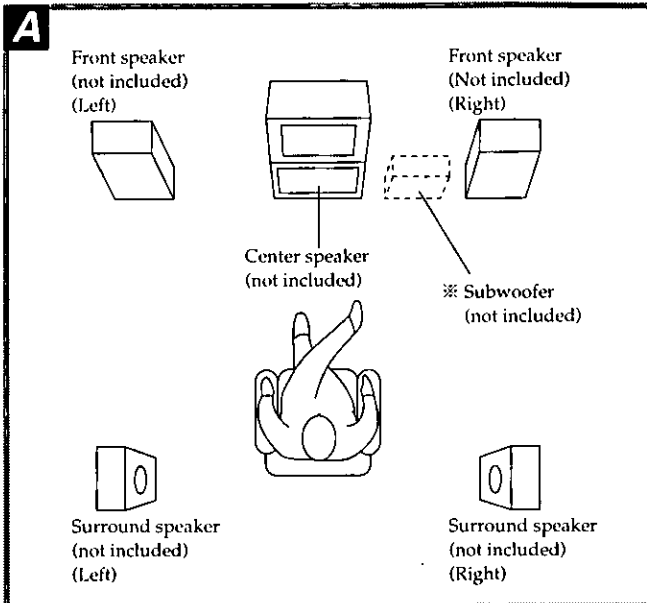

(Continued on next page)

Placement of speakers

A

For front speakers

Place the front left/right speakers at both the left and right sides of the TV at seated ear height so that there is good coherency between the picture and sound.

For center speaker

Place the center speaker underneath or above the center of the TV. Aim the speaker such that it is pointed at the seating area.

For surround speakers

Place the surround speakers on the side of or slightly behind the listener, and about one meter higher than ear level.

For subwoofer

The subwoofer can be placed in any position as long as it is at a reasonable distance from the TV.

Note that some experimentation in placement of the subwoofer can yield smoothest low frequency performance. Placement near a corner can increase the apparent output level, but can result in unnatural bass.

Connecting speakers

B

① Front "A" speakers

② Front "B" speakers

For connection to a second pair of speakers.

Speaker impedance: A or B 4-8 Ω
A and B 8 Ω

③ Center speaker

Speaker impedance: 8 Ω

④ Surround speakers

Note

Do not connect the surround speakers to the front speaker terminals. The surround speakers may be damaged if connected to the front terminals.

Speaker impedance: 8 Ω

⑤ Subwoofer

Note

This receiver has no amplifier section designed especially for the subwoofer.

To connect a subwoofer which does not have a built-in amplifier

Connect an optional amplifier to the "SUBWOOFER" terminal of this unit and then connect a subwoofer to the speaker terminals of the amplifier.

Before use

Speaker connections

Connecting the speaker cables

Note

To prevent damage to circuitry, never short-circuit positive (+) and negative (-) speaker wires.

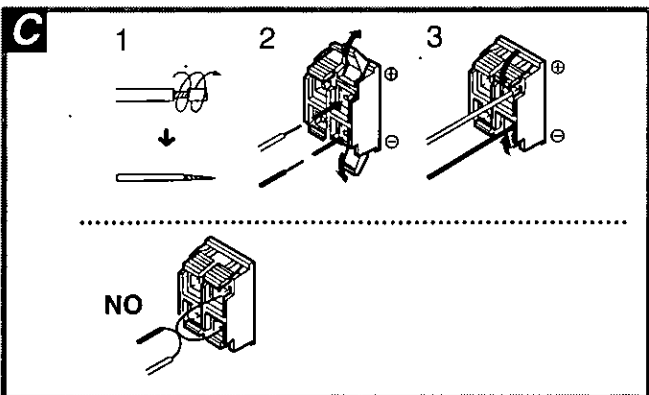
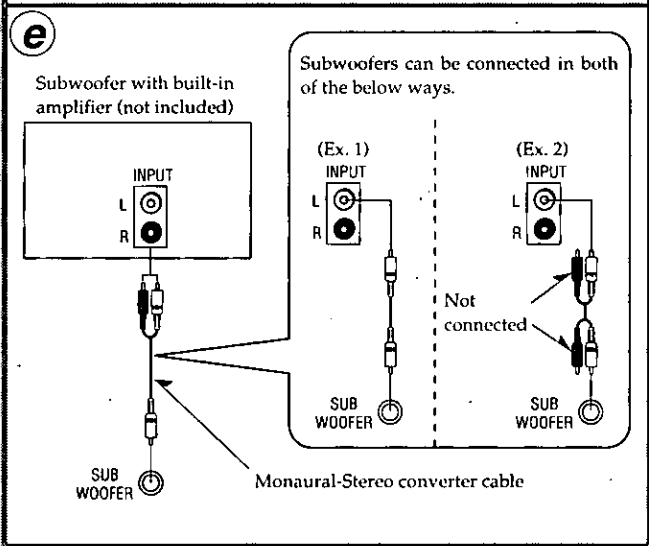
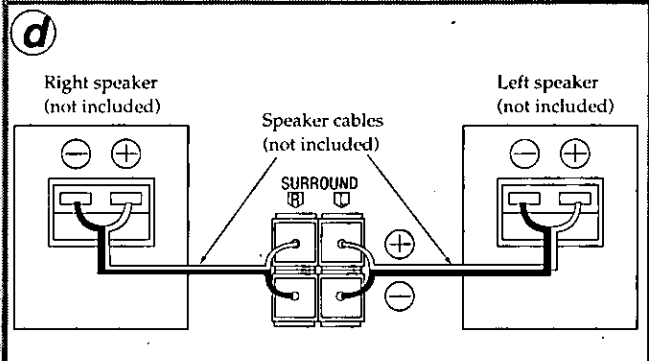
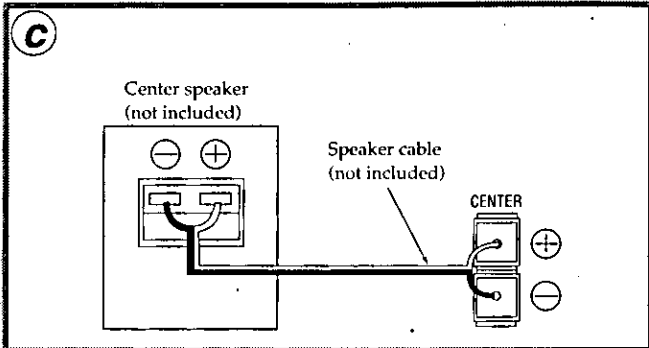

Basic operations

Before operation, set VOLUME to the "MIN" position.

- 1** Press **POWER**.
- 2** Press **A** and/or **B** to select the speaker system(s) to be used.

A and B refer to the speaker terminals at the rear of the unit.

If the button is pressed once more, the indicator will switch off and no sound will be heard from the speakers.

Caution

Before selecting your speaker system, make sure impedance is correct in the speakers you want to use. (See page 11.)

- 3** Press to select the desired source, and start the desired source.

(Refer to the appropriate operating instructions for details.)

VCR 1: To watch video tapes (VCR 1)

TV/VCR 2: To watch TV or video tapes (VCR 2)

DVD/DSS: To watch DVD or DSS

TAPE MONITOR: To listen to cassette tapes (The tape monitor indicator will appear.)
(See below.)

CD: To listen to compact discs

TUNER: To listen to radio broadcasts

PHONO: To listen to phono discs

Note

To watch a video (or DVD) or the TV, set the TV to either the TV mode or VIDEO mode as indicated below.

- To enjoy videos (or DVD)

Set it to VIDEO mode.

- To watch TV

Set it to TV mode.

- 4** Turn **VOLUME** to adjust the volume level.

After listening is finished

Be sure to reduce the volume level, and switch the power to the standby condition by pressing **POWER**.

When the tape monitor indicator is lit or flashing **A**

This indicates that the tape monitor function of this unit is ON.

To listen to sources other than a tape, be sure to press **TAPE MONITOR** and check the indicator goes out.

When using speakers with less than 8 Ω **B**

Press A or B

If even one of the speakers being used has an impedance of less than 8 Ω, press and hold down either button A or button B for 4 seconds or more to set the impedance on the main unit to LOW.

(Press and hold down once again for 4 seconds or more to turn it off.)

Note that When this indicator is illuminated, speakers A and B cannot both be used at the same time.

To change a speaker:

e.g. To use speaker B press A (the **A** indicator goes out), and then press B to activate speaker B.

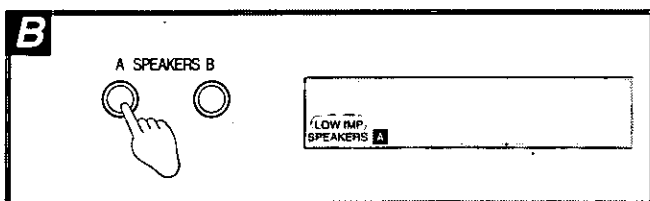
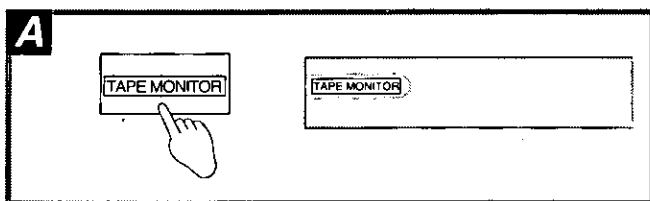
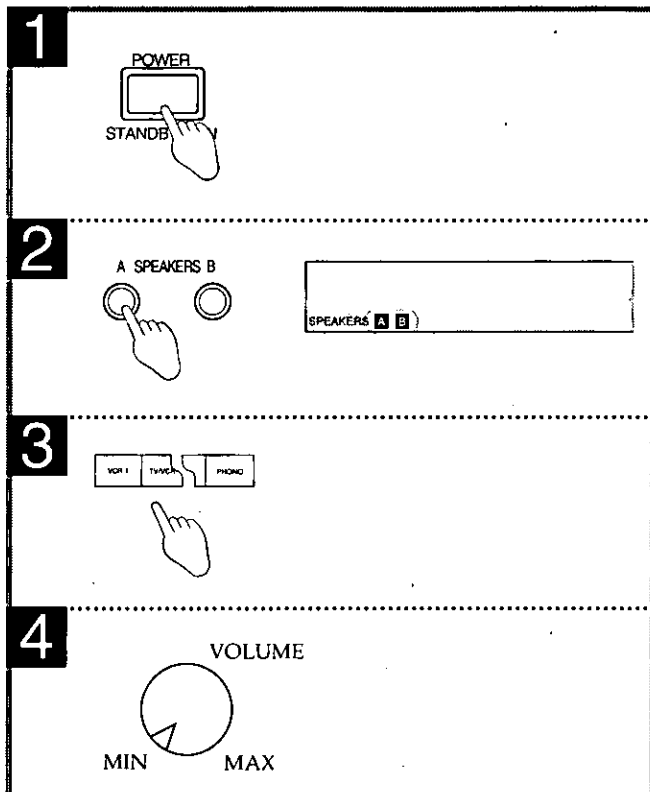
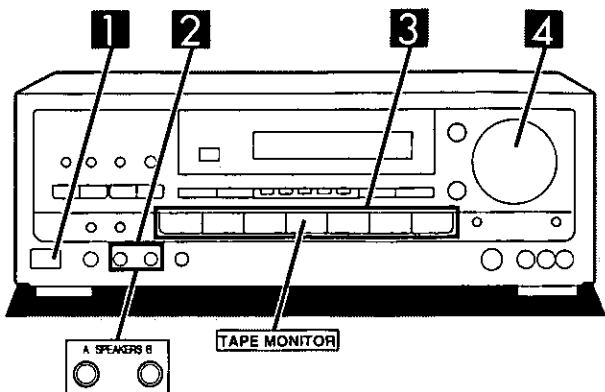

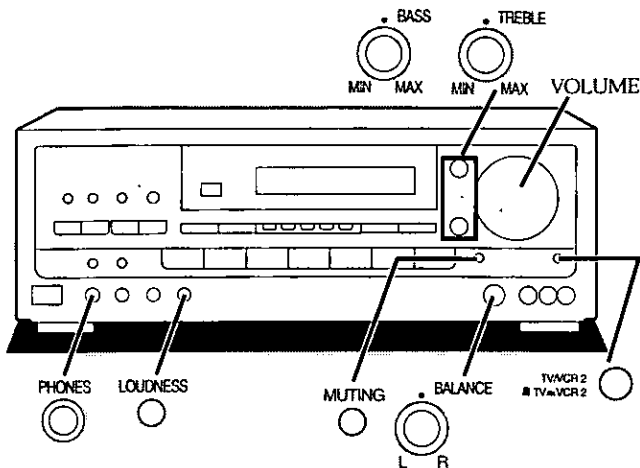

Basic operations

To adjust the tone quality A

- Ⓐ Turn **BASS** to adjust the low frequency sound.
- Ⓑ Turn **TREBLE** to adjust the high frequency sound.

To adjust the sound balance B

Turn **BALANCE** to adjust the left/right sound balance.

To mute the sound level C

Press MUTING.

The message "MUTING ON NOW" runs repeatedly from right to left across the display as long as the muting function is on.

Press once again to return to the previous volume level.

Note

When the receiver is turned off, the muting operation will be automatically cancelled.

To listen through headphones D

- ① Use **VOLUME** to reduce the volume level.
- ② **Connect the headphones.**
Plug type: 6.3 mm (1/4 in.) stereo
- ③ Use **VOLUME** to adjust the volume level.

If you do not want sound from the speakers, press **SPEAKERS** button(s) and check the speaker indicator(s) goes out. If a subwoofer is connected to your system, turn off power to it (or the subwoofer amp you are using) or lower the volume to the minimum level.

Note

Avoid listening for prolonged periods of time to prevent hearing damage.

To correct sound in case of low volume E

This button balances low volume sounds by boosting bass sound pressure.

Press LOUDNESS.

The message "LOUDNESS" will appear on the display, followed shortly thereafter by the current setting "OFF". (① - ②)
Pressing the button again within 4 seconds will turn loudness control ON. When ON, "■" indication will light up in the display. (③ - ④)

To return to the previous condition, press once again, then "■" indication turn off.

When using the VCR 2 terminals (front side) F

SA-AX910/AX810 only

This button can be used only when TV/VCR 2 is selected as the input source.

The TV/VCR 2 input select button works for both TV input and input from the source connected to the front side "VCR 2" terminals. (See page 7)

Press TV/VCR 2 (■ TV ■ VCR 2) to set to the desired position.

The display will read as follows.

- ① ■ ... "TV"
- ② ■ ... "FRT-VCR 2"

A

Ⓐ

Ⓑ

B

C

←

MUTING 0

D

①

②

③

E

① LOUDNESS

② OFF

③ ON

④

F

① TV

② FRT-VCR 2

Listening to radio broadcasts

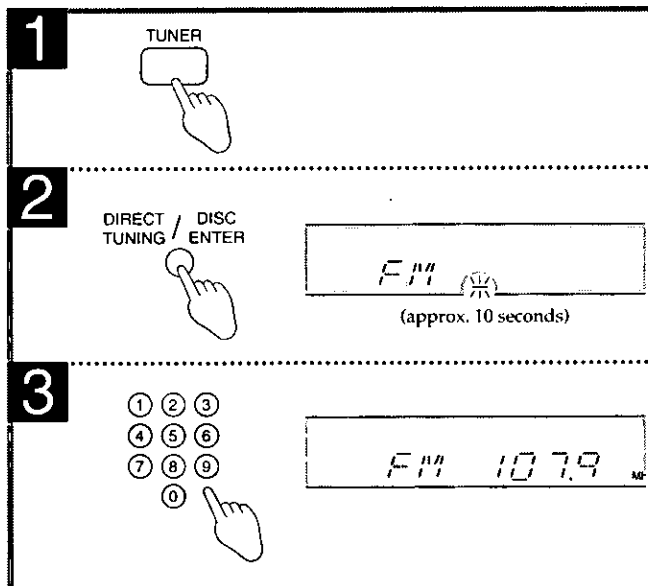
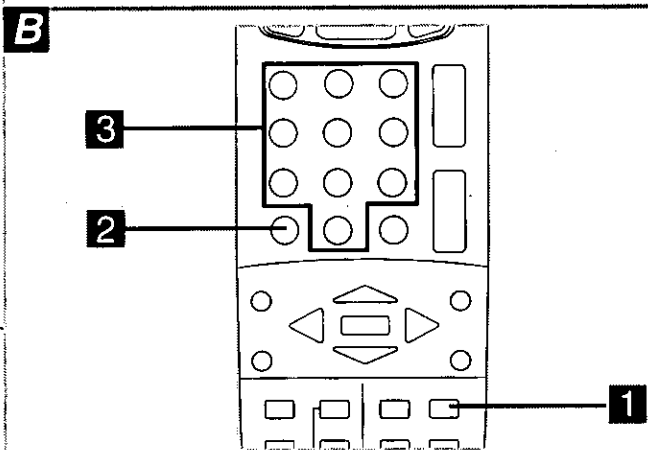
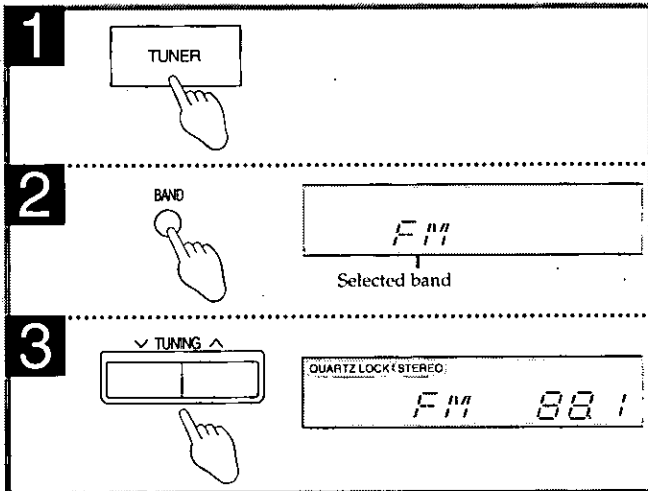
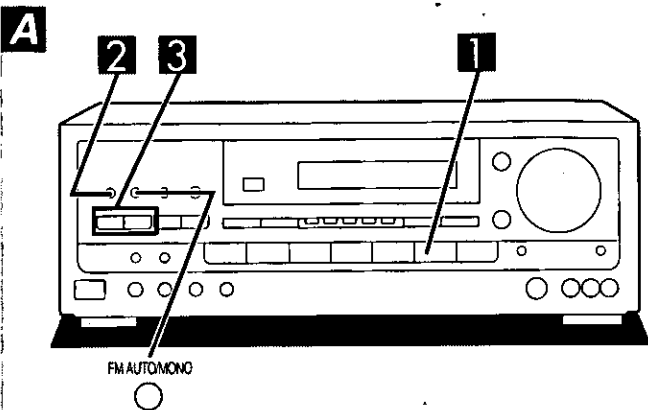

Sequential tuning

You can use the tuning buttons to tune-in radio broadcasts.

- 1** Press TUNER.
- 2** Press BAND to select "FM" or "AM".
- 3** Press TUNING (V) or (^) to tune to the desired broadcast.

Tuning intervals FM:0.2 MHz
AM:10 kHz

"QUARTZ LOCK" lights up when tuned.

"STEREO" lights up when an FM stereo broadcast is received.

To make an automatic search for broadcast stations

If TUNING (V) or (^) is held down for an instant until the frequency begins to scroll, the broadcast stations can be tuned in automatically when a broadcast station is found.

Note

Tuning may stop automatically if any jamming is encountered.

If noise is excessive in the FM stereo mode

Press FM AUTO/MONO.

(The "STEREO" indicator will go out, and the "MONO" indicator will light up.)

The broadcast will be monaural, but noise will be reduced.

If the button is pressed once more, the stereo mode will resume.

Direct tuning

(Only available from the remote control.)

Specify the frequency using the numeric buttons on the remote control transmitter to directly tune to the desired broadcast station.

First select between FM and AM with the BAND button on the receiver.

- 1** Press TUNER.
This will set the remote control to operate the tuner.
- 2** Press DIRECT TUNING/DISC ENTER.
- 3** Press the appropriate numeric buttons to enter the frequency, while cursor display is flashing.

Tuning intervals FM:0.1 MHz
AM:10 kHz

If the desired FM frequency is 107.9 MHz, press

1 → 0 → 7 → 9

If the frequency has been input correctly, the displayed frequency will flash once.

Note

1. If no button is pressed while the cursor display is flashing, the display will return to the frequency which is currently being received. To re-specify the frequency, repeat the procedure from step 2.
2. If the frequency has not been input correctly, "ERROR" indication will be displayed. In this case, re-enter the frequency.

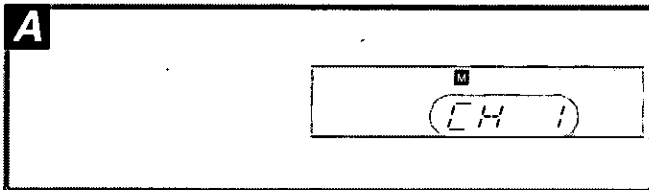
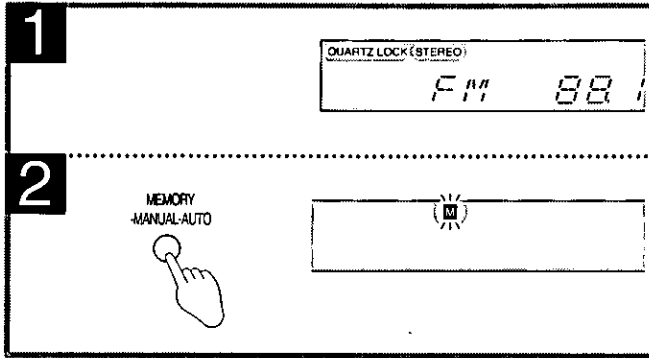
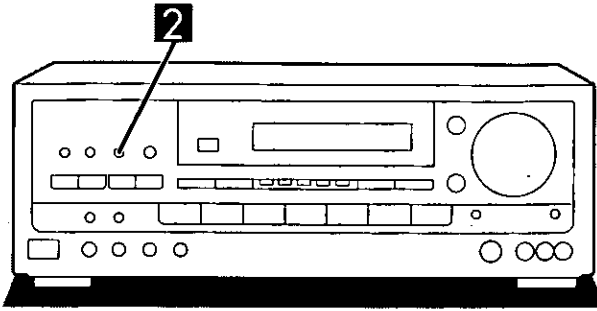

Listening to radio broadcasts

Preset tuning

Presetting radio stations into the memory channels of this unit makes selecting stations easy and simple.

A total of 30 FM and AM stations can be preset.

Please remember this

If a new broadcast station is preset into a channel, the setting for the broadcast station which was previously entered in that channel will be automatically erased.

Automatic memory presetting

Automatic memory presetting allows this unit to automatically search for broadcast stations and then preset them into memory. With this method, the following channels will be preset into the memory under the different bands (FM or AM).

When FM broadcast stations are preset,

For FM broadcast stations1-30

When FM and AM broadcast stations are preset,

For FM broadcast stations1-20

For AM broadcast stations21-30

1 Set to the frequency from which you want to start automatic memory presetting. (See page 15.)

2 Press MEMORY until the frequency begins to change.
(Automatic memory presetting will start.)

During automatic memory presetting, the memory indicator will flash while the frequency scrolls.

To stop, press MEMORY once again.

When a broadcast station is preset 

The memory indicator and the preset channel number will be displayed for approximately 1 second.

When presetting is completed

The last broadcast station to be preset will be displayed.

Note

Frequencies may not be preset correctly in cases where the broadcast waves are too strong or too weak. In such cases, carry out presetting manually. (See page 17)

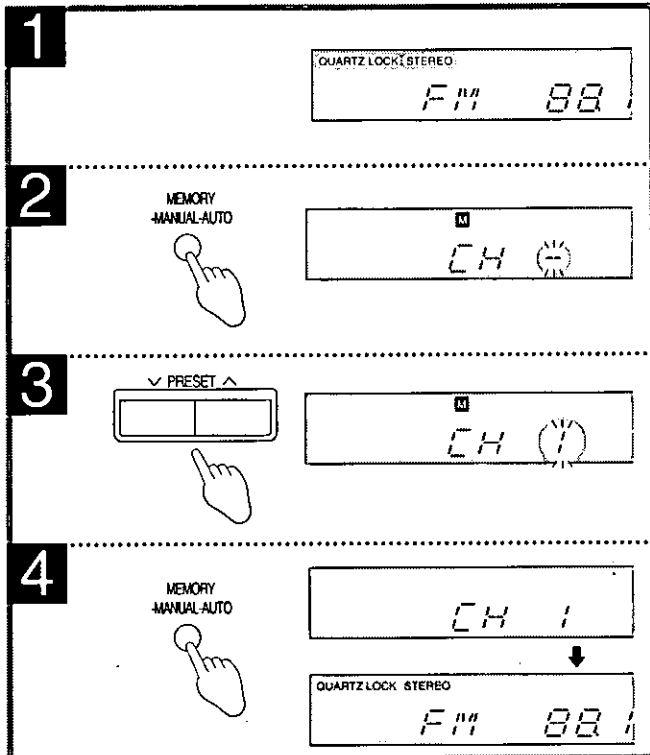
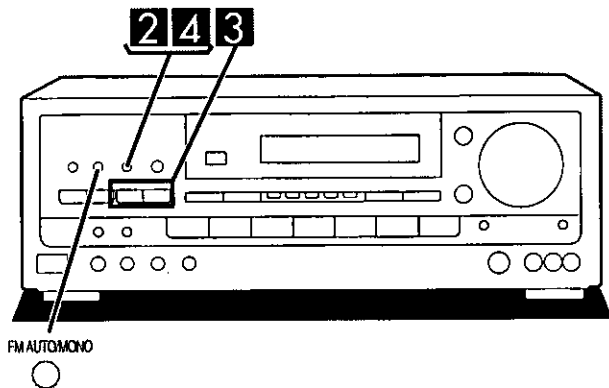
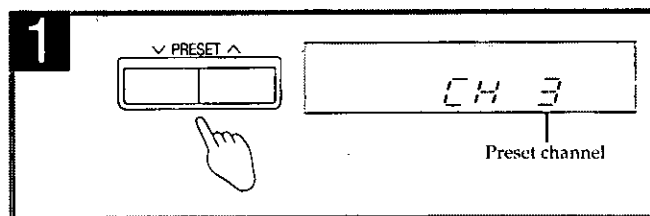
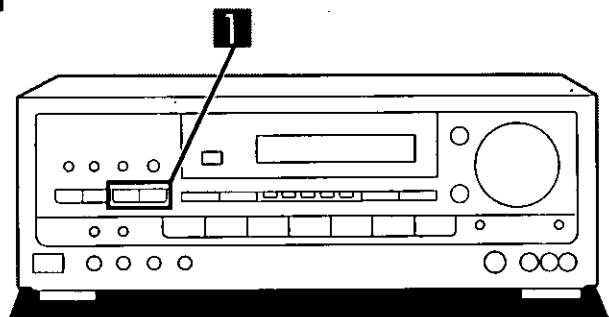
A**B****Listening to radio broadcasts****Manual memory presetting A**

The desired broadcast stations can be preset into the desired channels by the user.

- 1 Set to the desired broadcast.**
(See page 15.)

If interference or static is keeping you from enjoying an FM broadcast, press FM AUTO/MONO and change to monaural. You can preset the memory in monaural just as in stereo.

- 2 Press MEMORY.**
To cancel the memory function, press MEMORY again.
- 3 Press PRESET (∇) or (∧) to select the desired channel.**
Holding down the buttons lets you scroll through channels faster.
- 4 Press MEMORY.**
The channel will flash on the display.

To continue presetting
Repeat steps 1 through 4.

To listen to preset broadcast stations B

- 1 Press PRESET (∇) or (∧) to select the desired channel.**
Holding down the buttons lets you scroll through channels faster.

To confirm the channel number of the broadcast station being received

Press TUNER.
(The channel number will be displayed for approximately 1 second.)

Note

The channel number is not displayed if you change the reception frequency or FM mode setting.

For your reference

Even if the power is switched to standby or the power cord is disconnected from the household AC outlet, the memory will retain its contents for approximately one month.

If frequency presettings are accidentally erased

Make the presettings once again.
The power cord should remain connected for one hour or more for the memory back-up to be effective.

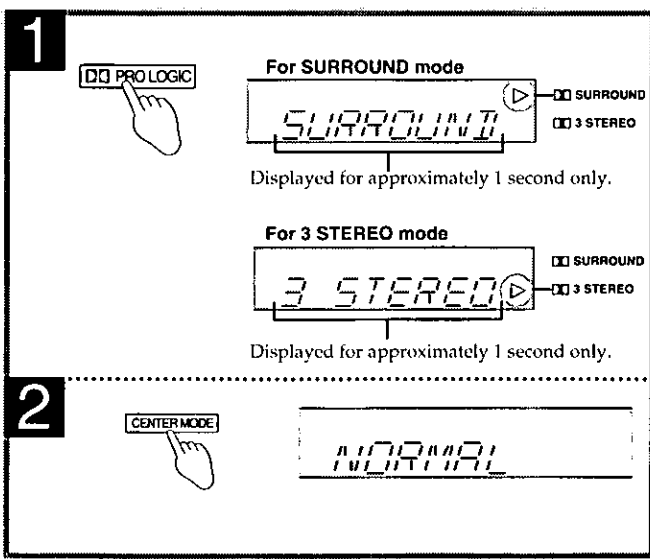
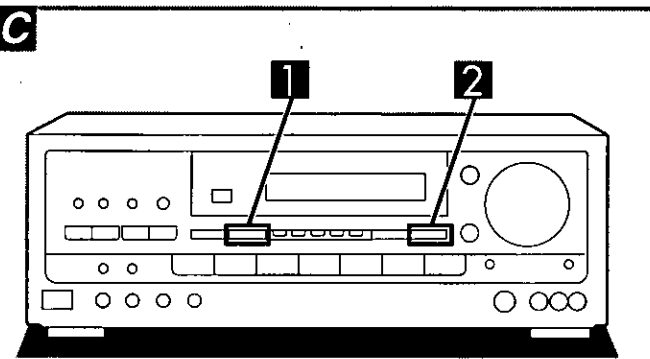
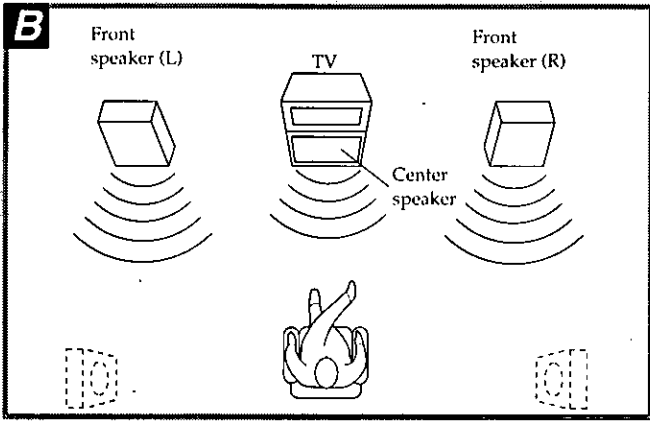
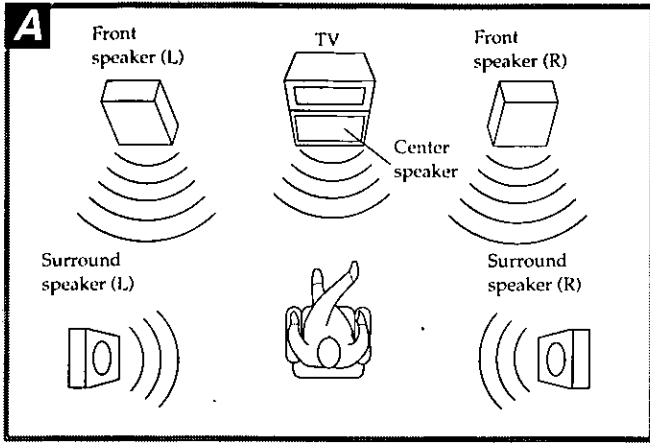

Enjoying sound with DOLBY PRO LOGIC

Dolby Pro Logic lets you enjoy movie software (video tapes and laser discs) in your own home with the same powerful stereophonic effect found in movie theaters. This unit has two Dolby Pro Logic modes: SURROUND and 3 STEREO.

SURROUND **A**

By reproducing the feeling of depth and movement of sound, video software or compact discs recorded with Dolby Surround provide the listener with a feeling of presence like that of a movie theater.

3 STEREO **B**

You can enjoy audio/video sources with clear sound, more presence and a good feeling of orientation. 3 STEREO can be used with stereo sources not encoded with DOLBY SURROUND.

Manufactured under license from Dolby Laboratories Licensing Corporation.
DOLBY, the double-D symbol **DD** and "PRO LOGIC" are trademarks of Dolby Laboratories Licensing Corporation.

Setting the center mode and adjusting speakers output level **C**

Note

- When ready to adjust speakers output level, situate yourself away from the speakers as you normally do when listening.
- First turn ON the speakers with the SPEAKERS (or SPEAKERS A or B) button on the receiver.
- If front speakers volume is unbalanced, adjust the balance with the BALANCE knob.
- You cannot adjust the output level of the subwoofer with this receiver.

1 Press **PRO LOGIC** to turn on the Dolby Pro Logic system and select the desired mode.

When the button is pressed, the current mode is displayed. Pressing it again changes the Dolby Pro Logic mode.

2 Press **CENTER MODE** to select the correct center mode.

When the button is pressed, the current center mode is displayed.

Pressing it again changes the center mode.

NORMAL

When the center speaker is smaller than the front speakers.

WIDEBAND

When the center speaker is the same size or larger than the front speakers.

PHANTOM **SURROUND only**

When no center speaker is connected.

Note

In the PHANTOM mode, the sound which would have been sent to the center speaker will be divided equally between both the left and right front speakers.

(Continued on next page)

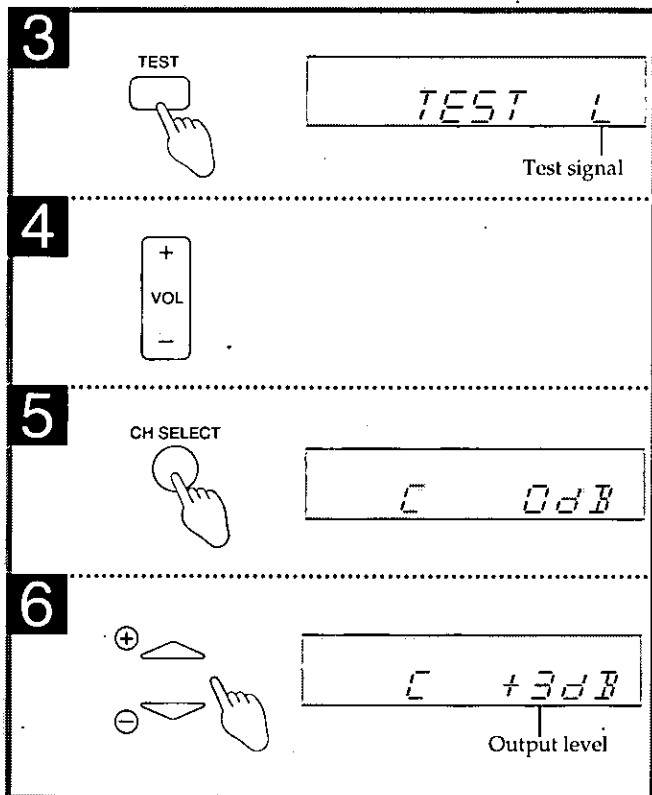
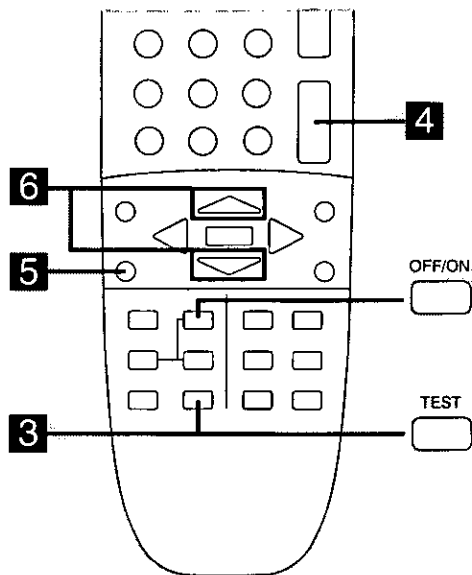

3 by remote control only

Press TEST to output a test signal.

The speaker outputting the test signal is displayed while the test is running.

- L : Front speaker (left)
- C : Center speaker
- R : Front speaker (right)
- S : Surround speakers

For SURROUND mode

L—C—R—S

For 3 STEREO mode

L—C—R

4 by remote control only

Press VOLUME (+) or (-) to set the volume level normally used for enjoying the source.

The following steps are for setting the output level of the front speakers and the center/surround speakers to the same listening level.

5 by remote control only

Press CH SELECT to select the center or surround speakers.

6 by remote control only

Press \oplus \triangle or \ominus ∇ to adjust the output level.

-: Decrease the output level.

+: Increase the output level.

Output level can be varied within a range of -12 dB to +12 dB with front speaker output level serving as the zero point.

Note

1. The test signal is output only by the speaker you are now adjusting and does not repeat the sequence until adjustments are complete.
2. Remember you cannot adjust output level of the surround speakers if you selected the 3 stereo mode in step 1.

To stop the test signal

Press TEST.

To turn off the Dolby Pro Logic systems

Press OFF/ON

Press once again to turn it on.

A

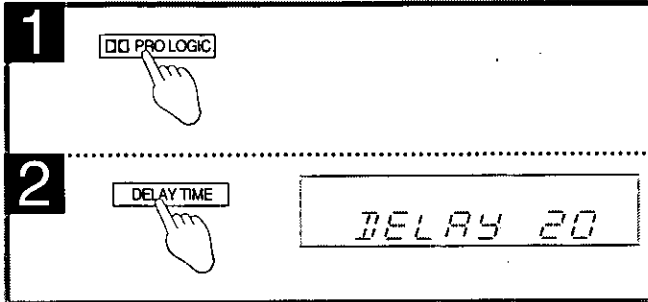
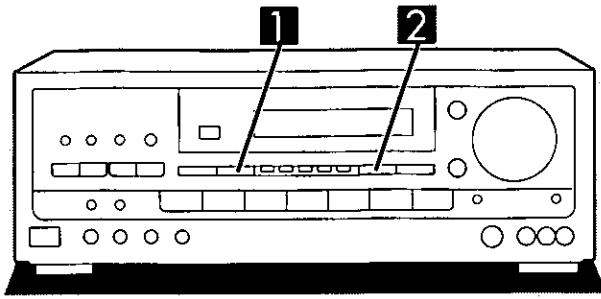

B

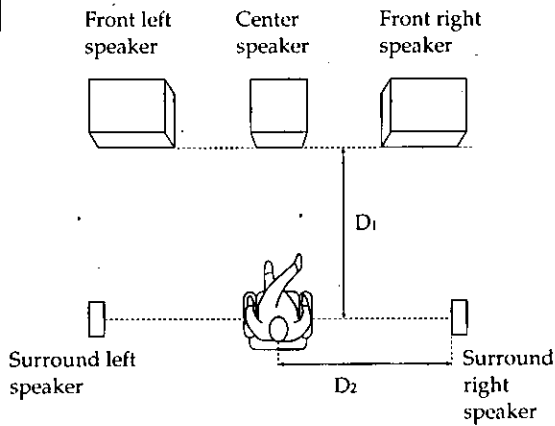

C

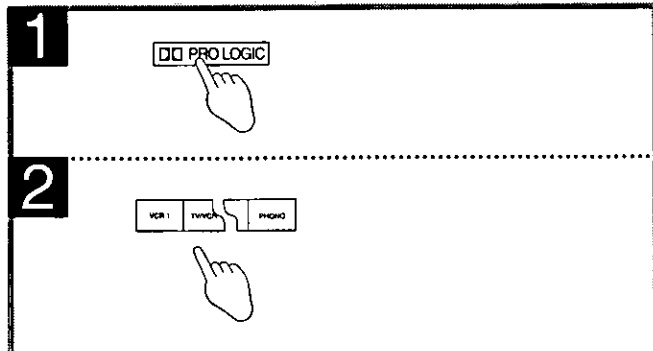
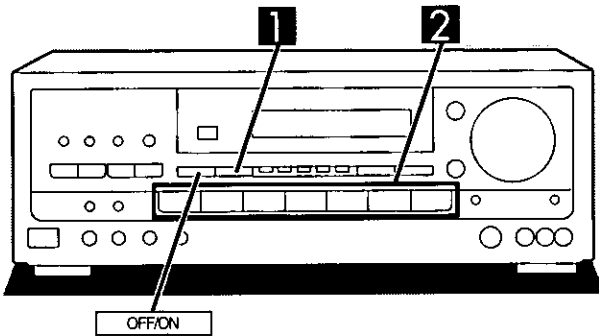

Enjoying sound with DOLBY PRO LOGIC

Adjusting the delay time

When enjoying with SURROUND only

Adjust the sound from the surround speakers until the proper effect is produced.

1 Press **PRO LOGIC** to turn on the Dolby Pro Logic system and select the SURROUND mode.

2 Press **DELAY TIME** to set to the suitable time. When the button is pressed, the current delay time is displayed. Pressing it again changes the delay time.

Each time the button is pressed, the delay time will increase by 5 ms within a range of 15 ms to 30 ms.

The standard setting is 20 ms.

To calculate the delay time

D₁: Distance from front speakers

D₂: Distance from surround speakers

• If D₁ is equal to or less than D₂

Set to 15ms.

• If D₂ is less than D₁

Start at 15ms and increase by 5 ms for every 1.5m (5 feet) of difference between D₁ and D₂.

Enjoying with SURROUND or 3 STEREO

1 Press **PRO LOGIC** to turn on the Dolby Pro Logic system and select the desired mode. When the button is pressed, the current mode is displayed. Pressing it again changes the Dolby Pro Logic mode.

2 Select the desired source and start the desired source.

Note

When employing SURROUND, use software recorded in Dolby Surround.

To turn off the Dolby Pro Logic systems

Press OFF/ON.

Enjoying sound with SFC

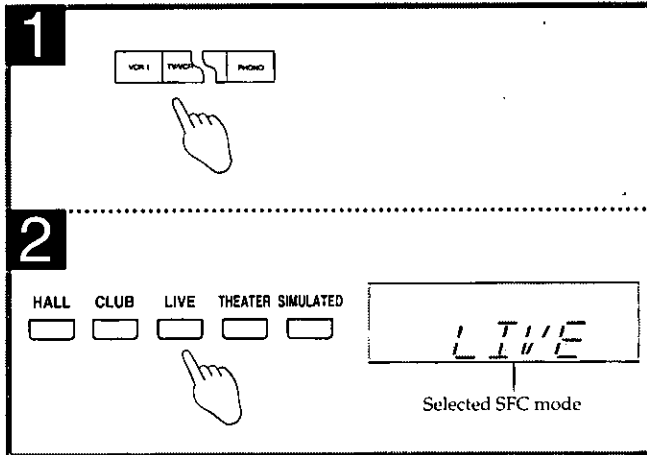
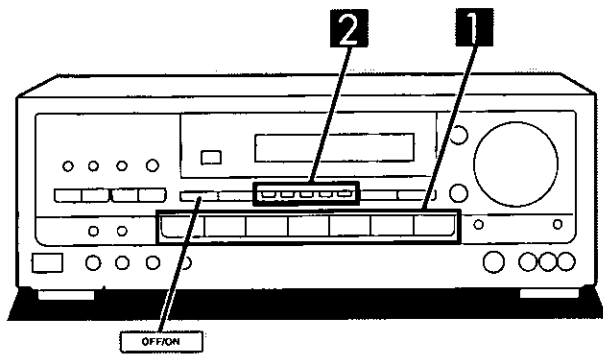

SFC is the abbreviation of Sound Field Control.

The SFC function gives presence and spread thereby enhancing and enriching the music or movie.

Read the following explanations in order to better understand how to make your selection.

HALL

This mode imparts a reflection and spread which will make you feel as if you are in a large concert hall.

CLUB

Like a jazz club, this mode provides an exciting and intimate atmosphere. It simulates the sound field of a relatively small room having a low ceiling and hard reflective surfaces, for a "live" sound with enhanced presence to bring the performers up close.

LIVE

Primarily for vocal pieces, this mode adds gloss to the vocals and you'll feel as though you were hearing a live stage performance.

THEATER

You can clearly perceive the directions and source of the movie. Real ambience of sound can also be recreated naturally using this mode.

THEATER mode can be used with stereo sources not encoded with DOLBY SURROUND.

Note

When using Dolby Surround encoded materials, select the DOLBY PRO LOGIC SURROUND.

SIMULATED

Choose this mode if little or no sound will be heard from the surround speakers.

You can feel as if you were in a more expanded space adding to the actual sound from the source.

This mode also adds effect to monaural sources by outputting the sound from surround speakers.

Note

You can adjust center speaker volume only in the theater mode. The center speaker is not used in the hall, and simulated modes.

1 Select the desired source and start the desired source.

2 Select the desired SFC mode.

To turn off the SFC function

Press OFF/ON.

Press once again to turn it on.

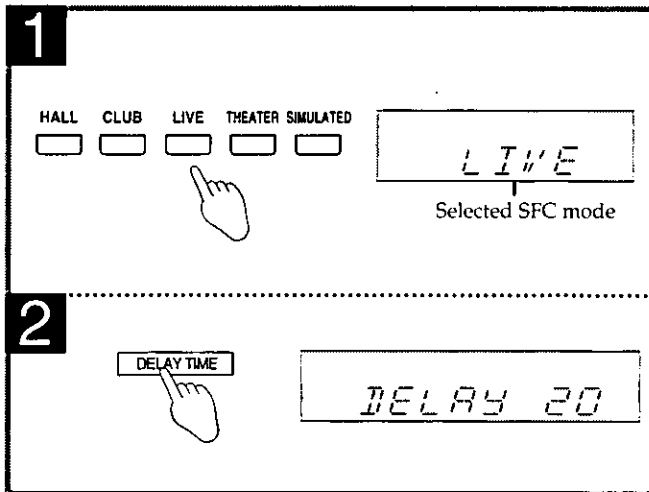
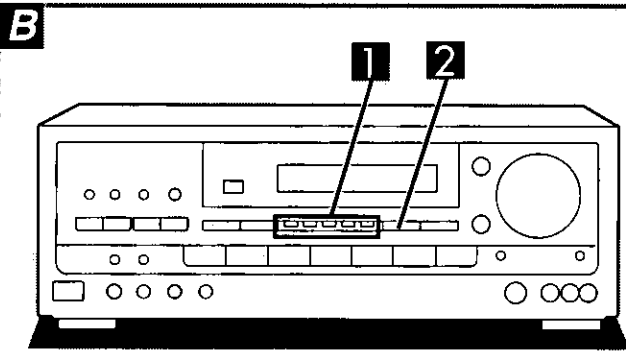
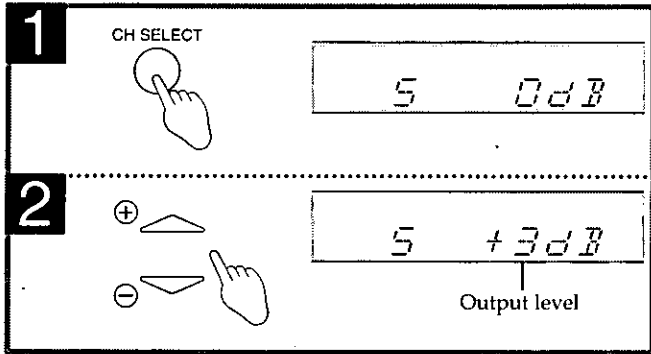
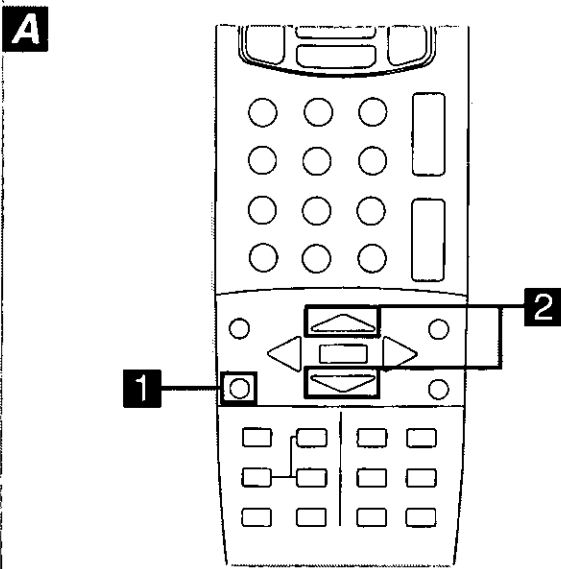

Enjoying sound with SFC

Adjusting field of sound

With this unit, you can adjust speaker volume. Adjust the field of sound while listening to a source.

To adjust center and surround speakers volume **A**

(Only available from the remote control.)

Note

Center speaker volume can be adjusted only in the THEATER mode.

1 Press CH SELECT to select the center or surround speakers.

2 Press \oplus \triangle or \ominus ∇ to adjust the output level.

To adjust the delay time **B**

1 Select the desired SFC mode.

2 Press DELAY TIME to set to the suitable time. When the button is pressed, the current delay time is displayed. Pressing it again changes the delay time.

Each time the button is pressed, the delay time will change.

The delay time increments are different depending on the SFC mode.

Select a delay time setting to accommodate to your individual needs.

SFC modes	Available delay time setting (ms)
HALL	40, 50, 20, 25, 30
CLUB	15, 20, 25, 30, 0
LIVE	50, 15, 20, 30, 40
THEATER	20, 25, 30, 40, 15
SIMULATED	15, 20, 25, 30, 40

Enjoying sound with 6 channel discrete

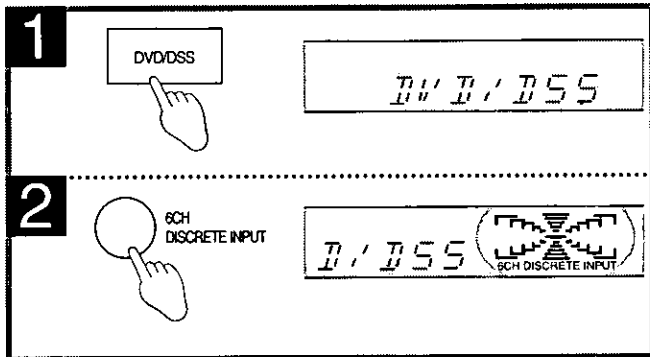
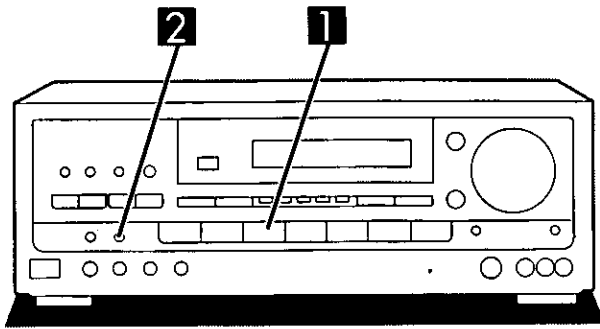

This receiver can playback 6 channel discrete sound.

It has jacks for connecting to components with 6 channel discrete output, such as a DVD player.

6 channel discrete output makes playback sound more real by adding depth, movement, position and other characteristics to the field of sound.

It will make you feel as if you were at the movie theater when in your own home.

To enjoy 6 channel discrete output sound

Of course, you have to connect a DVD player or other component that has 6 channel discrete output capabilities.

1 Press DVD/DSS

2 Press 6CH DISCRETE INPUT

If you press this button while another source (CD, PHONO, etc.) is selected, the receiver switches the source to DVD/DSS and engages the 6CH DISCRETE INPUT mode.

3 Start the desired source.

Follow your equipment's operating instructions.

To adjust sound balance

When in the 6CH DISCRETE INPUT mode, you can adjust the sound balance coming from the center and surround speakers, from the input level controls on the rear panel. (See page 8.)

Note

You cannot select Dolby Pro Logic or any of the SFC modes while in the 6CH DISCRETE INPUT mode. If you try, the message "NOT POSSIBLE IN 6CH DISCRETE INPUT" will appear on the display.

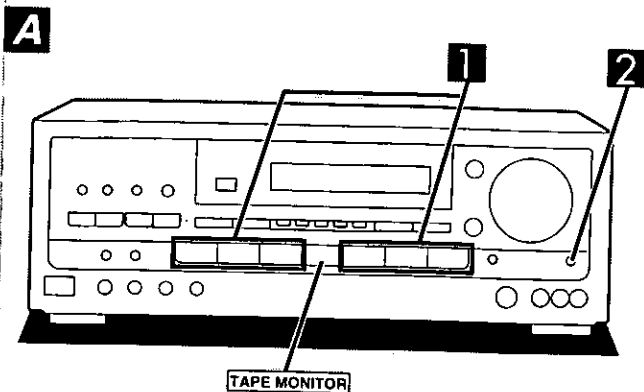

1

2 **SA-AX910/AX810 only**

TV/VCR 2

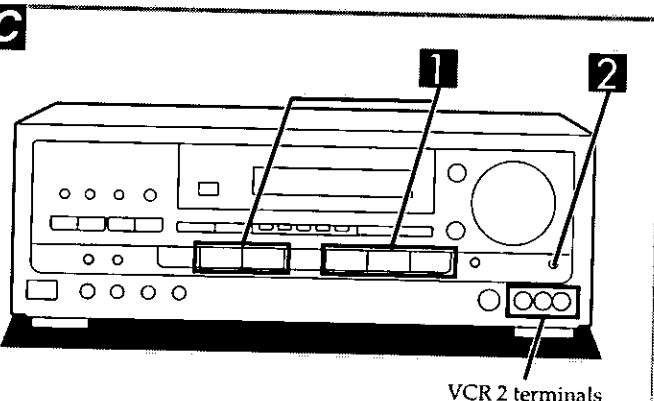
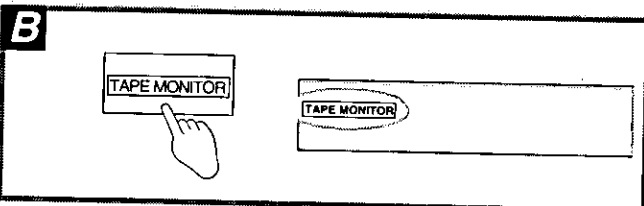

1

2 **SA-AX910/AX810 only**

TV/VCR 2

Making a recording

Note

When you select 6CH DISCRETE INPUT mode, only sound from the front left and right speakers is recorded. To record all 6 channels, switch to a 2 channel output mode. For details, see the instruction manual that came with the connected equipment.

Recording on the tape deck

Before recording, prepare the tape deck for recording (recording level adjustment, etc.). See the tape deck's operating instructions for details.

- 1** **Select the desired source to be recorded.**
Press any button except **TAPE MONITOR** to select the source you want to record from.
- 2** **SA-AX910/AX810 only**
(only if you press TV/VCR 2 in the above step)
Set TV/VCR 2 (TV VCR 2) to " TV" or " VCR 2" position.
- 3** **Begin recording.**
Follow your tape deck's operating instructions.

To check the sound recorded while a recording is being made

With a tape deck with 3 head system, it is possible to check the sound recorded on the tape.

Press **TAPE MONITOR** on this unit and set the monitor button on the tape deck to "TAPE".

Press **TAPE MONITOR** once again to turn it off.

Recording on the VCR

Before recording, prepare the VCR (VCR 1) for recording (recording level adjustment, input selector setting, etc.). See the VCR's operating instructions for details.

- 1** **Select the desired source to be recorded.**
Press any button except VCR 1 and **TAPE MONITOR** to select the source you want to record from.
- 2** **SA-AX910/AX810 only**
(only if you press TV/VCR 2 in the above step)
Set TV/VCR 2 (TV VCR 2) to " TV" or " VCR 2" position.
- 3** **Begin recording on the VCR 1.**
Follow your VCR's operating instructions.
- 4** **Begin the desired source to be recorded.**
Follow your equipment's operating instructions.

For your reference

There are VCR 2 terminals at the front of this unit. It is easier to carry out dubbing from a camcorder if it is connected to the front terminals.

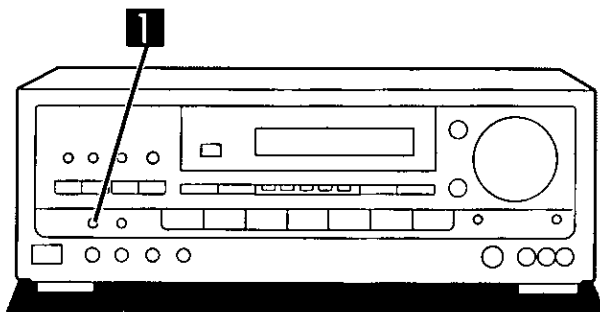

The sleep timer is an excellent little feature that lets you fall asleep with the radio on or while listening to another source. You can set the timer to turn off after 30, 60 or 90 minutes. External sources are turned off at the same time the receiver turns off provided their power cords are plugged into the socket on the receiver.

- 1** (While listening to a source)
Press SLEEP and set how long (minutes) you want the source to continue playing.

Each time the button is pressed, the indicator will change in the order: 30 -- 60 -- 90 -- OFF

The display returns to the way it was before in about 5 seconds, and the "SLEEP" indicator will appear on the display.

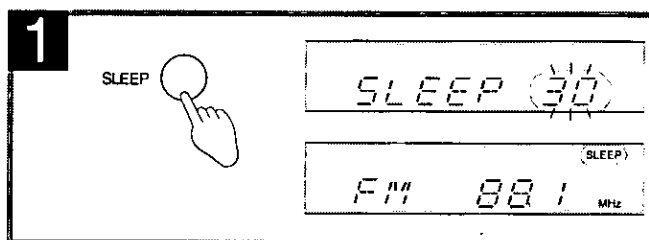

To cancel the sleep timer

Press SLEEP until "OFF" is displayed. The "SLEEP" indicator will go out.

To check how much time is left (while the timer is running).
 Press SLEEP once.

Note

Do not press SLEEP again before the remaining time indication goes out.

If you do so, the timer will return to the setting mode.

To change the setting time (while the timer is running)

1. Press SLEEP
2. Press SLEEP again while the remaining time is displayed and then reset the timer (30, 60 or 90 minutes).

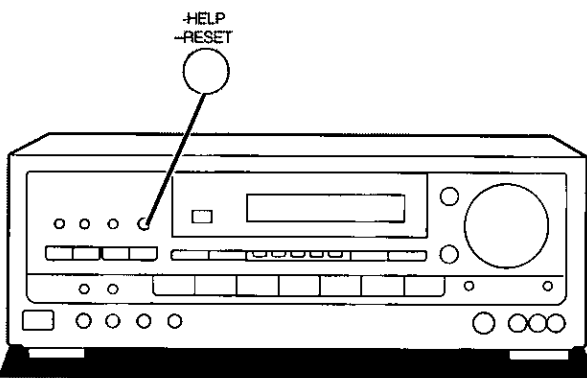

About the HELP function

If you make a mistake in operation or if sound output stops due to some operation which was performed, the HELP function displays information which can be useful for indicating the method by which this condition can be remedied.

If "ERROR" or scrolling characters (for instance, "TAPE MONITOR ON NOW") appears on the display during operation, carry out the following operation.

Press -HELP.

(Touch only.)

The method for remedying this situation will be displayed.

For your reference

If the above button is pressed for 2 second or more until "RESET" appears on the display, the operation settings for the unit will be initialized to the settings made at the time of shipment.

However, any broadcasting stations which have been preset into memory will not be erased at this time.

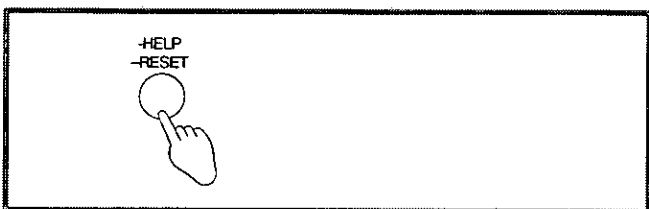

The On-Screen Display function can provide a wide range of information on a TV screen making the operation even easier. For example, by using the receiver button(s), the state of setting will display. If there is no sound and you do not understand the operation, press the HELP button to use the unit diagram displayed on the TV to display the applicable method.

Refer to the included supplemental instruction manual for details on the On-Screen Display function.



Selecting fine audio equipment such as the unit you've just purchased is only the start of your musical enjoyment. Now it's time to consider how you can maximize the fun and excitement your equipment offers. This manufacturer and the Electronic Industries Association's Consumer Electronics Group want you to get the most out of your equipment by playing it at a safe level. One that lets the sound come through loud and clear without annoying blaring or distortion—and, most importantly, without affecting your sensitive hearing.

We recommend you to avoid prolonged exposure to excessive noise.

Sound can be deceiving. Over time your hearing "comfort level" adapts to higher volumes of sound. So what sounds "normal" can actually be loud and harmful to your hearing.

Guard against this by setting your equipment at a safe level BEFORE your hearing adapts.

To establish a safe level:

- Start your volume control at a low setting.
- Slowly increase the sound until you can hear it comfortably and clearly, and without distortion.

Once you have established a comfortable sound level:

- Set the dial and leave it there.

Taking a minute to do this now will help to prevent hearing damage or loss in the future. After all, we want you listening for a lifetime.

Product service

Do not attempt to remove the cover(s) or repair the unit yourself.

Refer servicing to qualified personnel only.

Product information

For product service, product information or assistance in product operation, refer to the servicenter directory.

Troubleshooting guide

Before requesting service for this unit, check the chart below for a possible cause of the problem you are experiencing. Some simple checks or a minor adjustment on your part may eliminate the problem and restore proper operation.

If you are in doubt about some of the check points, or if the remedies indicated in the chart do not solve the problem, refer to the directory of Authorized Service Centers (enclosed with this unit) to locate a convenient service center, or consult your Technics dealer for instructions.

(In U.S.A. consult PASC Authorized Servicers for detailed instructions or call 1-800-545-2672 for the address of an authorized factory servicenter.)

Reference pages indicated in black circles.

Problem	Probable cause(s)	Suggested remedy
While listening to FM broadcasts		
An unusual hissing noise is heard when listening to the broadcast in stereo, but not heard when listening monaurally.	A slight noise may be heard because the method used for modulation of FM stereo broadcasts is different from that used for monaural broadcasts.	<ul style="list-style-type: none"> • Try reducing the treble sound by using the treble control. (12) • Try changing the location, height and/or direction of the antenna. (9 10) • If an indoor antenna is being used, change to an outdoor antenna. (10) • Try using an antenna with more elements.
Noise is excessive in both stereo and monaural broadcasts.	Poor location and/or direction of the antenna.	<ul style="list-style-type: none"> • Try changing the location, height and/or direction of the antenna. (9 10) • If an indoor antenna is being used, change to an outdoor antenna. (10) • Try using an antenna with more elements.
	Transmitting station is too far away.	
The FM stereo indicator or the quartz lock indicator flickers, without completely illuminating.	Poor location and/or direction of the antenna.	<ul style="list-style-type: none"> • Try changing the location, height and/or direction of the antenna. (9 10) • If an indoor antenna is being used, change to an outdoor antenna. (10) • Try using an antenna with more elements.
	Transmitting station is too far away.	
Excessive distortion in the sound of stereo broadcasts.	Nearby building or mountain.	<ul style="list-style-type: none"> • Try using an antenna with more elements.

While listening to AM broadcasts		
An unusual "beat" sound is heard.	The unit is being used at the same time as the television set.	<ul style="list-style-type: none"> • Turn off the television set, or use this unit farther away from it.
	Interference from adjacent broadcast signal.	<ul style="list-style-type: none"> • Try reducing the treble sound by using the treble control. (14)
A low-pitched "hum" sound is heard when the broadcast is tuned.	The AM loop antenna connection wires are too close to the power cord.	<ul style="list-style-type: none"> • Place the antenna connection wires and the power cord farther apart.
	The power supply frequency from the power cord is modulated and heard from the speakers.	<ul style="list-style-type: none"> • Install a special outdoor antenna. (10)
A strange hissing noise is produced continuously or intermittently.	Caused by the "discharge phenomenon" and the "oscillation phenomenon" of electric appliances (such as fluorescent lights, TV, small series-type motors, rectification equipment, etc.).	<ul style="list-style-type: none"> • Try placing this unit farther away from such equipment.

Problems noted at all times		
Power will not switch ON.	The power cord plug is not completely inserted.	<ul style="list-style-type: none"> • Confirm that the power cord plug is connected completely.
No sound is heard.	The speaker indicator(s) is(are) turned off.	<ul style="list-style-type: none"> • Turn on the speaker indicator(s). (15)
	The tape monitor function is ON.	<ul style="list-style-type: none"> • Press the tape monitor button. (13)
	The muting function is ON.	<ul style="list-style-type: none"> • Press the muting button. (14)
	Connections are incomplete or incorrect to the speaker systems, etc.	<ul style="list-style-type: none"> • Check to be sure that all connection wires are correctly connected. (11 12)
Sound stops during a performance, or no sound is heard when the power is switched ON. (The word "OVERLOAD" appears on the display.)	The incorrect input selector has been pressed.	<ul style="list-style-type: none"> • Check to be sure that the correct selector is pressed. (15)
	The protection circuitry has functioned because the positive and negative speaker connection wires are "shorted," speaker systems with an impedance less than the indicated rated impedance of this unit are used or under severe use, such as loud volume, excessive power and in an excessively hot environment.	<ul style="list-style-type: none"> • Switch off the power, and after determining and correcting the cause, switch on the power once again. • Use a speaker system of the proper impedance rating. (11)

■ **AMPLIFIER SECTION**

Rated minimum sine wave
RMS power output
 20 Hz-20 kHz both channels driven
 0.05% total harmonic distortion
 120 W per channel (8 Ω)

1 kHz continuous power output
 both channels driven
 0.05% total harmonic distortion 125 W per channel (8 Ω)
Total harmonic distortion
 rated power at 20 Hz-20 kHz 0.05% (8 Ω)
 half power at 1 kHz 0.03% (8 Ω)

Power output at the Dolby Pro Logic operation
 0.9% at 1 kHz,
 Front 2×100 W (8 Ω)
 Center 100 W (8 Ω)
 Surround 2×100 W (8 Ω)

Low frequency damping factor
 30 (8 Ω)

Load impedance
 Front
 A or B 4-8 Ω
 A and B 8 Ω
 Center 8 Ω
 Surround 8 Ω

Dynamic headroom 2 dB (8 Ω)
SMPTE intermodulation distortion 0.3%

Frequency response
 PHONO RIAA standard curve ±0.8 dB
 CD, TAPE, TV/VCR 2, VCR 1, DVD/DSS 7 Hz-70 kHz, ±3 dB

input sensitivity
 PHONO 0.4 mV (3 mV, IHF' 66)
 CD, TAPE, TV/VCR 2, VCR 1, DVD/DSS 27 mV (200 mV, IHF' 66)

S/N (IHF A)
 PHONO 70 dB (80 dB, IHF' 66)
 CD, TAPE, TV/VCR 2, VCR 1, DVD/DSS 75 dB (85 dB, IHF' 66)

Input impedance
 PHONO 47 kΩ
 CD, TAPE, TV/VCR 2, VCR 1, DVD/DSS 22 kΩ

Tone controls
 BASS 50 Hz, +10 to -10 dB
 TREBLE 20 kHz, +10 to -10 dB

Loudness control (volume at -30dB) 50 Hz, +9 dB
Subwoofer frequency response 7 Hz -100 Hz, ±3dB

■ **FM TUNER SECTION**

Frequency range 87.9-107.9 MHz
Sensitivity 11.2 dBf (2μV, IHF' 58)
50 dB quieting sensitivity
 MONO 18.3 dBf (4.5 μV, IHF' 58)
 STEREO 38.3 dBf (45 μV, IHF' 58)

Total harmonic distortion
 MONO 0.2%
 STEREO 0.3%

S/N
 MONO 75 dB
 STEREO 70 dB

Frequency response 20 Hz-15 kHz, +1 dB, -2 dB
Alternate channel selectivity 65 dB
Capture ratio 1 dB
Image rejection at 98 MHz 44 dB
IF rejection at 98 MHz 80 dB
Spurious response rejection at 98 MHz 75 dB
AM suppression 50 dB
Stereo separation
 1 kHz 40 dB
 10 kHz 30 dB

Carrier leak
 19 kHz -35 dB
 38 kHz -50 dB

Antenna terminal 75 Ω (unbalanced)

■ **AM TUNER SECTION**

Frequency range 530-1710 kHz
Sensitivity 20 μV, 330 μV/m
Selectivity 55 dB
Image rejection at 1000 kHz 40 dB
IF rejection at 1000 kHz 60 dB

■ **VIDEO SECTION**

Output voltage at 1 V input (unbalanced) 1±0.1 V_{p-p}
Maximum input voltage 1.5 V_{p-p}
Input/output impedance 75 Ω

■ **GENERAL**

Power supply AC 120 V, 60 Hz
Power consumption 290 W
 (In standby condition: 2W)
Dimensions (W×H×D) 430×158×312 mm
 (16-15/16"×6-7/32"×12-9/32")
Weight 9.5 kg (20.9 lb.)

Notes:

- Specifications are subject to change without notice.
Weight and dimensions are approximate.
- Total harmonic distortion is measured by the digital spectrum analyzer.

Free Manuals Download Website

<http://myh66.com>

<http://usermanuals.us>

<http://www.somanuals.com>

<http://www.4manuals.cc>

<http://www.manual-lib.com>

<http://www.404manual.com>

<http://www.luxmanual.com>

<http://aubethermostatmanual.com>

Golf course search by state

<http://golfingnear.com>

Email search by domain

<http://emailbydomain.com>

Auto manuals search

<http://auto.somanuals.com>

TV manuals search

<http://tv.somanuals.com>