

# Technics®

## AV Control Stereo Receiver

Operating Instructions

Model No. **SA-DX940**

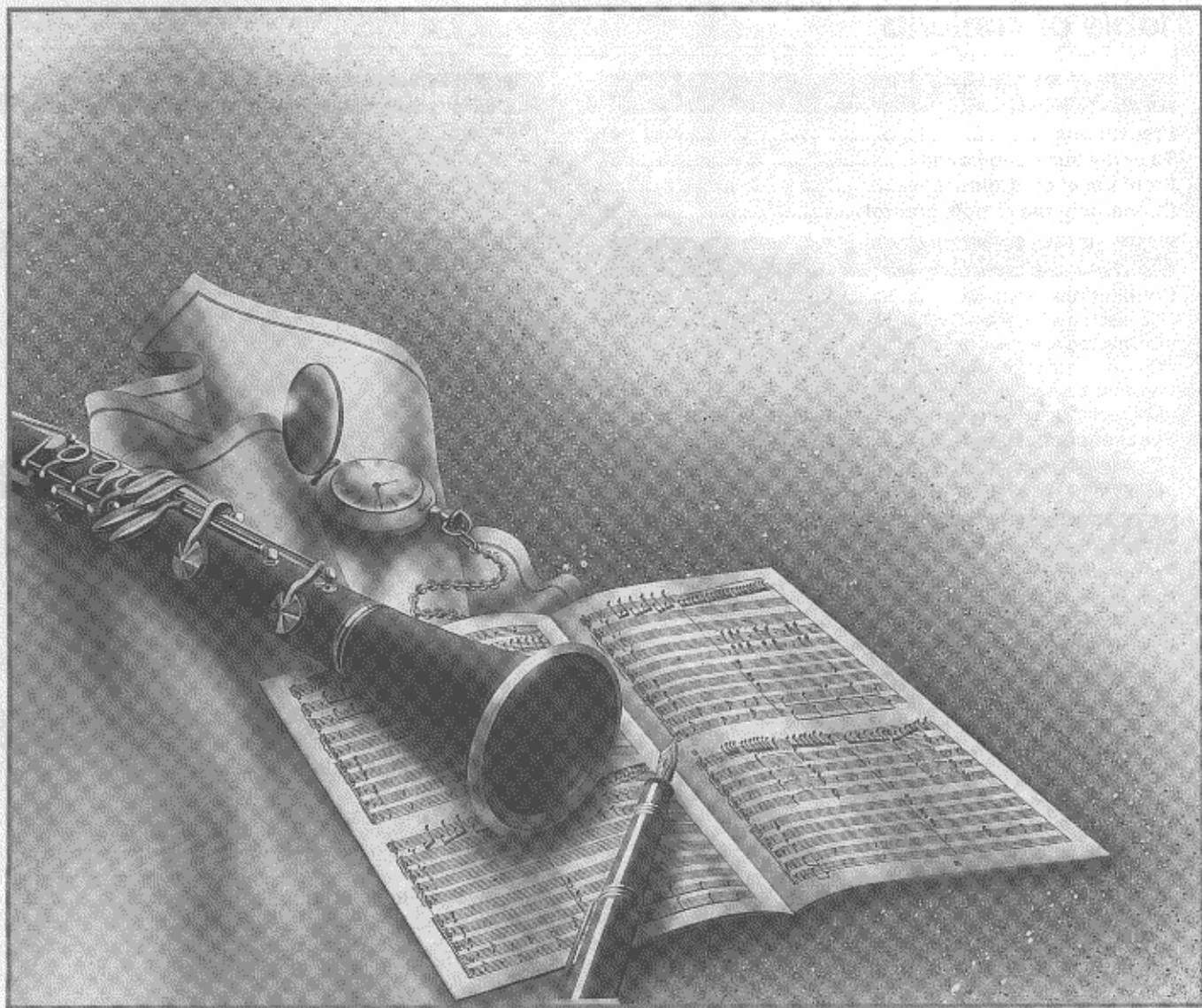
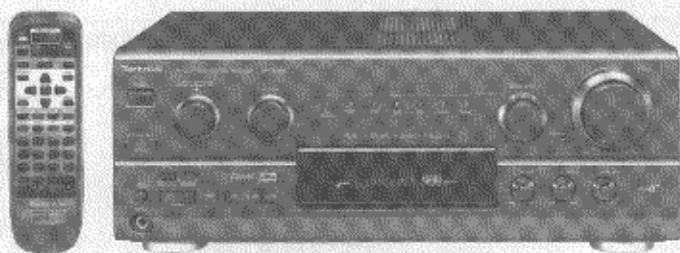

Before connecting, operating or adjusting this product, please read these instructions completely.  
Please keep this manual for future reference.

## Dear customer

Thank you for purchasing this product.

For optimum performance and safety, please read these instructions carefully.

User memo:

DATE OF PURCHASE	_____
DEALER NAME	_____
DEALER ADDRESS	_____
TELEPHONE NUMBER	_____

The model number and serial number of this product can be found on either the back or the bottom of the unit.

Please note them in the space provided below and keep for future reference.

MODEL NUMBER	SA-DX940
SERIAL NUMBER	_____

## Table of contents

<b>Before use</b>		<b>Radio functions</b>	
Precautions .....	4	The radio .....	26
To enjoy surround sound .....	5	Sequential tuning .....	26
Front panel controls .....	6	Direct tuning .....	27
Concerning the remote control .....	9	Preset tuning .....	28
<b>Connections</b>		<b>Others</b>	
Connections .....	10	Other functions .....	30
Connecting a TV and a DVD player .....	10	To mute the sound level .....	30
Connecting audio equipment .....	11	To listen through headphones .....	30
Connecting video equipment .....	11	Dynamic range compression .....	30
Antenna connections .....	12	<b>Making a recording</b> .....	31
Connecting the AC power supply cord and other information ..	13	Recording on a tape deck .....	31
<b>Speaker connections</b> .....	14	Recording on a VCR .....	31
Placement of speakers .....	14	<b>Remote control</b>	
Connecting speakers .....	14	The remote control .....	32
<b>Preparation</b>		To operate the receiver .....	32
Preparatory steps .....	16	To operate a cassette deck .....	33
Speaker settings .....	16	To operate a CD player .....	34
The speaker indicators .....	18	To watch TV broadcasts .....	35
Adjusting speaker output level .....	19	To watch video tapes .....	36
<b>Operations</b>		To operate a DVD player .....	37
Digital Signal Processor (DSP) .....	20	Changing the remote control code .....	38
Enjoying the sounds .....	22	<b>Reference</b>	
To adjust the tone quality .....	24	About the HELP function .....	39
To adjust the sound balance .....	24	Listening caution .....	40
Turning the subwoofer off .....	24	Maintenance .....	40
		Product Service .....	40
		Specifications .....	41
		Troubleshooting guide .....	42
		Servicenter List (US) .....	Back cover

## Supplied accessories

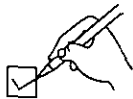

Please check and identify the supplied accessories.

- AC power supply cord ..... 1 pc.

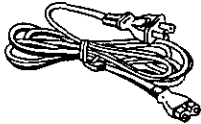

(RJA0065-A)

- AM loop antenna set
- AM loop antenna ..... 1 pc.
  - AM loop antenna holder ..... 1 pc.
  - Screw ..... 1 pc.

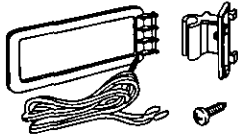

(RSA0012)

- FM indoor antenna ..... 1 pc.



(RSA0006)

- Batteries ..... 2 pcs.

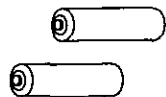

- Remote control ..... 1 pc.



(EUR647132)

Use numbers indicated in parentheses when asking for replacement parts.

(Only for U.S.A.)

To order accessories contact 1-800-332-5368 or web site (<http://www.panasonic.com>).

— THE FOLLOWING APPLIES ONLY IN THE U.S.A. —

### CAUTION:

This equipment has been tested and found to comply with the limits for a Class B digital device, pursuant to Part 15 of the FCC Rules.

These limits are designed to provide reasonable protection against harmful interference in a residential installation. This equipment generates, uses and can radiate radio frequency energy and, if not installed and used in accordance with the instructions, may cause harmful interference to radio communications. However, there is no guarantee that interference will not occur in a particular installation. If this equipment does cause harmful interference to radio or television reception, which can be determined by turning the equipment off and on, the user is encouraged to try to correct the interference by one of the following measures:

- Reorient or relocate the receiving antenna.
- Increase the separation between the equipment and receiver.
- Connect the equipment into an outlet on a circuit different from that to which the receiver is connected.
- Consult the dealer or an experienced radio/TV technician for help.

Any unauthorized changes or modifications to this equipment would void the user's authority to operate this device.

This device complies with Part 15 of the FCC Rules. Operation is subject to the following two conditions: (1) This device may not cause harmful interference, and (2) this device must accept any interference received, including interference that may cause undesired operation.

### WARNING:

**TO REDUCE THE RISK OF FIRE, ELECTRIC SHOCK OR PRODUCT DAMAGE, DO NOT EXPOSE THIS APPLIANCE TO RAIN, SPLASHING, DRIPPING OR MOISTURE.**

### CAUTION:

**TO PREVENT ELECTRIC SHOCK MATCH WIDE BLADE OF PLUG TO WIDE SLOT, FULLY INSERT.**



**CAUTION: TO REDUCE THE RISK OF ELECTRIC SHOCK, DO NOT REMOVE SCREWS. NO USER-SERVICEABLE PARTS INSIDE. REFER SERVICING TO QUALIFIED SERVICE PERSONNEL.**



The lightning flash with arrowhead symbol, within an equilateral triangle, is intended to alert the user to the presence of uninsulated "dangerous voltage" within the product's enclosure that may be of sufficient magnitude to constitute a risk of electric shock to persons.



The exclamation point within an equilateral triangle is intended to alert the user to the presence of important operating and maintenance (servicing) instructions in the literature accompanying the appliance.

Before use

# Precautions

Before using this unit please read these operating instructions carefully. Take special care to follow the warnings indicated on the unit itself as well as the safety suggestions listed below. Afterwards keep them handy for future reference.

## Safety

- 1. Power Source**—The unit should be connected to power supply only of the type described in the operating instructions or as marked on the unit.
- 2. Polarization**—If the unit is equipped with a polarized AC power plug (a plug having one blade wider than the other), that plug will fit into the AC outlet only one way. This is a safety feature. If you are unable to insert the plug fully into the outlet, try reversing the plug. If the plug should still fail to fit, contact your electrician to replace your obsolete outlet. Do not defeat the safety purpose of the polarized plug.
- 3. Power Cord Protection**—AC power supply cords should be routed so that they are not likely to be walked on or pinched by items placed upon or against them. Never take hold of the plug or cord if your hand is wet, and always grasp the plug body when connecting or disconnecting it.
- 4. Nonuse Periods**—When the unit is not used, turn the power off. When left unused for a long period of time, the unit should be unplugged from the household AC outlet.

## Installation

### Environment

- 1. Outdoor Antenna Grounding**—If an outside antenna is connected to the receiver, be sure the antenna system is grounded so as to provide some protection against voltage surges and built-up static charges. Section 810 of the National Electrical Code, ANSI/NFPA No. 70-1990, provides information with respect to proper grounding of the mast and supporting structure, grounding of the lead-in wire to an antenna discharge unit, size of grounding conductors, location of antenna-discharge unit, connection to grounding electrodes, and requirements for the grounding electrode. See figure below.

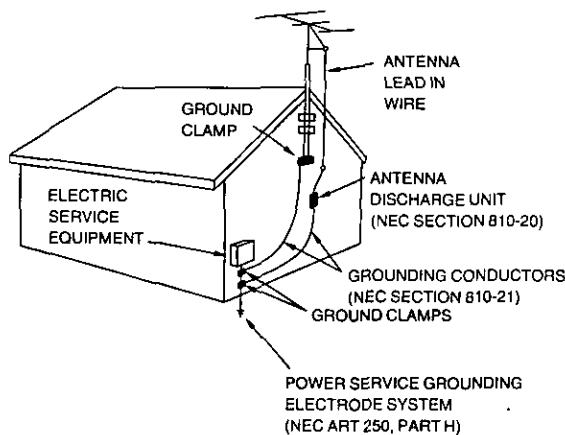

NEC—NATIONAL ELECTRICAL CODE

- 2. Water and Moisture**—Do not use this unit near water—for example, near a bathtub, washbowl, swimming pool, or the like. Damp basements should also be avoided.
- 3. Heat**—The unit should be situated away from heat sources such as radiators and the like. It also should not be placed in temperatures less than 5°C (41°F) or greater than 35°C (95°F).

### Placement

- 1. Ventilation**—The unit should be situated so that its location or position does not interfere with its proper ventilation. Allow 10 cm (4") clearance from the rear of the unit.
- 2. Foreign Material**—Care should be taken so that objects do not fall into and liquids are not spilled into the unit. Do not subject this unit to excessive smoke, dust, mechanical vibration, or shock.
- 3. Magnetism**—The unit should be situated away from equipment or devices that generate strong magnetic fields.
- 4. Stacking**—Do not place heavy objects, other than system components, on top of the unit.
- 5. Surface**—Place the unit on a flat, level surface.
- 6. Carts and Stands**—The unit should be used only with a cart or stand that is recommended by the manufacturer. The unit and cart combination should be moved with care. Quick stops, excessive force, and uneven surfaces may cause the unit and cart combination to overturn.
- 7. Wall or Ceiling Mounting**—The unit should not be mounted to a wall or ceiling, unless specified in this operating instructions.



## Maintenance

Clean the cabinet, panel and controls with a soft cloth lightly moistened with mild detergent solution. Do not use any type of abrasive pad, scouring powder or solvent such as alcohol or benzene.

## Service

- 1. Damage Requiring Service**—The unit should be serviced by qualified service personnel when:
  - (a) The AC power supply cord or the plug has been damaged;
  - or
  - (b) Objects have fallen or liquid has been spilled into the unit;
  - or
  - (c) The unit has been exposed to rain; or
  - (d) The unit does not appear to operate normally or exhibits a marked change in performance; or
  - (e) The unit has been dropped, or the enclosure damaged.
- 2. Servicing**—The user should not attempt to service the unit beyond that described in the operating instructions. All other servicing should be referred to an authorized service personnel.

**For the address of an authorized servicer:**

**In the U.S.A. 1-800-211-7262 or web site  
(<http://www.panasonic.com>)**

**In Canada 905-624-5505 or web site  
([www.panasonic.ca](http://www.panasonic.ca))**

# To enjoy surround sound

Do the connections, settings, and adjustments in the order shown to enjoy surround sound with this unit's DSP features. Be sure to make the correct speaker settings. If, for example, you have not connected a center speaker and you leave the initial setting value of LARGE as it is, then dialog and other sounds may not be reproduced.

## Connect the equipment

(→ Pages 10–13.)



## Position and connect the speakers

(→ Pages 14–15.)

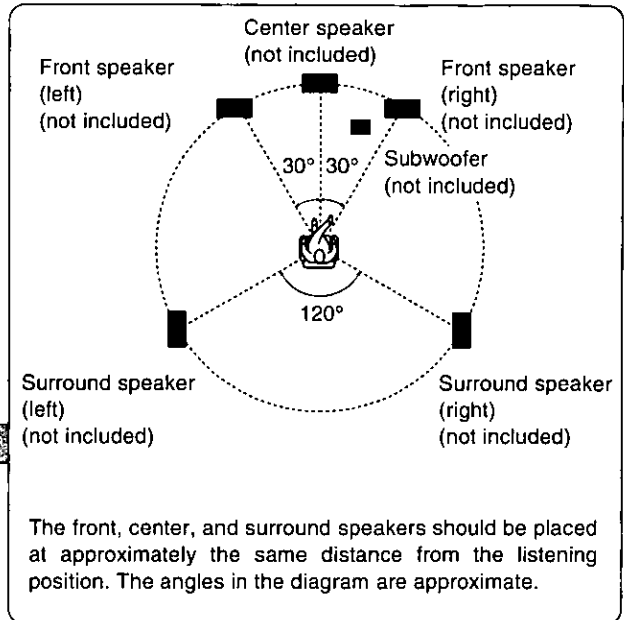

## Set the presence and type (small/large), distance and filter of the speakers you have connected

(→ Pages 16–18.)

### Front, Center, and Surround speaker

#### In SIZE

Select LARGE or SMALL for the front speakers  
Select LARGE, SMALL, or NONE for the center and surround speakers

#### In DISTANCE

Enter the distance of each speaker from the listening position

#### In FILTER

Enter the cutoff frequency for your subwoofer based on the bass capability of your front speakers

### SUBWOOFER

Select ON or OFF



## Adjust the level for the speakers

(→ Page 19.)

While sitting in the usual listening position, use the test signal to adjust the volume of the speakers to the same apparent level.



## Sit back and enjoy the experience

(→ Pages 22–23.)

Before use

# Front panel controls

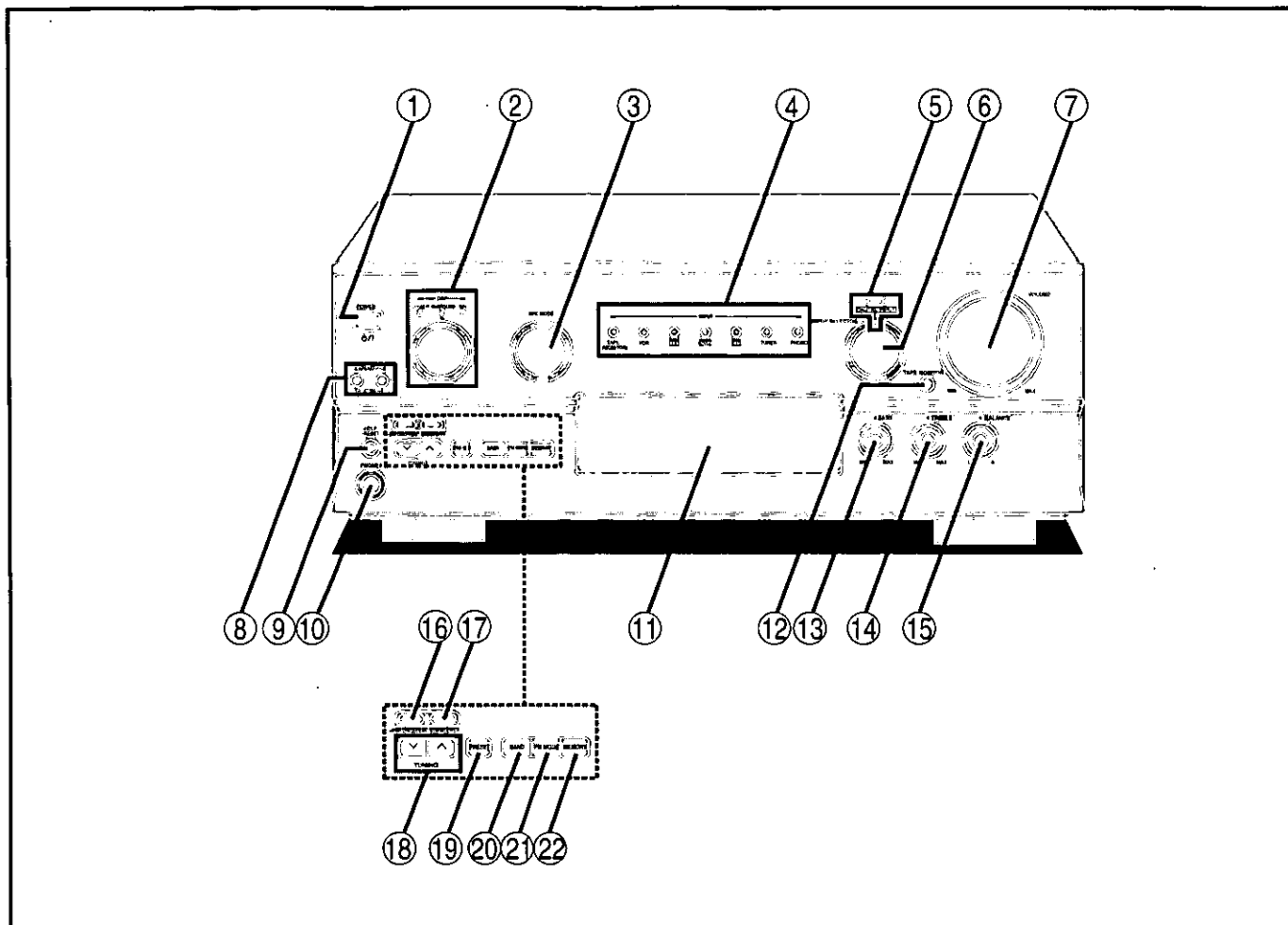

## Main unit

No.	Name	Ref.page	No.	Name	Ref.page
①	Power “ $\text{I}$ ” switch (POWER, $\text{I}$ )	16	⑩	Headphones jack (PHONES)	30
	Press to switch the unit from on to standby mode or vice versa. In standby mode, the unit is still consuming a small amount of power.		⑪	Display section	7
②	DSP mode selector (DSP)	22	⑫	Tape monitor button (TAPE MONITOR)	25
③	SFC mode selector (SFC MODE)	22	⑬	Bass control (BASS)	24
④	Input indicators (INPUT)	22	⑭	Treble control (TREBLE)	24
⑤	Digital input select button/indicator (DIGITAL INPUT)	22	⑮	Balance control (BALANCE)	24
⑥	Input selector (INPUT SELECTOR)	22	⑯	Digital signal processor on/defeat button (-DSP ON/DEFEAT)	21, 26
⑦	Volume control (VOLUME)	23	⑰	Subwoofer button (SUBWOOFER)	18, 24
⑧	Speaker select buttons (SPEAKERS A, B)	16, 22	⑱	Tuning buttons (TUNING $\nabla$ , $\wedge$ )	26
⑨	Help/reset button (-HELP, -RESET)	39	⑲	Preset channel button (PRESET)	29
			⑳	Band select button (BAND)	26
			㉑	FM mode select button (FM MODE)	26
			㉒	Memory button (MEMORY)	28

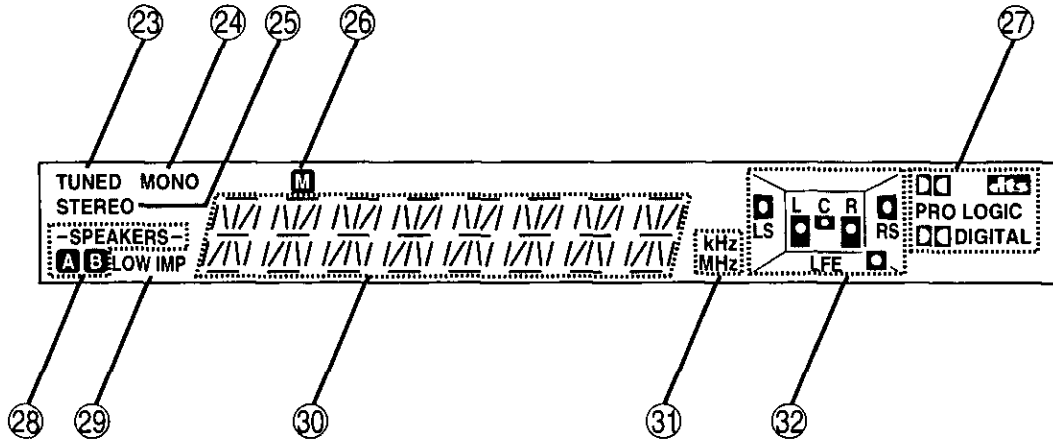

Display section

No.	Name	Ref.page
23	Tuned indicator (TUNED) .....	26
24	Monaural indicator (MONO) .....	26
25	Stereo indicator (STEREO) .....	26
26	Memory indicator (M) .....	28
27	Signal format indicators ( , , ) .....	20
28	Front speaker indicator (-SPEAKERS- ) .....	22
29	Low impedance indicator (LOW IMP) .....	25
30	Display	
31	Frequency unit indicator (kHz, MHz) .....	26

No.	Name	Ref.page
32	Speaker input indicators and Signal input indicators .....	18
	(L, C, R, LS, RS, LFE)	
	The signal input indicators light up to indicate the channels contained in the input signal.	
	L: Front channel (left)	
	C: Center channel	
	R: Front channel (right)	
	LS: Surround channel (left)	
	RS: Surround channel (right)	
	If the surround channel is monaural, LS and RS are displayed as S.	
	"LFE" (Low Frequency Effect) is a channel for the deep-bass effect in the low frequency range.	

## Front panel controls

## Remote control

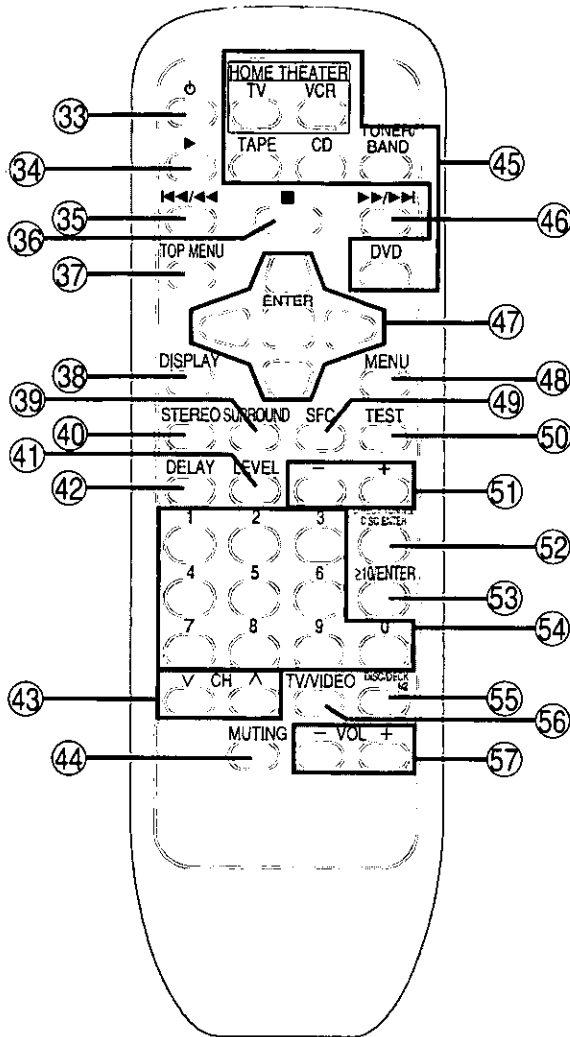

No.	Name	Ref. page
33	Power button (⏻) .....	32
34	▶ button (▶) .....	33
35	◀◀/◀◀ button (◀◀/◀◀) .....	33
36	■ button (■) .....	33
37	Top menu button (TOP MENU) .....	37
38	Display button (DISPLAY) .....	37
39	Surround mode select button (SURROUND) .....	32
40	Stereo mode select button (STEREO) .....	32
41	Speaker channel select button (LEVEL) .....	19, 32
42	Delay time button (DELAY) .....	23, 32
43	Channel up/down buttons (∇CH∧) .....	33
44	Muting button (MUTING) .....	30, 32
45	Input select buttons (TV, VCR, TAPE, CD, TUNER/BAND, DVD) .....	32
46	▶▶/▶▶ button (▶▶/▶▶) .....	33
47	Cursor/enter buttons .....	37
48	Menu button (MENU) .....	37
49	SFC mode select button (SFC) .....	32
50	Test button (TEST) .....	19, 32
51	Delay time/level adjust buttons (-, +) .....	19, 32
52	Direct tuning/disc enter button (DIRECT TUNING/DISC ENTER) .....	27, 33
53	≥10/enter button (≥10/ENTER) .....	33
54	Numbered buttons .....	27, 33
55	Disc/deck 1/2 select button (DISC/DECK 1/2) .....	33
56	TV/video select button (TV/VIDEO) .....	35
57	Volume buttons (-VOL+) .....	19, 32



## Concerning the remote control

### A Battery installation

#### Use of batteries

- Align the poles (+ and -) properly when inserting the batteries. Press in and down towards the minus end.
- Do not mix old and new batteries or different types of batteries.
- Do not recharge ordinary dry cell batteries.
- Do not heat or disassemble the batteries. Do not allow them to contact flame or water.
- Remove the batteries if the unit is not to be used for a long time.
- Do not keep together with metallic objects such as necklaces.
- Do not use rechargeable type batteries.
- Do not use batteries if the covering has been peeled off.

Mishandling of batteries can cause electrolyte leakage which can damage items the fluid contacts and may cause a fire.

If electrolyte leaks from the batteries, consult your dealer.

Wash thoroughly with water if electrolyte comes in contact with any part of your body.

### B Correct method of use

#### Operation notes

- Do not place obstacles between the remote control signal sensor and remote control unit.
- Do not expose the remote control signal sensor to direct sunlight or to the bright light of a fluorescent light.
- Take care to keep the remote control signal sensor and end of the remote control unit free from dust.
- If the unit is installed in a rack with glass doors, the glass doors' thickness or color might make it necessary to use the remote control a shorter distance from the unit.

#### To prevent damage

- Never place heavy items on top of the unit.
- Do not disassemble or reconstruct the unit.
- Do not spill water or other liquids into the unit.

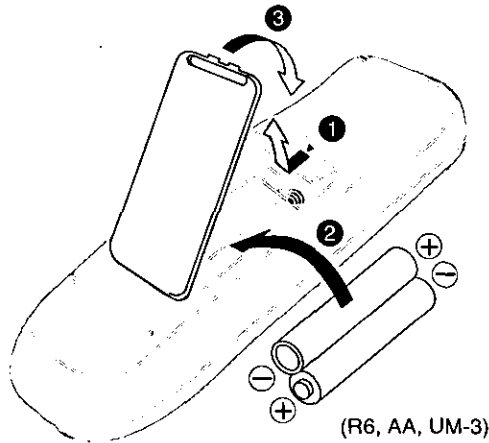
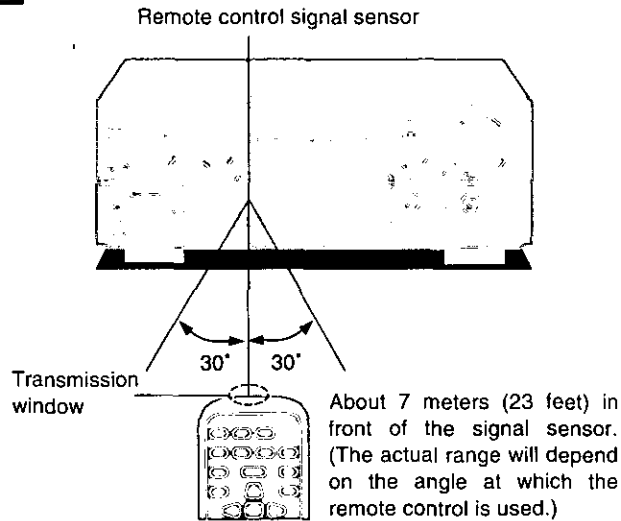
**A****B****Before use**

# Connections

## Stereo connection cable (not included)



## Video connection cable (not included)

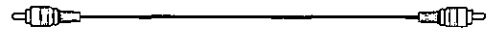

Make sure that the power supply for all components has been turned off before making any connections.

To connect equipment, refer to the appropriate operating instructions.

### Note

Use digital connection to enjoy Dolby Digital or DTS (→ page 20). Analog connection is necessary if you intend to record the source (→ page 31).

## Connecting a TV and a DVD player

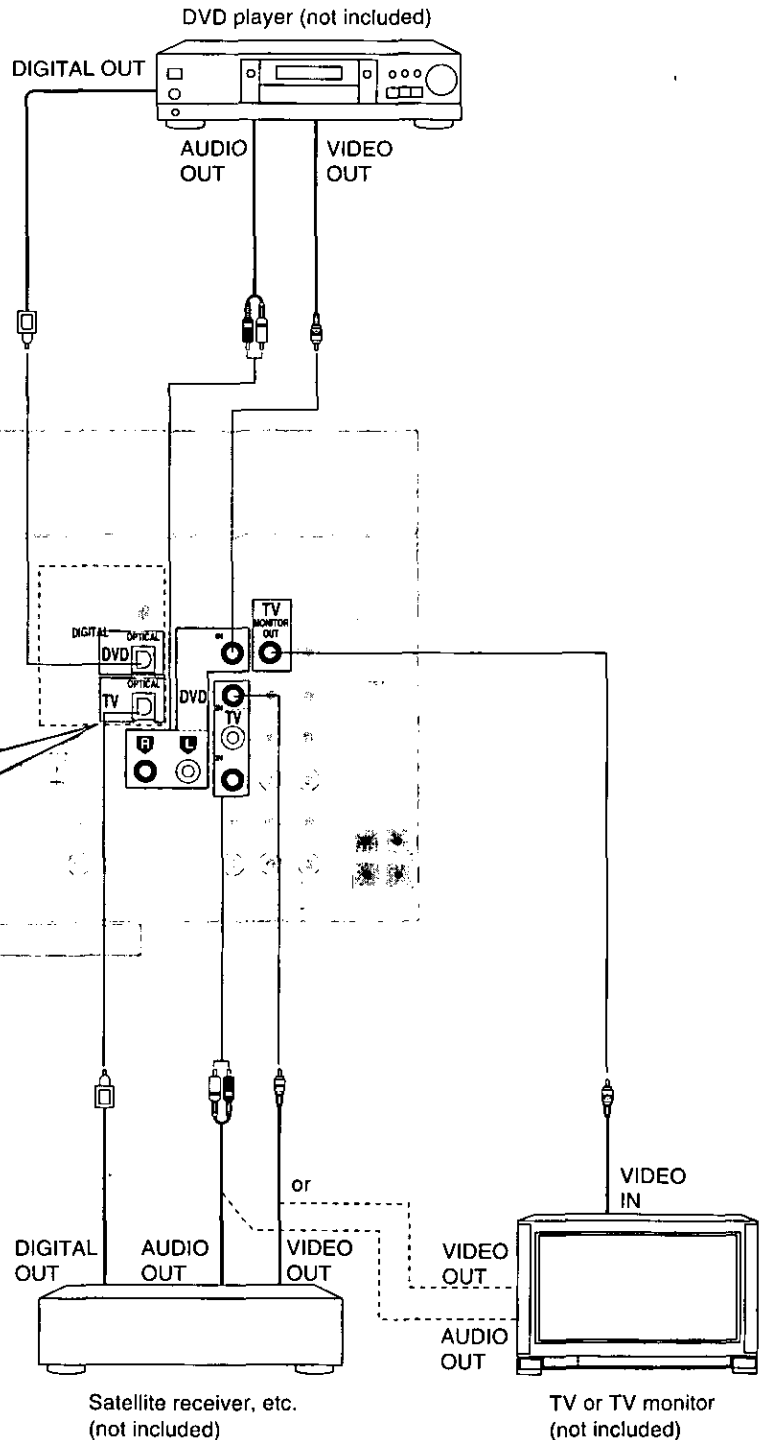
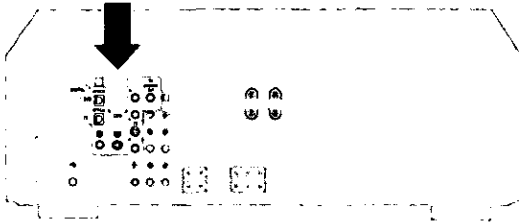

### Connection for optical fiber cable

Dust-protection cap

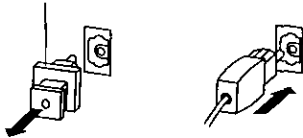

- Do not bend the optical fiber cable.
- If the digital optical connector is not going to be used, be sure to attach the dust-protection cap to prevent exposure to dust.

### Note

Dolby Digital RF (radio frequency) signals cannot be decoded with this unit.

Optical fiber cable (not included)

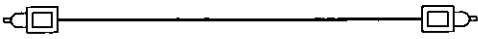

## Connecting audio equipment

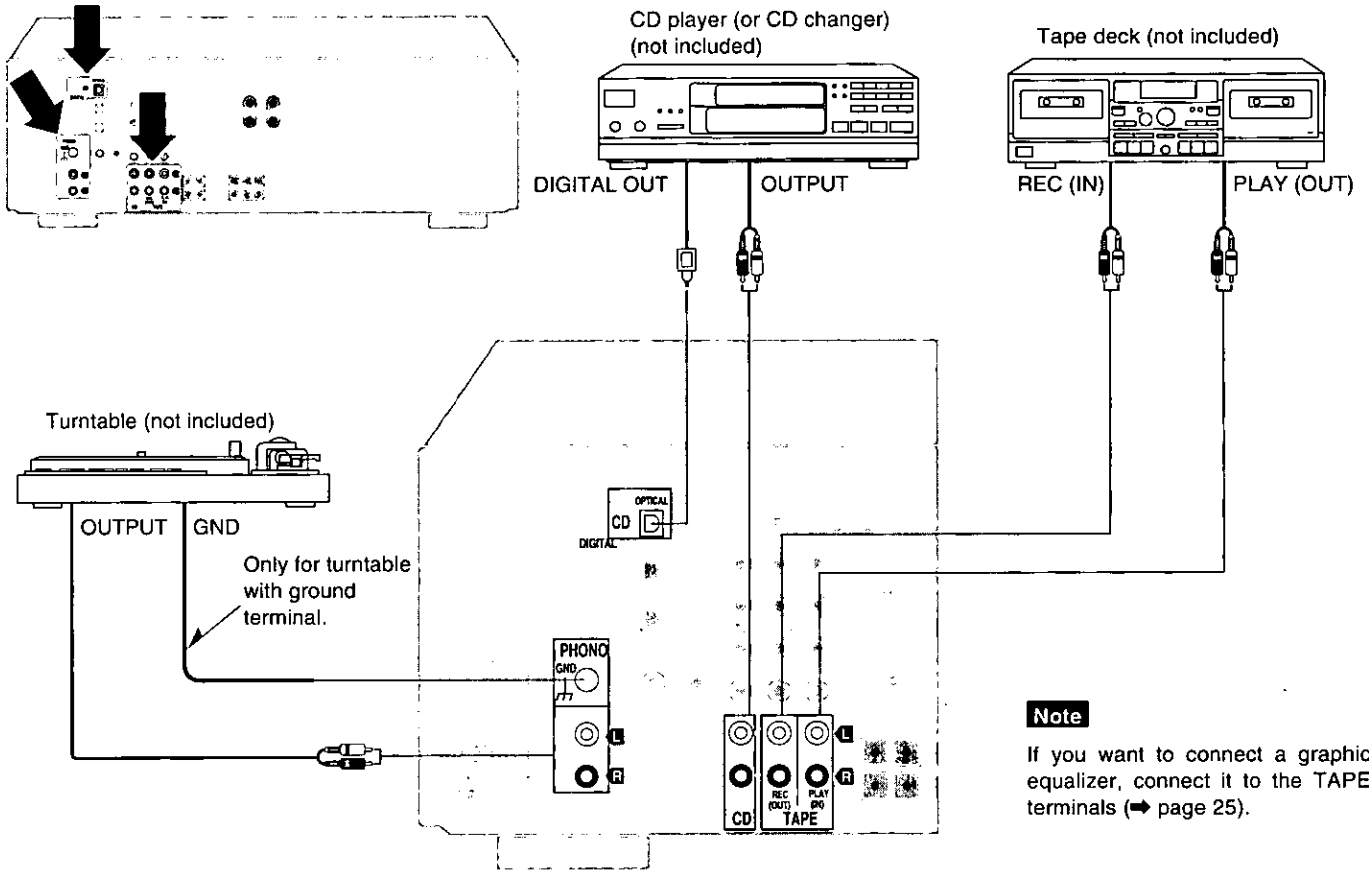

## Connecting video equipment

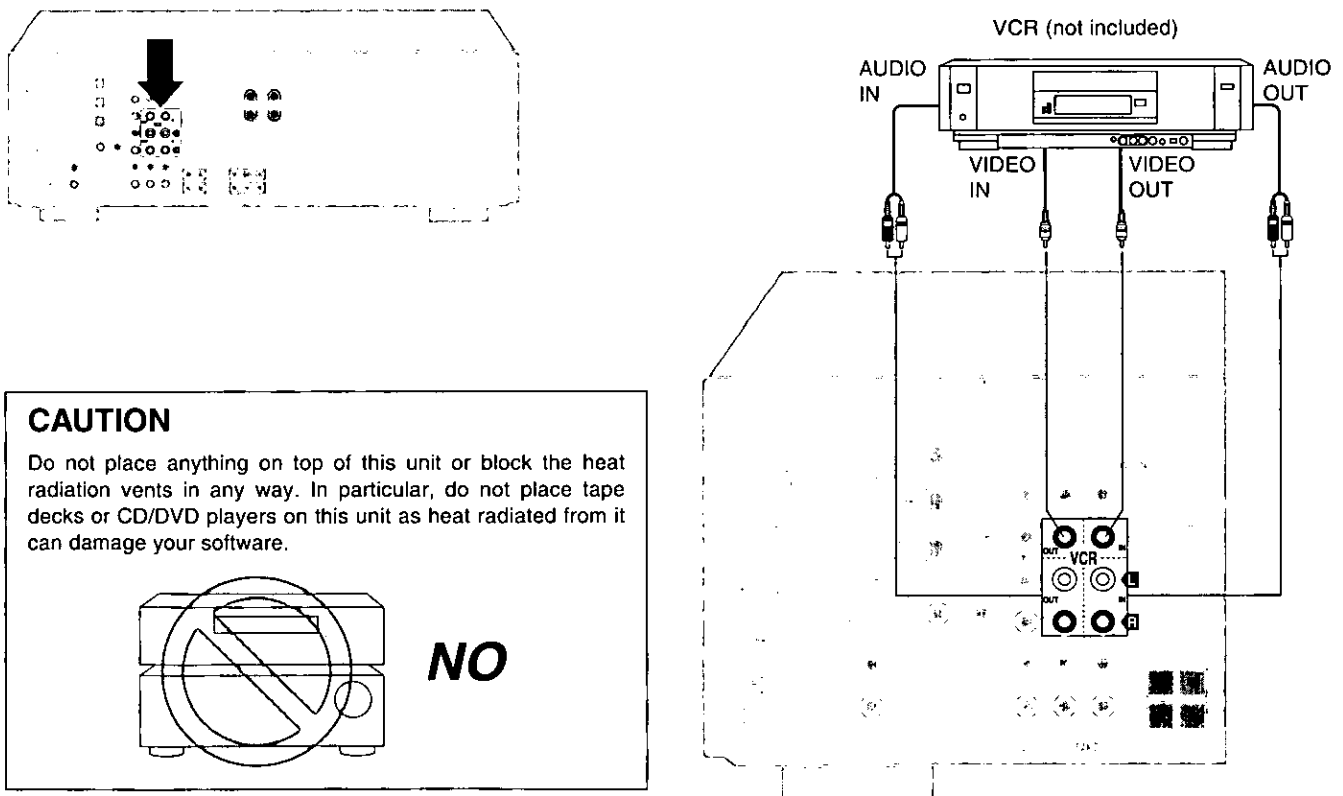

**Antenna connections**

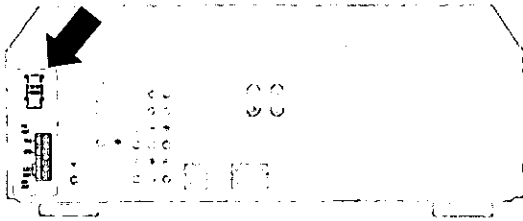

**AM loop antenna**

- Fit the AM loop antenna holder (included) onto the rear panel of this unit and then attach the AM loop antenna to the AM loop antenna holder (facing in the direction of best reception).
- Keep loose antenna cord away from other wire cords or a tape deck.

**When mounting the antenna to a column, a wall or rack**

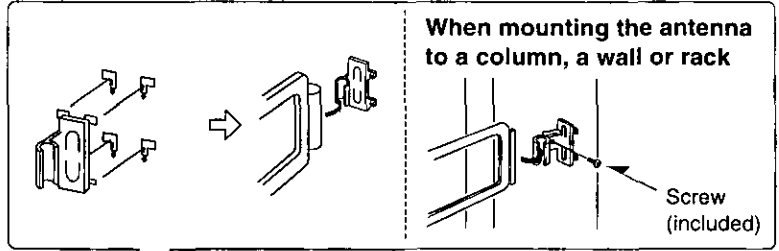

**FM antenna**

Fix the other end of the antenna where reception is best.

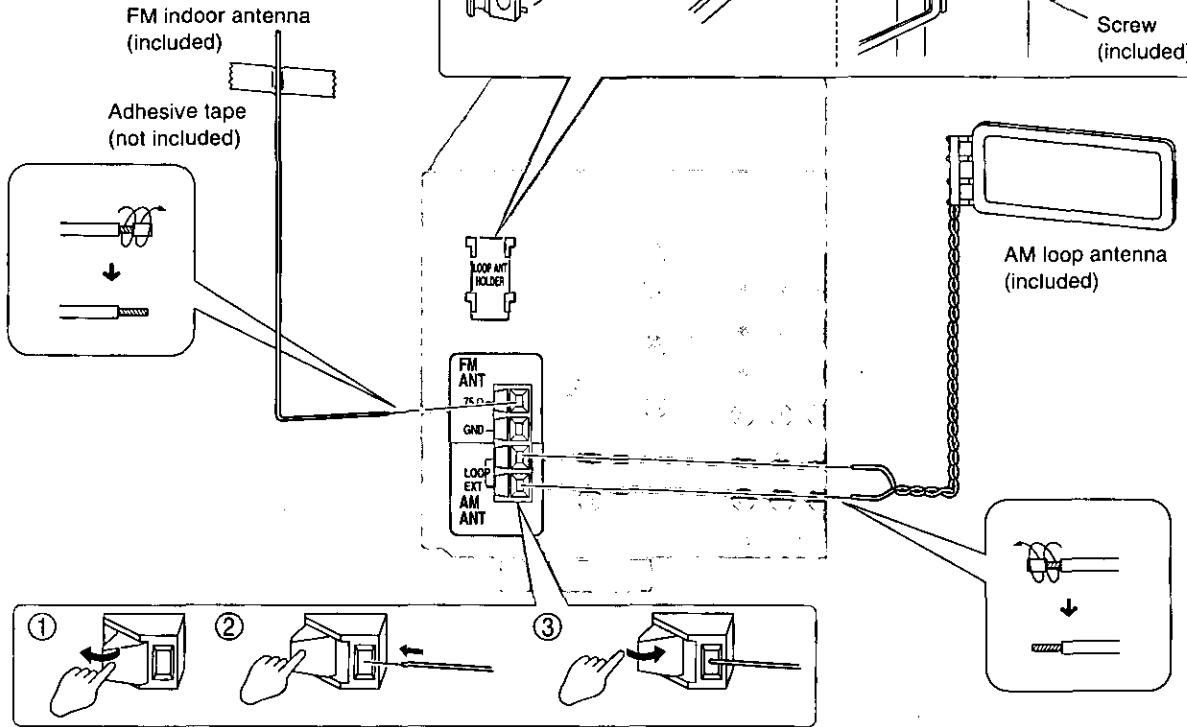

**To connect an outdoor antenna**

**FM outdoor antenna**

- Disconnect the FM indoor antenna.
- The antenna should be installed by a competent technician.
- Twist the coaxial cable's shield braid firmly and connect it to the GND terminal.

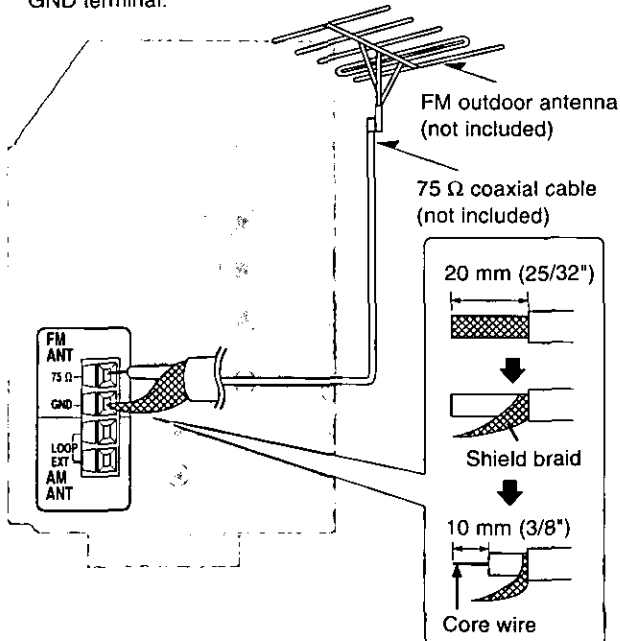

**AM outdoor antenna**

- Run a piece of vinyl wire horizontally across a window or other convenient location.
- Leave the loop antenna connected.
- Disconnect the antenna when the unit is not in use. Do not use the antenna during an electrical storm.

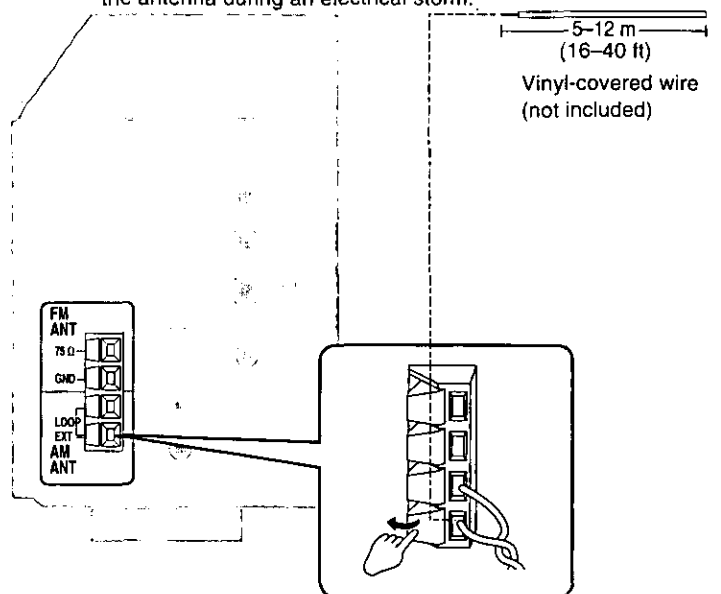

## Connecting the AC power supply cord and other information

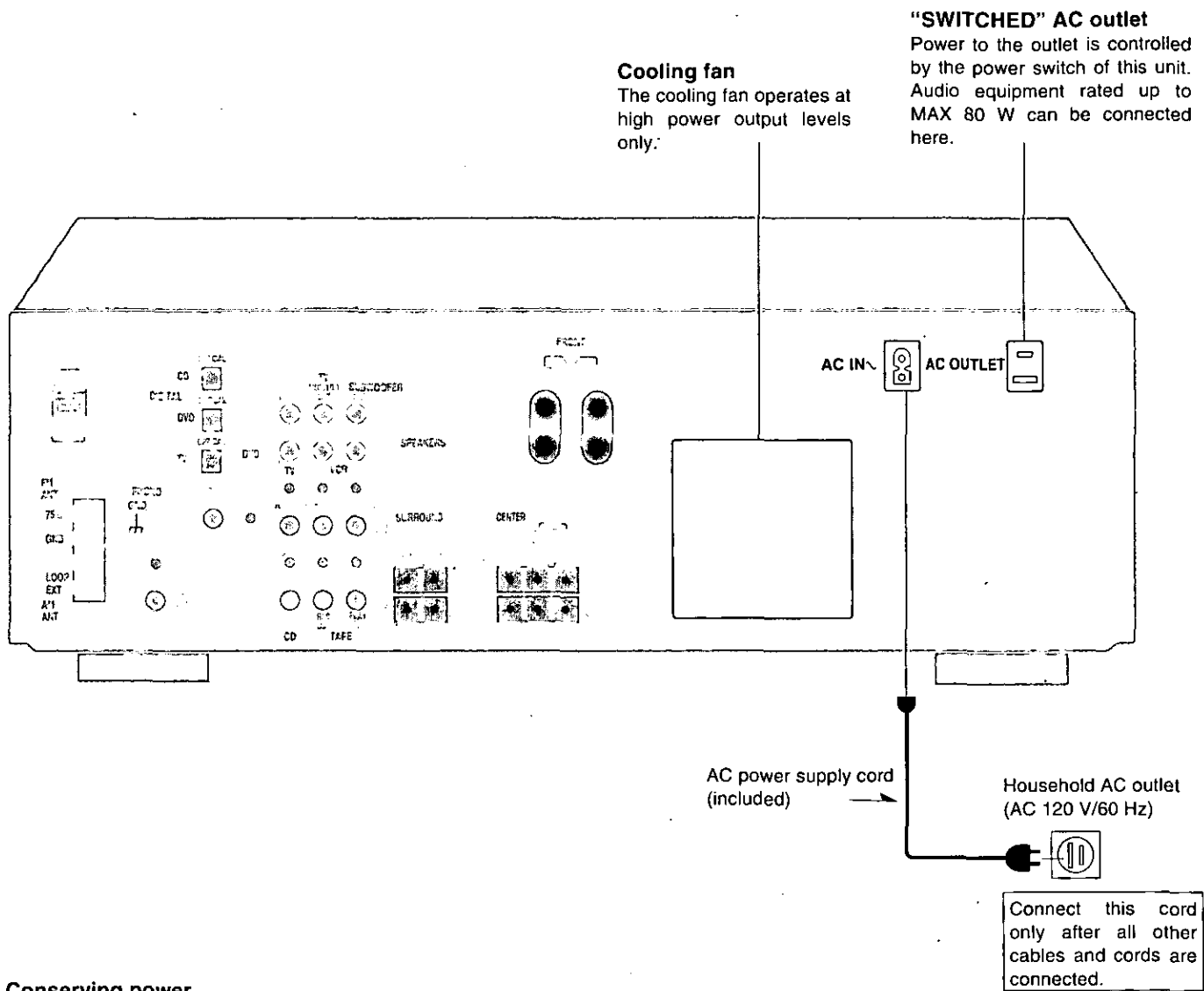

### Conserving power

The unit consumes 1 W even when it is turned off with [POWER,  $\odot/\text{I}$ ]. To save power when the unit is not to be used for a long time, unplug it from the household AC outlet.

If the unit is left unplugged for longer than a few weeks, all settings will revert to the factory settings. Do the settings again if this occurs.

### Note

The included AC power supply cord is for use with this unit only. Do not use it with other equipment.

# Speaker connections

## Placement of speakers

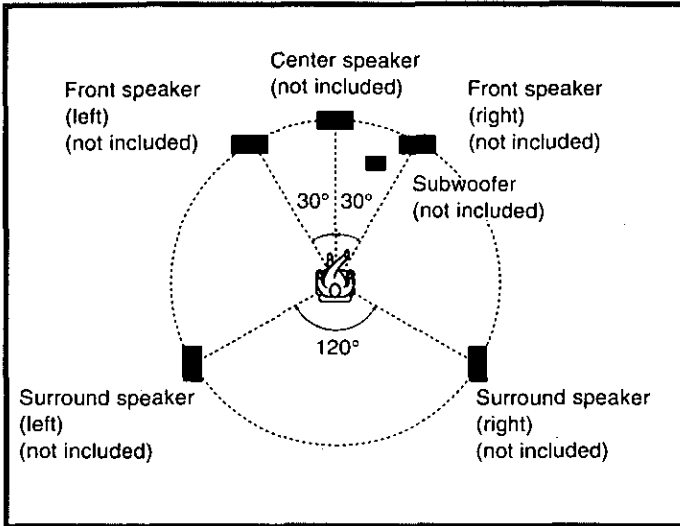

### Front speakers

Place on the left and right of the TV at seated ear height so that there is good coherency between the picture and sound.

### Center speaker

Place underneath or above the center of the TV. Aim the speaker at the seating area.

### Surround speakers

Place on the side of or slightly behind the listening position, about one meter higher than ear level.

### Subwoofer

The subwoofer can be placed in any position as long as it is at a reasonable distance from the TV.

Note that some experimentation can yield the smoothest low frequency performance. Placement near a corner can increase the apparent output level, but can result in unnatural bass.

## Connecting speakers

Other connections are possible depending on your speaker system. See your speaker system's operating instructions for details.

### Front speakers

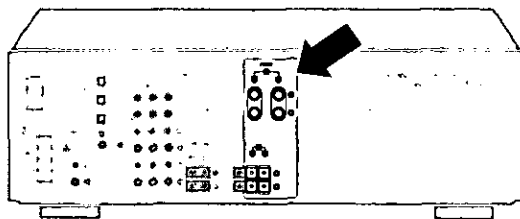

#### Speaker impedance:

A or B: 4-8 Ω  
A and B: 8 Ω

#### Note

If you connect speakers with an impedance under 8 Ω, switch on "LOW IMP" (→ page 25).

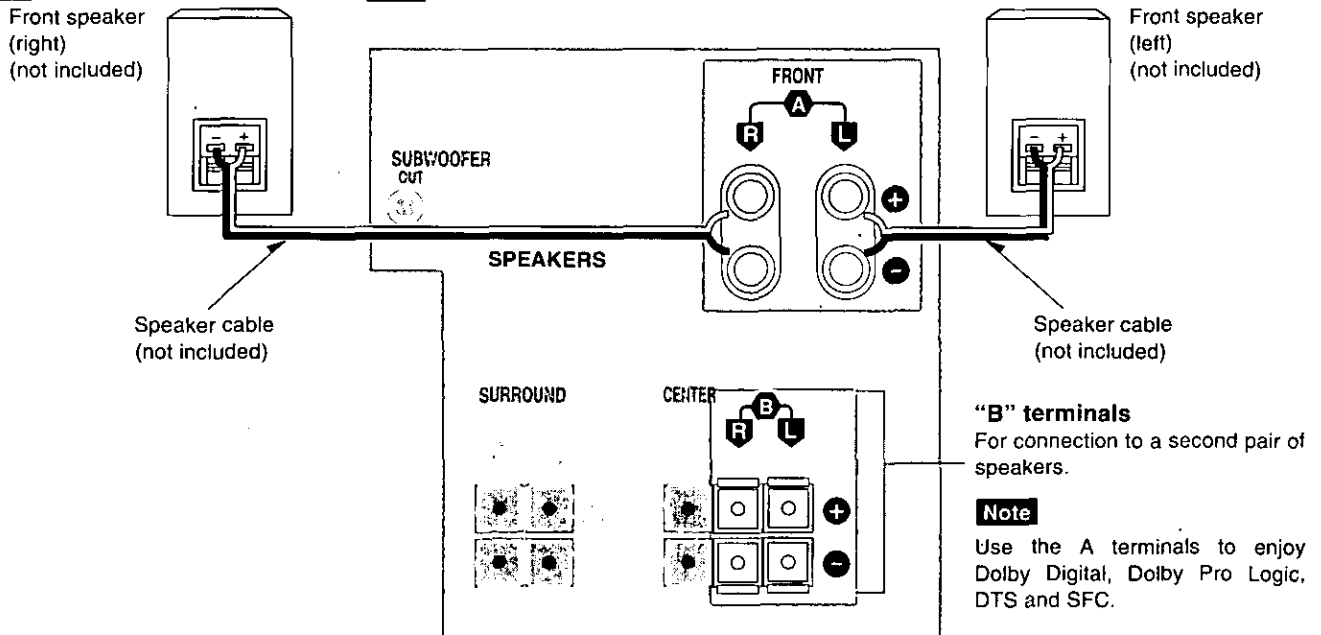

### Connecting the cables

(Front "A" terminals)

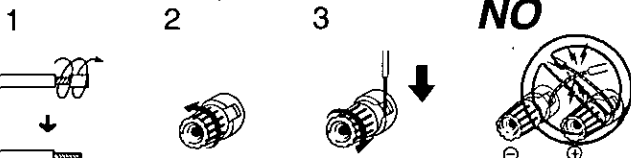

(Other speaker terminals)

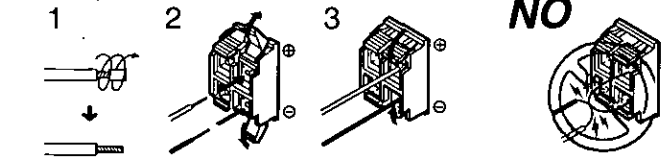

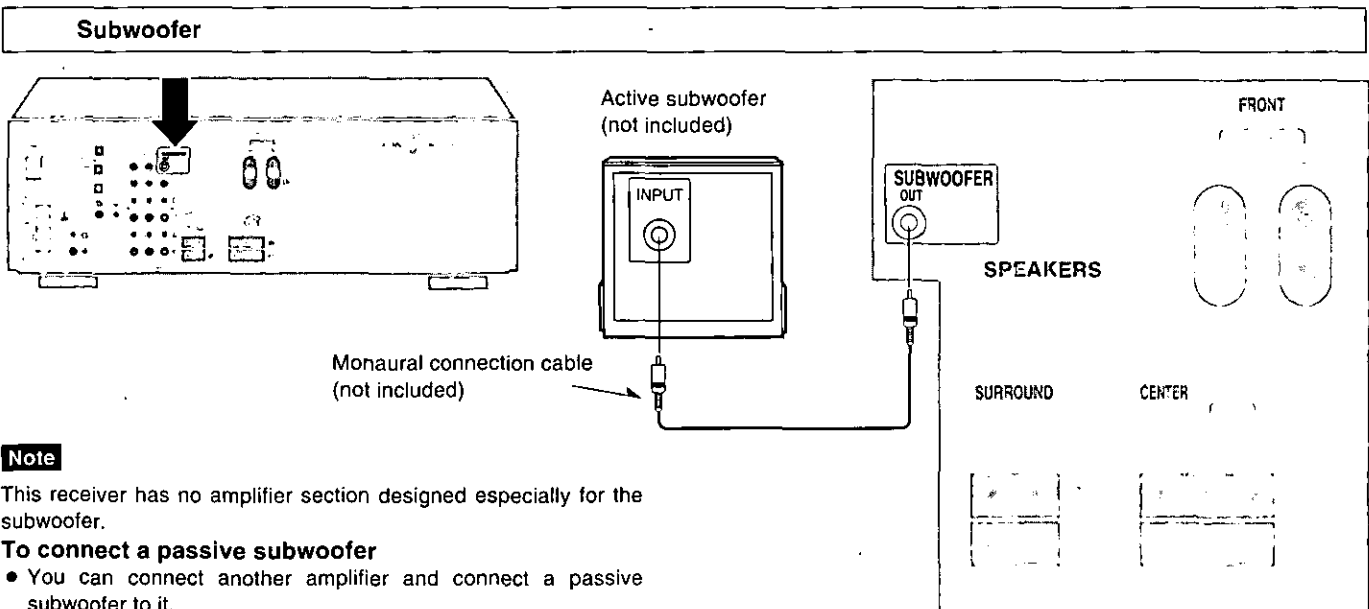
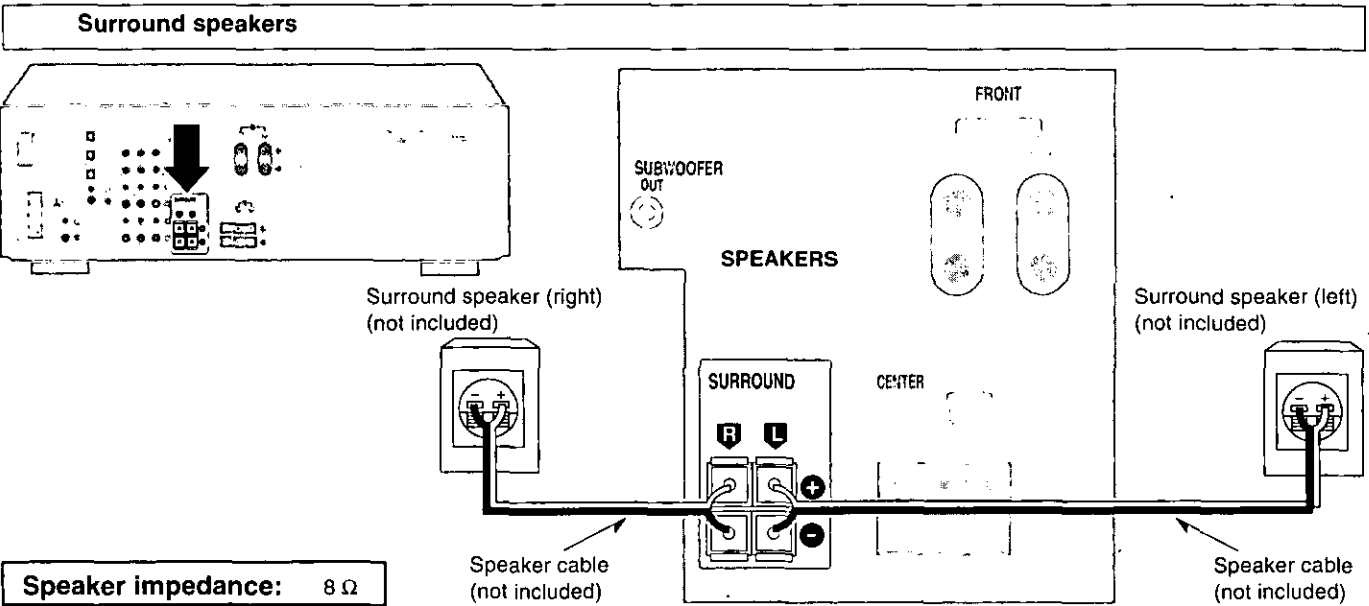
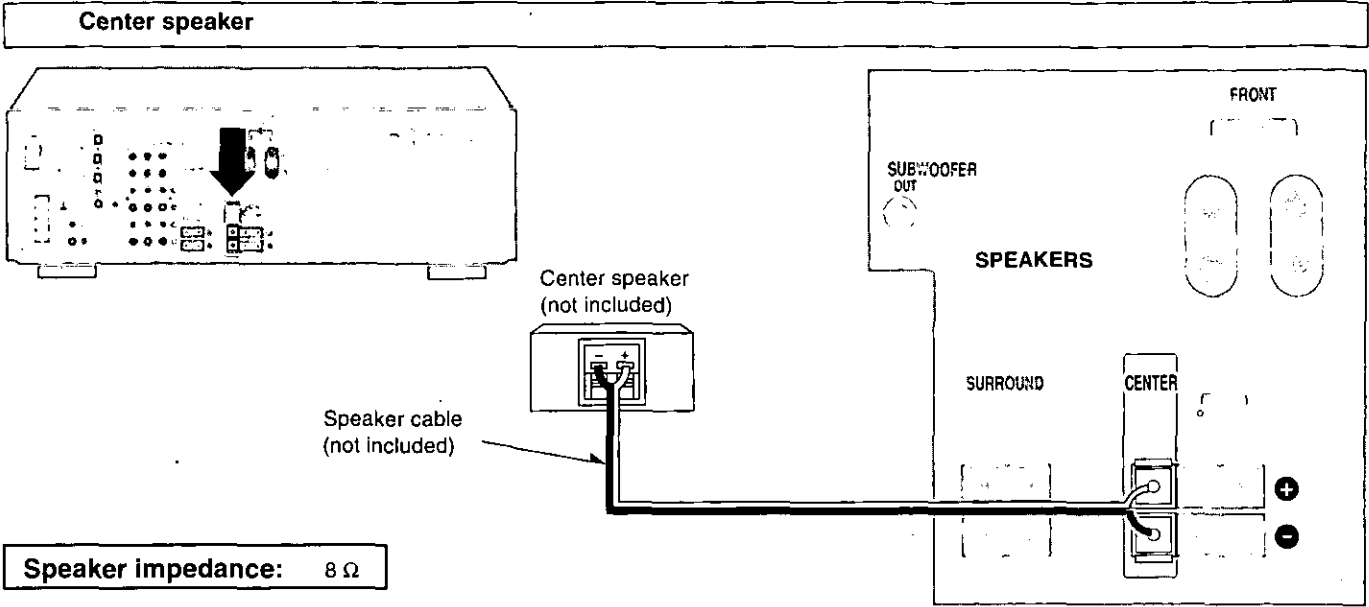

**Note**

This receiver has no amplifier section designed especially for the subwoofer.

**To connect a passive subwoofer**

- You can connect another amplifier and connect a passive subwoofer to it.
  - Connection to a passive subwoofer that has front speaker terminals is also possible.
- (See the operating instructions of the speaker system for details.)

## Preparatory steps

### Speaker settings

These settings should be done to get the most from the unit's reproduction modes (→ pages 20–21):

#### Front, center, and surround channel settings

Set the SIZE, DISTANCE, and FILTER for your speakers.

##### In SIZE

Set the type (LARGE or SMALL) and presence of your speakers. Select "LARGE" if the speakers can produce bass (below around 100 Hz). Select "SMALL" if the speakers cannot produce bass. If you aren't using center or surround speakers select "NONE" so the sound is produced through the front speakers.

The speaker channels are all set to "LARGE" before shipping. If all your speakers are LARGE, you may skip this operation.

##### In DISTANCE

Enter the distance of each speaker from the listening position so the sound from the speakers reaches the listening position at the same time. The unit calculates the delay time for the center and surround speakers based on these distances.

##### In FILTER

Enter the cutoff frequency for your subwoofer based on the bass capability of your front speakers  
The factory setting is 100 Hz.

**1** Press [POWER, .

**2** Press [A] and [B] at the same time.

"SETTING" appears on the display.

**3** Press [A] to select what you want to set.

Each time the button is pressed the display switches as follows.

SIZE → DISTANCE → FILTER → DR COMP

(continued on next page)

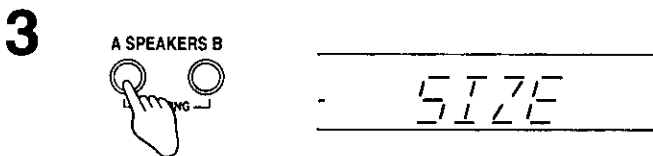
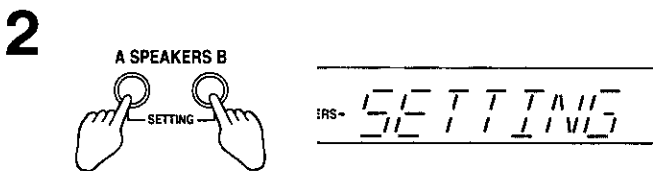
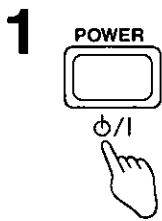
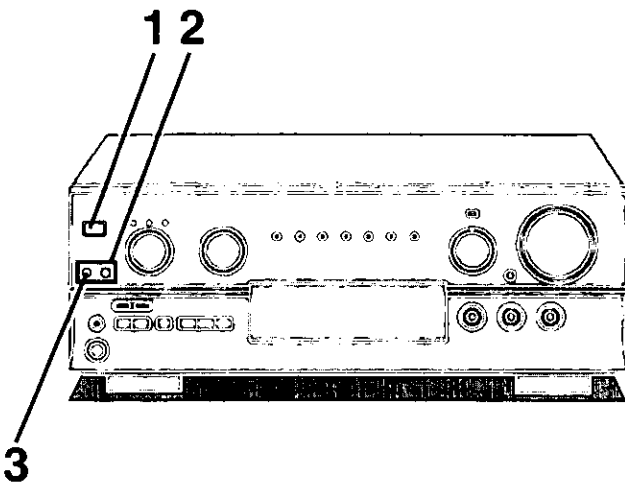



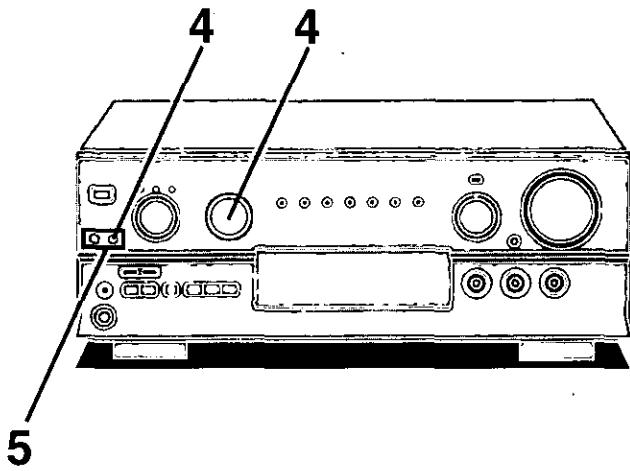

**4** When "SIZE" is selected

- ① Press [B] to select the speaker channel to be set.

Each time the button is pressed the display switches as follows.  
FRONT → CENTER → SURROUND

- ② Turn [SFC MODE] to set the type (LARGE, SMALL) and presence (NONE) of the speaker.

Each time the selector is turned the display switches as follows.

Front:  
SMALL ↔ LARGE  
Center, Surround:  
NONE ↔ SMALL ↔ LARGE

Select "NONE" if a center and surround speaker isn't connected.

- ③ Repeat steps ① and ② to complete at the size settings for the front, center and surround speakers.

When "DISTANCE" is selected

- ① Press [B] to select the speaker channel to be set.

Each time the button is pressed the display switches as follows.  
FRONT → CENTER → SURROUND

- ② Turn [SFC MODE] to set the distance.

Distance can be set at 1 foot intervals between 3 feet to 30 feet.

The factory settings are as follows.  
Front and center speakers: 10 FEET  
Surround speakers: 5 FEET

- ③ Repeat steps ① and ② to complete the distance settings for the front, center and surround speakers.

When "FILTER" is selected

Turn [SFC MODE] to set the cut off frequency.

Each time the selector is turned the display switches as follows.  
100 ↔ 150 ↔ 200

**5** Press [A] and [B] at the same time.

"COMPLETE" appears on the display.

If you allow about 10 seconds to elapse between settings, the procedure is cancelled, all settings are returned to how they were, and the previous display is restored. Begin again if this occurs.

**For your reference:**

The settings remain as they are until changed by the above procedure, even after the power has been turned off.

**4** "SIZE"

① A SPEAKERS B

② SFC MODE

"DISTANCE"

① A SPEAKERS B

② SFC MODE

"FILTER"

SFC MODE

**5** A SPEAKERS B

## Preparatory steps

### A Subwoofer channel setting

Press [SUBWOOFER] to select "ON" or "OFF".

"SUB-WFR" appears on the display and the current setting, "ON" or "OFF," is shown. Press again to switch between "ON" and "OFF."

**ON:** select if you are using a subwoofer.

**OFF:** select if you are not using a subwoofer.

### B The speaker indicators

This part of the display indicates which speakers sound comes from.

The corresponding indicators will not light if you selected "NONE" during the speaker setting procedure (➔ pages 16–17), or if you turned the subwoofer off (see above).

The surround and center speaker indicators do not light when STEREO mode is selected (➔ page 20).

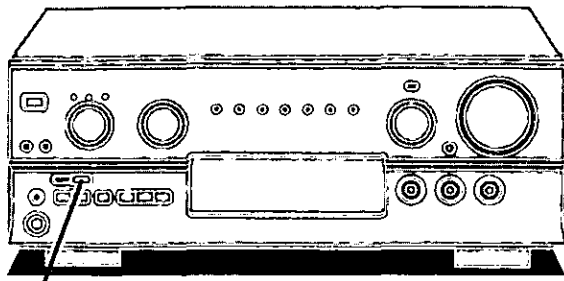
**A**

SUBWOOFER

SUBWOOFER

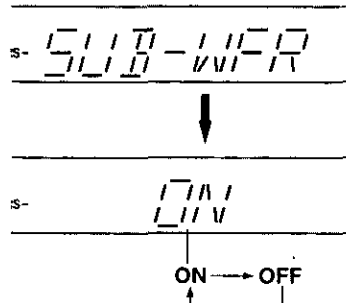
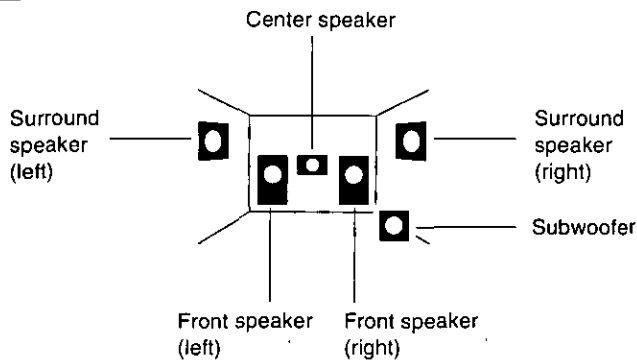
**B**

## Preparatory steps

Do these steps to get the most from your home theater system.

## Adjusting speaker output level

Adjust speaker level so the output from all the speakers is the same apparent level when sitting where you would normally enjoy a source.

### 1 Press [A] to turn on SPEAKERS A.

You cannot adjust when SPEAKERS B is selected.

### 2 by remote control only

### Press [TEST] to output the test signal.

"TEST" appears on the display.

The signal is output from each speaker in order for about two seconds each:

L: Front speaker (left)  
C: Center speaker  
R: Front speaker (right)  
RS: Surround speaker (right)  
LS: Surround speaker (left)  
SW: Subwoofer

Speakers set as "NONE" or "OFF" are skipped.

#### Note

DSP switches to SURROUND mode when the test starts.

### 3 by remote control only

### Press [VOL (- or +)] to set the volume level normally used for enjoying the source.

#### Note

Use [BALANCE] if the left right balance of the front speakers is off.

### 4 by remote control only

### Press [LEVEL] to select the speaker channel to adjust.

The current level appears on the display.  
Press again to change the speaker channel.

Speakers set as "NONE" or "OFF" are skipped.

### 5 by remote control only

### Press [-] or [+] to adjust the level to the same apparent level as the front speakers.

The four channels can be adjusted between -10 dB and +10 dB, with zero being the current level of the front speakers.

### 6 Repeat 4 and 5 for each speaker channel.

#### To stop the test signal

Press [TEST].

#### Note

The test signal will not be output if DSP DEFEAT is engaged. Ensure DSP is ON (→ Page 21).

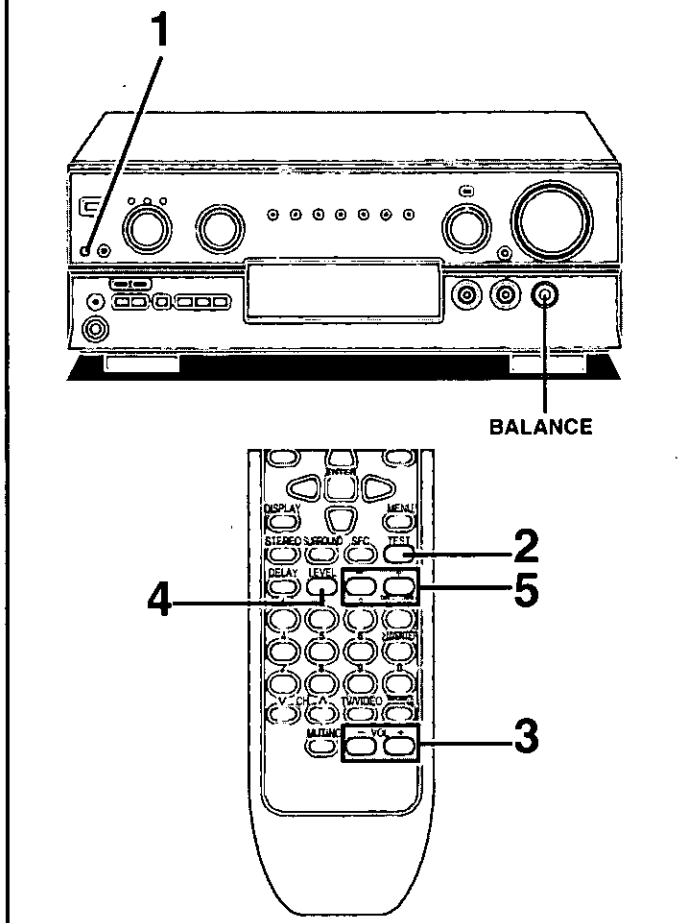

BALANCE

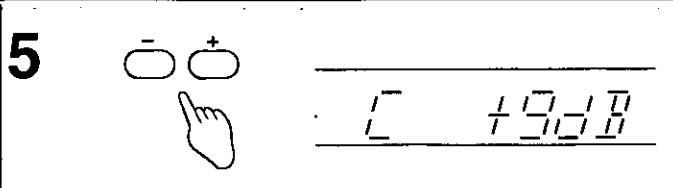
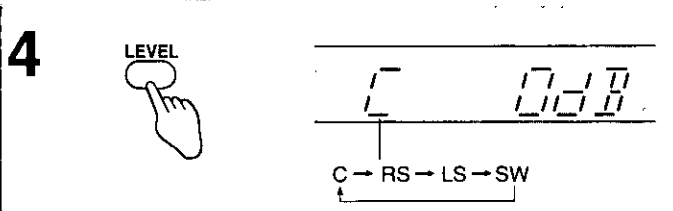
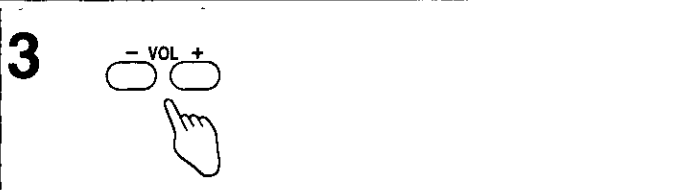
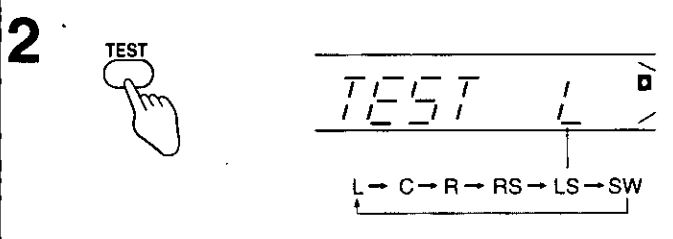
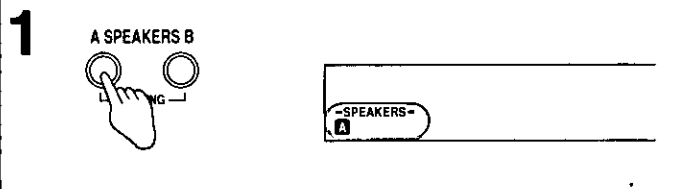

# Digital Signal Processor (DSP)

You can take advantage of the following modes with this unit.

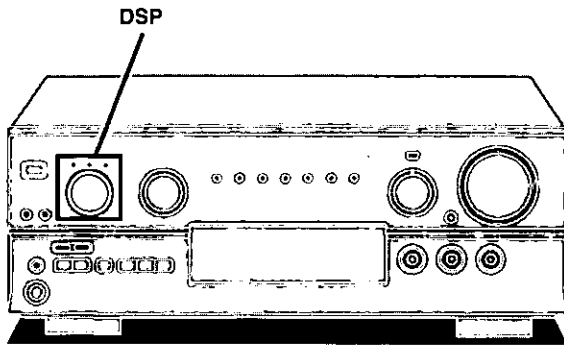

## A STEREO mode

Use this mode when you want to listen to stereo sources, whether they are digital or analog, or when you want to playback Dolby Digital or DTS sources through two channels. The sounds usually fed through the other speakers are down-mixed so they are output through the left and right front speakers. There may be some change in the overall sound when surround sources are down-mixed.

## B SURROUND mode

By selecting this mode while digital input is being used, the unit automatically determines the kind of digital source being used (Dolby Digital, Dolby Surround, or DTS), and processes it accordingly. Select this mode also when you are playing back an analog source, VCR for example, that has been recorded in Dolby Surround.

Software with the following mark can be played back in this mode.



### A

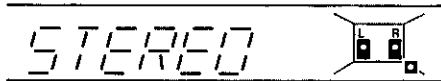
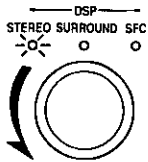

### B

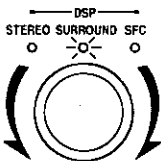

#### Dolby Pro Logic

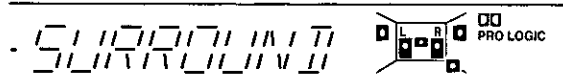

#### Dolby Digital

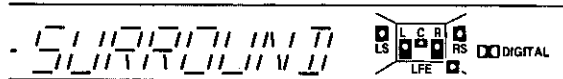

#### DTS

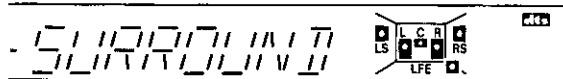

The following indicators light depending on the source.

#### PRO LOGIC

When playing analog sources.

When playing digital sources with PCM signals.

When playing Dolby Digital sources that contain Dolby Pro Logic.

#### DIGITAL

When playing Dolby Digital sources.

#### DTS

When playing DTS sources.

Manufactured under license from Dolby Laboratories. "Dolby", "Pro Logic" and the double-D symbol are trademarks of Dolby Laboratories. Confidential Unpublished Works. © 1992-1997 Dolby Laboratories, Inc. All rights reserved.

Manufactured under license from Digital Theater Systems, Inc. US Pat. No. 5,451,942 and other world-wide patents issues and pending. "DTS" and "DTS Digital Surround" are trademarks of Digital Theater Systems, Inc. © 1996 Digital Theater Systems, Inc. All rights reserved.

## Digital Signal Processor (DSP)

### SFC modes

The SFC (Sound Field Control) function gives presence and spread thereby enhancing and enriching the music or movie. Read the following explanations better understand how to make your selection.

#### Note

SFC is designed to add surround-like effects to stereo sources. Select the appropriate mode when playing back Dolby Digital, DTS, or Dolby Surround sources.

#### HALL

This mode imparts a reflection and spread which will make you feel as if you are in a large concert hall.

#### CLUB

Like a jazz club, this mode provides an exciting and intimate atmosphere. It simulates the sound field of a relatively small room having a low ceiling and hard reflective surfaces, for a "live" sound with enhanced presence to bring the performers up close.

#### LIVE

Primarily for vocal pieces, this mode adds gloss to the vocals and you'll feel as though you were hearing a live stage performance.

#### THEATER

You can clearly perceive the directions and source of the movie. Real ambience of sound can also be recreated naturally using this mode.

#### SIM SURR (SIMULATED)

Choose this mode if little or no sound will be heard from the surround speakers.

You can feel as if you were in a more expanded space adding to the actual sound from the source.

This mode also adds effect to monaural sources by outputting sound from surround speakers.

#### If the beginning of a track is cut off when playing CDs

The beginning of a track may not be heard if you play CDs in STEREO mode.

You can solve this by engaging the PCM FIX mode.

Press and hold [DIGITAL INPUT] for four seconds.

"PCM FIX" appears on the display.

This mode can be selected for each source, but is cancelled when the unit is turned off.

#### Note

- The PCM FIX mode can be selected in STEREO mode only.
- Dolby Digital and DTS sources cannot be played while PCM FIX mode is on.
- Noise can occur if DTS sources are played while PCM FIX mode is engaged. To avoid this, be sure to turn PCM FIX mode off after use.

#### If reception is weak or "TUNED" fails to light completely while playing the radio

Press and hold [-DSP ON/DEFEAT] until "DEFEAT" appears on the display.

Press and hold again to turn DSP on. The STEREO mode is selected.

This allows you to play back sound without it passing through the digital signal processor (DSP). When this is selected, no sound will go through the center or surround speakers or the subwoofer.

#### Note

When "DEFEAT" is selected the sound mode indicators (STEREO, SURROUND and SFC) go out and these modes can not be selected.

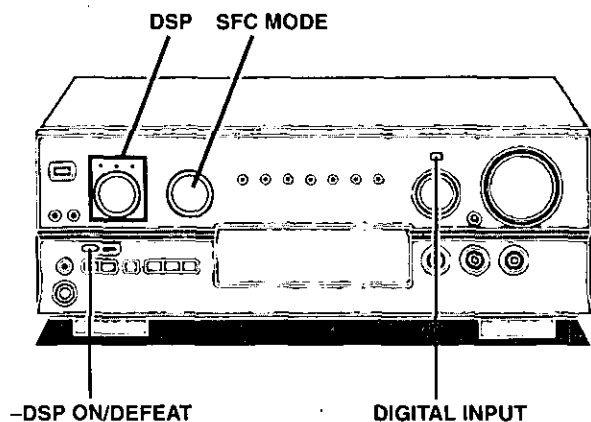

DSP  
STEREO SURROUND SFC



HALL



CLUB



LIVE



THEATER



SIM SURR



## Enjoying the sounds

Before operation, set [VOLUME] to the "MIN" position.

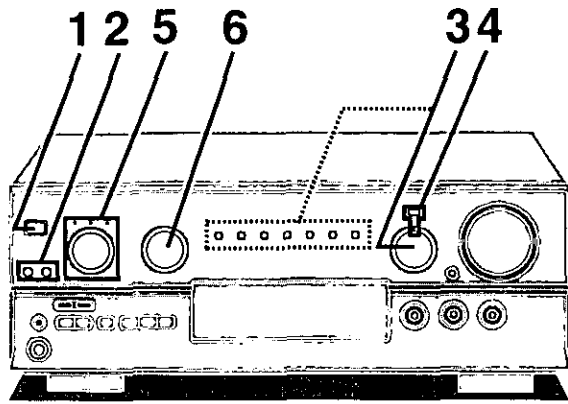

1

POWER



2

A SPEAKERS B

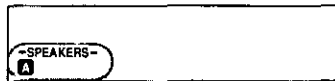
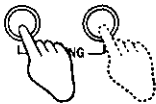

3

INPUT SELECTOR

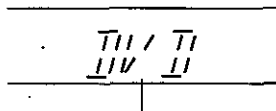

Selected source

4

DIGITAL INPUT

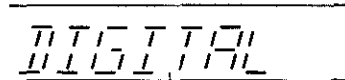
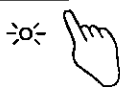

DIGITAL → ANALOG

5

DSP  
STEREO SURROUND SFC

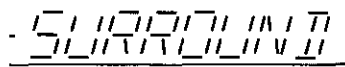

6

SFC MODE

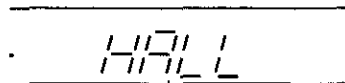
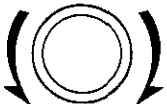

HALL ↔ CLUB ↔ LIVE  
↑ ↓  
SIM SURR ↔ THEATER

1 Press [POWER, ].

2 Press [A] and/or [B] to select the speaker system(s) to be used.

A and B refer to the speaker terminals at the rear of the unit.

"SURROUND" and "SFC" cannot be turned on if [B] is pressed. Press [A] to enjoy these modes.

If the button is pressed once more, the indicator will switch off and no sound will be heard from the speakers.

3 Turn [INPUT SELECTOR] to select desired source.

(Refer to the appropriate operating instructions for details.)

The indicator corresponding to the selected source lights and the source is shown on the display.

**TAPE:** To listen to cassette tapes

**VCR:** To watch video tapes

**TV:** To watch TV

**DVD:** To enjoy DVD

**CD:** To listen to compact discs

**TUNER:** To listen to radio broadcasts

**PHONO:** To listen to phono discs

### Note

To watch a video (or DVD) or the TV, set the TV to either the TV mode or VIDEO mode.

4 (only if you select TV, CD or DVD in the above step) Press [DIGITAL INPUT] to select "DIGITAL" or "ANALOG".

Switches between "DIGITAL" and "ANALOG" each time the button is pressed.

The "DIGITAL INPUT" indicator lights when DIGITAL selected.

5 Turn [DSP] to select the desired mode.

The DSP indicator corresponding to the selected mode lights and that mode is displayed.

### Note

Be sure to select the mode appropriate to the source you are playing (→ Pages 20–21).

Dolby Digital and DTS sources cannot be played with the SFC modes.

6 (only if you select SFC in the above step) Turn [SFC MODE] to select the desired SFC mode.

(continued on next page)

## Enjoying the sounds

**7 Start the source.**

**8 Adjust the volume.**

### While using the SFC modes

#### To adjust speaker level **by remote control only**

- 1 Press [LEVEL] to select the speaker channel to adjust.  
Each time the button is subsequently pressed, the speaker whose level is to be set is selected in the listed sequence.  
C → RS → LS → SW
- 2 Press [-] or [+] to adjust the output level.  
Channels C, RS, LS, and SW can be adjusted between -10 dB and +10 dB.

#### To adjust delay time **by remote control only**

You can adjust surround channel only.

- 1 Press [DELAY].  
When the button is pressed, the current delay time is displayed.
- 2 Press [-] or [+] to set the time.  
Select a delay time to suit your individual needs.  
Delay time can be set at 10 milliseconds (ms) intervals between 10 and 100 ms.  
The factory settings for each mode are 50 ms.

#### For your reference

Settings for volume level and delay time can be done for each SFC mode.

#### When you finish listening

Be sure to reduce the volume, and switch the power to the standby condition by pressing [POWER,  $\text{⏻}$ ].

#### For your reference

- If you are using VCR and you select TAPE, CD, TUNER, or PHONO  
The picture will remain on the screen.
- About DSP mode  
The DSP modes can be set for each source. Once you have set the mode for a source, the mode is engaged whenever that source is selected.  
These modes are automatically switched to STEREO if SPEAKERS B is selected or both speakers are turned off. When SPEAKERS B is turned off or SPEAKERS A is selected, the mode is switched back to the latest mode.
- Only Dolby Digital, DTS or PCM signals (44.1 kHz or 48 kHz) can be reproduced through the digital terminal  
The digital input signal of sampling frequencies 96 kHz and other signal formats such as MPEG cannot be reproduced on this unit.

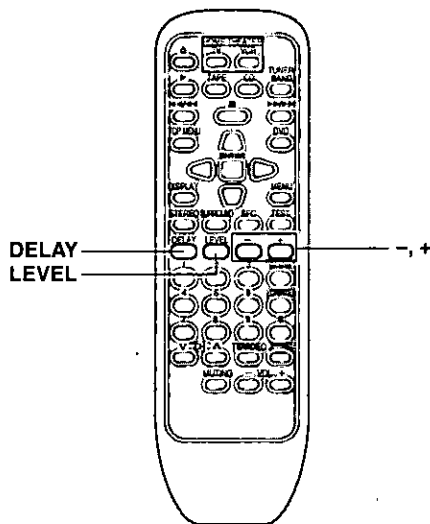
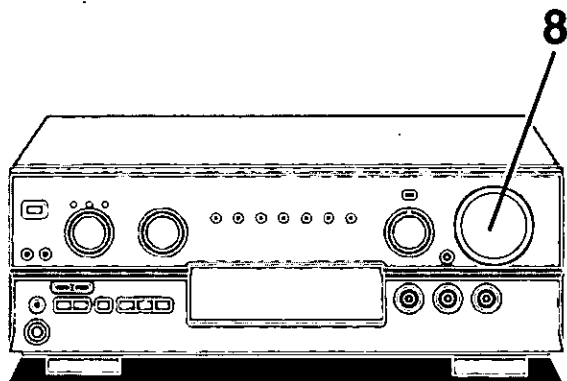

**8**

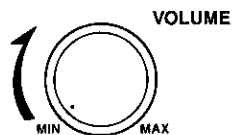

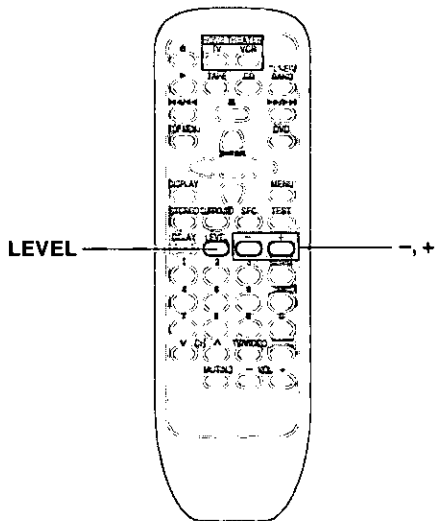
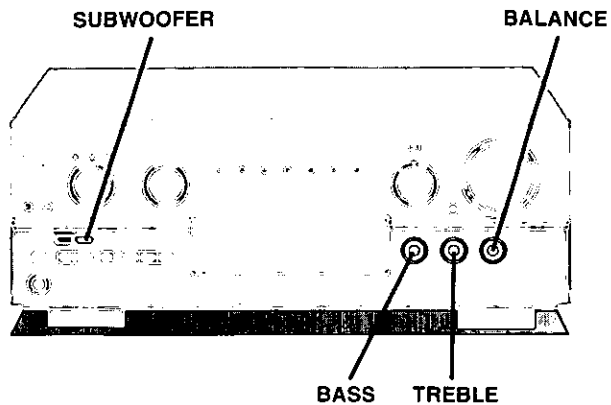

**A To adjust the tone quality**

Turn [BASS] to adjust the low frequency sound.

Turn [TREBLE] to adjust the high frequency sound.

**B To adjust the sound balance**

Turn [BALANCE] to adjust the left/right sound balance.

**C Turning the subwoofer off**

You can turn the subwoofer off when you want to listen to music.

Press [SUBWOOFER] to select "OFF".

(→ Page 18.)

You can also adjust the volume of the subwoofer in STEREO mode.

① Press [LEVEL].

② Press [+] or [-].

The volume can be adjusted between -10 dB and +10 dB.

**A**



**B**



**C**

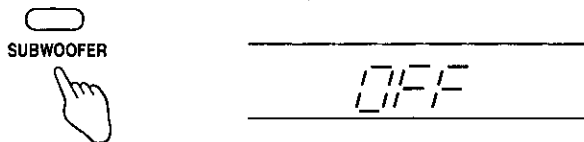



## Enjoying the sounds

### A For front speakers with an impedance under $8\ \Omega$

Press and hold [A] or [B] until "LOW IMP" lights up on the display.

If even one of the speakers being used has an impedance under  $8\ \Omega$ , press and hold down either [A] or [B] for 4 seconds or more to set the impedance on the main unit to LOW.

(Press and hold down once again for 4 seconds or more to turn it off.)

Note that when "LOW IMP" is illuminated, SPEAKERS A and B cannot both be used at the same time.

#### To change speakers:

e.g. To use SPEAKERS B, press [A] ("A" goes out), and then press [B] to activate SPEAKERS B.

### B The TAPE (MONITOR) indicator

This indicator lights in the following two situations:

1. While TAPE is selected.
2. While TAPE MONITOR is in use.

#### To use the tape monitor

(For use when you have connected a graphic equalizer to the TAPE terminals.)

If [TAPE MONITOR] is pressed while a source other than TAPE is selected, the "TAPE (MONITOR)" indicator lights and the tape monitor comes on.

Sources other than tape can still be selected with [INPUT SELECTOR] while the "TAPE (MONITOR)" indicator is on.

Press [TAPE MONITOR] again to turn the tape monitor off.

(➡ See "Making a recording" on page 31 for details on how to use the tape monitor during recording.)

#### Note

- The tape monitor cannot be used when TV, DVD, or CD digital input is being used.
- If you are using the tape monitor and you select a digital input source, the tape monitor switches off.
- Depending on the settings on the graphic equalizer, there may be some distortion.

SPEAKERS A, B

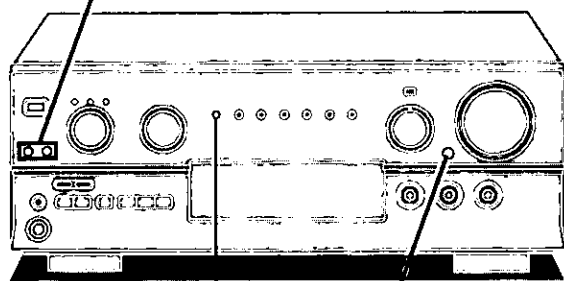

TAPE  
(MONITOR)

TAPE MONITOR

A

A SPEAKERS B



B

TAPE MONITOR



## The radio

### Sequential tuning

Use the tuning buttons to tune-in radio stations.

- 1 Turn [INPUT SELECTOR] to select "TUNER".
- 2 Press [BAND] to select "FM" or "AM".
- 3 Press [TUNING (∨ or ∧)] to tune to the desired frequency.

Tuning interval FM: 0.2 MHz  
AM: 10 kHz

"TUNED" lights up when tuned.

"STEREO" lights up when an FM stereo broadcast is received.

#### To make an automatic search for stations

If [TUNING (∨ or ∧)] is held down for an instant until the frequency begins to scroll, the broadcast stations are tuned in automatically when one is found.

#### Note

Tuning may stop automatically if any jamming is encountered.

#### If noise is excessive in the FM stereo mode

Press [FM MODE].

("STEREO" will go out, and "MONO" will light up).

The broadcast will be monaural, but noise will be reduced.

If the button is pressed once more, the stereo mode resumes.

#### If there is hissing or thumping while the radio is playing

Press and hold [-DSP ON/DEFEAT] to select "DEFEAT".

(→ Page 21 for details about DSP DEFEAT.)

#### For your reference

The tuner can pick up interference from DVD players. If this occurs turn the DVD player off.

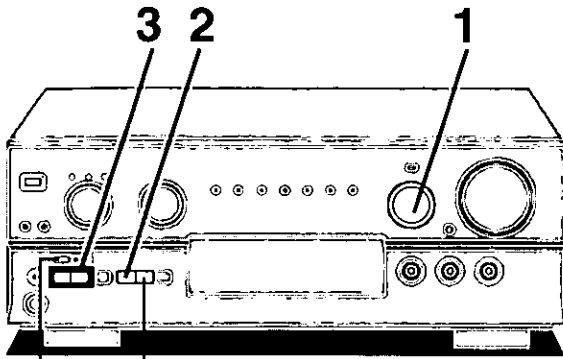

-DSP ON/DEFEAT FM MODE

#### 1 INPUT SELECTOR



TUNER

#### 2



FM 87.9 MHz

Selected band

#### 3

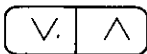

TUNING

TUNED  
STEREO  
-SPEAKERS-  
FM 88.1 MHz

## Direct tuning

by remote control only

Specify the frequency using the numbered buttons on the remote control to directly tune to the station.

### 1 Press [TUNER/BAND].

This will set the remote control to operate the tuner. The selector on the receiver will change to "TUNER". Each time the button is pressed, the band will change as follows,  
FM ⇌ AM.

### 2 Press [DIRECT TUNING/DISC ENTER].

### 3 While cursor display is flashing (approx. 10 seconds) Press the numbered buttons to enter the frequency.

Tuning interval FM: 0.1 MHz  
AM: 10 kHz

If the desired FM frequency is 107.9 MHz, press  
[1]→[0]→[7]→[9].

If the frequency has been input correctly, the displayed frequency will blink once.

#### Note

1. If no button is pressed while the cursor display is flashing, the display will return to the frequency which is currently being received.  
To re-specify the frequency, repeat the procedure from step 2.
2. If the frequency has not been input correctly, "ERROR" will be displayed.  
In this case, re-enter the frequency.

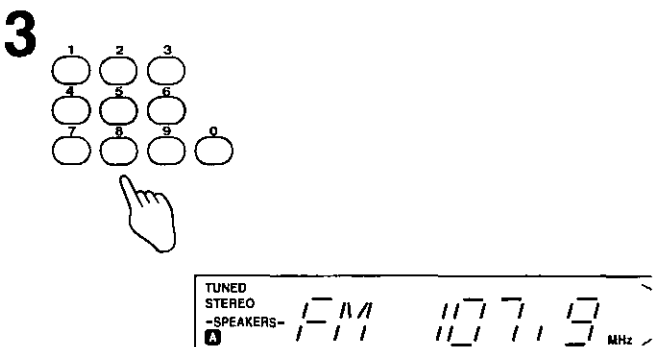
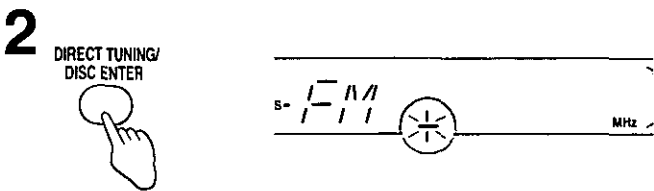
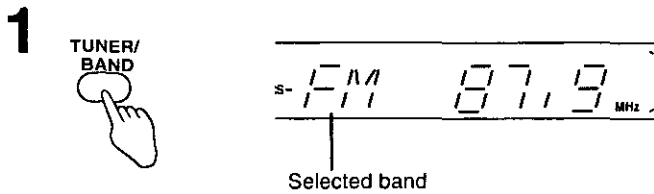
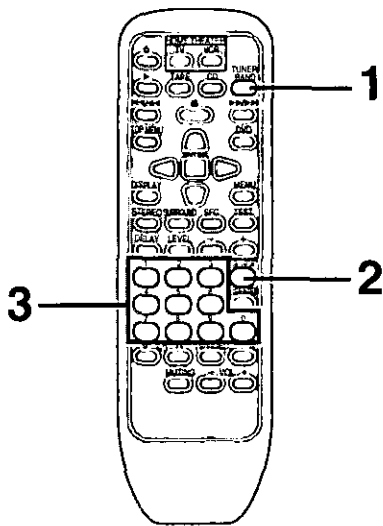

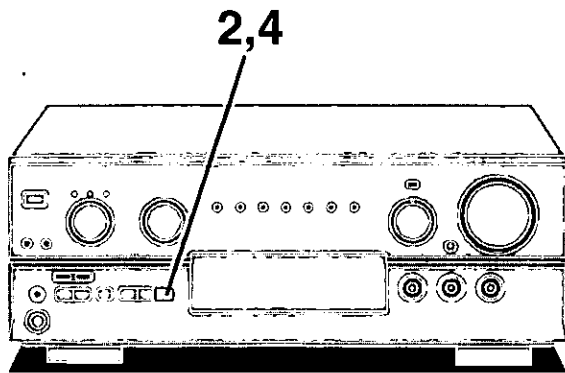

## Preset tuning

Presetting radio stations into the memory channels of this unit makes selecting stations simple.

A total of 30 FM and AM stations can be preset.

### Please remember this

If a new station is preset into a channel, the setting for the station which was previously entered in that channel will be automatically erased.

### Automatic memory presetting

Automatic memory presetting allows this unit to search for stations and then preset them into memory.

2

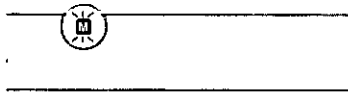

4



A

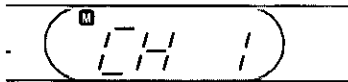

### 1 Tune to the lowest frequency in FM.

(→ Pages 26–27.)

### 2 Press and hold [MEMORY].

Automatic memory presetting will start.

All the FM stations the unit can receive are preset in channels 1 to 30.

### 3 Tune to the lowest frequency in AM.

(→ Pages 26–27.)

### 4 Press and hold [MEMORY].

Automatic memory presetting will start.

All the AM stations the unit can receive are preset in channels 21 to 30. (Any FM stations in these channels will be replaced.)

During automatic memory presetting, the memory indicator will flash while the frequency scrolls.

#### When a station is preset

The memory indicator and the preset channel number will be displayed for approximately 1 second. (A)

#### When presetting is completed

The last station to be preset will be displayed.

#### Note

Frequencies may not be preset correctly in cases where the broadcast waves are too strong or too weak. In such cases, carry out presetting manually (→ Page 29).

## The radio

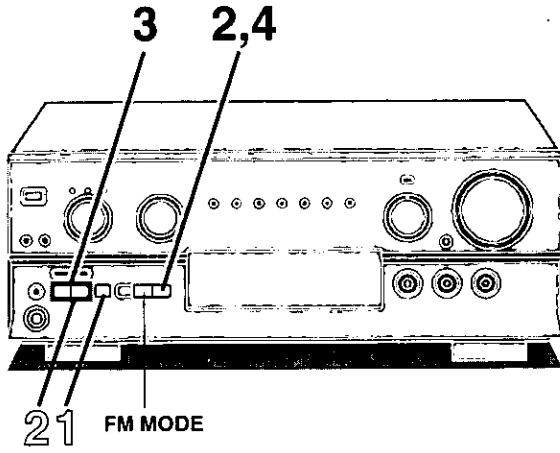

### A

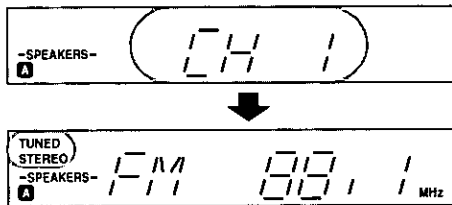
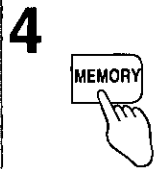
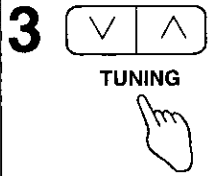
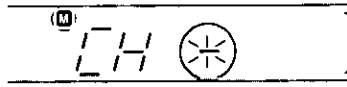

### B

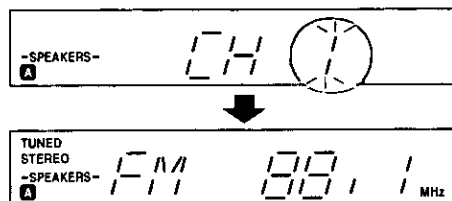
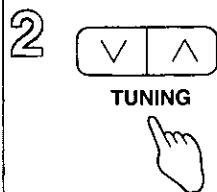

### A Manual memory presetting

The desired stations can be preset into the desired channels by the user.

#### 1 Set to the desired frequency.

(→ Pages 26–27.)

If interference or static is keeping you from enjoying an FM broadcast, press [FM MODE] and change to monaural. You can preset the station in monaural just as in stereo.

#### 2 Press [MEMORY].

To cancel the memory function, press [MEMORY] again.

#### 3 Press [TUNING (∇ or ▲)] to select the desired channel.

Holding the buttons down lets you scroll through channels faster.

#### 4 Press [MEMORY].

The channel will blink on the display.

#### To continue presetting

Repeat steps 1 through 4.

### B To listen to preset channels

#### 1 Press [PRESET].

#### 2 Press [TUNING (∇ or ▲)].

Holding down the buttons lets you scroll through channels faster.

The channel number flashes for approximately 5 seconds. Select the desired channel number during that time. After 5 seconds, the display will change from the channel number to the frequency.

#### Note

If you press [PRESET] while the channel number is displayed, the display will change to the frequency.

#### To confirm the channel number of the station being received

Press [PRESET].

(The channel number flashes for approximately 5 second.)

#### Note

The channel number is not displayed if you change the frequency or FM mode setting.

#### For your reference

Even if the power supply cord is disconnected from the household AC outlet, the memory will retain its contents for approximately one month.

#### If frequency presettings are accidentally erased

Program the presettings once again.

The power supply cord should remain connected for one hour or more for the memory back-up to be effective.

## Other functions

### A To mute the sound level

by remote control only

Press [MUTING].

The message "MUTING ON NOW" runs repeatedly from right to left across the display as long as the muting function is on.

Press once again to return to the previous volume level.

#### Note

Muting is cancelled when the receiver is turned off.

### B To listen through headphones

- ① Reduce the volume.
- ② Connect the headphones.  
Plug type: 6.3 mm (1/4 in.) stereo
- ③ Adjust the volume.

Select STEREO or turn SPEAKERS A and B off when using headphones. Turning the speakers off automatically engages STEREO mode and ensures no sound is heard from the subwoofer. If SURROUND is used, the sound heard through the headphones will seem unusual.

#### Note

Avoid listening for prolonged periods of time to prevent hearing damage.

### C Dynamic range compression

"Dynamic range compression" (DR COMP) is a function for compressing the dynamic range (reproduction level range) of audio signals. It is used for viewing movie software late at night or at other times when high volume levels are not desirable.

This function only works with DR COMP compatible Dolby Digital format software.

The factory setting is "OFF".

- ① Press [A] and [B] at the same time.

"SETTING" appears on the display.

- ② Press [A] to select "DR COMP".

Each time the button is pressed the display switches as follows.

SIZE → DISTANCE → FILTER → DR COMP

- ③ Turn [SFC MODE] to select the setting.

Each time the selector is turned the display switches as follows.

OFF → STANDARD → MAX

- ④ Press [A] and [B].

"COMPLETE" appears on the display.

#### For your reference

When DR COMP is on, scenes that already have a low sound level will be heard as they are. When scenes that are loud occur, the function acts to reduce the peak level.

The sound field will remain intact even if DR COMP is functioning.

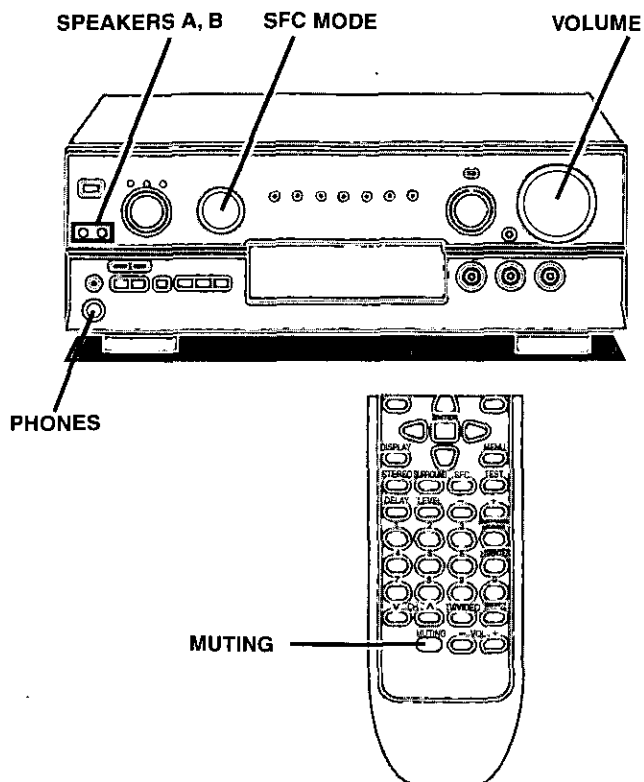

**A**

MUTING

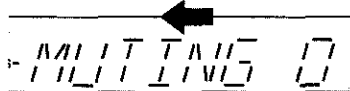

**B**

①

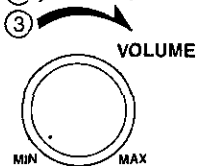

② PHONES

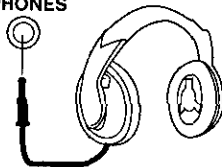

Headphones (not included)

**C**

①

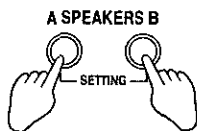

②

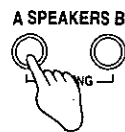

③

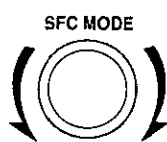

④

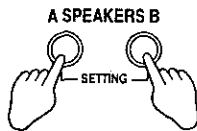

## Making a recording

### Note

- You cannot record a source connected through a digital terminal.
- When recording CD, DVD, or TV, ensure the source is connected through the corresponding analog terminals (→ pages 10–11) and "ANALOG" input is selected (→ page 22).

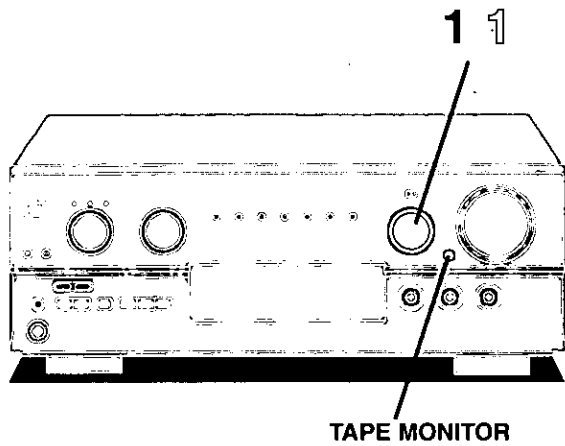

### A Recording on a tape deck

Before recording, prepare the tape deck.  
See the tape deck's operating instructions for details.

#### 1 Turn [INPUT SELECTOR] to select the source to be recorded.

Any source can be selected except TAPE.

#### 2 Begin recording on the tape deck.

Follow your tape deck's operating instructions.

#### 3 Begin the source to be recorded.

Follow your equipment's operating instructions.

### B To monitor the recorded sound

It is possible to check the sound being recorded if your tape deck is a 3 head system.

**Press [TAPE MONITOR] on this unit and set the monitor button on the tape deck to "TAPE".**

Press [TAPE MONITOR] once again to turn it off.

### C Recording on a VCR

Before recording, prepare the VCR.  
See the VCR's operating instructions for details.

#### 1 Turn [INPUT SELECTOR] to select the source to be recorded.

Any source can be selected except VCR and TAPE.

### Note

Recording from the tape deck is not possible.

#### 2 Begin recording on the VCR.

Follow your VCR's operating instructions.

#### 3 Begin the source to be recorded.

Follow your equipment's operating instructions.

### A

#### 1

INPUT SELECTOR



### B

TAPE MONITOR



### C

#### 1

INPUT SELECTOR



# The remote control

This remote control can be used to operate this unit and some other Panasonic and Technics cassette decks, CD players, TVs, VCRs and DVD players, provided they are equipped with a remote control sensor.

It is also possible to change-over the remote control code so that the remote control can operate TVs and VCRs which have not been manufactured by this company (⇒ page 38).

## To operate the receiver

Point the remote control toward the receiver

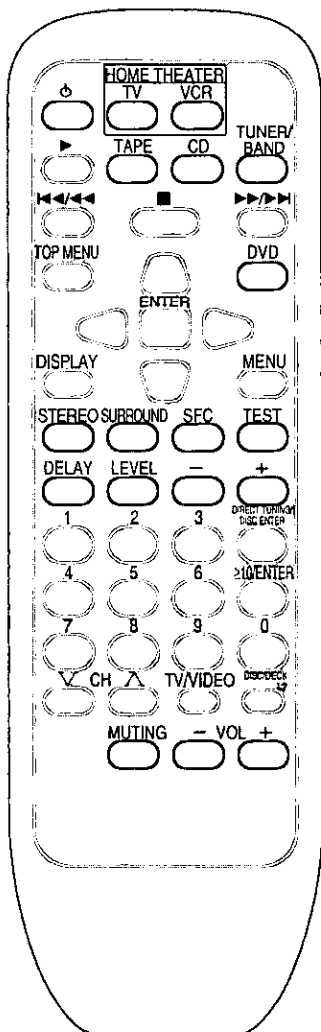











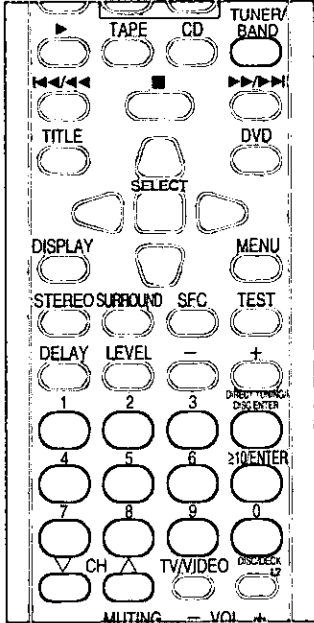

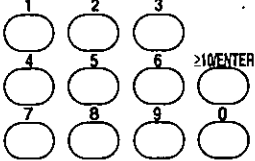

### Basic operations

<p>To turn the unit ON/OFF</p>	<p>TUNER/BAND → </p>
<p>To select an input source and switch the remote control to each operation mode</p>	<p>TAPE VCR TV DVD CD TUNER/BAND</p> <p><b>Note</b></p> <ul style="list-style-type: none"> <li>• PHONO can not be selected with this remote control.</li> <li>• TAPE MONITOR cannot be controlled with the [TAPE] button.</li> </ul>
<p>To turn on the STEREO mode</p>	<p>STEREO </p>
<p>To turn on the SURROUND mode</p>	<p>SURROUND </p>
<p>To turn SFC on and select the mode</p>	<p>SFC </p> <p>Changes as follows each time the button is pressed.</p> <p>HALL → CLUB → LIVE → THEATER</p> <p>└ SIM SURR (SIMULATED) ┘</p>
<p>To output a test signal</p>	<p>TEST </p> <p>Press once more to stop the test signal.</p>
<p>To select the speaker channel and adjust its output level</p>	<p>LEVEL →  </p> <p><b>When the SURROUND or SFC modes are on</b> You can adjust the level of the center and surround speakers and the subwoofer.</p> <p><b>When the STEREO mode is on</b> You can adjust the level of the subwoofer.</p>
<p>To change the surround channel delay time</p>	<p>When the SFC modes are on</p> <p>DELAY →  </p>
<p>To mute the sound level</p>	<p>MUTING </p> <p>The message "MUTING ON NOW" runs repeatedly from right to left across the display as long as the muting function is on. Press once more to return to the original volume.</p>
<p>To adjust the volume</p>	<p> VOL </p>

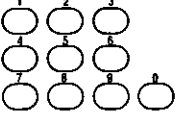

## To operate the receiver (continued)

Make sure the remote control is in the tuner operation mode (⇒ Page 32).







<p>Point the remote control toward the receiver</p>  	<p><b>To listen to radio broadcasts</b></p>
	<p><b>To select "FM" or "AM"</b></p> <p>TUNER/BAND  Changes as follows each time the button is pressed. FM ↔ AM</p>
	<p><b>To select the desired channel sequentially (Preset tuning)</b></p> <p> </p>
<p><b>To select the desired channel directly (Preset tuning)</b></p>	<p>  (Example: Channel 1)  (Example: Channel 10)  →  →  within 10 seconds</p>
<p><b>To select radio stations by frequency (Direct tuning)</b></p>	<p> →  (Example: 107.9MHz)  →  →  →  within 10 seconds</p>

## To operate a cassette deck

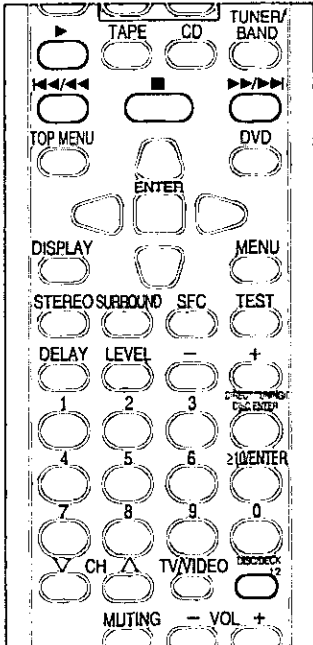
Turn the cassette deck ON before trying to operate it by remote control.

Make sure the remote control is in the cassette deck operation mode (⇒ Page 32).

It may not be possible to operate some cassette decks with this unit.

<p>Point the remote control toward the cassette deck</p>  	<p>Only when using a double cassette deck</p> <p><b>To select the tape deck (DECK 1/DECK 2)</b></p> <p>DISC/DECK </p>
	<p><b>To start playback</b></p> <p></p>
	<p><b>To fast-forward or rewind the tape</b></p> <p>While the tape is stopped</p> <p> </p> <p>With TPS-equipped cassette decks, you can move to the beginning or end of a track by pressing these buttons while the tape is playing.</p>
	<p><b>To stop playback</b></p> <p></p>

## To operate a CD player

Turn the CD player ON before trying to operate it by remote control.

**Make sure the remote control is in the CD player operation mode.** (⇒ Page 32.)

It may not be possible to operate some CD players with this unit.

Point the remote control toward the CD player

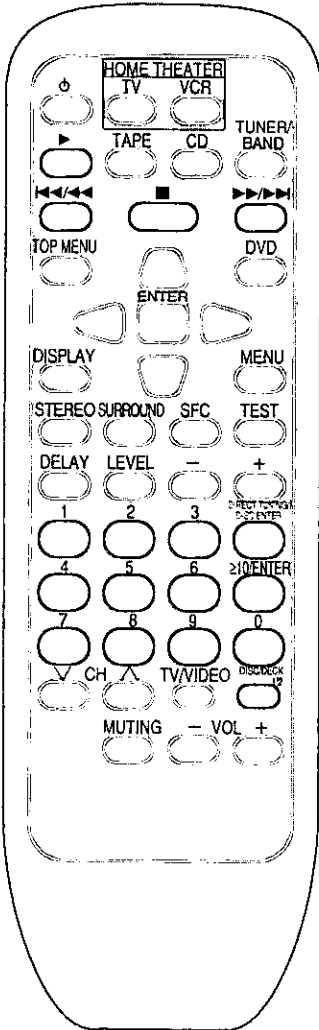

To start play



For 5 CD changer

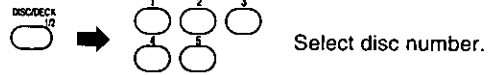

For MEGA CD changer ※

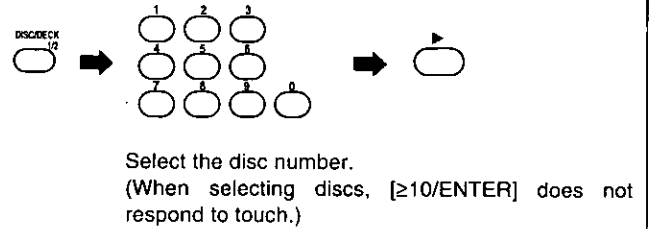

For your reference

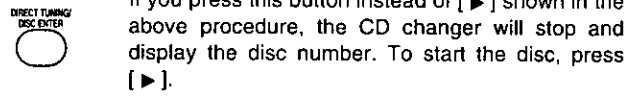

[CD changer only]  
To start play from the desired disc

To start play from the desired track

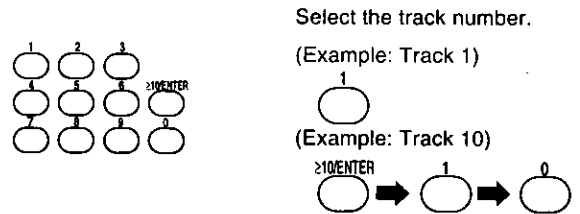

To skip a track



To stop play



# To watch TV broadcasts

The procedures below are examples for when a TV and VCR are connected to the receiver as shown in this manual. This remote control is designed for use with a home theater system. If you press [TV] (or [VCR]) and [⏻] in succession, the TV (or VCR) and receiver will be turned on and the selector on the receiver will change to TV (or VCR). Press [⏻] within 3 seconds of pressing [TV] (or [VCR]).

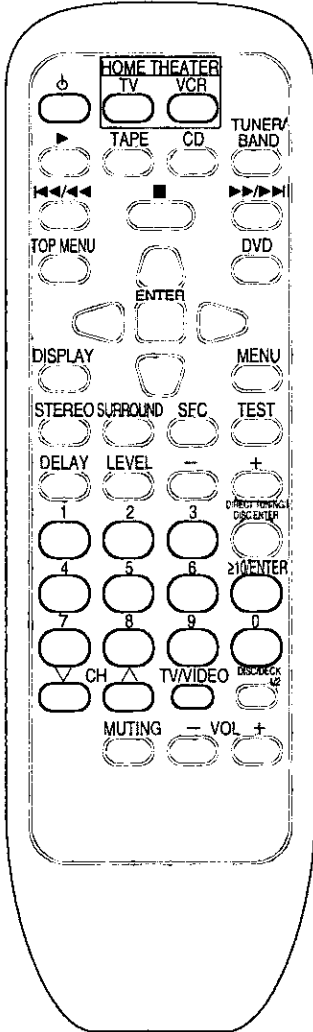

## To watch TV broadcasts

Point the remote control toward the TV and the receiver



Switch ON the TV and the receiver.

The receiver will switch to TV input.

Point the remote control toward the TV



Set the TV/VIDEO mode on the TV to "TV".

Point the remote control toward the TV

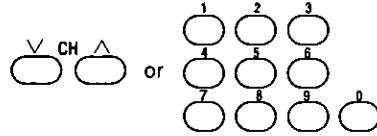

Select the desired channel.

### Note

If you allow more than 3 seconds to pass between pressing [TV] and [⏻], only the TV will be operated.

Do not use this remote control to turn the TV ON and OFF if you are not using the receiver.

## To watch TV broadcasts with a VCR tuner

Point the remote control toward the TV and the receiver



Switch ON the TV and the receiver.

Point the remote control toward the VCR and the receiver



Switch ON the VCR.

The receiver will switch to VCR input.

Set the input selector on the VCR to the "TUNER" position

Point the remote control toward the VCR

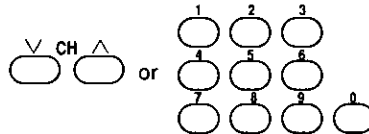

Select the desired channel.

Point the remote control toward the TV



Set the TV/VIDEO mode on the TV to "VIDEO".

### Note

If you allow more than 3 seconds to pass between pressing [VCR] and [⏻], only the VCR will be operated.

Do not use this remote control to turn the VCR ON and OFF if you are not using the receiver.

## To switch OFF the TV



## To switch OFF the VCR



### Note

Turn the receiver OFF last.



This button is used when using ENTER to select a channel on a TV or VCR which has not been manufactured by this company.

**To watch video tapes**

The procedures below are examples for when a TV and VCR are connected to the receiver as shown in this manual.

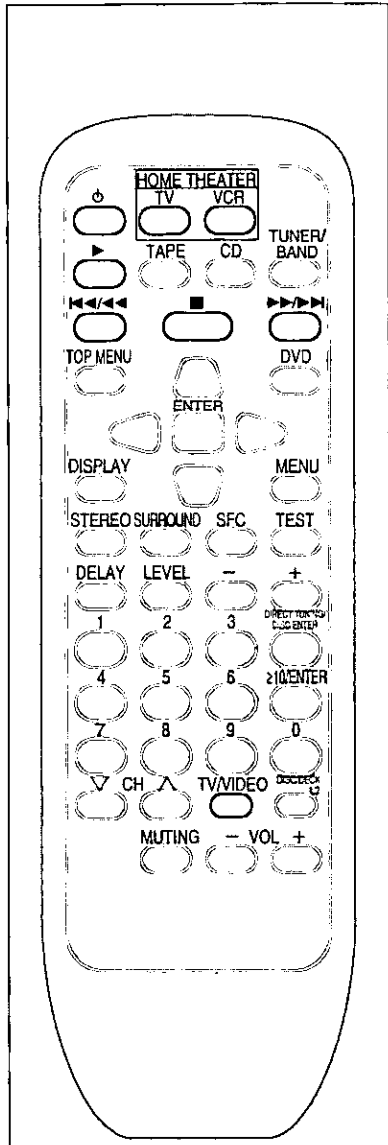

**To watch video tapes**

<p>Point the remote control toward the TV and the receiver</p> <p>TV → [TV] → [TV]</p> <p>Switch ON the TV and the receiver.</p>	<p>Point the remote control toward the VCR and the receiver</p> <p>VCR → [VCR] → [TV]</p> <p>Switch ON the VCR.</p> <p>The receiver will switch to VCR input.</p>	<p>Point the remote control toward the TV</p> <p>[TV/VIDEO]</p> <p>Set the TV/VIDEO mode on the TV to "VIDEO".</p> <p>Point the remote control toward the VCR</p> <p>[▶]</p> <p>Playback will begin.</p>
--	---	--

<p><b>To fast-forward or rewind the video tape</b></p>	<p>In the stop mode</p> <p>[VCR] → [◀▶] [▶▶▶]</p>
--	---

<p><b>To stop playback</b></p>	<p>[VCR] → [■]</p>
--------------------------------	--------------------

**To switch OFF the TV**

[TV] → [⏻]

**To switch OFF the VCR**

[VCR] → [⏻]

**Note**  
Turn the receiver OFF last.

# To operate a DVD player

The procedures below are examples for when a TV and DVD player are connected to the receiver as shown in this manual. **Make sure the remote control is in the DVD player operation mode.** (→ Page 32.) Actual operations depend on your equipment and software.

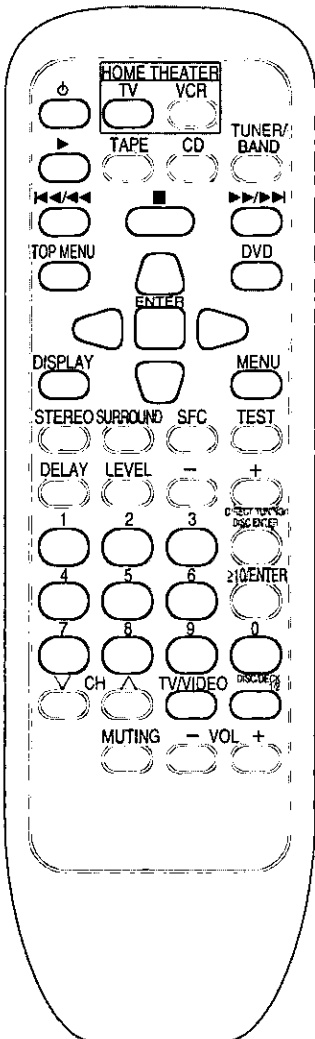

## To enjoy DVDs

Point the remote control toward the TV and the receiver



Switch ON the TV and the receiver.

Point the remote control toward the DVD player and receiver



Switch ON the DVD player. The receiver will switch to DVD input.

Point the remote control toward the TV



Set the TV/VIDEO mode on the TV to "VIDEO".

Point the remote control toward the DVD player.



Play will begin.

[DVD changer only]  
To start play from the desired disc

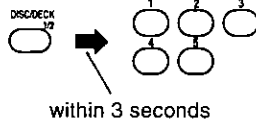

Select disc number.

To select the top menu

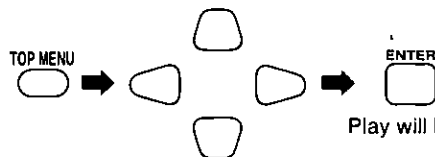

Play will begin.

To use the menu

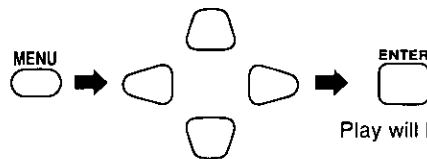

Play will begin.

To use on-screen graphic controls  
(Graphic user interfaces, GUI, are a feature of some DVD players. See your player's manual for details.)

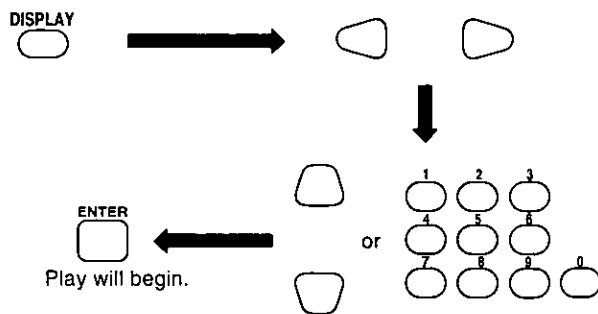

Play will begin.

To skip to the beginning of a track or chapter



To stop play



To switch OFF the TV



To switch OFF the DVD player



**Note**

Turn the receiver OFF last.

## Changing the remote control code

Change the remote control code in either of the following circumstances:

- If the Panasonic TV or VCR does not operate as a result of a difference in the remote control code.
  - If you wish to operate some other make of TV or VCR.
- (→ Refer to pages 35 and 36 for the buttons which can be used.)

### Note

Even after changing the code there may be cases where certain operations cannot be done or operation is not possible at all.

### How to change the remote control code

TV    VCR

**Hold down the button corresponding to the component you wish to operate.**

**Continue to hold the button down and...**

**Aim the remote control at the component you wish to operate and carefully and slowly press the numbered buttons to enter the appropriate two-digit code number.**

(Refer to the table below for the code number.)

When the two-digit code number is entered, the remote control will automatically output the on/off signal.

If the remote control has been correctly changed to the code for the component to be operated, the component will be switched ON or OFF.

**Note**

If there is more than one code number indicated in the code table, repeat the above procedure until you find a code number for which the power of the component is switched ON or OFF.

TV				VCR			
Manufacturer	Code No.	Manufacturer	Code No.	Manufacturer	Code No.	Manufacturer	Code No.
Panasonic	01,02,20	RCA	03,07,09,13,23,24,25	Panasonic	01,02,09,33	Philips	02,09,12
Sony	04	Sanyo	14	Sony	05,06,07,35,36,37	Pioneer	09
Fisher	14	Sharp	08,21	Fisher	13,14,15,18	Quasar	01,02,09,33
G-E	02,03,07,09	Sylvania	06,07,15	Funai	08,30	RCA	02,03,04,09,10,11,12,23,24,26
Gold Star	07,15	Symphonic	17	G-E	02,03,11	Sanyo	14,18
Hitachi	05,07	Toshiba	10,21	Gold Star	27	Sharp	16,17
JVC	12	Zenith	18,26	Hitachi	09,10,11	Shintom	32
LXI	03,06,07,10,14,15			JVC	19,25,31,38,39,40	Sylvania	02,09,12,30
Magnavox	06,07,11,15,22			LXI	10,13,14,15,18,27,30	Symphonic	30
Mitsubishi	07,15,16,21			Magnavox	02,09,12	Toshiba	23,24
NEC	07,15			Mitsubishi	21,22,28,29	Zenith	20
Philco	06,07			NEC	19,25,31,38		
Philips	06			Philco	02,09,12,30		
Pioneer	02,10,19						
Quasar	02						

### Note

Changes to the codes are cancelled when the remote control's batteries are replaced. Repeat the above operation to reenter the code.

## About the HELP function

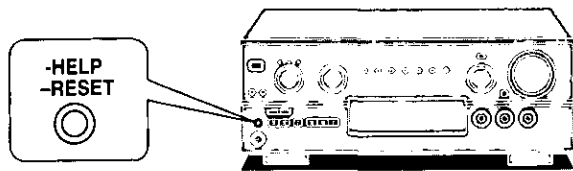

If you make a mistake in operation or if sound output stops due to some operation which was performed, the HELP function displays information which can be useful for indicating the method by which this condition can be remedied.

If "ERROR" or scrolling characters (for instance, "SPEAKER OFF NOW") appear on the display during operation, carry out the following operation.

### **Press [-HELP, -RESET].**

The method for remedying this situation will be displayed.

### **For your reference**

If the above button is pressed for 2 seconds or more until "RESET" appears on the display, the operation settings for the unit will be initialized to the settings made at the time of shipment.

However, any stations which have been preset into memory will not be erased at this time.

## Listening caution



Selecting fine audio equipment such as the unit you've just purchased is only the start of your musical enjoyment. Now it's time to consider how you can maximize the fun and excitement your equipment offers. This manufacturer and the Electronic Industries Association's Consumer Electronics Group want you to get the most out of your equipment by playing it at a safe level. One that lets the sound come through loud and clear without annoying blaring or distortion—and, most importantly, without affecting your sensitive hearing.

We recommend you to avoid prolonged exposure to excessive noise.

Sound can be deceiving. Over time your hearing "comfort level" adapts to higher volumes of sound. So what sounds "normal" can actually be loud and harmful to your hearing.

Guard against this by setting your equipment at a safe level **BEFORE** your hearing adapts.

To establish a safe level:

- Start your volume control at a low setting.
- Slowly increase the sound until you can hear it comfortably and clearly, and without distortion.

Once you have established a comfortable sound level:

- Set the dial and leave it there.

Taking a minute to do this now will help to prevent hearing damage or loss in the future. After all, we want you listening for a lifetime.

## Maintenance

### If the surfaces are dirty

To clean this unit, wipe with a soft, dry cloth.

If the surfaces are extremely dirty, use a soft cloth dipped in a soap-and-water solution or a weak detergent solution.

- Never use alcohol, paint thinner or benzine to clean this unit.
- Before using chemically treated cloth, read the instructions that came with the cloth carefully.

## Product Service

Do not attempt to remove the cover(s) or repair the unit yourself. Refer servicing to qualified personnel only.

### Product information

For product service, product information or assistance with product operation, refer to the servicenter directory.



# Specifications (IHF'78)

## ■ AMPLIFIER SECTION

<b>Rated minimum sine wave RMS power output</b>	
20 Hz–20 kHz both channels driven	100 W per channel (8 Ω)
0.05 % total harmonic distortion	
1 kHz continuous power output both channels driven	
0.05 % total harmonic distortion	105 W per channel (8 Ω)
<b>Total harmonic distortion</b>	
rated power at 20 Hz–20 kHz	0.05 % (8 Ω)
half power at 1 kHz	0.03 % (8 Ω)
<b>Power output at 1 kHz each channel driven</b>	
0.9 % total harmonic distortion	
Front	2 x 100 W (8 Ω)
Center	100 W (8 Ω)
Surround	2 x 100 W (8 Ω)
<b>Low frequency damping factor</b>	
	30 (8 Ω)
<b>Load impedance</b>	
Front	
A or B	4–8 Ω
A and B	8 Ω
Center	8 Ω
Surround	8 Ω
<b>Dynamic headroom</b>	
	2 dB (8 Ω)
<b>Frequency response</b>	
PHONO	RIAA standard curve ±0.8 dB
CD, TAPE, DVD, TV, VCR	10 Hz–70 kHz, ±3 dB
<b>Input sensitivity</b>	
PHONO	0.4 mV (3 mV, IHF '66)
CD, TAPE, DVD, TV, VCR	27 mV (200 mV, IHF '66)
<b>S/N (IHF A)</b>	
PHONO	70 dB (80 dB, IHF '66)
CD, TAPE, DVD, TV, VCR	75 dB (85 dB, IHF '66)
<b>Input impedance</b>	
PHONO	47 kΩ
CD, TAPE, DVD, TV, VCR	22 kΩ
<b>Tone controls</b>	
BASS	50 Hz, +10 to –10 dB
TREBLE	20 kHz, +10 to –10 dB
<b>Subwoofer frequency response (–6 dB)</b>	
	7–200 Hz

Digital input	
Optical	CD, DVD, TV

## ■ FM TUNER SECTION

Frequency range	87.9–107.9 MHz
Sensitivity	11.2 dBf (2 μV, IHF '58)
50 dB quieting sensitivity	
MONO	18.3 dBf (4.5 μV, IHF '58)
STEREO	38.3 dBf (45 μV, IHF '58)
<b>Total harmonic distortion</b>	
MONO	0.2 %
STEREO	0.3 %
<b>S/N</b>	
MONO	73 dB
STEREO	67 dB
Frequency response	20 Hz–15 kHz, +1 dB, –2 dB
Alternate channel selectivity	65 dB
Capture ratio	1.5 dB
Image rejection at 98 MHz	40 dB
Spurious response rejection at 98 MHz	75 dB
AM suppression	50 dB
<b>Stereo separation</b>	
1 kHz	40 dB
10 kHz	30 dB
Antenna terminal	75 Ω (unbalanced)

## ■ AM TUNER SECTION

Frequency range	530–1710 kHz
Sensitivity	20 μV, 330 μV/m
Selectivity	55 dB
IF rejection at 1000 kHz	50 dB

## ■ VIDEO SECTION

Output voltage at 1 V input (unbalanced)	1±0.1 Vp-p
Maximum input voltage	1.5 Vp-p
Input/output impedance	75 Ω

## ■ GENERAL

Power supply	AC 120 V, 60 Hz
Power consumption	380 VA, 290 W
Dimensions (W x H x D)	430 x 158 x 320.5 mm (16-15/16" x 6-7/32" x 12-5/8")
Mass	9.6 kg (21.3 lb.)

Power consumption in standby mode:	1 W
------------------------------------	-----

### Notes:

- Specifications are subject to change without notice. Mass and dimensions are approximate.
- Total harmonic distortion is measured by the digital spectrum analyzer.

# Troubleshooting guide

Before requesting service for this unit, check the chart below for a possible cause of the problem you are experiencing. Some simple checks or a minor adjustment on your part may eliminate the problem and restore proper operation.

If you are in doubt about some of the check points, or if the remedies indicated in the chart do not solve the problem, refer to the directory of Authorized Service Centers to locate a convenient service center, or consult your dealer for instructions.

*For detailed instructions, contact an authorized servicenter in the U.S.A. and Panasonic Canada Inc. Customer Care Centre in Canada.*

*In the U.S.A. 1-800-211-7262 or web site (<http://www.panasonic.com>)*

*In Canada 905-624-5505 or web site ([www.panasonic.ca](http://www.panasonic.ca))*

Problem	Probable cause(s)	Suggested remedy	Page(s)
<b>While listening to FM broadcasts</b>			
Hiss is heard during stereo broadcasts, but not during monaural ones.	Modulation for the two types is different so some noise may be heard during stereo broadcasts.	<ul style="list-style-type: none"> <li>• Reduce the treble.</li> <li>• Change the location and direction of the antenna.</li> </ul>	24 12
	Antenna location and direction poor.	<ul style="list-style-type: none"> <li>• Use an outdoor antenna.</li> <li>• Use an antenna with more elements.</li> </ul>	12 -
Excessive noise in both stereo and monaural broadcasts.	Station is distant.		
	DSP is on.	<ul style="list-style-type: none"> <li>• Select "DSP DEFEAT".</li> </ul>	21
"STEREO" and "TUNED" indicators flicker.	Antenna location and direction poor.	<ul style="list-style-type: none"> <li>• Change the location and direction of the antenna.</li> </ul>	12
	Station is distant.	<ul style="list-style-type: none"> <li>• Use an outdoor antenna.</li> <li>• Use an antenna with more elements.</li> </ul>	12 -
Stereo broadcasts highly distorted.	Building or mountain nearby.		-

<b>While listening to AM broadcasts</b>			
Unusual "beat" sound is heard.	A television is on nearby.	<ul style="list-style-type: none"> <li>• Separate the two or turn the television off.</li> </ul>	-
	Adjacent signal is interfering.	<ul style="list-style-type: none"> <li>• Reduce the treble.</li> </ul>	24
	DSP is on.	<ul style="list-style-type: none"> <li>• Select "DSP DEFEAT".</li> </ul>	21
Low-pitched "hum" is heard when a station is tuned.	Power cord is near the antenna wires.	<ul style="list-style-type: none"> <li>• Separate the power cord from the wires.</li> </ul>	-
	Electronic interference from the power cord is fed to the speakers.	<ul style="list-style-type: none"> <li>• Use an outdoor antenna.</li> </ul>	12
A continuous or intermittent hiss is heard.	Interference from other appliances.	<ul style="list-style-type: none"> <li>• Separate this unit from such appliances.</li> </ul>	-

<b>While enjoying the surround modes</b>			
Sound is not heard from the center, surround or subwoofer speakers.	The presence setting of the speaker has been incorrectly set to "NONE" or "OFF".	<ul style="list-style-type: none"> <li>• Set the type and presence setting of each speaker correctly.</li> </ul>	17, 18
	The DSP mode has been incorrectly set to "STEREO".	<ul style="list-style-type: none"> <li>• Set to SURROUND mode.</li> </ul>	20
SURROUND and SFC cannot be selected.	DSP is off.	<ul style="list-style-type: none"> <li>• Select "DSP ON".</li> </ul>	21
	SPEAKERS B is on.	<ul style="list-style-type: none"> <li>• Turns SPEAKERS B off.</li> </ul>	22
Cannot play Dolby Digital or DTS sources.	The PCM FIX mode may be on.	<ul style="list-style-type: none"> <li>• Turn PCM FIX mode off.</li> </ul>	21
	An SFC mode is on.	<ul style="list-style-type: none"> <li>• Switch to SURROUND or STEREO mode.</li> </ul>	20

Problem	Probable cause(s)	Suggested remedy	Page(s)
<b>Common Problems</b>			
Unit doesn't come on.	The power cord plug is not fully inserted.	<ul style="list-style-type: none"> <li>• Confirm the plug is fully inserted.</li> </ul>	-
Sound is not heard.	The speaker indicators are off.	<ul style="list-style-type: none"> <li>• Turn on the speaker indicators.</li> </ul>	22
	The tape monitor function is on.	<ul style="list-style-type: none"> <li>• Press the tape monitor button.</li> </ul>	25
	The muting function is on.	<ul style="list-style-type: none"> <li>• Press the muting button on the remote control.</li> </ul>	30
	Incomplete or incorrect connection to speakers and external equipment.	<ul style="list-style-type: none"> <li>• Check all connections.</li> </ul>	10-15
	The incorrect input source has been selected.	<ul style="list-style-type: none"> <li>• Select the correct source.</li> </ul>	22
	Digital signals this unit cannot decode are being played.	<ul style="list-style-type: none"> <li>• Either have the player convert the signals so this unit can handle them or switch to ANALOG input.</li> </ul>	22-23
Cannot play CD, DVD, or TV.	The DIGITAL input mode is set to DIGITAL or ANALOG.	<ul style="list-style-type: none"> <li>• Change the setting to suit the type of connection you have made.</li> </ul>	22
Sound suddenly stops or none is heard when the unit is switched on. "OVERLOAD" appears on the display.	The protection circuitry has functioned because: the positive and negative speaker wires have shorted; speakers with a lower impedance than this unit's rated impedance are being used; the speakers are under strain through excessive volume, excessive power, or by being used in a high temperature environment.	<ul style="list-style-type: none"> <li>• Switch off the unit, determine and correct the cause, then switch the unit on.</li> <li>• Use speakers with the right impedance rating.</li> </ul>	- 14-15
"F70" appears on the display.		<ul style="list-style-type: none"> <li>• Turn off the power and then turn it on again, or disconnect the AC power supply cord and then connect it to your household AC outlet again. (If "F70" remains on the display, consult an authorized service center or your dealer.)</li> </ul>	-

**Panasonic**

**Technics**

**Quasar**

*For Product Information, Operating Assistance, Literature Request, Dealer Locations, and all Customer Service inquiries please contact:  
1-800-211-PANA (7262), Monday-Friday 9 am-9 pm; Saturday-Sunday 9 am-7 pm, EST.*

*Web Site: <http://www.panasonic.com>  
You can purchase parts, accessories or locate your nearest servicenter by visiting our Web Site.*

**Accessory Purchases:**

1-800-332-5368 (Customer Orders Only)  
Panasonic Services Company 20421 84th Avenue South, Kent, WA 98032  
(6 am to 5 pm Monday-Friday; 6 am to 10:30 am Saturday; PST)  
(Visa, MasterCard, Discover Card, American Express, Check)

**Factory Servicenters Locations**

<p><b>CALIFORNIA</b> 6550 Katella Avenue Cypress, CA 90630</p> <p>800 Dubuque Avenue S. San Francisco CA 94080</p> <p>20201 Sherman Way Suite 102 Canoga Park, CA 91306</p> <p>3878 Ruffin Road Suite A San Diego, CA 92123</p> <p><b>COLORADO</b> 1640 South Abilene Street Suite D Aurora, CO 80012</p> <p><b>FLORIDA</b> 3700 North 29<sup>th</sup> Avenue Suite 102 Hollywood, FL 33020</p>	<p><b>GEORGIA</b> 8655 Roswell Road Suite 100 Atlanta, GA 30350</p> <p><b>ILLINOIS</b> 9060 Golf Road Niles, IL 60714</p> <p>1703 North Randall Road Elgin, IL 60123 (Pick-up/Drop-off only)</p> <p><b>MARYLAND</b> 62 Mountain Road Glen Burnie, MD 21061</p> <p><b>MASSACHUSETTS</b> 60 Glacier Drive Suite G Westwood, MA 02090</p>	<p><b>MICHIGAN</b> 37048 Van Dyke Avenue Sterling Heights, MI 48312</p> <p><b>MINNESOTA</b> 7850-12<sup>th</sup> Avenue South Airport Business Center Bloomington, MN 55425</p> <p><b>OHIO</b> 2236 Waycross Road Civic Center Plaza Forest Park, OH 45240</p> <p><b>PENNSYLVANIA</b> 2221 Cabot Blvd. West Suite B Langhorne, PA 19047</p> <p>Chartiers Valley Shopping Center 1025 Washington Pike Bridgeville, PA 15017</p>	<p><b>TENNESSEE</b> 3800 Ezell Road Suite 806 Nashville, TN 37211</p> <p><b>TEXAS</b> 7482 Harwin Drive Houston, TX 77036</p> <p>13615 Welch Road Suite 101 Farmers Branch TX 75244</p> <p><b>WASHINGTON</b> 20425-84<sup>th</sup> Avenue South Kent, WA 98032</p> <p><b>HAWAII</b> 99-859 Iwaiwa Street Aiea, Hawaii 96701 Phone (808) 488-1996 Fax (808) 486-4369</p>
---	--	--	---

*Service in Puerto Rico*

*Matsushita Electric of Puerto Rico, Inc. Panasonic Sales Company/Factory Servicenter:  
Ave. 65 de Infantería, Km. 9.5, San Gabriel Industrial Park, Carolina, Puerto Rico 00985  
Phone (787) 750-4300 Fax (787) 768-2910*

**Panasonic Consumer Electronics Company, Division of Matsushita Electric Corporation of America**  
One Panasonic Way Secaucus, New Jersey 07094  
<http://www.panasonic.com>

**Panasonic Sales Company, Division of Matsushita Electric of Puerto Rico, Inc. ("PSC")**  
Ave. 65 de Infantería, Km. 9.5 San Gabriel Industrial Park, Carolina, Puerto Rico 00985

**Panasonic Canada Inc.**  
5770 Ambler Drive  
Mississauga, Ontario  
L4W 2T3  
[www.panasonic.ca](http://www.panasonic.ca)



## Free Manuals Download Website

<http://myh66.com>

<http://usermanuals.us>

<http://www.somanuals.com>

<http://www.4manuals.cc>

<http://www.manual-lib.com>

<http://www.404manual.com>

<http://www.luxmanual.com>

<http://aubethermostatmanual.com>

Golf course search by state

<http://golfingnear.com>

Email search by domain

<http://emailbydomain.com>

Auto manuals search

<http://auto.somanuals.com>

TV manuals search

<http://tv.somanuals.com>