

# TOSHIBA

FILE NO. A10-031

## SERVICE MANUAL

# AIR-CONDITIONER SPLIT TYPE

### INDOOR UNIT <DIGITAL INVERTER>

#### Compact 4-way Cassette Type

**RAV-SM404MUT-E**

**RAV-SM404MUT-TR**

**RAV-SM454MUT-E**

**RAV-SM454MUT-TR**

**RAV-SM564MUT-E**

**RAV-SM564MUT-TR**

#### Concealed Duct Type

**RAV-SM564BT-E**

**RAV-SM564BT-TR**

**RAV-SM804BT-E**

**RAV-SM804BT-TR**

**RAV-SM1104BT-E**

**RAV-SM1104BT-TR**

**RAV-SM1404BT-E**

**RAV-SM1404BT-TR**

#### Ceiling Type

**RAV-SM564CT-E**

**RAV-SM564CT-TR**

**RAV-SM804CT-E**

**RAV-SM804CT-TR**

**RAV-SM1104CT-E**

**RAV-SM1104CT-TR**

**RAV-SM1404CT-E**

**RAV-SM1404CT-TR**



## NOTE

A direct current motor is adopted for indoor fan motor in the Concealed Duct Standard Type air conditioner. Caused from its characteristics, a current limit works on the direct current motor. When replacing the high-performance filter or when opening the service board, be sure to stop the fan. If an above action is executed during the fan operation, the protective control works to stop the unit operation, and the check code "P12" may be issued. However it is not a trouble. When the desired operation has finished, be sure to reset the system to clear "P12" error code using the leak breaker of the indoor unit. Then push the operation stop button of the remote controller to return to the usual operation.

# CONTENTS

<b>ORIGINAL INSTRUCTION .....</b>	<b>4</b>
<b>WARNING INDICATIONS ON THE AIR CONDITIONER UNIT6</b>	
<b>PRECAUTION FOR SAFETY .....</b>	<b>7</b>
<b>NEW REFRIGERANT (R410A) .....</b>	<b>13</b>
1. Safety Caution Concerned to New Refrigerant .....	13
2. Cautions on Installation/Service .....	13
3. Pipe Materials .....	13
<b>1. AIR DUCTING WORK.....</b>	<b>15</b>
1-1. Static Pressure Characteristics .....	15
<b>2. CONSTRUCTION VIEWS (EXTERNAL VIEWS) .....</b>	<b>17</b>
2-1. Compact 4-way Cassette Type .....	17
2-2. Concealed Duct Type .....	18
2-3. Ceiling Type .....	19
<b>3. WIRING DIAGRAM .....</b>	<b>20</b>
3-1. Indoor Unit.....	20
<b>4. SPECIFICATIONS OF ELECTRICAL PARTS .....</b>	<b>23</b>
4-1. Compact 4-way Cassette Type .....	23
4-2. Concealed Duct Type .....	23
4-3. Ceiling Type .....	23
<b>5. CONTROL BLOCK DIAGRAM .....</b>	<b>24</b>
5-1. Indoor Controller Block Diagram.....	24
5-2. Control Specifications .....	27
5-3. Indoor Print Circuit Board .....	40

<b>6. TROUBLESHOOTING .....</b>	<b>42</b>
6-1. Summary of Troubleshooting .....	42
6-2. Check Code List (Indoor) .....	47
6-3. Diagnostic Procedure for Each Check Code (Indoor Unit) .....	52
<b>7. REPLACEMENT OF SERVICE P.C. BOARD .....</b>	<b>64</b>
7-1. Indoort Unit .....	64
<b>8. SETUP AT LOCAL SITE AND OTHERS .....</b>	<b>68</b>
8-1. Indoor Unit .....	68
8-2. Setup at Local Site / Others .....	78
8-3. How to Set up Central Control Address Number .....	80
<b>9. ADDRESS SETUP .....</b>	<b>82</b>
9-1. Address Setup .....	82
9-2. Address Setup & Group Control .....	83
9-3. Address Setup (Manual Setting from Remote Controller) .....	86
9-4. Confirmation of Indoor Unit No. Position .....	87
<b>10. DETACHMENTS .....</b>	<b>88</b>
10-1. Compact 4-Way Cassette Type .....	88
10-2. Concealed Duct Type .....	97
10-3. Ceiling Type .....	100
<b>11. EXPLODED VIEWS AND PARTS LIST .....</b>	<b>104</b>
11-1. Compact 4-way Cassette Type .....	104
11-2. Concealed Duct Type .....	108
11-3. Ceiling Type .....	115

# Original instruction

Please read carefully through these instructions that contain important information which complies with the “Machinery” Directive (Directive 2006/42/EC), and ensure that you understand them.

## Generic Denomination: Air Conditioner

### Definition of Qualified Installer or Qualified Service Person

The air conditioner must be installed, maintained, repaired and removed by a qualified installer or qualified service person.

When any of these jobs is to be done, ask a qualified installer or qualified service person to do them for you.

A qualified installer or qualified service person is an agent who has the qualifications and knowledge described in the table below.

Agent	Qualifications and knowledge which the agent must have
Qualified installer (*1)	<ul style="list-style-type: none"> <li>• The qualified installer is a person who installs, maintains, relocates and removes the air conditioners made by Toshiba Carrier Corporation. He or she has been trained to install, maintain, relocate and remove the air conditioners made by Toshiba Carrier Corporation or, alternatively, he or she has been instructed in such operations by an individual or individuals who have been trained and is thus thoroughly acquainted with the knowledge related to these operations.</li> <li>• The qualified installer who is allowed to do the electrical work involved in installation, relocation and removal has the qualifications pertaining to this electrical work as stipulated by the local laws and regulations, and he or she is a person who has been trained in matters relating to electrical work on the air conditioners made by Toshiba Carrier Corporation or, alternatively, he or she has been instructed in such matters by an individual or individuals who have been trained and is thus thoroughly acquainted with the knowledge related to this work.</li> <li>• The qualified installer who is allowed to do the refrigerant handling and piping work involved in installation, relocation and removal has the qualifications pertaining to this refrigerant handling and piping work as stipulated by the local laws and regulations, and he or she is a person who has been trained in matters relating to refrigerant handling and piping work on the air conditioners made by Toshiba Carrier Corporation or, alternatively, he or she has been instructed in such matters by an individual or individuals who have been trained and is thus thoroughly acquainted with the knowledge related to this work.</li> <li>• The qualified installer who is allowed to work at heights has been trained in matters relating to working at heights with the air conditioners made by Toshiba Carrier Corporation or, alternatively, he or she has been instructed in such matters by an individual or individuals who have been trained and is thus thoroughly acquainted with the knowledge related to this work.</li> </ul>
Qualified service person (*1)	<ul style="list-style-type: none"> <li>• The qualified service person is a person who installs, repairs, maintains, relocates and removes the air conditioners made by Toshiba Carrier Corporation. He or she has been trained to install, repair, maintain, relocate and remove the air conditioners made by Toshiba Carrier Corporation or, alternatively, he or she has been instructed in such operations by an individual or individuals who have been trained and is thus thoroughly acquainted with the knowledge related to these operations.</li> <li>• The qualified service person who is allowed to do the electrical work involved in installation, repair, relocation and removal has the qualifications pertaining to this electrical work as stipulated by the local laws and regulations, and he or she is a person who has been trained in matters relating to electrical work on the air conditioners made by Toshiba Carrier Corporation or, alternatively, he or she has been instructed in such matters by an individual or individuals who have been trained and is thus thoroughly acquainted with the knowledge related to this work.</li> <li>• The qualified service person who is allowed to do the refrigerant handling and piping work involved in installation, repair, relocation and removal has the qualifications pertaining to this refrigerant handling and piping work as stipulated by the local laws and regulations, and he or she is a person who has been trained in matters relating to refrigerant handling and piping work on the air conditioners made by Toshiba Carrier Corporation or, alternatively, he or she has been instructed in such matters by an individual or individuals who have been trained and is thus thoroughly acquainted with the knowledge related to this work.</li> <li>• The qualified service person who is allowed to work at heights has been trained in matters relating to working at heights with the air conditioners made by Toshiba Carrier Corporation or, alternatively, he or she has been instructed in such matters by an individual or individuals who have been trained and is thus thoroughly acquainted with the knowledge related to this work.</li> </ul>



## Definition of Protective Gear

When the air conditioner is to be transported, installed, maintained, repaired or removed, wear protective gloves and 'safety' work clothing.



In addition to such normal protective gear, wear the protective gear described below when undertaking the special work detailed in the table below.

Failure to wear the proper protective gear is dangerous because you will be more susceptible to injury, burns, electric shocks and other injuries.

Work undertaken	Protective gear worn
All types of work	Protective gloves "Safety" working clothing
Electrical-related work	Gloves to provide protection for electricians and from heat Insulating shoes Clothing to provide protection from electric shock
Work done at heights (50 cm or more)	Helmets for use in industry
Transportation of heavy objects	Shoes with additional protective toe cap
Repair of outdoor unit	Gloves to provide protection for electricians and from heat



The important contents concerned to the safety are described on the product itself and on this Service Manual. Please read this Service Manual after understanding the described items thoroughly in the following contents (Indications/Illustrated marks), and keep them.

### [Explanation of indications]

Indication	Explanation
 <b>DANGER</b>	Indicates contents assumed that an imminent danger causing a death or serious injury of the repair engineers and the third parties when an incorrect work has been executed.
 <b>WARNING</b>	Indicates possibilities assumed that a danger causing a death or serious injury of the repair engineers, the third parties, and the users due to troubles of the product after work when an incorrect work has been executed.
 <b>CAUTION</b>	Indicates contents assumed that an injury or property damage (*) may be caused on the repair engineers, the third parties, and the users due to troubles of the product after work when an incorrect work has been executed.

\* Property damage : Enlarged damage concerned to property, furniture, and domestic animal/pet





### [Explanation of illustrated marks]

Mark	Explanation
	Indicates prohibited items (Forbidden items to do) The sentences near an illustrated mark describe the concrete prohibited contents.
	Indicates mandatory items (Compulsory items to do) The sentences near an illustrated mark describe the concrete mandatory contents.
	Indicates cautions (Including danger/warning) The sentences or illustration near or in an illustrated mark describe the concrete cautious contents.

# Warning Indications on the Air Conditioner Unit

## [Confirmation of warning label on the main unit]

Confirm that labels are indicated on the specified positions  
 If removing the label during parts replace, stick it as the original.

Warning indication	Description		
 <table border="1" data-bbox="309 465 820 703"> <tr> <td data-bbox="309 465 820 546" style="text-align: center;"><b>WARNING</b></td> </tr> <tr> <td data-bbox="309 551 820 703"> <b>ELECTRICAL SHOCK HAZARD</b>            Disconnect all remote electric power supplies before servicing.         </td> </tr> </table>	<b>WARNING</b>	<b>ELECTRICAL SHOCK HAZARD</b> Disconnect all remote electric power supplies before servicing.	<b>WARNING</b> <b>ELECTRICAL SHOCK HAZARD</b> Disconnect all remote electric power supplies before servicing.
<b>WARNING</b>			
<b>ELECTRICAL SHOCK HAZARD</b> Disconnect all remote electric power supplies before servicing.			
 <table border="1" data-bbox="309 819 820 1034"> <tr> <td data-bbox="309 819 820 900" style="text-align: center;"><b>WARNING</b></td> </tr> <tr> <td data-bbox="309 904 820 1034">           Moving parts.            Do not operate unit with grille removed.            Stop the unit before the servicing.         </td> </tr> </table>	<b>WARNING</b>	Moving parts. Do not operate unit with grille removed. Stop the unit before the servicing.	<b>WARNING</b> Moving parts. Do not operate unit with grille removed. Stop the unit before the servicing.
<b>WARNING</b>			
Moving parts. Do not operate unit with grille removed. Stop the unit before the servicing.			
 <table border="1" data-bbox="309 1160 820 1375"> <tr> <td data-bbox="309 1160 820 1240" style="text-align: center;"><b>CAUTION</b></td> </tr> <tr> <td data-bbox="309 1245 820 1375">           High temperature parts.            You might get burned when removing this panel.         </td> </tr> </table>	<b>CAUTION</b>	High temperature parts. You might get burned when removing this panel.	<b>CAUTION</b> High temperature parts. You might get burned when removing this panel.
<b>CAUTION</b>			
High temperature parts. You might get burned when removing this panel.			
 <table border="1" data-bbox="309 1480 820 1673"> <tr> <td data-bbox="309 1480 820 1561" style="text-align: center;"><b>CAUTION</b></td> </tr> <tr> <td data-bbox="309 1565 820 1673">           Do not touch the aluminum fins of the unit.            Doing so may result in injury.         </td> </tr> </table>	<b>CAUTION</b>	Do not touch the aluminum fins of the unit. Doing so may result in injury.	<b>CAUTION</b> Do not touch the aluminum fins of the unit. Doing so may result in injury.
<b>CAUTION</b>			
Do not touch the aluminum fins of the unit. Doing so may result in injury.			
 <table border="1" data-bbox="309 1800 820 2038"> <tr> <td data-bbox="309 1800 820 1881" style="text-align: center;"><b>CAUTION</b></td> </tr> <tr> <td data-bbox="309 1886 820 2038"> <b>BURST HAZARD</b>            Open the service valves before the operation, otherwise there might be the burst.         </td> </tr> </table>	<b>CAUTION</b>	<b>BURST HAZARD</b> Open the service valves before the operation, otherwise there might be the burst.	<b>CAUTION</b> <b>BURST HAZARD</b> Open the service valves before the operation, otherwise there might be the burst.
<b>CAUTION</b>			
<b>BURST HAZARD</b> Open the service valves before the operation, otherwise there might be the burst.			

# Precaution for Safety



The manufacturer shall not assume any liability for the damage caused by not observing the description of this manual.

## WARNING







 General	<p>Before starting to repair the air conditioner, read carefully through the Service Manual, and repair the air conditioner by following its instructions.</p>
	<p>Only qualified service person (*1) is allowed to repair the air conditioner. Repair of the air conditioner by unqualified person may give rise to a fire, electric shocks, injury, water leaks and/or other problems.</p>
	<p>Only a qualified installer (*1) or qualified service person (*1) is allowed to carry out the electrical work of the air conditioner. Under no circumstances must this work be done by an unqualified individual since failure to carry out the work properly may result in electric shocks and/or electrical leaks.</p>
	<p>Wear protective gloves and safety work clothing during installation, servicing and removal.</p>
	<p>When connecting the electrical wires, repairing the electrical parts or undertaking other electrical jobs, wear gloves to provide protection for electricians and from heat, insulating shoes and clothing to provide protection from electric shocks. Failure to wear this protective gear may result in electric shocks.</p>
	<p>Use wiring that meets the specifications in the Installation Manual and the stipulations in the local regulations and laws. Use of wiring which does not meet the specifications may give rise to electric shocks, electrical leakage, smoking and/or a fire.</p>
	<p>Only a qualified installer (*1) or qualified service person (*1) is allowed to undertake work at heights using a stand of 50 cm or more or to remove the intake grille of the indoor unit to undertake work.</p>
	<p>When working at heights, use a ladder which complies with the ISO 14122 standard, and follow the procedure in the ladder's instructions. Also wear a helmet for use in industry as protective gear to undertake the work.</p>
	<p>When working at heights, put a sign in place so that no-one will approach the work location, before proceeding with the work. Parts and other objects may fall from above, possibly injuring a person below.</p>
	<p>Do not touch the aluminum fin of the outdoor unit. You may injure yourself if you do so. If the fin must be touched for some reason, first put on protective gloves and safety work clothing, and then proceed.</p>
	<p>Do not climb onto or place objects on top of the outdoor unit. You may fall or the objects may fall off of the outdoor unit and result in injury.</p>
	<p>When transporting the air conditioner, wear shoes with additional protective toe caps.</p>
	<p>When transporting the air conditioner, do not take hold of the bands around the packing carton. You may injure yourself if the bands should break.</p>
<p>This air conditioner has passed the pressure test as specified in IEC 60335-2-40 Annex EE.</p>	





## DANGER





 Turn off breaker.	<p>Before carrying out the installation, maintenance, repair or removal work, be sure to set the circuit breaker to the OFF position. Otherwise, electric shocks may result.</p>
	<p>Before opening the intake grille of the indoor unit or service panel of the outdoor unit, set the circuit breaker to the OFF position. Failure to set the circuit breaker to the OFF position may result in electric shocks through contact with the interior parts. Only a qualified installer (*1) or qualified service person (*1) is allowed to remove the intake grille of the indoor unit or service panel of the outdoor unit and do the work required.</p>
	<p>Before starting to repair the outdoor unit fan or fan guard, be absolutely sure to set the circuit breaker to the OFF position, and place a "Work in progress" sign on the circuit breaker.</p>
	<p>When cleaning the filter or other parts of the indoor unit, set the circuit breaker to OFF without fail, and place a "Work in progress" sign near the circuit breaker before proceeding with the work.</p>

 Execute discharge between terminals.	<p>Even if the circuit breaker has been set to the OFF position before the service panel is removed and the electrical parts are repaired, you will still risk receiving an electric shock. For this reason, short-circuit the high-voltage capacitor terminals to discharge the voltage before proceeding with the repair work. For details on the short-circuiting procedure, refer to the Service Manual. You may receive an electric shock if the voltage stored in the capacitors has not been sufficiently discharged.</p>
 Prohibition	<p>Place a "Work in progress" sign near the circuit breaker while the installation, maintenance, repair or removal work is being carried out. There is a danger of electric shocks if the circuit breaker is set to ON by mistake.</p>
 Stay on protection	<p>If, in the course of carrying out repairs, it becomes absolutely necessary to check out the electrical parts with the electrical parts box cover of one or more of the indoor units and the service panel of the outdoor unit removed in order to find out exactly where the trouble lies, wear insulated heat-resistant gloves, insulated boots and insulated work overalls, and take care to avoid touching any live parts. You may receive an electric shock if you fail to heed this warning. Only qualified service person (*1) is allowed to do this kind of work.</p>

 **WARNING**

 Check earth wires.	<p>Before troubleshooting or repair work, check the earth wire is connected to the earth terminals of the main unit, otherwise an electric shock is caused when a leak occurs. If the earth wire is not correctly connected, contact an electric engineer for rework.</p> <p>After completing the repair or relocation work, check that the ground wires are connected properly.</p> <p>Be sure to connect earth wire. (Grounding work) Incomplete grounding causes an electric shock. Do not connect ground wires to gas pipes, water pipes, and lightning rods or ground wires for telephone wires.</p>
 Prohibition of modification.	<p>Do not modify the products. Do not also disassemble or modify the parts. It may cause a fire, electric shock or injury.</p>
 Use specified parts.	<p>When any of the electrical parts are to be replaced, ensure that the replacement parts satisfy the specifications given in the Service Manual (or use the parts contained on the parts list in the Service Manual). Use of any parts which do not satisfy the required specifications may give rise to electric shocks, smoking and/or a fire.</p>
 Do not bring a child close to the equipment.	<p>If, in the course of carrying out repairs, it becomes absolutely necessary to check out the electrical parts with the electrical parts box cover of one or more of the indoor units and the service panel of the outdoor unit removed in order to find out exactly where the trouble lies, place "Keep out" signs around the work site before proceeding. Third-party individuals may enter the work site and receive electric shocks if this warning is not heeded.</p>
 Insulating measures	<p>Connect the cut-off lead wires with crimp contact, etc, put the closed end side upward and then apply a water-cut method, otherwise a leak or production of fire is caused at the users' side.</p>
 No fire	<p>When performing repairs using a gas burner, replace the refrigerant with nitrogen gas because the oil that coats the pipes may otherwise burn. When repairing the refrigerating cycle, take the following measures.</p> <ol style="list-style-type: none"> <li>1) Be attentive to fire around the cycle. When using a gas stove, etc, be sure to put out fire before work; otherwise the oil mixed with refrigerant gas may catch fire.</li> <li>2) Do not use a welder in the closed room. When using it without ventilation, carbon monoxide poisoning may be caused.</li> <li>3) Do not bring inflammables close to the refrigerant cycle, otherwise fire of the welder may catch the inflammables.</li> </ol>

 <p>Refrigerant</p>	<p>The refrigerant used by this air conditioner is the R410A.  Check the used refrigerant name and use tools and materials of the parts which match with it.  For the products which use R410A refrigerant, the refrigerant name is indicated at a position on the outdoor unit where is easy to see.  To prevent miss-charging, the route of the service port is changed from one of the former R22. Do not use any refrigerant different from the one specified for complement or replacement. Otherwise, abnormally high pressure may be generated in the refrigeration cycle, which may result in a failure or explosion of the product or an injury to your body.  For an air conditioner which uses R410A, never use other refrigerant than R410A.  For an air conditioner which uses other refrigerant (R22, etc.), never use R410A.  If different types of refrigerant are mixed, abnormal high pressure generates in the refrigerating cycle and an injury due to breakage may be caused.  Do not charge refrigerant additionally.  If charging refrigerant additionally when refrigerant gas leaks, the refrigerant composition in the refrigerating cycle changes resulted in change of air conditioner characteristics or refrigerant over the specified standard amount is charged and an abnormal high pressure is applied to the inside of the refrigerating cycle resulted in cause of breakage or injury.  Therefore if the refrigerant gas leaks, recover the refrigerant in the air conditioner, execute vacuuming, and then newly recharge the specified amount of liquid refrigerant.  In this time, never charge the refrigerant over the specified amount.  When recharging the refrigerant in the refrigerating cycle, do not mix the refrigerant or air other than R410A into the specified refrigerant.  If air or others is mixed with the refrigerant, abnormal high pressure generates in the refrigerating cycle resulted in cause of injury due to breakage.  After installation work, check the refrigerant gas does not leak.  If the refrigerant gas leaks in the room, poisonous gas generates when gas touches to fire such as fan heater, stove or cooking stove though the refrigerant gas itself is innocuous.  Never recover the refrigerant into the outdoor unit.  When the equipment is moved or repaired, be sure to recover the refrigerant with recovering device. The refrigerant cannot be recovered in the outdoor unit; otherwise a serious accident such as breakage or injury is caused.</p>
 <p>Assembly/ Cabling</p>	<p>After repair work, surely assemble the disassembled parts, and connect and lead the removed wires as before.  Perform the work so that the cabinet or panel does not catch the inner wires.  If incorrect assembly or incorrect wire connection was done, a disaster such as a leak or fire is caused at user's side.</p>
 <p>Insulator check</p>	<p>After the work has finished, be sure to use an insulation tester set (500V Megger) to check the resistance is 1MΩ or more between the charge section and the non-charge metal section (Earth position).  If the resistance value is low, a disaster such as a leak or electric shock is caused at user's side.</p>
 <p>Ventilation</p>	<p>When the refrigerant gas leaks during work, execute ventilation.  If the refrigerant gas touches to a fire, poisonous gas generates.  A case of leakage of the refrigerant and the closed room full with gas is dangerous because a shortage of oxygen occurs. Be sure to execute ventilation.</p>
 <p>Compulsion</p>	<p>When the refrigerant gas leaks, find up the leaked position and repair it surely.  If the leaked position cannot be found up and the repair work is interrupted, pump-down and tighten the service valve, otherwise the refrigerant gas may leak into the room.  The poisonous gas generates when gas touches to fire such as fan heater, stove or cooking stove though the refrigerant gas itself is innocuous.  When installing equipment which includes a large amount of charged refrigerant such as a multi air conditioner in a sub-room, it is necessary that the density does not the limit even if the refrigerant leaks.  If the refrigerant leaks and exceeds the limit density, an accident of shortage of oxygen is caused.</p> <p>Tighten the flare nut with a torque wrench in the specified manner.  Excessive tighten of the flare nut may cause a crack in the flare nut after a long period, which may result in refrigerant leakage.</p> <p>Nitrogen gas must be used for the airtight test.</p> <p>The charge hose must be connected in such a way that it is not slack.</p> <p>For the installation/moving/reinstallation work, follow to the Installation Manual.  If an incorrect installation is done, a trouble of the refrigerating cycle, water leak, electric shock or fire is caused.</p>

 Check after repair	Once the repair work has been completed, check for refrigerant leaks, and check the insulation resistance and water drainage. Then perform a trial run to check that the air conditioner is running properly.
	After repair work has finished, check there is no trouble. If check is not executed, a fire, electric shock or injury may be caused. For a check, turn off the power breaker.
	After repair work (installation of front panel and cabinet) has finished, execute a test run to check there is no generation of smoke or abnormal sound. If check is not executed, a fire or an electric shock is caused. Before test run, install the front panel and cabinet.
 Do not operate the unit with the valve closed.	Check the following matters before a test run after repairing piping. <ul style="list-style-type: none"> <li>• Connect the pipes surely and there is no leak of refrigerant.</li> <li>• The valve is opened.</li> </ul> Running the compressor under condition that the valve closes causes an abnormal high pressure resulted in damage of the parts of the compressor and etc. and moreover if there is leak of refrigerant at connecting section of pipes, the air is suctioned and causes further abnormal high pressure resulted in burst or injury.
 Check after reinstallation	Only a qualified installer (*1) or qualified service person (*1) is allowed to relocate the air conditioner. It is dangerous for the air conditioner to be relocated by an unqualified individual since a fire, electric shocks, injury, water leakage, noise and/or vibration may result.
	Check the following items after reinstallation. <ol style="list-style-type: none"> <li>1) The earth wire is correctly connected.</li> <li>2) The power cord is not caught in the product.</li> <li>3) There is no inclination or unsteadiness and the installation is stable.</li> </ol> If check is not executed, a fire, an electric shock or an injury is caused.
	When carrying out the pump-down work shut down the compressor before disconnecting the refrigerant pipe. Disconnecting the refrigerant pipe with the service valve left open and the compressor still operating will cause air, etc. to be sucked in, raising the pressure inside the refrigeration cycle to an abnormally high level, and possibly resulting in reputing, injury, etc.
 Cooling check	When the service panel of the outdoor unit is to be opened in order for the compressor or the area around this part to be repaired immediately after the air conditioner has been shut down, set the circuit breaker to the OFF position, and then wait at least 10 minutes before opening the service panel. If you fail to heed this warning, you will run the risk of burning yourself because the compressor pipes and other parts will be very hot to the touch. In addition, before proceeding with the repair work, wear the kind of insulated heat-resistant gloves designed to protect electricians.
	When the service panel of the outdoor unit is to be opened in order for the fan motor, reactor, inverter or the areas around these parts to be repaired immediately after the air conditioner has been shut down, set the circuit breaker to the OFF position, and then wait at least 10 minutes before opening the service panel. If you fail to heed this warning, you will run the risk of burning yourself because the fan motor, reactor, inverter heat sink and other parts will be very hot to the touch. In addition, before proceeding with the repair work, wear the kind of insulated heat-resistant gloves designed to protect electricians.
 Installation	Only a qualified installer (*1) or qualified service person (*1) is allowed to install the air conditioner. If the air conditioner is installed by an unqualified individual, a fire, electric shocks, injury, water leakage, noise and/or vibration may result.
	Before starting to install the air conditioner, read carefully through the Installation Manual, and follow its instructions to install the air conditioner.
	Do not install the air conditioner in a location that may be subject to a risk of expire to a combustible gas. If a combustible gas leaks and becomes concentrated around the unit, a fire may occur.
	Install the indoor unit at least 2.5 m above the floor level since otherwise the users may injure themselves or receive electric shocks if they poke their fingers or other objects into the indoor unit while the air conditioner is running.
	Install a circuit breaker that meets the specifications in the installation manual and the stipulations in the local regulations and laws.
	Install the circuit breaker where it can be easily accessed by the qualified service person (*1).
	Do not place any combustion appliance in a place where it is directly exposed to the wind of air conditioner, otherwise it may cause imperfect combustion.

## Explanations given to user

- If you have discovered that the fan grille is damaged, do not approach the outdoor unit but set the circuit breaker to the OFF position, and contact a qualified service person to have the repairs done. Do not set the circuit breaker to the ON position until the repairs are completed.

## Relocation

- Only a qualified installer (\*1) or qualified service person (\*1) is allowed to relocate the air conditioner. It is dangerous for the air conditioner to be relocated by an unqualified individual since a fire, electric shocks, injury, water leakage, noise and/or vibration may result.
- When carrying out the pump-down work shut down the compressor before disconnecting the refrigerant pipe. Disconnecting the refrigerant pipe with the service valve left open and the compressor still operating will cause air, etc. to be sucked in, raising the pressure inside the refrigeration cycle to an abnormally high level, and possibly resulting in reputing, injury, etc.

(\*1) Refer to the “Definition of Qualified Installer or Qualified Service Person.”

## Declaration of Conformity

Manufacturer: Toshiba Carrier Corporation  
336 Tadehara, Fuji-shi, Shizuoka-ken 416-8521 JAPAN

Authorized Nick Ball

Representative/TCF holder: Toshiba EMEA Engineering Director  
Toshiba Carrier UK Ltd.  
Porsham Close, Belliver Industrial Estate,  
PLYMOUTH, Devon, PL6 7DB.  
United Kingdom

Hereby declares that the machinery described below:

Generic Denomination: Air Conditioner

Model/type:	RAV-SM404MUT-E	RAV-SM404MUT-TR
	RAV-SM454MUT-E	RAV-SM454MUT-TR
	RAV-SM564MUT-E	RAV-SM564MUT-TR
	RAV-SM564BT-E	RAV-SM564BT-TR
	RAV-SM804BT-E	RAV-SM804BT-TR
	RAV-SM1104BT-E	RAV-SM1104BT-TR
	RAV-SM1404BT-E	RAV-SM1404BT-TR
	RAV-SM564CT-E	RAV-SM564CT-TR
	RAV-SM804CT-E	RAV-SM804CT-TR
	RAV-SM1104CT-E	RAV-SM1104CT-TR
	RAV-SM1404CT-E	RAV-SM1404CT-TR

Commercial name: Digital Inverter Series / Super Digital Inverter Series Air Conditioner

Complies with the provisions of the “Machinery” Directive (Directive 2006/42/EC) and the regulations transposing into national law.

Complies with the provisions of the following harmonized standard:

EN 378-2: 2008 / A1: 2009

**Note:** This declaration becomes invalid if technical or operational modifications are introduced without the manufacturer’s consent.



## Specifications

Model	Sound power level (dBA)		Weight (kg) Main unit (Ceiling panel)
	Cooling	Heating	
RAV-SM404MUT-E	*	*	16 (3)
RAV-SM454MUT-E	*	*	16 (3)
RAV-SM564MUT-E	*	*	16 (3)
RAV-SM404MUT-TR	*	*	16 (3)
RAV-SM454MUT-TR	*	*	16 (3)
RAV-SM564MUT-TR	*	*	16 (3)
RAV-SM564BT-E	*	*	30
RAV-SM804BT-E	*	*	39
RAV-SM1104BT-E	*	*	54
RAV-SM1404BT-E	*	*	54
RAV-SM564BT-TR	*	*	30
RAV-SM804BT-TR	*	*	39
RAV-SM1104BT-TR	*	*	54
RAV-SM1404BT-TR	*	*	54
RAV-SM564CT-E	*	*	21
RAV-SM804CT-E	*	*	25
RAV-SM1104CT-E	*	*	33
RAV-SM1404CT-E	*	*	33
RAV-SM564CT-TR	*	*	21
RAV-SM804CT-TR	*	*	25
RAV-SM1104CT-TR	*	*	33
RAV-SM1404CT-TR	*	*	33

\*: Under 70 dBA

- Other specifications than abovementioned models are equal to current models (2 series).



# New Refrigerant (R410A)

This air conditioner adopts a new HFC type refrigerant (R410A) which does not deplete the ozone layer.

## 1. Safety Caution Concerned to New Refrigerant

The pressure of R410A is high 1.6 times of that of the former refrigerant (R22).

Accompanied with change of refrigerant, the refrigerating oil has been also changed.

Therefore, be sure that water, dust, the former refrigerant or the former refrigerating oil is not mixed into the refrigerating cycle of the air conditioner with new refrigerant during installation work or service work.

If an incorrect work or incorrect service is performed, there is a possibility to cause a serious accident.

Use the tools and materials exclusive to R410A to purpose a safe work.

## 2. Cautions on Installation/Service

- 1) Do not mix the other refrigerant or refrigerating oil.

For the tools exclusive to R410A, shapes of all the joints including the service port differ from those of the former refrigerant in order to prevent mixture of them.

- 2) As the use pressure of the new refrigerant is high, use material thickness of the pipe and tools which are specified for R410A.

- 3) In the installation time, use clean pipe materials and work with great attention so that water and others do not mix in because pipes are affected by impurities such as water, oxide scales, oil, etc.

Use the clean pipes.

Be sure to brazing with flowing nitrogen gas. (Never use gas other than nitrogen gas.)

- 4) For the earth protection, use a vacuum pump for air purge.

- 5) R410A refrigerant is azeotropic mixture type refrigerant.

Therefore use liquid type to charge the refrigerant. (If using gas for charging, composition of the refrigerant changes and then characteristics of the air conditioner change.)

## 3. Pipe Materials

For the refrigerant pipes, copper pipe and joints are mainly used.

It is necessary to select the most appropriate pipes to conform to the standard.

Use clean material in which impurities adhere inside of pipe or joint to a minimum.

### 1) Copper pipe

#### <Piping>

The pipe thickness, flare finishing size, flare nut and others differ according to a refrigerant type.

When using a long copper pipe for R410A, it is recommended to select "Copper or copper-base pipe without seam" and one with bonded oil amount 40mg/10m or less.

Also do not use crushed, deformed, discolored (especially inside) pipes.

(Impurities cause clogging of expansion valves and capillary tubes.)

#### <Flare nut>

Use the flare nuts which are attached to the air conditioner unit.

### 2) Joint

The flare joint and socket joint are used for joints of the copper pipe.

The joints are rarely used for installation of the air conditioner.

However clear impurities when using them.

## 4. Tools

### 1. Required Tools for R410A

Mixing of different types of oil may cause a trouble such as generation of sludge, clogging of capillary, etc. Accordingly, the tools to be used are classified into the following three types.

- 1) Tools exclusive for R410A (Those which cannot be used for conventional refrigerant (R22))
- 2) Tools exclusive for R410A, but can be also used for conventional refrigerant (R22)
- 3) Tools commonly used for R410A and for conventional refrigerant (R22)

The table below shows the tools exclusive for R410A and their interchangeability.

#### Tools exclusive for R410A (The following tools for R410A are required.)

Tools whose specifications are changed for R410A and their interchangeability

No.	Used tool	Usage	R410A air conditioner installation		Conventional air conditioner installation
			Existence of new equipment for R410A	Whether conventional equipment can be used	Whether conventional equipment can be used
①	Flare tool	Pipe flaring	Yes	* (Note)	Yes
②	Copper pipe gauge for adjusting projection margin	Flaring by conventional flare tool	Yes	* (Note)	* (Note)
③	Torque wrench	Tightening of flare nut	Yes	No	No
④	Gauge manifold	Evacuating, refrigerant charge, run check, etc.	Yes	No	No
⑤	Charge hose				
⑥	Vacuum pump adapter	Vacuum evacuating	Yes	No	Yes
⑦	Electronic balance for refrigerant charging	Refrigerant charge	Yes	Yes	Yes
⑧	Refrigerant cylinder	Refrigerant charge	Yes	No	No
⑨	Leakage detector	Gas leakage check	Yes	No	Yes

**(Note)** When flaring is carried out for R410A using the conventional flare tools, adjustment of projection margin is necessary. For this adjustment, a copper pipe gauge, etc. are necessary.

#### General tools (Conventional tools can be used.)

In addition to the above exclusive tools, the following equipments which serve also for R22 are necessary as the general tools.

- |   |  |
|---|--|
| 1) Vacuum pump. Use vacuum pump by attaching vacuum pump adapter. | 7) Screwdriver (+, -)                  |
| 2) Torque wrench  | 8) Spanner or Monkey wrench            |
| 3) Pipe cutter  | 9) Hole core drill                     |
| 4) Reamer   | 10) Hexagon wrench (Opposite side 4mm) |
| 5) Pipe bender  | 11) Tape measure                       |
| 6) Level vial   | 12) Metal saw                          |

Also prepare the following equipments for other installation method and run check.

- |                |  |
|----------------|--|
| 1) Clamp meter | 3) Insulation resistance tester (Megger) |
| 2) Thermometer | 4) Electroscop                           |

# 1. AIR DUCTING WORK

## 1-1. Static Pressure Characteristics

### Concealed Duct type

RAV-SN564BT \*, RAV-SN804BT \*, RAV-SN1104BT \*, RAV-SN1404BT \*

Fig. 1 SM56 type (Round duct)

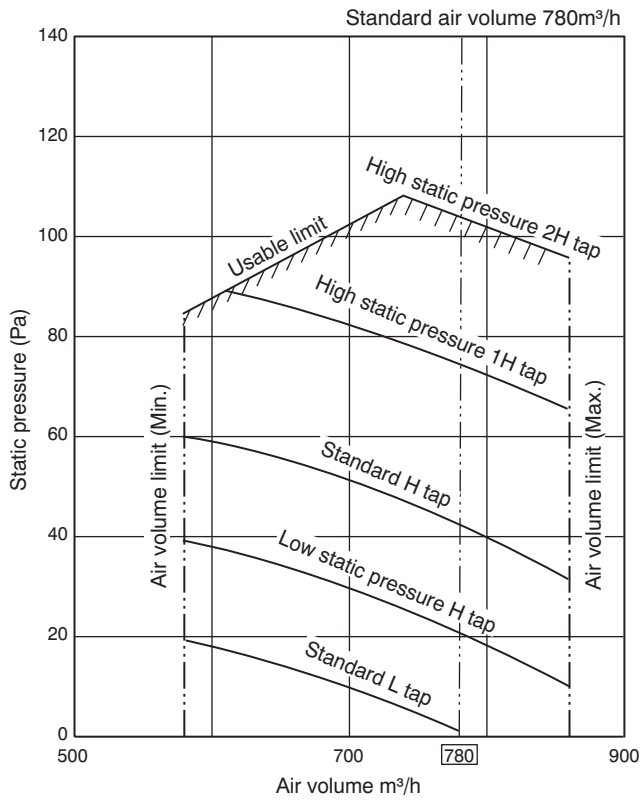

Fig. 3 SM80 type (Round duct)

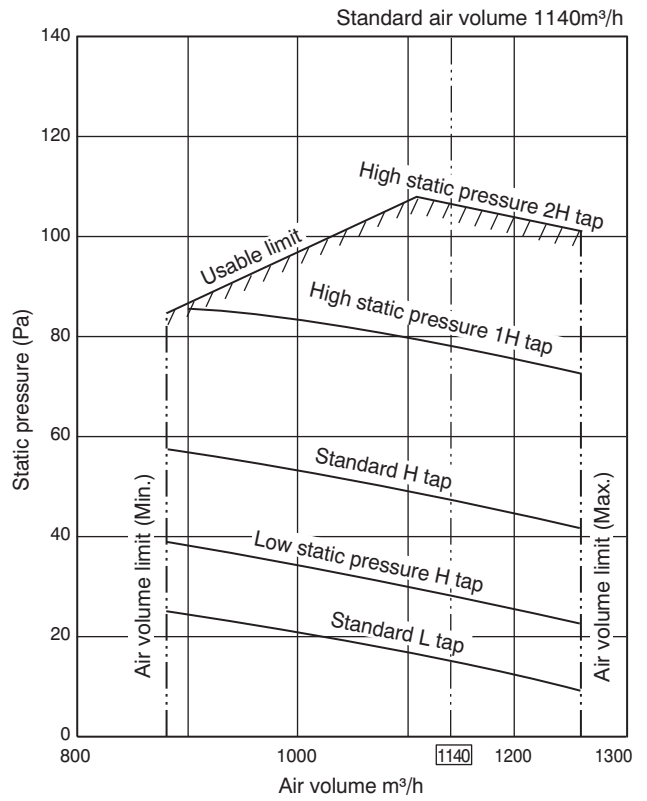

Fig. 2 SM56 type (Square duct)

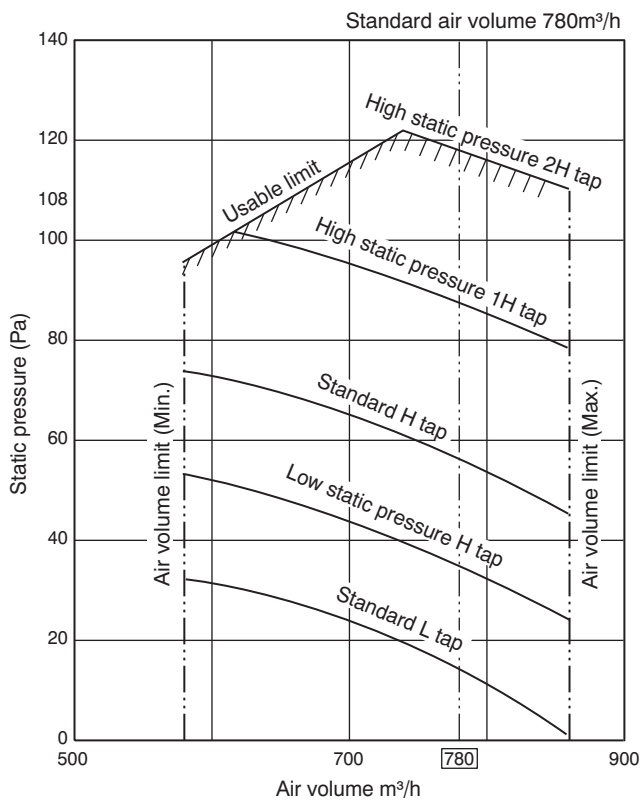
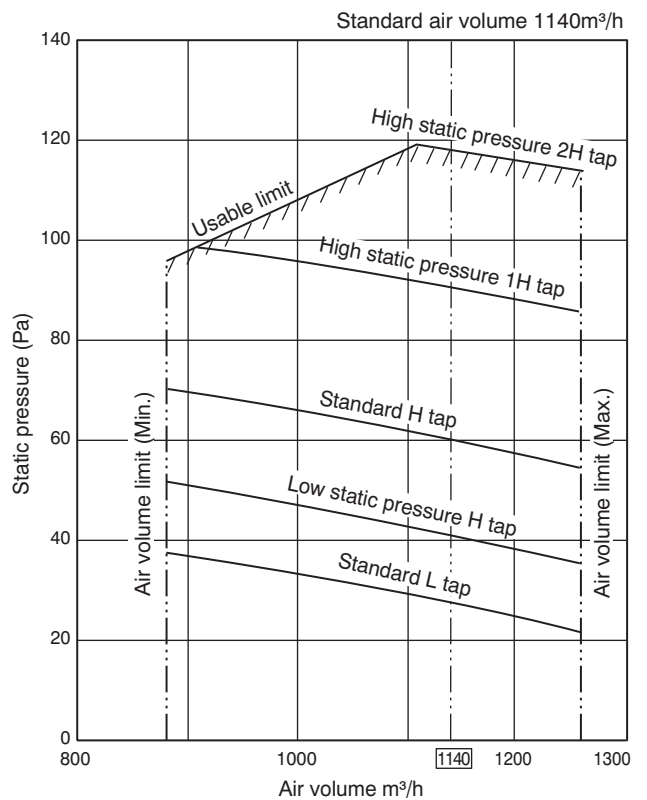
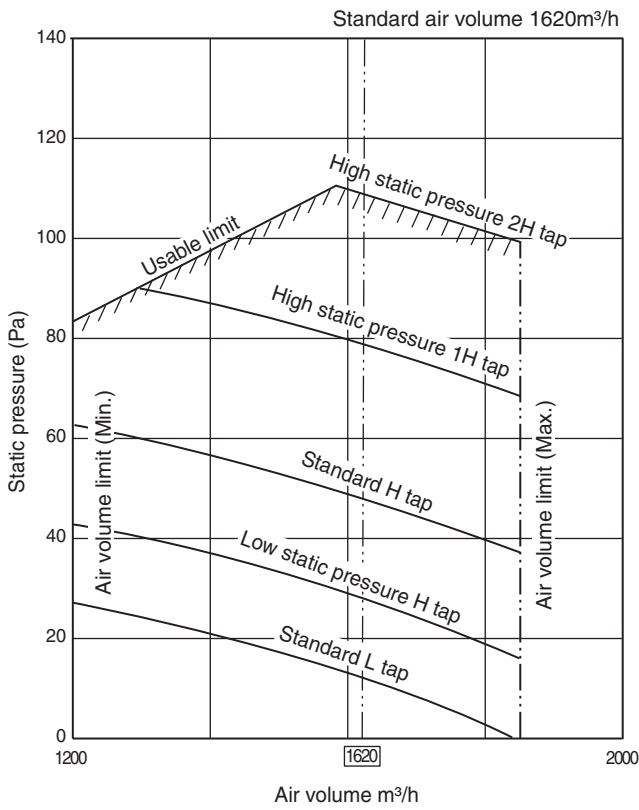

Fig. 4 SM80 type (Square duct)



**Fig. 5 SM110 type (Round duct)**



**Fig. 7 SM140 type (Round duct)**

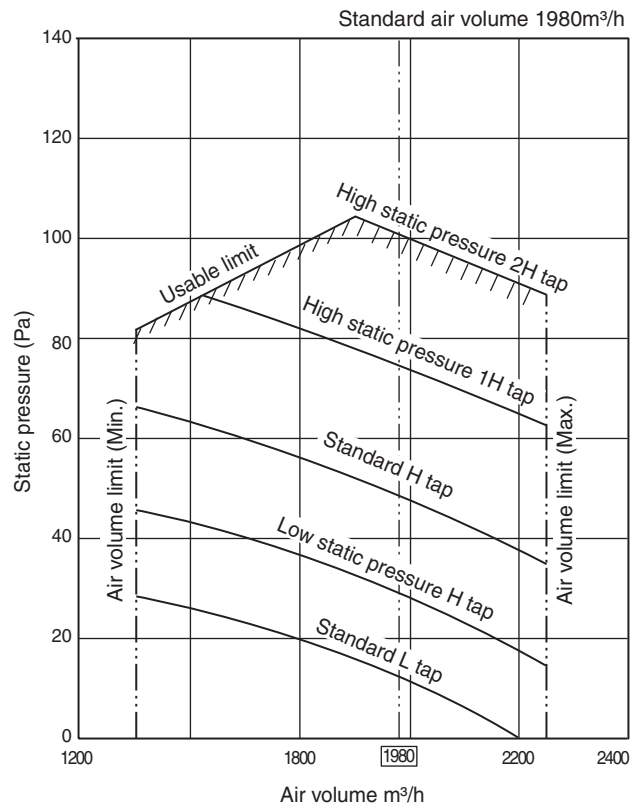

**Fig. 6 SM110 type (Square duct)**

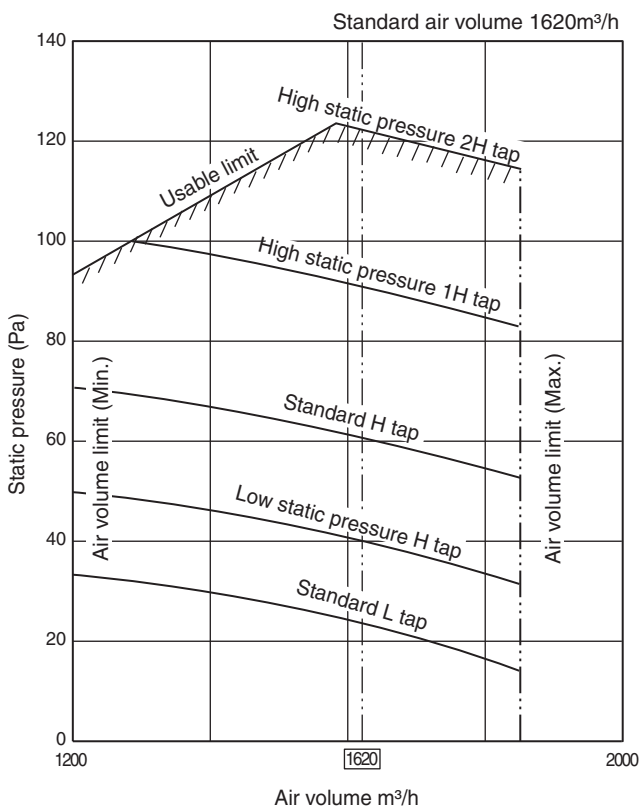

**Fig. 8 SM140 type (Square duct)**

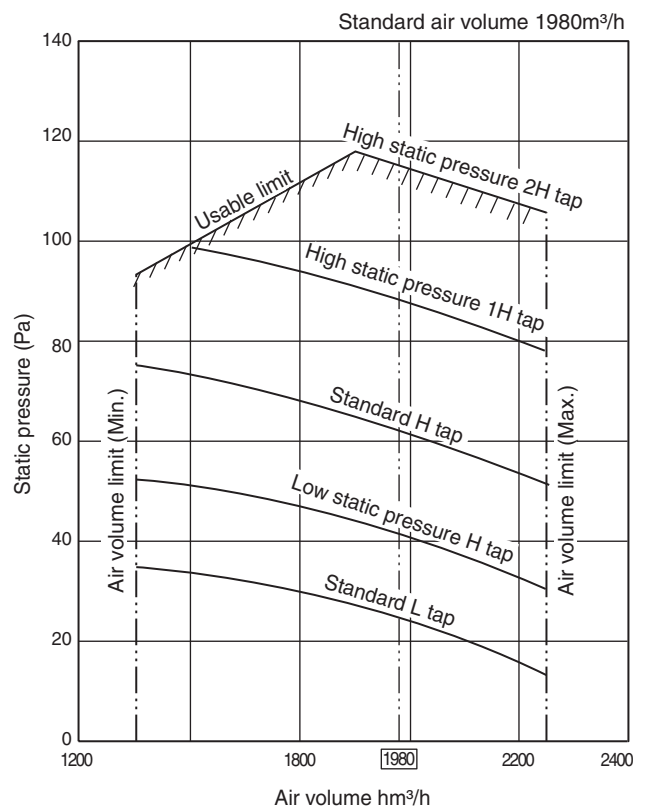

## 2. CONSTRUCTION VIEWS (EXTERNAL VIEWS)

### 2-1. Compact 4-way Cassette Type

RAV-SM404MUT\*, RAV-SM454MUT\*, RAV-SM564MUT\*

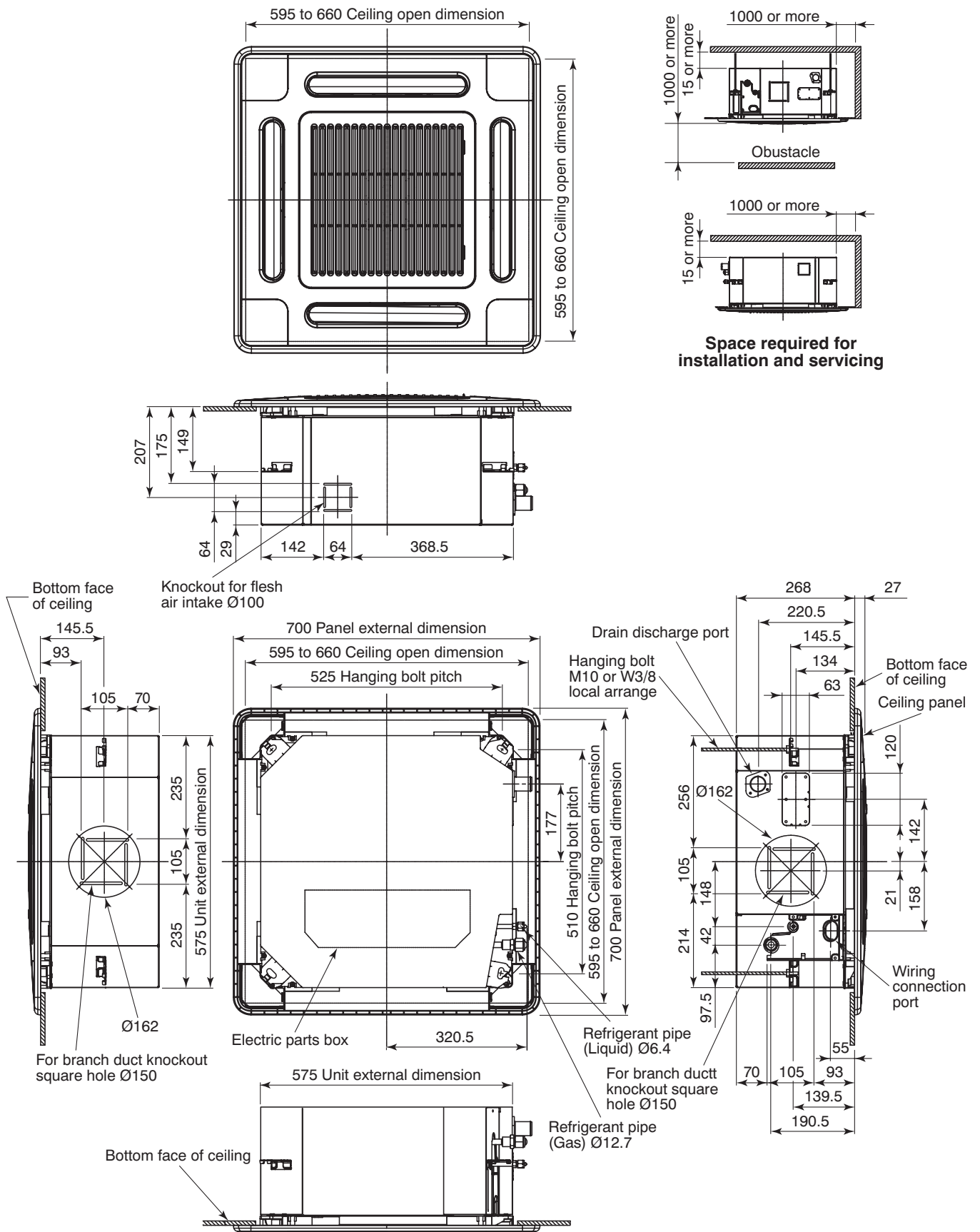

Space required for installation and servicing

## 2-2. Concealed Duct Type

RAV-SM564BT\*, RAV-SM804BT\*, RAV-SM1104BT\*, RAV-SM1404BT\*

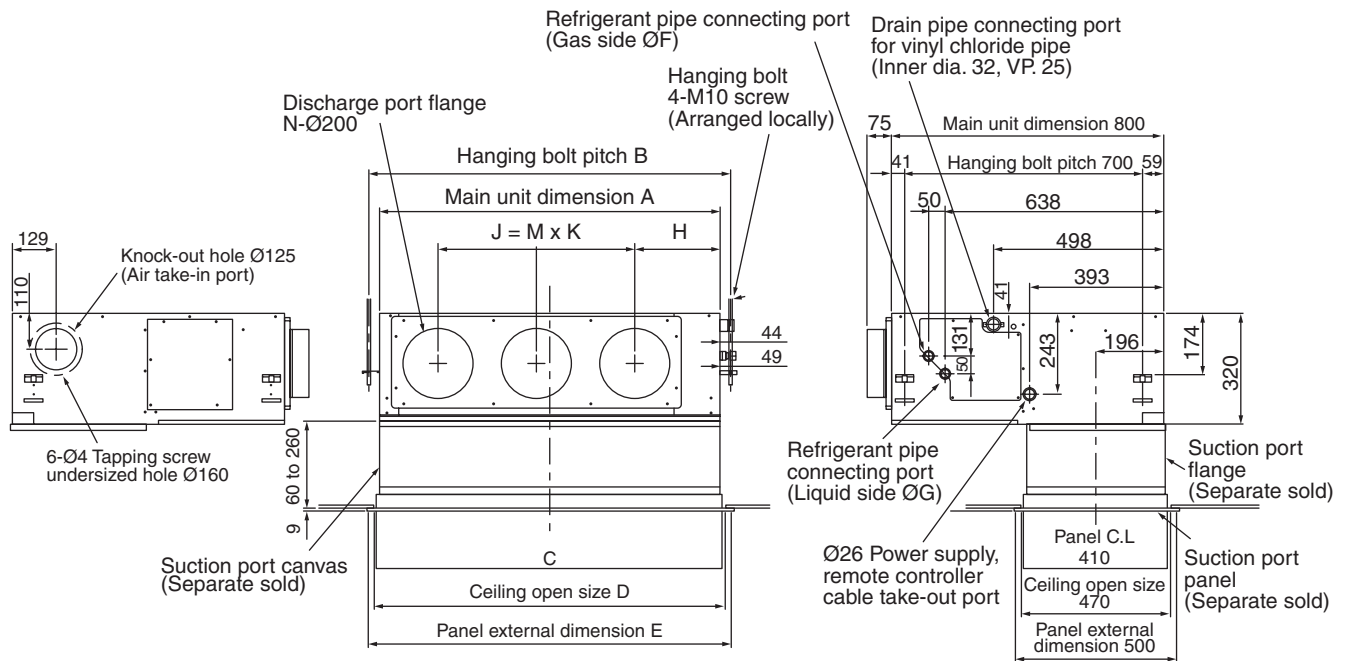

### • Dimension

	A	B	C	D	E	F	G	H	J	K	M	N	O
<b>SM56 type</b>	700	766	690	750	780	12.7	6.4	252	280	280	1	2	410
<b>SM80 type</b>	1000	1066	990	1050	1080	15.9	9.5	252	580	290	2	3	410
<b>SM110 type SM140 type</b>	1350	1416	1340	1400	1430	15.9	9.5	252	930	310	3	4	410

#### NOTE 1 :

For maintenance of the equipment, be sure to install a check port A at the position as shown below.

#### NOTE 2 :

Using the drain up kit sold separately, drain-up by 300 (mm) from drain pipe draw-out port of the main unit is necessary. The drain-up over 300mm or more is impossible.

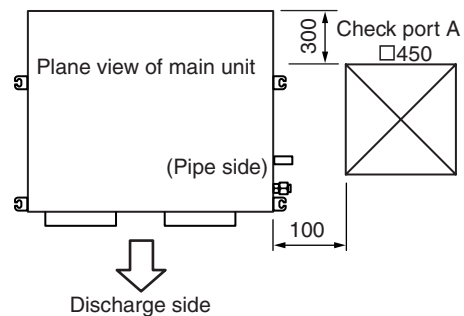

### 2-3. Ceiling Type

RAV-SM564CT\*, RAV-SM804CT\*, RAV-SM1104CT\*, RAV-SM1404CT\*

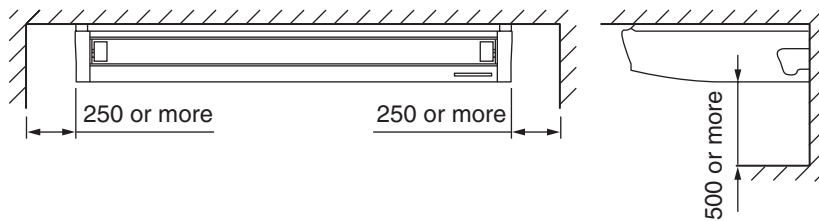
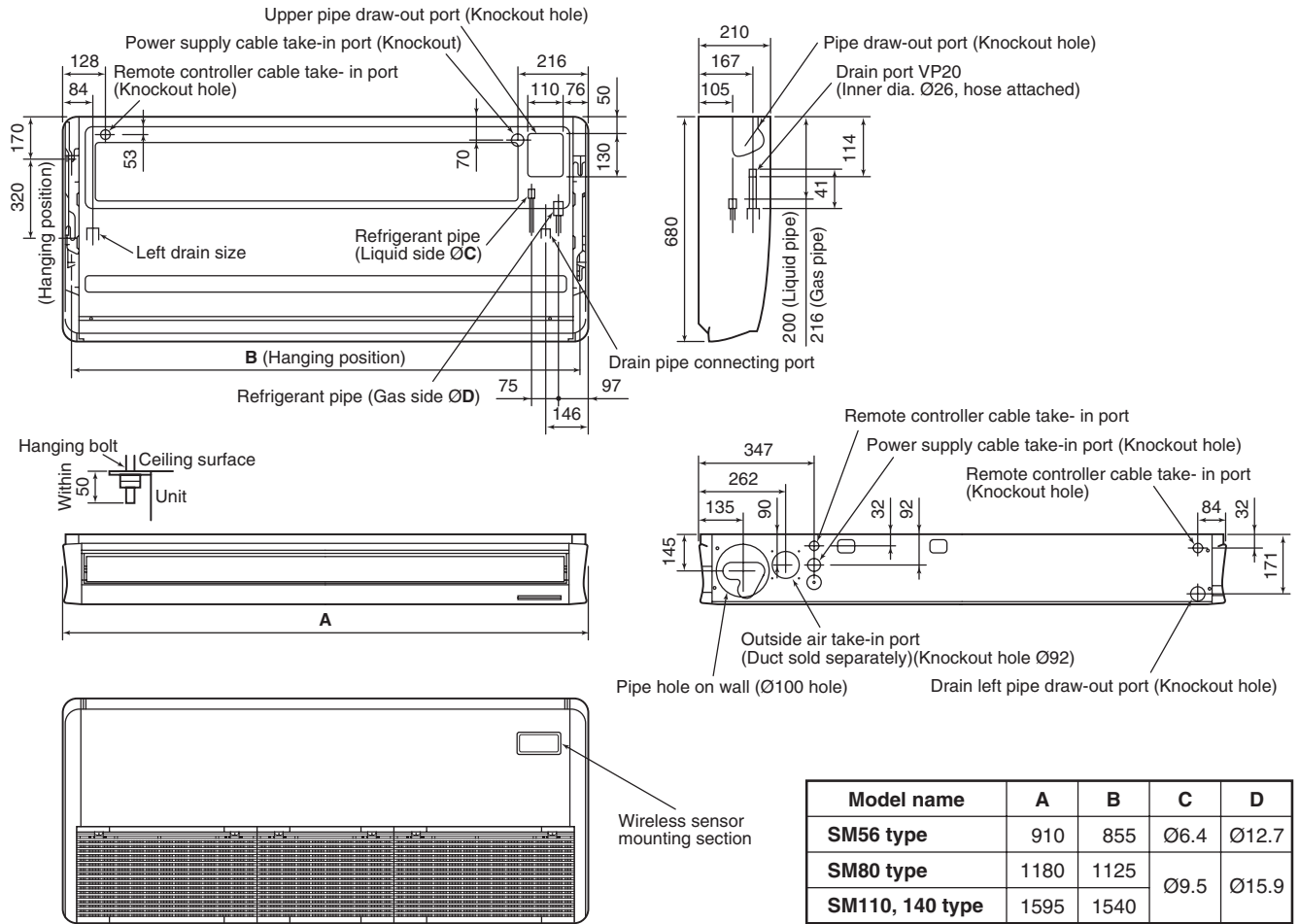

### 3. WIRING DIAGRAM

#### 3-1. Indoor Unit

##### 3-1-1. Compact 4-way Cassette Type

RAV-SM404MUT \*, RAV-SM454MUT \*, RAV-SM564MUT \*

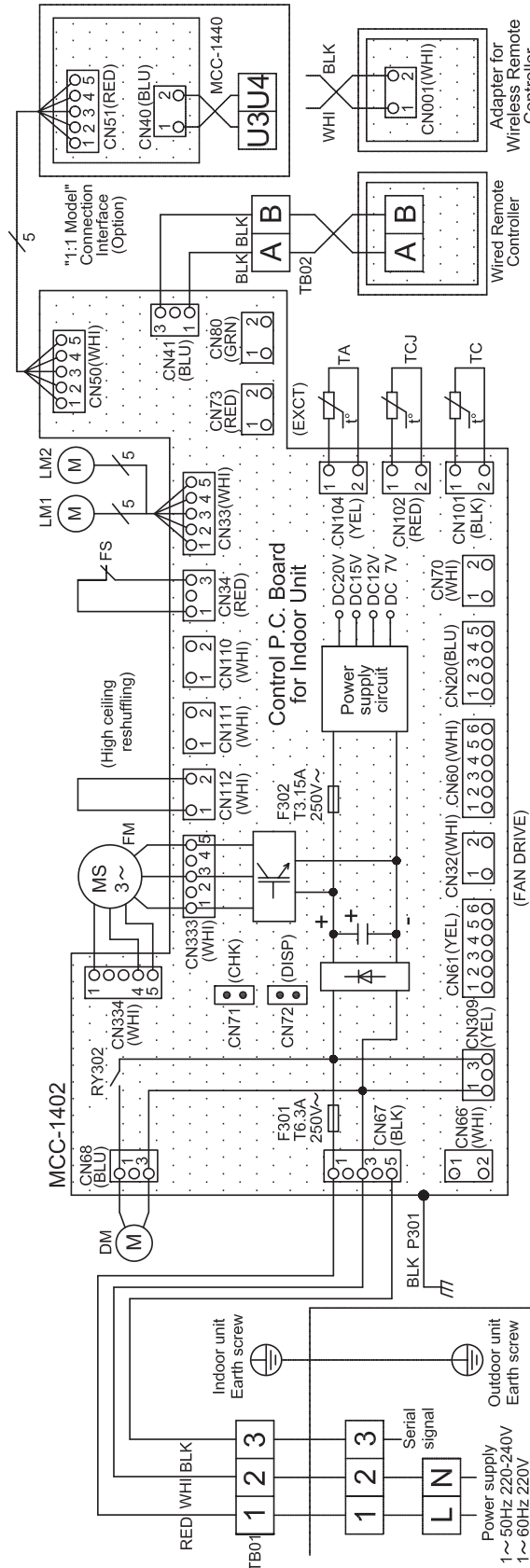

1. Broken line indicate the wiring at site.  
Long dashed short dashed line indicate the accessories.
2. indicates the terminal block.  
 indicates the connection terminal.
3. indicates the connector on the control P.C. board.
4. indicates the protection ground.

COLOR IDENTIFICATION	
RED	: RED
WHI	: WHITE
YEL	: YELLOW
BLU	: BLUE
BLK	: BLACK
GRY	: GRAY
PNK	: PINK
ORN	: ORANGE
BRW	: BROWN
GRN	: GREEN

Symbol	Parts Name
CN**	Connector
DM	Drain Pump Motor
F301,302	Fuse
FM	Fan Motor
LM1,2	Float Switch
RY302	Lower Motor
TA	Drain Control Relay
TB01,02	Indoor temp sensor
TC,TCJ	Terminal Block
	Temp sensor



### 3-1-2. Concealed Duct Type

RAV-SM564BT \*, RAV-SM804BT \*, RAV-SM1104BT \*, RAV-SM1404BT \*

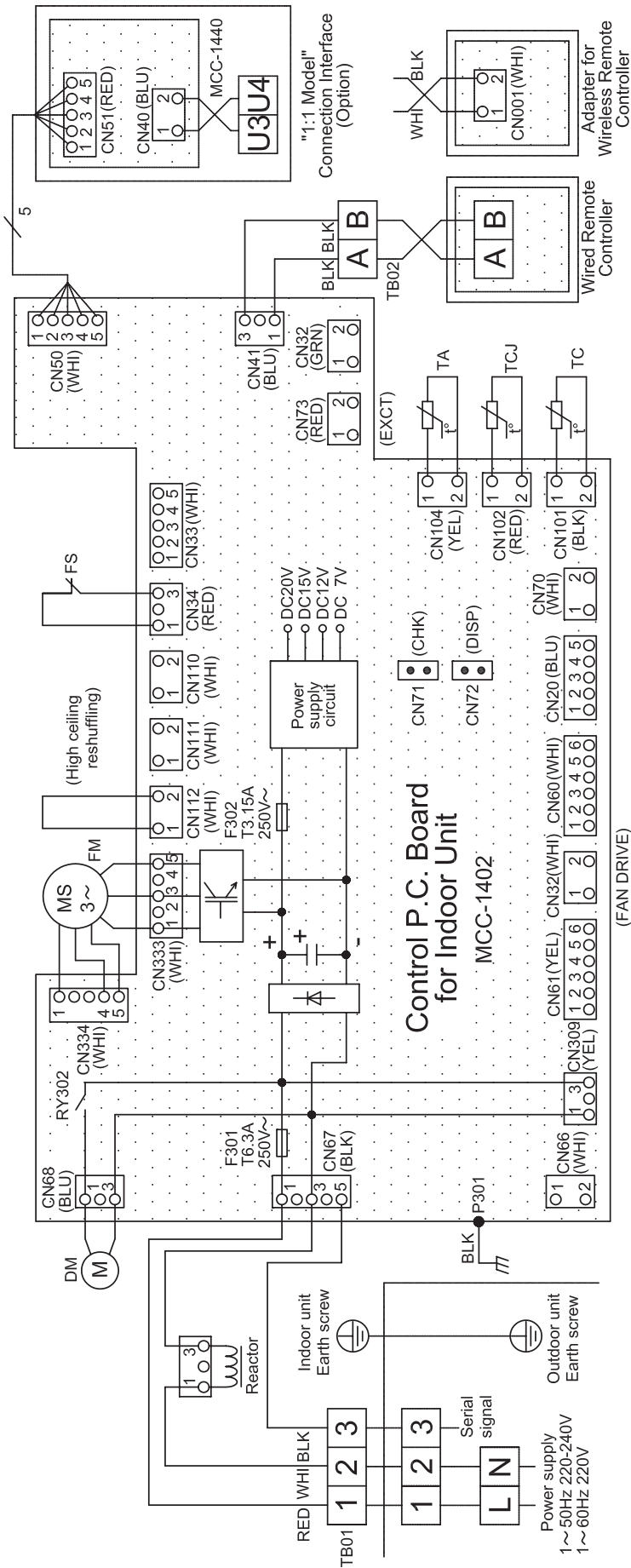

COLOR IDENTIFICATION

RED	: RED
WHI	: WHITE
YEL	: YELLOW
BLU	: BLUE
BLK	: BLACK
GRY	: GRAY
PNK	: PINK
ORN	: ORANGE
BRW	: BROWN
GRN	: GREEN

1. Broken line indicate the wiring at site.  
Long dashed short dashed line indicate the accessories.
2. □ indicates the terminal block.  
—○— indicates the connection terminal.  
□○ indicates the connector on the control P.C. board.
3. ⊕ indicates the protection ground.
4. □□□□ indicates the control P.C. board.

Symbol	Parts Name
CN**	Connector
DM	Drain Pump Motor
F301,302	Fuse
FM	Fan Motor
FS	Float Switch
RY302	Drain Control Relay
TA	Indoor temp sensor
TB01,02	Terminal Block
TC, TCJ	Temp sensor

### 3-1-3. Ceiling Type

RAV-SM564CT \*, RAV-SM804CT \*, RAV-SM1104CT \*, RAV-SM1404CT \*

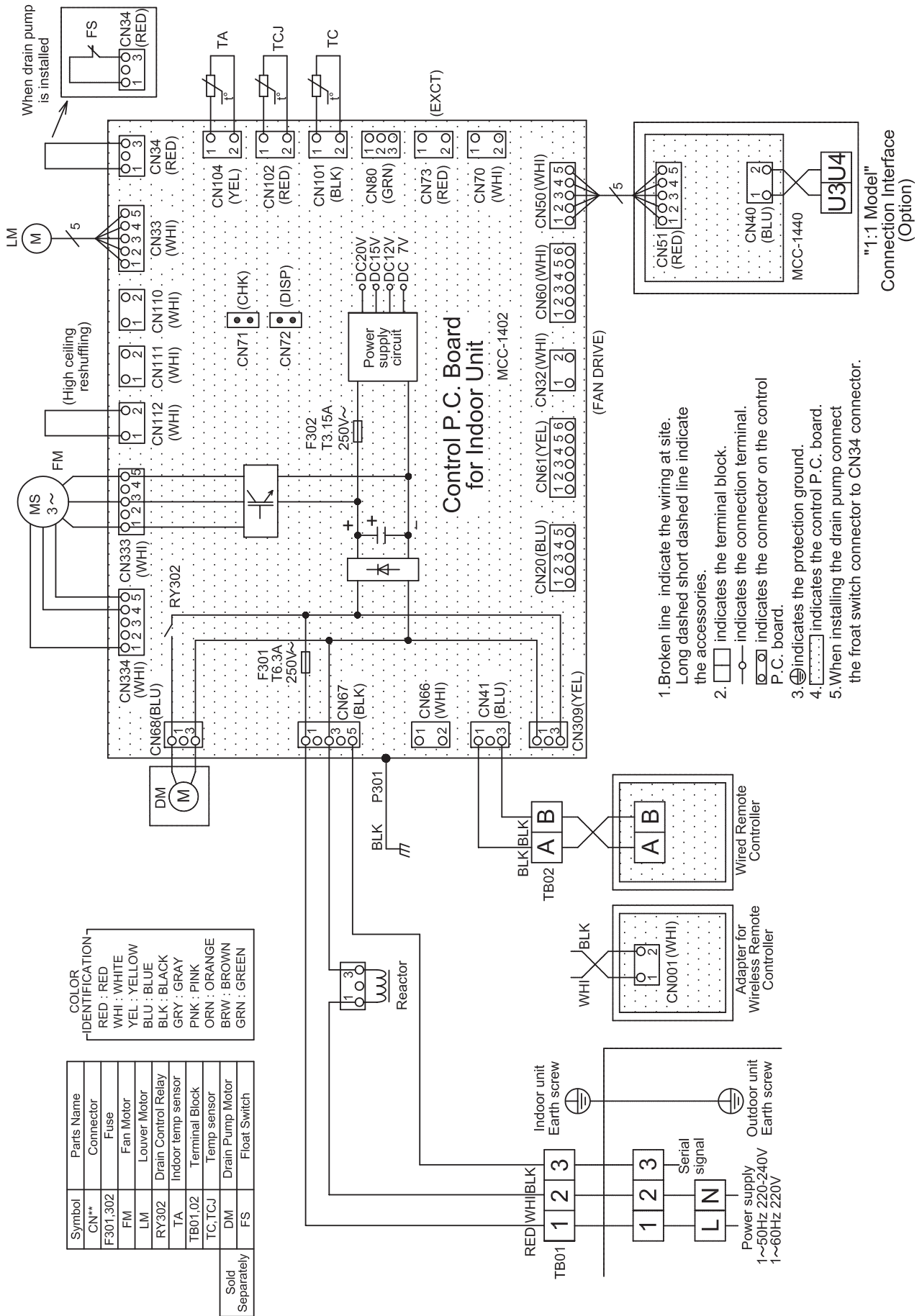

## 4. SPECIFICATIONS OF ELECTRICAL PARTS

### 4-1. Compact 4-way Cassette Type

No.	Parts name	Type	Specifications
1	Fan motor (for indoor)	SWF-230-60-1R	Output (Rated) 60 W, 220–240 V
2	Thermo. sensor (TA-sensor)	155 mm	10 kΩ at 25°C
3	Heat exchanger sensor (TCJ-sensor)	Ø6 mm, 1200 mm	10 kΩ at 25°C
4	Heat exchanger sensor (TC-sensor)	Ø6 mm, 1200 mm	10 kΩ at 25°C
5	Float switch	FS-0218-102	
6	Drain pump motor	ADP-1409	

### 4-2. Concealed Duct Type

No.	Parts name	Type	Specifications
1	Fan motor (SM804BT)	ICF-280-120-1C	Output (Rated) 120 W, 220–240 V
2	Fan motor (SM564BT/SM1104BT/SM1404BT)	ICF-280-120-2C	Output (Rated) 120 W, 220–240 V
3	Thermo. sensor (TA-sensor)	618 mm	10 kΩ at 25°C
4	Heat exchanger sensor (TCJ-sensor)	Ø6 mm, 1200 mm	10 kΩ at 25°C
5	Heat exchanger sensor (TC-sensor)	Ø6 mm, 1200 mm	10 kΩ at 25°C
6	Float switch	FS-0218-102	
7	Drain pump motor	ADP-1409	
8	Reactor	CH-43-2Z-T	10 mH, 1 A

### 4-3. Ceiling Type

No.	Parts name	Type	Specifications
1	Fan motor (SM564CT)	SWF-280-60-1R	Output (Rated) 60 W, 220–240 V
2	Fan motor (SM804CT)	SWF-280-60-2R	Output (Rated) 60 W, 220–240 V
3	Fan motor (SM1104CT/SM1404CT)	SWF-280-120-2R	Output (Rated) 120 W, 220–240 V
4	Thermo. sensor (TA-sensor)	155 mm	10 kΩ at 25°C
5	Heat exchanger sensor (TCJ-sensor)	Ø6 mm, 1200 mm	10 kΩ at 25°C
6	Heat exchanger sensor (TC-sensor)	Ø6 mm, 1200 mm	10 kΩ at 25°C
7	Louver motor	MP24Z2N	DC 15V
8	Reactor	CH-43-2Z-T	10 mH, 1 A

# 5. CONTROL BLOCK DIAGRAM

## 5-1. Indoor Controller Block Diagram

### 5-1-1. In Case of Connection of Wired (Simple) Remote Controller

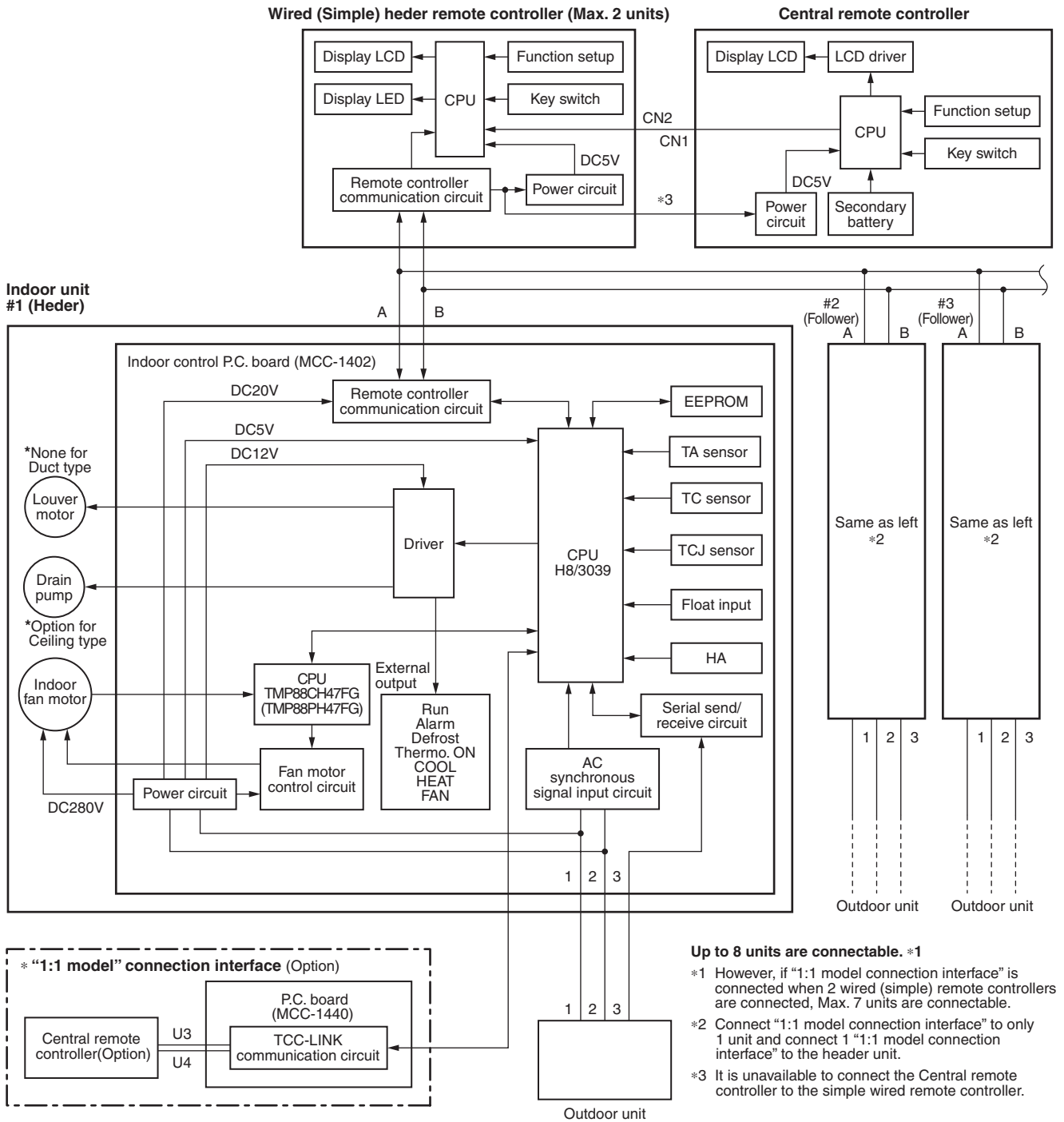

## 5-1-2. In Case of Connection of Wireless Remote Controller

### Indoor unit #1 (Header)

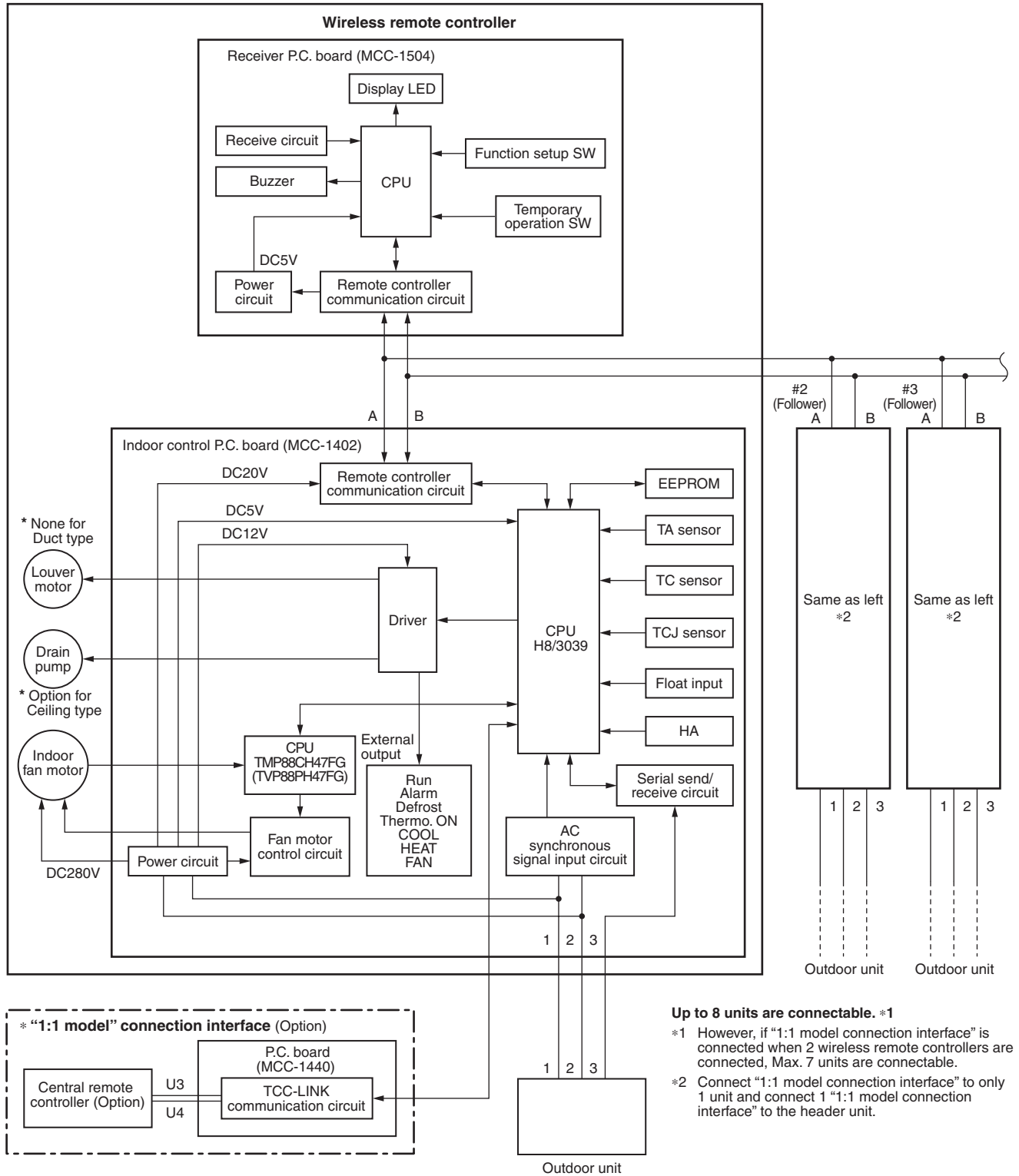

### 5-1-3. Connection of Both Wired (Simple) Remote Controller and Wireless Remote Controller

Indoor unit  
#1 (Header)

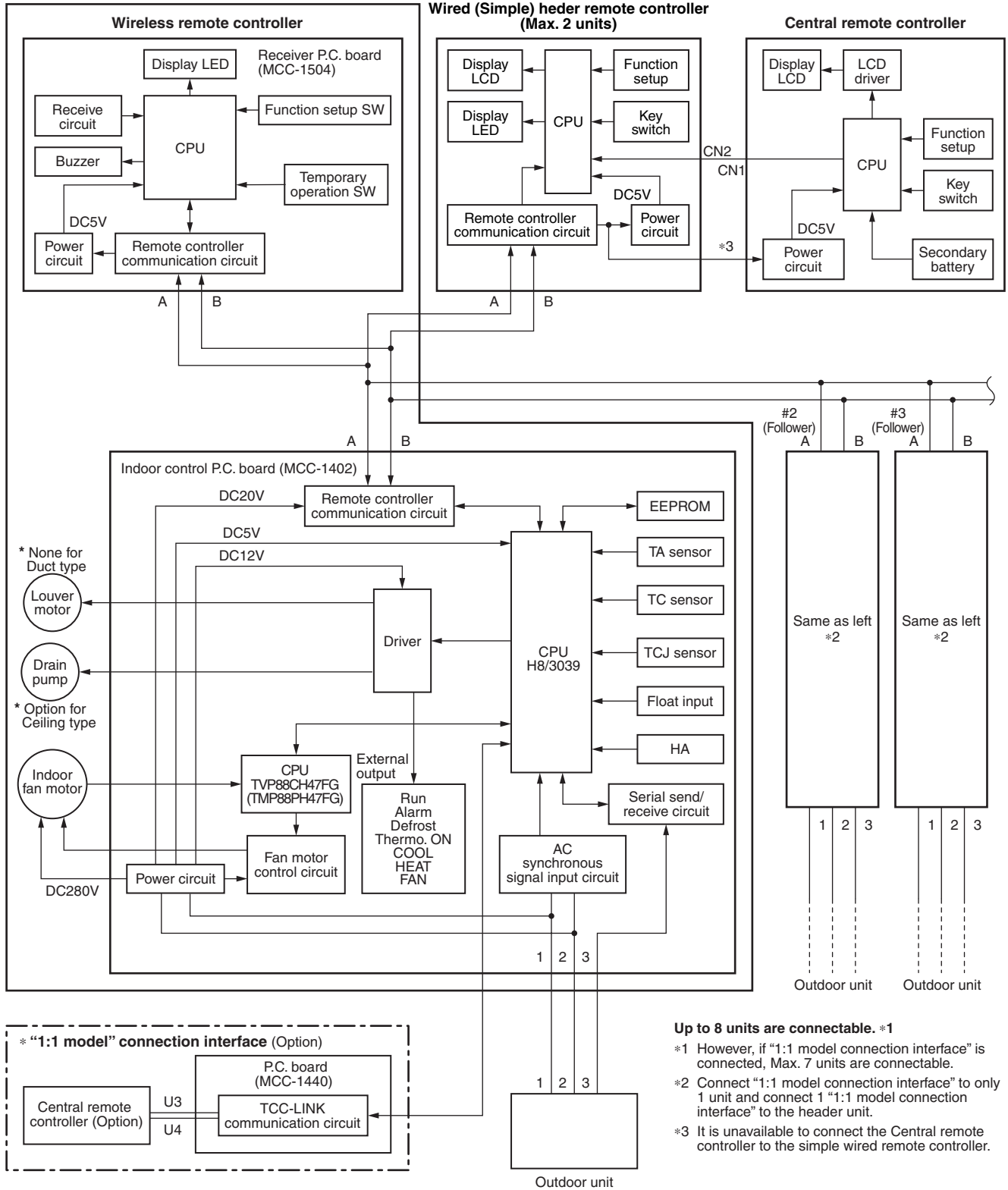

- Up to 8 units are connectable. \*1**
- \*1 However, if "1:1 model connection interface" is connected, Max. 7 units are connectable.
  - \*2 Connect "1:1 model connection interface" to only 1 unit and connect 1 "1:1 model connection interface" to the header unit.
  - \*3 It is unavailable to connect the Central remote controller to the simple wired remote controller.





## 5-2. Control Specifications

No.	Item	Outline of specifications	Remarks																										
1	When power supply is reset	<p>1) Distinction of outdoor unit When the power supply is reset, the outdoors are distinguished and the control is selected according to the distinguished result.</p> <p>2) Setting of indoor fan speed and existence of air direction adjustment Based on EEPROM data, select setting of the indoor fan speed and the existence of air direction adjustment.</p>	Fan speed (rpm)/ Air direction adjustment																										
2	Operation mode selection	<p>1) Based on the operation mode selecting command from the remote controller, the operation mode is selected.</p> <table border="1" style="width: 100%; border-collapse: collapse;"> <thead> <tr> <th style="text-align: center;">Remote controller command</th> <th style="text-align: center;">Control outline</th> </tr> </thead> <tbody> <tr> <td style="text-align: center;">STOP</td> <td style="text-align: center;">Air conditioner stops.</td> </tr> <tr> <td style="text-align: center;">FAN</td> <td style="text-align: center;">Fan operation</td> </tr> <tr> <td style="text-align: center;">COOL</td> <td style="text-align: center;">Cooling operation</td> </tr> <tr> <td style="text-align: center;">DRY</td> <td style="text-align: center;">Dry operation</td> </tr> <tr> <td style="text-align: center;">HEAT</td> <td style="text-align: center;">Heating operation</td> </tr> <tr> <td style="text-align: center;">AUTO</td> <td> <ul style="list-style-type: none"> <li>• COOL/HEAT operation mode is automatically selected by Ta, Ts and To for operation.</li> <li>• The operation is performed as shown in the following figure according to Ta value at the first time only. (In the range of <math>T_s + \alpha - 1 &lt; T_a &lt; T_s + \alpha + 1</math>, Cooling thermo. OFF (Fan)/Setup air volume operation continues.)</li> </ul> <div style="text-align: center; margin-top: 10px;"> </div> <ul style="list-style-type: none"> <li>• <math>\alpha</math> is corrected according to the outside temperature.</li> </ul> <table border="1" style="width: 100%; border-collapse: collapse; margin-top: 10px;"> <thead> <tr> <th style="text-align: center;">Outside temp.</th> <th style="text-align: center;">Correction value (<math>\alpha</math>)</th> </tr> </thead> <tbody> <tr> <td style="text-align: center;">No To</td> <td style="text-align: center;">0K</td> </tr> <tr> <td style="text-align: center;"><math>T_o \geq 24^\circ\text{C}</math></td> <td style="text-align: center;">-1K</td> </tr> <tr> <td style="text-align: center;"><math>24^\circ\text{C} &gt; T_o \geq 18^\circ\text{C}</math></td> <td style="text-align: center;">0K</td> </tr> <tr> <td style="text-align: center;"><math>T_o &lt; 18^\circ\text{C}</math></td> <td style="text-align: center;">+1K</td> </tr> <tr> <td style="text-align: center;">To error</td> <td style="text-align: center;">0K</td> </tr> </tbody> </table> </td> </tr> </tbody> </table> <p style="text-align: right; margin-top: 10px;">Ta: Room temp. Ts: Setup temp. To: Outside temp.</p>	Remote controller command	Control outline	STOP	Air conditioner stops.	FAN	Fan operation	COOL	Cooling operation	DRY	Dry operation	HEAT	Heating operation	AUTO	<ul style="list-style-type: none"> <li>• COOL/HEAT operation mode is automatically selected by Ta, Ts and To for operation.</li> <li>• The operation is performed as shown in the following figure according to Ta value at the first time only. (In the range of <math>T_s + \alpha - 1 &lt; T_a &lt; T_s + \alpha + 1</math>, Cooling thermo. OFF (Fan)/Setup air volume operation continues.)</li> </ul> <div style="text-align: center; margin-top: 10px;"> </div> <ul style="list-style-type: none"> <li>• <math>\alpha</math> is corrected according to the outside temperature.</li> </ul> <table border="1" style="width: 100%; border-collapse: collapse; margin-top: 10px;"> <thead> <tr> <th style="text-align: center;">Outside temp.</th> <th style="text-align: center;">Correction value (<math>\alpha</math>)</th> </tr> </thead> <tbody> <tr> <td style="text-align: center;">No To</td> <td style="text-align: center;">0K</td> </tr> <tr> <td style="text-align: center;"><math>T_o \geq 24^\circ\text{C}</math></td> <td style="text-align: center;">-1K</td> </tr> <tr> <td style="text-align: center;"><math>24^\circ\text{C} &gt; T_o \geq 18^\circ\text{C}</math></td> <td style="text-align: center;">0K</td> </tr> <tr> <td style="text-align: center;"><math>T_o &lt; 18^\circ\text{C}</math></td> <td style="text-align: center;">+1K</td> </tr> <tr> <td style="text-align: center;">To error</td> <td style="text-align: center;">0K</td> </tr> </tbody> </table>	Outside temp.	Correction value ( $\alpha$ )	No To	0K	$T_o \geq 24^\circ\text{C}$	-1K	$24^\circ\text{C} > T_o \geq 18^\circ\text{C}$	0K	$T_o < 18^\circ\text{C}$	+1K	To error	0K	<p style="text-align: right;">K = deg</p>
Remote controller command	Control outline																												
STOP	Air conditioner stops.																												
FAN	Fan operation																												
COOL	Cooling operation																												
DRY	Dry operation																												
HEAT	Heating operation																												
AUTO	<ul style="list-style-type: none"> <li>• COOL/HEAT operation mode is automatically selected by Ta, Ts and To for operation.</li> <li>• The operation is performed as shown in the following figure according to Ta value at the first time only. (In the range of <math>T_s + \alpha - 1 &lt; T_a &lt; T_s + \alpha + 1</math>, Cooling thermo. OFF (Fan)/Setup air volume operation continues.)</li> </ul> <div style="text-align: center; margin-top: 10px;"> </div> <ul style="list-style-type: none"> <li>• <math>\alpha</math> is corrected according to the outside temperature.</li> </ul> <table border="1" style="width: 100%; border-collapse: collapse; margin-top: 10px;"> <thead> <tr> <th style="text-align: center;">Outside temp.</th> <th style="text-align: center;">Correction value (<math>\alpha</math>)</th> </tr> </thead> <tbody> <tr> <td style="text-align: center;">No To</td> <td style="text-align: center;">0K</td> </tr> <tr> <td style="text-align: center;"><math>T_o \geq 24^\circ\text{C}</math></td> <td style="text-align: center;">-1K</td> </tr> <tr> <td style="text-align: center;"><math>24^\circ\text{C} &gt; T_o \geq 18^\circ\text{C}</math></td> <td style="text-align: center;">0K</td> </tr> <tr> <td style="text-align: center;"><math>T_o &lt; 18^\circ\text{C}</math></td> <td style="text-align: center;">+1K</td> </tr> <tr> <td style="text-align: center;">To error</td> <td style="text-align: center;">0K</td> </tr> </tbody> </table>	Outside temp.	Correction value ( $\alpha$ )	No To	0K	$T_o \geq 24^\circ\text{C}$	-1K	$24^\circ\text{C} > T_o \geq 18^\circ\text{C}$	0K	$T_o < 18^\circ\text{C}$	+1K	To error	0K																
Outside temp.	Correction value ( $\alpha$ )																												
No To	0K																												
$T_o \geq 24^\circ\text{C}$	-1K																												
$24^\circ\text{C} > T_o \geq 18^\circ\text{C}$	0K																												
$T_o < 18^\circ\text{C}$	+1K																												
To error	0K																												
3	Room temp. control	<p>1) Adjustment range: Remote controller setup temperature ( °C )</p> <table border="1" style="width: 100%; border-collapse: collapse; margin-top: 10px;"> <thead> <tr> <th></th> <th style="text-align: center;">COOL/DRY</th> <th style="text-align: center;">HEAT</th> <th style="text-align: center;">AUTO</th> </tr> </thead> <tbody> <tr> <td style="text-align: center;">Wired type</td> <td style="text-align: center;">18°C to 29°C</td> <td style="text-align: center;">18°C to 29°C</td> <td style="text-align: center;">18°C to 29°C</td> </tr> <tr> <td style="text-align: center;">Wireless type</td> <td style="text-align: center;">18°C to 30°C</td> <td style="text-align: center;">16°C to 30°C</td> <td style="text-align: center;">17°C to 27°C</td> </tr> </tbody> </table>		COOL/DRY	HEAT	AUTO	Wired type	18°C to 29°C	18°C to 29°C	18°C to 29°C	Wireless type	18°C to 30°C	16°C to 30°C	17°C to 27°C															
	COOL/DRY	HEAT	AUTO																										
Wired type	18°C to 29°C	18°C to 29°C	18°C to 29°C																										
Wireless type	18°C to 30°C	16°C to 30°C	17°C to 27°C																										

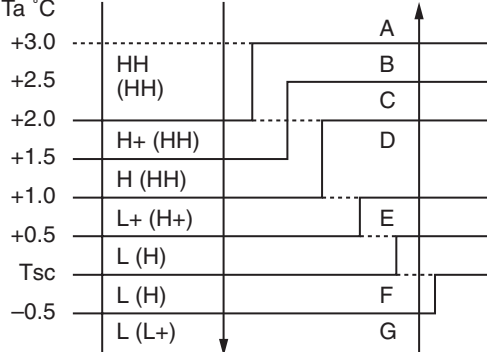
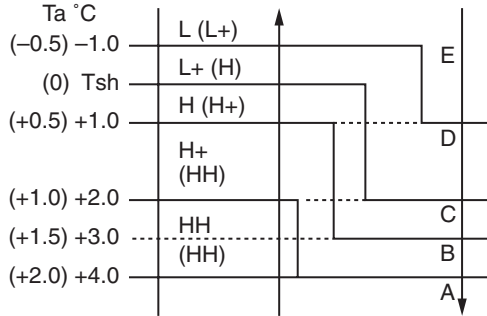
No.	Item	Outline of specifications	Remarks												
3	Room temp. control (Continued)	2) Using the CODE No. 06, the setup temperature in heating operation can be corrected. <table border="1" data-bbox="443 286 1096 394"> <tr> <td><b>SET DATA</b></td> <td><b>0</b></td> <td><b>2</b></td> <td><b>4</b></td> <td><b>6</b></td> </tr> <tr> <td><b>Setup temp. correction</b></td> <td>+0°C</td> <td>+2°C</td> <td>+4°C</td> <td>+6°C</td> </tr> </table> Setting at shipment <table border="1" data-bbox="443 450 754 490"> <tr> <td><b>SET DATA</b></td> <td>2</td> </tr> </table>	<b>SET DATA</b>	<b>0</b>	<b>2</b>	<b>4</b>	<b>6</b>	<b>Setup temp. correction</b>	+0°C	+2°C	+4°C	+6°C	<b>SET DATA</b>	2	Shift of suction temperature in heating operation
<b>SET DATA</b>	<b>0</b>	<b>2</b>	<b>4</b>	<b>6</b>											
<b>Setup temp. correction</b>	+0°C	+2°C	+4°C	+6°C											
<b>SET DATA</b>	2														
4	Automatic capacity control (GA control)	1) Based on the difference between Ta and Ts, the operation frequency is instructed to the outdoor unit. 2) Cooling operation Every 90 seconds, the room temperature difference between temperature detected by Ta and Ts and the varied room temperature value are calculated to obtain the correction value of the frequency command and then the present frequency command is corrected. $Ta(n) - Ts(n)$ : Room temp. difference $n$ : Counts of detection $Ta(n-1) - Ts(n)$ : Varied room temp. value $n - 1$ : Counts of detection of 90 seconds before 3) Heating operation Every 1 minute (60 sec.), the room temperature difference between temperature detected by Ta and Ts and the varied room temperature value are calculated to obtain the correction value of the frequency command and then the present frequency command is corrected. $Ts(n) - Ta(n)$ : Room temp. difference $n$ : Counts of detection $Ta(n) - Ta(n - 1)$ : Varied room temp. value $n - 1$ : Counts of detection of 1 minute before 4) Dry operation The frequency correction control is same as those of the cooling operation. However the maximum frequency is limited to approximately "S6". <b>Note)</b> When LOW is set up, the maximum frequency is limited to approximately "SB".													
5	Automatic cooling/heating control	1) The judgment of selecting COOL/HEAT is carried out as shown below. When +1.5°C exceeds against Tsh 10 minutes and after thermo. OFF, heating operation (Thermo. OFF) exchanges to cooling operation. Description in the parentheses shows an example of cooling ON/OFF. <div data-bbox="533 1688 1002 1883" style="text-align: center;"> </div> When -1.5°C lowers against Tsc 10 minutes and after thermo. OFF, cooling operation (Thermo. OFF) exchanges to heating operation. 2) For the automatic capacity control after judgment of cooling/heating, see Item 4. 3) For temperature correction of room temp. control in automatic heating, see Item 3.	Tsc: Setup temp. in cooling operation Tsh: Setup temp. in heating operation + temp. correction of room temp. control												

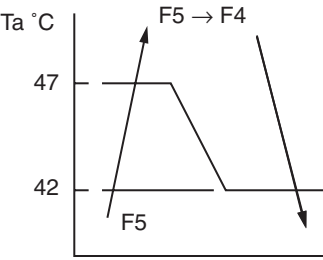

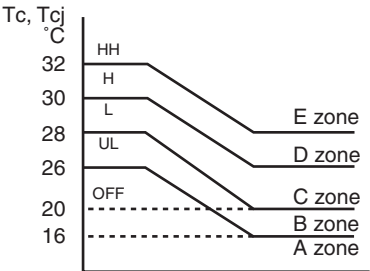



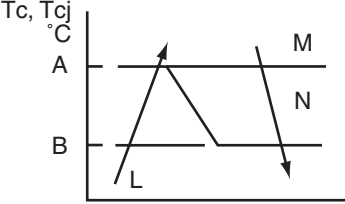

No.	Item	Outline of specifications	Remarks
6	Fan speed control	<p>1) Operation with (HH), (H), (L) or [AUTO] mode is carried out by the command from the remote controller.</p> <p>2) When the fan speed mode [AUTO] is selected, the fan speed varies by the difference between Ta and Ts.</p> <p>&lt;COOL&gt;</p>  <ul style="list-style-type: none"> <li>• Controlling operation in case when thermostat of remote controller works is same as a case when thermostat of the body works.</li> <li>• If the fan speed has been changed once, it is not changed for 3 minutes. However when the air volume is exchanged, the fan speed changes.</li> <li>• When cooling operation has started, select a downward slope for the fan speed, that is, the high position.</li> <li>• If the temperature is just on the difference boundary, the fan speed does not change.</li> <li>• Mode in the parentheses indicates one in automatic cooling operation.</li> </ul> <p>&lt;HEAT&gt;</p>  <p>Value in the parentheses indicates one when thermostat of the remote controller works. Value without parentheses indicates one when thermostat of the body works.</p> <ul style="list-style-type: none"> <li>• If the fan speed has been changed once, it is not changed for 1 minute. However when the fan speed exchanged, the fan speed changes.</li> <li>• When heating operation has started, select an upward slope for the fan speed, that is, the high position.</li> <li>• If the temperature is just on the difference boundary, the fan speed does not change.</li> <li>• Mode in the parentheses indicates one in automatic heating operation.</li> <li>• In <math>T_c \geq 60^\circ\text{C}</math>, the fan speed increases by 1 step.</li> </ul>	<p>HH &gt; H+ &gt; H &gt; L+ &gt; L &gt; UL</p> <p>Tc: Indoor heat exchanger sensor temperature</p>

No.	Item	Outline of specifications	Remarks																																																																																																																																																								
6	Fan speed control (Continued)	<p><b>(Ceiling type)</b></p> <table border="1" data-bbox="475 264 1169 792"> <thead> <tr> <th rowspan="2">CODE No. [5d]</th> <th colspan="2">Standard</th> <th colspan="2">Type 1</th> <th colspan="2">Type 3</th> <th colspan="2">Type 6</th> </tr> <tr> <th colspan="2">0000</th> <th colspan="2">0001</th> <th colspan="2">0002</th> <th colspan="2">0003</th> </tr> <tr> <th>SW501 (1)/(2)</th> <th colspan="2">OFF/OFF</th> <th colspan="2">ON/OFF</th> <th colspan="2">OFF/ON</th> <th colspan="2">ON/ON</th> </tr> <tr> <th>Tap</th> <th>HEAT</th> <th>COOL</th> <th>HEAT</th> <th>COOL</th> <th>HEAT</th> <th>COOL</th> <th>HEAT</th> <th>COOL</th> </tr> </thead> <tbody> <tr> <td>F1</td> <td></td> <td></td> <td></td> <td></td> <td>HH</td> <td>HH</td> <td>HH</td> <td>HH</td> </tr> <tr> <td>F2</td> <td></td> <td></td> <td>HH</td> <td>HH</td> <td></td> <td></td> <td></td> <td></td> </tr> <tr> <td>F3</td> <td></td> <td></td> <td></td> <td>H+</td> <td>H+, H</td> <td>H+, H</td> <td>H+, H L+, L</td> <td>H+, H L+, L</td> </tr> <tr> <td>F4</td> <td></td> <td></td> <td>H+</td> <td></td> <td></td> <td></td> <td></td> <td></td> </tr> <tr> <td>F5</td> <td></td> <td>HH</td> <td></td> <td>H</td> <td></td> <td></td> <td></td> <td></td> </tr> <tr> <td>F6</td> <td>HH</td> <td></td> <td>H</td> <td></td> <td>L+</td> <td>L+</td> <td></td> <td></td> </tr> <tr> <td>F7</td> <td>H+</td> <td>H+</td> <td></td> <td></td> <td>L</td> <td>L</td> <td></td> <td></td> </tr> <tr> <td>F8</td> <td></td> <td>H</td> <td></td> <td>L+</td> <td></td> <td></td> <td></td> <td></td> </tr> <tr> <td>F9</td> <td>H</td> <td></td> <td>L+</td> <td>L</td> <td></td> <td></td> <td></td> <td></td> </tr> <tr> <td>FA</td> <td></td> <td>L+</td> <td>L</td> <td></td> <td></td> <td></td> <td></td> <td></td> </tr> <tr> <td>FB</td> <td>L+</td> <td>L</td> <td></td> <td></td> <td></td> <td></td> <td></td> <td></td> </tr> <tr> <td>FC</td> <td>L</td> <td></td> <td></td> <td></td> <td></td> <td></td> <td></td> <td></td> </tr> <tr> <td>FD</td> <td></td> <td>UL</td> <td></td> <td>UL</td> <td></td> <td>UL</td> <td></td> <td>UL</td> </tr> </tbody> </table> <p data-bbox="459 824 1189 1131">           3) In heating operation, the mode changes to [UL] if thermostat is turned off.            4) If <math>T_a \geq 25^\circ\text{C}</math> when heating operation has started and when defrost operation has been cleared, the air conditioner operates with (H) mode or higher mode for 1 minute after <math>T_c</math> entered in E zone of cool air discharge preventive control (No. 7).            5) In automatic cooling/heating operation, the revolution frequency of (HH) is set larger than that in the standard cooling/heating operation.         </p>  <p data-bbox="805 1227 1189 1344">However the revolution frequency is restricted in the automatic heating operation as shown in the following figure.</p> <p data-bbox="459 1422 1189 1512">           6) Self-clean operation            When performing self-clean operation after stopping the cooling operation, the mode becomes 210 rpm.         </p>	CODE No. [5d]	Standard		Type 1		Type 3		Type 6		0000		0001		0002		0003		SW501 (1)/(2)	OFF/OFF		ON/OFF		OFF/ON		ON/ON		Tap	HEAT	COOL	HEAT	COOL	HEAT	COOL	HEAT	COOL	F1					HH	HH	HH	HH	F2			HH	HH					F3				H+	H+, H	H+, H	H+, H L+, L	H+, H L+, L	F4			H+						F5		HH		H					F6	HH		H		L+	L+			F7	H+	H+			L	L			F8		H		L+					F9	H		L+	L					FA		L+	L						FB	L+	L							FC	L								FD		UL		UL		UL		UL	<p data-bbox="1217 253 1412 347">Selection of high ceiling type CODE No.: 5d</p> <p data-bbox="1217 958 1444 1070">However only when the high ceiling selection is set to [Standard]</p> <p data-bbox="1217 1429 1412 1485">[Self-clean  </p>
CODE No. [5d]	Standard			Type 1		Type 3		Type 6																																																																																																																																																			
	0000		0001		0002		0003																																																																																																																																																				
SW501 (1)/(2)	OFF/OFF		ON/OFF		OFF/ON		ON/ON																																																																																																																																																				
Tap	HEAT	COOL	HEAT	COOL	HEAT	COOL	HEAT	COOL																																																																																																																																																			
F1					HH	HH	HH	HH																																																																																																																																																			
F2			HH	HH																																																																																																																																																							
F3				H+	H+, H	H+, H	H+, H L+, L	H+, H L+, L																																																																																																																																																			
F4			H+																																																																																																																																																								
F5		HH		H																																																																																																																																																							
F6	HH		H		L+	L+																																																																																																																																																					
F7	H+	H+			L	L																																																																																																																																																					
F8		H		L+																																																																																																																																																							
F9	H		L+	L																																																																																																																																																							
FA		L+	L																																																																																																																																																								
FB	L+	L																																																																																																																																																									
FC	L																																																																																																																																																										
FD		UL		UL		UL		UL																																																																																																																																																			
7	Cool air discharge preventive control	<p data-bbox="459 1545 1189 1765">           1) In heating operation, the indoor fan is controlled based on the detected temperature of <math>T_c</math> sensor or <math>T_{cj}</math> sensor. As shown below, the upper limit of the revolution frequency is restricted.            However B zone is assumed as C zone for 6 minutes and after when the compressor activated.            In defrost operation, the control value of <math>T_c</math> is shifted by <math>6^\circ\text{C}</math>.         </p> 	<p data-bbox="1217 1545 1444 1848">           In D and E zones, the priority is given to air volume selection setup of remote controller.            In A zone while thermo is ON, [PRE-HEAT  </p>																																																																																																																																																								

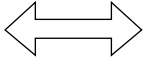
No.	Item	Outline of specifications	Remarks
8	Freeze preventive control (Low temperature release)	<p>1) The cooling operation (including Dry operation) is performed as follows based on the detected temperature of Tc sensor or Tcj sensor.</p> <p>When [J] zone is detected for 6 minutes (Following figure), the commanded frequency is decreased from the real operation frequency.</p> <p>After then the commanded frequency changes every 30 seconds while operation is performed in [J] zone.</p> <p>In [K] zone, time counting is interrupted and the operation is held.</p> <p>When [ I ] zone is detected, the timer is cleared and the operation returns to the normal operation.</p> <p>If the commanded frequency becomes S0 because the operation continues in [J] zone, the return temperature A is raised from 5°C to 12°C until [ I ] zone is detected and the indoor fan operates with [L] mode.</p> <div data-bbox="644 837 991 1032" data-label="Figure"> </div> <p>In heating operation, the freeze-preventive control works if 4-way valve is not exchanged and the following conditions are satisfied. (However the temperature for J zone dashing control is changed from 2°C to -5°C.)</p> <p><b>&lt;Conditions&gt;</b></p> <ul style="list-style-type: none"> <li>• When ① or ② is established 5 minutes after activation.</li> <li>① <math>T_{cn} \leq T_c(n-1) - 5</math></li> <li>② <math>T_{cn} &lt; T_c(n-1) - 1</math> and <math>T_{cn} \leq T_a &lt; 5^\circ\text{C}</math></li> </ul>	<p><b>Tcj:</b> Indoor heat exchanger sensor temperature</p> <p><b>Tcn:</b> Tc temperature when 5 minutes elapsed after activation</p> <p><b>Tc (n – 1):</b> Tc temperature at start time</p>

No.	Item	Outline of specifications	Remarks						
9	High-temp. release control	<p>1) The heating operation is performed as follows based on the detected temperature of Tc sensor or Tcj sensor.</p> <ul style="list-style-type: none"> <li>• When [M] zone is detected, the commanded frequency is decreased from the real operation frequency. After then the commanded frequency changes every 30 seconds while operation is performed in [M] zone.</li> <li>• In [N] zone, the commanded frequency is held.</li> <li>• When [L] zone is detected, the commanded frequency is returned to the original value by approx. 6Hz every 60 seconds.</li> </ul> <p><b>Setup at shipment</b></p> <table border="1" data-bbox="437 600 679 719"> <thead> <tr> <th colspan="2">Control temp. °C</th> </tr> <tr> <th>A</th> <th>B</th> </tr> </thead> <tbody> <tr> <td>56 (54)</td> <td>52 (52)</td> </tr> </tbody> </table>  <p><b>NOTE:</b> When the operation has started or when Tc or Tcj &lt; 30°C at start of the operation or after operation start, temperature is controlled between values in parentheses of A and B.</p>	Control temp. °C		A	B	56 (54)	52 (52)	<p>However this control is ignored in case of the follower unit of the twin.</p> <p>Same status as that when “thermostat-OFF” (status that the air conditioner enters in the room temp. monitor mode when the temperature reached the setup temperature on the remote controller)</p>
Control temp. °C									
A	B								
56 (54)	52 (52)								
10	Drain pump control (The ceiling type is optional)	<ol style="list-style-type: none"> <li>1) In cooling operation (including Dry operation), the drain pump is usually operated.</li> <li>2) If the float switch works while drain pump drives, the compressor stops, the drain pump continues the operation, and a check code is output.</li> <li>3) If the float switch works while drain pump stops, the compressor stops and the drain pump operates. If the float switch keeps operating for approx. 4 minutes, a check code is output.</li> </ol>	Check code [P10]						
11	After-heat elimination	When heating operation stops, in some cases, the indoor fan operates with (L) for approx. 30 seconds.							



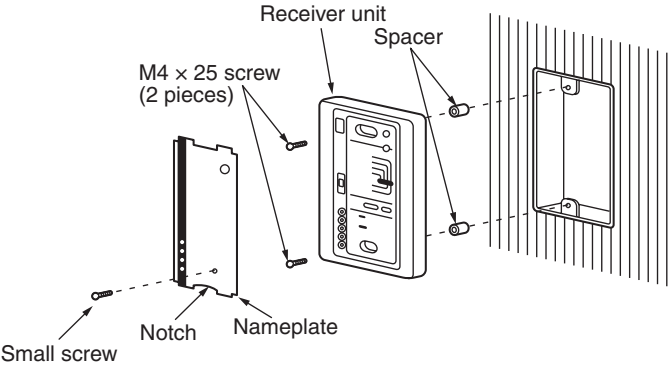

No.	Item	Outline of specifications	Remarks
12	Louver control: Compact 4-way type only	<p>1) Louver position setup</p> <ul style="list-style-type: none"> <li>When the louver position is changed, the position moves necessarily to downward discharge position once to return to the set position.</li> <li>The louver position can be set up in the following operation range.</li> </ul> <p><b>In cooling/dry operation</b>                      <b>In heating/fan operation</b></p> <div style="display: flex; justify-content: space-around; align-items: center;">   </div> <ul style="list-style-type: none"> <li>In group twin/triple operation, the louver positions can be set up collectively or individually.</li> </ul> <p>2) Swing setup</p> <ul style="list-style-type: none"> <li>[SWING] is displayed and the following display is repeated.</li> </ul> <p style="text-align: center;"><b>In all operations</b></p> <div style="display: flex; justify-content: center; align-items: center;">    </div> <p style="text-align: center;">(Repeats)</p> <ul style="list-style-type: none"> <li>In group twin operation, the louver positions can be set up collectively or individually.</li> </ul> <p>3) When the unit stopped or the warning was output, the louver is automatically set to full closed position.</p> <p>4) When PRE-HEAT (Heating ready) is displayed (Heating operation started or defrost operation is performed), heating thermo is off or self-cleaning is performed, the louver is automatically set to horizontal discharge position.</p> <p>* The louver which air direction is individually set or the locked louver closes fully when the unit stops and the louver is automatically set to horizontal discharge position when PRE-HEAT (Heating ready) is displayed, heating thermo is off or self-cleaning is performed.</p>	<p>The swinging louver moves usually up to the ceiling side from the louver position of the set time.</p>







No.	Item	Outline of specifications	Remarks
13	(Continued) For ceiling type only	<p>1) Louver position setup</p> <ul style="list-style-type: none"> <li>When the louver position is changed, the position moves necessarily to downward discharge position once to return to the set position.</li> <li>The louver position can be set up in the following operation range.</li> </ul> <p><b>In cooling/dry operation      In heating/fan operation</b></p>  <ul style="list-style-type: none"> <li>In group operation, the louver positions can be set up collectively or individually.</li> </ul> <p>2) Swing setup</p> <ul style="list-style-type: none"> <li>The swinging position can be moved in the following operation range.</li> </ul> <p><b>All modes</b></p>  <ul style="list-style-type: none"> <li>In group operation, the swinging positions can be set up collectively or individually.</li> </ul> <p>3) When the unit stops or when a warning is output, the louver automatically moves downward.</p> <p>4) While the heating operation is ready or self cleaning, the louver automatically moves upward.</p>	<p><b>Alarm :</b> A check code is displayed on the remote controller, and the indoor unit stops. (Excluding [F08] and [L31])</p>

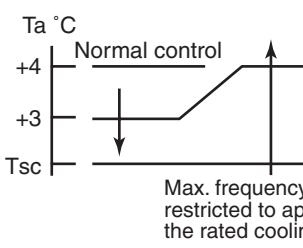
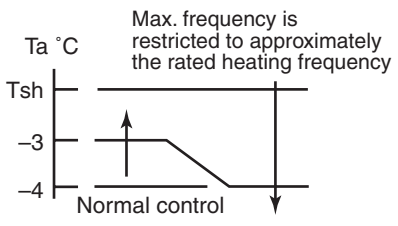



No.	Item	Outline of specifications	Remarks
13	Frequency fixed operation (Test run)	<p><b>&lt;In case of wired remote controller&gt;</b></p> <ol style="list-style-type: none"> <li>1) When pushing [CHK] button for 4 seconds or more, [TEST] is displayed on the display screen and the mode enters in Test run mode.</li> <li>2) Push [ON/OFF] button.</li> <li>3) Using [MODE] button, set the mode to [COOL] or [HEAT]. <ul style="list-style-type: none"> <li>• Do not use other mode than [COOL]/[HEAT] mode.</li> <li>• During test run operation, the temperature cannot be adjusted.</li> <li>• An error is detected as usual.</li> <li>• A frequency fixed operation is performed.</li> </ul> </li> <li>4) After the test run, push [ON/OFF] button to stop the operation. (Display in the display part is same as the procedure in Item 1.)</li> <li>5) Push [CHK] button to clear the test run mode. ([TEST] display in the display part disappears and the status returns to the normal stop status.)</li> </ol> <p><b>&lt;In case of wireless remote controller&gt; (Compact 4-way, Concealed Duct type)</b></p> <ol style="list-style-type: none"> <li>1) Turn off power of the set. Remove the nameplate of the receiver unit and then turn the Dip switch to [Test operation / ON].</li> <li>2) The test operation starts by [START/STOP] button. <ul style="list-style-type: none"> <li>• [START], [TIMER] and [READY] LEDs flash during test operation</li> <li>• Under condition of [Test operation / ON], the temperature adjustment is invalid even if using the wireless remote controller. Do not use it at other cases than a test operation because it applies excessive force.</li> </ul> </li> <li>3) Carry out a test operation under anyone mode of HEAT, COOL or FAN operation mode. <ul style="list-style-type: none"> <li>• The outdoor unit does not operate for approx. 3 minutes after the power supply was turned on and after operation stop.</li> </ul> </li> <li>4) After the test operation, stop the unit by the wireless remote controller and then return Dip switch of the receiver unit to the original position. (In order to prevent sequential test operation, this receiving unit is attached with 60-minutes timer release function.)</li> </ol> 	Command frequency is approximately [S7]

No.	Item	Outline of specifications	Remarks																								
13	Frequency fixed operation (Test run) (Continued)	<p><b>(Ceiling type)</b></p> <table border="1" data-bbox="459 264 1430 965"> <thead> <tr> <th data-bbox="459 264 596 309">Procedure</th> <th colspan="2" data-bbox="596 264 1430 309">Description</th> </tr> </thead> <tbody> <tr> <td data-bbox="459 309 596 443"><b>4</b></td> <td colspan="2" data-bbox="596 309 1430 443">Turn on power of the air conditioner.  The operation is not accepted for 5 minutes when power has been turned on at first time after installation, and 1 minute when power has been turned on at the next time and after. After the specified time has passed, perform a test operation.</td> </tr> <tr> <td data-bbox="459 443 596 510"><b>2</b></td> <td colspan="2" data-bbox="596 443 1430 510">Push [Start/Stop] button and change the operation mode to [COOL] or [HEAT] with [Mode] button. Then change the fan speed to [High] using [Fan] button.</td> </tr> <tr> <td data-bbox="459 510 596 622"><b>3</b></td> <td data-bbox="596 510 1011 622"><b>Test cooling operation</b> Set temperature to [18°C] using [Temperature set] button.</td> <td data-bbox="1011 510 1430 622"><b>Test heating operation</b> Set temperature to [30°C] using [Temperature set] button.</td> </tr> <tr> <td data-bbox="459 622 596 712"><b>4</b></td> <td data-bbox="596 622 1011 712">After checking the receiving sound "Pi", immediately push [Temperature set] button to set to [19°C]</td> <td data-bbox="1011 622 1430 712">After checking the receiving sound "Pi", immediately push [Temperature set] button to set to [29°C].</td> </tr> <tr> <td data-bbox="459 712 596 801"><b>5</b></td> <td data-bbox="596 712 1011 801">After checking the receiving sound "Pi", immediately push [Temperature set] button to set to [18°C].</td> <td data-bbox="1011 712 1430 801">After checking the receiving sound "Pi", immediately push [Temperature set] button to set to [30°C].</td> </tr> <tr> <td data-bbox="459 801 596 920"><b>6</b></td> <td colspan="2" data-bbox="596 801 1430 920">Then repeat the procedure <b>4 → 5 → 4 → 5</b>. After approx. 10 seconds, all the display lamps on the sensor part of wireless remote controller, [Operation] (Green), [Timer] (Green), and [Ready] (Yellow) flash and the air conditioner starts operation. If the lamps do not flash, repeat the procedure 2 and after.</td> </tr> <tr> <td data-bbox="459 920 596 965"><b>7</b></td> <td colspan="2" data-bbox="596 920 1430 965">After the test operation, push [Start/Stop] button to stop the operation.</td> </tr> </tbody> </table> <p data-bbox="435 996 1201 1025"><b>&lt;Outline of test operation from the wireless remote controller&gt;</b></p> <p data-bbox="435 1032 692 1061">Test cooling operation:</p> <p data-bbox="435 1061 1445 1090">Start → 18°C → 19°C → 18°C → 19°C → 18°C → 19°C → 18°C → (Test operation) → Stop</p> <p data-bbox="435 1097 697 1126">Test heating operation:</p> <p data-bbox="435 1126 1445 1155">Start → 30°C → 29°C → 30°C → 29°C → 30°C → 29°C → 30°C → (Test operation) → Stop</p> <div data-bbox="488 1256 1361 1581"> </div>	Procedure	Description		<b>4</b>	Turn on power of the air conditioner.  The operation is not accepted for 5 minutes when power has been turned on at first time after installation, and 1 minute when power has been turned on at the next time and after. After the specified time has passed, perform a test operation.		<b>2</b>	Push [Start/Stop] button and change the operation mode to [COOL] or [HEAT] with [Mode] button. Then change the fan speed to [High] using [Fan] button.		<b>3</b>	<b>Test cooling operation</b> Set temperature to [18°C] using [Temperature set] button.	<b>Test heating operation</b> Set temperature to [30°C] using [Temperature set] button.	<b>4</b>	After checking the receiving sound "Pi", immediately push [Temperature set] button to set to [19°C]	After checking the receiving sound "Pi", immediately push [Temperature set] button to set to [29°C].	<b>5</b>	After checking the receiving sound "Pi", immediately push [Temperature set] button to set to [18°C].	After checking the receiving sound "Pi", immediately push [Temperature set] button to set to [30°C].	<b>6</b>	Then repeat the procedure <b>4 → 5 → 4 → 5</b> . After approx. 10 seconds, all the display lamps on the sensor part of wireless remote controller, [Operation] (Green), [Timer] (Green), and [Ready] (Yellow) flash and the air conditioner starts operation. If the lamps do not flash, repeat the procedure 2 and after.		<b>7</b>	After the test operation, push [Start/Stop] button to stop the operation.		
Procedure	Description																										
<b>4</b>	Turn on power of the air conditioner.  The operation is not accepted for 5 minutes when power has been turned on at first time after installation, and 1 minute when power has been turned on at the next time and after. After the specified time has passed, perform a test operation.																										
<b>2</b>	Push [Start/Stop] button and change the operation mode to [COOL] or [HEAT] with [Mode] button. Then change the fan speed to [High] using [Fan] button.																										
<b>3</b>	<b>Test cooling operation</b> Set temperature to [18°C] using [Temperature set] button.	<b>Test heating operation</b> Set temperature to [30°C] using [Temperature set] button.																									
<b>4</b>	After checking the receiving sound "Pi", immediately push [Temperature set] button to set to [19°C]	After checking the receiving sound "Pi", immediately push [Temperature set] button to set to [29°C].																									
<b>5</b>	After checking the receiving sound "Pi", immediately push [Temperature set] button to set to [18°C].	After checking the receiving sound "Pi", immediately push [Temperature set] button to set to [30°C].																									
<b>6</b>	Then repeat the procedure <b>4 → 5 → 4 → 5</b> . After approx. 10 seconds, all the display lamps on the sensor part of wireless remote controller, [Operation] (Green), [Timer] (Green), and [Ready] (Yellow) flash and the air conditioner starts operation. If the lamps do not flash, repeat the procedure 2 and after.																										
<b>7</b>	After the test operation, push [Start/Stop] button to stop the operation.																										
14	Filter sign display (Except wireless type) * It is provided on the separately sold type TCB-AX21E2.	<ol style="list-style-type: none"> <li>1) The operation time of the indoor fan is calculated, the filter reset signal is sent to the remote controller when the specified time (2500H) has passed, and it is displayed on LCD.</li> <li>2) When the filter reset signal has been received from the remote controller, time of the calculation timer is cleared. In this case, the measurement time is reset if the specified time has passed, and display on LCD disappears.</li> </ol>	[FILTER  ] goes on.																								



No.	Item	Outline of specifications	Remarks
15	Central control mode selection	<p>1) Setting at the central controller side enables to select the contents which can be operated on the wired remote controller.</p> <p>2) Setup contents</p> <ul style="list-style-type: none"> <li>• In case of TCC-LINK Central remote controller (TCB-SC642TLE2)</li> </ul> <p>[Individual]: Operated by wired remote controller ([After-push precedence])</p> <p>[Central 1]: START / STOP operation by wired remote controller is unavailable.</p> <p>[Central 2]: START / STOP, MODE change and TEMP. setting by wired remote controller are unavailable.</p> <p>[Central 3]: MODE change and TEMP. setting by wired remote controller are unavailable.</p> <p>[Central 4]: MODE change by wired remote controller is unavailable.</p> <ul style="list-style-type: none"> <li>• In case of the wireless remote controller, the contents to be operated are same though the display lamp does not change.</li> </ul> <p>If an item prohibited by the central control mode is operated from the remote controller, it is notified with receiving sound Pi, Pi, Pi, Pi, Pi (5 times)</p>	<p>Display at wired remote controller side (No display)</p> <p>[  ] goes on.</p> <p>[  ] goes on.</p> <p>[  ] goes on.</p> <p>[  ] goes on.</p>
16	Energy-saving control	<p>1) Selecting [AUTO] mode enables an energy-saving to be operated.</p> <p>2) The setup temperature is shifted (corrected) in the range not to lose the comfort ability according to input values of various sensors.</p> <p>3) Data (Input value room temp. Ta, Outside temp. To, Air volume, Indoor heat exchanger sensor temp. Tc) for 20 minutes are taken the average to calculate correction value of the setup temperature.</p> <p>4) The setup temperature is shifted every 20 minutes, and the shifted range is as follows.</p> <p style="padding-left: 40px;">In cooling time: +1.5 to -1.0K In heating time: -1.5 to +1.0K.</p>	
17	Max. frequency cut control	<p>1) This control is operated by selecting [AUTO] operation mode.</p> <p>2) COOL operation mode: It is controlled according to the following figure if <math>T_o &lt; 28^{\circ}\text{C}</math>.</p> <div style="text-align: center;">  <p>Max. frequency is restricted to approximately the rated cooling frequency</p> </div> <p>3) HEAT operation mode: It is controlled according to the following figure if <math>T_o &gt; 15^{\circ}\text{C}</math>.</p> <div style="text-align: center;">  <p>Max. frequency is restricted to approximately the rated heating frequency</p> </div>	

No.	Item	Outline of specifications	Remarks														
18	DC motor	1) When the fan operation has started, positioning of the stator and the rotor are performed. (Moves slightly with tap sound) 2) The motor operates according to the command from the indoor controller.  <b>Notes)</b> <ul style="list-style-type: none"> <li>• When the fan rotates while the air conditioner stops due to entering of outside air, etc, the air conditioner may operate while the fan motor stops.</li> <li>• When a fan lock is found, the air conditioner stops, and an error is displayed.</li> </ul>	Check code [P12]														
19	Self-clean operation (Dry operation)	1) When cooling operation mode (AUTO COOL, COOL, DRY) stopped, the following three self-clean operations are performed. <table border="1" data-bbox="491 707 1422 893" style="margin: 10px auto;"> <thead> <tr> <th>Compressor ON period</th> <th>Self-clean operation period</th> <th>FAN</th> <th>Drain pump</th> <th>Louver</th> </tr> </thead> <tbody> <tr> <td>0 to 10 min.</td> <td>None</td> <td rowspan="3">Fan (UL)</td> <td rowspan="3">STOP</td> <td rowspan="3">Horizontal discharge position *Concealed duct is none.</td> </tr> <tr> <td>10 to 60 min.</td> <td>1 hour</td> </tr> <tr> <td>60 min. to</td> <td>2 hours</td> </tr> </tbody> </table> 2) During operation of self-clean,  lights on the wired remote controller screen. However the operation lamp (Green LED) goes off. 3) To stop the self-clean operation, push twice the [ON/OFF] button on the remote controller continuously. (Stop the operation as compressor ON time in the table above: 10 minutes or below.) 4) When the follower unit executes self-clean operation in the group connection, the segment of  is displayed on the wired remote controller screen via master unit. * If self-clean operation is not used, set invalidity (does not use) of the self-clean operation by changing [0001 (At shipment) of CODE No. (DN) [D3] to [0000]. * To erase the  display during operation of self-clean, change CODE No. [D4] from [0000: Display (At shipment)] to [0001: Non-display].	Compressor ON period	Self-clean operation period	FAN	Drain pump	Louver	0 to 10 min.	None	Fan (UL)	STOP	Horizontal discharge position *Concealed duct is none.	10 to 60 min.	1 hour	60 min. to	2 hours	And it is not also on the wireless remote controller. It is recognized as [STOP] from the remote monitor side.
Compressor ON period	Self-clean operation period	FAN	Drain pump	Louver													
0 to 10 min.	None	Fan (UL)	STOP	Horizontal discharge position *Concealed duct is none.													
10 to 60 min.	1 hour																
60 min. to	2 hours																
20	Save operation	1) Turn on  button on the remote controller. 2) During operation of save operation,  lights on the wired remote controller. 3) During save operation, the current release control is performed with the restriction ratio set in EEPROM on the outdoor unit. 4) The restriction ratio can be set by keeping  button pushed for 4 seconds or more on the remote controller. 5) When validating the save operation, the next operation starts with save operation valid because contents are held even when operation stops, operation mode changes or power supply is reset. 6) The restriction ratio can be set by changing the setup data of CODE No. (DN) [C2] in the range of 50 to 100% (every 1%, Setting at shipment: 75%).	Carry out setting operation during stop of the unit; otherwise the unit stops operation. For the setup operation, refer to "How to set contents of save operation" in Section "8. SETUP AT LOCAL SITE AND OTHERS".														

No.	Item	Outline of specifications	Remarks
21	8°C heating/Frost protective operation	<p>1) This functional is intended for the cold latitudes and performs objective heating operation (8°C heating operation).</p> <p>2) This function is valid only for combination with the outdoor units.</p> <p>3) Using the indoor CODE No. [D1] (1 bit), Valid/Invalid of this function is set up at the customer's side. * The setup by CODE No. is Invalid [0]/Valid [1] and Invalid [0] has been set at the shipment.</p> <p>4) This operation is the heating operation which sets 8°C as the setup temperature of the target.</p> <p>5) This function starts operation by pushing temperature button  during heating operation; besides by pushing  button for 4 seconds or more after temperature reached the minimum set temperature.</p> <p>6) To stop/release this operation, select and execute one from the following operations.</p> <p>① Push  button: Heating operation (18°C setting) continues.</p> <p>② Push [START/STOP] button: Air conditioner stops. (Heating 18°C operation at the next start)</p> <p>③ Push  : Other operation mode is selected and the operation continues.</p> <p>7) As the setup temperature is 8°C and the human heating is not targeted, the cold air discharge preventive control (Item 7) is made invalid to suppress the intermittent operation.</p> <p>8) The settings of the air direction and air volume are changeable during this operation.</p> <p>9) The indoor fan stops to protect the compressor for 2 minutes after start of heating operation (Thermo-ON) by this function.</p>	<p>In a group connection, if there is even one combination with other unit, "This function is not provided." is displayed.</p> <p>The setup temperature jumps from [18] to [8].</p>

### 5-3. Indoor Print Circuit Board

#### 5-3-1. Compact 4-way Cassette Type / Concealed Duct Type / Ceiling Type

<MCC-1402>

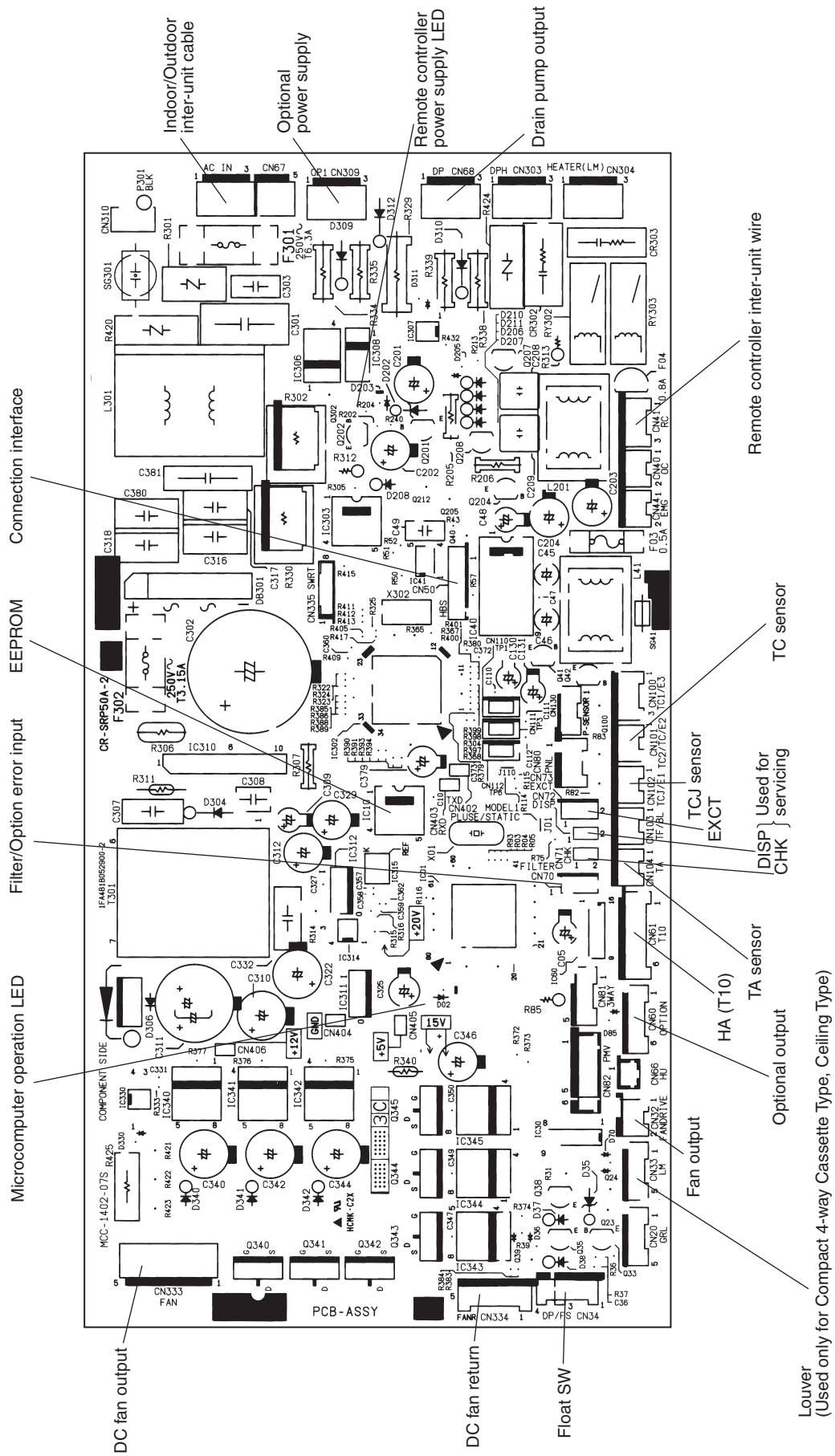

## Indoor P.C. Board Optional Connector Specifications (MCC-1402)

Function	Connector No.	Pin No.	Specifications	Remarks
Option output	CN60	1	DC12V (COM)	
		2	Defrost output	ON during defrost operation of outdoor unit
		3	Thermo. ON output	ON during Real thermo-ON (Comp ON)
		4	Cooling output	ON when operation mode is in cooling system (COOL, DRY, COOL in AUTO cooling/heating)
		5	Heating output	ON when operation mode is in heating system (HEAT, HEAT in AUTO cooling/heating)
		6	Fan output	ON during indoor fan ON (Air purifier is used/Interlock cable)
Outside error input	CN80	1	DC12V (COM)	(When continued for 1 minute) Check code "L30" is output and forced operation stops.
		2	DC12V (COM)	
		3	Outside error input	
CHK Operation check	CN71	1	Check mode input	Used for operation check of indoor unit. (Communication with outdoor unit or remote controller is not performed, but the specified operation such as indoor fan "H" or drain pump ON is output.)
		2	0V	
DISP display mode	CN72	1	Display mode input	Display mode enables indoor unit and remote controller to communicate. (When power is turned on)
		2	0V	
EXCT demand	CN73	1	Demand input	Forced thermo-OFF operation in indoor unit
		2	0V	

## 6. TROUBLESHOOTING

### 6-1. Summary of Troubleshooting

#### <Wired remote controller type>

#### 1. Before troubleshooting

- 1) Required tools/instruments
  - ⊕ and ⊖ screwdrivers, spanners, radio cutting pliers, nippers, push pins for reset switch
  - Tester, thermometer, pressure gauge, etc.
- 2) Confirmation points before check
  - a) The following operations are normal.
    1. Compressor does not operate.
      - Is not 3-minutes delay (3 minutes after compressor OFF)?
      - Is not the outdoor unit in standby status though the remote controller reached the setup temperature?
      - Does not timer operate during fan operation?
      - Is not an overflow error detected on the indoor unit?
      - Is not outside high-temperature operation controlled in heating operation?
    2. Indoor fan does not rotate.
      - Does not cool air discharge preventive control work in heating operation?
    3. Outdoor fan does not rotate or air volume changes.
      - Does not high-temperature release operation control work in heating operation?
      - Does not outside low-temperature operation control work in cooling operation?
      - Is not defrost operation performed?
    4. ON/OFF operation cannot be performed from remote controller.
      - Is not automatic address being set up?  
(When the power is turned on at the first time or when indoor unit address setting is changed, the operation cannot be performed for maximum approx. 5 minutes after power-ON.)
      - Is not being carried out a test run by operation of the outdoor P.C. board?
  - b) Did you return the cabling to the initial positions?
  - c) Are connecting cables of indoor unit and remote controller correct?

#### 2. Troubleshooting procedure

When a trouble occurred, check the parts along with the following procedure.



#### NOTE :

---

For cause of a trouble, power conditions or malfunction/erroneous diagnosis of microcomputer due to outer noise is considered except the items to be checked. If there is any noise source, change the cables of the remote controller to shield cables.

---

## <Wireless remote controller type>

### 1. Before troubleshooting

#### 1) Required tools/instruments

- ⊕ and ⊖ screwdrivers, spanners, radio cutting pliers, nippers, etc.
- Tester, thermometer, pressure gauge, etc.

#### 2) Confirmation points before check

##### a) The following operations are normal.

##### 1. Compressor does not operate.

- Is not 3-minutes delay (3 minutes after compressor OFF)?
- Is not the outdoor unit in standby status though the remote controller reached the setup temperature?
- Does not timer operate during fan operation?
- Is not an overflow error detected on the indoor unit?
- Is not outside high-temperature operation controlled in heating operation?

##### 2. Indoor fan does not rotate.

- Does not cool air discharge preventive control work in heating operation?

##### 3. Outdoor fan does not rotate or air volume changes.

- Does not high-temperature release operation control work in heating operation?
- Does not outside low-temperature operation control work in cooling operation?
- Is not defrost operation performed?

##### 4. ON/OFF operation cannot be performed from remote controller.

- Is not forced operation performed?
- Is not the control operation performed from outside/remote side?
- Is not automatic address being set up?
- Is not being carried out a test run by operation of the outdoor controller?

##### b) Did you return the cabling to the initial positions?

##### c) Are connecting cables between indoor unit and receiving unit correct?

### 2. Troubleshooting procedure

(When the power is turned on at the first time or when indoor unit address setting is changed, the operation cannot be performed for maximum approx. 5 minutes after power-ON.)

When a trouble occurred, check the parts along with the following procedure.



## Outline of judgment

The primary judgment to check whether a trouble occurred in the indoor unit or outdoor unit is carried out with the following method.

Method to judge the erroneous position by display panel of the indoor unit  
(lamp display of the wireless receiving part)





The indoor unit monitors the operating status of the air conditioner, and the blocked contents of self-diagnosis are displayed restricted to the following cases if a protective circuit works.

● : Go off, ○ : Go on, ☼ : Flash (0.5 sec.)

Lamp indication	Check code	Cause of trouble occurrence	
Operation   Timer   Ready ●   ●   ● No indication at all	—	Power supply OFF or miswiring between lamp indication unit and indoor unit	
Operation   Timer   Ready ☼   ●   ● Flash	E01	Receiving error } Receiving unit } Sending error } Communication stop } Miswiring or wire connection error between receiving unit and indoor unit	
	E02		
	E03		
	Operation   Timer   Ready ☼   ●   ● Flash	E08	Duplicated indoor unit No. } Duplicated master units of remote controller } Setup error
		E09	
		E10	Communication error between CPUs on indoor unit P.C. board
E18	Wire connection error between indoor units, Indoor power OFF (Communication stop between indoor header and follower)		
Operation   Timer   Ready ●   ●   ☼ Flash	E04	Miswiring between indoor unit and outdoor unit or connection error (Communication stop between indoor and outdoor units)	
Operation   Timer   Ready ●   ☼   ☼ Alternate flash	P10	Overflow was detected. } Indoor DC fan error } Protective device of indoor unit worked.	
	P12		
Operation   Timer   Ready ☼   ●   ☼ Alternate flash	P03	Outdoor unit discharge temp. error } Outdoor high pressure system error } Protective device of outdoor unit worked.   *1	
	P04		
	P05	Negative phase detection error } Heat sink overheat error } Gas leak detection error } Outdoor unit error	
	P07		
	P15		
	P19	4-way valve system error (Indoor or outdoor unit judged.)	
	P20	Outdoor unit high pressure protection	
	P22	Outdoor unit: Outdoor unit error } Outdoor unit: Inverter Idc operation } Outdoor unit: Position detection error } Protective device of outdoor unit worked.   *1	
	P26		
	P29		
P31	Stopped because of error of other indoor unit in a group (Check codes of E03/L03/L07/L08)		

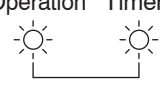
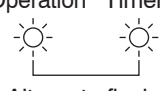
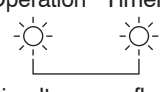

\*1: These are representative examples and the check code differs according to the outdoor unit to be combined.



Lamp indication	Check code	Cause of trouble occurrence	
Operation Timer Ready  Alternate flash	F01	Heat exchanger sensor (TCJ) error } Indoor unit sensor error	
	F02		Heat exchanger sensor (TC) error
	F10		Heat exchanger sensor (TA) error
Operation Timer Ready  Alternate flash	F04	} Sensor error of outdoor unit *1	
	F06		Discharge temp. sensor (TD) error
	F07		Temp. sensor (TE) error
	F08		Temp. sensor (TL) error
	F12		Temp. sensor (TO) error
	F13		Temp. sensor (TS) error
	F15		Temp. sensor (TH) error
Operation Timer Ready  Simultaneous flash	F29	Indoor EEPROM error	
	F31	Outdoor EEPROM error	
Operation Timer Ready  Flash	H01	} Outdoor compressor system error *1	
	H02		Compressor break down
	H03		Compressor lock
	H04		Current detection circuit error
	H06		Case thermostat worked.
Operation Timer Ready  Simultaneous flash	L03	} → AUTO address * If group construction and address are not normal when power supply turned on, automatically goes to address setup mode.	
	L07		Duplicated header indoor units
	L08		There is indoor unit of group connection in individual indoor unit.
	L09		Unsetting of group address
Operation Timer Ready  Simultaneous flash	L10	} Others	
	L20		Unset model type (Service board)
	L29		Duplicated indoor central addresses
	L30		Outdoor unit and other error
	L31		Outside interlock error
		Negative phase error	

\*1: These are representative examples and the check code differs according to the outdoor unit to be combined.

**Others (Other than Check Code)**

Lamp indication	Check code	Cause of trouble occurrence
Operation Timer Ready  Simultaneous flash	—	During test run
Operation Timer Ready  Alternate flash	—	Disagreement cool/heat (Automatic cool/heat setting to automatic cool/heat prohibited mode)

## 6-2. Check Code List (Indoor) (Indoor unit detected)

Check code indication TCC-LINK central & Remote controller	Representative defective position	Explanation of error contents	Air conditioner operation	
			Automatic reset	Operation continuation
E03	Regular communication error between indoor and remote controller	No communication from remote controller and network adapter (Also no communication from central control system)	○	×
E04	Indoor/Outdoor serial error	There is error on serial communication between indoor and outdoor units	○	×
E08	Duplicated indoor addresses	Same address as yours was detected.	○	×
E10	Communication error between indoor MCU	MCU communication error between main motor and micro computer	○	×
E18	Regular communication error between indoor master and follower units	Regular communication between indoor master and follower units is impossible.	○	×
F01	Indoor unit, Heat exchanger (TCU) error	Open/short was detected on heat exchanger (TCU).	○	×
F02	Indoor unit, Heat exchanger (TC) error	Open/short was detected on heat exchanger (TC).	○	×
F10	Indoor unit, Room temp. sensor (TA) error	Open/short was detected on room temp. sensor (TA).	○	×
F29	Indoor unit, other indoor PC board error	EEPROM error (Other error may be detected. If no error, automatic address is repeated.	×	×
L03	Duplicated setting of indoor group master unit	There are multiple master units in a group.	×	×
L07	There is group cable in individual indoor unit.	When even one group connection indoor unit exists in individual indoor unit.	×	×
L08	Unset indoor group address	Indoor group address is unset.	×	×
L09	Unset indoor capacity	Capacity of indoor unit is unset.	×	×
L20	Duplicated central control system address	Duplicated setting of central control system address	○	×
L30	Outside error input to indoor unit (Interlock)	Abnormal stop by outside error (CN80) input	×	×
P01	Indoor unit, AC fan error	An error of indoor AC fan was detected. (Fan motor thermal relay worked.)	×	×
P10	Indoor unit, overflow detection	Floater switch worked.	×	×
P12	Indoor unit, DC fan error	Indoor DC fan error (Over-current/Lock, etc.) was detected.	×	×
P19	4-way valve system error	In heating operation, an error was detected by temp. down of indoor heat exchanger sensor.	○	×
P31	Other indoor unit error	Follower unit in group cannot operate by warning from [E03/L03/L07/L08] of master unit.	○	×

◇ When this warning was detected before group construction/address check finish at power supply was turned on, the mode shifts automatically to AUTO address setup mode.

## (Remote controller detected)

Check code indication Remote controller	Representative defective position	Explanation of error contents	Air conditioner operation	
			Automatic reset	Operation continuation
E01	No master remote controller, Remote controller communication (Receive) error	Signal cannot be received from indoor unit. Master remote controller was not set. (including 2 remote controllers)	—	—
E02	Remote controller communication (Send) error	Signal cannot be sent to indoor unit.	—	—
E09	Duplicated master remote controller	In 2-remote controller control, both were set as master. (Indoor master unit stops warning and follower unit continues operation.)	×	△

## (Central control devices detected)

Check code indication TCC-LINK central	Representative defective position	Explanation of error contents	Air conditioner operation	
			Automatic reset	Operation continuation
C05	Central control system communication (send) error	Signal sending operation of central control system is impossible. There are multiple same central dev/ces. (AI-NET)	—	—
C06	Central control system communication (receive) error	Signal receiving operation of central control system is impossible.	—	—
C12	General-purpose device control interface batched warning	An error on device connected to general-purpose device control interface of exclusive to TCC-LINK/AI-NET	—	—
P30	Group follower unit is defective.	Group follower unit is defective. (For remote controller, above-mentioned [***] details are displayed with unit No.)	—	—

**NOTE:** Even for the same contents of error such as communication error, the display of check code may differ according to detection device.  
When remote controller or central controller detects an error, it is not necessarily related to operation of the air conditioner. In this list, the check codes that outdoor unit detects are not described.

# Check Code List

## Error mode detected by indoor unit

Operation of diagnostic function				Judgment and measures
Check code	Cause of operation	Status of air conditioner	Condition	
E03	No communication from remote controller (including wireless) and communication adapter	Stop (Automatic reset)	Displayed when error is detected	1. Check cables of remote controller and communication adapters. • Remote controller LCD display OFF (Disconnection) • Central remote controller [97] check code
E04	The serial signal is not output from outdoor unit to indoor unit. • Miswiring of inter-unit wire • Defective serial sending circuit on outdoor P.C. board • Defective serial receiving circuit on indoor P.C. board	Stop (Automatic reset)	Displayed when error is detected	1. Outdoor unit does not completely operate. • Inter-unit wire check, correction of miswiring • Check outdoor P.C. board. Correct wiring of P.C. board. 2. When outdoor unit normally operates Check P.C. board (Indoor receiving / Outdoor sending).
E08	Duplicated indoor unit address	Stop	Displayed when error is detected	1. Check whether remote controller connection (Group/Individual) was changed or not after power supply turned on (Finish of group construction/Address check). * If group construction and address are not normal when the power has been turned on, the mode automatically shifts to address setup mode. (Resetting of address)
L03	Duplicated indoor header unit			
L07	There is group wire in individual indoor unit.			
L08	Unset indoor group address			
L09	Unset indoor capacity	Stop	Displayed when error is detected	1. Set indoor capacity (DN=11)
L30	Abnormal input of outside interlock	Stop	Displayed when error is detected	1. Check outside devices. 2. Check indoor P.C. board.
P10	Float switch operation • Float circuit, Disconnection, Coming-off, Float switch contact error	Stop	Displayed when error is detected	1. Trouble of drain pump 2. Clogging of drain pump 3. Check float switch. 4. Check indoor P.C. board.
P12	Indoor DC fan error	Stop	Displayed when error is detected	1. Position detection error 2. Indoor fan driving part over-current protective circuit operation 3. Indoor fan lock 4. Indoor P.C. board check
P19	4-way valve system error • After heating operation has started, indoor heat exchangers temp. is down.	Stop (Automatic reset)	Displayed when error is detected	1. Check 4-way valve. 2. Check 2-way valve and check valve. 3. Check indoor heat exchanger (TC/TCJ). 4. Check indoor P.C. board.
P31	Own unit stops while warning is output to other indoor units.	Stop (Follower unit) (Automatic reset)	Displayed when error is detected	1. Judge follower unit while master unit is [E03], [L03], [L07] or [L08]. 2. Check indoor P.C. board.
F01	Coming-off, disconnection or short of indoor heat exchanger temp. sensor (TCJ)	Stop (Automatic reset)	Displayed when error is detected	1. Check indoor heat exchanger temp. sensor (TCJ). 2. Check indoor P.C. board.
F02	Coming-off, disconnection or short of indoor heat exchanger temp. sensor (TC)	Stop (Automatic reset)	Displayed when error is detected	1. Check indoor heat exchanger temp. sensor (TC). 2. Check indoor P.C. board.
F10	Coming-off, disconnection or short of indoor heat exchanger temp. sensor (TA)	Stop (Automatic reset)	Displayed when error is detected	1. Check indoor heat exchanger temp. sensor (TA). 2. Check indoor P.C. board.
F29	Indoor EEPROM error • EEPROM access error	Stop (Automatic reset)	Displayed when error is detected	1. Check indoor EEPROM. (including socket insertion) 2. Check indoor P.C. board.
E10	Communication error between indoor MCU • Communication error between fan driving MCU and main MCU	Stop (Automatic reset)	Displayed when error is detected	1. Check indoor P.C. board.
E18	Regular communication error between indoor header and follower units	Stop (Automatic reset)	Displayed when error is detected	1. Check remote controller wiring. 2. Check indoor power supply wiring. 3. Check indoor P.C. board.

## Error mode detected by outdoor unit

The check code has been ramified from **4** series and after

The ramified check code is displayed only when both the indoor unit and the outdoor unit are **4** series and after.  
(Ex. Combination of RAV-SM1404BT-E with RAV-SP1404AT-E)

When the outdoor unit is 3 series and before, the conventional check code is displayed.

(Ex. Combination of RAV-SM1404BT-E and RAV-SM1403AT-E: Indoor unit only is **4** series.)

Operation of diagnostic function				Judgment and measures
Check code	Cause of operation	Status of air conditioner	Condition	
Indoor unit				
F04	Disconnection, short of discharge temp. sensor (TD)	Stop	Displayed when error is detected	1. Check discharge temp. sensor (TD). 2. Check outdoor P.C. board.
F06	Disconnection, short of outdoor temp. sensor (TE)	Stop	Displayed when error is detected	1. Check temp. sensor (TE). 2. Check outdoor P.C. board.
F07	Disconnection, short of outdoor temp. sensor (TL)	Stop	Displayed when error is detected	1. Check temp. sensor (TL). 2. Check outdoor P.C. board.
F12	Disconnection, short of suction temp. sensor (TS)	Stop	Displayed when error is detected	1. Check suction temp. sensor (TS). 2. Check outdoor P.C. board.
F15	Miss-mounting of outdoor temp. sensor (TE, TS)	Stop	Displayed when error is detected	1. Check temp. sensor (TE, TS). 2. Check outdoor P.C. board.
F08	Disconnection, short of outside temp. sensor (TO)	Continue	Displayed when error is detected	1. Check outside temp. sensor (TO). 2. Check outdoor P.C. board.
F13	Disconnection, short of heat sink temp. sensor (TH)	Stop	Displayed when error is detected	1. Check outdoor P.C. board. (Q201 is incorporated in TH sensor.)
F31	Outdoor P.C. EEPROM error	Stop	Displayed when error is detected	1. Check outdoor P.C. board.
L10	Unset jumper of service P.C. board	Stop	Displayed when error is detected	1. Outdoor service P.C. board Check model type setting jumper wire.
L29	Communication error between outdoor P.C. board MCU	Stop	Displayed when error is detected	1. Check outdoor P.C. board 2. Connection check for each P.C. board.
P07	Heat sink overheat error * Heat sink temp. sensor detected over specified temperature.	Stop	Displayed when error is detected	1. Check screw tightening between PC. Board and heat sink and check radiator grease. 2. Check heat sink blast path.
P15	Detection of gas leak * Discharge temp. sensor (TD), Suction temp. sensor (TS) detected temperature over specified temp.	Stop	Displayed when error is detected	1. Check gas leak, recharge 2. Check full open of service valve. 3. Check PMV (Pulse Motor Valve). 4. Check broken pipe. 5. Check discharge temp. sensor (TD), suction temp. sensor (TS).
P19	4-way valve inverse error * After heating operation has started, indoor heat exchanger temp. lowers under the specified temp. * After heating operation has started, outdoor heat exchanger / suction temp. rises over the specified temp.	Stop	Displayed when error is detected	1. Check operation of 4-way valve. 2. Check outdoor heat exchanger (TE), suction temp. sensor (TS). 3. Check indoor heat exchanger sensor (TC). 4. Check 4-way valve coil. 5. Check PMV (Pulse Motor Valve).
H01	Compressor break down * Although operation has started, operation frequency decreases and operation stops.	Stop	Displayed when error is detected	1. Check power supply voltage. 2. Overload operation of refrigerating cycle
H02	Compressor lock * Over-current detection after compressor start-up	Stop	Displayed when error is detected	1. Trouble of compressor (Lock, etc.): Replace compressor. 2. Wiring error of compressor (Open phase)

Operation of diagnostic function				Judgment and measures
Check code	Cause of operation	Status of air conditioner	Condition	
Indoor unit				
H03	Current detection circuit error	Stop	Displayed when error is detected	1. Check outdoor P.C. board (MCC-1596). (AC current detection circuit)
P05	Open phase of 3-phase power supply	Stop	Displayed when error is detected	1. Check open phase of 3-phase power supply. 2. Black lead wire to be connected to CN03 of MCC-1596 does not pass through T611.
F23	Ps sensor error	Stop	Displayed when error is detected	1. Check connection of Ps sensor connector. 2. Check failure of Ps sensor. 3. Check compressing power error of compressor. 4. Check 4-way valve error. 5. Check outdoor P.C. board error.
H06	Low pressure protective operation	Stop	Displayed when error is detected	1. Check service valves are fully opened. (Gas side, Liquid side) 2. Check clogging of outdoor PMV. (PMV1, 2) 3. Check SV2 circuit. 4. Check Ps sensor error. 5. Check clogging of indoor filter. 6. Check clogging of refrigerant pipe. 7. Check of outdoor fan operation. (In heating mode) 8. Check short of refrigerant.
P03	Discharge temp. error * Discharge temp. (TD) over specified value was detected.(1.6)	Stop	Displayed when error is detected	1. Check refrigerating cycle (Gas leak) 2. Trouble of electronic expansion valve 3. Check discharge temp. sensor (TD).
H04	Case thermostat operation * Abnormal overheat of compressor	Stop	Displayed when error is detected	1. Check case thermostat and connector. 2. Check gas leak, recharge 3. Check full open of service valve. 4. Check PMV (Pulse Motor Valve). 5. Check broken pipe.
P04	High pressure SW system error	Stop	Displayed when error is detected	1. Check service valves are fully opened. (Gas side, Liquid side) 2. Check of outdoor fan operation. 3. Check motor error of outdoor fan. 4. Check clogging of outdoor PMV. (PMV1, 2) 5. Check clogging of heat exchanger in indoor/outdoor units. 6. Short-circuit status of suction/discharge air in outdoor unit. 7. Check outdoor P.C. board error. 8. Check fan system error (Cause of air volume drop) at indoor side. 9. Check PMV opening status in indoor unit.
P05	Power supply voltage error	Stop	Displayed when error is detected	1. Check power supply voltage.
P20	High pressure protective operation • During cooling operation, outdoor temp. sensor (TL) detected temperature over specified temp. • During heating operation, indoor temp. sensor (TC, TCJ) detected temperature over specified temp.	Stop	Displayed when error is detected	1. Check outdoor heat exchanger sensor (TL). 2. Check indoor heat exchanger sensor (TC, TCJ). 3. Check full open of service valve. 4. Check indoor/outdoor fan. 5. Check PMV (Pulse Motor Valve). 6. Check clogging and short circuit of indoor/outdoor heat exchanger. 7. Overcharge of refrigerant. Recharge
P22	Outdoor fan system error	Stop	Displayed when error is detected	1. Check lock of fan motor. 2. Check power supply voltage between L2 and N. 3. Check outdoor P.C. board.
P26	Short-circuit error of compressor driving element	Stop	Displayed when error is detected	1. When performing operation while taking-off compressor wire, P26 error occurs. Check control P.C. board. 2. When performing operation while taking-off compressor wire, an error does not occur. (Compressor rare short)
P29	Position detection circuit error	Stop	Displayed when error is detected	1. Check control P.C. board.

## Error mode detected by remote controller or central controller (TCC-LINK)

Operation of diagnostic function				Judgment and measures
Check code	Cause of operation	Status of air conditioner	Condition	
Not displayed at all (Operation on remote controller is impossible.)	No communication with master indoor unit <ul style="list-style-type: none"> <li>Remote controller wiring is not correct.</li> <li>Power of indoor unit is not turned on.</li> <li>Automatic address cannot be completed.</li> </ul>	Stop	—	Power supply error of remote controller, Indoor EEPROM error <ol style="list-style-type: none"> <li>1. Check remote controller inter-unit wiring.</li> <li>2. Check remote controller.</li> <li>3. Check indoor power wiring.</li> <li>4. Check indoor P.C. board.</li> <li>5. Check indoor EEPROM. (including socket insertion) → Automatic address repeating phenomenon generates.</li> </ol>
E01 *2	No communication with master indoor unit <ul style="list-style-type: none"> <li>Disconnection of inter-unit wire between remote controller and master indoor unit (Detected by remote controller side)</li> </ul>	Stop (Automatic reset) * If center exists, operation continues.	Displayed when error is detected	Receiving error from remote controller <ol style="list-style-type: none"> <li>1. Check remote controller inter-unit wiring.</li> <li>2. Check remote controller.</li> <li>3. Check indoor power wiring.</li> <li>4. Check indoor P.C. board.</li> </ol>
E02	Signal send error to indoor unit (Detected by remote controller side)	Stop (Automatic reset) * If center exists, operation continues.	Displayed when error is detected	Sending error of remote controller <ol style="list-style-type: none"> <li>1. Check sending circuit inside of remote controller. → Replace remote controller.</li> </ol>
E09	There are multiple main remote controllers. (Detected by remote controller side)	Stop (Sub unit continues operation.)	Displayed when error is detected	<ol style="list-style-type: none"> <li>1. In 2-remote controllers (including wireless), there are multiple main units. Check that there are 1 main remote controller and other sub remote controllers.</li> </ol>
L20 ----- Central controller L20	Duplicated indoor central addresses on communication of central control system (Detected by indoor/central controller side)	Stop (Automatic reset)	Displayed when error is detected	<ol style="list-style-type: none"> <li>1. Check setting of central control system network address. (Network adapter SW01)</li> <li>2. Check network adapter P.C. board.</li> </ol>
— *3 ----- Central controller (Send) C05 (Receive) C06	Communication circuit error of central control system (Detected by central controller side)	Continues (By remote controller)	Displayed when error is detected	<ol style="list-style-type: none"> <li>1. Check communication wire / miswiring</li> <li>2. Check communication (U3, U4 terminals)</li> <li>3. Check network adapter P.C. board.</li> <li>4. Check central controller (such as central control remote controller, etc.)</li> <li>5. Check terminal resistance. (TCC-LINK)</li> </ol>
— ----- Central controller P30	Indoor Gr sub unit error (Detected by central controller side)	Continuation/Stop (According to each case)	Displayed when error is detected	Check the check code of the corresponding unit from remote controller.

\*2 The check code cannot be displayed by the wired remote controller.  
(Usual operation of air conditioner becomes unavailable.)

For the wireless models, an error is notified with indication lamp.

\*3 This trouble is related to communication of remote controller (A, B), central system (TCC-LINK U3, U4), and [E01], [E02], [E03], [E09] or [E18] is displayed or no check display on the remote controller according to the contents.

### 6-3. Diagnostic Procedure for Each Check Code (Indoor Unit)

#### Check code

#### [E01 error]

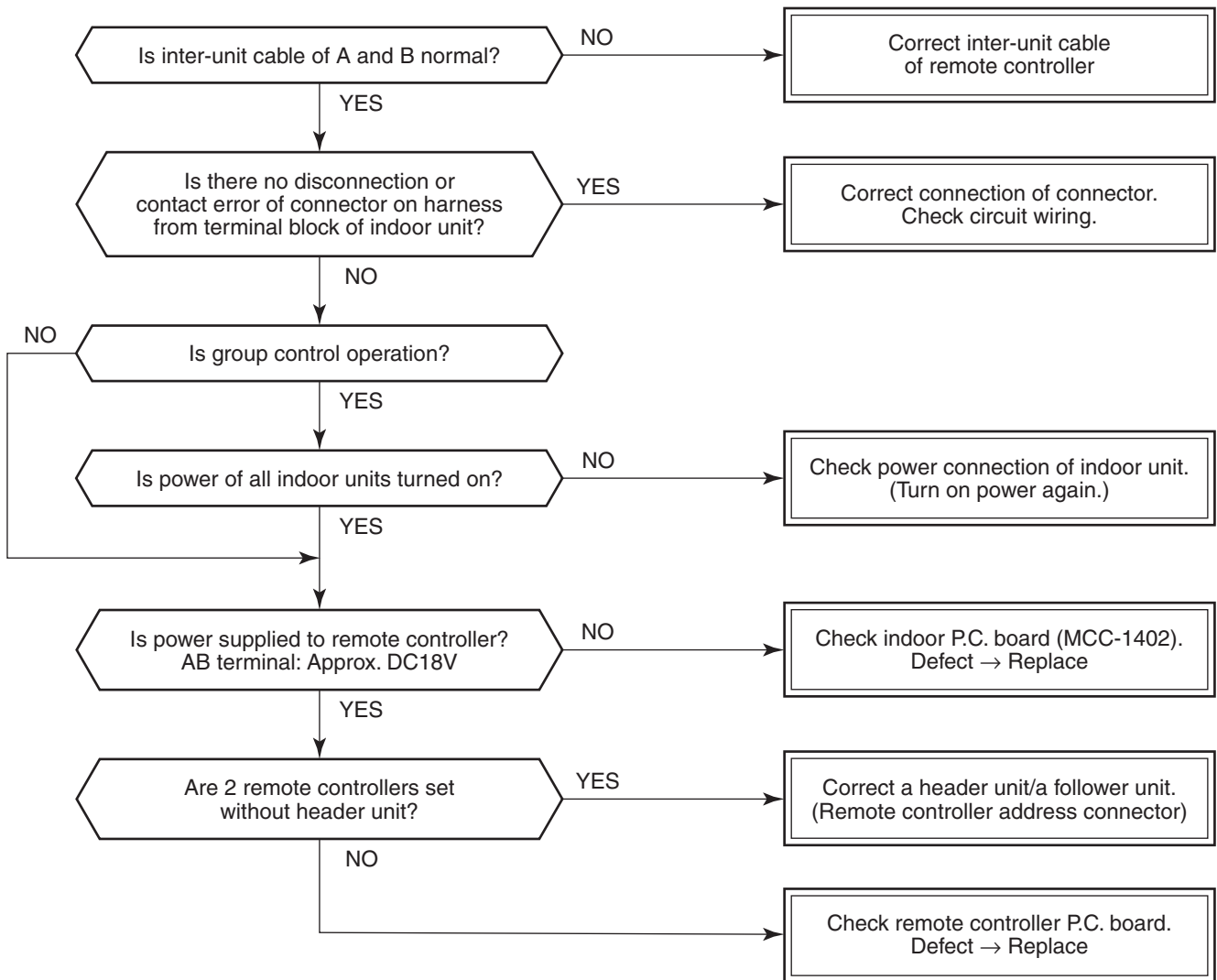

#### [E09 error]

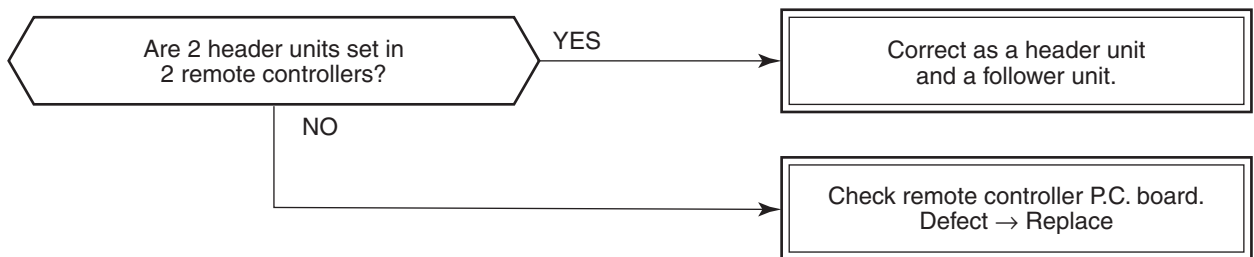



**[E04 error]**

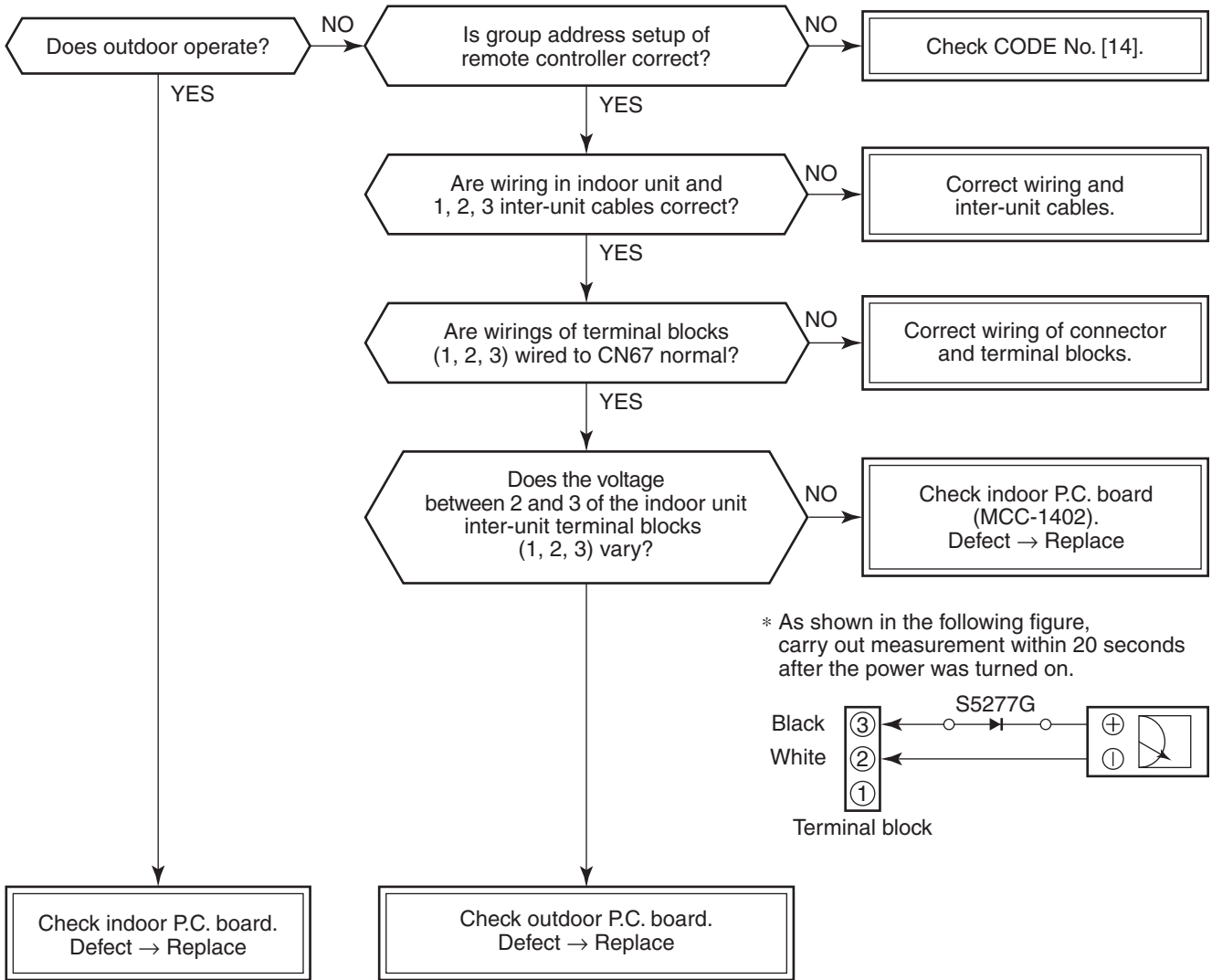

**[E10 error]**

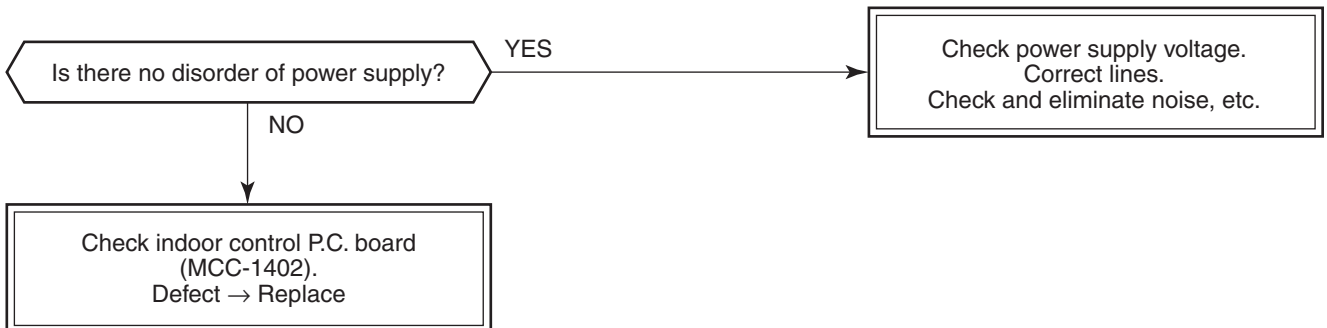

**[E18 error]**

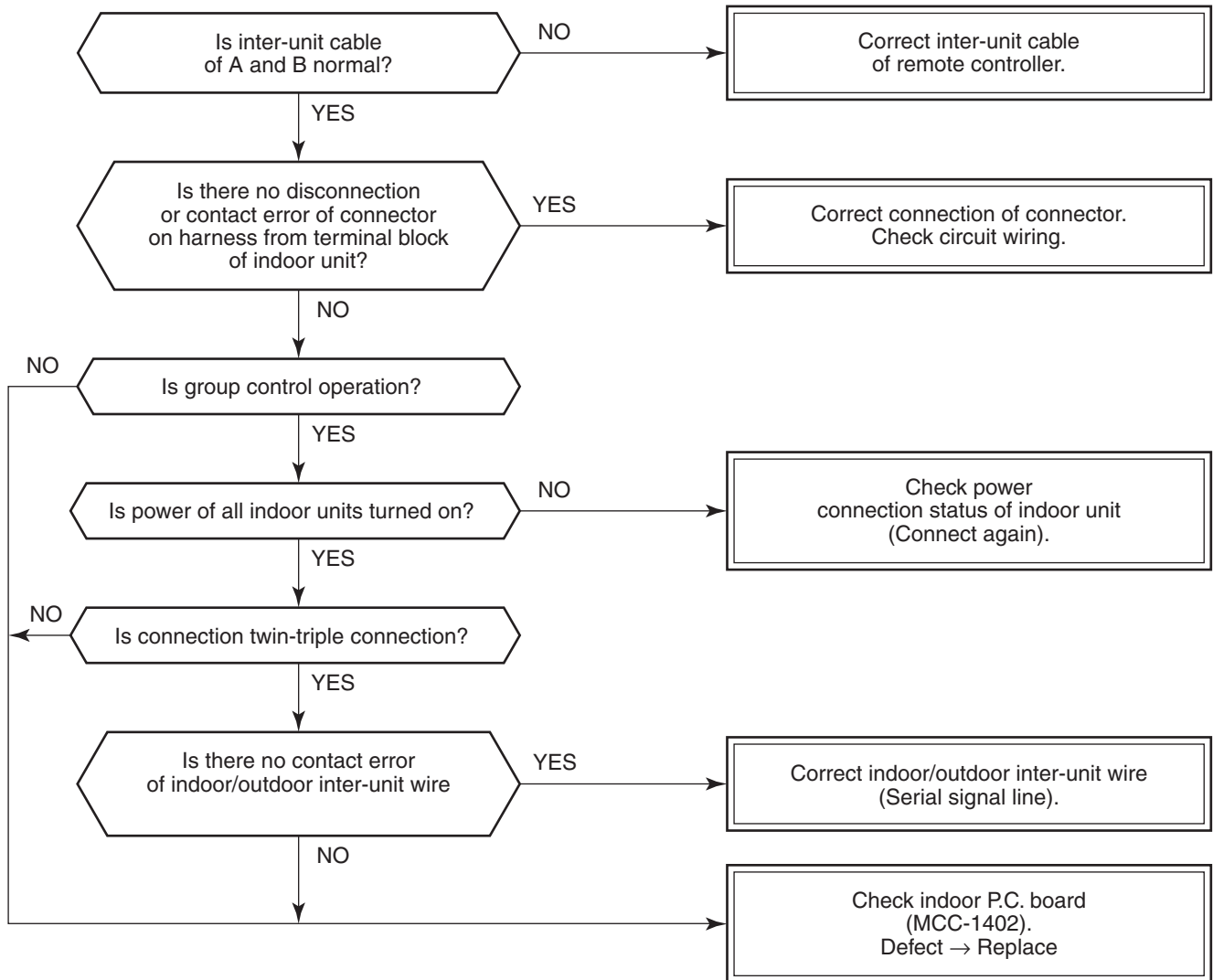

**[E08, L03, L07, L08 error]**

E08: Duplicated indoor unit No.

L03: There are 2 or more header units in a group control.

L07: There is 1 or more group address [Individual] in a group control.

L08: The indoor group address is unset. (99)

If the above error is detected when power supply turned on, the mode enters automatically in the automatic address set mode. (Check code is not output.)

However, if the above error is detected during the automatic address set mode, a check code may be output.

**[L09 error]**

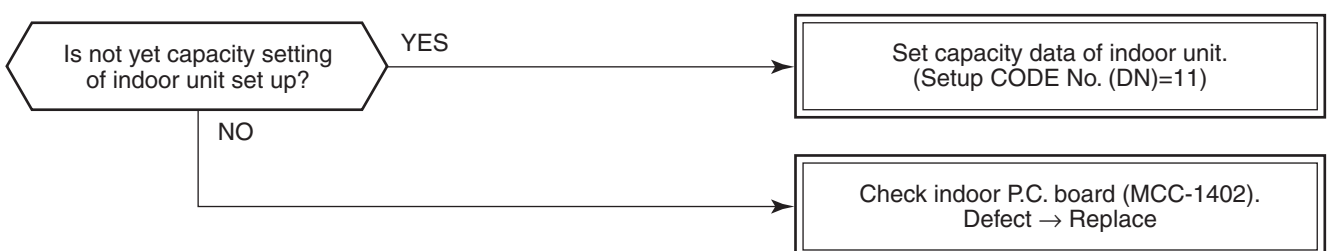

**[L20 error]**

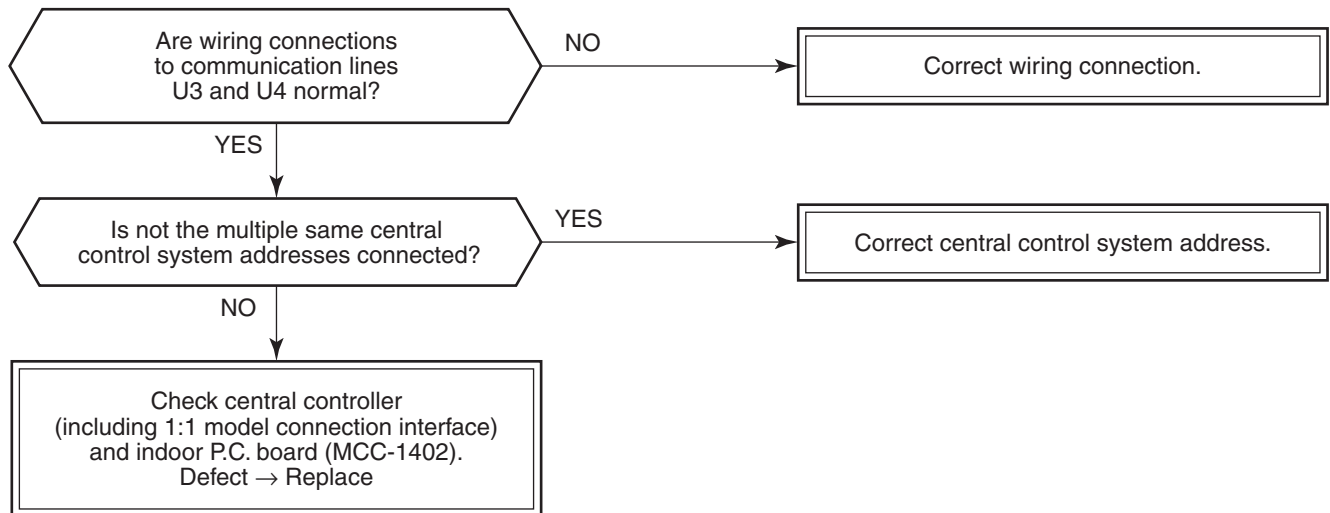

**[L30 error]**

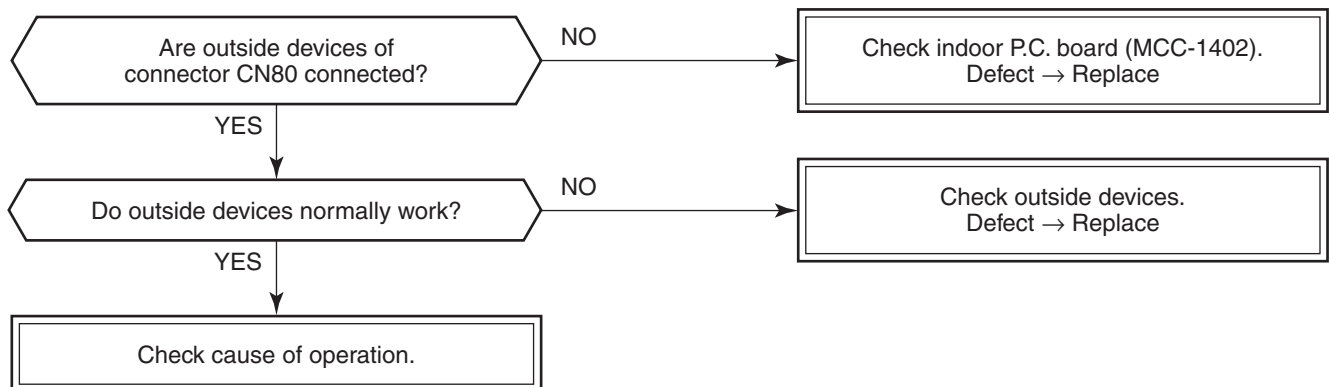

**[P30 error] (Central controller)**

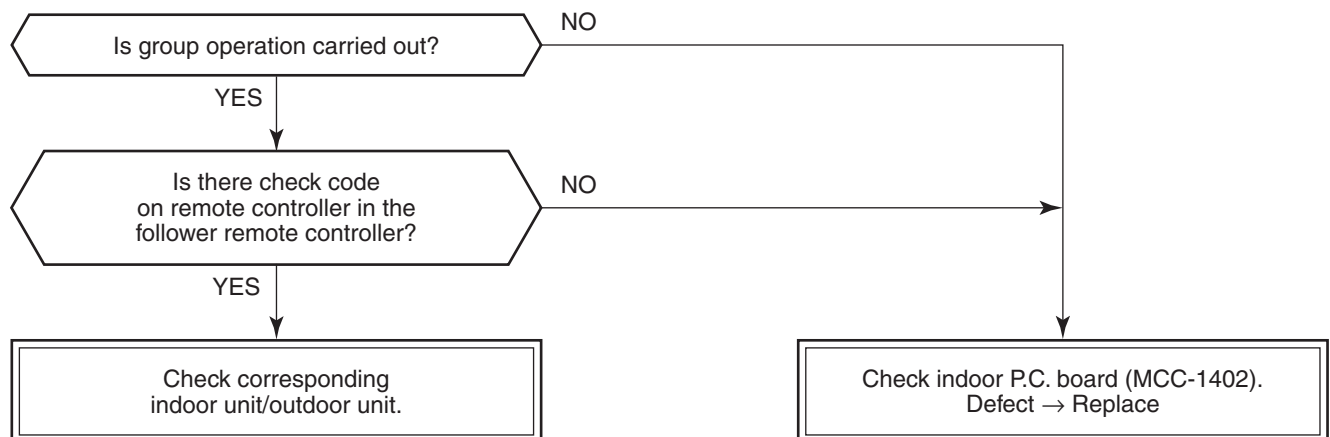

**[P10 error]**

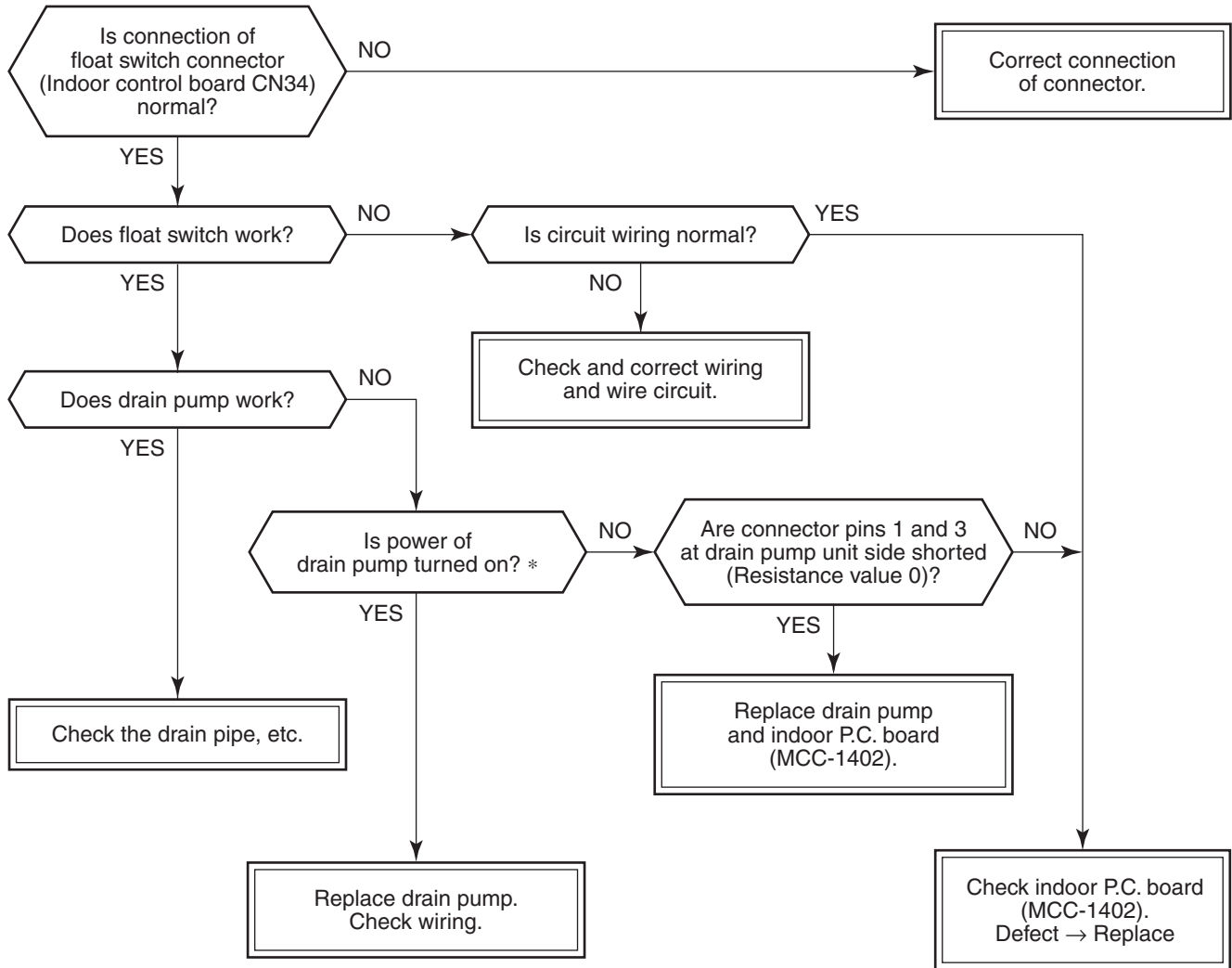

\* Check that voltage of 1 – 3 pin of CN068 on the indoor P.C. board is 220–240V.

**[F10 error]**

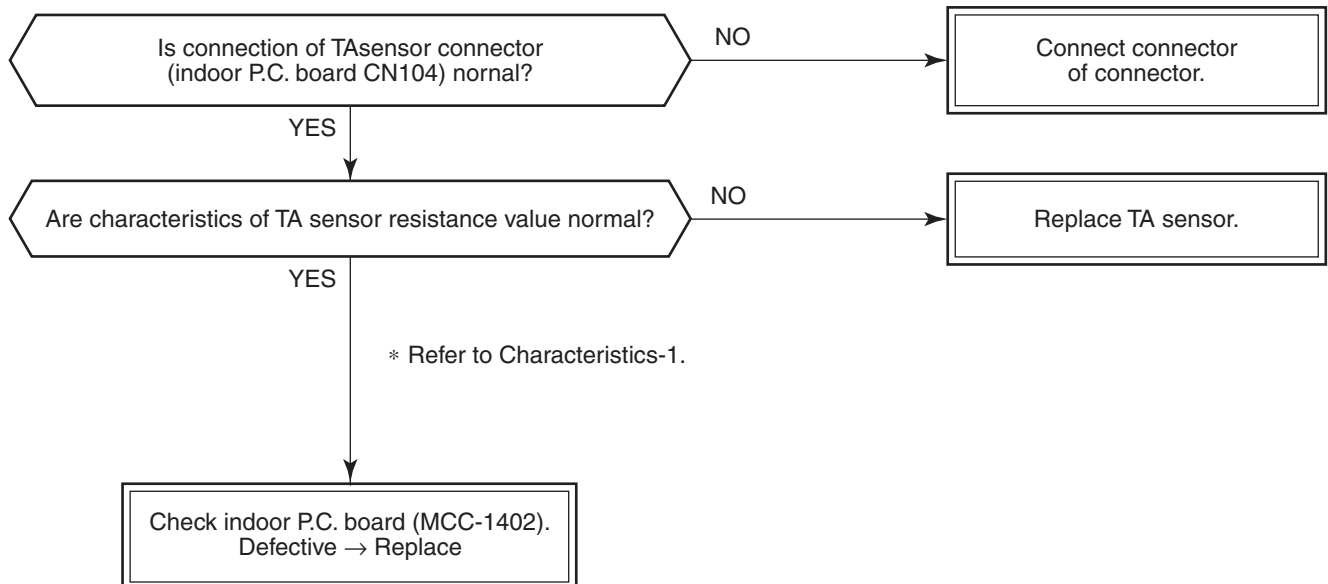

[P12 error]

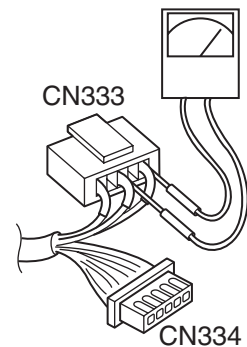
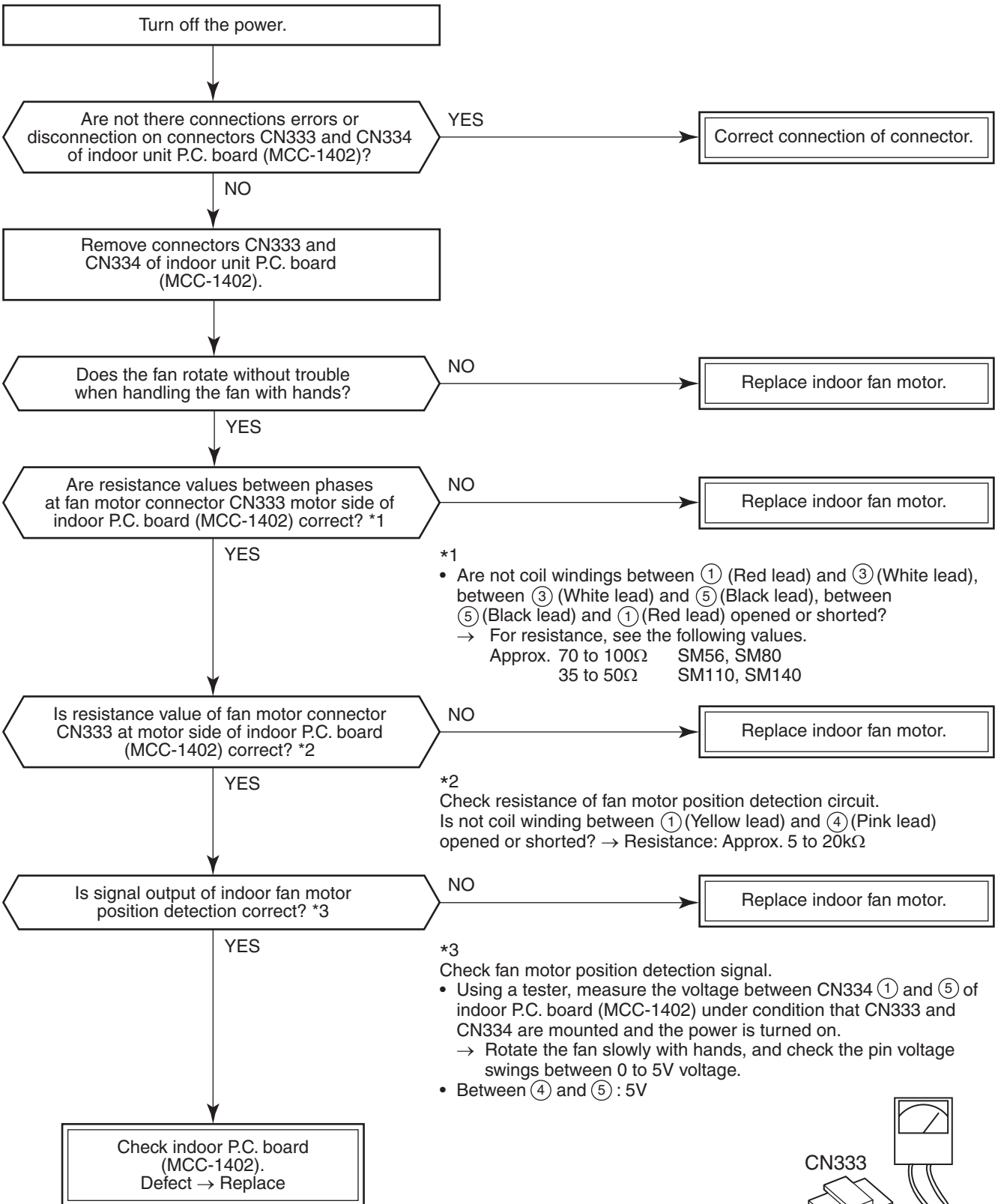

**[P19 error]**

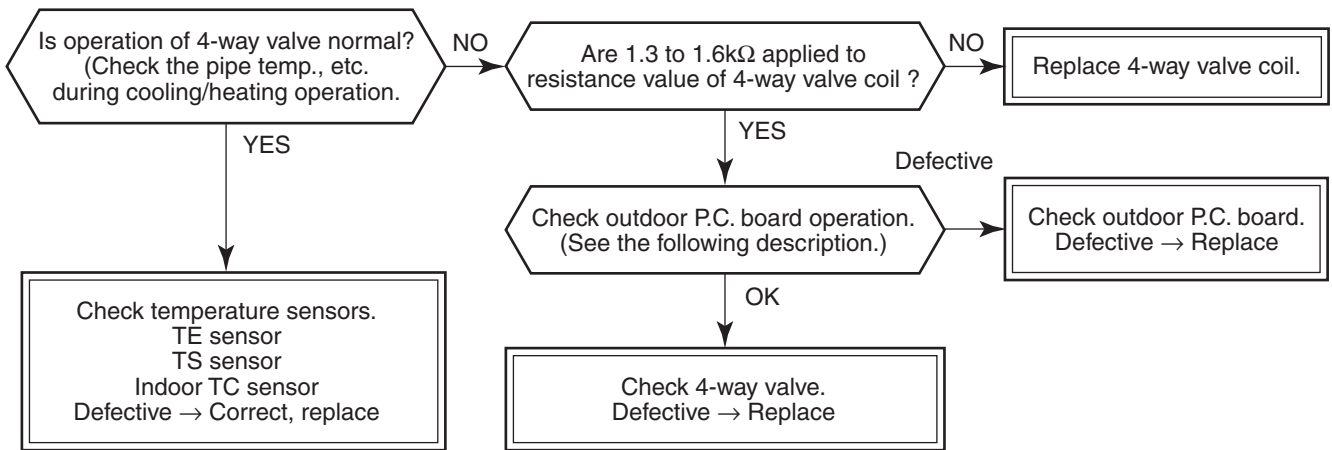

**Operation check direction of the outdoor P.C. board (In case of self-preservation valve)**

- 1) Set the Dip switch SW804 as same as the following table and push SW801 for approx. 1 second. It enables you to check the exchange operation to cooling cycle or heating cycle.
  - Only for approx. 10 seconds, the power is turned on.
  - As the heat value of part (coil: resistance R700) is large, when checking the operation continuously, wait 1 minute or more until the next check. (There is no problem if a coil is not connected.)
- 2) After check, turn off all the Dip switches SW804.

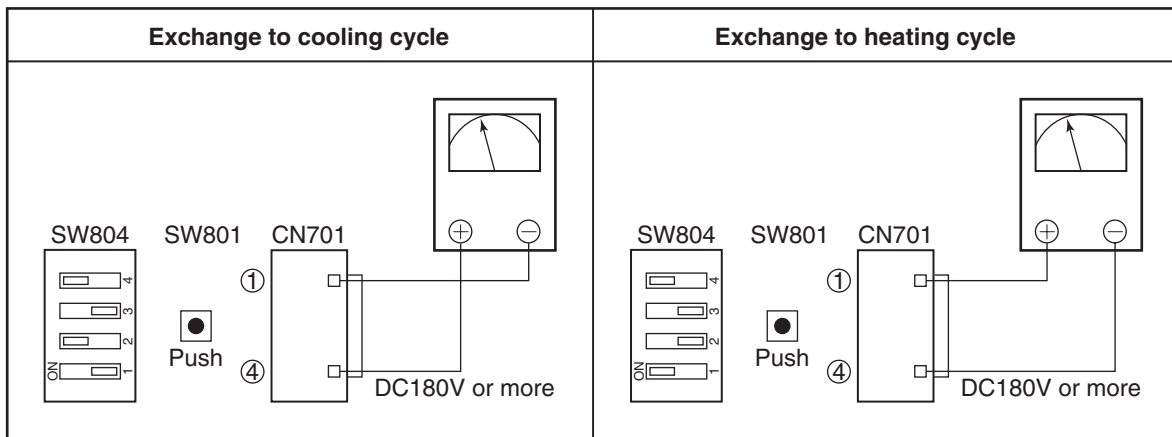

**Check by tester**

Analog tester: Good article if over DC180V

Digital tester: Although in some cases, the value varied and indicated. If the maximum value is DC180V or more, it is good article.

**[F02 error]**

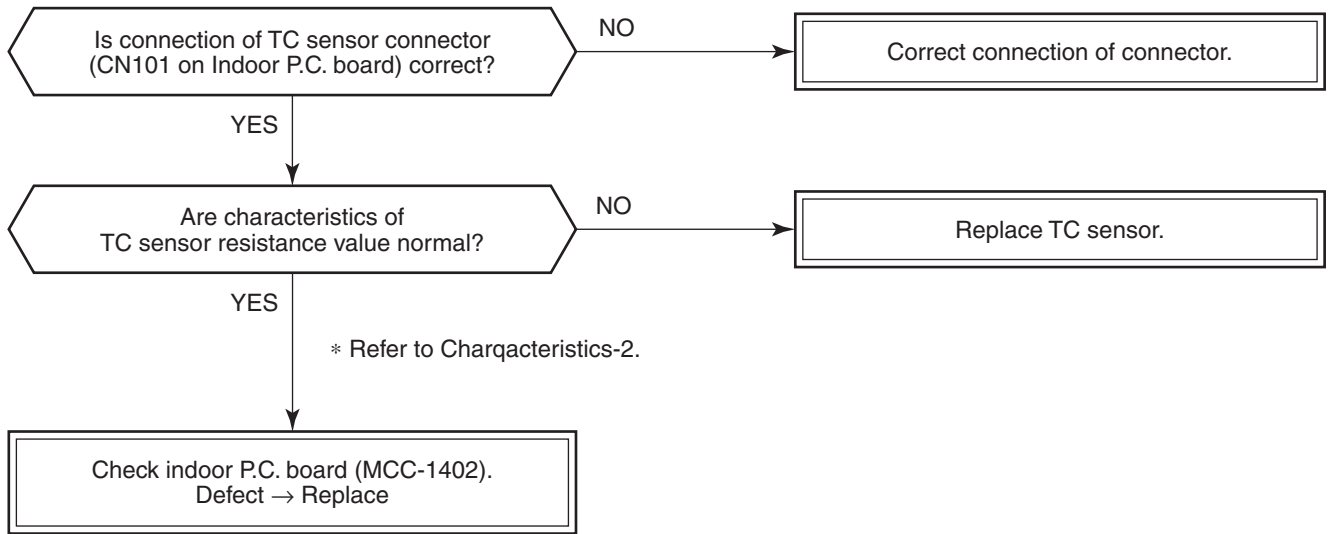

**[F01 error]**

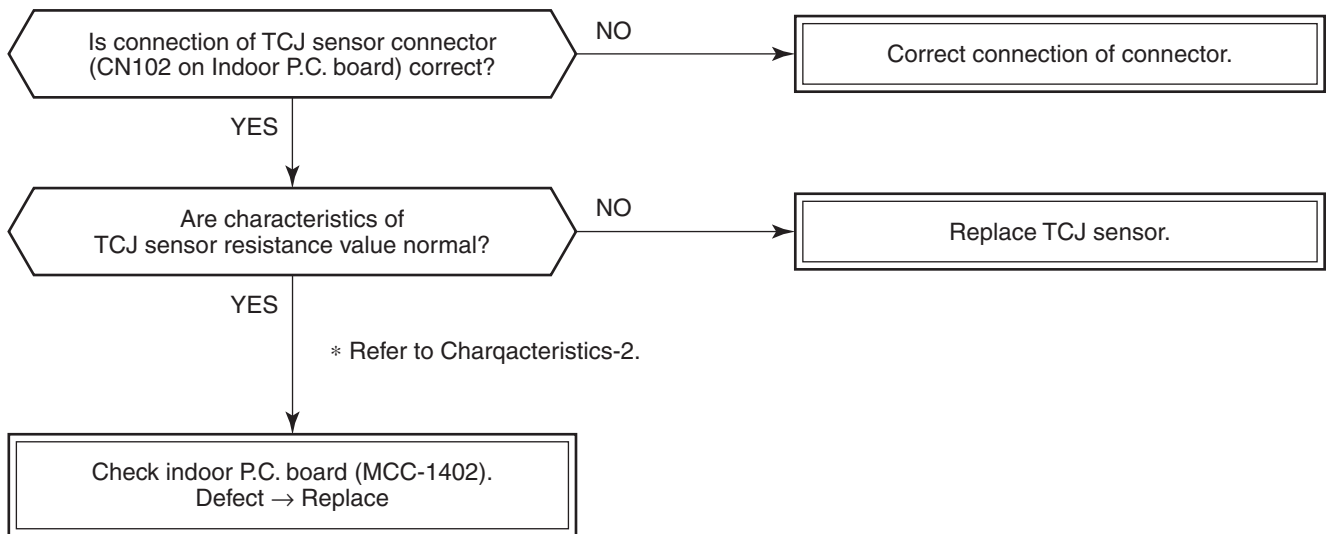

**[C06 error] (1:1 model connection interface)**

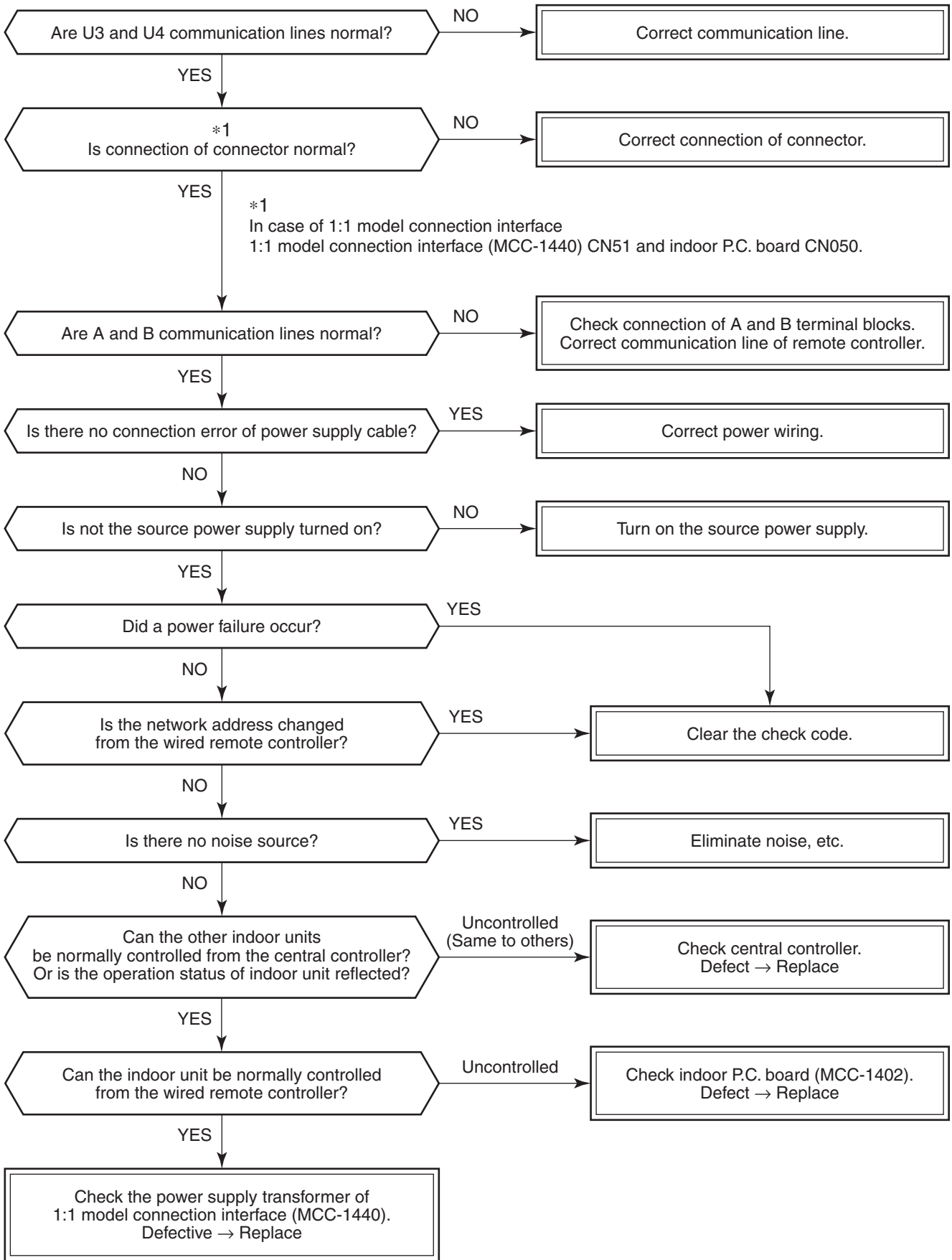



### [E03 error] (Master indoor unit)

[E03 error] is detected when the indoor unit cannot receive a signal from the wired remote controller (also central controller).

Check A and B remote controllers and communication lines of the central control system U3 and U4.

As communication is impossible, this check code [E03] is not displayed on the wired remote controller and the central controller.

[E01] is displayed on the wired remote controller and [C06 error] is displayed on the central controller.

If these check codes generate during operation, the air conditioner stops.

### [F29 error]

This check code indicates a detection error of IC10 non-volatile memory (EEPROM) on the indoor unit P.C. board, which generated during operation of the air conditioner. Replace the service P.C. board.

\* When EEPROM was not inserted when power supply turned on or when the EEPROM data read/write operation is impossible at all, the automatic address mode is repeated. In this time, [97 error] is displayed on the central controller.

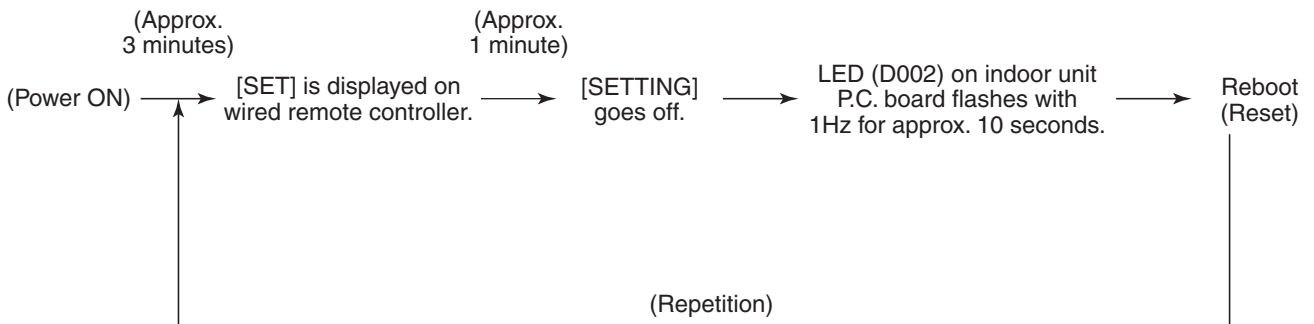

### [P31 error] (Follower indoor unit)

When the master unit of a group operation detected [E03], [L03], [L07] or [L08] error, the follower unit of the group operation detects [P31 error] and then the unit stops.

There is no display of the check code or alarm history of the wired remote controller. (In this model, the mode enters in automatic address set mode when the header unit detected [L03], [L07] or [L08] error.)

## Temperature – Resistance value characteristic table

**TA, TC, TCJ, TE, TS, TO sensor**

**TD, TL sensor**

**Representative value**

**Representative value**

Temperature (°C)	Resistance value (kΩ)		
	(Minimum value)	(Standard value)	(Maximum value)
0	32.33	33.80	35.30
10	19.63	20.35	21.09
20	12.23	12.59	12.95
25	9.75	10.00	10.25
30	7.764	7.990	8.218
40	5.013	5.192	5.375
50	3.312	3.451	3.594
60	2.236	2.343	2.454
70	1.540	1.623	1.709
80	1.082	1.146	1.213
90	0.7740	0.8237	0.8761
100	0.5634	0.6023	0.6434

Temperature (°C)	Resistance value (kΩ)		
	(Minimum value)	(Standard value)	(Maximum value)
0	150.5	161.3	172.7
10	92.76	99.05	105.6
20	58.61	62.36	66.26
25	47.01	49.93	52.97
30	37.93	40.22	42.59
40	25.12	26.55	28.03
50	17.00	17.92	18.86
60	11.74	12.34	12.95
70	8.269	8.668	9.074
80	5.925	6.195	6.470
90	4.321	4.507	4.696
100	3.205	3.336	3.468

### TA, TC, TCJ, TE, TS, TO sensor

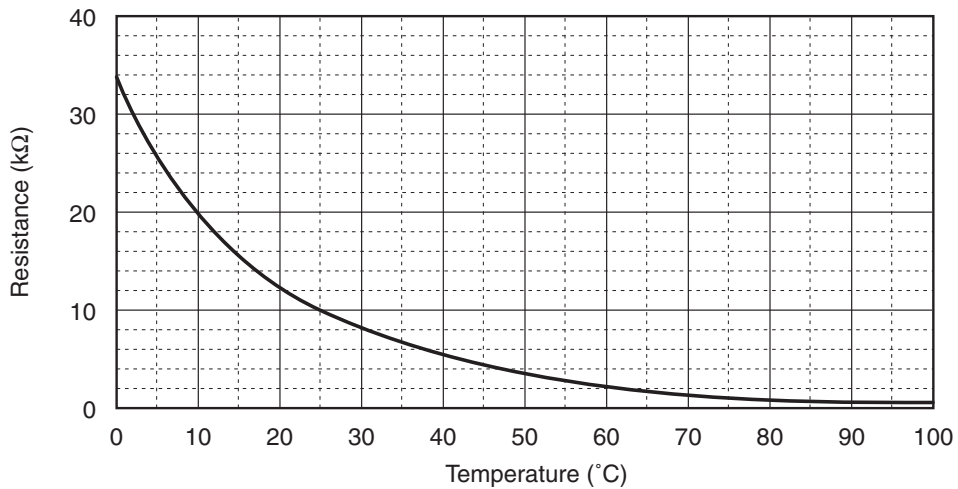

### TD, TL sensor

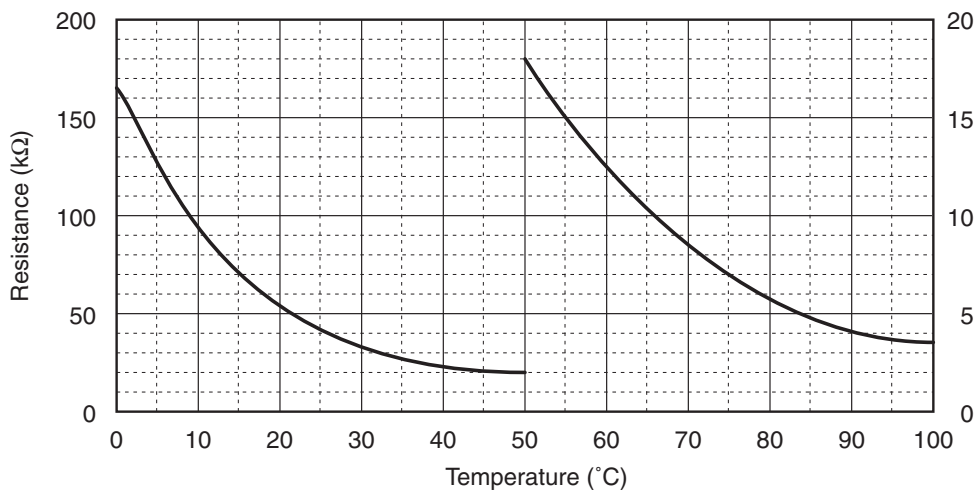

## Winding Resistance of Fan Motor

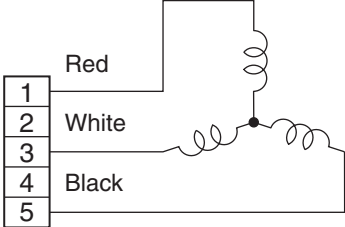
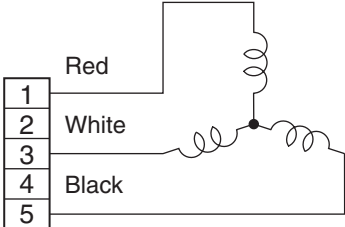
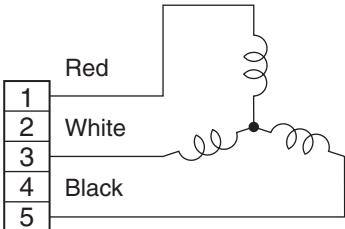
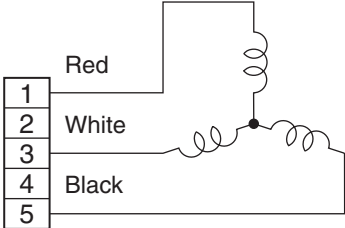
Part name	Checking procedure								
Compact 4-way Cassette type Fan motor STF-230-60-1R	Measure the resistance value of each winding by using the tester.  Fan motor inside wiring diagram   <table border="1" data-bbox="892 400 1422 602"> <thead> <tr> <th>Position</th> <th>Resistance value</th> </tr> </thead> <tbody> <tr> <td>Black – Red</td> <td><math>87 \pm 8.7</math></td> </tr> <tr> <td>Black – White</td> <td><math>87 \pm 8.7</math></td> </tr> <tr> <td>Red – White</td> <td><math>87 \pm 8.7</math></td> </tr> </tbody> </table> <p style="text-align: right;">Under 20°C</p>	Position	Resistance value	Black – Red	$87 \pm 8.7$	Black – White	$87 \pm 8.7$	Red – White	$87 \pm 8.7$
Position	Resistance value								
Black – Red	$87 \pm 8.7$								
Black – White	$87 \pm 8.7$								
Red – White	$87 \pm 8.7$								
Concealed Duct type Fan motor ICF-280-120-1C (RAV-SM804BT *) ICF-280-120-2C (RAV-SM564BT *, RAV-SM1104BT *, RAV-SM1404BT *)	Measure the resistance value of each winding by using the tester.  Fan motor inside wiring diagram   <table border="1" data-bbox="892 851 1422 1052"> <thead> <tr> <th>Position</th> <th>Resistance value</th> </tr> </thead> <tbody> <tr> <td>Black – Red</td> <td><math>23.4 \pm 2.4</math></td> </tr> <tr> <td>Black – White</td> <td><math>23.4 \pm 2.4</math></td> </tr> <tr> <td>Red – White</td> <td><math>23.4 \pm 2.4</math></td> </tr> </tbody> </table> <p style="text-align: right;">Under 20°C</p>	Position	Resistance value	Black – Red	$23.4 \pm 2.4$	Black – White	$23.4 \pm 2.4$	Red – White	$23.4 \pm 2.4$
Position	Resistance value								
Black – Red	$23.4 \pm 2.4$								
Black – White	$23.4 \pm 2.4$								
Red – White	$23.4 \pm 2.4$								
Ceiling type Fan motor SWF-280-60-1R (RAV-SM564CT *) SWF-280-60-2R (RAV-SM804CT *)	Measure the resistance value of each winding by using the tester.  Fan motor inside wiring diagram   <table border="1" data-bbox="892 1317 1422 1518"> <thead> <tr> <th>Position</th> <th>Resistance value</th> </tr> </thead> <tbody> <tr> <td>Black – Red</td> <td><math>53 \pm 5.3</math></td> </tr> <tr> <td>Black – White</td> <td><math>53 \pm 5.3</math></td> </tr> <tr> <td>Red – White</td> <td><math>53 \pm 5.3</math></td> </tr> </tbody> </table> <p style="text-align: right;">Under 20°C</p>	Position	Resistance value	Black – Red	$53 \pm 5.3$	Black – White	$53 \pm 5.3$	Red – White	$53 \pm 5.3$
Position	Resistance value								
Black – Red	$53 \pm 5.3$								
Black – White	$53 \pm 5.3$								
Red – White	$53 \pm 5.3$								
Ceiling type Fan motor SWF-280-120-1R (RAV-SM1104CT *, RAV-SM1404CT *)	Measure the resistance value of each winding by using the tester.  Fan motor inside wiring diagram   <table border="1" data-bbox="892 1787 1422 1989"> <thead> <tr> <th>Position</th> <th>Resistance value</th> </tr> </thead> <tbody> <tr> <td>Black – Red</td> <td><math>37 \pm 3.7</math></td> </tr> <tr> <td>Black – White</td> <td><math>37 \pm 3.7</math></td> </tr> <tr> <td>Red – White</td> <td><math>37 \pm 3.7</math></td> </tr> </tbody> </table> <p style="text-align: right;">Under 20°C</p>	Position	Resistance value	Black – Red	$37 \pm 3.7$	Black – White	$37 \pm 3.7$	Red – White	$37 \pm 3.7$
Position	Resistance value								
Black – Red	$37 \pm 3.7$								
Black – White	$37 \pm 3.7$								
Red – White	$37 \pm 3.7$								

## 7. REPLACEMENT OF SERVICE P.C. BOARD

### 7-1. Indoort Unit

#### <Note: when replacing the P.C. board for indoor unit servicing>

The nonvolatile memory (hereafter called EEPROM, IC10) on the indoor unit P.C. board before replacement includes the model specific type information and capacity codes as the factory-set value and the important setting data which have been automatically or manually set when the indoor unit is installed, such as system/indoor/group addresses, high ceiling select setting, etc.

When replacing the P.C. board for indoor unit servicing, follow the procedures below.

After replacement completes, confirm whether the settings are correct by checking the indoor unit No., Group master unit / sub unit settings and perform the cooling cycle confirmation through the trial operation.

#### <Replacement procedures>

### CASE 1

**Before replacement, the indoor unit can be turned on and the setting data can be read out by wired remote control operation.**

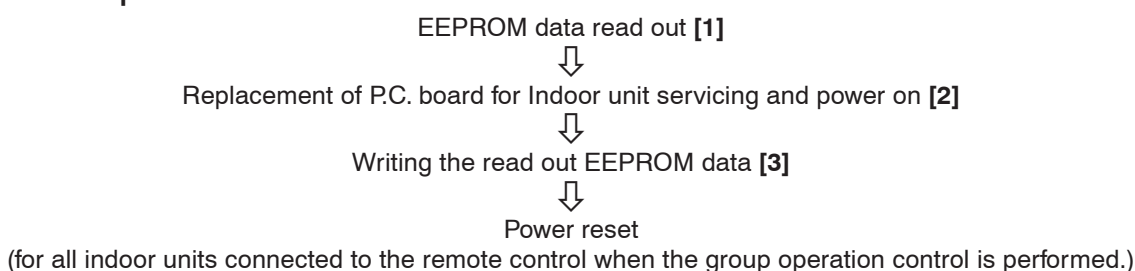

### CASE 2

**Before replacement, the indoor unit cannot be turned on or the wired remote controller operation is impossible due to trouble of the power supply circuit to the remote controller. (Defective P.C. board)**

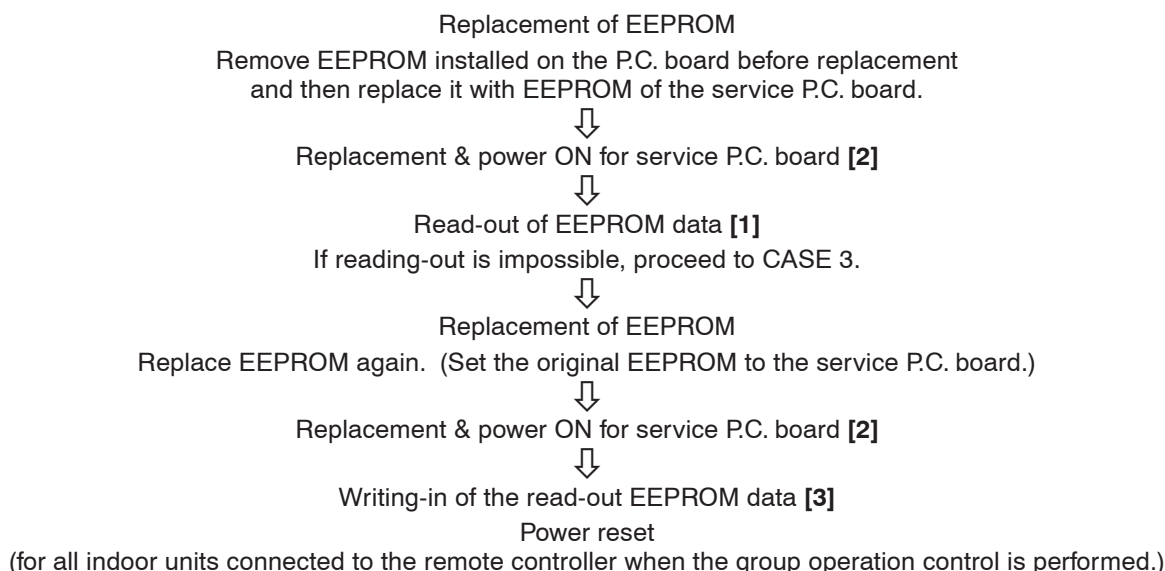





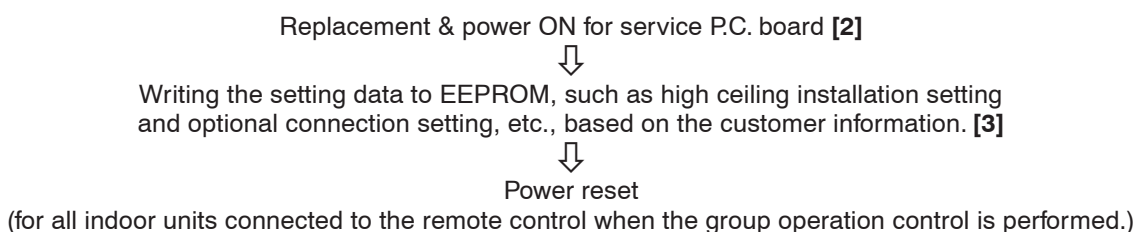



### CASE 3

**The EEPROM before replacement is defective and the setting data cannot be read out.**



## [1] Setting data read out from EEPROM

The setting data modified on the site, other than factory-set value, stored in the EEPROM shall be read out.



- Step 1** Push ,  and  button on the remote controller simultaneously for more than 4 seconds.  
\* When the group operation control is performed, the unit No. displayed for the first time is the header unit No. At this time, the CODE No. (DN) shows “/0”. Also, the fan of the indoor unit selected starts its operation and the swing operation also starts if it has the louvers.
- Step 2** Every time when the  button is pushed, the indoor unit No. under the group control is displayed in order. Specify the indoor unit No. to be replaced.  
1. **Change the CODE No. (DN) to /0 → 0/ by pushing  /  buttons for the temperature setting. (this is the setting for the filter sign lighting time.)**  
**At this time, be sure to write down the setting data displayed.**  
2. Change the CODE No. (DN) by pushing  /  buttons for the temperature setting.  
Similarly, be sure to write down the setting data displayed.  
3. Repeat the step 2-2 to set the other settings in the same way and write down the setting data as shown in the table 1 (example).  
\* The CODE No. (DN) are ranged from “0/” to “FF”. The CODE No. (DN) may skip.
- Step 3** After writing down all setting data, push  button to return to the normal stop status. (It takes approx. 1 min until the remote controller operation is available again.)

### CODE No. required at least

DN	Contents
10	Type
11	Indoor unit capacity
12	System address
13	Indoor unit address
14	Group address

1. The CODE No. for the Indoor unit type and Indoor unit capacity are required to set the rotation number setting of the fan.
2. If the system/indoor/group addresses are different from those before replacement, the auto-address setting mode starts and the manual resetting may be required again. (when the multiple units group operation including twin, triple system.)

## [2] P.C. Board for indoor unit servicing replacement procedures

- Step 1** Replace the P.C. board to the P.C. board for indoor unit servicing.  
On the new P.C. board, set the same setting of the jumper wire and setting of shortcut connection connector as those of the P.C. board before replacement.
- Step 2** According to the system configuration, turn on the indoor unit following to the either methods shown below.
- a) Single operation (Indoor unit is used as standalone.)  
Turn on the indoor unit.
1. After completion of the auto-address setting mode (required time: approx. 5 min.), proceed to [3]. (System address = 1, Indoor unit address = 1, Group address = 0 (standalone) are automatically set.)
  2. Push ,  and  buttons simultaneously for more than 4 seconds to interrupt the auto-address setting mode, and proceed to [3]. (The unit No. “ALL” is displayed.)
- b) Group operation (including twin system)  
Turn on the indoor unit(s) with its P.C. board replaced to the P.C. board for indoor unit servicing, according to either methods 1 or 2 shown below.
1. Turn on only the indoor unit with its P.C. board replaced. (Be sure to confirm the remote controller is surely connected. If not, the operation [3] cannot be performed.)  
Perform either methods 1 or 2 described in item a) above.
  2. Turn on the multiple indoor units including the indoor unit with its P.C. board replaced.
    - Twin, triple, double twin, 1 system only
    - All group connections

After completion of the auto-address setting mode (required time: approx. 5 min.), proceed to [3].

- \* The header unit of the group may be changed by performing the auto-address setting.  
Also, the system address/Indoor unit address of the indoor unit with its P.C. board replaced may be assigned to the addresses (not used) other than those of the indoor units without its P.C. board replaced.  
It is recommended to keep the information in advance, which cooling system the indoor unit belongs to or whether the indoor unit works as the header unit or the follower unit in the group control operation.

### [3] Writing the setting data to EEPROM

The settings stored in the EEPROM of the P.C. board for indoor unit servicing are the factory-set values.

- Step 1** Push **SET**, **CL** and **TEST** buttons on the remote controller simultaneously for more than 4 seconds.
- \* In the group control operation, the unit No. displayed for the first time is the header unit No.
  - At this time, the CODE No. (DN) shows “/0”. Also, the fan of the indoor unit selected starts its operation and the swing operation starts if it has the louvers.
  - (The unit No. “ALL” is displayed if the auto-address setting mode is interrupted in [2] step 2 a))
- Step 2** Every time when **UNIT LOUVER** button is pushed, the indoor unit No. in the group control operation are displayed in order.
- (The settings stored in the EEPROM of the P.C. board for indoor unit servicing are the factory-set values.)
- Specify the indoor unit No. with its P.C. board replaced to the P.C. board for indoor unit servicing.  
(You cannot perform this operation if “ALL” is displayed.)
- Step 3** Select the CODE No. (DN) can be selected by pushing the **▼** / **▲** button for the temperature setting.
- Step 4** Set the indoor unit type and capacity.
- The factory-set values shall be written to the EEPROM by changing the type and capacity.
1. Set the CODE No. (DN) to “/0”. (without change)
  2. Select the type by pushing **▼** / **▲** buttons for the timer setting.  
(For example, 4-way Air Discharge Cassette Type is set to “0001”. Refer to table 2)
  3. Push **SET** button.  
(The operation completes if the setting data is displayed.)
  4. Change the CODE No. (DN) to “/1” by pushing **▼** / **▲** buttons for the temperature setting.
  5. Select the capacity by pushing **▼** / **▲** buttons for the timer setting.  
(For example, 80 Type is set to “0012”. Refer to table 3)
  6. Push **SET** button.  
(The setting completes if the setting data are displayed.)
  7. Return to the normal stop status by pushing **TEST** button.  
(Approx. 1 minute is needed to start operation of the remote controller.)
- Step 5** Write the on-site setting data to the EEPROM, such as address setting, etc. Perform the steps 1 and 2 above again.
- Step 6** Change the CODE No. (DN) to “/1” by pushing **▼** / **▲** buttons for the temperature setting.  
(this is the setting for the filter sign lighting time.)
- Step 7** Check the setting data displayed at this time with the setting data put down in [1].
1. If the setting data is different, modify the setting data by pushing **▼** / **▲** buttons for the timer setting to the data put down in [1].  
The operation completes if the setting data is displayed.
  2. If the data is the same, proceed to next step.
- Step 8** Change the CODE No. (DN) by pushing **▼** / **▲** buttons for the temperature setting. As described above, check the setting data and modify to the data put down in [1].
- Step 9** Repeat the steps 6 and 7.
- Step 10** After the setting completes, push **TEST** button to return to the normal stop status. (It takes approx. 1 min until the remote control operation is available again.)
- \* The CODE No. (DN) are ranged from “/0” to “FF”.
  - The CODE No. (DN) is not limited to be serial No.
  - Even after modifying the data wrongly and pushing **SET** button, it is possible to return to the data before modification by pushing **CL** button if the CODE No. (DN) is not changed.

<Fig. 1 RBC-AMT32E>

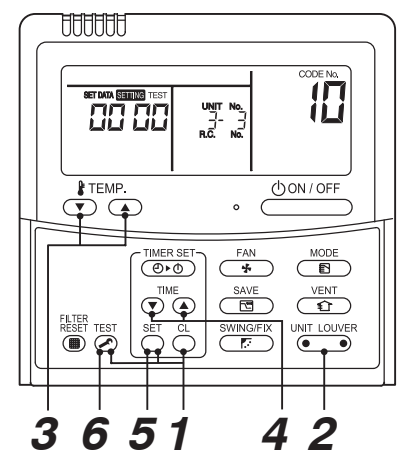

### <Fig. 2 EEPROM layout diagram>

The EEPROM (IC10) is attached to the IC socket. When detaching the EEPROM, use a tweezers, etc. Be sure to attach the EEPROM by fitting its direction as shown in the figure.

- \* Do not bend the IC lead when replacing.

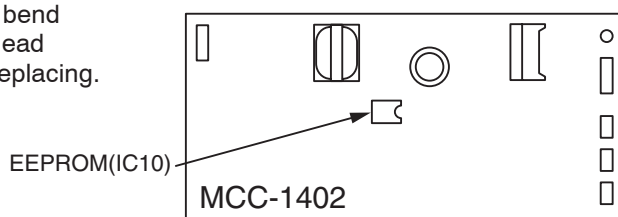

Match the notched parts of IC socket and EEPROM and then put in.

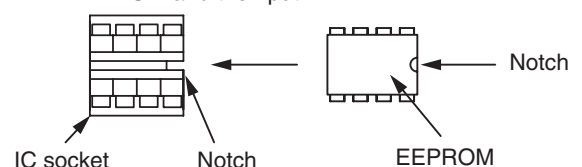

**Table 1**

DN	Item	Setting data	Factory-set value
01	Filter sign lighting time		Depending on Type
02	Filter pollution level		0000: standard
03	Central control address		0099: Not determined
06	Heating suction temperature shift		0002: +2°C
0F	Cooling only		0000: Heat pump
10	Type		Depending on model type
11	Indoor unit capacity		Depending on capacity type
12	System address		0099: Not determined
13	Indoor unit address		0099: Not determined
14	Group address		0099: Not determined
1E	Temperature range of cooling/heating automatic SW control point		0003: 3 deg (Ts ± 1.5)
28	Auto restart after power failure		0000: None
2b	Thermo output SW (T10 ③ )		0000: Thermo ON
31	Ventilation fan (standalone)		0000: Not available
32	Sensor select (Selection of static pressure)		0000: Body sensor
40	Drain pump control		0003: Drain pump OFF
60	Timer setting (wired remote controller)		0000: Available
C2	DEMAND setup		0075: 75%
d0	Remote controller save function		0001: Valid
d1	Frost protection function		0000: Not available
d3	Revolutions per minute of dry operation		0001: 210rpm

**Table 2. Type: CODE No. 10**

Setting data	Type	Type name abb.
0004	Concealed Duct Type	RAV-SM***BT-E (TR)
0007	Ceiling Type	RAV-SM***CT-E (TR)
0014	Compact 4-way Cassette Type	RAV-SM***MUT-E (TR)

**Table 3. Indoor unit capacity: CODE No. 11**

Setting data	Type
0000*	Disable
0006	40
0007	45
0009	56
0012	80
0015	110
0017	140



\* EEPROM initial value on the P.C. board for indoor unit servicing.

## 8. SETUP AT LOCAL SITE AND OTHERS

### 8-1. Indoor Unit

#### 8-1-1. Test Run Setup on Remote Controller

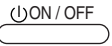
##### <Wired remote controller>



1. When pushing  button on the remote controller for 4 seconds or more, "TEST" is displayed on LC display.  
Then push  button.
  - "TEST" is displayed on LC display during operation of Test Run.
  - During Test Run, temperature cannot be adjusted but air volume can be selected.
  - In heating and cooling operation, a command to fix the Test Run frequency is output.
  - Detection of error is performed as usual. However, do not use this function except case of Test Run because it applies load on the unit.
2. Use either heating or cooling operation mode for [TEST].  
**NOTE** : The outdoor unit does not operate after power has been turned on or for approx. 3 minutes after operation has stopped.
3. After a Test Run has finished, push  button again and check that [TEST] on LC display has gone off.  
(To prevent a continuous test run operation, 60-minutes timer release function is provided to this remote controller.)

##### (Compact 4-way Cassette Type and Concealed Duct Type)

#### 1 Remove a screw which fixes the serial plate of the receiver part on the wireless remote controller.

Remove the nameplate of the receiver section by inserting a minus screwdriver, etc. into the notch at the bottom of the plate, and set the Dip switch to [TEST RUN ON].

#### 2 Execute a test operation with button on the wireless remote controller.

- ,  and  LED flash during test operation.
- Under status of [TEST RUN ON], the temperature adjustment from the wireless remote controller is invalid.

Do not use this method in the operation other than test operation because the equipment is damaged.

#### 3 Use either [COOL] or [HEAT] operation mode for test operation.

- The outdoor unit does not operate approx. 3 minutes after power-ON and operation stop.

#### 4 After the test operation finished, stop the air conditioner from the wireless remote controller, and return Dip switch of the sensor section as before.

(A 60 minutes timer clearing function is attached to the sensor section in order to prevent a continuous test operation.)

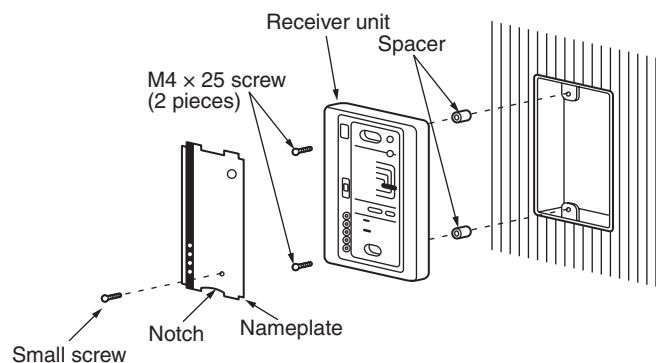



<Ceiling Type>

Procedure	Description	
<b>1</b>	Turn on power of the air conditioner.	
	The operation is not accepted for 5 minutes when power has been turned on at first time after installation, and 1 minute when power has been turned on at the next time and after. After the specified time has passed, perform a test operation.	
<b>2</b>	Push <b>[Start/Stop]</b> button and change the operation mode to <b>[COOL]</b> or <b>[HEAT]</b> with <b>[Mode]</b> button. Then change the fan speed to <b>[High]</b> using <b>[Fan]</b> button.	
<b>3</b>	Test cooling operation	Test heating operation
	Set temperature to <b>[18°C]</b> using <b>[Temperature set]</b> button.	Set temperature to <b>[30°C]</b> using <b>[Temperature set]</b> button.
<b>4</b>	After checking the receiving sound "Pi", immediately push <b>[Temperature set]</b> button to set to <b>[19°C]</b>	After checking the receiving sound "Pi", immediately push <b>[Temperature set]</b> button to set to <b>[29°C]</b> .
<b>5</b>	After checking the receiving sound "Pi", immediately push <b>[Temperature set]</b> button to set to <b>[18°C]</b> .	After checking the receiving sound "Pi", immediately push <b>[Temperature set]</b> button to set to <b>[30°C]</b> .
<b>6</b>	Then repeat the procedure <b>4 → 5 → 4 → 5</b> .	
	After approx. 10 seconds, all the display lamps on the sensor part of wireless remote controller, <b>[Operation]</b> (Green), <b>[Timer]</b> (Green), and <b>[Ready]</b> (Yellow) flash and the air conditioner starts operation. If the lamps do not flash, repeat the procedure <b>2</b> and after.	
<b>7</b>	After the test operation, push <b>[Start/Stop]</b> button to stop the operation.	

<Outline of test operation from the wireless remote controller>

Test cooling operation:

Start → 18°C → 19°C → 18°C → 19°C → 18°C → 19°C → 18°C → (Test operation) → Stop





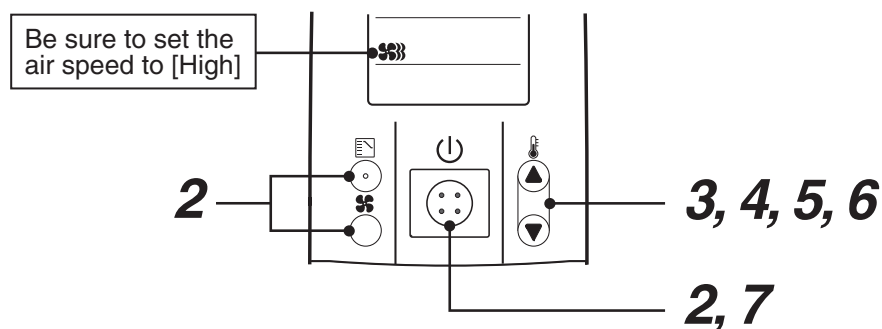





Test heating operation:

Start → 30°C → 29°C → 30°C → 29°C → 30°C → 29°C → 30°C → (Test operation) → Stop



## 8-1-2. Forced Defrost Setup of Remote Controller (For wired remote controller only)

### (Preparation in advance)

- 1** Push  +  +  buttons simultaneously for 4 seconds or more on the remote controller. (Push buttons while the air conditioner stops.)  
The first displayed unit No. is the master indoor unit address in the group control.
- 2** Every pushing  button, the indoor unit No. in the group control is displayed one after the other.  
Select a main indoor unit (outdoor unit is connected) which is to be defrosted.  
In this time, fan and louver of the selected indoor unit operate.
- 3** Using the set temperature   buttons, specify the CODE No. (DN) 8C.
- 4** Using the timer time   buttons, set time to data 0001. (0000 at shipment)
- 5** Push  button. (OK if indication lights)
- 6** Pushing  button returns the status to the normal stop status.

### (Practical operation)

- Push ON/OFF  Key.
- Select the HEAT mode.
- After while, the forced defrost signal is sent to the outdoor unit and then the outdoor unit starts defrost operation. (The forced defrost operation is performed for Max. 12 minutes.)
- After defrost operation finished, the operation returns to the heating operation.

**To execute the defrost operation again, start procedure from above item 1 .**

(If the forced defrost operation was executed once, setting of the above forced defrost operation is cleared.)

## 8-1-3. LED Display on Indoor P.C. Board

### 1. D002 (Red)

- Goes on at the same time when power was turned on (Main microcomputer operates and goes on.)
- Flashes with 1-second interval (every 500ms): When EEPROM is not provided or writing was an error.
- Flashes with 10-seconds interval (every 5S): When the mode is DISP

### 2. D203 (Red)

- Goes on when power is supplied to remote controller (Lights on the hardware)

### 8-1-4. Function Selection Setup

<Procedure> Perform setting while the air conditioner stops.

**1** Push **TEST** + **SET** + **CL** buttons simultaneously for 4 seconds or more.

The first displayed unit No. is the master indoor unit address in the group control.  
In this time, fan and louver of the selected indoor unit operate.



**2** Every pushing **UNIT LOUVER** button (button at left side), the indoor unit No. in the group control is displayed one after the other. In this time, fan and louver of the selected indoor unit only operate.



**3** Using the set temperature **TEMP.** buttons, specify the CODE No. (DN).



**4** Using the timer time **TIME** buttons, select the set data.



**5** Push **SET** button. (OK if indication lights)

- To change the selected indoor unit, proceed to Procedure **2**.
- To change item to be set up, proceed to Procedure **3**.



**6** Pushing **TEST** button returns the status to the normal stop status.

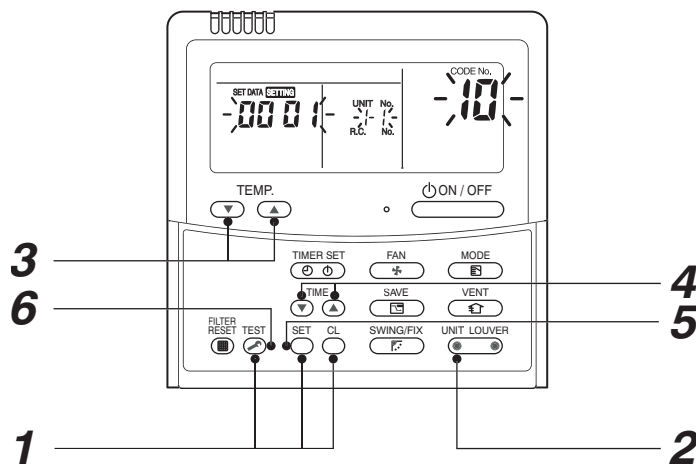

<Operation procedure>

**1 → 2 → 3 → 4 → 5 → 6 END**

**Item No. (DN) table (Selection of function)**

DN	Item	Description	At shipment														
01	Filter sign lighting time}	0000 : None 0002 : 2500H (4-Way/Duct/Ceiling Type)	0002 : 2500H														
02	Dirty state of filter	0000 : Standard                      0001 : High degree of dirt (Half of standard time)	0000 : Standard														
03	Central control address	0001 : No.1 unit            to            0064 : No.64 unit 0099 : Unfixed	0099 : Unfixed														
06	Heating suction temp shift	0000 : No shift                      0001 : +1°C 0002 : +2°C                      to            0010 : -10°C (Up to recommendation + 6)	0002 : +2°C														
0F	Cooling only	0000 : Heat pump                      0001 : Cooling only (No display of [AUTO] [HEAT])	0000 : Heat pump														
10	Type	0004 : Concealed duct type    0007 : Ceiling type 0014 : Compact 4-way cassette type	According to model type														
11	Indoor unit capacity	0000 : Unfixed                      0006 : 40 type 0007 : 45 type                      0009 : 56 type 0012 : 80 type                      0015 : 110 type 0017 : 140 type	According to capacity type														
12	Line address	0001 : No.1 unit            to            0030 : No.30 unit	0099 : Unfixed														
13	Indoor unit address	0001 : No.1 unit            to            0064 : No.64 unit	0099 : Unfixed														
14	Group address	0000 : Individual                      0001 : Master of group 0002 : Follower of group	0099 : Unfixed														
19	Louver type (Air direction adjustment) * None for concealed duct	0000 : No louver                      0001 : Swing only 0002 : 1-way                      0003 : 2-way 0004 : 4-way	According to model type														
1E	Temp difference of automatic cooling/heating mode selection COOL → HEAT, HEAT →COOL	0000 : 0 deg to                      0010 : 10 deg (For setup temperature, reversal of COOL/HEAT by ± (Data value)/2)	0003 : 3 deg (Ts±1.5)														
28	Auto restart after power failure	0000 : None                      0001 : Auto restart	0000 : None														
2A	Option		0002 : Default														
2b	Thermo output selection (T10 ③)	0000 : Indoor thermo ON 0001 : Output of outdoor comp-ON receiving	0000: Thermo. ON														
2E	Option		0000 : Default														
30	Option		0000 : Default														
31	Option		0000 : Default														
32	Sensor selection	0000 : Body TA sensor                      0001 : Remote controller sensor	0000 : Body sensor														
33	Temperature indication	0000 : °C (celsius)                      0001 : °F (Fahrenheit)	0000 : °C														
40	Option		0003 : Default														
5d	High ceiling selection (External static pressure selection)	0000 : Standard                      0001 : High ceiling 1 0002 : High ceiling 2                      0003 : High ceiling 3  <Concealed Duct type> <table border="1" style="margin-left: 20px;"> <thead> <tr> <th>Set data</th> <th>0000</th> <th>0001</th> <th>0003</th> <th>0006</th> </tr> </thead> <tbody> <tr> <td rowspan="2">External static pressure</td> <td>40 Pa</td> <td>70 Pa*1</td> <td>100 Pa*2</td> <td>20 Pa</td> </tr> <tr> <td>Standard (At shipment)</td> <td>High static pressure 1</td> <td>High static pressure 2</td> <td>Low static pressure</td> </tr> </tbody> </table> *1: SM140 become to 65Pa. *2: SM140 become to 90Pa.	Set data	0000	0001	0003	0006	External static pressure	40 Pa	70 Pa*1	100 Pa*2	20 Pa	Standard (At shipment)	High static pressure 1	High static pressure 2	Low static pressure	0000 : Standard
Set data	0000	0001	0003	0006													
External static pressure	40 Pa	70 Pa*1	100 Pa*2	20 Pa													
	Standard (At shipment)	High static pressure 1	High static pressure 2	Low static pressure													

DN	Item	Description	At shipment
60	Timer set (Wired remote controller)	0000 : Available (Operable) 0001 : Unavailable (Operation prohibited)	0000 : Available
8b	Correction of high heat feeling	0000 : None                      0001 : Correction	0000 : None
42	Self clean time	0000: None 0001: 0.5h to 0.012: 6.0h The case that compressor-ON time is 10 to 60 minutes is set up. When ON time is over 60 minutes, the operating time becomes two times of it.	0002: 1 hour
C2	Power saving (Current demand × % to outdoor unit)	0050: 50%    to    0100: 100%	0075: 75%
CC	Forced stop setting for self clean	0000: None                      0001: Set	0000: None
CD	Self clean stop function when [START/STOP] operation was prohibited	When stopping the air conditioner (including "Fire alarm" of the control system, etc.) while [START/STOP] operation is prohibited (Central 1, 2) from the central controller side, 0000: Valid (No self cleaning) 0001: Invalid (Self cleaning)	0000: Valid
D0	Existence of Power save operation	0000: Invalid (Unavailable) 0001: Valid (Available)	0001: Valid (Available)
D1	Existence of 8°C heating operation function	0000: Invalid (Unavailable)} 0001: Valid (Available)	0000: Invalid (Unavailable)
D3	Revolution count of self clean	0000: Invalid (Self cleaning is not performed.) 0001: Valid (Self cleaning is performed at 210 rpm.)	0001: Valid (210rpm/operation)
D4	Display/ No display of [SELF CLEANING] during self clean operation	0000: Displayed, 0001: Not displayed	0000: Displayed

## 8-1-5. Cabling and Setting of Remote Controller Control

### 2-remote controller control (Controlled by 2 remote controllers)

This control is to operate 1 or multiple indoor units are controlled by 2 remote controllers.  
(Max. 2 remote controllers are connectable.)

#### • When connected 2 remote controllers operate an indoor unit

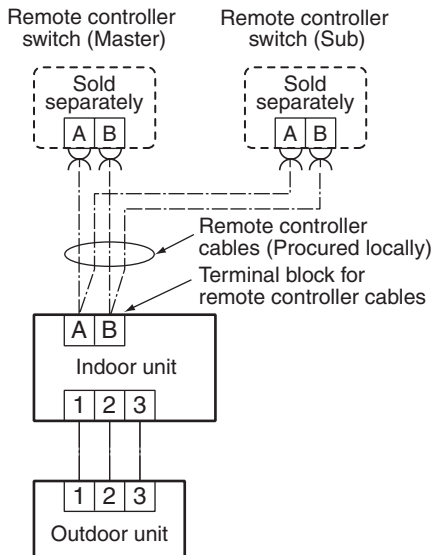

#### • When connected 2 remote controllers operate the twin

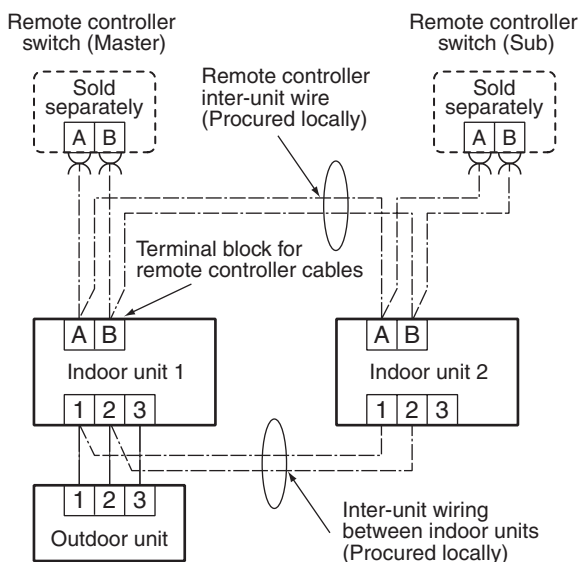

#### (Setup method)

One or multiple indoor units are controlled by two remote controllers.  
(Max. 2 remote controllers are connectable.)

### <Wired remote controller>

#### How to set wired remote controller as sub remote controller

Change DIP switch inside of the rear side of the remote controller switch from remote controller master to sub. (In case of RBC-AMT32E)

Remote controller (Inside of the rear side)

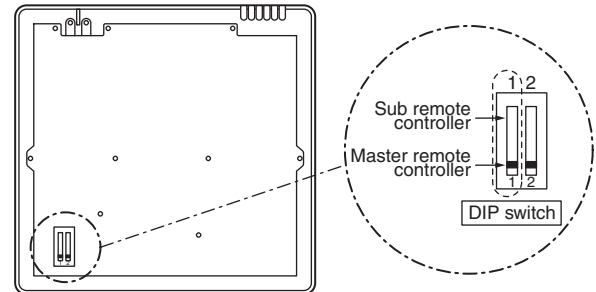

### <Wireless remote controller>

#### How to set wireless remote controller to sub remote controller

Standalone receiver (TCB-AX21E2)

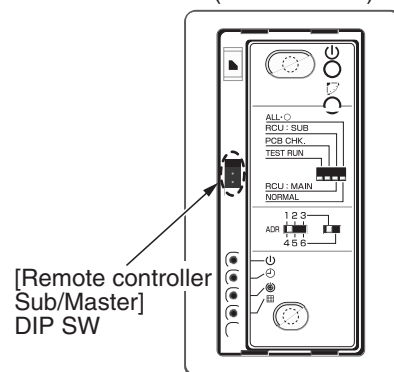

#### [Operation]

1. The operation contents can be changed by Last-push-priority.
2. Use a timer on either Master remote controller or Sub remote controller.

### <Wireless remote controller>

#### (Ceiling Type)

#### How to set wireless remote controller as sub remote controller

Turn Bit [3: Remote controller Sub/Master] of the switch S003 from OFF to ON.

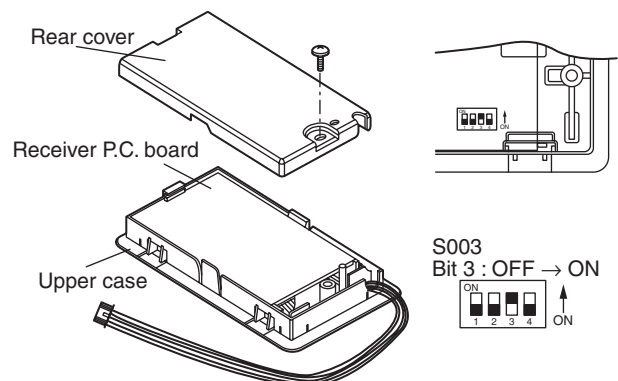

## 8-1-6. Monitor Function of Remote Controller

### ■ Calling of sensor temperature display

#### <Contents>

Each sensor temperature of the remote controller, indoor unit, and outdoor unit can become known by calling the service monitor mode from the remote controller.

#### <Procedure>

- 1 Push **TEST** + **CL** buttons simultaneously for 4 seconds to call the service monitor mode.

The service monitor goes on, the master indoor unit No. is displayed, at first and then the temperature of **CODE No. 00** is displayed.

- 2 Push temperature set **TEMP.** buttons and then change the **CODE No.** of data to be monitored.

The item code list is shown below:

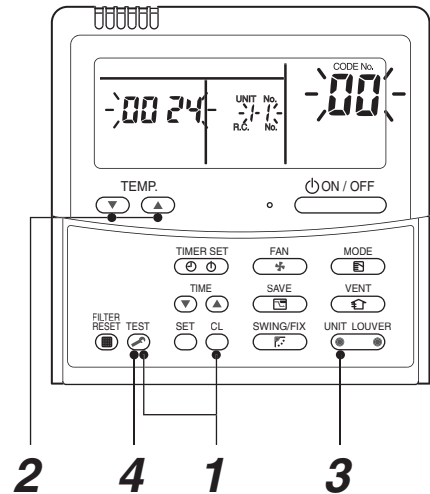

<Operation procedure>

**1 → 2 → 3 → 4**

Returned to usual display

	CODE No.	Data name	Unit
Indoor unit data	01	Room temperature (Remote controller)	°C
	02	Indoor suction temperature (TA)	°C
	03	Indoor heat exchanger (Coil) temperature (TCJ)	°C
	04	Indoor heat exchanger (Coil) temperature (TC)	°C
	07	Indoor fan revolution frequency	rpm
	F2	Indoor fan calculated operation time	×100h
	F3	Filter sign time	×1h
	F8	Indoor discharge temperature	°C

	CODE No.	Data name	Unit
Outdoor unit data	60	Outdoor heat exchanger (Coil) temperature (TE)	°C
	61	Outside temperature (TO)	°C
	62	Compressor discharge temperature (TD)	°C
	63	Compressor suction temperature (TS)	°C
	65	Heat sink temperature (THS)	°C
	6A	Operation current (× 1/10)	A
	6D	Outdoor heat exchanger (Coil) temperature (TL)	°C
	70	Compressor operation frequency	rps
	72	Outdoor fan revolution frequency (Lower)	rpm
	73	Outdoor fan revolution frequency (Upper)	rpm
	F1	Compressor calculated operation time	×100h



- 3 Push **UNIT LOUVER** button to select the indoor unit to be monitored. Each data of the indoor unit and its outdoor units can be monitored.



- 4 Pushing **TEST** button returns the status to the usual display.

- The data value of each item is not the real time, but value delayed by a few seconds to ten-odd seconds.
- If the combined outdoor unit is one before 2 or 3 series, the outdoor unit data [6D], [70], [72] and [73] are not displayed.

## ■ Calling of error history

### <Contents>

The error contents in the past can be called.

### <Procedure>

- 1 Push **CL** + **TEST** buttons simultaneously for 4 seconds or more to call the service check mode.

Service Check goes on, the **CODE No. 01** is displayed, and then the content of the latest alarm is displayed.

The number and error contents of the indoor unit in which an error occurred are displayed.

- 2 In order to monitor another error history, push the set temperature **▼** / **▲** buttons to change the error history No. (CODE No.)

CODE No. 01 (Latest) → CODE No. 04 (Old)

NOTE : 4 error histories are stored in memory.

- 3 Pushing **TEST** button returns the display to usual display.

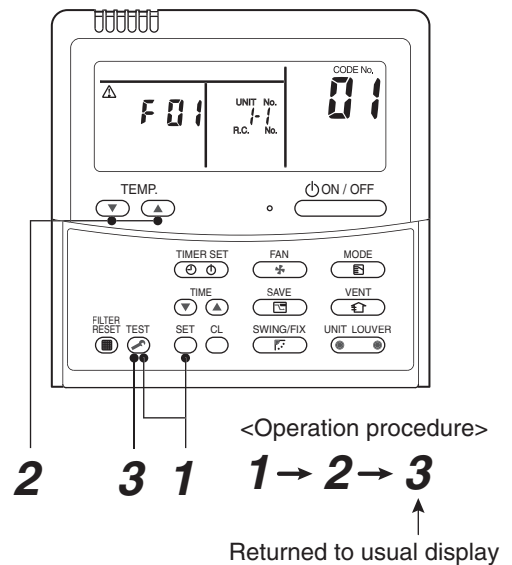

## REQUIREMENT

Do not push **CL** button, otherwise all the error histories of the indoor unit are deleted. If the error histories are deleted by pushing CL button, turn off the power supply once and then turn on the power supply again. When the error which is same as one occurred at the last before deletion continuously occurs again, it may not be stored in memory.

## (Group control operation)

In a group control, operation of maximum 8 indoor units can be controlled by a remote controller.

Twin, triple or double twin of an outdoor unit is one of the group controls.

The indoor unit connected with outdoor unit (Individual/Header of twin) controls room temperature according to setting on the remote controller.

### <System example>

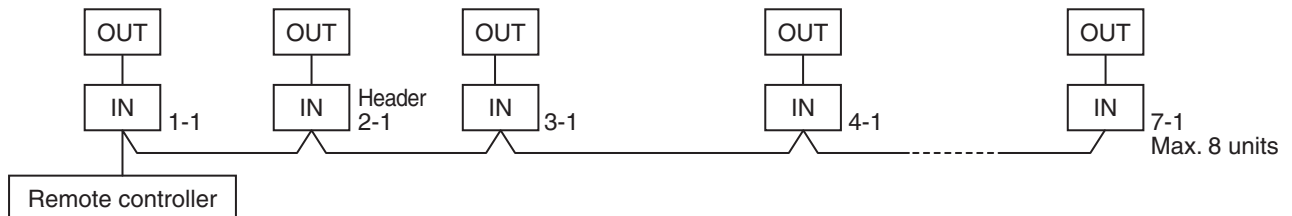

1. Display range on remote controller

The setup range (Operation mode/Air volume select/Setup temp) of the indoor unit which was set to the header unit is reflected on the remote controller.

- 1) Concealed duct high static pressure type (RAV-SMXXX) is not set up on the header unit.

- If the Concealed duct high static pressure type is the header unit:

Operation mode: [Cooling/Heating AUTO] [HEAT] [COOL] [FAN] and no [DRY]  
Air volume select: [HIGH]

- When the operation mode is [DRY], [FAN] stops in concealed duct high static pressure models.

2. Address setup

If there is no serial communication between indoor and outdoor when the power is turned on, it is judged as follower unit of the twin. (Every time when the power is turned on)

- The judgment of header (wired) / follower (simple) of twin is carried out every time. It is not stored in non-volatile memory.

Turn on power of the indoor unit to be controlled in a group within 3 minutes after setting of automatic address.

If power of the indoor unit is not turned on within 3 minutes (completion of automatic address setting), the system is rebooted and the automatic address setting will be judged again.

- 1) Connect indoor/outdoor connecting wire surely.

- 2) Check line address/indoor address/group address of the unit one by one.

Especially in case of twin, triple, double twin, check whether they are identical system address or not.

- 3) The unit No. (line/indoor gout address) which have been set once keep the present status as a rule if the unit No. is not duplicated with one of another unit.



## ■ Indoor unit power-ON sequence

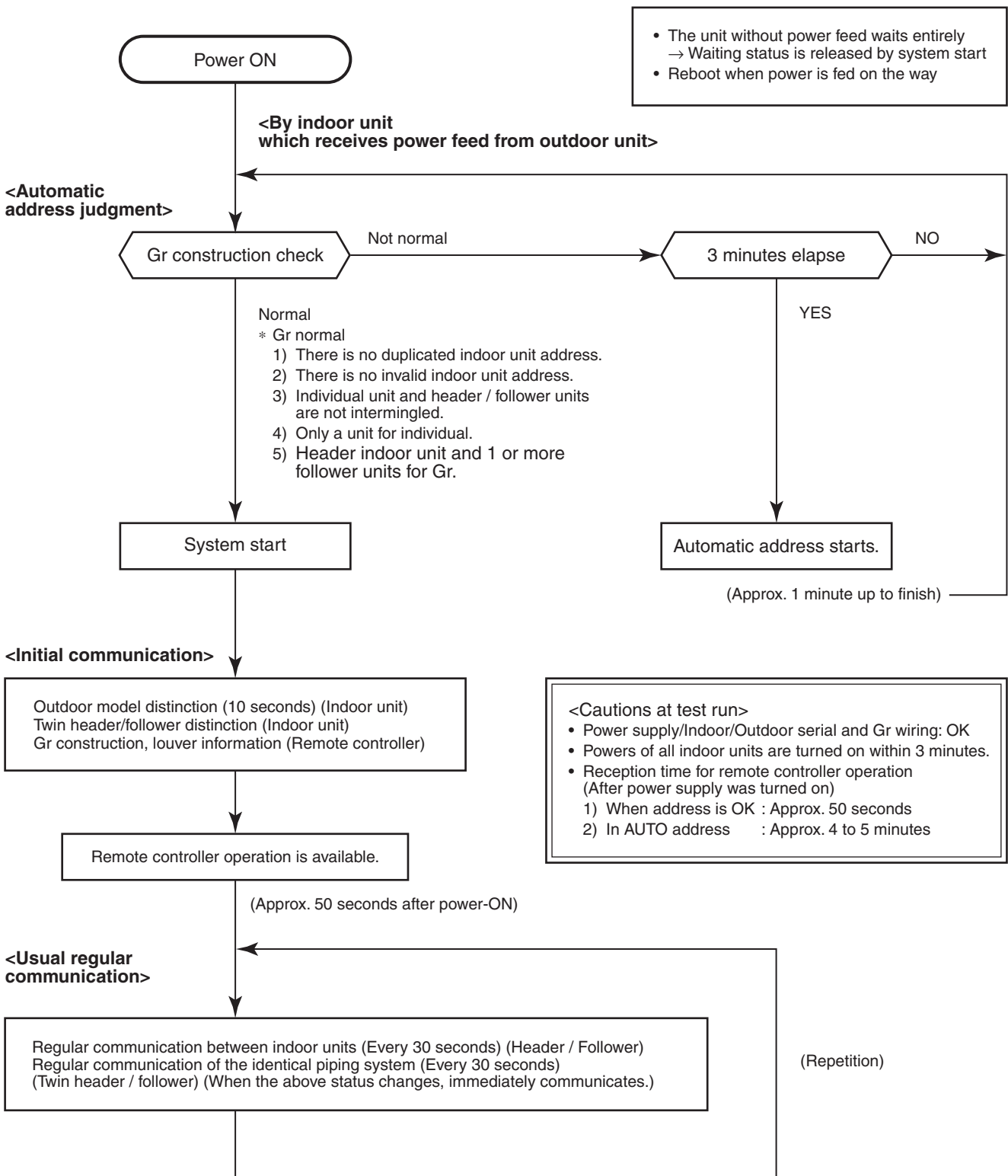

- In a group operation, if the indoor unit which was fed power after judgment of automatic address cannot receive regular communication from the header unit and regular communication on identical pipe within 120 seconds after power was turned on, it reboots (system reset).  
→ The operation starts from judgment of automatic address (Gr construction check) again.  
(If the address of the header unit was determined in the previous time, the power fed to the header unit and reboot works, the header unit may change though the indoor unit line address is not changed.)

## 8-2. Setup at Local Site / Others

Model name: TCB-PCNT30TLE

### 8-2-1. 1:1 Model Connection Interface (TCC-LINK adapter)

#### 1. Function

This model is an optional P.C. board to connect the indoor unit to 1:1 model connection interface.

#### 2. Microprocessor block diagram

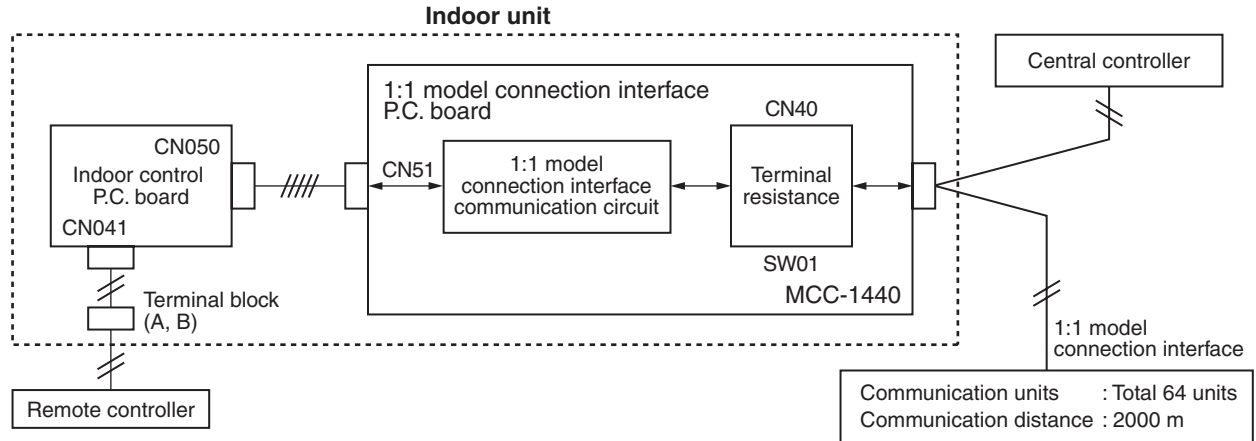

#### 3. 1:1 model connection interface wiring connection

### CAUTION

- 1) When controlling DI, SDI series collectively, 1:1 model connection interface (This option) is required.
- 2) In case of group operation, twin-triple operation, the 1:1 model connection interface is necessary to be connected to the header unit.
- 3) Connect the central control devices to the central control system wiring.
- 4) When controlling DI, SDI series only, turn on only Bit 1 of SW01 of the least line of the system address No. (OFF when shipped from the factory)

\* In case of DI, SDI series, the address is necessary to be set up again from the wired remote controller after automatic addressing.

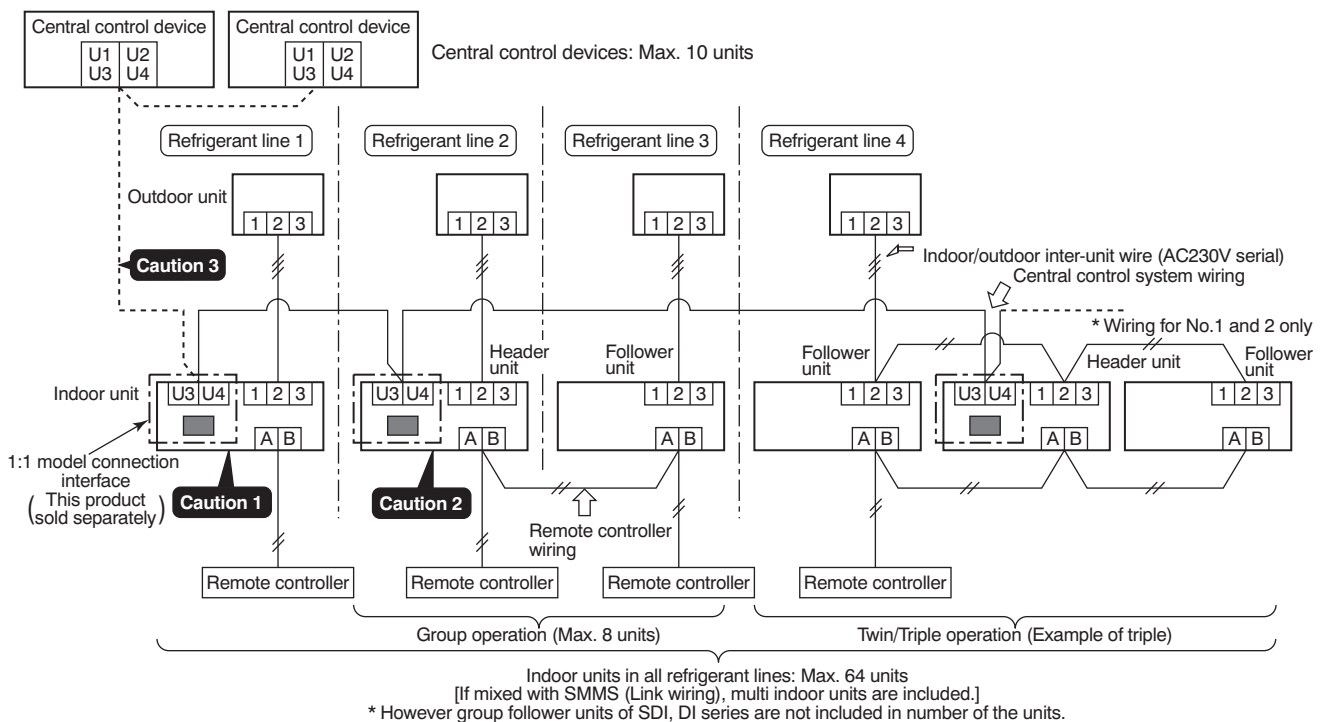

#### 4. Wiring Specifications

- Use 2-core with no polar wire.
- Match the length of wire to wire length of the central control system. If mixed in the SMMS system, the wire length is lengthened with all indoor/outdoor inter-unit wire length at side.
- To prevent noise trouble, use 2-core shield wire.
- Connect the shield wire by closed-end connection and apply open process (insulating process) to the last terminal. Ground the earth wire to 1 point at indoor unit side. (In case of central controlling of digital inverter (DI, SDI) unit setup)

No. of wires	Size
2	Up to 1000m: twisted wire 1.25mm <sup>2</sup> Up to 2000m: twisted wire 2.0mm <sup>2</sup>

#### CAUTION

- 1) Closed-end connection of shield wire (Connect all the connecting parts of each indoor unit)
- 2) Apply open process to the last terminal (insulating process).
- 3) Ground earth wire to 1 point at indoor unit side.

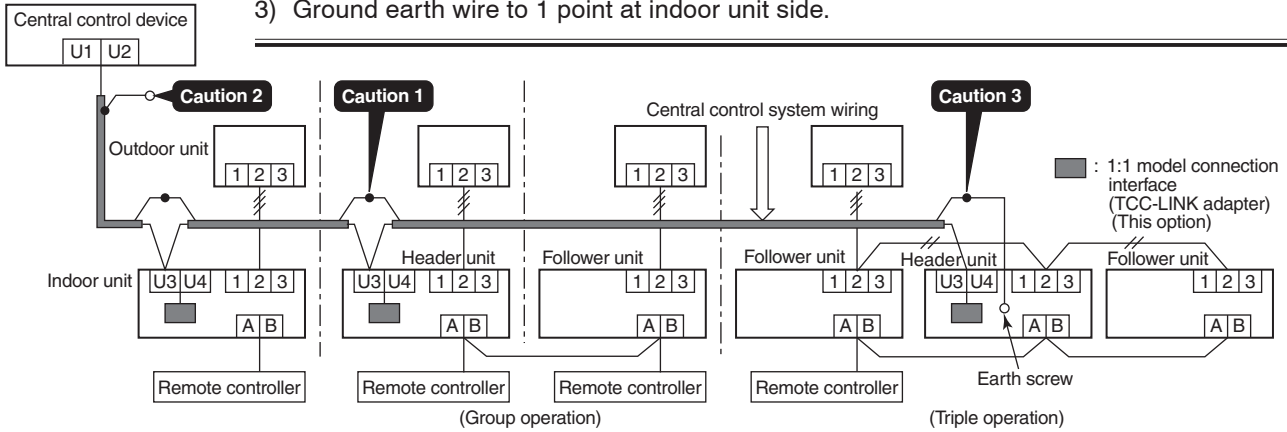

#### 5. P.C. Board Switch (SW01) Setup

When performing collective control by customized setup only, the setup of terminator is necessary.

- Using SW01, set up the terminator.
- Set up the terminator to only the interface connected to the indoor unit of least line address No.

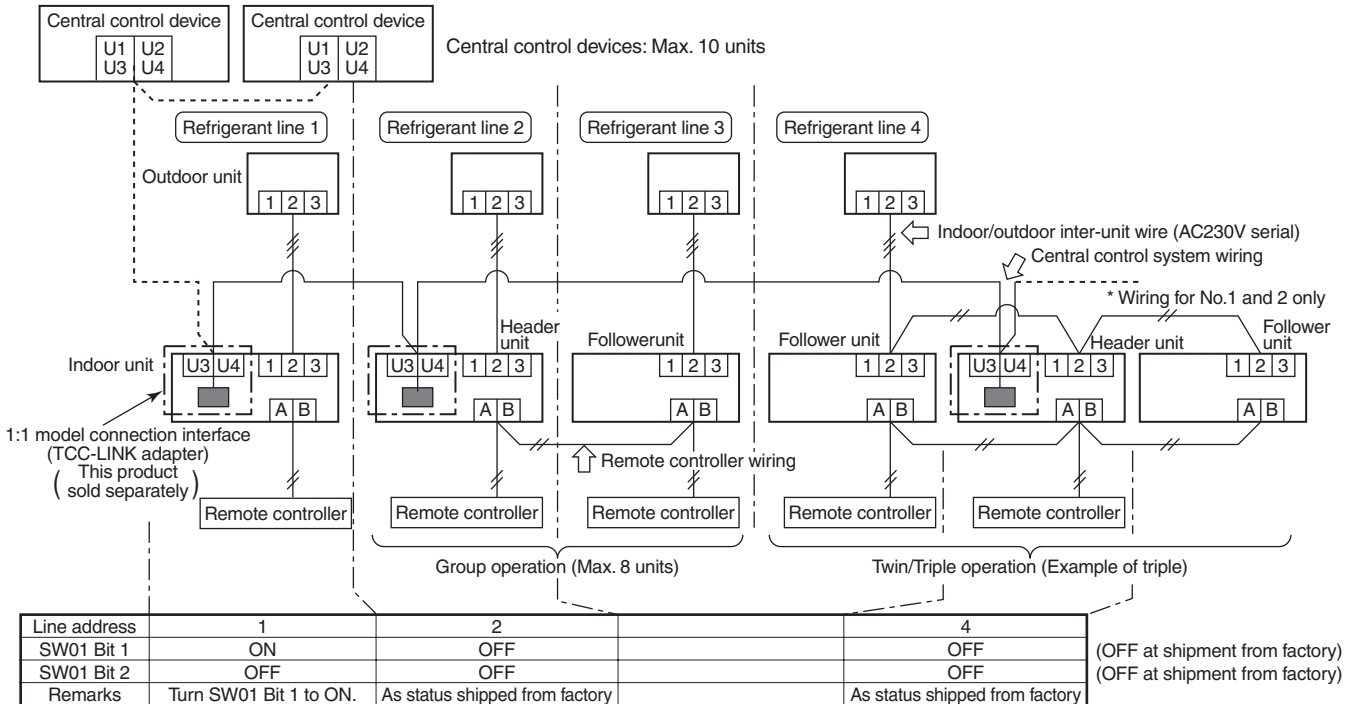

(Reference) Setup contents of switch

SW01		Terminator	Remarks
Bit 1	Bit 2		
OFF	OFF	None	Mixed with SMMS (Link wiring) at shipment from factory
ON	OFF	100Ω	Central control by digital inverter only
OFF	ON	75Ω	Spare
ON	ON	43Ω	Spare

## 6. External view of P.C. board assembly

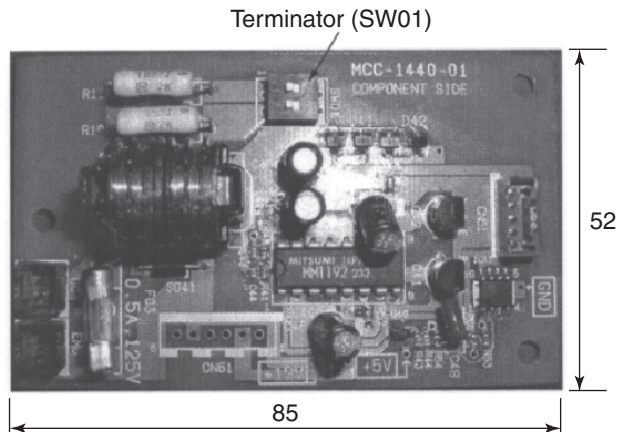

## 7. Address setup

In addition to set up the central control address, it is necessary to change the indoor unit number. (Line/Indoor/Group address). For details, refer to 1:1 model connection interface Installation Manual.

### 8-3. How to Set up Central Control Address Number

When connecting the indoor unit to the central control remote controller using 1:1 model connection interface, it is necessary to set up the central control address number.

- The central control address number is displayed as the line No. of the central control remote controller.

#### How to set up from indoor unit side by remote controller

<Procedure> Perform setup while the unit stops.

- 1 Push + buttons for 4 seconds or more.

When group control is executed, first the unit No. **ALL** is displayed and all the indoor units in the group control are selected. In this time, fans of all the selected indoor units are turned on. (Fig. 1)  
(Keep **ALL** displayed status without pushing button.)

In case of individual remote controller which is not group-controlled, Line address and Indoor unit address are displayed.

- 2 Using temperature setup buttons, specify CODE No. 03.

- 3 Using timer time buttons, select the SET DATA.  
The setup data is shown in the table below (Table 1).

- 4 Push button. (OK if display goes on.)

- To change the item to be set up, return to Procedure 2.

- 5 Push button.

The status returns to usual stop status.

(Table 1)

SET DATA	Central control address No.
0001	1
0002	2
0003	3
⋮	⋮
0064	64
0099	Unset (Setup at shipment from factory)

(Fig.1)

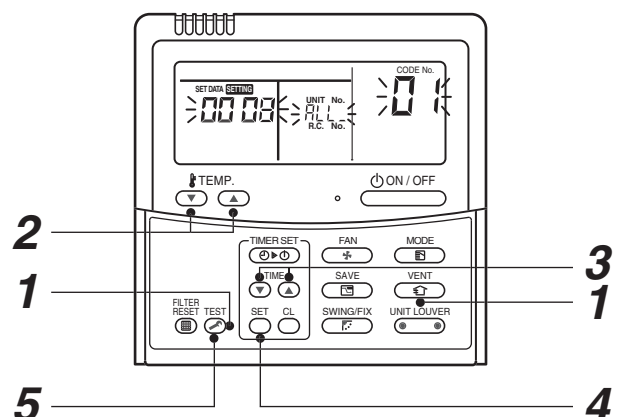

## How to confirm the central control address (New function for AMT32E remote controller)

<Procedure> It can be confirmed even during operation or stopping.

**1** Push  button for 4 seconds or more.



**2** In the frame at left side of the remote controller screen, the lighting set contents are displayed.

During unset time, *0099* (At shipment from factory) is displayed.



**3** After lighting display for 3 seconds, the display automatically disappears.

If any button is pushed during display, immediately the display disappears and then the pushed button is displayed.

## 9. ADDRESS SETUP

### 9-1. Address Setup

#### <Address setup procedure>

When an outdoor unit and an indoor unit are connected and they are twin-triple, or when an outdoor unit is connected to each indoor unit respectively in the group operation even if multiple refrigerant lines are provided, the automatic address setup completes with power-ON of the outdoor unit. The operation of the remote controller is not accepted while automatic address works. (Approx. 4 to 5 minutes)

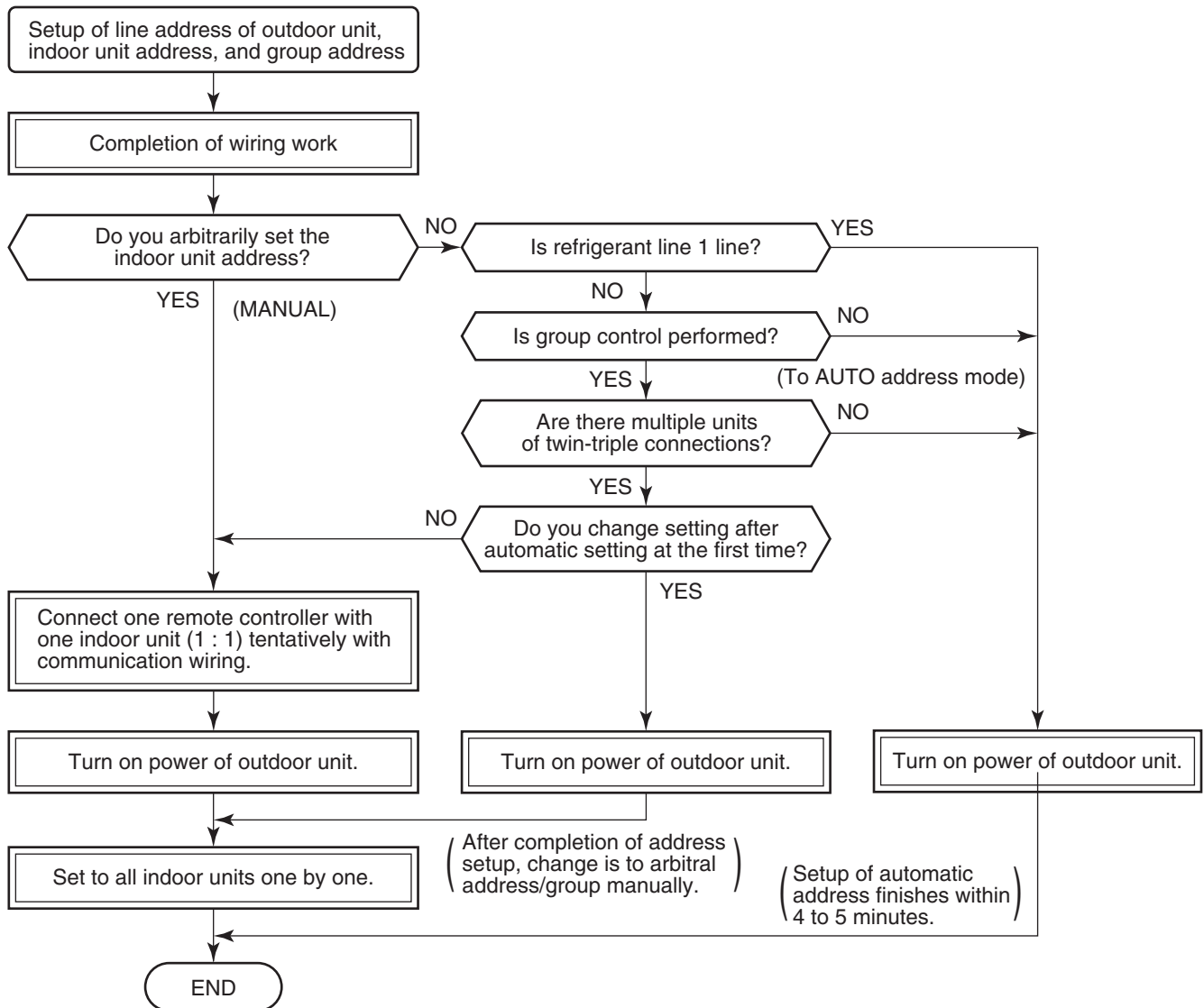

- When the following addresses are not stored in the neutral memory (IC10) on the indoor P.C. board, a test run operation cannot be performed. (Unfixed data at shipment from factory)

	CODE No.	Data at shipment	SET DATA range
Line address	12	0099	0001 (No. 1 unit) to 0030 (No. 30 unit)
Indoor unit address	13	0099	0001 (No. 1 unit) to 0064 (No. 64 unit) Max. value of indoor units in the identical refrigerant line (Double twin = 4)
Group address	14	0099	0000 : Individual (Indoor units which are not controlled in a group) 0001 : Header unit (1 indoor unit in group control) 0002 : Follower unit (Indoor units other than header unit in group control)

## 9-2. Address Setup & Group Control

### <Terminology>

- Indoor unit No. : N – n = Outdoor unit line address N (Max. 30) – Indoor unit address n (Max. 64)
- Group address : 0 = Single (Not group control)  
 1 = Header unit in group control  
 2 = Follower unit in group control
- Header unit (= 1) : The representative of multiple indoor units in group operation sends/receives signals to/from the remote controllers and follower indoor units.  
 (\*It has no relation with an indoor unit which communicates serially with the outdoor units.)  
 The operation mode and setup temperature range are displayed on the remote controller LCD. (Except air direction adjustment of louver)
- Follower unit (= 2) : Indoor units other than header unit in group operation  
 Basically, follower units do not send/receive signals to/from the remote controllers.  
 (Except errors and response to demand of service data)
- Master unit (Representative unit) (Header Twin) : This unit communicates with the indoor unit (sub) which serial-communicates with the outdoor units and sends/receives signal (Command from compressor) to/from the outdoor units as the representative of the cycle control in the indoor units of the identical line address within the minimum unit which configures one of the refrigerating cycles of Twin, Triple, Double twin.
- Sub unit (Subordinate unit) (Follower Twin) : Indoor units excluding the header unit in Twin, Triple, Double twin  
 This unit communicates with (Master) indoor unit in the identical line address and performs control synchronized with (Master) indoor unit.  
 This unit does not perform the signal send/receive operation with the outdoor units.:  
 N judgment for serial signal error.

### 9-2-1. System configuration

#### 1. Single

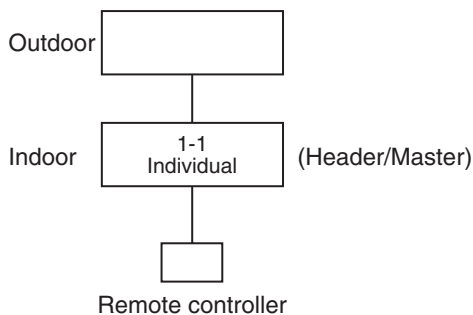

#### 2. Single group operation

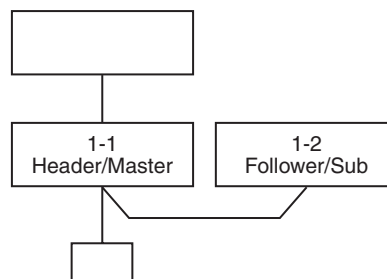

#### 3. Triple

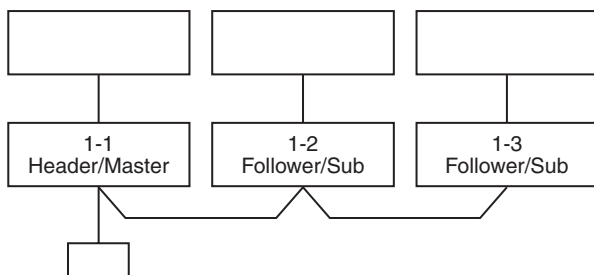

#### 4. Single group operation

- Each indoor unit controls the outdoor unit individually.

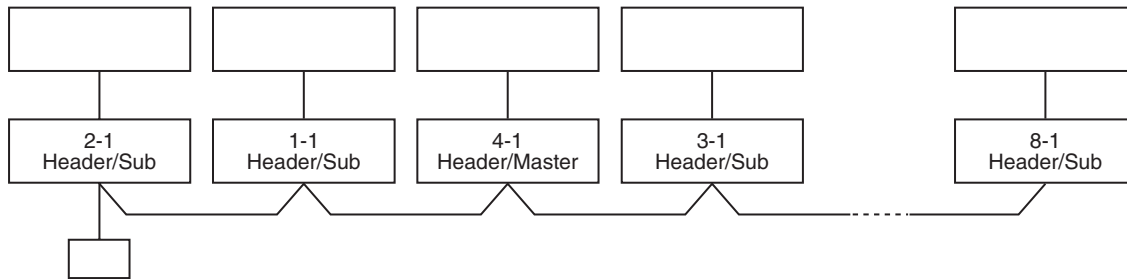

#### 5. Multiple groups operation (Manual address setting)

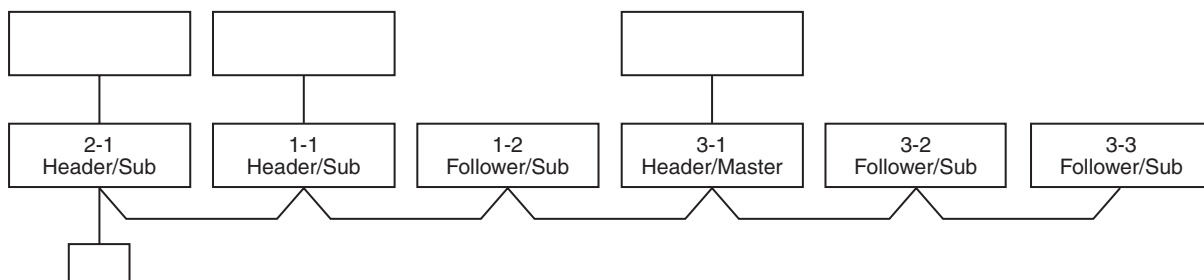

- **Master unit:** The master unit receives the indoor unit data (thermo status) of the sub (Without identical line address & indoor/outdoor serial) and then finally controls the outdoor compressor matching with its own thermo status. The master unit sends this command information to the sub unit.
- **Sub unit:** The sub unit receives the indoor unit data from the master (With identical line address & indoor/outdoor serial) and then performs the thermo operation synchronized with the master unit. The sub unit sends own thermo ON/OFF demand to the master unit.

**(Example)**

No. 1-1 master unit sends/receives signal to/from No. 1-2 and No. 1-3 sub units.  
(It is not influenced by the line 2 or 3 address indoor unit.)



## 9-2-2. Automatic Address Example from Unset Address (No miswiring)

### 1. Standard (One outdoor unit)

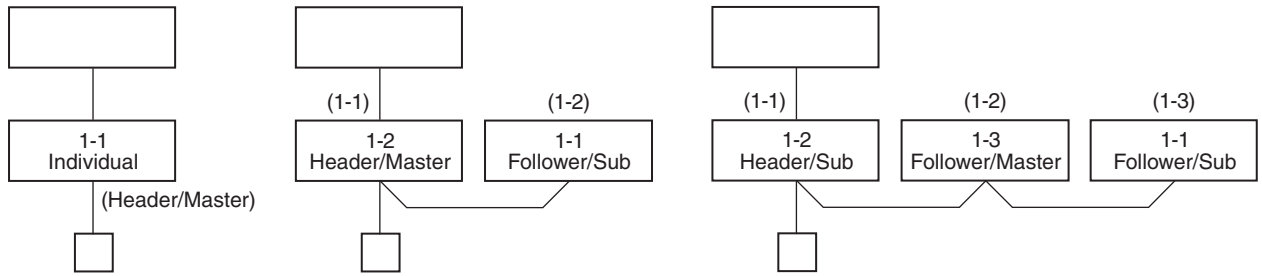

**Only turning on source power supply (Automatic completion)**

### 2. Group operation

(Multiple outdoor units = Multiple indoor units with serial communication only, without twin)

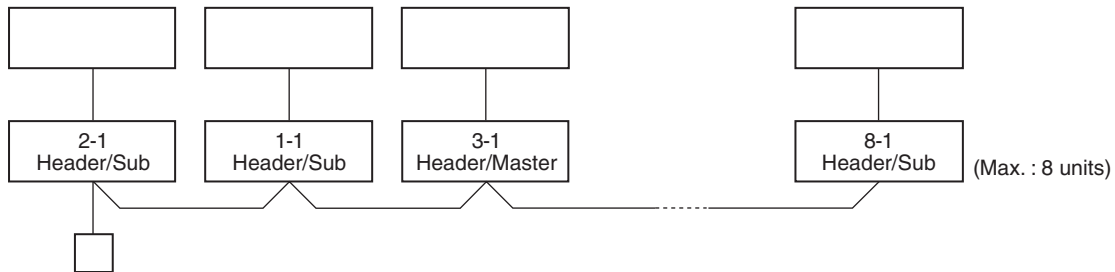

**Only turning on source power supply (Automatic completion)**

### 3. Multiple groups operation

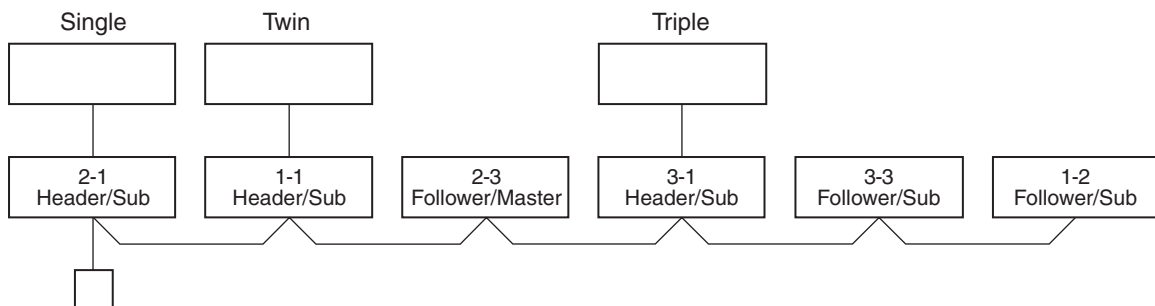

**Change is necessary**  
**Manually change addresses of the multiple sub units**  
**simultaneously from the remote controller.**

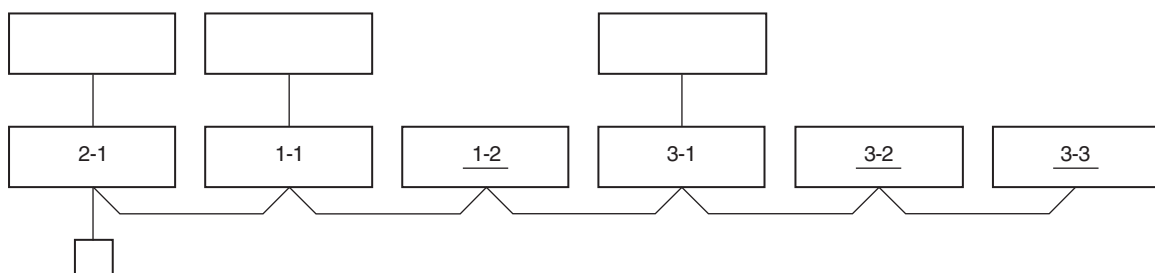

### 9-3. Address Setup (Manual Setting from Remote Controller)

In case that addresses of the indoor units will be determined prior to piping work after wiring work

- Set an indoor unit per a remote controller.
- Turn on power supply.

(Example of 2-lines wiring)  
(Real line: Wiring, Broken line: Refrigerant pipe)

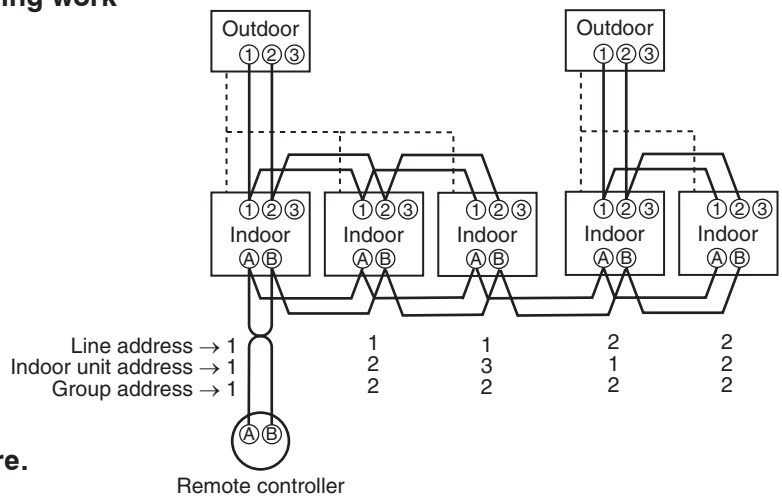

**1** Push **SET** + **CL** + **TEST** buttons simultaneously for 4 seconds or more.

**2** (Line address)  
Using the temperature setup **▼** / **▲** buttons, set **12** to the CODE No.

**3** Using timer time **▼** / **▲** buttons, set the line address.

**4** Push **SET** button. (OK when display goes on.)

**5** (Indoor unit address)  
Using the temperature setup **▼** / **▲** buttons, set **13** to the CODE No.

**6** Using timer time **▼** / **▲** buttons, set **1** to the line address.

**7** Push **SET** button. (OK when display goes on.)

**8** (Group address)  
Using the temperature setup **▼** / **▲** buttons, set **14** to the CODE No.

**9** Using timer time **▼** / **▲** buttons, set **0000** to Individual, **0001** to Header unit, and **0002** to Folloer unit.

**10** Push **SET** button. (OK when display goes on.)

**11** Push **TEST** button.

Setup completes. (The status returns to the usual stop status.)

For the above example, perform setting by connecting singly the wired remote controller without remote controller inter-unit wire.

Group address  
Individual : 0000  
Header unit : 0001  
Follower unit : 0002 } In case of group control

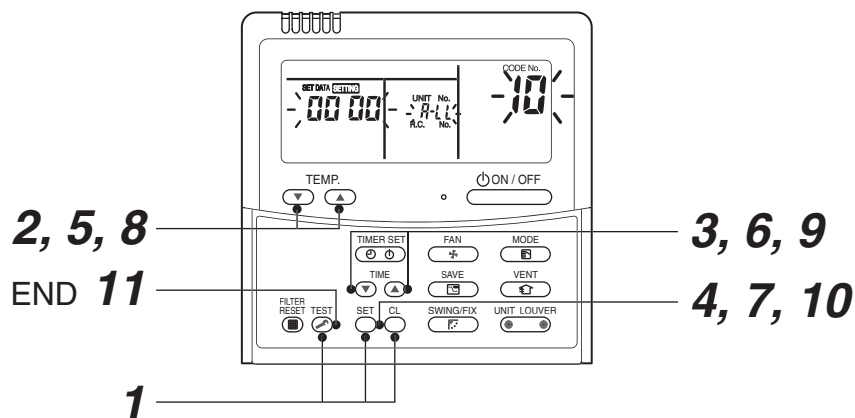

<Operation procedure>

**1 → 2 → 3 → 4 → 5 → 6 → 7 → 8 → 9 → 10 → 11 END**

## 9-4. Confirmation of Indoor Unit No. Position

### 1. To know the indoor unit addresses though position of the indoor unit body is recognized

- In case of individual operation (Wired remote controller : indoor unit = 1 : 1)  
(Follow to the procedure during operation)

#### <Procedure>

**1** Push  button if the unit stops.

**2** Push  button.

Unit No. *1-1* is displayed on LCD.

(It disappears after several seconds.)

The displayed unit No. indicate line address and indoor unit address. (When other indoor units are connected to the identical remote controller (Group control unit), other unit numbers are also displayed every pushing  button.

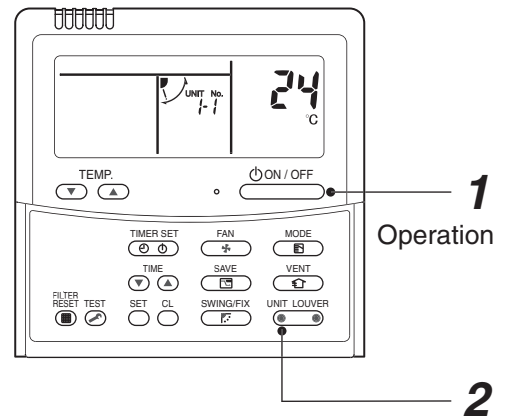

<Operation procedure>

**1 → 2** END

### 2. To know the position of indoor unit body by address

- To confirm the unit No. in the group control  
(Follow to the procedure during operation) (in this procedure, the indoor units in group control stop.)

#### <Procedure>

The indoor unit numbers in the group control are successively displayed, and fan, louver, and drain pump of the corresponding indoor unit are turned on. (Follow to the procedure during operation)

**1** Push  and  buttons simultaneously for 4 seconds or more.

- Unit No. *ALL* is displayed.
- Fans and louvers of all the indoor units in the group control operate.

**2** Every pushing  button, the unit numbers in the group control are successively displayed.

- The unit No. displayed at the first time indicates the header unit address.
- Fan and louver of the selected indoor unit only operate.

**3** Push  button to finish the procedure. All the indoor units in the group control stop.

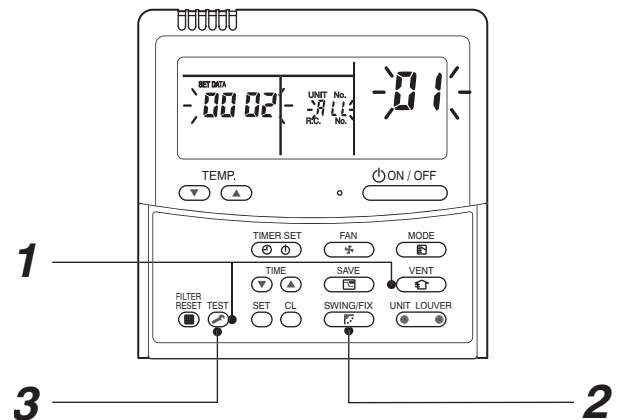

<Operation procedure>

**1 → 2 → 3** END

## 10. DETACHMENTS

### 10-1. Compact 4-Way Cassette Type

RAV-SM\*\*\*MUT \*

Ceiling panel: RBC-UM11PG(W)E

#### Preparing work:

1. Before work, be sure to stop the power supply of the air conditioner and turn off switch of the power supply breaker. (Otherwise an electric shock may be caused.)
2. Be sure to put on the gloves when working; otherwise an injury may be caused with parts sharp edges etc.

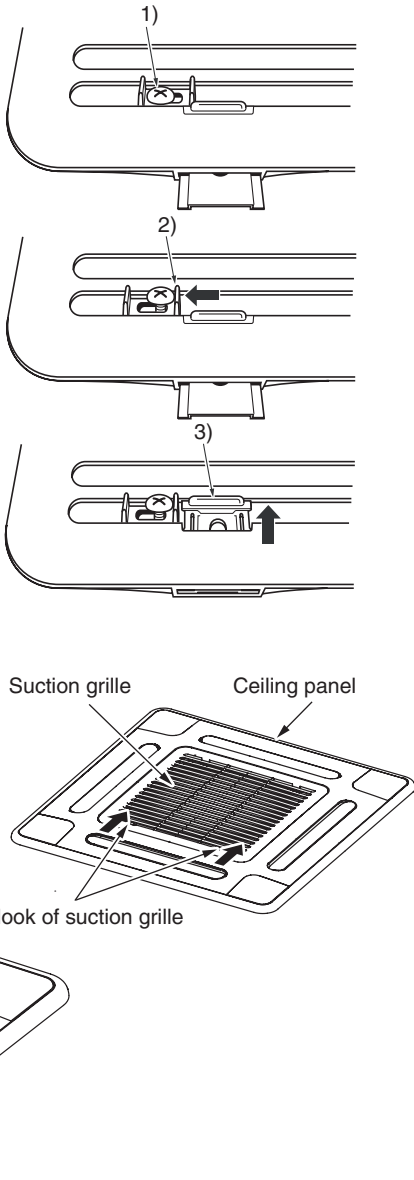
No.	Part name	Procedure	Remarks
①	Suction grille	<p><b>1. Detachment</b></p> <ol style="list-style-type: none"> <li>1) Loosen the fixing screw.</li> <li>2) Slide the fixing bracket toward the outside.</li> <li>3) Slide the air intake grille buttons to detach the air intake grille from the ceiling panel. Lower the grille slowly whilst holding</li> <li>4) Slide hooks (2 positions) of the suction grille to inner side, and then hang down the suction grille.</li> <li>5) Take off the strap that connects the panel and the suction grille, and then lift up shaft of the suction grille to remove the suction grille.</li> </ol> <p><b>2. Attachment</b></p> <ol style="list-style-type: none"> <li>1) Hook shaft of the suction grille to the panel.</li> <li>2) Hook strap of the suction grille to the original position of the panel.</li> <li>3) Close the suction grille and slide the hooks outward to fix it.</li> <li>4) Slide the fixing bracket toward the inner side.</li> <li>5) Tighten the fixing screw.</li> </ol>	

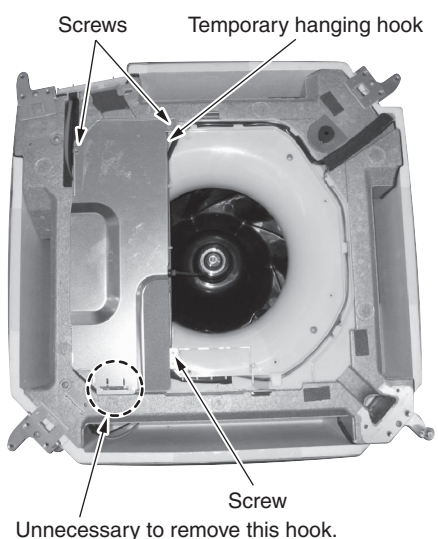
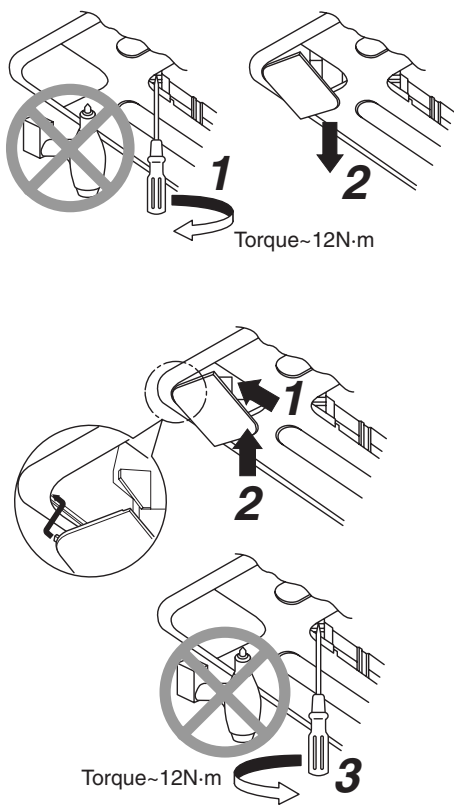
No.	Part name	Procedure	Remarks
②	Electric parts cover	<p><b>1. Detachment</b></p> <ol style="list-style-type: none"> <li>1) Perform work of procedure ① -1.</li> <li>2) Take off screws (Ø4 × 10, 3 pcs.) fixing the electric parts cover.</li> <li>3) Remove the electric parts cover from the temporary hanging hook of the electric parts cover, and then open the cover.</li> </ol> <p><b>2. Attachment</b></p> <ol style="list-style-type: none"> <li>1) Close the electric parts cover and hook the cover hole to the temporary hanging hook.</li> <li>2) Tighten the fixing screws. (Ø4 × 10, 3 pcs.)</li> </ol>	
③	Adjust corner cover	<p><b>1. Detachment</b></p> <ol style="list-style-type: none"> <li>1) Perform work of procedure of ① -1.</li> <li>2) Turn clockwise screws (4 positions) at the suction port corner until adjust corner cover rises up.</li> </ol> <p><b>NOTE)</b> When you work, keep the torque at below 12N•m. Do not use an electric screwdriver; otherwise the mechanism of adjust corner cover may be damaged and not be removed.</p> <ol style="list-style-type: none"> <li>3) Pull downward the risen-up part of adjust corner cover and remove it.</li> <li>4) Remove the strap of adjust corner cover.</li> </ol> <p><b>2. Attachment</b></p> <ol style="list-style-type: none"> <li>1) Attach the strap of adjust corner cover to the panel, hook claws of adjust corner cover to the panel corner, and then push the opposite side into the panel.</li> <li>2) Turn screws (4 positions) of the suction port corner counterclockwise until bump between adjust corner cover and panel disappears.</li> </ol> <p><b>NOTE)</b> When you work, keep the torque at below 12N•m. Do not use an electric screwdriver; otherwise the mechanism of adjust corner cover may be damaged and not be removed.</p>	

No.	Part name	Procedure	Remarks
④	Ceiling panel	<p><b>1. Detachment</b></p> <ol style="list-style-type: none"> <li>1) Perform works of procedure ① -1-, ② -1, and ③ -1.</li> <li>2) Remove the flap connector (CN33, White, 5P) connected to the control P.C. board and then take off the lead wire from the clamp.</li> </ol> <p><b>NOTE)</b> Remove the connectors after unlocking the lock of the housing.</p> <ol style="list-style-type: none"> <li>3) Take off screws (M5, 4 pcs.) fixing the ceiling panel.</li> <li>4) Push the temporary bracket to inner side to remove the ceiling panel.</li> </ol> <p><b>2. Attachment</b></p> <ol style="list-style-type: none"> <li>1) Hook the panel to the temporary bracket of the drain pan of the main body.</li> </ol> <p><b>NOTE)</b> The panel has directionality. Therefore mount the panel according to the temporary bracket and the bracket mounting position.</p> <ol style="list-style-type: none"> <li>2) Tighten the fixing screws. (M5, 4 pcs.)</li> <li>3) Connect flap connector of the ceiling panel to the connector (CN33, White, 5P) of the control P.C. board.</li> </ol>	

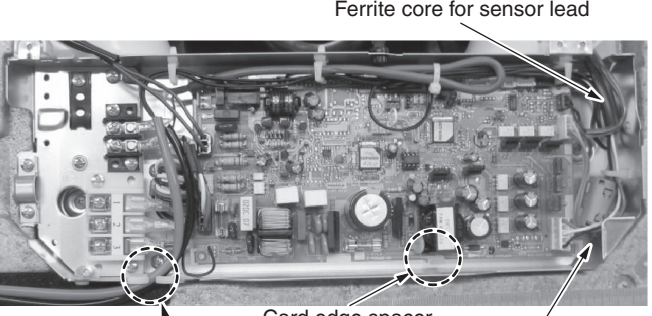
No.	Part name	Procedure	Remarks
⑤	Control P.C. board	<p><b>1. Detachment</b></p> <ol style="list-style-type: none"> <li>1) Perform works of procedure ① -1- and ② -1.</li> <li>2) Remove the connectors connected from the control P.C. board to other parts.            CN33 : Louver motor (5P, White)            CN34 : Float switch (3P, Red)            CN41 : Terminal block of remote controller (3P, Blue)            CN40 : Terminal block of crossover between inside and outside (5P, Black)            CN68 : Drain pump (3P, Blue)            CN67 : Terminal block of power supply (3P, Black)            CN101 : TC sensor (2P, Black)            CN102 : TCJ sensor (2P, Red)            CN104 : Room temp sensor (2P, Yellow)            CN333 : Fan motor power supply (5P, White)            CN334 : Fan motor position detection (5P, White)</li> </ol> <p><b>NOTE)</b>            Remove the connectors after unlocking the lock of the housing.</p> <ol style="list-style-type: none"> <li>3) Unlock the lock of the card edge spacer (6 positions) and then remove the control P.C. board.</li> </ol> <p><b>2. Attachment</b></p> <ol style="list-style-type: none"> <li>1) Fix the control P.C. board to the card edge spacer. (6 positions)</li> <li>2) Connect the connectors as original before being removed in item 1.</li> </ol> <p><b>NOTE)</b>            For drawing of each wire and position of ferrite core, perform wiring same as those before removing. If there is incomplete drawing of wire, short or water leakage of the parts may be caused.</p> <p>Fix the sensor lead wires with cord clamps (2 positions) so that it does not slacken at P.C. board side and draw wires as shown in the figure.</p> <p><b>&lt;Details of sensor lead wire drawing&gt;</b></p> <p>As shown in the figure, hook the sensor lead wires to claw of the piping cover and then pass them so that they are stored in the groove.</p> <p>After mounting the piping cover, check each lead wire does not hit the liquid pipe.</p> <p><b>&lt;Details of piping cover assembly and mounting&gt;</b></p>	 <p><b>Arrow view E</b></p> <p>Please note the float SW lead wires are set at inner side of the fan motor lead wires.</p> <p><b>&lt;Details of fan motor lead wire drawing&gt;</b></p> <p>Turn up the fan motor lead wires and fix surely with the cord clamp. (There should be no catching of lead wire by P.C. board.)</p> <p>Clamp (yellow, gray, black) lead wires of the fan motor and arrange them as shown in the figure.</p>



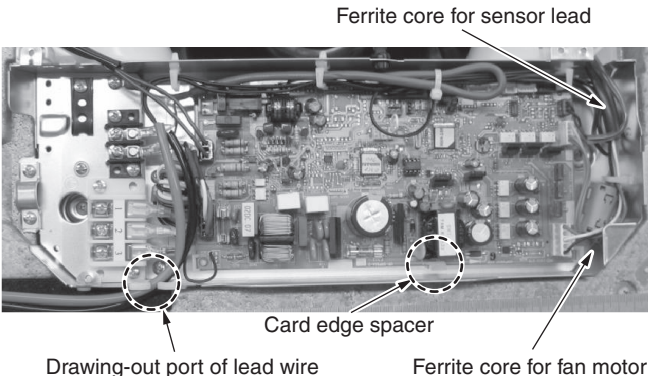
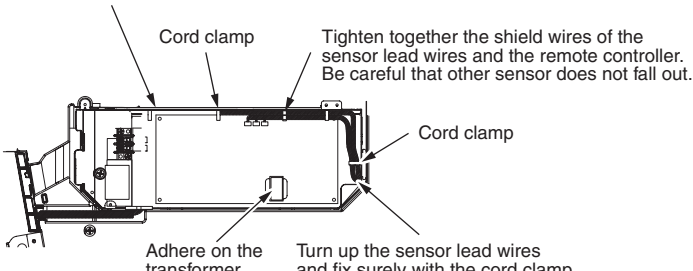
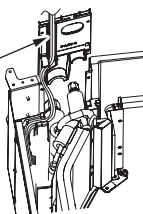
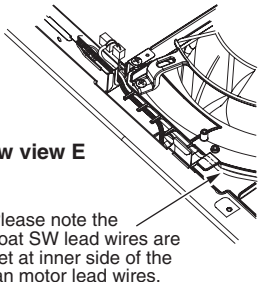

No.	Part name	Procedure	Remarks
⑥	Electric parts box	<p><b>1. Detachment</b></p> <ol style="list-style-type: none"> <li>1) Perform works of procedure ① -1-and ② -1.</li> <li>2) Remove connectors of the lead wire connected to the following connectors of the control P.C. board.            CN33 : Louver motor (5P, White)            CN34 : Float switch (3P, Red)            CN68 : Drain pump (3P, Blue)            CN101 : TC2 sensor (2P, Black)            CN102 : TCJ sensor (2P, Red)            CN333 : Fan motor power supply (5P, White)            CN334 : Fan motor position detection (5P, White)</li> </ol> <p><b>NOTE)</b>            Remove the connectors after unlocking the lock of the housing.</p> <ol style="list-style-type: none"> <li>3) Remove each lead wire from cord clamps in the electric parts box.</li> <li>4) Remove the power supply wiring, remote controller wiring, and crossover wiring.</li> <li>5) Take off screws (Ø4 × 10, 2 pcs.)</li> </ol>	
		<p><b>2. Attachment</b></p> <ol style="list-style-type: none"> <li>1) Tighten screws (Ø4 × 10, 2 pcs.) fixing the electric parts box.</li> <li>2) Connect the connectors as original before being removed in item 1.</li> <li>3) Perform power supply wiring, remote controller wiring, and crossover wiring between inside and outside.</li> </ol> <p><b>NOTE)</b>            For drawing of each wire and position of ferrite core, perform wiring same as those before removing. If there is incomplete drawing of wire, short or water leakage of the parts may be caused.</p> <p>Fix the sensor lead wires with cord clamps (2 positions) so that it does not slacken at P.C. board side and draw wires as shown in the figure.</p>  <p style="text-align: center;"><b>&lt;Details of sensor lead wire drawing&gt;</b></p> <p>As shown in the figure, hook the sensor lead wires to claw of the piping cover and then pass them so that they are stored in the groove.</p> <p>After mounting the piping cover, check each lead wire does not hit the liquid pipe.</p>  <p style="text-align: center;"><b>&lt;Details of piping cover assembly and mounting&gt;</b></p>  <p style="text-align: center;"><b>&lt;Details of fan motor lead wire drawing&gt;</b></p>	

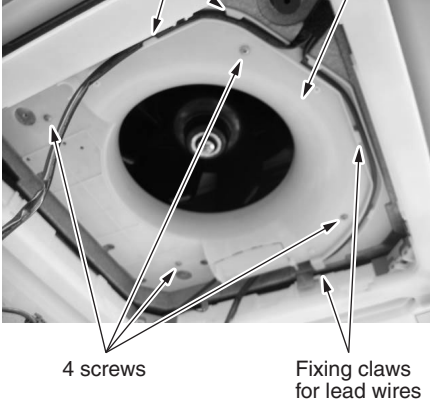
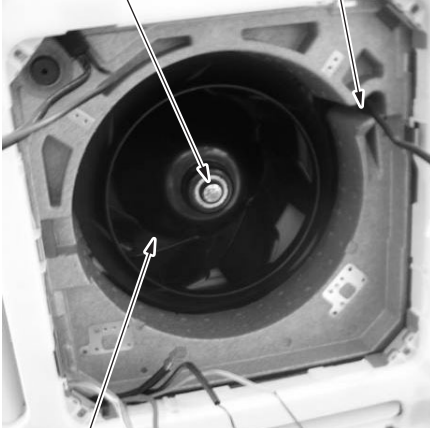

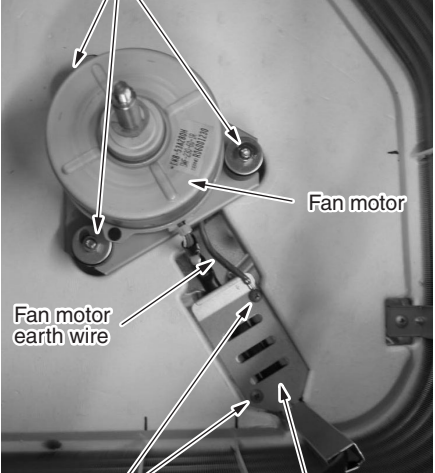
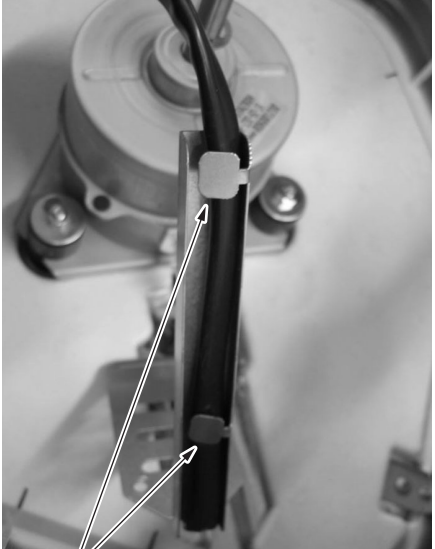
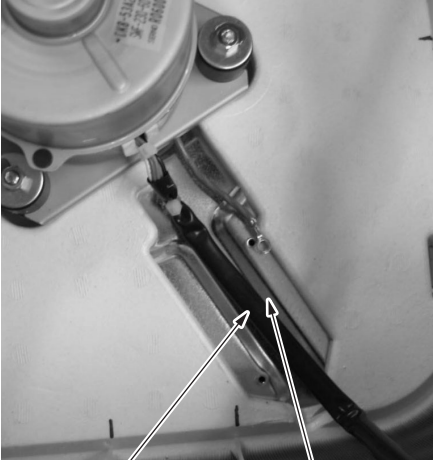
No.	Part name	Procedure	Remarks
⑦	Bell mouth	<p><b>1. Detachment</b></p> <ol style="list-style-type: none"> <li>1) Perform work of procedure ① -1.</li> <li>2) Take off the lead wires of the drain pump, float switch, and fan motor from the bell mouth.</li> <li>3) Take off fixing screws of the bell mouth. (Ø4 × 10, 4 pcs.)</li> </ol> <p><b>2. Attachment</b></p> <ol style="list-style-type: none"> <li>1) Mount the bell mouth with screws. (Ø4 × 10, 4 pcs.)</li> <li>2) Perform wiring as original before being removed.</li> </ol> <p><b>NOTE)</b> Pinch lead wire of the drain pump and float switch with lead wire fixing claws of the bell mouth and perform wiring along the guide.</p>	
⑧	Turbo fan	<p><b>1. Detachment</b></p> <ol style="list-style-type: none"> <li>1) Perform work of procedure ⑦ -1.</li> <li>2) Take off the nut (M6 nut 1 pc.) of the turbo fan.</li> </ol> <p><b>NOTE)</b> Use a box wrench for attachment and detachment of the turbo fan. If using a monkey wrench etc, the other parts may be damaged in work.</p> <p><b>2. Attachment</b></p> <ol style="list-style-type: none"> <li>1) Insert the turbo fan into the fan motor so that boss of the turbo fan matches with cut surface of the fan motor, and then tighten it with nut.</li> </ol> <p><b>NOTE)</b> Tightening torque of turbo fan: <math>5.9 \pm 0.6\text{N.m}</math> Apply looseness-preventing agent to the nut after tightening.</p>	

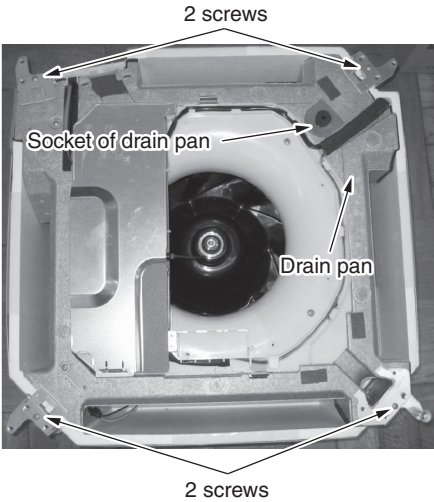
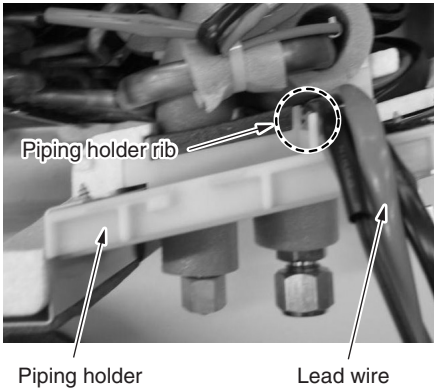
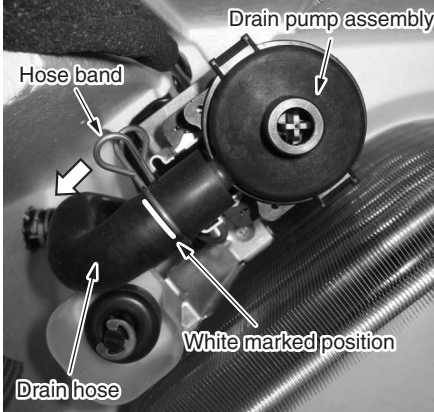
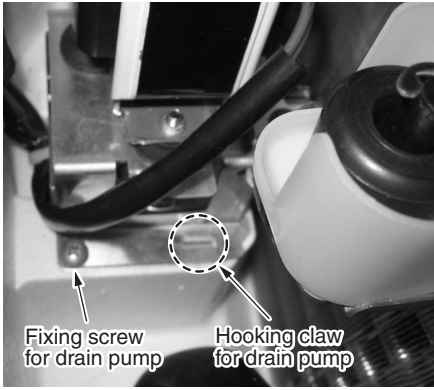
No.	Part name	Procedure	Remarks
⑨	Fan motor	<p><b>1. Detachment</b></p> <ol style="list-style-type: none"> <li>1) Perform work of procedure ⑧.</li> <li>2) Take off screws fixed with lead holding bracket of the fan motor. (<math>\varnothing 4 \times 10</math>, 2 pcs.)</li> <li>3) Open wiring holding part of the fan motor lead holding bracket and then take off the fan motor lead wire from the bracket.</li> <li>4) Take off fixing nuts for the fan motor to remove the fan motor. (M 3 pcs.)</li> </ol> <p><b>NOTE)</b> Use a box wrench for attachment and detachment of the fan motor fixing nuts; otherwise contact or damage for other parts may be caused.</p> <p><b>2. Attachment</b></p> <ol style="list-style-type: none"> <li>1) Mount the fan motor with the fixing nuts.</li> </ol> <p><b>NOTE)</b> Tightening torque of turbo fan: <math>5.9 \pm 0.6\text{N.m}</math> Apply looseness-preventing agent (as paints) to the nut after tightening.</p> <ol style="list-style-type: none"> <li>2) Attach the fan motor lead wire holder.</li> </ol> <p><b>NOTE)</b></p> <ul style="list-style-type: none"> <li>• For the fan motor lead wire, fix the lead wire holding bracket along concave part of the ceiling panel. (There is no catch-in of lead wire and ceiling panel.)</li> <li>• When fixing the lead wire bracket, tighten fan motor earth together with the lead wire.</li> <li>• For this work, do not use an electric screwdriver.</li> <li>• Take note the damage of earth terminal.</li> </ul> <ol style="list-style-type: none"> <li>3) Bend the lead wire holding part and fix the fan motor lead wire.</li> </ol> <p><b>NOTE)</b> Be sure that the lead wire does not come to contact with the heat exchanger.</p>	<p>Fixing nut for fan motor</p>  <p>Fan motor</p> <p>Fan motor earth wire</p> <p>Fixing screw</p> <p>Holding metal fitting for fan motor lead wire</p>  <p>Wiring holding bracket</p>  <p>Fan motor lead wire</p> <p>Concave part of ceiling panel</p>

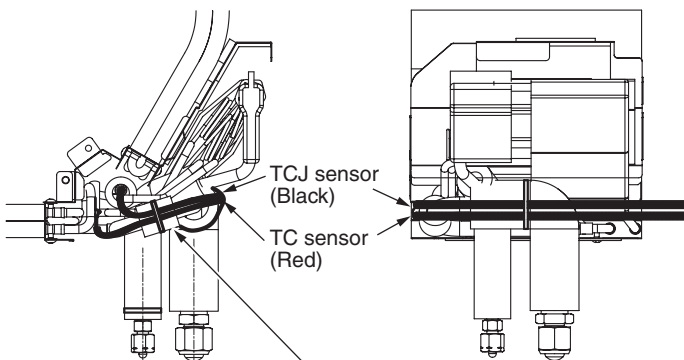
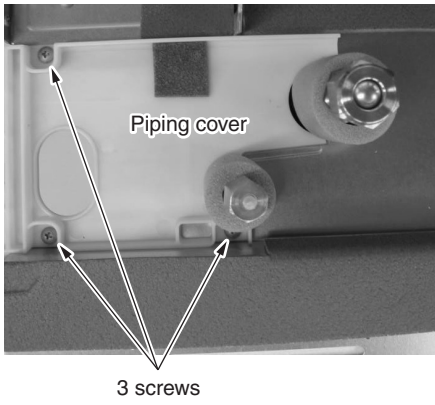
No.	Part name	Procedure	Remarks
⑩	Drain pan	<p><b>1. Detachment</b></p> <ol style="list-style-type: none"> <li>1) Perform works of procedure ④ -1 and ⑦ -1.</li> <li>2) Remove the drain cap and extract drain water accumulated in the drain pan.</li> </ol> <p><b>NOTE)</b> When removing the drain cap, be sure to receive drain water with a bucket, etc.</p> <ol style="list-style-type: none"> <li>3) Take off screws fixing the drain pan to remove the drain pan. (Ø4×10, 4 pcs.)</li> </ol> <p><b>2. Attachment</b></p> <ol style="list-style-type: none"> <li>1) Insert the drain cap into the drain pan.</li> </ol> <p><b>NOTE)</b> Put a stick or others into hole at center of the drain cap, and then insert the drain cap until it strikes on the socket of the drain pan.</p> <ol style="list-style-type: none"> <li>2) Draw each lead wire to the correct positions, and then insert the drain pan into the main unit.</li> </ol> <p><b>NOTE)</b> Draw lead wires of the drain pump and the float switch along the guide of the cabinet. Insert the drain pan along the guides of sensors (TC1, TC2, TCJ) and PMV lead wire.</p> <p>The drain pan and each lead wire are not caught in; otherwise water leakage may be caused.</p> <ol style="list-style-type: none"> <li>3) Fix the drain pan with screws. (Ø4 × 10, 4 pcs.)</li> </ol>	 
⑪	Drain pump assembly	<p><b>1. Detachment</b></p> <ol style="list-style-type: none"> <li>1) Perform work of procedure ⑩ -1.</li> <li>2) Pick up the hose band and slide it from the pump connecting part to remove the drain hose.</li> <li>3) Take off screws (Ø4 × 10, 3 pcs.) fixing the drain pump assembly, and then move hooking claw (1 position) of the main body from the drain pump assembly to remove the drain pump assembly.</li> </ol> <p><b>2. Attachment</b></p> <ol style="list-style-type: none"> <li>1) Fix the drain pump assembly as original.</li> </ol> <p><b>NOTE)</b> For fixing, use a hooking claw (1 position) and screws (3 positions). When screwing, be sure not to run on the hooking claw at main body side.</p> <ol style="list-style-type: none"> <li>2) Mount the drain hose and the hose band as original.</li> </ol> <p><b>NOTE)</b> Insert the drain hose up to the end of pump connecting part, and then put the band at white marked position of the hose.</p>	 

No.	Part name	Procedure	Remarks
⑫	Heat exchanger	<p><b>1. Detachment</b></p> <ol style="list-style-type: none"> <li>1) Recover refrigerant gas.</li> <li>2) Remove the refrigerant pipe at indoor unit side.</li> <li>3) Perform work of procedure ⑩ -1.</li> <li>4) Take off screws (Ø4 × 10, 3 pcs.) fixing the piping cover to remove the piping cover.</li> <li>5) While holding the heat exchanger, remove fixing band and fixing screws (Ø4 × 10, 3 pcs.) and then remove the heat exchanger.</li> </ol> <p><b>2. Attachment</b></p> <ol style="list-style-type: none"> <li>1) Mount parts in order, heat exchanger → fixing band → piping cover → drain pan → bell mouth → electric parts box as original.</li> </ol> <p><b>NOTE)</b> Arrange wires as original.</p> <ol style="list-style-type: none"> <li>2) Attach the removed connectors and wires as original.</li> <li>3) Connect the refrigerant pipe as original, and then perform vacuuming.</li> </ol> <p style="text-align: center;"><b>&lt;Details of sensor lead wire drawing&gt;</b></p>  <p style="text-align: center;">Wind pipe cover over the header, attach a sensor on it. (Do not set the head of tie wrap upward.)</p>	 <p style="text-align: center;">Piping cover</p> <p style="text-align: center;">3 screws</p>  <p style="text-align: center;">Fixing band      Fixing band for heat exchanger</p>  <p style="text-align: center;">2 fixing screws for heat exchanger</p>



## 10-2. Concealed Duct Type

### RAV-SM\*\*\*BT \*

Be sure to turn off the power supply or circuit breaker before disassembling work

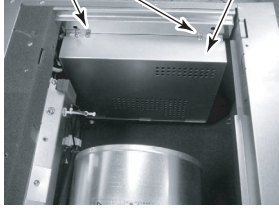
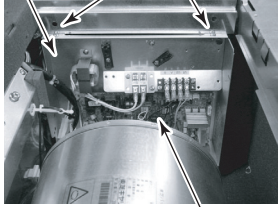
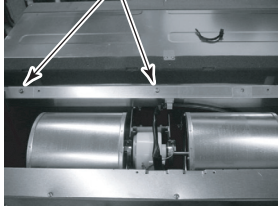
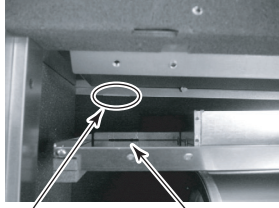
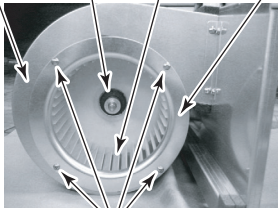
No.	Part name	Procedure	Remarks
①	Electrical parts box	<ol style="list-style-type: none"> <li>1. Remove the air filter.</li> <li>2. Remove the set screws (2 positions) of the electrical parts cover.</li> <li>3. Remove the electrical parts cover.</li> <li>4. Remove the set screws (2 positions) of the electrical parts box.</li> <li>5. Remove the electrical parts box. The electrical parts box is fixed to the main unit with claws at the right side. Lift up it once and pull toward you. Then claws come off.</li> </ol> <p>In this time, remove connectors of TA sensor, TC sensor and TCJ sensor if necessary.</p>	<p>Screws (Fixing electrical parts cover and box)</p> <p>Electrical parts cover</p>  <p>①-2 ①-3</p> <p>Screws (Fixing electrical parts box and main unit)</p> <p>Electrical parts box</p>  <p>①-4 ①-5</p> <p>Claw (Reverse side)</p>
②	Multi blade fan	<ol style="list-style-type: none"> <li>1. Remove the air filter.</li> <li>2. Remove the connector of the fan motor P.C. board.</li> <li>3. Remove the hexagon head screw (562: 2, 802, 1102, 1402 : 3 positions) of fixing fan assembly and main unit.</li> <li>4. Remove the fan assembly from main unit. The fan assembly is fixed to the main unit with claws (3 positions) at the upper side. Lift up it once and pull toward rear side. Then claws come off.</li> <li>5. Remove the set screws (4 positions) of fixing fan case and fan cover.</li> <li>6. Remove the fan cover.</li> <li>7. Loosen the sets crew of the Multi blade fan using hexagon wrench.</li> <li>8. Pull the Multi blade fan towered fan case side. Then fans come off.</li> </ol>	<p>Hexagon head screws (Fixing fan assembly and main unit)</p>  <p>②-3</p>  <p>②-4</p> <p>Fixing claw (Main unit)</p> <p>Fixing hole (Fan assembly)</p> <p>Fan case</p> <p>Multi blade fan</p> <p>Set screw</p> <p>Fan case cover</p>  <p>②-5 ②-6</p> <p>Screws (Fixing fan case cover)</p>

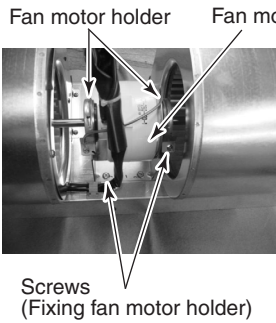
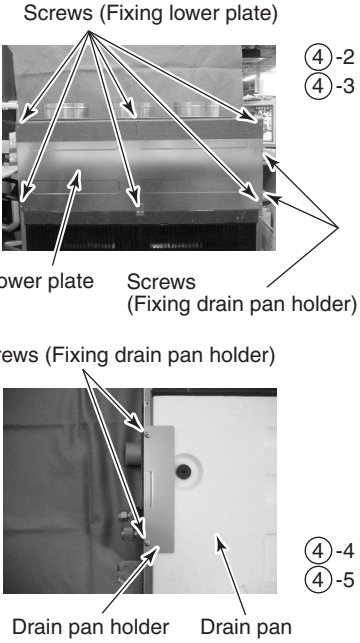
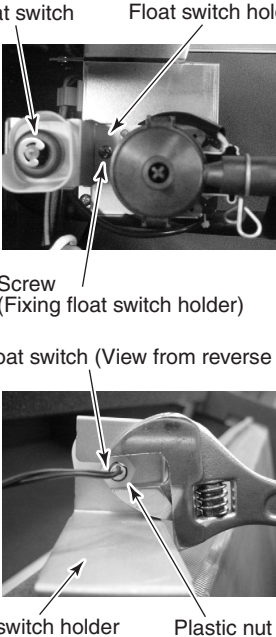
No.	Part name	Procedure	Remarks
③	Fan motor	<ol style="list-style-type: none"> <li>1. Remove the Multi blade fan.</li> <li>2. Remove the hexagon head screw of fixing fan motor holder.</li> <li>3. Remove the fan motor holder (2 positions).</li> </ol>	 <p>Fan motor holder    Fan motor</p> <p>Screws (Fixing fan motor holder)</p> <p>③-2 ③-3</p>
④	Drain pan	<ol style="list-style-type: none"> <li>1. Take down the main unit and then treat the drain pan on the floor.</li> <li>2. Remove the set screws (562 : 7, 802, 1102, 1402 : 9 positions) of fixing lower plate.</li> <li>3. Remove the lower plate from main unit.</li> <li>4. Remove the set screws (562 : Nothing, 802 : 2 positions, 1102, 1402 : 4 positions) of fixing drain pan holder and main unit.</li> <li>5. Remove the drain pan holder (562 : Nothing, 802 : 1 position, 1102, 1402 : 2 positions) from main unit.</li> <li>6. Remove the drain pan. Pull it lower side.</li> </ol>	 <p>Screws (Fixing lower plate)</p> <p>Lower plate    Screws (Fixing drain pan holder)</p> <p>Screws (Fixing drain pan holder)</p> <p>Drain pan holder    Drain pan</p> <p>④-2 ④-3 ④-4 ④-5</p>
⑤	Float switch	<ol style="list-style-type: none"> <li>1. Remove the drain pan.</li> <li>2. Remove the set screw (1 position) of fixing float switch holder.</li> <li>3. Remove the plastics nut of foxing float switch.</li> <li>4. Remove the float switch.</li> </ol>	 <p>Float switch    Float switch holder</p> <p>Screw (Fixing float switch holder)</p> <p>Float switch (View from reverse side)</p> <p>Float switch holder    Plastic nut</p> <p>⑤-2 ⑤-3</p>

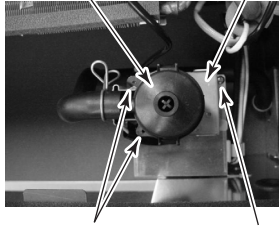
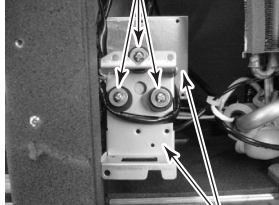
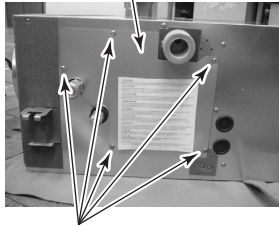
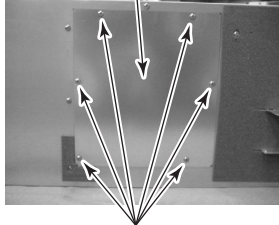
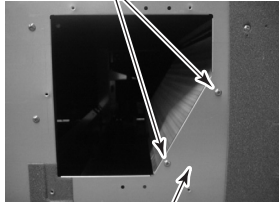
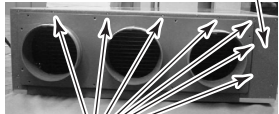
No.	Part name	Procedure	Remarks
⑥	Drain pump	<ol style="list-style-type: none"> <li>1. Remove the drain pan and float switch.</li> <li>2. Remove the set screws (3 positions) of fixing drain pump plate and main unit.</li> <li>3. Remove the set screws (3 positions) of fixing drain pump plate and drain pump.</li> </ol>	<p>Drain pump      Drain pump holder</p>  <p>⑥ -2</p> <p>Screws (Fixing drain pump holder)</p> <p>Screws (Fixing plate and drain pump)</p>  <p>⑥ -3</p> <p>Drain pump holder</p> <p>⑥ -3. View from reverse side of drain pump</p>
⑦	TC, TCJ sensor	<ol style="list-style-type: none"> <li>1. Remove the set screws (5 positions) and check port cover (right side).</li> <li>2. Pull out the sensor is inserted into pipe of the heat exchanger.</li> </ol>	<p>Checking port cover (Right side)</p>  <p>⑦ -1</p> <p>Screws (Fixing check port cover (Right side))</p>
⑧	Heat exchanger	<ol style="list-style-type: none"> <li>1. Take down the main unit and then treat the heat exchanger on the floor.</li> <li>2. Remove the drain pan.</li> <li>3. Remove the check port cover (right side).</li> <li>4. Remove the set screws (6 positions) and check port cover (left side).</li> <li>5. Remove the set screws (2 positions) of fixing heat exchanger and main unit (left side).</li> <li>6. Remove the set screws (7 positions) of fixing heat exchanger and main unit (front right side).</li> </ol>	<p>Check port cover (Left side)</p>  <p>⑧ -4</p> <p>Screws (Fixing check port cover (Left side))</p> <p>Screws (Fixing heat exchanger)</p>  <p>⑧ -5</p> <p>Main unit (Left side)</p> <p>Main unit (Front side)</p>  <p>⑧ -6</p> <p>Screws</p>



### 10-3. Ceiling Type

#### RAV-SM\*\*\*CT \*

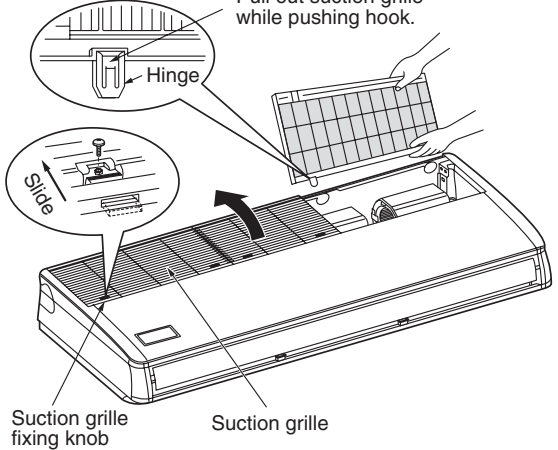
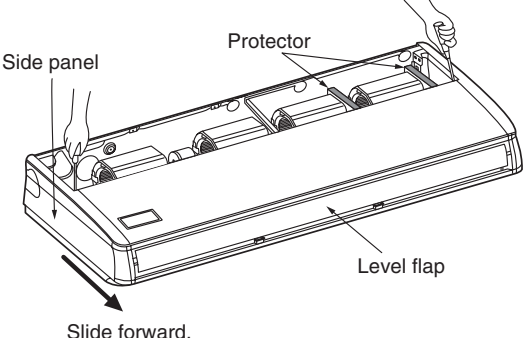
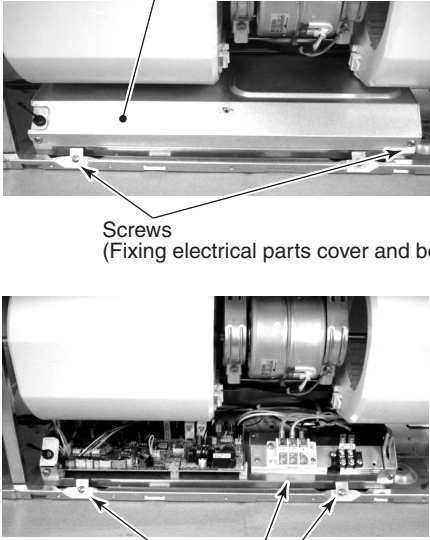
Be sure to turn off the power supply or circuit breaker before disassembling work

No.	Part name	Procedure	Remarks
①	Suction grille	<ol style="list-style-type: none"> <li>1. Remove the screws of air intake grille fixing knob on a side of each filter.</li> <li>2. Slide the suction grille fixing knobs (2 positions) toward the arrow direction of left figure, and open the suction grille.</li> <li>3. Under the condition of the suction grille opened, push the hook section of hinges (2 positions) at the rear side, and then pull out the suction grille.</li> </ol>	 <p>Pull out suction grille while pushing hook.</p> <p>Hinge</p> <p>Slide</p> <p>Suction grille fixing knob</p> <p>Suction grille</p>
②	Side panel	<ol style="list-style-type: none"> <li>1. Open the suction grille.</li> <li>2. After removing the side panel screws (2 positions), slide the side panel forward and then remove it.</li> </ol>	 <p>Side panel</p> <p>Protector</p> <p>Level flap</p> <p>Slide forward.</p>
③	Electrical parts box	<ol style="list-style-type: none"> <li>1. Remove the suction grille.</li> <li>2. Loosen the set screws (2 positions) of the electrical parts cover.</li> <li>3. Remove the electrical parts cover.</li> <li>4. Remove the set screws (2 positions) of the electrical parts box.</li> <li>5. Remove the electrical parts box.</li> </ol> <p>In this time, remove connectors of TA sensor, TC sensor and TCJ sensor if necessary.</p>	 <p>Electrical parts cover</p> <p>Screws (Fixing electrical parts cover and box)</p> <p>③-2</p> <p>③-3</p> <p>Electrical parts box</p> <p>Screws (Fixing electrical parts box and main unit)</p> <p>③-4</p> <p>③-5</p>

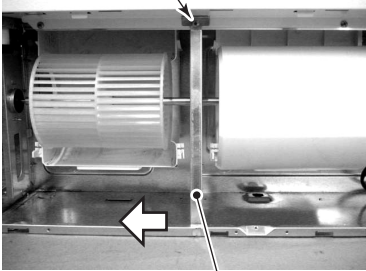
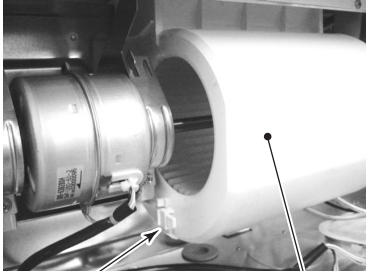

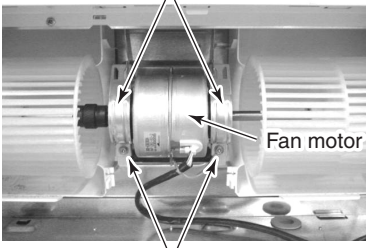
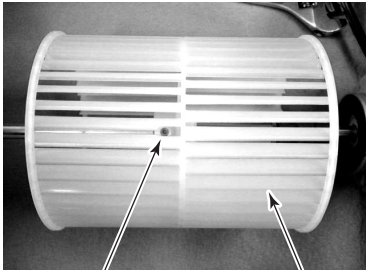
No.	Part name	Procedure	Remarks
④	Multi blade fan motor	<ol style="list-style-type: none"> <li>1. Remove the suction grille.</li> <li>2. Remove the connector of the fan motor from P.C. board.</li> <li>3. (SM802, SM1102, SM1402CT-E only) Remove the set screw (1 position) to fixing and reinforcing bar. (Slide the reinforcing bar toward arrow side on the left figure.)</li> <li>4. Push the fan cover fixing hooks (2 positions) forward fan cover side and remove the fan cover.</li> <li>5. (SM1102, SM1402CT-E only) Remove the hexagon head screws (2 positions) to fix bearing and the bearing.</li> <li>6. Remove the hexagon head screw of fixing fan motor and fan motor holder then the assembly removed from the main unit.</li> <li>7. Loosen the sets crew of the multi blade fan using hexagon wrench.</li> <li>8. Pull the multi blade fan toward fan case side. Then fans come off.</li> </ol>	<p data-bbox="981 235 1332 280">Screws (Fixing reinforcing bar and main unit)</p>  <p data-bbox="1364 537 1412 571">④-3</p> <p data-bbox="1133 582 1276 616">Reinforcing bar</p>  <p data-bbox="1364 884 1412 918">④-4</p> <p data-bbox="933 929 1396 963">Fan cover fixing hook    Fan cover (Lower side)</p>  <p data-bbox="1364 1232 1412 1265">④-5</p> <p data-bbox="981 1276 1268 1332">Hexagon head screws (Fixing bearing and main unit)</p> <p data-bbox="981 1355 1157 1388">Fan motor holder</p>  <p data-bbox="1364 1601 1412 1635">④-6</p> <p data-bbox="1045 1646 1348 1702">Hexagon screws (Fixing fan motor and main unit)</p>  <p data-bbox="1364 1971 1412 2004">④-7</p> <p data-bbox="933 2016 1396 2049">Set screw of multi blade fan    Multi blade fan</p>

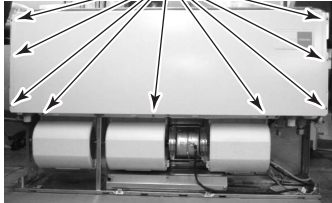
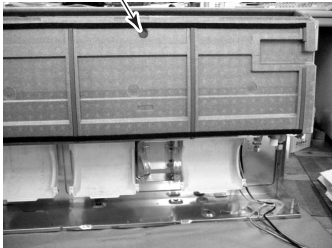
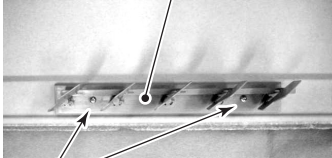
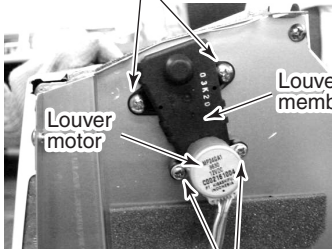
No.	Part name	Procedure	Remarks
⑤	Drain pan	<ol style="list-style-type: none"> <li>1. Take down the main unit and then treat the drain pan on the floor.</li> <li>2. Remove the both side panels and suction grilles.</li> <li>3. (SM802, SM1102, SM1402CT-E only) Remove the set screw (1 position) to fixing and reinforcing bar. (Slide the reinforcing bar toward arrow side on the right figure.)</li> <li>4. Remove the set screws (9 positions) of fixing lower plate.</li> <li>5. Remove the heat insulation on the drain pan. (SM562, SM802 : 1 position, SM1102, SM1402 : 2 positions)</li> <li>6. Remove the set screws (SM562, SM802 : 1 position, SM1102, SM1402 : 2 positions) of fixing drain pan and main unit.</li> <li>7. Remove the drain pan. Pull it lower side.</li> </ol>	<p>Screws (Fixing lower plate and main unit)</p>  <p>⑤-4</p> <p>Heat insulation The screw that fixed drain pan and main unit is under this insulation.</p>  <p>⑤-5 ⑤-6</p>
⑥	Vertical grille	<ol style="list-style-type: none"> <li>1. Remove the drain pan.</li> <li>2. Remove the set screws (2 positions) of fixing vertical grille.</li> <li>3. Remove the vertical grille.</li> </ol>	<p>Vertical grille</p>  <p>Screws (Fixing drain pan and vertical grille) ⑥-2</p>
⑦	Louver motor, Louver drive member	<ol style="list-style-type: none"> <li>1. Remove the side cover (right side only).</li> <li>2. Remove the set screws (2 positions) and louver motor.</li> <li>3. Remove the set screws (2 positions) and louver drive member.</li> </ol>	<p>Screws (Fixing louver drive member and main unit)</p>  <p>Louver motor Louver drive member</p> <p>⑦-3</p> <p>Screws (Fixing louver motor and louver drive member)</p>

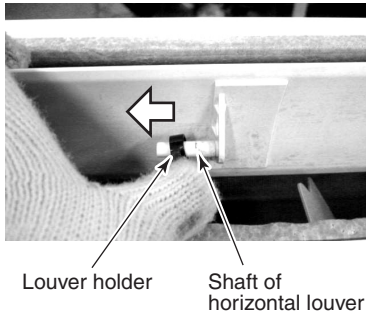
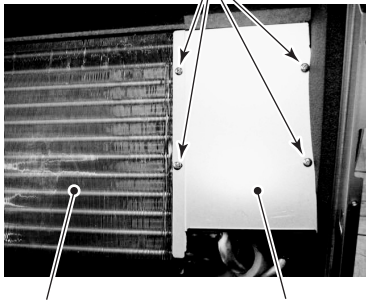
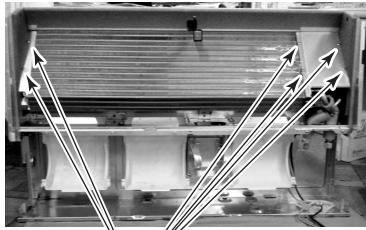
No.	Part name	Procedure	Remarks
⑧	Horizontal louver	<ol style="list-style-type: none"> <li>1. Push the louver holder toward arrow direction of right figure, and pull out the center shaft (SM562, SM802 : 1 position, SM1102, SM1402 : 2 positions) from louver holder.</li> <li>2. Pull off the left and right shaft of horizontal louver.</li> </ol>	 <p style="text-align: right;">⑧-1</p> <p style="text-align: center;">Louver holder      Shaft of horizontal louver</p>
⑨	TC, TCJ sensor	<ol style="list-style-type: none"> <li>1. Remove the drain pan.</li> <li>2. Remove the set screws (4 positions) and heat exchanger support.</li> <li>3. Pull out the sensor is inserted into pipe of the heat exchanger.</li> </ol>	 <p style="text-align: right;">⑨-3</p> <p style="text-align: center;">Screws (Fixing heat exchanger support)</p> <p style="text-align: center;">Heat exchanger      Heat exchanger support</p>
⑩	Heat exchanger	<ol style="list-style-type: none"> <li>1. Take down the main unit and then treat the heat exchanger on the floor.</li> <li>2. Remove the drain pan.</li> <li>3. Remove the set screws (6 positions) of fixing heat exchanger and main unit.</li> </ol>	 <p style="text-align: right;">⑩-3</p> <p style="text-align: center;">Screws (Fixing heat exchanger and main unit)</p>

# 11. EXPLODED VIEWS AND PARTS LIST

## 11-1. Compact 4-way Cassette Type

RAV-SM404MUT \*, RAV-SM454MUT \*, RAV-SM564MUT \*

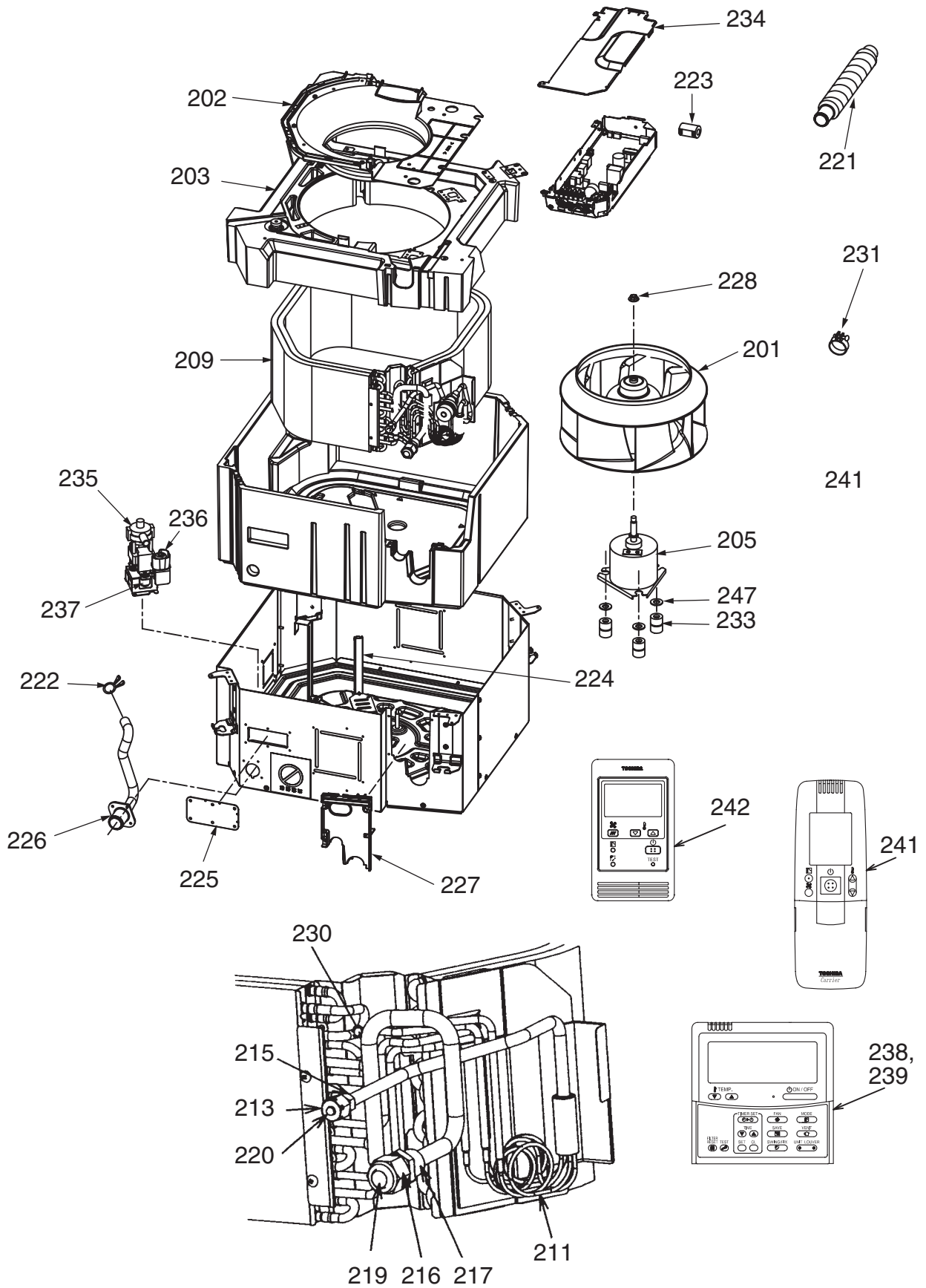

Location No.	Part No.	Description	Model name RAV-SM		
			404MUT-E	454MUT-E	564MUT-E
201	43120225	FAN, ASSY TURBO	1	1	1
202	43122094	BELLMOUTH	1	1	1
203	43172185	PAN ASSY, DRAIN	1	1	1
205	43121738	MOTOR, FAN	1	1	1
209	4314J329	REFRIGERATION CYCLE ASSY	1	1	1
211	4314Q034	DISTRIBUTOR ASSY	1	1	1
213	43047685	NUT, FLARE, 1/4 IN	1	1	1
215	43149351	SOCKET	1	1	1
216	43047688	NUT, FLARE, 1/2, IN	1	1	1
217	43149353	SOCKET	1	1	1
219	43147195	BONNET, 1/2 IN	1	1	1
220	43049697	BONNET	1	1	1
221	43170244	HOSE, DRAIN	1	1	1
222	43079249	BAND, HOSE	1	1	1
223	43060029	FILTER,NOISE	1	1	1
224	43163052	HOLDER, LEAD, FAN MOTOR	1	1	1
225	43119482	COVER, ASSY BODY	1	1	1
226	43170248	HOSE, DRAIN	1	1	1
227	43119483	COVER, PIPE	1	1	1
228	43097212	NUT	1	1	1
230	43019904	HOLDER, SENSOR (TS)	2	2	2
231	43179135	BAND, HOSE	1	1	1
233	43139137	RUBBER, CUSHION	3	3	3
234	43162056	COVER, E-BOX	1	1	1
235	43177001	PUMP, DRAIN	1	1	1
236	43151289	SWITCH, FLOAT	1	1	1
237	43179126	RUBBER, PUMP DRAIN	3	3	3
238	43166011	REMOTE CONTROLLER, SX-A4EE	1	1	1
239	43166012	REMOTE CONTROLLER, SX-A5EE	1	1	1
240	43166004	REMOTE CONTROLLER, SX-A11JE2	1	1	1
241	43166006	REMOTE CONTROLLER, WH-H1JE2	1	1	1
242	431S8221	OWNER'S MANUAL	1	1	1
247	43197155	WASHER	3	3	3

Location No.	Part No.	Description	Model name RAV-SM		
			404MUT-TR	454MUT-TR	564MUT-TR
201	43120225	FAN, ASSY TURBO	1	1	1
202	43122094	BELLMOUTH	1	1	1
203	43172185	PAN ASSY, DRAIN	1	1	1
205	43121738	MOTOR, FAN	1	1	1
209	4314J329	REFRIGERATION CYCLE ASSY	1	1	1
211	4314Q034	DISTRIBUTOR ASSY	1	1	1
213	43047685	NUT, FLARE, 1/4 IN	1	1	1
215	43149351	SOCKET	1	1	1
216	43047688	NUT, FLARE, 1/2, IN	1	1	1
217	43149353	SOCKET	1	1	1
219	43147195	BONNET, 1/2 IN	1	1	1
220	43049697	BONNET	1	1	1
221	43170244	HOSE, DRAIN	1	1	1
222	43079249	BAND, HOSE	1	1	1
223	43060029	FILTER,NOISE	1	1	1
224	43163052	HOLDER, LEAD, FAN MOTOR	1	1	1
225	43119482	COVER, ASSY BODY	1	1	1
226	43170248	HOSE, DRAIN	1	1	1
227	43119483	COVER, PIPE	1	1	1
228	43097212	NUT	1	1	1
230	43019904	HOLDER, SENSOR (TS)	2	2	2
231	43179135	BAND, HOSE	1	1	1
233	43139137	RUBBER, CUSHION	3	3	3
234	43162056	COVER, E-BOX	1	1	1
235	43177001	PUMP, DRAIN	1	1	1
236	43151289	SWITCH, FLOAT	1	1	1
237	43179126	RUBBER, PUMP DRAIN	3	3	3
238	43166011	REMOTE CONTROLLER, SX-A4EE	1	1	1
239	43166012	REMOTE CONTROLLER, SX-A5EE	1	1	1
240	43166004	REMOTE CONTROLLER, SX-A11JE2	1	1	1
241	43166006	REMOTE CONTROLLER, WH-H1JE2	1	1	1
242	431S8222	OWNER'S MANUAL	1	1	1
247	43197155	WASHER	3	3	3

# Electric parts

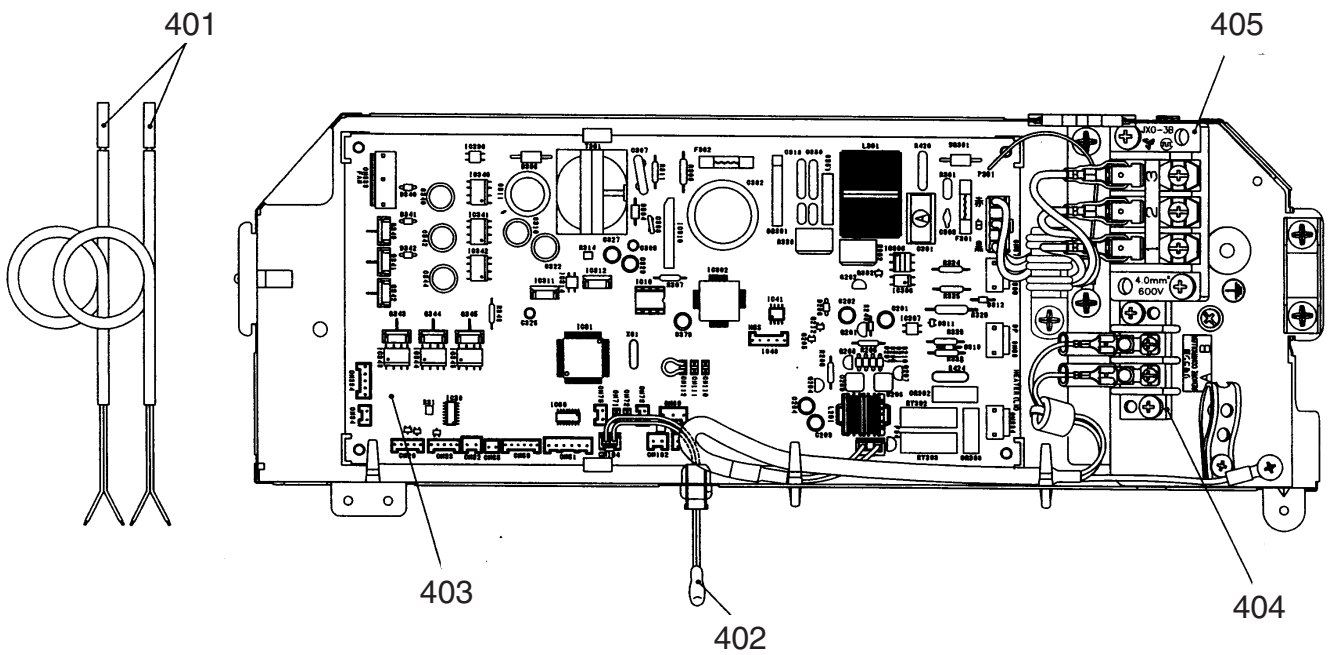

Location No.	Part No.	Description	Model name RAV-SM		
			404MUT-E (TR)	454MUT-E (TR)	564MUT-E (TR)
401	43050425	SENSOR ASSY, SERVICE, TC	2	2	2
402	43050426	SENSOR, SERVICE, TA	1	1	1
403	4316V461	PC BOARD ASSY, MCC-1402	1	1	1
404	43160568	TERMINAL, 2P	1	1	1
405	43160565	TERMINAL BLOCK, 3P, 20A	1	1	1

## 11-2. Concealed Duct Type

RAV-SM564BT-E, RAV-SM564BT-TR

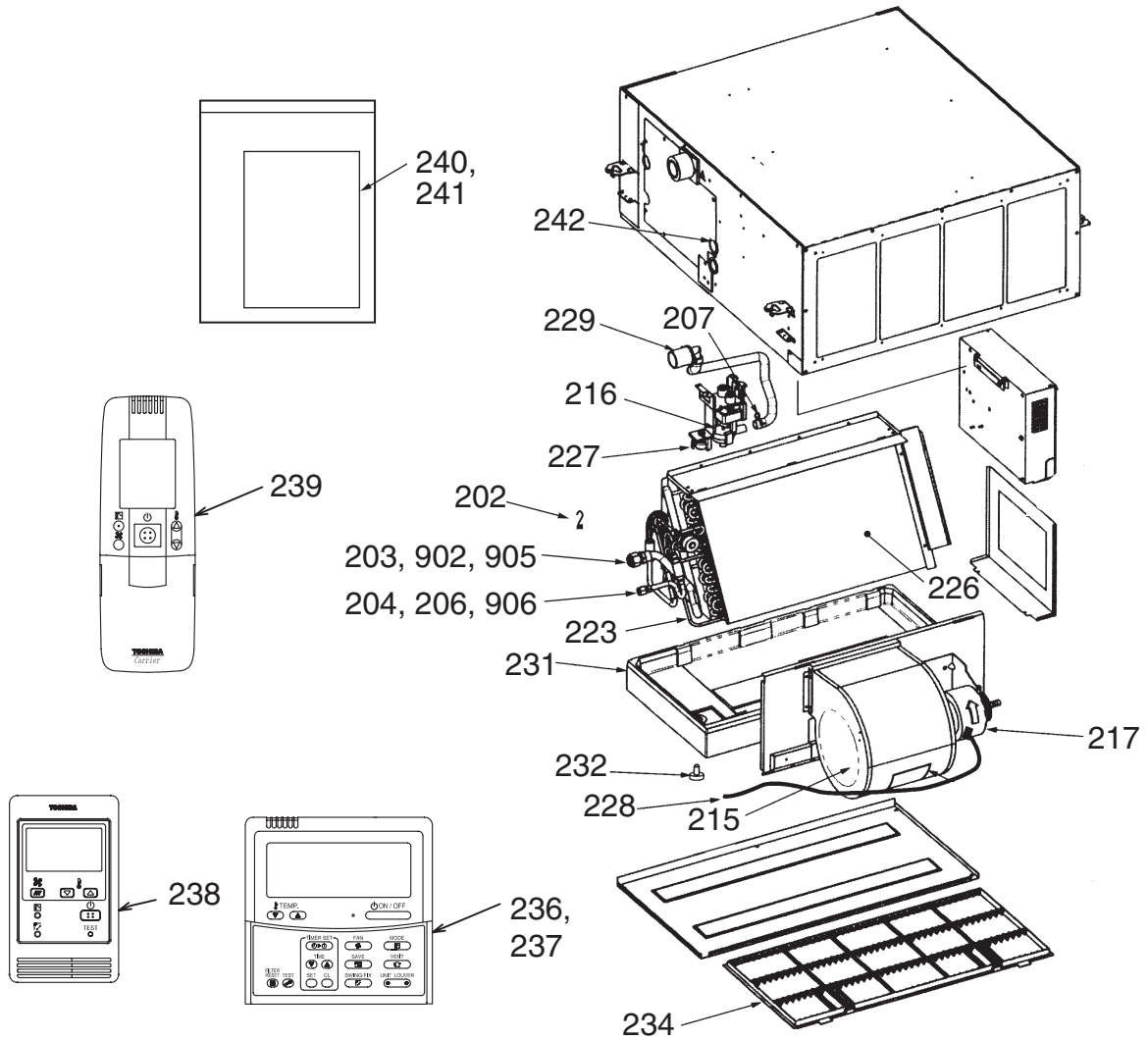



Location No.	Part No.	Description	Model name	
			RAV-SM564BT-E	RAV-SM564BT-TR
202	43019904	HOLDER, SENSOR (TS)	2	2
203	43047692	BONNET	1	1
204	43047685	NUT, FLARE, 1/4 IN	1	1
206	43049697	BONNET	1	1
207	43079249	BAND, HOSE	1	1
215	43120239	FAN, MULTI BLADE	1	1
216	43121747	PUMP ASSY, WIRING	1	1
217	4312C021	MOTOR, FAN	1	1
223	4314Q015	DISTRIBUTOR ASSY	1	1
226	4314J268	REFRIGERATION CYCLE ASSY	1	1
227	43151294	SWITCH, FLOAT	1	1
228	43160553	LEAD, MOTOR, FAN	1	1
229	43170233	HOSE, DRAIN	1	1
231	43172168	PAN ASSY, DRAIN	1	1
232	43179110	PLUG	1	1
234	43180311	AIR FILTER	1	1
236	43166011	REMOTE CONTROLLER, SX-A4EE	1	1
237	43166012	REMOTE CONTROLLER, SX-A5EE	1	1
238	43166004	REMOTE CONTROLLER, SX-A11JE2	1	1
239	43166006	REMOTE CONTROLLER, WH-H1JE2	1	1
240	431S8224	OWNER'S MANUAL		1
241	431S8223	OWNER'S MANUAL	1	
242	43196012	BUSHING	2	2
902	43149351	SOCKET	2	2
905	43047688	NUT, FLARE, 1/2, IN	1	1
906	43149353	SOCKET	1	1

RAV-SM804BT-E, RAV-SM804BT-TR

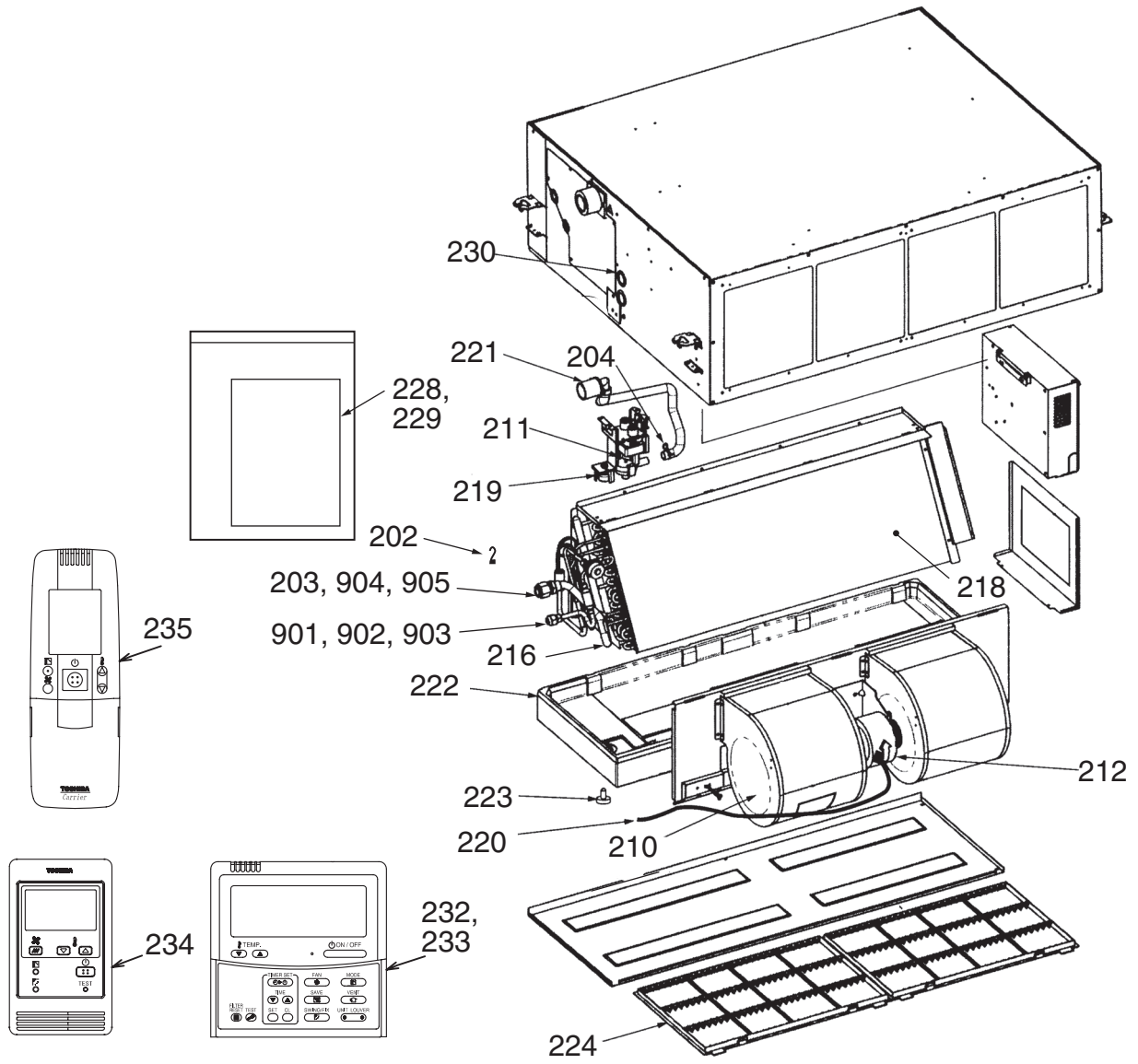

Location No.	Part No.	Description	Model name	
			RAV-SM804BT-E	RAV-SM804BT-TR
202	43019904	HOLDER, SENSOR (TS)	2	2
203	43047609	BONNET	1	1
204	43079249	BAND, HOSE	1	1
210	43120239	FAN, MULTI BLADE	2	2
211	43121747	PUMP ASSY, WIRING	1	1
212	4312C020	MOTOR, FAN	1	1
216	4314Q016	DISTRIBUTOR ASSY	1	1
218	4314J269	REFRIGERATION CYCLE ASSY	1	1
219	43151294	SWITCH, FLOAT	1	1
220	43160553	LEAD, MOTOR, FAN	1	1
221	43170233	HOSE, DRAIN	1	1
222	43172167	PAN ASSY, DRAIN	1	1
223	43179110	PLUG	1	1
224	43180312	AIR FILTER	2	2
228	431S8224	OWNER'S MANUAL		1
229	431S8223	OWNER'S MANUAL	1	
230	43196012	BUSHING	2	2
232	43166011	REMOTE CONTROLLER, SX-A4EE	1	1
233	43166012	REMOTE CONTROLLER, SX-A5EE	1	1
234	43166004	REMOTE CONTROLLER, SX-A11JE2	1	1
235	43166006	REMOTE CONTROLLER, WH-H1JE2	1	1
901	43049776	SOCKET	1	1
902	43194029	BONNET	1	1
903	43149355	NUT, FLARE, 3/8, IN	1	1
904	43149352	NUT, FLARE, 5/8, IN	1	1
905	43149354	SOCKE	1	1

**RAV-SM1104BT-E, RAV-SM1404BT-E,  
RAV-SM1104BT-TR, RAV-SM1404BT-TR**

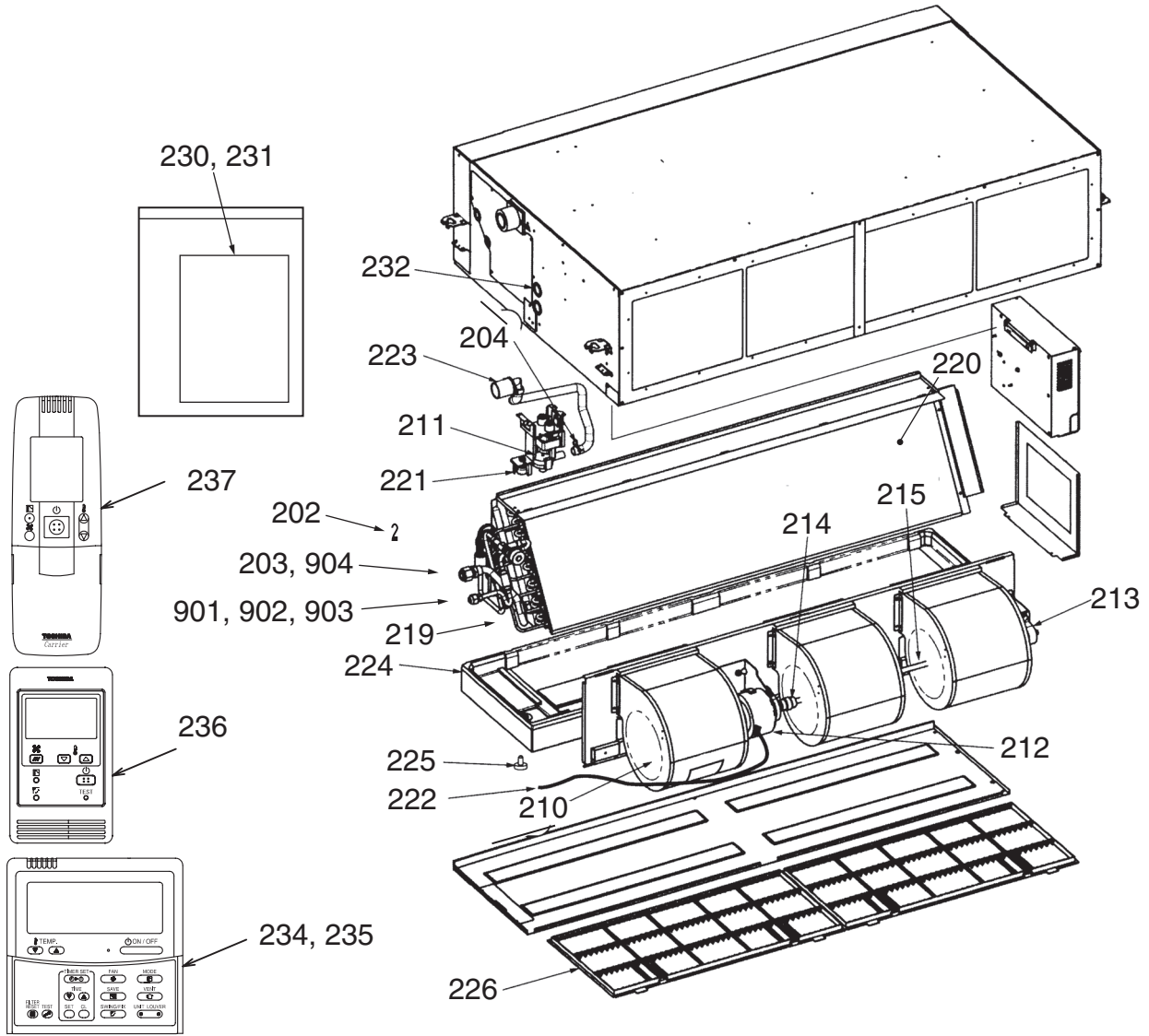

Location No.	Part No.	Description	Model name RAV-SM			
			1104BTE	1404BTE	1104BT-TR	1404BT-TR
202	43019904	HOLDER, SENSOR (TS)	2	2	2	2
203	43047609	BONNET	1	1	1	1
204	43079249	BAND, HOSE	1	1	1	1
210	43120239	FAN, MULTI BLADE	3	3	3	3
211	43121747	PUMP ASSY, WIRING	1	1	1	1
212	4312C021	MOTOR, FAN	1	1	1	1
213	43125131	BEARING, SHAFT	1	1	1	1
214	43125162	COUPLING	1	1	1	1
215	43125163	SHAFT	1	1	1	1
219	4314Q017	DISTRIBUTOR ASSY	1	1	1	1
220	4314J270	REFRIGERATION CYCLE ASSY	1	1	1	1
221	43151294	SWITCH, FLOAT	1	1	1	1
222	43160553	LEAD, MOTOR, FAN	1	1	1	1
223	43170233	HOSE, DRAIN	1	1	1	1
224	43172166	PAN ASSY, DRAIN	1	1	1	1
225	43179110	PLUG	1	1	1	1
226	43180311	AIR FILTER	2	2	2	2
230	431S8224	OWNER'S MANUAL			1	1
231	431S8223	OWNER'S MANUAL	1	1		
232	43196012	BUSHING	2	2	2	2
234	43166011	REMOTE CONTROLLER, SX-A4EE	1	1	1	1
235	43166012	REMOTE CONTROLLER, SX-A5EE	1	1	1	1
236	43166004	REMOTE CONTROLLER, SX-A11JE2	1	1	1	1
237	43166006	REMOTE CONTROLLER, WH-H1JE2	1	1	1	1
901	43049776	SOCKET	1	1	1	1
902	43194029	BONNET	1	1	1	1
903	43149355	NUT, FLARE, 3/8, IN	1	1	1	1
904	43149352	NUT, FLARE, 5/8, IN	1	1	1	1

## Electric parts

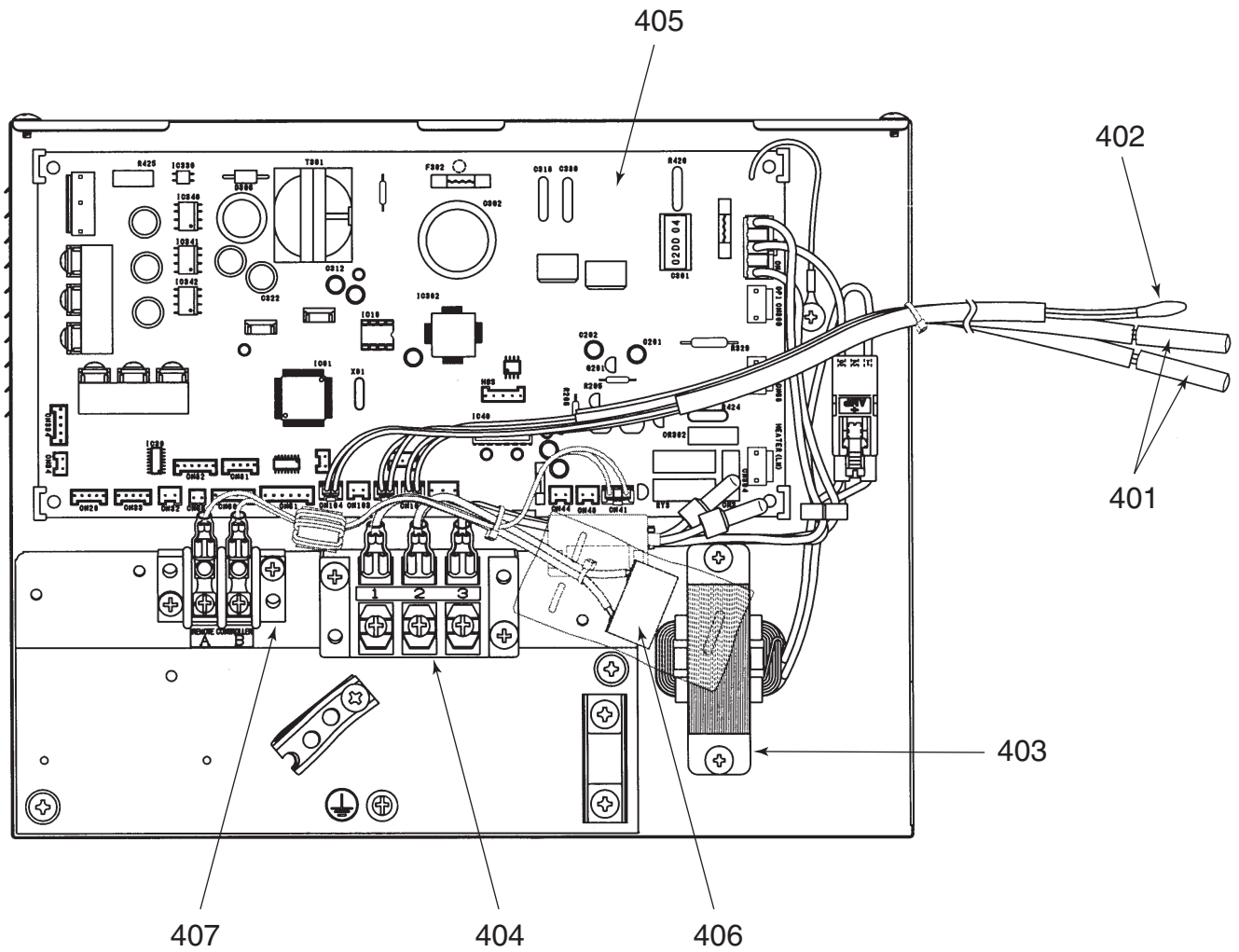

Location No.	Part No.	Description	Model name RAV-SM			
			564BT-E (TR)	804BT-E (TR)	1104BT-E (TR)	1404BT-E (TR)
401	43050425	SENSOR ASSY, SERVICE, TC6	2	2	2	2
402	43050426	SENSOR, SERVICE, TA	1	1	1	1
403	43158193	REACTOR, CH-43-2Z-T	1	1	1	1
404	43160565	TERMINAL BLOCK, 3P, 20A	1	1	1	1
405	4316V462	PC BOARD ASSY, MCC-1402	1	1	1	1
406	43155203	CAPACITOR KIT, SERVICE	1	1	1	1
407	43160568	TERMINAL, 2P	1	1	1	1

### 11-3. Ceiling Type

RAV-SM564CT \*, RAV-SM804CT \*, RAV-SM1104CT \*, RAV-SM1404CT \*

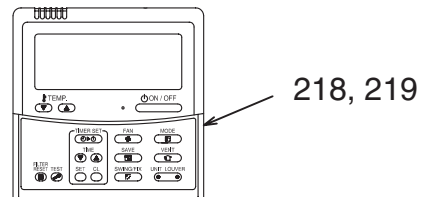
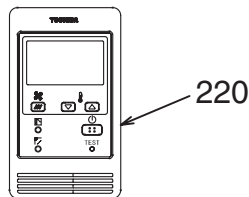
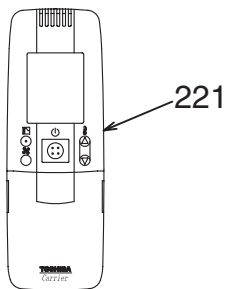
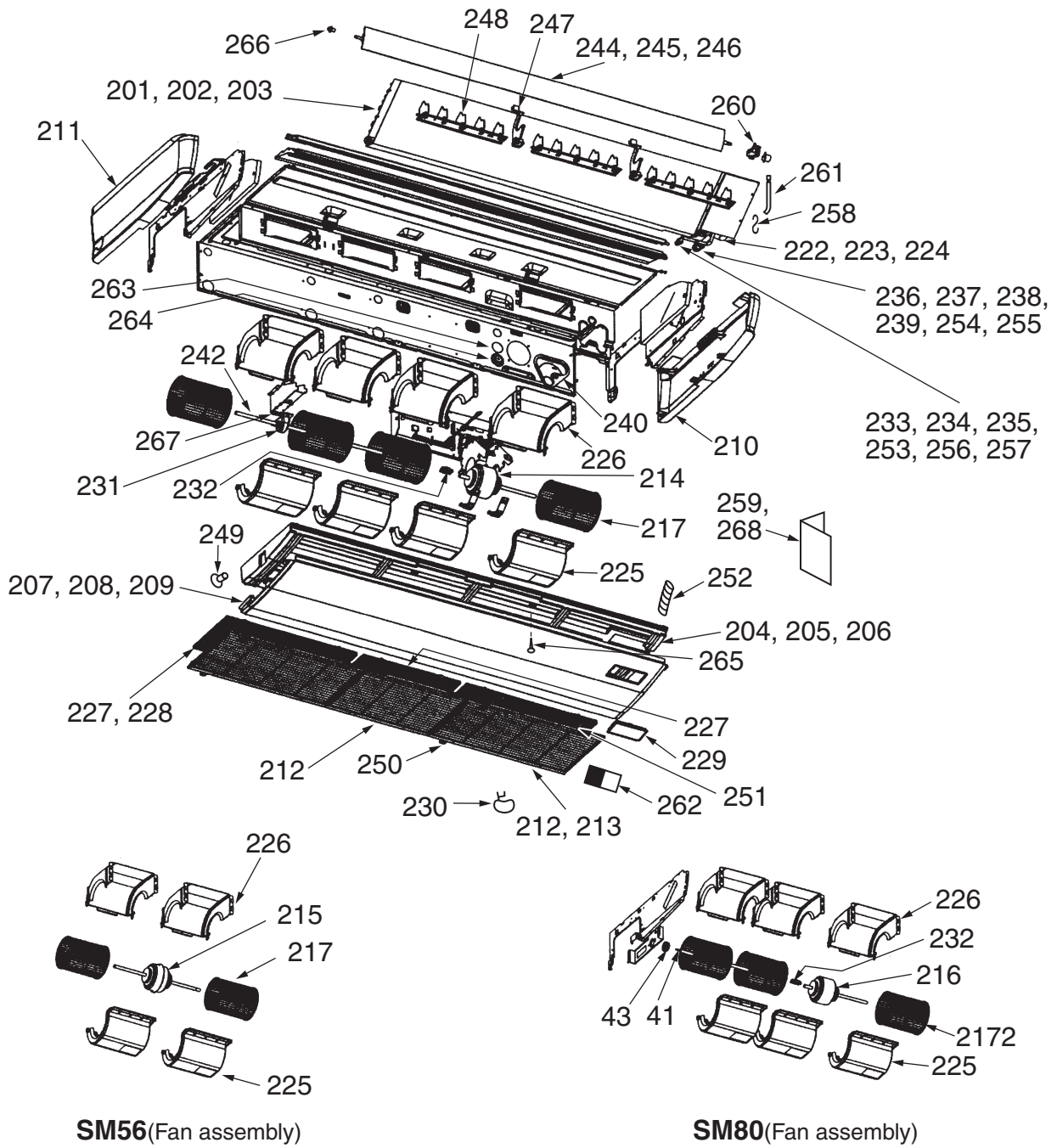

Location No.	Part No.	Description	Model name RAV-SM			
			564CTE	804CTE	1104CTE	1404CTE
201	4314J271	REFRIGERATION CYCLE A'SSY	1			
202	4314J272	REFRIGERATION CYCLE A'SSY		1		
203	4314J367	REFRIGERATION CYCLE ASSY			1	1
204	43172188	PAN DRAIN, ASS'Y	1			
205	43172189	PAN DRAIN, ASS'Y		1		
206	43172190	PAN DRAIN, ASS'Y			1	1
207	43100356	PANEL, UNDER	1			
208	43100357	PANEL, UNDER		1		
209	43100358	PANEL, UNDER			1	1
210	43102647	COVER, SIDE (RIGHT)	1	1	1	1
211	43102648	COVER, SIDE (LEFT)	1	1	1	1
212	43109407	GRILLE, INLET	2		1	1
213	43109408	GRILLE, INLET		2	2	2
214	43121741	MOTOR, FAN			1	1
215	43121742	MOTOR, FAN	1			
216	43121743	MOTOR, FAN		1		
217	43120227	FAN, MULTI BLADE	2	3	4	4
218	43166011	REMOTE CONTROLLER, SX-A4EE	1	1	1	1
219	43166012	REMOTE CONTROLLER, SX-A5EE	1	1	1	1
220	43166004	REMOTE CONTROLLER, SX-A11JE2	1	1	1	1
221	43166006	REMOTE CONTROLLER, WH-H1JE2	1	1	1	1
222	4314Q090	DISTRIBUTOR ASSY	1			
223	43147701	DISTRIBUTOR A'SSY		1		
224	43147702	DISTRIBUTOR A'SSY			1	1
225	43122084	CASE, FAN, LOWER	2	3	4	4
226	43122085	CASE, FAN, UPPER	2	3	4	4
227	43180314	AIR FILTER	2		1	1
228	43180315	AIR FILTER		2	2	2
229	43108014	BASE, RECEIVER	1	1	1	1
230	43179136	BAND, HOSE	2	2	2	2
231	43125131	BEARING, SHAFT			1	1
232	43125162	COUPLING		1	1	1
233	43047685	NUT, FLARE, 1/4 IN	1			
234	43049776	SOCKET		1	1	1
235	43149351	SOCKET	1			
236	43047688	NUT, FLARE, 1/2, IN	1			
237	43149352	NUT, FLARE, 5/8, IN		1	1	1
238	43149353	SOCKET	1			
239	43149354	SOCKET\		1	1	1
240	43149326	COVER, BACK BASE	1	1	1	1
241	43125164	SHAFT		1		
242	43125165	SHAFT			1	1
243	43125159	BEARING		1		
244	43109409	GRILLE A'SSY, HORIZONTAL	1			
245	43109410	GRILLE A'SSY, HORIZONTAL		1		
246	43109411	GRILLE A'SSY, HORIZONTAL			1	1
247	43107260	SUPPORT, GRILLE HORIZONTAL	1	1	2	2
248	43122086	GRILLE A'SSY, VERTICAL	2	2	3	3
249	43179129	CAP DRAIN	1	1	1	1
250	43107254	HINGE, GRILLE INLET	4	4	6	6
251	43107255	HOOK, GRILLE INLET	2	2	3	3
252	43170234	HOSE, DRAIN	1	1	1	1
253	43047609	BONNET		1	1	1
254	43047692	BONNET	1			
255	43194029	BONNET		1	1	1
256	43149355	NUT, FLARE, 3/8, IN		1	1	1
257	43049697	BONNET	1			
258	43019904	HOLDER, SENSOR (TS)	2	2	2	2
259	431S8225	OWNER'S MANUAL	1	1	1	1
260	43121746	DRIVER A'SSY HORIZONTAL LOUVER	1	1	1	1
261	43160556	LEAD, LOUVER HORIZONTAL	1	1	1	1
262	43108016	MARK TOSHIBA	1	1	1	1
263	43162049	BUSHING 50DIA	1	1	1	1
264	43162050	BUSHING 56DIA	1	1	1	1
265	43197189	SCREW, FIX DRAIN PAN	1	1	2	2
266	43107252	SHAFT, HOLIZONTAL LOUVER	1	1	1	1
267	43139153	SPACER, BEARING			2	2
269	43107285	HOOK, GRILLE INLET	2	2	3	3
270	43197202	NUT, FLANGE	2	2	3	3
271	43197203	SCREW, PAINT, M3	2	2	3	3



Location No.	Part No.	Description	Model name RAV-SM			
			564CT-TR	804CT-TR	1104CT-TR	1404CT-TR
201	4314J271	REFRIGERATION CYCLE A'SSY	1			
202	4314J272	REFRIGERATION CYCLE A'SSY		1		
203	4314J367	REFRIGERATION CYCLE ASSY			1	1
204	43172188	PAN DRAIN, ASS'Y	1			
205	43172189	PAN DRAIN, ASS'Y		1		
206	43172190	PAN DRAIN, ASS'Y			1	1
207	43100356	PANEL, UNDER	1			
208	43100357	PANEL, UNDER		1		
209	43100358	PANEL, UNDER			1	1
210	43102647	COVER, SIDE (RIGHT)	1	1	1	1
211	43102648	COVER, SIDE (LEFT)	1	1	1	1
212	43109407	GRILLE, INLET	2		1	1
213	43109408	GRILLE, INLET		2	2	2
214	43121741	MOTOR, FAN			1	1
215	43121742	MOTOR, FAN	1			
216	43121743	MOTOR, FAN		1		
217	43120227	FAN, MULTI BLADE	2	3	4	4
218	43166011	REMOTE CONTROLLER, SX-A4EE	1	1	1	1
219	43166012	REMOTE CONTROLLER, SX-A5EE	1	1	1	1
220	43166004	REMOTE CONTROLLER, SX-A11JE2	1	1	1	1
221	43166006	REMOTE CONTROLLER, WH-H1JE2	1	1	1	1
222	4314Q090	DISTRIBUTOR ASSY	1			
223	43147701	DISTRIBUTOR A'SSY		1		
224	43147702	DISTRIBUTOR A'SSY			1	1
225	43122084	CASE, FAN, LOWER	2	3	4	4
226	43122085	CASE, FAN, UPPER	2	3	4	4
227	43180314	AIR FILTER	2		1	1
228	43180315	AIR FILTER		2	2	2
229	43108014	BASE, RECEIVER	1	1	1	1
230	43179136	BAND, HOSE	2	2	2	2
231	43125131	BEARING, SHAFT			1	1
232	43125162	COUPLING		1	1	1
233	43047685	NUT, FLARE, 1/4 IN	1			
234	43049776	SOCKET		1	1	1
235	43149351	SOCKET	1			
236	43047688	NUT, FLARE, 1/2, IN	1			
237	43149352	NUT, FLARE, 5/8, IN		1	1	1
238	43149353	SOCKET	1			
239	43149354	SOCKET\		1	1	1
240	43149326	COVER, BACK BASE	1	1	1	1
241	43125164	SHAFT		1		
242	43125165	SHAFT			1	1
243	43125159	BEARING		1		
244	43109409	GRILLE A'SSY, HORIZONTAL	1			
245	43109410	GRILLE A'SSY, HORIZONTAL		1		
246	43109411	GRILLE A'SSY, HORIZONTAL			1	1
247	43107260	SUPPORT, GRILLE HORIZONTAL	1	1	2	2
248	43122086	GRILLE A'SSY, VERTICAL	2	2	3	3
249	43179129	CAP DRAIN	1	1	1	1
250	43107254	HINGE, GRILLE INLET	4	4	6	6
251	43107255	HOOK, GRILLE INLET	2	2	3	3
252	43170234	HOSE, DRAIN	1	1	1	1
253	43047609	BONNET		1	1	1
254	43047692	BONNET	1			
255	43194029	BONNET		1	1	1
256	43149355	NUT, FLARE, 3/8, IN		1	1	1
257	43049697	BONNET	1			
258	43019904	HOLDER, SENSOR (TS)	2	2	2	2
260	43121746	DRIVER A'SSY HORIZONTAL LOUVER	1	1	1	1
261	43160556	LEAD, LOUVER HORIZONTAL	1	1	1	1
262	43108016	MARK TOSHIBA	1	1	1	1
263	43162049	BUSHING 50DIA	1	1	1	1
264	43162050	BUSHING 56DIA	1	1	1	1
265	43197189	SCREW, FIX DRAIN PAN	1	1	2	2
266	43107252	SHAFT, HORIZONTAL LOUVER	1	1	1	1
267	43139153	SPACER, BEARING			2	2
268	431S8225	OWNER'S MANUAL	1	1	1	1
269	43107285	HOOK, GRILLE INLET	2	2	3	3
270	43197202	NUT, FLANGE	2	2	3	3
271	43197203	SCREW, PAINT, M3	2	2	3	3

## Electric parts

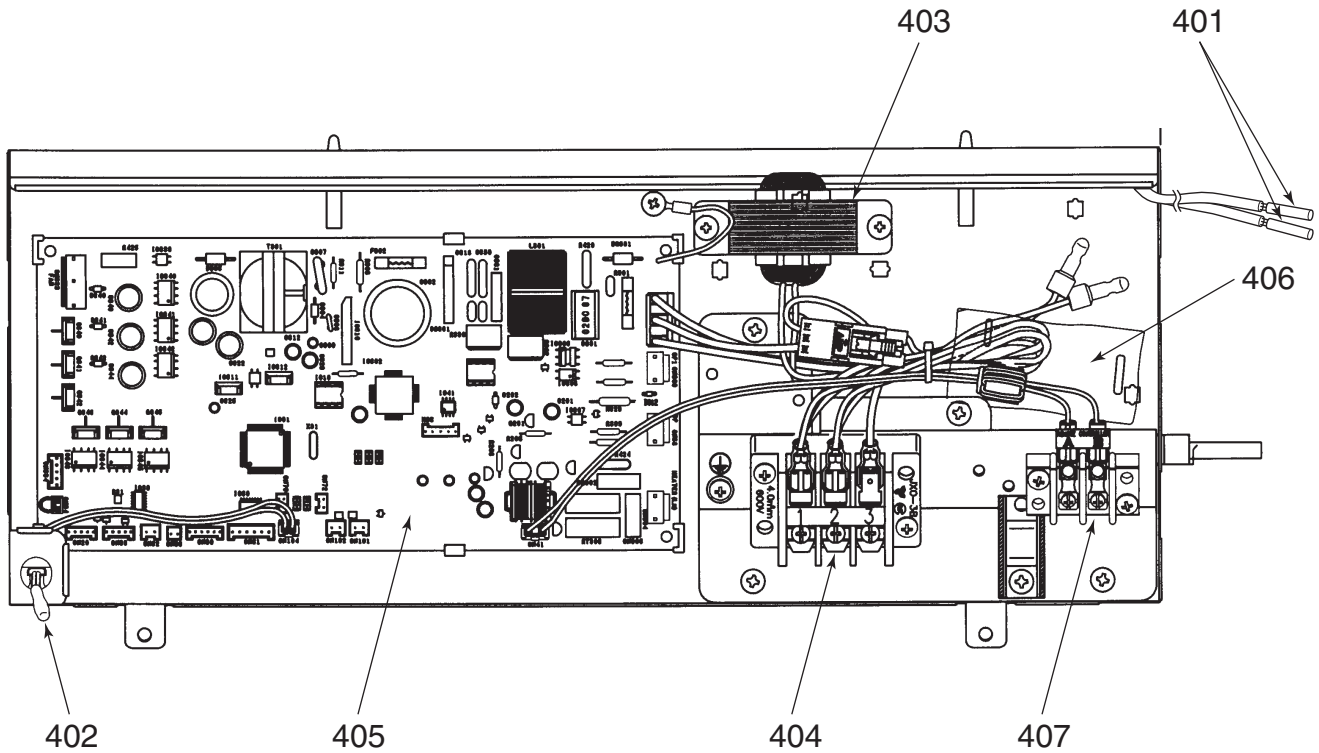

Location No.	Part No.	Description	Model name RAV-SM			
			564CT-E (TR)	804CT-E (TR)	1104CT-E (TR)	1404CT-E (TR)
401	43050425	SENSOR ASSY, SERVICE, TC	2	2	2	2
402	43050426	SENSOR, SERVICE, TA	1	1	1	1
403	43158193	REACTOR, CH-43-2Z-T	1	1	1	1
404	43160565	TERMINAL BLOCK, 3P, 20A	1	1	1	1
405	4316V461	PC BOARD ASSY, MCC-1402	1	1	1	1
406	43155203	CAPACITOR KIT, SERVICE	1	1	1	1
407	43160568	TERMINAL, 2P	1	1	1	1

# WARNINGS ON REFRIGERANT LEAKAGE

## Check of Concentration Limit

The room in which the air conditioner is to be installed requires a design that in the event of refrigerant gas leaking out, its concentration will not exceed a set limit.

The refrigerant R410A which is used in the air conditioner is safe, without the toxicity or combustibility of ammonia, and is not restricted by laws to be imposed which protect the ozone layer.

However, since it contains more than air, it poses the risk of suffocation if its concentration should rise excessively. Suffocation from leakage of R410A is almost non-existent.

With the recent increase in the number of high concentration buildings, however, the installation of multi air conditioner systems is on the increase because of the need for effective use of floor space, individual control, energy conservation by curtailing heat and carrying power etc.

Most importantly, the multi air conditioner system is able to replenish a large amount of refrigerant compared with conventional individual air conditioners.

If a single unit of the multi conditioner system is to be installed in a small room, select a suitable model and installation procedure so that if the refrigerant accidentally leaks out, its concentration does not reach the limit (and in the event of an emergency, measures can be made before injury can occur).

In a room where the concentration may exceed the limit, create an opening with adjacent rooms, or install mechanical ventilation combined with a gas leak detection device.

The concentration is as given below.

$$\frac{\text{Total amount of refrigerant (kg)}}{\text{Min. volume of the indoor unit installed room (m}^3\text{)}} \leq \text{Concentration limit (kg/m}^3\text{)}$$

The concentration limit of R410A which is used in multi air conditioners is 0.3kg/m<sup>3</sup>.

### NOTE 1 :

If there are 2 or more refrigerating systems in a single refrigerating device, the amounts of refrigerant should be as charged in each independent device.

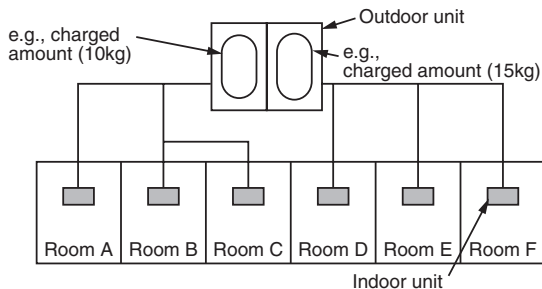

For the amount of charge in this example:

The possible amount of leaked refrigerant gas in rooms A, B and C is 10kg.

The possible amount of leaked refrigerant gas in rooms D, E and F is 15kg.

## Important

### NOTE 2 :

The standards for minimum room volume are as follows.

- (1) No partition (shaded portion)

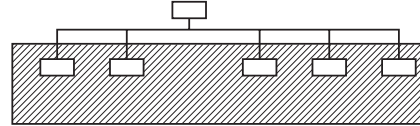

- (2) When there is an effective opening with the adjacent room for ventilation of leaking refrigerant gas (opening without a door, or an opening 0.15% or larger than the respective floor spaces at the top or bottom of the door).

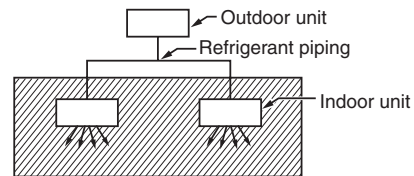

- (3) If an indoor unit is installed in each partitioned room and the refrigerant piping is interconnected, the smallest room of course becomes the object. But when a mechanical ventilation is installed interlocked with a gas leakage detector in the smallest room where the density limit is exceeded, the volume of the next smallest room becomes the object.

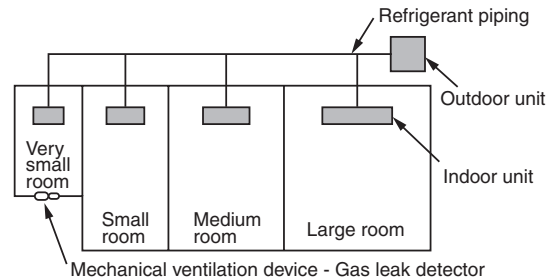

### NOTE 3 :

The minimum indoor floor area compared with the amount of refrigerant is roughly as follows: (When the ceiling is 2.7m high)

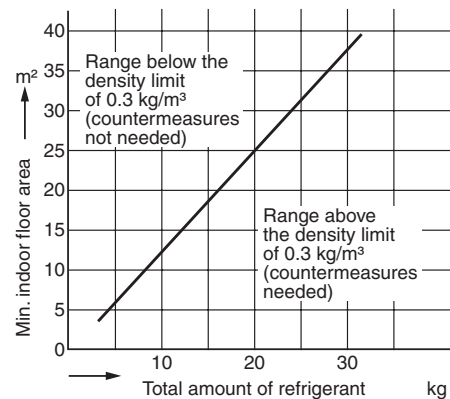

# **TOSHIBA CARRIER CORPORATION**

23-17, TAKANAWA 3 CHOME, MINATOKU, TOKYO, 108-8580, JAPAN

Copyright © 1999 to 2010 TOSHIBA CARRIER CORPORATION, ALL Rights Reserved.

## Free Manuals Download Website

<http://myh66.com>

<http://usermanuals.us>

<http://www.somanuals.com>

<http://www.4manuals.cc>

<http://www.manual-lib.com>

<http://www.404manual.com>

<http://www.luxmanual.com>

<http://aubethermostatmanual.com>

Golf course search by state

<http://golfingnear.com>

Email search by domain

<http://emailbydomain.com>

Auto manuals search

<http://auto.somanuals.com>

TV manuals search

<http://tv.somanuals.com>