

TOSHIBA

CD-ROM DRIVE

(T)XM6401B/F1 HARDWARE INSTRUCTION MANUAL

**VERSION 2.0
APRIL 2000**



CD-ROM DRIVE
Hardware Instruction Manual

For the following CD-ROM Drives:

XM-6401B
TXM6401F1

TOSHIBA AMERICA ELECTRONIC COMPONENTS, INC.
Storage Device Division
35 Hammond
Irvine, CA 92618

Contents of this manual are subject to change without prior notice.

© 1998 TOSHIBA AMERICA ELECTRONIC COMPONENTS, INC.
All rights reserved

Printed in USA



CERTIFICATION

<i>This equipment complies with the following standards:</i>	
XM-6401B	TXM6401F1
UL 1950 Electrical Business Equipment	UL 1950 Electrical Business Equipment
CAN/CSA: TD STD 950/UL 1950	CSA Standard C22.2 No. 234
TUV EN 60950/08.92, A1/01.93, A2/08.93 60929/09/91	N/A
FCC Class B - specification limits defined by EN55022 for information Technology Equip.	FCC Class B - specification limits defined by EN55022 for information Technology Equip.
IEC Standard: IEC 801-2: 1992 IEC 801-3: 1994, ENV 50140 1994 IEL 801-4: 1988	N/A
European: Directives: 89/336/EEC (EMC directives)	
Harmonized Standard: EN 500821-1: 1992 EN55022: 1992 class B	N/A

FCC DECLARATION OF CONFORMITY

CD-External Enclosure:	TXM6401F1
Certification Date:	11/9/98
Toshiba America Electronic Components, Inc. - SDD 35 Hammond, Irvine, CA 92618	

This equipment has been tested and found to comply with the limits for a class B digital device, pursuant to part 15 of the FCC Rules. These limits are designed to provide reasonable protection against harmful interference in a residential installation. This equipment generates, uses and can radiate radio frequency energy, and if not installed and used in accordance with the instructions, may cause harmful interference to radio communications. However, there is no guarantee that interference will not occur in a particular installation. If this equipment does cause harmful interference to radio or television reception, which can be determined by turning the equipment off and on, the user is encouraged to try to correct the interference by one or more of the following measures:

- Re-orient or relocate the receiving antenna.
- Increase the separation between the equipment and receiver.
- Connect the equipment into an outlet on a circuit different from that to which the receiver is connected.
- Consult the dealer or an experienced radio/TV technician for help.

This equipment has been certified to comply with the limits for a class B computing device, pursuant to FCC Rules. In order to maintain compliance with FCC regulations, shielded cables must be used with this equipment. Operation with non-approved equipment or unshielded cables is likely to result in interference to radio and TV reception. The user is cautioned that changes and modifications made to the equipment without the approval of the manufacturer could void the user's authority to operate this equipment.

LASER CAUTION

This appliance contains a laser system and is classified as a "CLASS 1 LASER PRODUCT". To use this model properly, read this Owner's Manual carefully and keep this manual for future reference. In case of any trouble with this model, please contact your nearest "Authorized Repair Center". To prevent direct exposure to the laser beam, do not try to open the enclosure.

CAUTION!

- **REFLECTIVE OBJECTS SHOULD NOT BE PLACED IN THE DISK SLOT DUE TO POSSIBLE HAZARDOUS RADIATION EXPOSURE.**
- **USE OF CONTROLS, ADJUSTMENTS, OR PROCEDURES OTHER THAN SPECIFIED IN THIS MANUAL MAY RESULT IN HAZARDOUS RADIATION EXPOSURE.**

TRADEMARK INFORMATION

IBM is a registered trademark of International Business Machines, Inc.

Apple Macintosh is a registered trademark of Apple Computer, Inc.

MS-DOS is a registered trademark of Microsoft Corporation

Photo CD symbol is a trademark of Kodak used under license.

Future Domain is a registered trademark of Adaptec

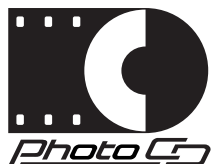

Must be used with
Kodak approved
host adapter board
and software driver.

<i>Version</i>	<i>Date Published</i>	<i>Revised Contents</i>
01	December 1998	Initial release
02	April 2000	DPD to SDD

Table of Contents

Introduction	1
SCSI drives	2
Installing CD-ROM	3
Installation Requirements	3
Installing an Internal CD-ROM	3
CD-ROM Jumper Settings	4
Placing CD-ROM inside your computer	7
Cabling	8
Completing Installation	11
Software	11
Installing an External CD-ROM	12
CD-ROM SCSI ID Settings	12
Termination	13
Cabling	14
Software	15
Using your CD-ROM	16
The Controls	16
Front Panel	17
Back Panel	18
Operating the CD Loading Tray	20
Emergency Eject	21
Specifications	22
Performance	22
Environmental Conditions	24
Physical Characteristics	25
Technical Support	26
Repair Center	27
Warranty	28

Introduction

Congratulations on the purchase of your Toshiba XM-6401B CD-ROM drive. This manual will provide you with the information you will need to install and operate your new CD-ROM.

This manual covers both the internal CD-ROM (XM-6401B) and the external CD-ROM (TXM6401F1). Instructions in this manual apply to both models, unless otherwise stated.

The XM-6401B is one of the fastest CD-ROM drives currently available. Features include:

- **40X speed** *Brings leading edge performance.*
- **Tray operation** *No need to use a caddy. Just open tray, drop in a disc, and close tray.*
- **85ms Random Seek** *XM-6401B's great performance makes it ideal for data and multimedia applications.*
- **6,000kb/s Sustained Transfer Rate** *Fast enough for the most demanding applications.*



XM-6401B Front Panel

SCSI DRIVES

The XM-6401B is a SCSI-2 (Small Computer Systems Interface) device. Some other SCSI devices you may already have connected to your computer are scanners, tape drives, or another CD-ROM drive.

PC SYSTEMS: To add a SCSI device to your computer, you must have a SCSI interface card already in place. The interface card fits into one of the slots inside your computer and connects to your CD-ROM device via a SCSI cable.

Your CD-ROM also requires a software driver to be installed. This driver is written for the SCSI interface card you are using. If you do not have the CD software driver, contact your SCSI card manufacturer (**do not contact Toshiba**).

APPLE MACINTOSH SYSTEMS: If you are connecting the XM-6401B CD-ROM to an Apple Macintosh system, there is no need to install an interface card, as Apple systems have a built-in SCSI port. You will need a CD-ROM software driver written for the Macintosh that supports Toshiba CD-ROMs. (Toshiba recommends *CD-ROM Tool Kit* by FWB Inc.)*

* *CD-ROM Tool Kit can be purchased from Advanced Multimedia Concepts (AMC), 888-262-9700.*

Installing CD-ROM

Before you begin to install your CD-ROM, make sure you have the items listed below. In most cases, these items will not come with your CD-ROM. See your local computer retailer to purchase them.

INSTALLATION REQUIREMENTS

- CD-ROM Software Driver (*when installing on a PC the software driver must be written for the SCSI host adapter card you have installed in your computer system*)
- SCSI Host Adapter Board (*PC systems only*)
- SCSI Interface Cable
- External Terminator (*TXM6401F1 installations only*)
- Power Cord (*TXM6401F1 installations only*)

INSTALLING AN INTERNAL CD-ROM (XM-6401B)

The instructions that follow are for use on PC systems only. In order to install your internal CD-ROM successfully, you will need to complete the following steps:

- ☛ Install SCSI host adapter board in your computer system (*if not already installed*).
- ☛ Set jumper settings on CD-ROM.
- ☛ Install CD-ROM inside your computer.
- ☛ Using a SCSI cable, connect CD-ROM to SCSI interface card.
- ☛ Connect +5/+12V power cable to internal CD-ROM drive.
- ☛ Connect a sound cable to your CD-ROM (*optional*).
- ☛ Load CD-ROM driver software (*driver is obtained from your SCSI host adapter manufacturer*).

IMPORTANT NOTE

Before you begin installing your CD-ROM, make sure your computer is switched OFF and the power cable is disconnected.

CD-ROM JUMPER SETTINGS

In order for your CD-ROM to work properly, it may be necessary for you to change the CD-ROM's jumper settings.

Locate the block of jumpers on the back left side of the CD-ROM.

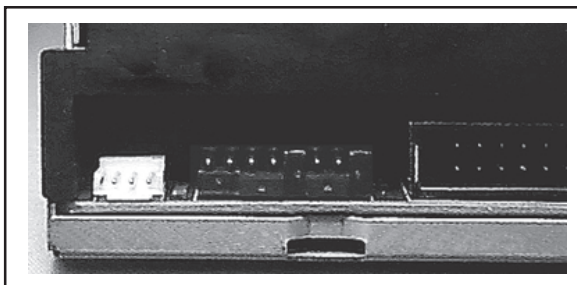

Jumper Location

Jumpers can be set in either an ON mode or OFF mode. If the jumper covers both pins on the jumper block, it is ON, if there is no jumper or only one of the pins is jumpered, the jumper is OFF. This section will discuss the following jumper settings: SCSI ID, Parity, Eject, Test/Audio Reproduction, Termination, and Power Supply.

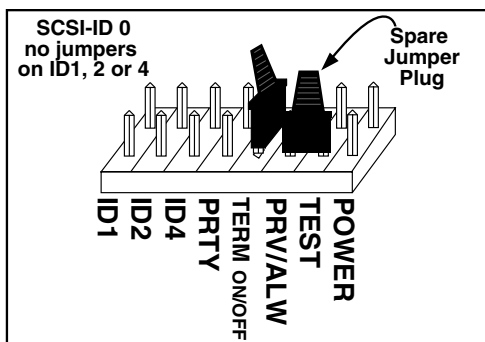

All SCSI devices attached to your computer are assigned a SCSI-ID number from 0 to 7. Your CD-ROM's SCSI ID must be set so that its ID number does not conflict with any other device's SCSI-ID in your system. In most cases your CD-ROM will come set to SCSI ID 0. If your CD-ROM is the only SCSI device connected to your computer, you should leave the jumpers as they are. If you have additional SCSI devices (another CD-ROM, hard drive, etc.) you will be "daisy-chaining" these devices. Each SCSI device must have a different SCSI ID. Note that your SCSI interface card in most cases has a SCSI ID of 7. The chart below shows the jumper settings for the eight possible ID numbers:

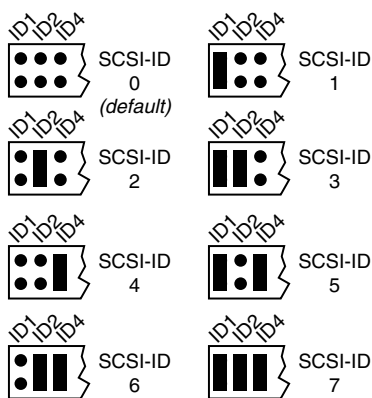

Parity Jumper

The Parity Jumper should be set to OFF (no jumper present). This jumper activates/de-activates the parity bit check function on the SCSI data bus. This enhances data bus reliability. (Cannot be used if no parity generation function is provided on the I/F card.)

Terminator ON/OFF Jumper

This jumper turns termination power ON or OFF. If you are “daisy-chaining” a series of SCSI devices (connecting more than one SCSI device to your system), and the XM-6401B CD-ROM is **not at the end of the chain**, you must remove the jumper.

Eject Prevention Jumper

This jumper is used to inhibit the operation of the drive’s EJECT button. When jumper is set to ON (jumper present), the EJECT button will not operate. Setting the jumper to OFF (no jumper present) will allow the EJECT button to operate.

Test/Audio Reproduction Jumper

The TEST jumper should be set to OFF (no jumper present). Setting it in the ON position (jumper present) will provide audio disc reproduction (*note: SCSI-ID must be set to 0*). In audio mode the CD will begin at track 1 and continue to the end of the CD. To advance to the next track, push eject button for less than a second. Pushing the button for more than a second opens the CD tray. When you are in audio disc reproduction mode, commands from the host computer are ignored.

Power Supply Jumper (Termination Power Jumper)

Toshiba SCSI CD-ROM drives can supply power to other equipment on the SCSI BUS. When the jumper is ON, the drive will supply termination power. At least one device on the SCSI BUS must supply the termination power. If you’re not sure if any other device supplies termination power, it is fine to leave the jumper ON.

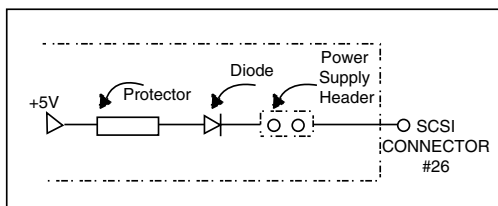

PLACING CD-ROM INSIDE YOUR COMPUTER

You are now ready to install your CD-ROM inside your computer. You should refer to the book that came with your computer, as computer casings are different from each other. Usually the casing is attached to the frame by a number of screws at the back. Turn your computer around, so the back faces you, and look for 4 or 6 screws around the edge of the casing. Remove the screws and put them somewhere safe. Lift or slide casing away from computer frame, and place aside (make sure to allow yourself enough workspace for the CD-ROM installation).

The XM-6401B CD-ROM drive can be placed in any free half-height drive slot at the front of your computer. (It can be mounted horizontally or vertically.) You most likely will have to remove the cover plate which conceals the front of the open slot (see your computer book on how to remove panel).

Carefully start sliding the CD-ROM drive into the opening with the disc tray facing the front of the computer. Before you push drive all the way in you will need to connect the SCSI interface cable and the power cable to the back of the drive.



Installing XM-6401B

CABLING

SCSI - The internal SCSI interface cable is connected to your SCSI host adapter card and fits into the socket on the back of your CD-ROM. The stripe side (or red-colored side) of the ribbon cable connects to pin 1 on the drive's SCSI connector which is found next to the drive's power connector. Carefully push the SCSI connector into the socket, making sure it fits snugly.

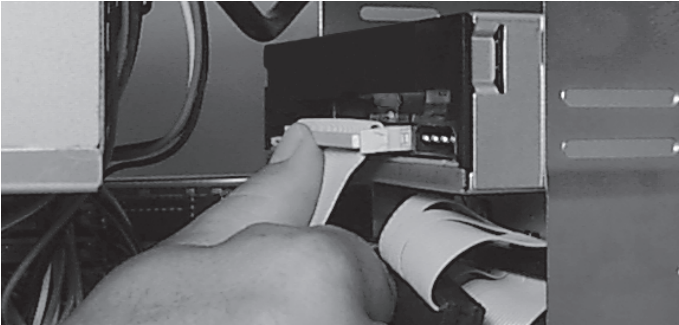

Attaching SCSI Cable

Power - Apply power to your CD-ROM by connecting your computer's +12V/+5V power cable to the power socket at the back of the drive. One side of the plug has chamfered edges, so the power connector fits only one way. Push plug completely into the socket making sure the plug fits into the socket correctly.

CAUTION!

Severe damage to the CD-ROM circuits may occur if power cable is plugged in upside-down with power ON.



Installing Power Cable

If there is no power cable in your system, contact your computer dealer. You may need a “power splitter lead” (a Y shaped cable which taps two power outputs from one input).

Sound (optional) - If you have a sound card and speakers and would like to play audio CDs on your computer, you will need to get a sound cable. Contact our small parts supplier, AMC at 888/262-9700. Sound cables are made for the sound card you are using and the CD-ROM drive you are connecting it to. Make sure you have this information when purchasing a sound cable. The sound cable connects to your sound card at one end and the audio connector at the left rear of the CD-ROM at the other end. Refer to the instructions that came with your sound card for details on any sound-driver software required.

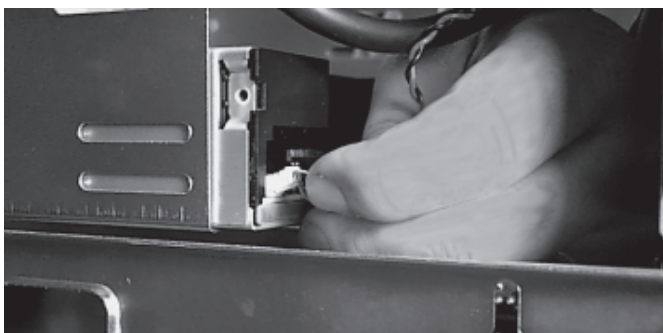

Installing Sound Cable

Daisy-Chaining - If the CD-ROM you are installing is one of two or more SCSI devices you have connected to your system, you will need to use a custom built SCSI interface cable. Remember that the terminator jumper on the CD-ROM drive must have the jumper installed when the drive is the last device in the chain.

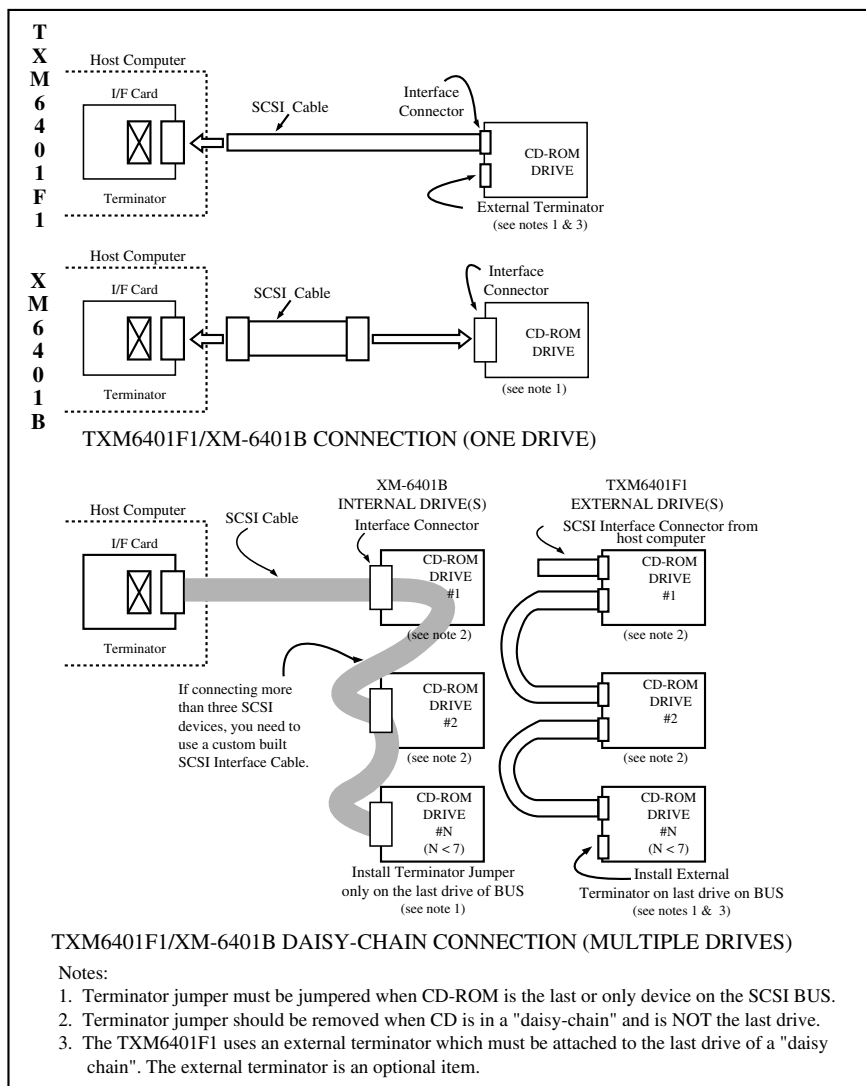

COMPLETING INSTALLATION

After you have connected all the necessary cables, you can push the CD-ROM completely into the slot. There are 12 screw holes on the XM-6401B that are used to mount the CD-ROM into your computer. The screw length should not exceed $3 \pm 0.5\text{mm}$ (measured from outside surface of side or bottom of CD-ROM to tip of screw). Replace the computer's cover, and replace all outer screws.

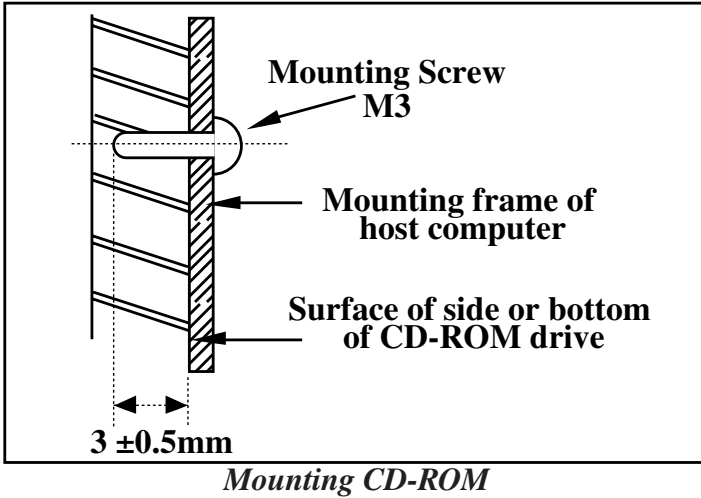

SOFTWARE

In order for your computer to recognize the CD-ROM, you must install a CD-ROM software driver. If you do not have this software driver, contact the manufacturer of your SCSI host adapter card. Use the instructions that came with your software to install the CD-ROM software driver.

INSTALLING AN EXTERNAL CD-ROM (TXM6401F1)

The instructions that follow are for use on PC and Macintosh systems. In order to install your external CD-ROM successfully, you will need to complete the following steps.

- ☛ Install SCSI host adapter board in your computer system (*if not already installed*). - *PC systems only*
- ☛ Set SCSI ID Switch on CD-ROM.
- ☛ Using a SCSI cable, connect CD-ROM to SCSI interface card or SCSI port.
- ☛ Connect supplied power cord to CD-ROM.
- ☛ Load CD-ROM driver software.

IMPORTANT NOTE

Before you begin installing your CD-ROM, make sure your computer is switched OFF and the power cable is disconnected.

CD-ROM SCSI ID SETTING

In order for your CD-ROM to work properly, it may be necessary for you to change the CD-ROM's SCSI ID. All SCSI devices attached to your computer are assigned a SCSI ID number from 0 to 7. Your CD-ROM's SCSI ID must be set so that its ID number does not conflict with any other SCSI device's ID in your system. In most cases your CD-ROM system will come set to SCSI ID 0. If your CD-ROM is the only SCSI device connected to your computer, you should leave the SCSI ID switch in the default position. If you have additional SCSI devices (another CD-ROM, hard drive, etc.) you will be "daisy-chaining" these devices. Each SCSI device must have a different SCSI ID. Note that your SCSI interface card, in most cases, has a SCSI ID of 7. The SCSI ID Switch is located on the rear of the CD-ROM Enclosure. Click button to select a SCSI ID between 0 and 7.

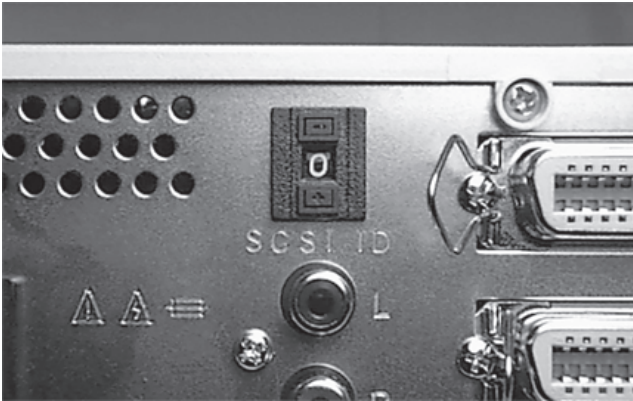

SCSI ID Switch

TERMINATION

If the CD-ROM is being installed as the last drive in a daisy-chain or as the only SCSI device, you must install an external terminator on one of the SCSI connectors at the rear of the CD-ROM.



External Terminator

CABLING

SCSI - Locate the SCSI interface card connection or SCSI port at the back of your computer. Plug the SCSI cable into socket, making sure it fits snugly. (*If the plug has fixing screws or clips, use them to ensure the connector is firmly fixed.*) Plug the other end of the cable into one of the sockets found on the back of the CD-ROM drive (the other connector should have a terminator installed, or if daisy-chaining, be attached to another SCSI device). You must use a daisy-chain cable if you are connecting more than one SCSI device to your computer. Only the last drive in the chain will need to have an external terminator installed.

Power - Connect power to CD-ROM using the power cord included with your CD-ROM.



SCSI Cabling and Power Connector

Audio (optional) - Audio jacks are located at the rear of the CD-ROM drive. These audio jacks can be used to connect your CD-ROM to an external amplified audio device.

SOFTWARE

In order for your computer to recognize the CD-ROM, you must install a CD-ROM software driver.

PCs - If you do not have this software, contact the manufacturer of your SCSI host adapter card. Use the instructions that came with your software to install the CD-ROM software driver.

Using your CD-ROM

THE CONTROLS

The XM-6401B/TXM6401F1 CD-ROM drives have the following controls and features:

- CD Loading Tray
- EJECT Button
- Emergency Eject Hole
- BUSY Light
- Headphone Jack
- Volume Control
- Audio Output Terminals (*TXM6401F1 only*)

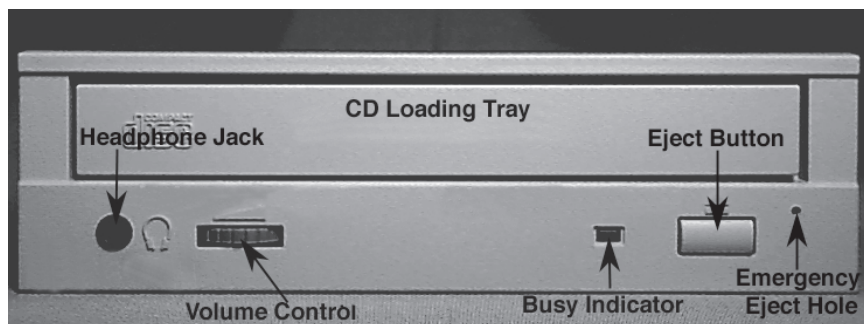

XM-6401B Front Panel

THE FRONT PANEL

Eject Button - The EJECT button is used to open the disc tray so you can install or remove a disc. The EJECT Inhibit Jumper must be set to OFF in order for the EJECT button to function. (*If jumper is in ON position, the drive accepts all eject control from the computer*).

Busy Light - When you install a disc into the CD-ROM drive, the BUSY light flashes slowly as it attempts to locate the disc. One of the following will occur:

- BUSY light goes out. *The CD-ROM drive is ready to read data from the disc.*
- BUSY light flashes slowly. *The disc may be dirty.*
- BUSY light remains ON. *The CD-ROM is accessing data.*
- BUSY light remains ON indefinitely. *The CD-ROM is experiencing an error.*

Headphone Jack - The headphone jack is used to connect headphones to your CD-ROM.

Emergency Eject Hole - The emergency eject hole is to be used *only* when the CD tray will not open when EJECT button is pressed. See page 20 for additional information.

Volume Control - The volume control is used to adjust the level of the audio signal from the headphone jack. The volume control does not affect the level of the signal sent to the audio output on the back of the drive.

THE BACK PANEL

The pictures below show the back panel of the XM-6401B and TXM6401F1 CD-ROM drives. Descriptions of features are as follows:

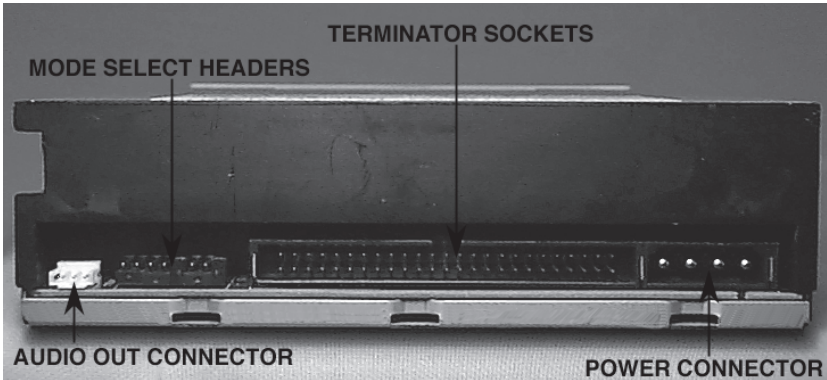

XM-6401B Back Panel

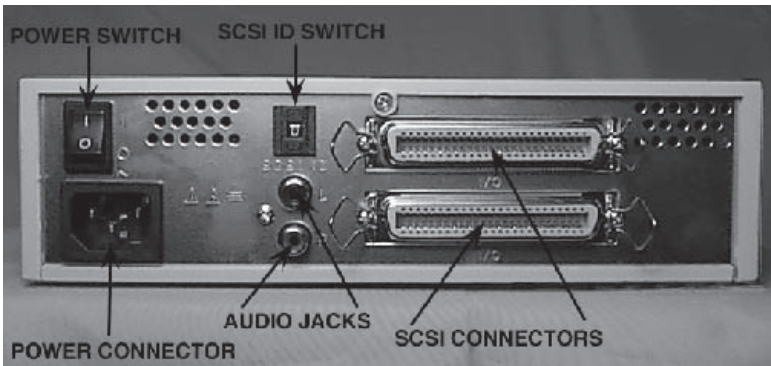

TXM6401F1 Back Panel

Audio Out Connector - Outputs analog signal on the XM-6401B only.

Mode Select Headers (jumpers) - Selects SCSI-ID, Parity Check function, Power Supply, EJECT Button inhibit function, Test/Audio Reproduction mode and Terminator Power (*XM-6401B only*).

SCSI Connector(s) - Connects CD-ROM to computer. The TXM6201F1 has two SCSI connectors.

Power Connector - Connects CD-ROM to power source (either power adapter or power cable from computer).

Power Switch - Turns power ON and OFF on the TXM6401F1.

Audio Jacks - Connects CD-ROM to external amplified device (*TXM6401F1 only*).

SCSI ID Switch - Selects SCSI ID (*TXM6401F1 only*).

OPERATING THE CD LOADING TRAY

To open the CD loading tray, just press the EJECT button. After inserting or removing a disc, press the EJECT button again or gently push on the open disc tray, the tray will automatically close.

Vertical Installations

If you are loading a disc in a XM-6401B drive that has been mounted vertically, perform the following procedures:

1. The disc holders (4 locations) are fixed by four projections.
2. Position the disc at the bottom disc holders until it catches. It's okay if the disc is not secured by the top disc holders.
3. Close the drive by gently pushing in the tray or pressing the eject button.

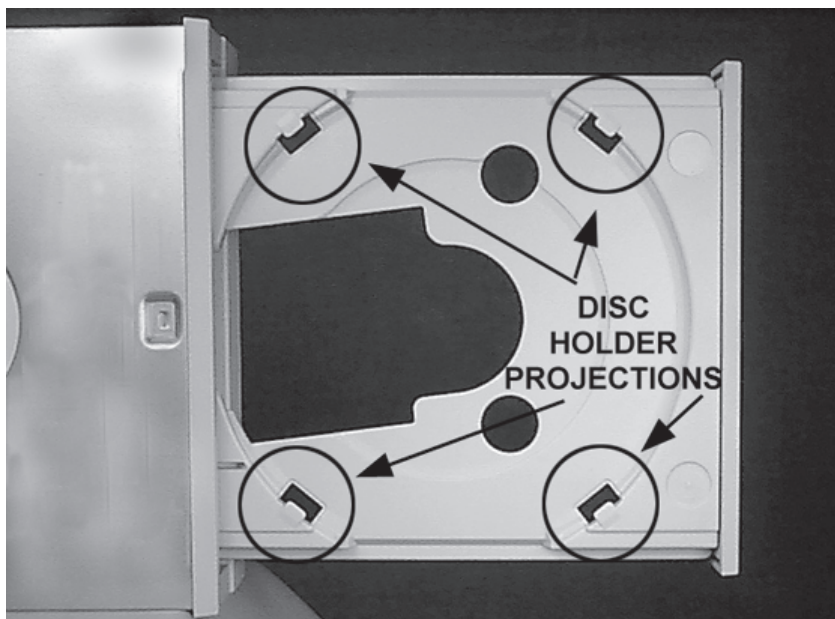

CD Loading Tray

EMERGENCY EJECT

CAUTION!

The following procedure is intended only as a last resort when pressing the eject button fails to open the CD tray.

1. Turn CD-ROM drive power OFF.
2. Insert a solid bar (i.e. large paper clip*) into Emergency Eject hole and push in as shown in the picture below.
3. CD tray will open/eject.

This procedure cannot be repeated without cycling the CD-ROM's power. After the media is removed and the loading tray is closed, the tray will not reopen without first turning the power ON/OFF.

- * Use a bar that is less than 1.5 mm in diameter. Do not insert more than 50mm in depth. Inserting more than 50mm may damage the CD-ROM drive.

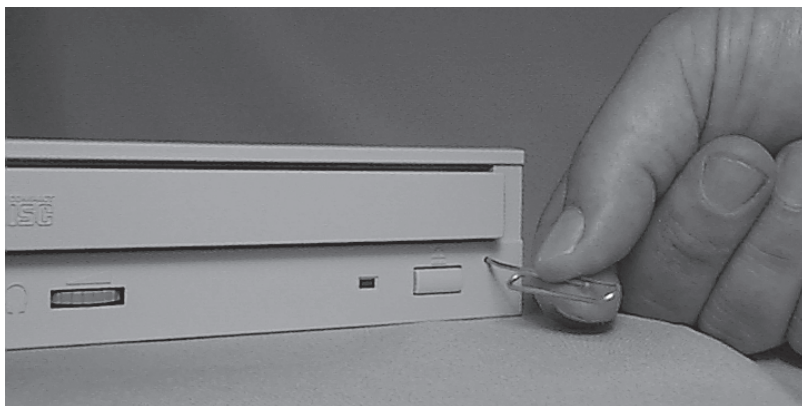

Inserting Bar to Eject CD Tray

Specifications

The following describes the specifications of the XM-6401B CD-ROM. (*Specifications are subject to change without notice.*)

PERFORMANCE

- *Disk Formats¹* Red Book, Yellow Book, CD-ROM XA, CD-I Bridge (Photo CD, Video CD), CD-I, CD-I Ready, CD-G and Multisession (Photo-CD, CDEXTRA, CD-RW, CD-R)

¹Note: All CD formats, except CD-Red book (audio), require additional application specific software and/or hardware. The XM-6401B CD-ROM drive is capable of reading these data formats. However, in order to run applications that use these formats, you must first have the required software and/or hardware.

- *Data Capacity (Yellow-Book)*
 - User data block size:
 - Mode-1: 2,048 Bytes
 - Mode-2: 2,336 Bytes
- *Rotational Speed²*
 - 6X-14X (PCAV): 3,000 rpm (apprx)
 - 17.3X-40X (CAV): 8,500 rpm (apprx)
- *Transfer Rate*
 - Average Sustained Block Transfer Rate
 - 6X-14X: 450-1,050 blocks/second
 - 17.3X-40X: 1,295-3,000 blocks/second
 - Mode 1 Sustained Data Transfer Rate
 - 6X-14X: 900-2,100 Kbytes/second
 - 17.3X-40X: 2,595-6,000 Kbytes/second
 - Mode 2 Sustained Data Transfer Rate
 - 6X-14X: 1,026-2,394 Kbytes/second
 - 17.3X-40X: 2,958-6,840 Kbytes/second
 - Burst (SCSI interface):
 - Async: 5 Mbytes/second
 - Sync: 20 Mbytes/second

- *Access Time*
 - Average Random Access Time³:
80 msec typ. (40X mode)
 - Average Random Seek Time⁴:
75 msec typ. (40X mode)
 - Average Full Stroke Access Time⁵:
135 msec typ. (40X mode)
- ² 6-14X rotational speed is fixed for CD-audio (Red-Book) format. For the other formats, 17.3X - 40X or 6X-14X mode is selected by command. The default value is 40X.
- ³ Measured by performing multiple accesses which refer to reads of data blocks over the whole area of the media from 00:02:00 to 60:01:74 more than 3,000 times. Includes positioning, setting, latency time, and ECC implementation time (if required).
- ⁴ Measured by performing multiple accesses which refer to seeks of data blocks over the whole area of the media from 00:02:00 to 60:01:74 more than 3,000 times. Includes positioning and setting time which has the same definition as HDD.
- ⁵ Measured by performing multiple maximum accesses which refer to reads of data blocks from 00:02:00 to 60:01:74 more than 100 times. Includes positioning, setting, latency time, and ECC implementation time (if required). Typical value is for the average drive.

- *Spin-up Time* (focus search time and disc motor start up time)
 - 3.5 sec. typ. (40X)
 - 5.5 sec. max.
- *Data buffer*
 - 256 Kbytes
- *Load/Eject*
 - Electronic Load/Eject (EJECT Button)
 - Load/Eject by SCSI command
 - Emergency Eject
- *Air Flow*
 - Not Required
- *Acoustic Noise*
 - 45dB (IEC 179 A-weighted) max. at 1 meter
- *Power Supply (XM-6401B)*
 - +5 volts and +12V
- *F1 Enclosure*
 - +5 volts and +12V
 - AC input 96-276 VAC/50-60hz
- *Indicators*
 - Busy
- *Signal Interface Connector*
 - Input/Output (SCSI-2)

- *Audio Output*
 - Analog output (.90 Vrms typ. at load impedance 10KΩ min.)
 - Headphone output terminal: 3.5 mm diameter stereo phonejack, adjustable output level
 - Headphone output 0.9V (rms typ.)

ENVIRONMENTAL CONDITIONS

- *XM-6401B*
 - Operating temperature: 41° to 122° F (+5° to 50° C)
 - Operating humidity: 8% to 80% (no condensation)
 - Storage/shipping humidity: 5% to 95% (no condensation)
 - Storage temperature: 14° to 140° F (-10° to +60° C)
 - Shipping temperature: -40° to +149° F (-40° to +65° C)
 - Wet bulb temperature: 80.6° F (27° C)
- *TXM6401F1*
 - Operating temperature: 32° to 104° F (0° to +40° C)
 - Non-operating temperature: -4° to +185° F (-20° to +85° C)
 - Non-operating Humidity: 5% to 95% (no condensation)

RELIABILITY

- *Hard Read Error Rate*
 - Mode 1: 10⁻¹⁵ max
 - Mode 2: 10⁻¹² max
- *Seek Error Rate*
 - 10⁻⁶ max
- *MTBF*
 - 100,000 hours
- *MTTR*
 - 0.5 hours
- *Drive Life*
 - 15,000/hours or 5 years
- *Load/Eject*
 - 10,000 times or more
- *Interface Connector Attach/Detach*
 - 20 times or more
- *DC Power Connector Attach/Detach*
 - 20 times or more

PHYSICAL CHARACTERISTICS

■ Dimensions and weight

- Dimensions:
 XM-6401B: 5.75 x 1.63 x 7.6 inches
 (146 x 41.5 x 193 mm)
 TXM6401F1: 10 x 9.7 x 2.7 inches
 (254 x 246.4 x 68.5 mm)
- Weight:
 XM-6401B: 1.96 lbs (.73 Kg)
 TXM6401F1: 7.05 lbs (2.63 Kg)

■ Operating position

- XM-6401B: Horizontal and Vertical
- TXM6401F1: Horizontal

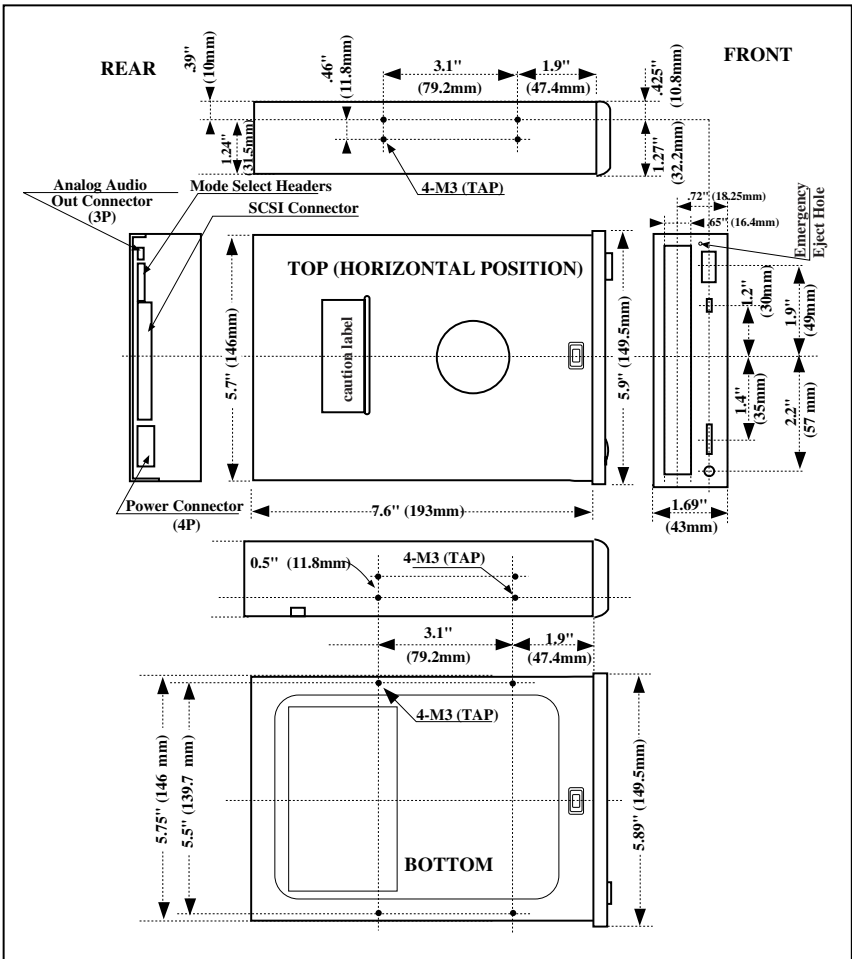

Technical Support

Should you require technical support, contact your local distributor. If your distributor is unable to answer your questions, have them call Toshiba Storage Device Division Technical Support, on your behalf.

**Toshiba Storage Device Division
Technical Support
949/455-0407**

Please provide your distributor with the following information before they contact the Toshiba Technical Support Organization:

1. A written, accurate record of any error messages and the sequence of events leading up to the problem.
2. System version you are using (i.e. Win95, Win98).
3. Host adapter board, software driver, and version level you are using.
4. The hardware system configuration of your system including any non-standard hardware.
5. A list of any special additional software or modifications that have been made to the AUTOEXEC.BAT or CONFIG.SYS files.

In addition, please have hardware near the phone or readily accessible. Remember, many problems are caused by the interaction of two or more products in your system. The problem could be related to your latest addition.

Technical information can be obtained by fax using Toshiba SDD's *FaxBack* system through the technical support phone number above. *FaxBack* is available 24 hours a day, 7 days a week.

You can also obtain technical information and software driver information from our web site at <http://www.toshiba.com> or from the BBS at 949/837-8864.

Repair Center

Should your CD-ROM require maintenance, contact Toshiba SDD's Repair Center. In order to return your CD-ROM a Return Authorization Number (RA#) must be obtained from Toshiba's SDD Repair Center (do not send drives without an authorized RA number).

Toshiba Repair Center
510/651-6798
(fax: 510/623-9893)

Warranty

Toshiba America Electronic Components, Inc. (“TAEC”) warrants that all products will, upon delivery by TAEC to the customer in new condition, be free from defects in material and workmanship for a period of twelve (12) months after delivery. TAEC warrants that spare Parts and Accessories will be free from defects in material and workmanship for a period of ninety (90) days. These warranties are effective from the date of shipment by TAEC to the original purchaser and will be extended only to that original purchaser. TAEC will, at its option, repair or replace the defective item under warranty in accordance with TAEC’s published Repair Policy and Procedure.

This warranty is void: (a) if the Products are used under other than normal use and maintenance conditions, (b) if the Products are modified or altered, unless the modification or alteration is expressly authorized by TAEC, (c) if the equipment is subject to abuse, neglect, lightning, electrical fault, or accident, (d) if the Products are repaired by someone other than TAEC, (e) if the serial numbers of the Products are defaced or missing, or (f) if the Products are installed or used in combination or in assembly with products not supplied by and which are not compatible or of inferior quality, design or performance.

This Warranty shall constitute the sole and exclusive liability of the TAEC, its successors or assigns, in connection with the goods purchased and is in lieu of all other Warranties, expressed or implied, including but not limited to any implied warranty of merchantability, fitness for a particular purpose or fitness for use, and all other obligations or liabilities of TAEC, its successors or assigns.

Under no circumstances will the customer or any user or other person be entitled to any direct, indirect, special, consequential, or exemplary damages, for Breach of Contract, Tort, or otherwise. Under no circumstances will any such person be entitled to any sum greater than the purchase price paid for the product that is malfunctioning.

This warranty does not apply to expendable parts such as fuses, filters, removable media, and other such parts classified by Seller as expendable.

- All repairs will be performed at TAEC’s Repair facility, except for repairs made at the Purchaser’s site, as specifically agreed by TAEC in writing.
- Purchaser shall bear the cost of shipping to TAEC’s facility those items that fail while under warranty. TAEC shall bear the cost of return shipment to Purchaser’s facility.
- Repairs on products that fail during the new product warranty period are warranted for the remainder of the new product warranty period or 90 days, whichever is the greatest.
- The repair of product that failed after the expiration of the original warranty period is warranted for ninety days from the date the repaired item is shipped back to the customer.
- To obtain service under this warranty, the Purchaser must bring the malfunction of the Product to the attention of TAEC within the twelve (12) month period and no later than thirty (30) days after such malfunction, whichever occurs first. Failure to bring the malfunction to the attention of TAEC, within the prescribed time, will result in the Purchaser being not entitled to warranty service.

Force Majeure: Non-performance by Buyer or Seller shall be excused to the extent that performance is rendered impossible by war, fire, flood, earthquakes, labor disputes, acts of God or the public enemy, or acts of the Government or any other causes beyond the reasonable control of the non-performing party.

General Provisions: The terms and conditions of this Policy shall govern all Releases placed hereunder and implied on any purchase order or acknowledgment form issued by either Buyer or Seller. No other terms or conditions set forth on any purchase order or acknowledgment form shall be binding upon Buyer or Seller unless said terms and conditions are specifically accepted in writing by Buyer or Seller. The failure of Buyer or Seller to enforce at any time this Agreement shall not constitute a waiver of such provisions. If any provision or illegal, it shall be deemed severable from the other validity performance and construction of this Agreement shall be governed by the laws of the State of California. Seller agrees that the Equipment and Spare Parts furnished under this Policy are produced in compliance with all applicable requirements under Sections 6, 7, and 12 of the Fair Labor Standards Act as amended and all valid and applicable regulations and orders of the "Wage and Hour Divisions" issued under Section 14 thereof. Seller also agrees to comply with all provisions of the Equal Opportunity Law of the United States including Executive Order 11246.

Entire Policy: This policy constitutes the entire policy with respect to the subject matter hereof and shall supersede all previous proposals, both oral and written, negotiations, representations, commitments, writings, agreements, and all other communications between the buyer and seller. It may not be released, discharged, changed or modified, except by an instrument in writing signed by duly authorized representative of Toshiba America Electronic Components, Inc.

No person other than an officer of TAEC may extend or modify this warranty. no such modification or extensions are effective, unless it is in writing and signed by the Vice President, General Manager, Disk Products Division.



P/N 470073-B0

Free Manuals Download Website

<http://myh66.com>

<http://usermanuals.us>

<http://www.somanuals.com>

<http://www.4manuals.cc>

<http://www.manual-lib.com>

<http://www.404manual.com>

<http://www.luxmanual.com>

<http://aubethermostatmanual.com>

Golf course search by state

<http://golfingnear.com>

Email search by domain

<http://emailbydomain.com>

Auto manuals search

<http://auto.somanuals.com>

TV manuals search

<http://tv.somanuals.com>