

TOSHIBA

27/30WL46 Series

Owner's manual
Bedienungsanleitung
Gebruiksaanwijzing
Manuel de L'utilisateur
Manual de Instrucciones
Manuale di Istruzioni
Manual de Instruções



List of contents



Important Information	4
Special features	5
Safety instructions	6
Where to install	7
Getting started.....	8
Aerial connection.....	8
Switching on	8
Battery fitting	8
Control unit.....	9
Front and rear panel	9
Remote control.....	10
Using the TV	11
Tuning the TV	12
Automatic tuning.....	12
Manual tuning.....	13
Program sorting.....	15
TV setup	15
Sound menu	15
Sound Features	15-16
Picture menu.....	16-18
Features Menu	18-21
Using teletext	22-23
Connecting external equipment.....	24-28
Help and service tips.....	29
Technical specifications table.....	30

Important Information

The LCD display panels are manufactured using an extremely high level of precision technology, however sometimes some parts of the screen may be missing picture elements or have luminous spots. This is not a sign of a malfunction.

Please take note

EXCLUSION CLAUSE

Toshiba shall under no circumstances be liable for loss and/or damage to the product caused by ;

- i) fire;
- ii) earthquake;
- iii) accidental damage;
- iv) intentional misuse of the product;
- v) use of the product in improper conditions;
- vi) loss and/or damage caused to the product whilst in the possession of a third party;
- vii) any damage or loss caused as a result of the owner's failure and/or neglect to follow the instructions set out in the owner's manual;
- viii) any loss or damage caused directly as a result of misuse or malfunction of the product when used simultaneously with associated equipment;

Furthermore, under no circumstances shall Toshiba be liable for any consequential loss and/or damage including but not limited to the following, loss of profit, interruption of business, the loss of recorded data whether caused during normal operation or misuse of the product.

Stationary Image

If stationary images generated by teletext, channel identification logos, computer displays, video games, on screen menus, etc. are left on the TV screen for any length of time they could become conspicuous, it is always advisable to reduce both the brightness and contrast settings.

Cleaning the screen and the cabinet...

After turning off the power, clean the screen and the cabinet with a soft, dry cloth. We recommend that you do not use any proprietary polishes or solvents on the screen or cabinet as this may cause damage.

Disposal...

The cold cathode fluorescent lamp in the LCD panel contains a small amount of mercury, when the set reaches the end of its useful life please dispose of it in accordance with Local Government Regulations or at a recycling centre.

Television

Thank you for buying this television which is designed to give you many years of satisfactory service.

You may already be familiar with using a television but do please take time to read these instructions. They are designed to familiarise you with the unit's many new features and to ensure you get the very best out of your purchase.

Special features

- 16,722,216 color (8 byte)
- Available for Cable Channels (A decoder will be required)
- 2X10 W Stereo sound
- 800 page teletext
- PIP(Picture-in-Picture) Feature
- PAP (Picture and Picture) Feature
- Wide angle perspective
- 3 SCART sockets, AV Socket and external sound system connection
- Minimum energy consumption
- AVL - Automatic Volume Limiting
- ATS - Automatic Tuning System
- Blue back
- Intelligent program switch
- Programmed power on
- Programmed power off
- Graphic equalizer
- On screen viewing of all control commands, program numbers and additional features
- Manual Fine Tuning
- 100 Program memory
- Infrared Remote Control
- Panel lock
- DVI-D socket

Safety Instructions - For Your Safety

This equipment has been designed and manufactured to meet international safety standards but, like any electrical equipment, care must be taken if you are to obtain the best results and safety is to be assured. So, please read the points below for your own safety. They are of a general nature, intended to help you with all your electronic consumer products and some points may not apply to the goods you have just purchased.

Air Circulation...

Leave at least 10 cm clearance around the television to allow adequate ventilation. This will prevent the TV from overheating and consequential possible damage to the TV. Dusty places should also be avoided.

Heat Damage...

Damage may occur if you leave the TV in direct sunlight or near a heater. Avoid places subject to extremely high temperatures or humidity, or locations where the temperature is likely to fall below 5 C (41 F).

Mains Supply...

The mains supply required for this equipment is 110 –240 V AC 50 Hz. Use only the power cord supplied with the unit. Never connect to a DC supply or any other power source. DO ensure that the TV is not standing on the mains lead. DO NOT cut off the mains plug from this equipment, this incorporates a special Radio Interference Filter, the removal of which will impair its performance. In the UK, the fuse fitted in this plug is 5A, and is approved by ASTA or BSI to BS1362. It should only be replaced by a correctly rated and approved type and the fuse cover must be refitted. IF IN DOUBT PLEASE CONSULT A COMPETENT ELECTRICIAN.

Do...

DO read the operating instructions before you attempt to use the equipment.

DO ensure that all electrical connections (including the mains plug, extension leads and inter-connections between pieces of equipment) are properly made and in accordance with the manufacturers instructions. Switch off and withdraw the mains plug before making or changing connections.

DO consult your dealer if you are ever in doubt about the installation, operation or safety of your equipment.

DO be careful with glass panels or doors on equipment.

Do not...

DON'T remove any fixed cover as this may expose dangerous voltages.

DON'T obstruct the ventilation openings of the equipment with items such as newspapers, tablecloths, curtains, etc. Overheating will cause damage and shorten the life of the equipment.

DON'T allow electrical equipment to be exposed to dripping or splashing or objects filled with liquids, such as vases, to be placed on the equipment.

DON'T place hot objects or naked flame sources, such as lighted candles or nightlights on, or close to equipment. High temperatures can melt plastic and lead to fires.

DON'T use makeshift stands and NEVER fix legs with wood screws. To ensure complete safety, always fit the manufacturer's approved stand or legs with the fixings provided according to the instructions.

DON'T listen to headphones at high volume, as such use can permanently damage your hearing.

DON'T leave equipment switched on when it is unattended, unless it is specifically stated that it is designed for unattended operation or has a standby mode. Switch off using the switch on the equipment and make sure your family know how to do this. Special arrangements may need to be made for infirm or handicapped people.

DON'T continue to operate the equipment if you are in any doubt about it working normally, or it is damaged in any way – switch off, withdraw the mains plug and consult your dealer.

ABOVE ALL – NEVER let anyone, especially children, push anything into holes, slots or any other openings in the case – this could result in a fatal electric shock.

NEVER guess or take chances with electrical equipment of any kind – it is better to be safe than sorry.

TO FULLY DISCONNECT THE TV, THE MAINS PLUG IS USED AS A DISCONNECTING DEVICE AND THEREFORE SHALL BE READILY OPERABLE.

Where to install

Locate the television away from direct sunlight and strong lights, soft, indirect lighting is recommended for comfortable viewing. Use curtains or blinds to prevent direct sunlight falling on the screen.

Place on a sturdy platform, the mounting surface should be flat and steady. It should then be secured to the wall with a sturdy tie using the clip on the back of the television, or secured to the platform.

The LCD display panels are manufactured using an extremely high level of precision technology, however sometimes some parts of the screen may be missing picture elements or have luminous spots. This is not a sign of a malfunction.

Make sure the television is located in a position where it cannot be pushed or hit by objects, as pressure will break or damage the screen, and that small items cannot be inserted into slots or openings in the case.



Getting started

Remove your Television carefully from the box. You may wish to store the packaging for future use.

In the box

Inside the carton box you should have:

- Accessories box
- Power cord
- Remote control
- Batteries

Note: Scart, DVI, VGA and RCA leads are not supplied.

Read these instructions before use.

Aerial connection

To connect an aerial, plug the aerial lead into the aerial socket on the rear of the TV.



You can use an outdoor or indoor aerial. However, if you use an indoor aerial the quality of the reception may be reduced and adjustment of the aerial may be required when changing programs.

Please note

If you live in a poor reception area or use an indoor aerial you may experience loss or corruption of teletext transmissions.

Switching on and First Use

1. Connect the power cord plug to the mains socket.
2. Connect the input socket of the power cord to the power socket at the back panel of the LCD TV

Note 1: Your TV will go to stand-by mode in five minutes if there is no broadcast signal.

Note 2: Your TV is equipped to operate with front panel buttons, "MENU", "←", "→", "P", "▲", "▼", "□", "△" in case your R/C is broken or the batteries are exhausted.

Please Note

When not in use disconnect the mains plug from the mains supply.



3. Press the **Power** button on the bottom of the TV. The standby indicator will be red.

4. Press a **Numeric** button or the P▲ or P▼ button on the remote handset or ▲/▼ or **MENU** button on the top of the TV to switch the TV on. The standby indicator turns blue. The picture will appear after a few seconds.

Please Note

Do not leave the television in standby unattended or overnight.

Switching the TV on for the first time

To install your TV, please read the sections "TV controls" and "Tuning the television".

The batteries

Remove the back cover to reveal the battery compartment and make sure you insert the batteries the right way round.

Suitable battery types for this remote are UM-4, IEC R03 or AAA 1.5V.

Do not throw your old batteries into a fire, dispose of them in a designated disposal area.

Do not combine a used, old battery with a new one or mix battery types.

The performance of the remote control will deteriorate beyond a distance of 8 metres or outside an angle of 30 degrees from the centre of the TV.

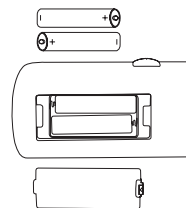

Control Unit

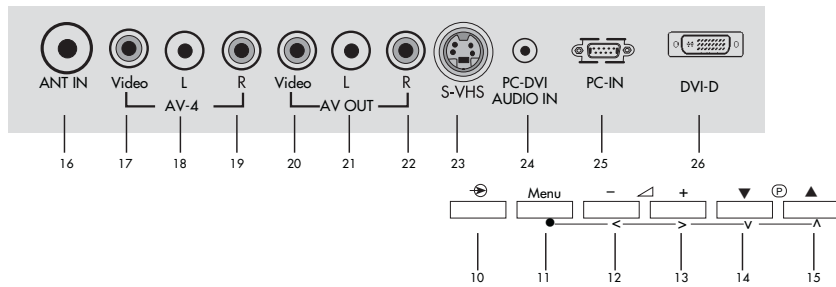
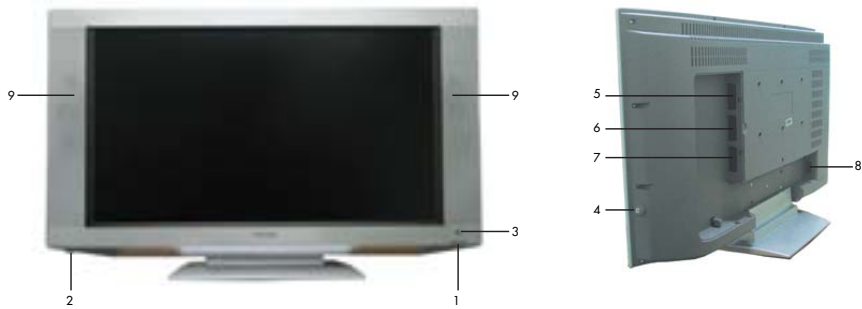

- | | |
|--------------------------|---|
| 1. Stand-by | 15. Program up |
| 2. Power on / off | 16. Antenna input |
| 3. Remote control | 17. Video input Phono connector |
| 4. Headphone jack | 18. Phono Connector (L) |
| 5. Scart (EXT1) | 19. Phono Connector (R) |
| 6. Scart (EXT2) | 20. Video output Phono connector |
| 7. Scart (EXT3) | 21. Audio RCA output (L) |
| 8. Power Input | 22. Audio RCA output (R) |
| 9. Speaker | 23. S-VHS |
| 10. Source Select | 24. PC sound input |
| 11. Menu button | 25. VGA |
| 12. Volume down | 26. DVI-D |
| 13. Volume up | |
| 14. Program down | |

Please note

- Do not use Video RCA and S-Video connections at the same time, otherwise they will effect the picture.
- RGB inputs from scart will give you better picture quality.

Remote Control

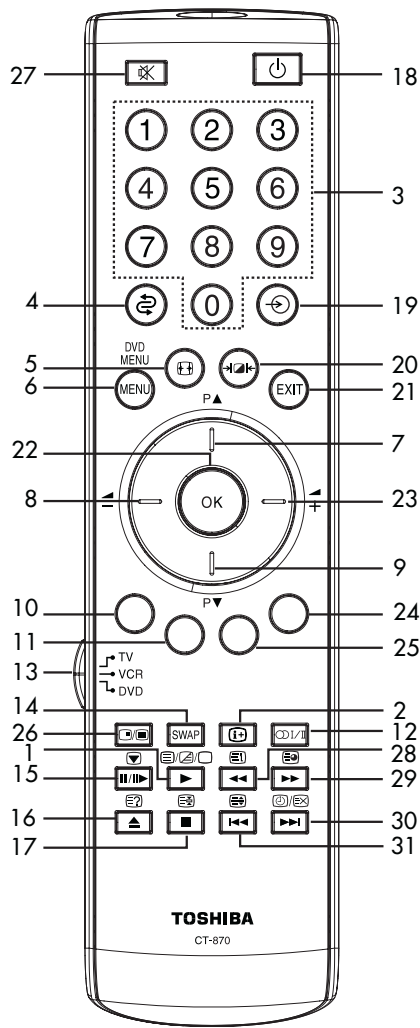

1. Teletext / TV Mix / TV choice buttons
2. Info / Txt index page button
3. Numeric buttons
4. Return to Selected Program Button (⊕)
5. Picture Mode button
6. MENU button
7. Upward movement (P▲) (Menu)
8. Left movement (◀) (Menu)
9. Down button (P▼) (Menu)
10. Red Fastext Button
11. Green Fastext Button
12. Sound Type / Language choice button (⊕/⊖)
13. RC mode choice button
14. No function at tv mode
15. No function at tv mode
16. Txt Question/Answer button (Reveal)
17. Txt Stop Button (Hold)
18. Stand-by On/Off button
19. External Input select button
20. Picture Format choice button
21. Exit button
22. OK button
23. Right button (▶) (Menu)
24. Blue Teletext Button
25. Yellow teletext Button
26. PIP-PAP mode enter/exit button
27. Mute button (⊘)
28. No function at tv mode
29. No function at tv mode
30. Teletext Time
31. Teletext enlarge button (DoubleSize)

Using the TV

Turning on for the first time and Tuning

TV Controls

Temporary On-Off (STAND-BY)

When you press the red (⏻) stand-by button (temporary on-off function) located on the upper right hand side of your remote control of your television when it is switched on; In that case, the power indicator of your television will flash Red. To switch your television back on, either press the same button, any of the number buttons or one of the (P▲)/(P▼) buttons.



Caution!
If you are not going to use your television for a long period of time, make sure to switch it off from the main power button.

Programme selection

Press the (P▲)/(P▼) buttons on your remote control, or by selecting a numeric button in order to get the desired channel on your television. In order to select a program whose number is greater than 9, you can use the numeric buttons, punching in the desired numbers as required. For example, to select program 12, press the numeric buttons 1 and 2 one after another.



Mute



To temporarily mute the sound of your television, press the (⊘) button, where the **Sound mute** on screen display will appear on screen as an indication of the application. When you press the same button again, the sound will return. During mute, when you press the (⏪) button the volume will decrease and automatically get out of the mute function if you press the (⏩) button the volume will increase and automatically get out of the mute function.

Return to Selected Button Program (SWAP)



If you wish to return to the previous program that you were watching then you have the ability to return with a single function, by pressing the SWAP button. Regardless of whether you are at AV, or any other program, by using the SWAP function allows you to swap between the program you were watching and the last selected program. If you hit the same button again, you will return to the program or AV you were watching before.

E.G. 3 → (↺) 11 → (↺) 3

External Device



The television has 3 SCART connections. After every time you press the AV button, the input settings change as follows.

1. EXT1 when using SCART socket 1 (with RGB support)
2. EXT2 when using SCART socket 2 (with RGB support)
3. EXT3 when using SCART socket 3
4. EXT4 when using RCA socket
5. EXT5 when using S-Video socket
6. in PC mode
7. in DVI mode.

You can return to TV mode by pressing "⊙" button again.

Program tuning and saving into memory

You can either tune the programs automatically or manually and storing them in your television. As a result of your television's Automatic Tuning System (ATS), the programs found are automatically ordered in accordance to the selected country channels that send their title and teletext information, followed by those programs that do not.

Please note: In the case that your television does not receive any broadcast signals for 5 minutes it will automatically go to stand-by. The 5 minute countdown OSD will be on screen.



Tuning The TV

Automatic tuning and storing of the television program channels

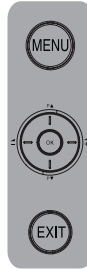

In the SETUP menu select the country of which you want to watch the program with priority by pushing the Right/Left movement button (←/→) in the Language bar. Afterwards press the down (↓) button to change the Country setting. Later choose Auto Tuning and press "OK" or the Left/right (←/→) buttons. You will see a warning sign before Auto Tuning starts. To start Auto Tuning press the "OK" button; the channels will be searched automatically and those broadcasting will be saved from the first programme into memory. At this point, the auto program menu appears showing an indication that displays the position of the auto tuning bar and the auto program operation as well as the system, channel number of the existing channels and, if present, their name information. To stop the process at any given time, press the "EXIT" button. The program numbers that have been stored are reflected in the Programme Sort, giving you the ability to assign any program number to the channel of your choice.



Manual Tuning

TV channel search by user and saving to memory

If you do not know the Channel number

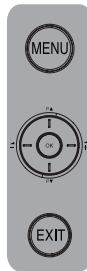

By pressing the MENU and (↔) buttons of your remote control, you will bring up the SET UP menu on your television screen. Using the down button (P▼) on your remote control, highlight the Manual Tuning bar in yellow and press "OK" or the left/right motion (←/→) button. The Manual Tuning menu will appear on the screen. Use the (P▲) and (P▼) or number buttons to manually tune your desired program and press OK. The screen will show the Manual Tuning menu. Choose with the pressing of the right move button (→) the program and systems you want to make a search in between the Program number, Color System and System lines.

Here your TV can be set to one system, you can also select from more than one systems with the (P▲) and (P▼) buttons. (option) access the Search bar using the right button (→). Scan the channels using the (P▲) and (P▼) buttons. If the program on the screen has the desired quality store it in the memory pressing the OK button. Repeat the same operation for the next program. If you need to do Manual Fine Tuning on the current channel or to name the current channel refer to the related parts.



If you already know the Channel number

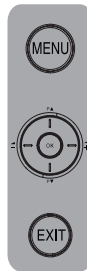

By pressing the MENU and (↔) buttons of your remote control, you will bring up the SET UP menu on your television screen. Using the down button (P▼) on your remote control, highlight the Manual Tuning bar in yellow and press "OK" or (↔) button. The Manual Tuning menu will appear on the screen. Select the desired program by using the (P▲) and (P▼) buttons and press the OK button. The menu for the Manual Tuning will be on screen. Access the System bar using the right button (→). Here your TV can be set to one system, you can also select from more than one systems. (option) Select the Channel Band bar pressing five times the right button (→). Using the Up (P▲) or down (P▼) direction buttons select S for Cable channels and C for terrestrial programs and press the right (→) button. Here you can directly enter the channel number using the numbering buttons on remote control, you can as well scan the channels in the ascending or descending order using the up (P▲) or down (P▼) direction buttons.

If the program found on screen is acceptable in quality, then press the OK button to store it in the memory and repeat the same operations for the next channel.

If you need to do Manual Fine Tuning on the current channel or to name the current channel refer to the related sections.

To leave the "MENU" and menus to return to the previous menu for any reason press the EXIT button.

Fine Tuning

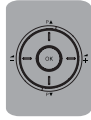

If the current channel requires fine tuning, skip the Manual Fine Tuning bar using the right (→) button on the Manual Tuning menu. Using the up (P▲) and down (P▼) movement (↔) buttons on your remote control, adjust the program on the screen to the quality you wish. Under normal conditions you will not need Fine Tuning. Your television will automatically lock channels, which need AFC values. However, in the event that the TV transmitters do not work, then you may need to use this process. For storing the settings to the memory press OK button.



Program Skipping

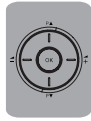

If you want to skip some of the channels in the memory while selecting program with (P▲) and (P▼) buttons, select the Program Skip bar using the right button on the Manual Tuning menu. Using the Up (P▲) and down (P▼) buttons, the program for which you select "⏮" mark will be skipped.

Naming Stations

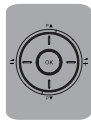

If you wish to assign an 8-character labelling to the channels in the memory, select station bar using the right button (→) on the Manual Tuning bar. You can choose a letter using the Up (P▼) and Down (P▲) buttons and a section with the direction (↔) buttons. After the process press the "OK" button. The changes you made are now stored. You can assign labelling to the next programme in the same way.

Manual Setting (For AV/PC Modes)

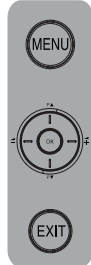

To give names in the AV or PC mode, use the MENU and (→) buttons on the remote control, to bring the SETTINGS menu on screen Using the down (P▼) button on your remote control, yellow highlight the Manual Setting selection and press "OK" or the right/left (↔) buttons.

The Manual Tuning menu will appear on the screen. Using the right (→) button select the Station line. Using the Up (P▲) and down (P▼) buttons to select the desired letter and the direction (↔) buttons for the desired column. Press the "OK" button after you are done. Changes are stored in memory.



Please note: In Manual Setting selection you can only make adjustments in AV or PC mode you are in. To make changes in the AV or PC mode, enter the Manual Settings menu, which becomes active after you enter these modes.

Programme Sorting

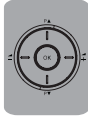

In the Setup menu use the down (P▼) button to select the Programme Sorting line and press "OK" or the left/right (←/→) button.

The Programme Sorting menu will be shown on screen. Please select your desired program using the (P▲) and (P▼) buttons, then press the OK or right (→) button. Match the program you have selected using the (P▲) and (P▼) buttons with the program number you want. To complete the operation press again the "OK" button. You can switch the next program you wish to another program number in the same way.



AV Connection

In the Setup menu use the down (P▼) button to select the AV Connection line and press "OK" or the right/left (←/→) buttons. The AV Connection menu will be on screen. You can change the output from your television of the devices you are going to connect to SCART2 and SCART3 through this menu. When you choose the TV feature; the audio and video of the program you are watching is transferred.. When you choose *NONE*, SCART2 and SCART3 outputs will be cancelled.



Quick Setup



In the Setup menu use the down (P▼) button to select the Quick Setup line and press "OK" or the right/left buttons. The Quick Setup menu will be on screen. Here, after making your Language and Country choice and pressing the OK button, Auto Tuning will become active. The channels will be searched automatically and those with broadcasting will be saved from the first program into memory. At this point, the auto program menu appears showing an indication that displays the position of the auto tuning bar and the auto programme operation as well as the system, channel number of the existing channels and, if present, their station name. To stop the process at any given time, press the "EXIT" button.



The setup of your television Setting up the Sound Menu

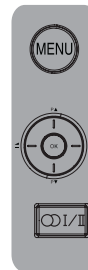

You can set the volume with the "+" and "-" buttons on the television or the (←/→) buttons on the remote control. You can control the other sound settings by entering the Sound menu For this application all you need to do is press the MENU button of your remote control. Press the "OK" or (P▼) button selecting the direction button on the Sound menu bar The Sound menu appears on the screen. Using the up/down movement buttons (P▲/P▼) you can choose the features that you require.

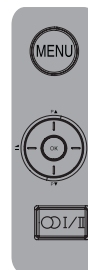
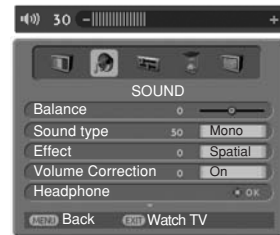

Balance: To adjust the volume balance between the left and right speakers to the desired level, select the Balance bar using the down (P▼) button. Using the right/left movement (←/→) buttons adjust the balance.

Sound Type: The program you watch might be stereo or in two different languages. Using the right/left keys (←/→) in this menu you can select Mono/Stereo or Dual-I/Dual-II language.

Note: You can make this selection without entering the menu with the (ODI/I) button on your remote control.

Effect: If you want to add depth to the sound of the program you watch, select Spatial with the (←) button.

Volume Correction

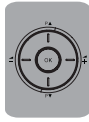

Television transmitters have different sound levels. This can be noticed from the different volume levels that can be heard while switching from one program to another. Using the right/left movement (←/→) buttons switch to Open. The AVL (Automatic Volume Limiting) function maintains the same sound level as you switch from program to program. To cancel choose Closed.

Headphones

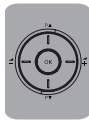

By connecting the headphone unit to your television you can listen to the program sounds independently from your television. In order to increase and decrease the sound level of the headphones, you can enter the HEADPHONES menu and make the necessary adjustments using the (←) and (→) buttons in the Volume bar. When you only want to hear the sound from the headphone, just press button.

Balance: To adjust the volume balance between the left and right headphone to the desired level, select the Balance bar using the down (P▼) button. Use the left/right button (←/→) to make adjustments.

Bass: You can adjust the bass levels of the sound you hear in the headphone.

Treble: You can adjust the treble levels of the sound you hear in the headphone.

Sound Type: The program you watch might be stereo or in two different languages. Using the right/left keys (←/→) in this menu you can select Mono/Stereo or Dual-I/Dual-II language.

Please note: The sound and headphone adjustments made will be stored without any additional transactions necessary.



Equalizer

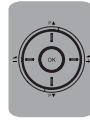

Selecting the Equalizer mark press "OK" or (P▼) button. The equalizer setting function will be displayed. You can selected with the right/left (←/→) buttons, pre-programed, unchangeable sound enhancing Music, Sport, Cinema and Speech settings for the programs you are watching. These can be adjusted by you in the User selection. To adjust the User selection; select the User selection and press the (OK) button. You can adjust the frequency levels with the (P▼) and (P▲) buttons. You can select 120Hz, 500Hz, 1.5KHz, 5KHz and 10KHz frequency bands with (←) and (→) buttons. Storing the adjustment levels in memory press the menu button to exit the user option. You can exit the equalizer function pressing the "EXIT" button at any time.



Picture Set up

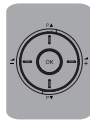

By pressing the MENU and "OK" or (←) button on your remote control please enter the Picture menu. Select the setting function you want using the Up and down buttons (↑/↓). The picture brightness, contrast, color and sharpness levels can all be adjusted according to your desire. The changes you make in the picture settings will be automatically stored without any further transactions necessary being your Personal settings. Furthermore, you can select one of the non-adjustable default settings in the memory (Picture Mode) by pressing the (→) button on your remote control. Picture Mode 1, 2 and 3 are preset values. Picture Mode M is the value you store in the memory.



Widescreen viewing

Depending on the type of broadcast being transmitted, programmes can be viewed in a number of formats. Press the  button repeatedly to select between **Super live, Cinema, Subtitle, 14:9, Wide** and **4:3**. Please note: Whenever the **MENU** button is pressed the picture size setting will change while the menus are ON the screen. This is to ensure that the menus do not overlap the edges of the viewable area.

AUTO: Automatic format selection dependant on transmission.

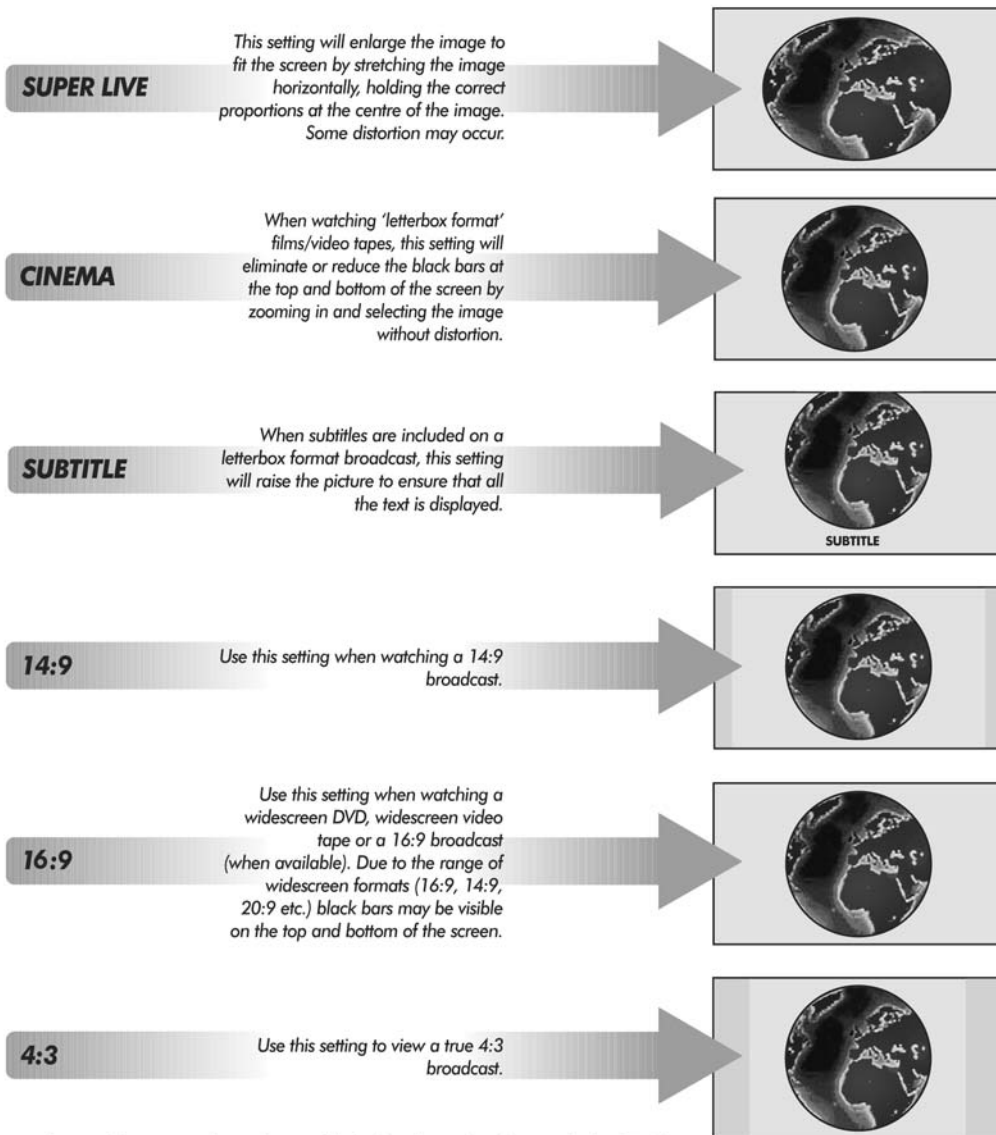

Using the special functions to change the size of the displayed image (i.e. changing the height/width ratio) for the purposes of public display or commercial gain may infringe on copyright laws.

Features

Automatic Size



Some channels broadcast with the program also size information. If you choose Open for the Automatic Size feature the TV will adjust to the size information broadcasted. To detect Automatic Size, the screen setting needs to be at Auto Mode. Your television is in the picture format of 16:9. However, for the programs that do not send automatic format information, you can change the format of the program you watch with the (F) button on the RC.



Blue Screen: If you chose this feature to be On, you will see a blue screen instead of static on channels without broadcasting.

Color Tint

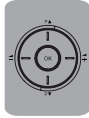

When NTSC video is used in SCART, Color Tint settings can be made. If you do not use such a video type the Color Tint choice is seen in the menu, but Up/down (▲/▼) buttons cannot be used to select it. If NTSC video is used in SCART this choice becomes active and can be changed.

DNR: This feature improves noise on picture with three levels. Dynamic Noise Reduction can be selected with 4 settings; Off-Soft-Sharp-Sharpest. If "Off" item is selected, no noise reduction is applied on picture.

Black Stretch: Black Stretch enhances the contrast of the picture. The dark regions of the picture are made darker, while bright areas remain unchanged.

Luminance Peaking: The Luminance Peaking improves the overall frequency response of the luminance. It creates blacker blacks and whiter whites.

Color Temperature

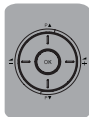

To adjust the color temperature while watching TV select this feature and use the right/left (←/→) button to select Normal, Tepid or Cool. Changes are stored without any further action.

Zoom

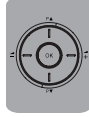

In the picture menu select the Zoom selection and press OK to enter this menu. When you enter this menu you will see in the lower right corner of the screen the Zoom sub-menu. Using the Up/down (▲/▼) buttons you can enlarge or shrink the image in 20 steps. During the Zoom process the image will be enlarge focused on the center. In this case if you want to move the image up/down or right/left press the OK button on your remote. Later use the directional buttons to move around. If you want to exit the Zoom menu at any time press the MENU button.

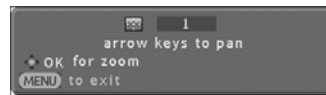

Special Features Timer

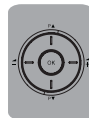

Select the Timer bar in the menu and press "OK" or (↵) button. The Timer menu will be on screen. This function will enable you to open and close your television automatically.

Select the Switch-off Time and press the OK button. The changeable number will appear grey. Enter the hour and minute for which you can set 12 hours 59 min. at most using the numerical buttons on the RC. Your TV will automatically switch to standby at the end of this period. In the event that you wish to exit the application at any given stage, simply press the MENU button.

On Timer: Select the Switch-on Time and press the OK button. The changeable number will appear grey. Enter the hour and minute for which you can set 12 hours 59 min. at most using the numerical buttons on the RC. Your TV will be turned on with the program automatically selected on standby at the end of this period.



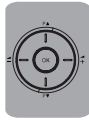

If any of the Timers is activated, the Green coloured light on the front side will flash.

Please note: If you turn your television off from the main power supply switch then the sleep timer modes selected will be reset and cancelled.

In Timer Mode: Use the right/left (←/→) buttons to select the program you want the TV to open when switching on.

Feature

In the MENU select Feature and press "OK" or (P▼) button . The Feature menu will be on screen.

Teletext

Select the teletext bar using the "OK" or down button in the setup menu. To right (→) button; If you choose Automatic; Fasttext or Toptext (option) features can be determined for the channels with txt broadcasting. When list is selected, if the current channel does not broadcast Fasttext or Toptext, you can store the teletext page numbers you want with the colour buttons or (P▲) and (P▼) buttons in the section there are 4 different colour buttons when you select teletext. While in the other pages of teletext, you can directly access this page you selected by pressing the colour button linked to them.



Panel Lock

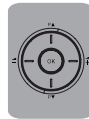

If you switch this feature On, the button on the TV will not work when the TV is in Stand-by mode and screen will show a Panel Lock warning. In addition if the Panel Lock is On, the TV will not switch on with the (P▲) and (P▼) buttons from stand-by mode.

Back Lighting: Using this feature you can increase or decrease the panel light.

PIP Usage (Picture in Picture) Feature

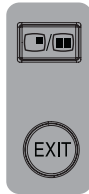

1. Press the PIP button on your remote control.
 2. A picture will open in main picture and will position itself in the lower screen.
 3. If you press the PIP button again, you will enter the PIP mode in which the main picture and the PIP picture will be shown in equal size.
 4. If you press the PIP button the third time, the window will close and you will have exited this mode.
- Note:** If you want to exit the PIP mode at any time press the EXIT button.



PIP Menu



In the Features menu select PIP and press the OK button or the right/left (←/→) buttons. The screen will show the PIP menu.

Note: This menu is only available in the features menu if the PIP is active.

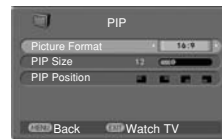

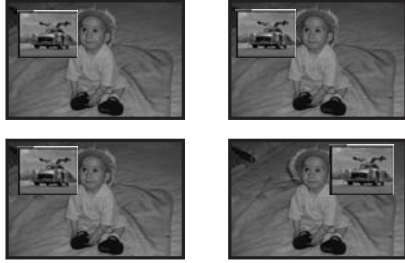

Picture Format

To change the PIP Picture Format select this feature and press the right/left (←/→) buttons. PIP window can be watched in the 4:3 or 16:9 format.



PIP Size

 This feature enables you to resize your PIP window. Press the right/left (←/→) buttons after you yellow highlighted the PIP Size selection. After you resized your PIP window you can exit the menu by pressing the EXIT button of the remote control.





PIP Position

 This feature enables you to position your PIP window. Press the right/left (←/→) buttons after you yellow highlighted the PIP Position selection. After you positioned your PIP window you can exit the menu by pressing the EXIT button of the remote control.







Entering PIP Mode

 Pressing the PIP button on the remote control will bring the PIP window on screen. If the same button is pressed a second time you will enter the PAP mode.



Entering the PAT Mode

When the PIP button is pressed during Teletext mode you will enter the PAT mode. To exit this mode you only need to press the PIP button or the EXIT button.

Selecting PIP Channel

 Swap PIP picture with main picture.

Introduction

Because your 27" - 30" LCD-TV equipment is provided with VGA inputs, it may be used as a PC monitor as well. (Plug&Play)

Transition to the PC mode

To change your LCD-TV into monitor (PC) mode you have to press 6 times the "⊙" button on the remote control or press the OK button to select the PC choice in the line-up menu on screen and press OK to access it directly. To change back from the PC mode to the TV mode use the EXIT button on the remote control.



PC Input Setting

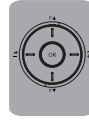

While in PC mode, use the down (P▼) button in the Setup menu to select the PC Input Setting and press "OK" or left/right (←/→) .The PC Input Setting menu will be on screen. In this menu you can make the desired changes with Left-right, Up-down motion (←/→) (P▼/P▲) buttons on your remote control.

H.Position: Horizontal position setting.

V.Position: Vertical position setting.

Phase: ADC's phase setting.

Automatic configuration: The most suitable geometric settings in accordance to the entry mode is configured by this function. For this application, choose the AUTOMATIC CONFIGURATION option and press the OK button.

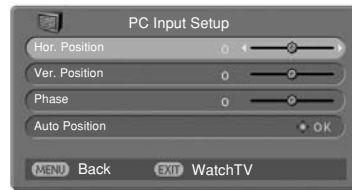

Using Teletext

Teletext is an information system that displays text on your TV screen. Using the teletext control buttons you can view pages of information that are listed in the teletext index.

Please Note

No On Screen Display is available in text mode. The contrast, brightness and colour cannot be changed but the volume adjustment is still available.

To enter Text mode Please Note

Make sure the TV channel you are watching transmits teletext. If not a NO TEXT sign will be shown on the screen.



Press the  button. The text page will appear, normally the index page.

To exit Text mode



Press the  button twice. This will return to the channel you were watching.

To select a page of text



Find the number of the page in the index and enter it using the **Numeric** buttons. The number of the page will appear in the top left hand corner of the screen.

The page counter will search for your page. When it finds it, the page will be displayed.



To move to the next page of text press the (P▲) button.

To move to the previous page press the (P▼) button.



To return to the index page press the (Ei) button.

TV/text mix



To view a TV programme whilst in text mode, press the  button. The text will be superimposed over the TV programme.

Page search whilst watching TV



In Text mode press the  button. The TV will return to TV mode with the text page number in the top left hand corner of the screen.



Enter the page number you want using the **Numeric** buttons.



The top line of the text page will appear whilst the text searches for your page. When the page is found the number will remain in the top left hand corner of the screen.



Press the  button to view your selected page of text.

Double height text



If you have difficulty reading the text on the TV you can double the height of the text.



Press the  button. The top half of the page will be displayed in double height text.



Press the  button again. The bottom half of the page will be displayed in double height text.



Press the  button again to return to the full page in normal text.

Page Stop



If the page of text you have selected contains sub pages, these sub pages will automatically be displayed in order with a delay to allow you to read the page.

To stop the move to the next sub page press the () button. STOP will appear in the top left hand corner.



To continue moving through the sub pages press the () button again.

To select a sub page



If the page of text you are viewing contains sub pages, the number of the sub page you are on and the total number of sub pages is displayed on the right of the screen i.e. 1/7.

To select a sub page press the () button. Press the green button to select next sub-page or press the red button to select the previous sub-page.



Enter the number of the sub page, using the **Numeric** buttons in the format S0001 for sub page 1.

The teletext will search for the sub page. This may take some time. To return to the TV whilst the teletext is searching press the () button.

When the page number is found it will appear in the top left hand corner of the screen.



Press the () button again to view the text page.

To reveal information



Press the () button to reveal concealed information (quiz answers etc.).



Press the () button again to conceal the information again.

Clock



Press the () button, whilst watching a TV program , to display the time.

Press the () button again to remove the displayed time.

Fast text

At the bottom of the teletext screen is a row of subject headings in red, green yellow and blue.

The remote control has a row of coloured buttons corresponding to the row of coloured subjects on the screen.

Pressing one of the coloured buttons will take you directly to the page corresponding to the subject heading.

Connecting external equipment

You can connect a wide range of audio and video equipment to your TV.

Connecting a video recorder

① Via SCART

Make sure the TV and video recorder are both switched off. Plug one end of the SCART lead (not supplied) into the back of the video recorder and the other end into one of the SCART sockets on the back of the TV.

Switch on the video recorder and the TV.



Press the  button on the remote control to select EXT1, EXT2 or EXT3 correspond with the SCART socket you are using on the back of the TV.

Please note:

You can connect RGB external equipment via Scart. It is necessary to you use a full Scart cable for this purpose.

Select the video output of the external device by using its menu, and set to RGB.

② Via RCA lead

Make sure the TV and video recorder are both switched off.

Plug one end of the RCA lead into the video and audio out sockets on the back of the video recorder and plug the other end into the video and audio in sockets of the TV.

If the sound is mono, use the Audio Input L. and in the SOUND menu select the MONO feature.

3 Via aerial socket

Make sure the TV and video recorder are both switched off.

Unplug the aerial lead from the TV and plug it into the aerial socket on the video recorder.

Plug a coaxial plug into the RF out socket on the rear of the video recorder and plug the other end into the aerial socket on the TV.

Switch on the video recorder and the TV. If your video recorder has a test signal, switch it on. (Refer to the video recorder user guide).

See 'Tuning the TV' and carry out the tuning procedure for the video recorder test signal. Select a programme number 0.

4-5 Via RCA lead and S-Video socket

You can also connect it through the S-Video socket of the TV.

Plug the S-Video plug into the S-Video socket and the audio leads into the audio sockets.

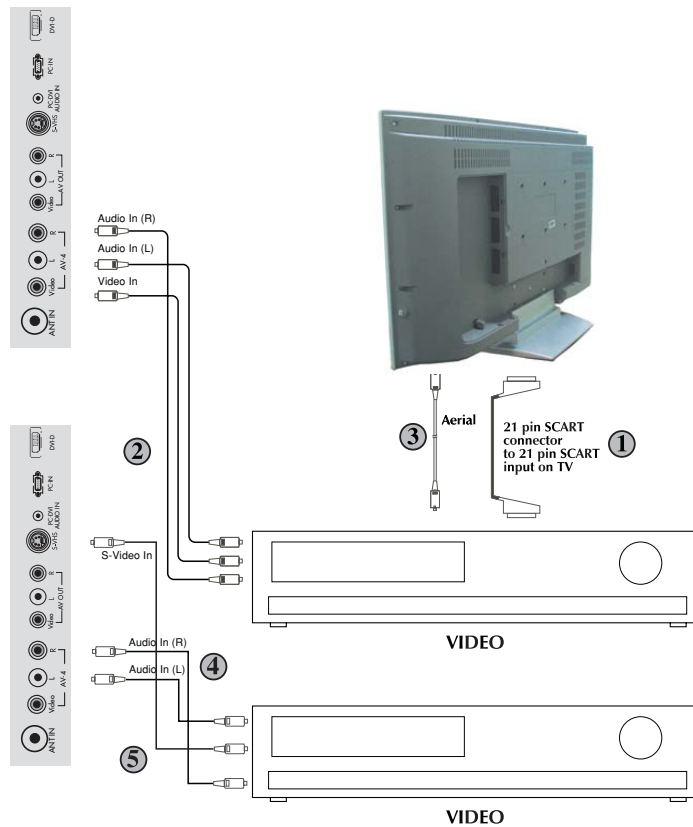

Connecting a DVD player

① Via SCART

Make sure the TV and DVD player are both switched off.

Plug one end of the SCART lead (not supplied) into the back of the DVD player and the other end into the SCART socket on the back of the TV.

Switch on the DVD and the TV.

② Via RCA lead

Make sure the TV and DVD player are both switched off.

Plug one end of the RCA lead into the video and audio out sockets on the back of the DVD player and plug the other end into the video and audio in sockets of the TV.

③ Via RCA lead and S-Video socket

You can also connect it through the S-Video socket of the TV.

Plug the S-Video plug into the S-Video socket and the audio leads into the audio sockets.

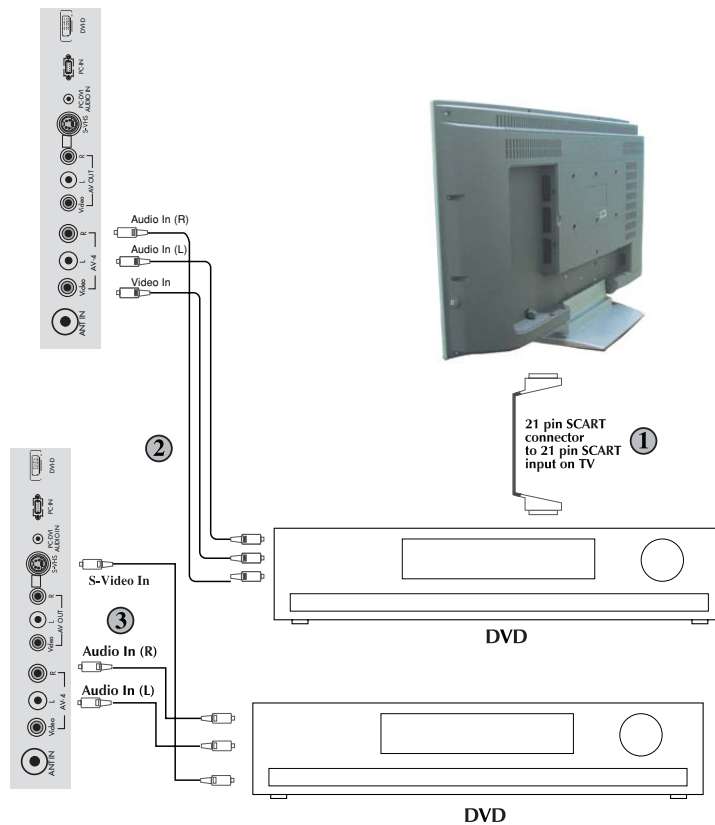

Connecting a decoder

Via SCART

Make sure the TV and decoder are both switched off.

Plug one end of the SCART lead (not supplied) into the back of the decoder and the other end into the SCART on the back of the TV.

Switch on the decoder and the TV.



Press the  button on the remote control to select EXT1.

② Via RCA lead

Make sure the TV and decoder are both switched off.

Note: For Decoder connection Via RCA lead your Decoder device must have the tuner built in.

Plug one end of the RCA lead into the video and audio out sockets on the back of the decoder and plug the other end into the video and audio in sockets on the TV.

Connecting DVI-D

Your TV has DVI-D input socket. You can connect any device such as PC etc. which has DVI digital out using the proper cable. At the same time you can listen to the sound from the connected device. PC or DVI use a special cable to PC-DVI/AUDIO IN input at the back of your TV.

AV Outputs

You can connect any device which is proper to Phono inputs via Phono Video and Audio Outs at the back of your TV set using proper AV cable (not available with the set).

Any programme or AV input which is seen on the main screen other than S-VHS, PC or DVI (which is option) is available as picture and sound signals at Phono Video/Audio outs.

Scart sockets at the back of your TV set are always give the signals of selected programme from the set Tuner.

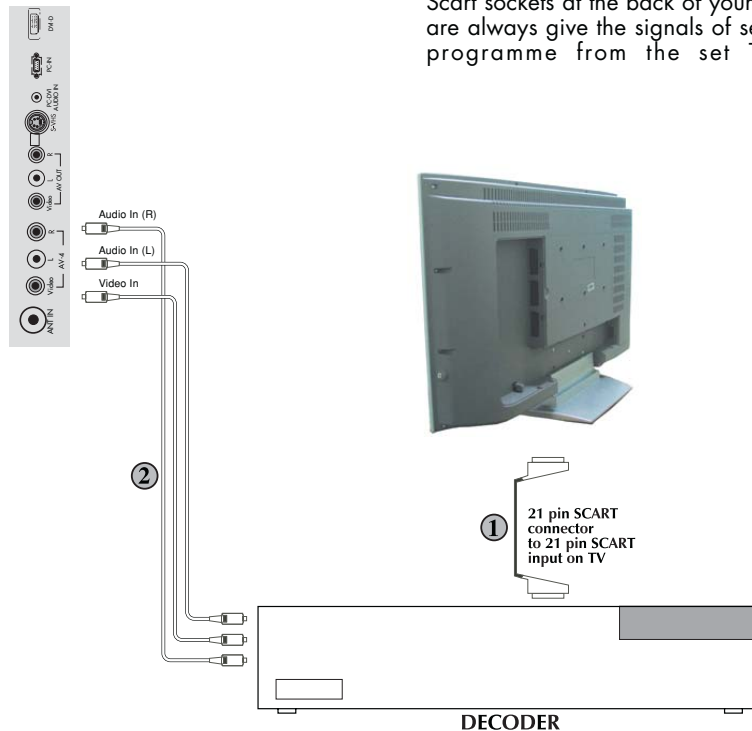

Connecting TV with video and satellite/digital receiver

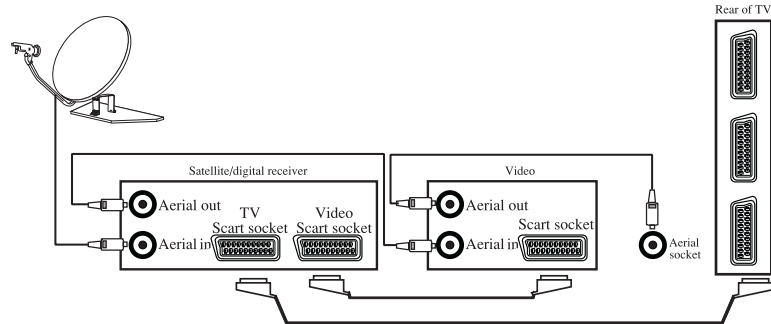

Connecting TV with camcorder

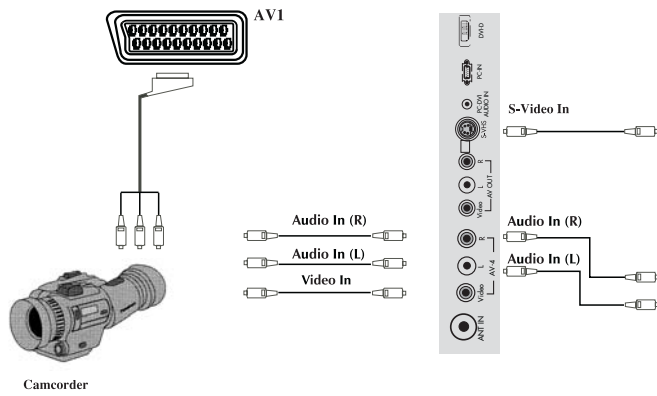

Connecting TV games and computer

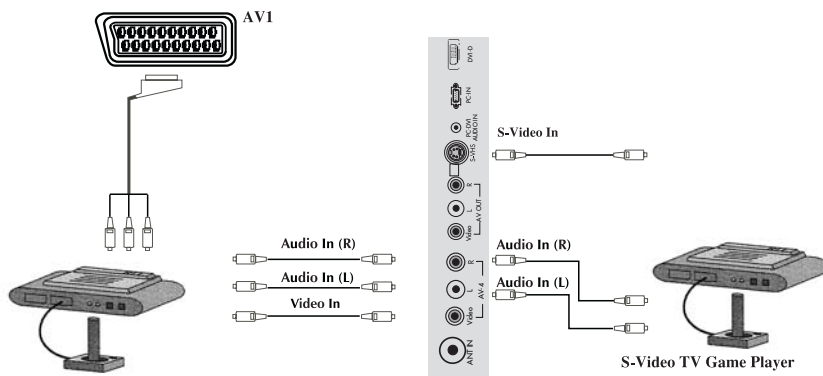

Help and service tips

The TV does not work

Make sure it is plugged into the mains supply and switched on.

Poor picture

- Is the aerial plugged in?
- If you are using a set top aerial is it properly aligned for the best signal.
- Make sure the aerial is not too close to neon lights, loudspeakers etc.
- Try changing the direction of the outdoor aerial. High buildings and mountains can cause ghost pictures or double images.
- The picture quality may be reduced by connecting two external sources at once. Disconnect one of the sources.
- Adjust the fine tuning.

No picture

- Is the aerial plugged in properly?
- Is the aerial lead damaged?
- Are all the plugs in the aerial lead fitted correctly?
- Have you pressed the correct buttons on the remote control

No sound

- Is the sound muted? Press the Mute button.
- Is the volume turned down?
- Are there headphones connected?

Sound coming from only one speaker

- Is the balance set to one side? See the sound menu.

No response to the remote control

- Try changing the batteries.
- Is there an obstruction between the remote control and the sensor on the TV.

If nothing works

If you have tried the above solutions and none seem to work, try switching the unit off and on again.

If this does not work contact your supplier or TV repair technician. Never attempt to repair a defective TV yourself.



Symptoms	Solutions	Check if on/off switch is "on"	Try a different channel. If OK, probably station trouble	Check aerial connections on back of set	Check aerial broken wires	Re orientate aerial	Probably local interference, such as an appliance	Adjust fine tuning control	Adjust brightness control	Adjust contrast control	Check if station is broadcasting colour	Adjust colour control	Check batteries in the remote control handset.	Switch the TV set OFF and ON from mains
No picture, no sound		✓	✓	✓	✓	✓	✓	✓	✓	✓	✓	✓	✓	✓
Poor sound, picture OK		✓	✓	✓	✓	✓	✓	✓	✓	✓	✓	✓	✓	✓
Poor Picture, sound OK		✓	✓	✓	✓	✓	✓	✓	✓	✓	✓	✓	✓	✓
Weak picture		✓	✓	✓	✓	✓	✓	✓	✓	✓	✓	✓	✓	✓
Blurred picture		✓	✓	✓	✓	✓	✓	✓	✓	✓	✓	✓	✓	✓
Double image		✓	✓	✓	✓	✓	✓	✓	✓	✓	✓	✓	✓	✓
Lines in picture		✓	✓	✓	✓	✓	✓	✓	✓	✓	✓	✓	✓	✓
Distorted picture		✓	✓	✓	✓	✓	✓	✓	✓	✓	✓	✓	✓	✓
Weak reception on some channels		✓	✓	✓	✓	✓	✓	✓	✓	✓	✓	✓	✓	✓
Horizontal bars		✓	✓	✓	✓	✓	✓	✓	✓	✓	✓	✓	✓	✓
Picture rolls vertically		✓	✓	✓	✓	✓	✓	✓	✓	✓	✓	✓	✓	✓
Poor colour		✓	✓	✓	✓	✓	✓	✓	✓	✓	✓	✓	✓	✓
No colour		✓	✓	✓	✓	✓	✓	✓	✓	✓	✓	✓	✓	✓
Remote control not working		✓	✓	✓	✓	✓	✓	✓	✓	✓	✓	✓	✓	✓
TV does not accept any command		✓	✓	✓	✓	✓	✓	✓	✓	✓	✓	✓	✓	✓
Teletext rolling up/down		✓	✓	✓	✓	✓	✓	✓	✓	✓	✓	✓	✓	✓

Technical specifications table

LCD Panel size/type	27" 16:9 active matrix TFT	30" 16:9 active matrix TFT
Sound Output (%10 THD)	2X10 W	2X10 W
Power consumption	120 W	140 W
Stand by Power consumption	< 4 W	< 4 W

General technical specifications

Power Supply

AC: 110-240 V 50 Hz

Number of preset programmes.....100

RF Aerial input75 ohm (unbalanced)

Speaker impedance4 ohm

Sound SystemsMono/Stereo/NICAM

Batteries.....2x UM-4, IEC R03 or AAA 1.5V

Receiving channelsVHF (Band I Channels 2-4)

.....VHF (Band III Channels 5-12)

.....UHF (Channels 21-69)

.....Cable TV (S1-S20/S21-S41)

Receiving broad systemPAL BG

PAL SECAM BG

PAL SECAM BG DK/DK'

PAL SECAM BG LL'

PAL I

Please note: Your TV set is produced to receive only "one" of the colour and sound system options and cannot be changed by user, except BG/DK and BG/LL' if both systems are available you can select BG or DK and BG or LL from the section "Tuning the TV" on page 13.

Following information is only for EU-member states:

The use of the symbol indicates that this product may not be treated as household waste. By ensuring this product is disposed of correctly, you will help prevent potential negative consequences for the environment and human health, which could otherwise be caused by inappropriate waste handling of this product. For more detailed information about recycling of this product, please contact your local city office, your household waste disposal service or the shop where you purchased the product.

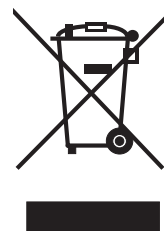

Free Manuals Download Website

<http://myh66.com>

<http://usermanuals.us>

<http://www.somanuals.com>

<http://www.4manuals.cc>

<http://www.manual-lib.com>

<http://www.404manual.com>

<http://www.luxmanual.com>

<http://aubethermostatmanual.com>

Golf course search by state

<http://golfingnear.com>

Email search by domain

<http://emailbydomain.com>

Auto manuals search

<http://auto.somanuals.com>

TV manuals search

<http://tv.somanuals.com>