

TOSHIBA

**DIGITAL PLAIN PAPER COPIER
OPERATOR'S MANUAL
FOR COPYING FUNCTIONS**

e-STUDIO 45/35

WARNING: Changes or modification made to this equipment, not expressly approved by Toshiba TEC or parties authorized by Toshiba TEC could void the user's authority to operate the equipment.

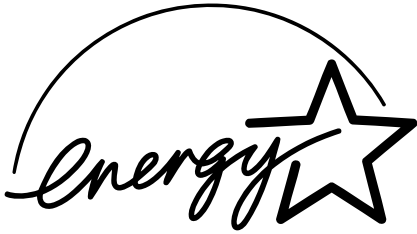

EPA ENERGY STAR® (MFD)

EPA ENERGY STAR Program-

The United States Environmental Protection Agency (EPA) has introduced a voluntary program, the ENERGY STAR Program, to encourage the widespread and voluntary use of energy-efficient technologies that enhance the workplace, improve product performance and prevent pollution. As an ENERGY STAR Partner, the Toshiba TEC Corp. has determined that this copier model meets the ENERGY STAR guidelines for energy efficiency.

ENERGY STAR guidelines for this class of copier require ENERGY STAR copiers to have an 'Off Mode' feature that automatically turns the copier off after a period of inactivity, ensuring night and weekend shut-off. The copier must also automatically change to a 'Low Power Mode' (Automatic Energy Save) after a period of time since the last usage.

For Copier+Printer or FAX models, ENERGY STAR guidelines for this class of copier require ENERGY STAR Multifunction copiers to have a 'Sleep Mode' feature that automatically makes the copier enter the sleep mode after a period of inactivity. The copier must also automatically change to a 'Low Power Mode' (Automatic Energy Save) after a period of time since the last usage.

Specifically, this copier complies with the following requirements —

◇ e-STUDIO45/35 Copier model (Base model)

'Off Mode'-

The copier consumes less than 20 watts (e-STUDIO45) /15 watts (e-STUDIO35) in the 'Off Mode'.

'Off Mode' Default Time-

The default time for the 'Off Mode' is 60 minutes.

'Automatic Energy Save'-

The copier consumes less than 178 watts (e-STUDIO45) /139 watts (e-STUDIO35) during Energy Save.

'Automatic Energy Save' Default Time-

The default time for the 'Automatic Energy Save' is 15 minutes.

◇ e-STUDIO45/35 Copier + Printer model (Multifunction model)-

'Sleep Mode'-

The copier consumes less than 95 watts (e-STUDIO45) /80 watts (e-STUDIO35) in the 'Sleep Mode'.

'Sleep Mode' Default Time-

The default time for the 'Sleep Mode' is 90 minutes (e-STUDIO45) /60 minutes (e-STUDIO35).

'Automatic Energy Save'-

The copier consumes less than 223 watts (e-STUDIO45) / 184 watts (e-STUDIO35) during Energy Save.

'Automatic Energy Save' Default Time-

The default time for the 'Automatic Energy Save' is 15 minutes.

Note1- The default setting for the 'Off Mode' or 'Sleep Mode' and 'Automatic Energy save' can be changed.

Note2- To restart the copier after an automatic shutoff or in the sleep mode, press the power key on the control panel.

Note3- In the sleep mode, if the FAX or printer data are received, or the power key on the control panel is pressed, the copier starts warming itself up and prints out the data when it becomes ready.

Note4- For Copier model (Base model), after an automatic shutoff, weekly timer feature cannot be activated. If you prefer to activate this feature, contact your authorized Toshiba dealer.

* Note 4 is applied to the regions with power requirements other than 100V.

In accordance with the EPA ENERGY STAR Program guidelines, this copier is suitable for the use of recycled copier paper (with up to 100% post-consumer content) meeting the requirements as specified in ENV 12281 (paper-printing and business paper-Requirements for copy paper for dry toner imaging processes).

If you have any questions regarding the use of recycled paper or some recommended types of recycled paper, please contact your authorized Toshiba dealer.

ENERGY STAR is a U. S. registered mark.

TOSHIBA QUALITY IS SECOND TO NONE

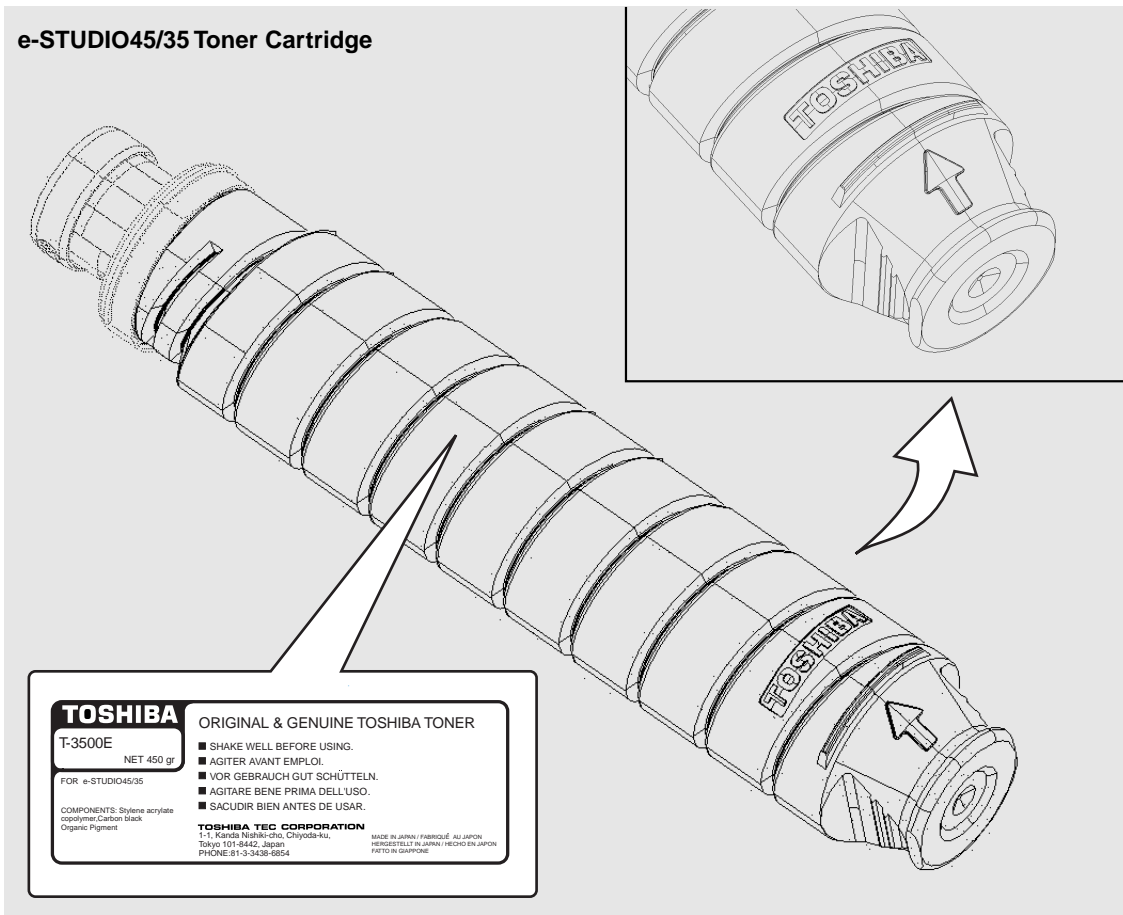

It is recommended that genuine TOSHIBA supplies and parts be used in order to obtain optimum results.

Supplies / Parts

Dependability

Genuine Toshiba supplies are subjected to the strictest of inspections so that every supply you receive will perform at optimal levels.

High Productivity

Genuine Toshiba supplies are created to meet the demands of our competitive world and provide high-speed reliable trouble-free copies when you need them.

Stable Image Quality

Genuine Toshiba supplies are designed to provide consistently stable image output day after day.

Copier Kind

Genuine Toshiba supplies are designed to keep the copier and all its parts in trouble-free working order. Reduction of machine wear is due to Toshiba's intimate knowledge of the copier's characteristics ensuring the highest standard of care.

Machine Balance

From the beginning Toshiba supplies and machines were made for each other. Whenever Toshiba designs a new machine, it also designs a new toner that is made just for that machine. By using Genuine Toshiba supplies with Toshiba copiers you guarantee optimum performance.

TOSHIBA QUALITY IS SECOND TO NONE (Cont.)

Toners

Optimum Image Quality

Genuine Toshiba toners use ultra-fine quality materials and precisely controlled parameters so that Toshiba copiers can continually generate sharp high-quality image output.

Cost Advantage

Genuine Toshiba toners mean value. They are designed to use only the proper amount of toner enabling the machine to continue to operate until all the toner has been used. In this way you get the full value of the toner.

Environmental Harmony

Genuine Toshiba toners are designed with the environment in mind. To care for Mother Earth, we use embossed or plastic labels making our toners fully recyclable. In addition, harmful dust and ozone levels have been reduced to improve the working environment.

Human Friendly

Genuine Toshiba toners are people-friendly. Before approving our toners for sale, we test them to be sure that they pass the strictest of health standards. This takes the worry out of handling the toner.

General

ISO 9000 and ISO 14000

Toshiba toner plants are ISO 9001 or ISO 9002 and ISO 14001 certified. Therefore quality of craftsmanship and environmental friendly production are guaranteed from the factory.

Service and Support Benefits

Toshiba's Service engineers are certified to keep your copier performing at optimum levels. To ensure continuous image quality it is highly recommended to utilize an authorized Toshiba service provider to care for and perform periodical maintenance so that you can get full benefit from your copier.

PREFACE

Thank you for purchasing the Toshiba Digital Copier e-STUDIO45/35. This Operator's Manual describes the following:

- how to use the digital copier
- how to inspect and carry out maintenance on the digital copier
- how to remedy mechanical and copying problems

Before using the digital copier, thoroughly read and understand this Operator's Manual. To ensure that clean copies are made at all times and to keep your digital copier in optimum working order, this Operator's Manual should be readily available for future reference.

When the digital copier is used as a printer and a FAX, be sure to read the Operator's Manual for Printing Functions and the Operator's Manual for Facsimile Functions.

■ To ensure correct and safe use of the Toshiba Digital Copier e-STUDIO45/35, this Operator's Manual describes safety precautions according to the following three levels of warning:

Before reading this Operator's Manual, you should fully understand the meaning and importance of these signal words.

Warning .. Indicates a potentially hazardous situation which, if not avoided, could result in death, serious injury, or serious damage, or fire in the equipment or surrounding assets.

Caution ... Indicates a potentially hazardous situation which, if not avoided, may result in minor or moderate injury, partial damage of the equipment or surrounding assets, or loss of data.

Note Indicates a procedure you should follow to ensure the optimal performance of the digital copier and problem-free copying.

Tip Describes handy information that is useful to know when operating the digital copier.

Advice Describes an operation you should follow to keep the digital copier in good working order.

Warning

This is a Class A product. In a domestic environment this product may cause radio interference in which case the user may be required to take adequate measures.

1. Do not touch the connector terminal when disconnecting the cables of peripheral equipment.
2. Before opening any covers or removing any units from the copier, discharge the static electricity from your body by touching a metal part of the copier.

This product is carrying the CE-Mark in accordance with the related European Directives. Responsible for CE-marking is Toshiba Europe GmbH, Hammfelddamm 8, 41460 Neuss, Germany. Phone +49-2131-158-01.

PREFACE (Cont.)

Features of the e-STUDIO45/35

The e-STUDIO45/35 is a digital copier that can also be used as a printer, scanner/printer, and facsimile by installing the related options. (Please check with your authorized Toshiba dealers to purchase these options.)

The e-STUDIO45/35 scans originals and stores the resulting data in its memory as digital images. The e-STUDIO45/35 allows you to process and edit these digital image data, as well as enabling copies to be sorted and grouped quietly, quickly and easily. The e-STUDIO45/35 incorporates a touch panel that graphically represents copier functions. As a result, anybody can make clear-looking copies quickly and easily.

The e-STUDIO45/35 also has the following convenient features and functions.

- Copying speed is 45 copies (A4) per minute for the e-STUDIO45, and 35 copies (A4) per minute for the e-STUDIO35.
- New originals can be scanned while the previous originals are being copied.
- The energy-saving POWER key on the control panel suppresses unnecessary power consumption when the e-STUDIO45/35 is in standby mode.
- The warming up time is only about 30 seconds.
- The automatic original density mode automatically reads the density of the original to set the ideal copy density.
- The size of the original is automatically read and the appropriate paper size and reproduction ratio are automatically selected.
- Wide reproduction range from 25% to 400% (25% to 200% when the optional reversing automatic document feeder is used).
- Duplex copies or single-sided copies can be made from two-sided originals. Duplex copies can also be made from single-sided originals.
- The following digital image editing functions are standard:
Trimming, masking, negative/positive reversal, X-Y zoom and mirror image, etc.
- The following memory editing functions are standard:
2 in 1, 4 in 1, document storage, annotation and page numbering
- With the electronic sort function, you can sort at high speed without damaging the originals.
- The cover-sheet mode allows you to add cover pages as the first and/or last pages of the copies. The sheet-insertion mode allows you to insert copied and /or blank sheets at specified pages by the user.
- Copy sizes from A5-R up to A3 are acceptable.
- The e-STUDIO45 has 2 finisher options, and the e-STUDIO35 has 3 finisher options. Each option offers quick sorting and stapling of copies. An optional hole punching unit can be installed with the console type finishers.
- A weekly timer allows automatic turning ON or OFF of the power supply at the specified startup or shutdown times, respectively.

TABLE OF CONTENTS

● Toshiba quality is second to none	1
● Preface	3
Features of the e-STUDIO45/35	4
● Table of contents	5
● Precautions	8
1. Installation	8
2. General precautions	9
● Forgery prevention function	10

1. Before making copies	1-1
1. Description of the digital copier and the optional equipment	1-2
• Main components	1-2
• Optional equipment	1-3
• Control panel	1-4
• Touch panel	1-6
• Total counter	1-8
2. Copy paper	1-9
• Acceptable paper types and sizes/Handling and storing paper	1-9
• Changing the paper size of the cassette/Setting the cassette for special uses	1-10
3. Turning ON the power switch	1-13
• Turning ON the power switch/Auto job start	1-13
• Controlling the use of the copier with department codes	1-14
• Controlling the use of the copier using the optional key copy counters	1-15

2. How to make copies	2-1
1. General copying procedures	2-2
2. Setting originals	2-4
3. Auto job start	2-8
4. Interrupt copying	2-9
5. Stopping the copy operation	2-10
6. Deleting or changing order of pending jobs	2-12

3. Setting of basic copy modes	3-1
1. Paper selection	3-2
• Automatic paper selection (APS)	3-2
• Manual paper selection	3-3
• Bypass copying	3-4
2. Reduction and enlargement copying	3-6
3. Selecting types of copying (1-sided, 2-sided, book-type)	3-9
4. Copy density adjustment	3-15
5. Selecting image quality types of originals (text, photo, text/photo)	3-17

4. Using the editing functions	4-1
1. Image shift copying	4-2
2. Edge erase copying	4-4
3. Dual-page copying	4-5
4. X-Y zoom copying	4-6
5. Image editing	4-7
• Trimming/Masking	4-7
• Mirror image	4-9
• Negative/Positive reversal	4-10
6. 2 IN 1 / 4 IN 1 copying	4-11

TABLE OF CONTENTS (Cont.)

7. Copying with annotation added	4-13
8. Page numbering copying	4-14
9. Magazine sort copying (from editing menu)	4-16
10. Cover sheet copying	4-18
11. Sheet insertion copying	4-20
12. Document storage	4-22
13. Direction of copy images (rotation)	4-24

5. Using the special functions	5-1
1. Continuous original feeding/Single original feeding	5-2
2. Copying mixed-sized originals	5-4
3. Mode memory copying	5-5
4. Copying on special types of paper	5-8
5. Weekly timer	5-10
6. Setting the other paper sizes (other key)	5-12
7. Setting the date and time	5-13
8. Setting automatic energy saving mode	5-14
9. Setting automatic shutoff mode	5-15
10. Switching between languages	5-16
11. Department codes	5-17
12. Entering letters	5-24

6. Selecting finishing modes (Using the optional finishers)	6-1
1. Finishing modes and finishers (optional)	6-2
2. Sort/group copying	6-3
3. Staple mode	6-5
4. Alternate stacking mode	6-7
5. Hole punching mode	6-8
6. Magazine sort & Saddle stitching mode	6-9

7. When graphic symbols flash on the touch panel	7-1
1. Description of the flashing graphic symbols	7-2
2. Add paper symbol	7-3
• Adding paper to the cassettes	7-3
• Adding paper to the large-capacity feeder (optional)	7-4
3. Replace toner cartridge symbol	7-5
4. Clear paper symbol	7-10
① Reversing automatic document feeder (optional)	7-10
② Cassette feeding area	7-12
③ Large-capacity feeder (optional)	7-13
④ Bypass feed unit	7-13
⑤ Automatic duplexer	7-14
⑥ Jam releasing unit	7-14
⑦ Fuser unit	7-15
⑧ Relay unit	7-16
⑨ Hole punching unit (optional)	7-17
⑩ Finisher (optional)	7-17
⑪ Saddle stitching unit (optional)	7-19
5. Adding staples	7-21
6. Removing jammed staples	7-25
7. Clearing accumulated punched paper bits	7-28
8. Call service symbol	7-29
9. Periodic maintenance message	7-30

8. Maintenance	8-1
1. Daily inspection	8-2
2. Simple troubleshooting	8-4

9. Specifications & Options	9-1
1. e-STUDIO45/35 specifications	9-2
2. Specifications of options	9-3
3. Packing list	9-6

PRECAUTIONS

1. Installation

- 1** The e-STUDIO45/35 should be installed by a qualified service technician.
Note: The packing material should be disposed of properly.

- 2** To obtain the best possible results, this copier should be used in conjunction with a dedicated AC power line at the following ratings.

220–240V, 50/60Hz, 8A

Notes:

1. The use of other appliances or other equipment on the same line as this copier may adversely affect performance and copy quality.
2. Be sure to use a 3-conductor, grounded wall outlet.
3. In areas where a 2-pin plug is used, the copier must be grounded for safety.
Never ground it to a gas pipe, a water pipe, or any other object not suitable for grounding.

- 3** After a suitable place has been selected for the installation of the e-STUDIO45/35, please do not change it. Avoid excessive heat, dust, vibration and direct sunlight. Also, provide proper ventilation as the copier emits a small amount of ozone.

Notes:

1. The recommended environmental range for use is as follows:
 - Temperature: 10~30°C/50~86°F
 - Humidity: 20~85% RH
2. To insure optimal operation, allow clearances of at least 80cm on the left, 80cm on the right and 10 cm in the rear (refer to the illustration below).

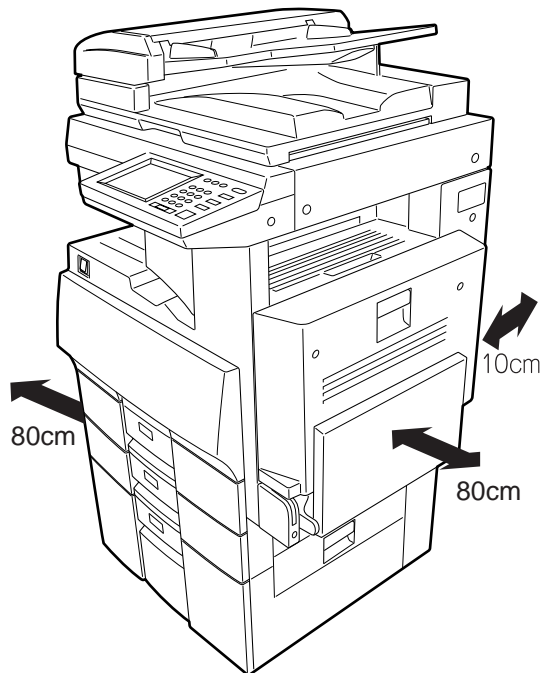

The socket-outlet shall be installed near the equipment and shall be easily accessible.

2. General Precautions

1 Handle and use the copier gently and carefully.

- Do not place anything on the paper cassettes or the original feeding tray.
- Never allow the power cable to be trampled on or pinched between hard objects, otherwise an accident or electrical trouble might occur.
- Do not allow any metal items such as paper clips to fall into the copier.

2 Be sure to turn OFF the power switch (unless using the weekly timer mode):

- When you leave your office at night.
- If a power failure occurs.

Caution: When turning OFF the power switch, be sure to do so only after the machine cycling has come to a complete stop.

Be sure to disconnect the power-cord plug:

- When you do not intend to use the copier for an extended period of time.

Be sure to turn OFF the power switch immediately and call for service:

- If an unusual noise is heard from the copier.
- If the outside of the copier becomes unusually hot.
- If any part of this copier is damaged, or if it has been dropped.
- If the copier has been exposed to rain or liquid.

3 It is recommended that only supplies made or designated by Toshiba be used for the e-STUDIO45/35 in order to optimize copy quality. All supplies should be stored in a cool, dry area.

For optimum performance, it is recommended that 80 g/m² xerographic bond paper of high quality be used.

Paper of lower quality may contain inherent properties such as excess paper dust and may lead to premature servicing.

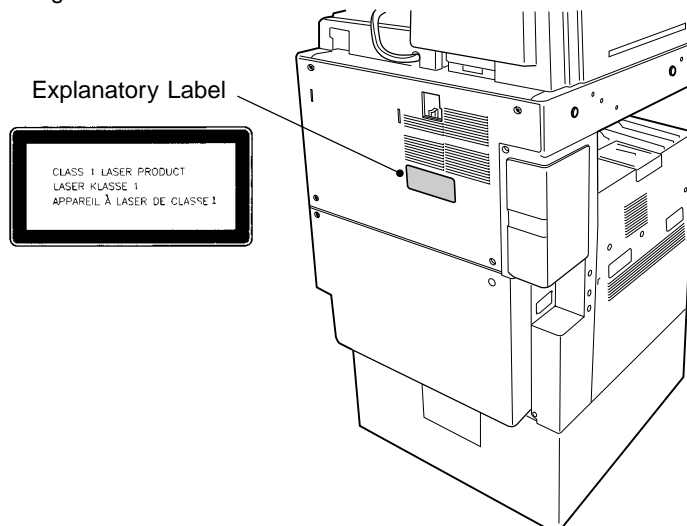

WARNING: DO NOT LEAN ON, APPLY FORCE OR PLACE HEAVY OBJECTS ON THE FINISHER. PERSONAL INJURY OR PROPERTY DAMAGE MAY RESULT.

Machine Noise Information

Ordinance 3. GSGV, January 18, 1991: The maximum sound pressure level is equal to or less than 70dB(A) according to EN27779.

FORGERY PREVENTION FUNCTION

This copier has a forgery prevention function.

Please ensure that your digital copier is not used for making copies of prohibited items.

1. BEFORE MAKING COPIES

1. Description of the digital copier and the optional equipment	1-2
• Main components	1-2
• Optional equipment	1-3
• Control panel	1-4
• Touch panel	1-6
• Total counter	1-8
2. Copy paper	1-9
• Acceptable paper types and sizes/Handling and storing paper	1-9
• Changing the paper size of the cassette/Setting the cassette for special uses	1-10
3. Turning ON the power switch	1-13
• Turning ON the power switch/Auto job start	1-13
• Controlling the use of the copier with department codes	1-14
• Controlling the use of the copier using the optional key copy counters	1-15

1. DESCRIPTION OF THE DIGITAL COPIER AND THE OPTIONAL EQUIPMENT

Main Components

1

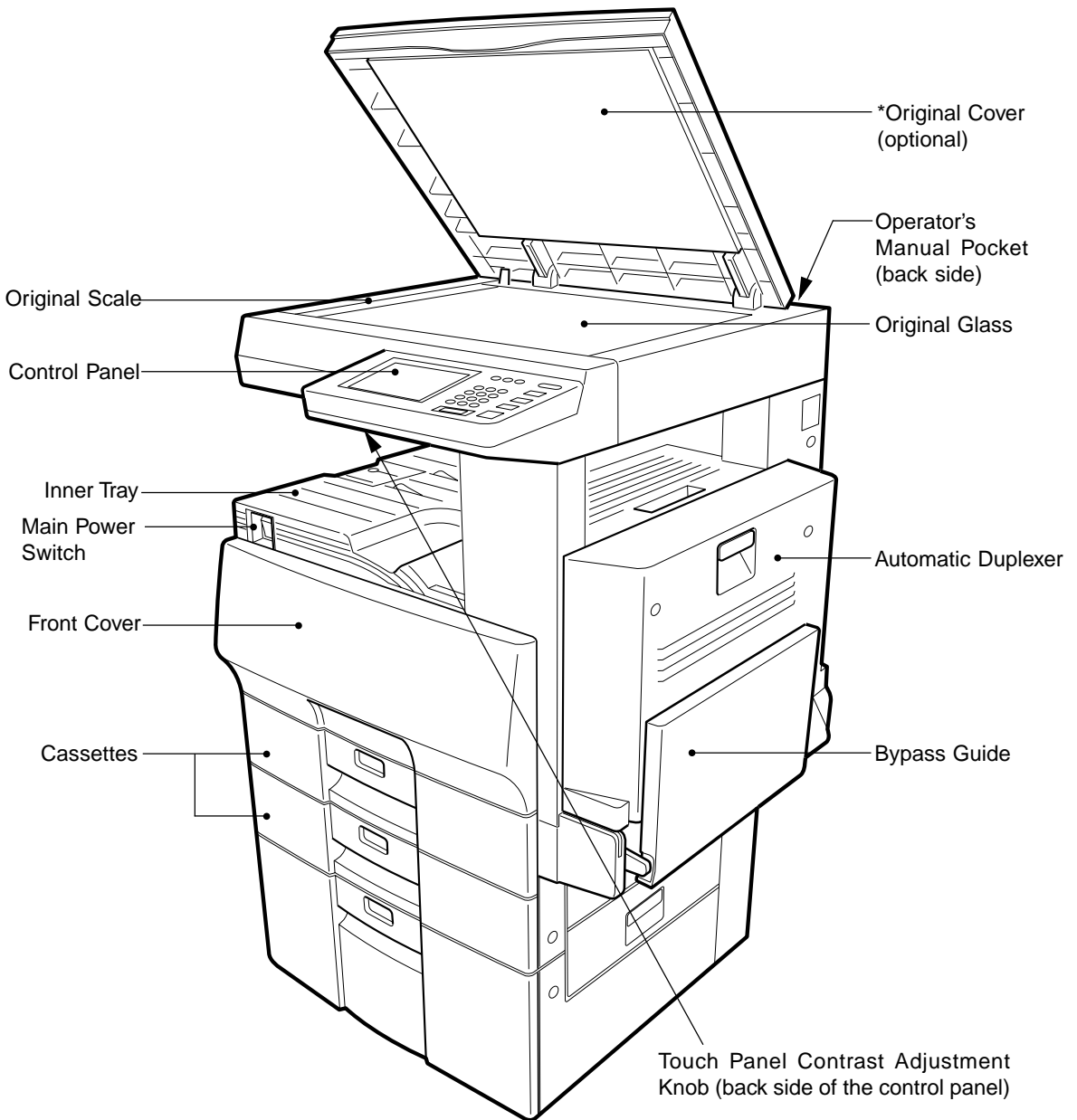

1-2

BEFORE MAKING COPIES

Optional Equipment

① **Key Copy Counter** ► Page 1-15

Records (or accumulates) the number of copies made by each person or group separately.

② **Reversing Automatic Document Feeder** ► Page 2-6

Automatically feeds a placed stack of originals one by one to have them copied.

③ **Large-Capacity Feeder**

Feeds up to 2500 sheets of A4-sized paper (recommended by Toshiba) continuously. A paper feed pedestal can also be installed instead. Ask your service technician for details.

④ **Finisher** ► Page 6-2

Enables the use of the hole punching (available when the optional hole punching unit is installed) and saddle stitching modes in addition to the sort, group and stapling modes. There are 2 console types and a hanging type. (The hanging type can be installed in the e-STUDIO35 only.)

⑤ **Hole Punching Unit** ► Page 6-8



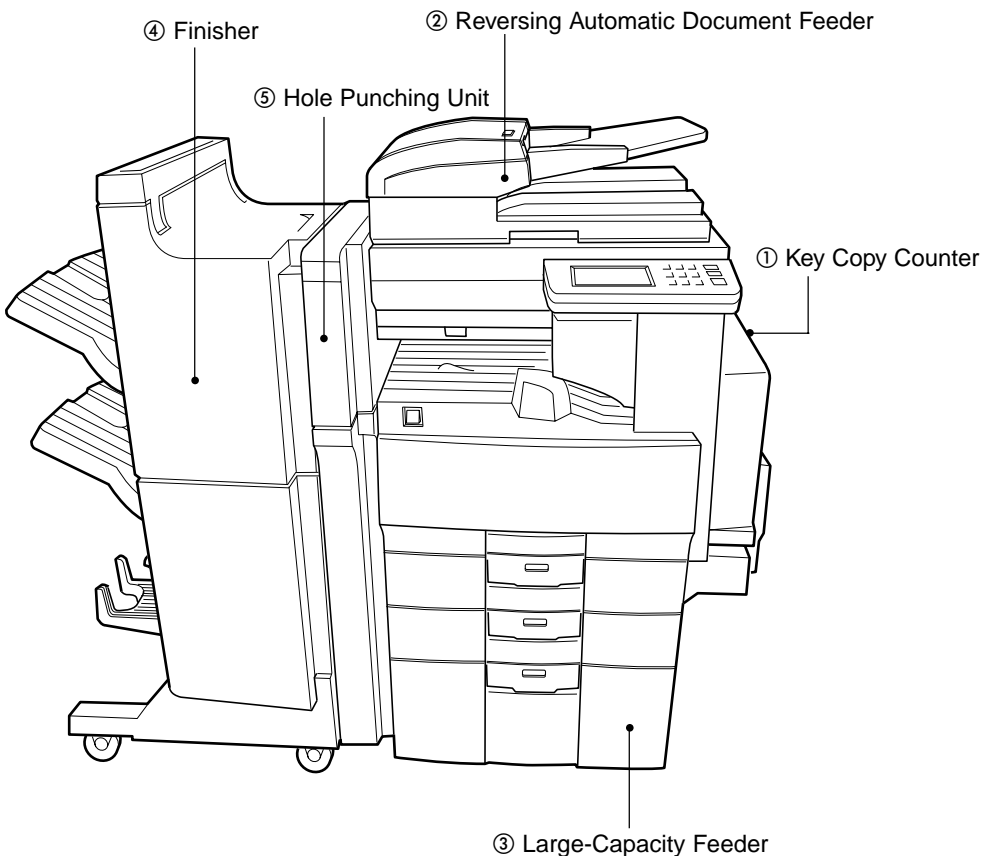

Makes punch holes on copies. This unit can be installed in the console type finishers.



1. DESCRIPTION OF THE DIGITAL COPIER AND THE OPTIONAL EQUIPMENT (Cont.)

Control Panel

1

- ① **Touch panel**
Displays the copier conditions, operating procedures, and various instructions and information to the user in text and graphics.
- ②  **PRINTER/NETWORK** key
If you have a print option installed, press this key to access the printer function.
- ③ **DATA LED/ERROR LED**
DATA LED lights when the device has received data. ERROR LED lights when a communication error occurs.
- ④  **COPY** key
Press this key to select the copy function.
- ⑤  **FAX** key
Press this key to select the fax function.
- ⑥ **MEMORY RX LED**
This LED lights when the memory contains a received original standing by to be printed.
- ⑦ **MAIN POWER LED**
This LED shows the AC power supply status. When the copier is ready to be used in the energy saving mode, it is green. It becomes red in the auto shutoff (or sleep) mode.
* In the regions with power requirements of 200V, when the copier does not have the optional facsimile or printer function installed, the LED goes out in the auto shutoff mode.
- ⑧  **POWER** key
When you are not going to use the copier for a while, press this key for two seconds; all indicator lamps except the MAIN POWER LED, and the touch panel are turned off and unnecessary electricity is cut off in the shutoff mode. To resume copying, press the key again. Within 30 seconds, the copier will become ready for copying. If you press this key when the optional facsimile and/or printer is installed, the power supply to the FAX reception detection circuit and the printer board is not cut off, which allows automatic return of the device when it receives FAX and printer data.

Automatic Function Clear

Even if you do not press the  **FUNCTION CLEAR** key, within 30 seconds after copying is finished or after the last key is pressed in a copy procedure, the automatic function clear mode will work to clear all settings to defaults, and the basic screen will be displayed. While the department management function is being operated, the display returns to the department code input screen. ► Page 1-14

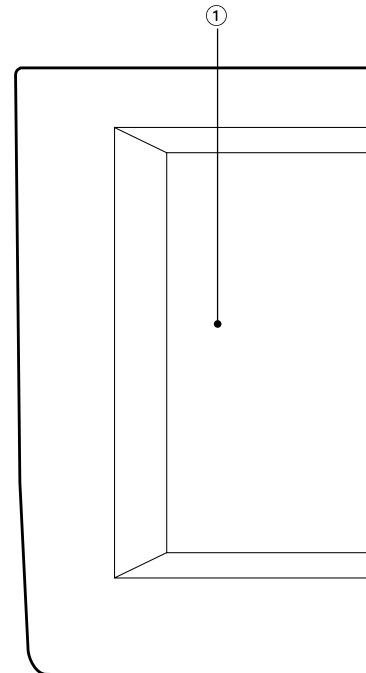

⑨ **Digital keys**

Use these keys to enter the number of copies you want to make. Up to 999 copies can be set. They can also be used for setting time and department codes, and for sheet insertion, etc.

⑩ **INTERRUPT** key

While copying is already in progress, press this key when you want to make copies of different originals. Pressing the key again will return you to the previous copy job.

⑪ **FUNCTION CLEAR** key

When this key is pressed, all selected copy modes are cleared to default settings.

* Automatic Function Clear ► Page 1-4

⑫ **C/⊗ CLEAR/STOP** key

Use this key to correct an incorrect copy quantity entered, or to stop an ongoing scan and copy operation. During scanning, pressing the key once will stop the copier; pressing it twice will clear the copy quantity to the default setting. ► Page 2-10

⑬ **JOB STATUS** key

Press this key to see the job list, to delete or move jobs, to confirm the job status, to change the cassette setting, or to display the counter. Graphic symbols flash when there is no paper in the cassette, the wrong cassette size is set, the finisher is full, the holder for the hole punched paper bits is full, etc.

⑭ **HELP** key

When this key is pressed, appropriate operation procedures are displayed.

⑮ **MONITOR/PAUSE** key

This key is used when the copier is used as a facsimile. See the **Operator's Manual for Facsimile Functions** for detail.

⑯ **START** key

Press this key to start copying.

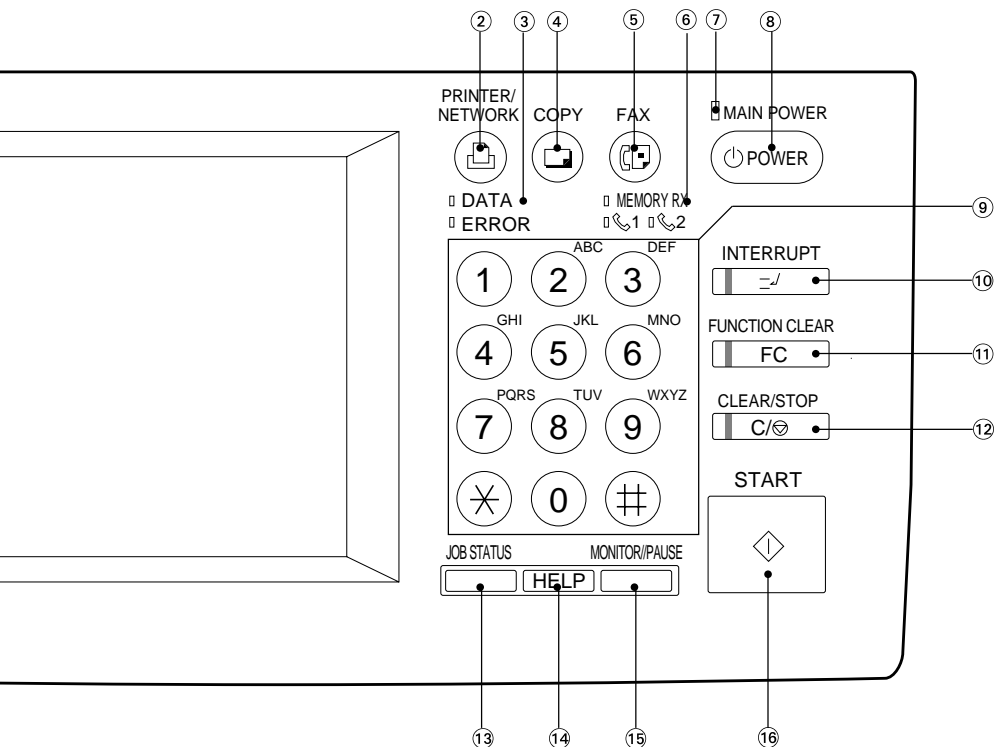

1. DESCRIPTION OF THE DIGITAL COPIER AND THE OPTIONAL EQUIPMENT (Cont.)

Touch Panel

1

When the power is turned on, the following basic screen is shown on the touch panel. (If controlled by the department code or an optional key copy counter, a different screen is displayed.)

On the screen, currently set functions, selected functions and the copier status are shown using messages and graphics.

* The brightness of the touch panel can be adjusted with the touch panel contrast adjustment knob on the back side of the control panel.

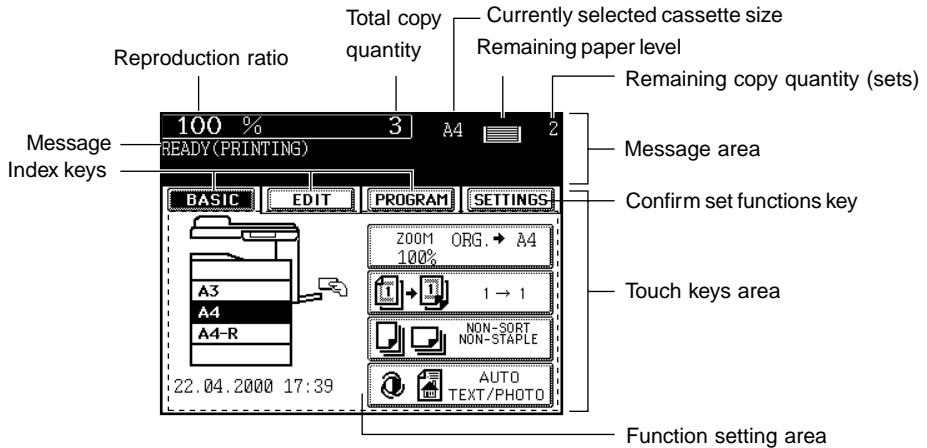

Message Area

The following information is shown here:

Copier status, operational instructions, cautionary messages, reproduction ratios, total copy quantity, paper sizes, remaining paper level, and remaining copy quantity (sets).

● Remaining paper level

The various paper levels indicated on the right show the approximate numbers of sheets when recommended paper is used.

The numbers in parentheses are applicable when the large-capacity feeder (optional) is used.

	550 ~ 100 (2500 ~ 100)
	100 ~ 1 (100 ~ 1)

Touch-keys Area

The various function items shown here are touch-key selectable. Press any key lightly with your finger.

● Index keys

Used for switching between the Basic, Editing and Program menu.

● Function setting area

This is where you select or set various functions.

- **Confirm set functions key**

This key allows you to confirm the functions that have been set. (The display shown on the right is an example.)

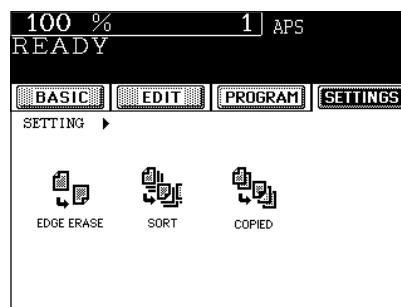

Clearing the Functions Selected

If you again press any key that is highlighted, the function selected is cleared. Also, if the copier is left inactive for approx. 30 seconds, the automatic function clear (► Page 1-4) works and the settings will be cleared.

1. DESCRIPTION OF THE DIGITAL COPIER AND THE OPTIONAL EQUIPMENT (Cont.)

Total Counter

1

This function displays the total number of copies.
The total counter is a cumulative counter. You cannot clear this counter.

1 Press the **JOB STATUS** key on the control panel.

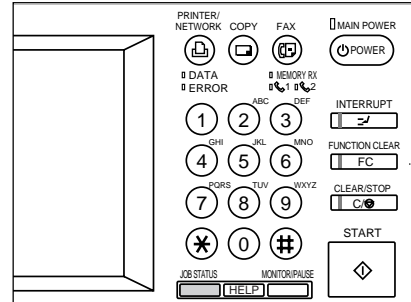

2 Press the **STATUS** key.

- The total number of copies of the copier is displayed.

Tip

If you want the copy, FAX list, or printer counter to be displayed in the screen on the right, consult your service technician.

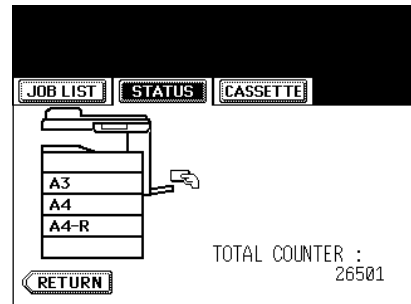

2. COPY PAPER

Acceptable Paper Types and Sizes/Handling and Storing Paper

For optimum copy quality, use the paper recommended by Toshiba. Consult your service technician for details.

1

Acceptable Paper Types and Sizes

Feeder	Type of paper	Paper size	Maximum capacity	Remarks
• Cassette • Paperfeed pedestal (optional)	Plain paper (64 ~ 80 g/m ²) only	Standard size A/B format: A3, A4, A4-R, A5-R, B4, B5, B5-R, FOLIO	550 sheets (Height: 60.5mm)	Plain paper with holes for filing cannot be used.
• Large-capacity feeder (optional)	Plain paper (64 ~ 80 g/m ²) only	Standard size A/B format: A4 only	2500 sheets	Plain paper with holes for filing cannot be used.
• Sheet bypass	Multi-sheet feeding: Plain paper (64 ~ 80 g/m ²) only 1-sheet feeding: Plain paper, Thick paper (81 ~ 209 g/m ²), tracing paper, OHP films, labels	Standard size A/B format: A3, A4, A4-R, A5-R, B4, B5, B5-R, FOLIO	100 sheets (Height: approx. 11mm) 1 sheet	Plain paper with holes for filing cannot be used. Also, some of the items specified under "type of paper" may not be used depending on type, thickness or storing condition. (For details, consult your service technician.)

"Maximum capacity" refers to the number of sheets when the paper recommended by Toshiba is set.

Handling and Storing Paper

Pay attention to the following points:

- Avoid using paper that is specially treated or paper that was printed on another machine, and also avoid performing double copying on the same side of paper; this may cause a malfunction.
- Do not use paper with creases, wrinkles or prone to curling, smooth paper, or tough paper; this may cause paper misfeeds.
- Paper should be wrapped in its wrapping paper and stored in a damp-free place.
- To prevent paper from being folded or bent, store it evenly on a flat surface.

2. COPY PAPER (Cont.)

Changing the Paper Size of the Cassette/Setting the Cassette for Special Uses

1

The paper size of the cassettes of the copier can be changed to desired sizes. The cassettes can also be set for cover sheet, sheet insertion, FAX and special sheets.

1 Pull out the cassette toward you.

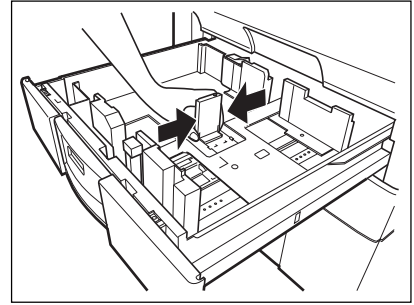

2 Push the lower part of the width guide in the direction of the arrow to remove it, and reinstall the width guide at the desired paper size (indicated on the bottom surface of the cassette).

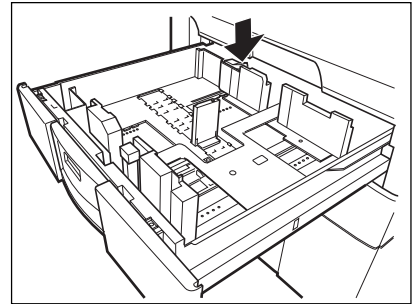

3 Push the arrow part (right side) of the size selection lever to unlock it.

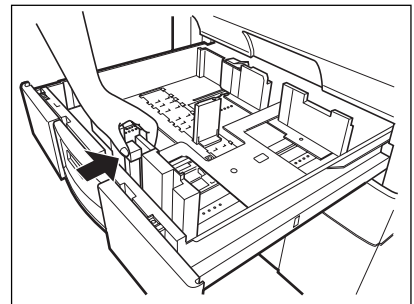

4 While pushing the size selection lever in the direction of the arrow, set the side guide to the desired paper width (indicated on the bottom surface of the cassette).

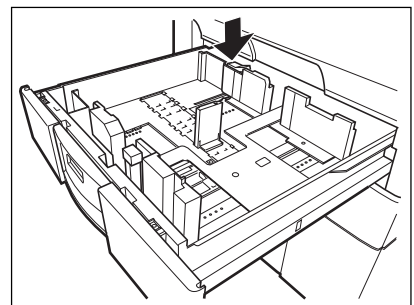

5 Push the arrow part (left side) to lock the size selection lever.

6 Place paper in the cassette.

7 Install the cassette into the copier.

- 8** Press the **JOB STATUS** key on the control panel, then the **CASSETTE** key on the touch panel.

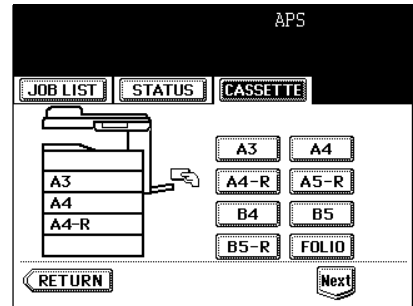

- 9** Press the cassette key corresponding to that in which the paper size has been changed, then press the key of the paper size newly set.

- Chinese paper sizes (16K, 8K and 16K-R) can be selected on the screen which appears when the **Next** key is pressed once. Pressing the **Next** key again will display the LT format (North American paper sizes).
- Press the **JOB STATUS** or the **FUNCTION CLEAR** key on the control panel or **RETURN** key on the touch panel to return to the basic screen.

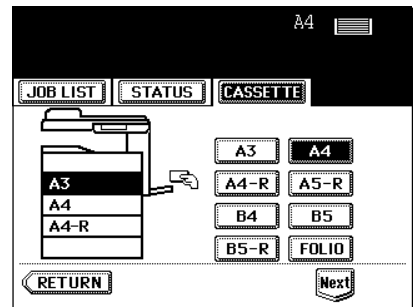

Setting the Cassette for Special Uses

You can set the cassette for various uses (cover sheet, sheet insertion, FAX and special sheets).

The acceptable paper is plain paper (64–80g/m²) only. ► Page 1-9

- Cassette for cover sheet ► Page 4-18
- Cassette for sheet insertion ► Page 4-20
- Cassette for FAX...Needed when the optional facsimile function is made available (The **FAX** key is available only when the facsimile function is installed).
- Cassette for special sheets...Colour paper, paper with a watermark, etc.

- 1** Set the paper in the cassette.

- For changing the paper size in the cassette, follow step 1 to 7 on the previous page.

- 2** Press the **JOB STATUS** key on the control panel, then the **CASSETTE** key on the touch panel.

- Press the **NEXT** key to display the screen on the right.

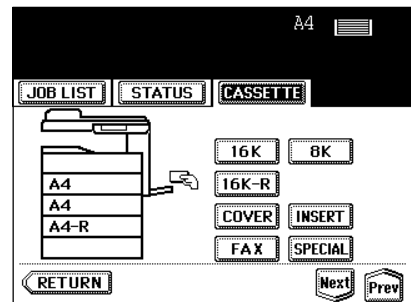

2. COPY PAPER (Cont.)

Changing the Paper Size of the Cassette/Setting the Cassette for Special Uses (Cont.)

1

3 Press the cassette key corresponding to that in which the paper has been set, then select any of the **COVER**, **INSERT**, **FAX** and **SPECIAL** keys.

- If you want to select the **COVER** or **INSERT**, make sure that paper with the same size as that for the **COVER** or **INSERT** is set in the other cassette.

- The setting is completed as shown on the right.

Tip

Up to 2 cassettes can be set for the sheet insertion. After having set "INSERT 1", press the cassette key corresponding to that in which the paper for "INSERT 2" has been set, and press the **INSERT** key.

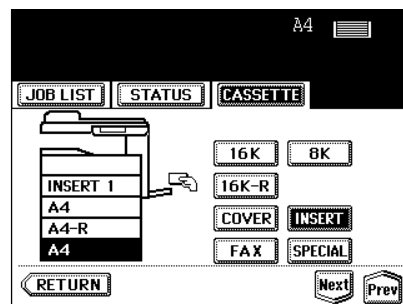
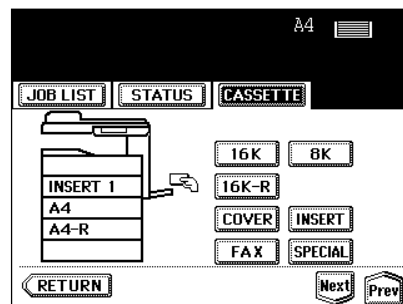
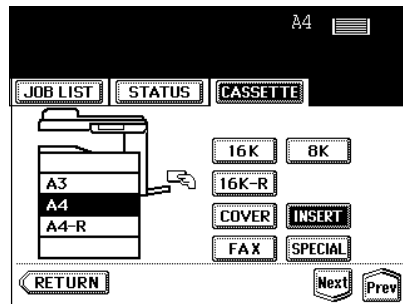

Clearing the Cassette for Special Uses

Press the cassette key corresponding to that which is set for the special use, then press the key of the same mode as the cassette.

- If you clear **INSERT 1** when both **INSERT 1** and **INSERT 2** are set, the cassette for **INSERT 2** changes to **INSERT 1**.
- Replace the paper set in the cassette as required.
- Press the **JOB STATUS** or the **FUNCTION CLEAR** key on the control panel or the **RETURN** key on the touch panel to return the machine to the basic screen.

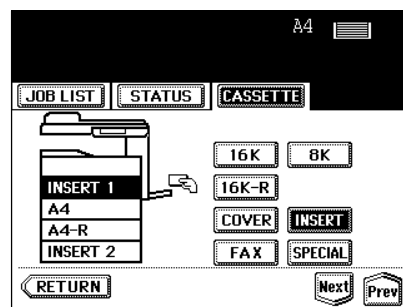

3. TURNING ON THE POWER SWITCH

Turning ON the Power Switch/Auto Job Start

Turning ON the Power Switch

1 Open the cover and turn ON the main power switch.

- This message appears on the message panel of the Basic Screen:

Wait Warming Up

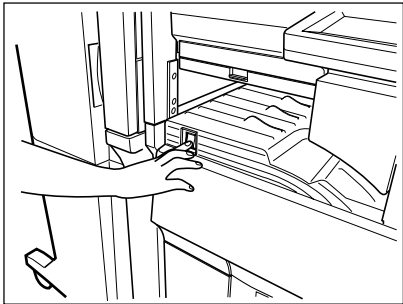

2 About 30 seconds later, the copier will become ready for copying.

- This message appears on the message panel:

READY

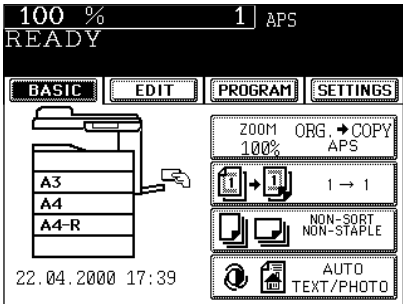

Auto Job Start

While the copier is warming up, place the original on the glass, select the desired copy modes and press the **(START)** key. The copier starts scanning the originals.

READY

When this message appears, copying will automatically start.

Tip

Up to 5 jobs can be stored in the memory. Place the originals for the 6th job on the original glass or the reversing automatic document feeder (optional) and press the **(START)** key. The following message will appear:

Auto Start

To clear this status, press the **(FUNCTION CLEAR)** or the **(C/CLEAR/STOP)** key.

3. TURNING ON THE POWER SWITCH (Cont.)

Controlling the Use of the Copier with Department Codes

1

With the use of department codes (access codes), you can restrict copier users as well as manage copy volumes made by individual groups or departments of your company.

* Registering, changing and deleting a department code ► Page 5-18

1 When the department control function is in use, the screen shown on the right appears immediately after the main power switch is turned on (or when the automatic function clear mode is activated).

2 Key in a registered department code (5-digit).

- The copier will be ready for copying.

Tip

- 5-digit numbers that can be used as department codes are 00001 to 99999.
- If the following message remains displayed,

Enter Department Code

the access code you have entered may be incorrect. Key in the correct code.

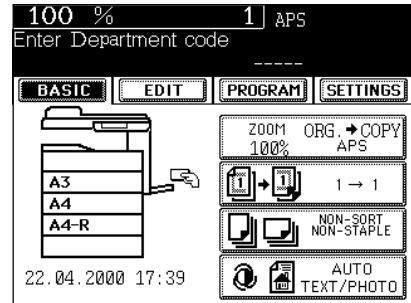

After the Scanning Operation is Finished

If the department control function is in use, be sure to press the **FUNCTION CLEAR** key twice when the scanning operation has been made. The display returns to the department code input screen and the department control function will remain active.

Controlling the Use of the Copier Using the Optional Key Copy Counters

When the optional key copy counter function is available, you can only make copies by inserting your key copy counter. When you make copies with your key copy counter inserted, the number of copies made is recorded (or added up) in your counter. Any number of key copy counters can be used.

* For how to use the key copy counter, consult your service technician.

1 The following message appears on the basic screen:

Set key copy counter

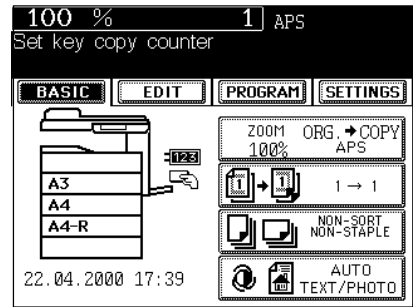

2 Insert your key copy counter.

- Holding the counter with its arrow-marked side facing up and the arrow pointed toward the copier, insert the counter slowly until it comes to a stop.
- When the message has changed to:

READY

the copier is ready for copying.

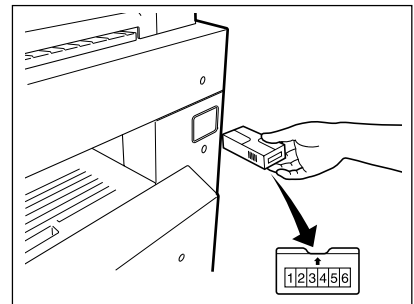

After Copying is Finished

After you have finished making copies, remove your key copy counter.

2. HOW TO MAKE COPIES

- 1. General copying procedures..... 2-2
- 2. Setting originals 2-4
- 3. Auto job start 2-8
- 4. Interrupt copying 2-9
- 5. Stopping the copy operation 2-10
- 6. Deleting or changing order of pending jobs 2-12

1. GENERAL COPYING PROCEDURES

When originals are set and the **START** key is pressed with any settings unchanged, copies are made in the initial (default) settings (*1).

2

The initial (default) settings of the copier at the time of installation are as shown on the right.

- *1 The copy modes that are automatically set when the power is turned on or when the **FUNCTION CLEAR** key is pressed on the control panel are called the initial (default) settings.
- *2 This is displayed when the reversing automatic document feeder (optional) is installed.

Initial settings

Reproduction ratio 100%
Copy quantity 1
Automatic paper selection
1-sided copies from 1-sided originals
Automatic image density
Text/photo mode (original image type)
Non-sort Non-staple mode
Continuous original feed mode (*2)

Copying Procedure

1 Place the originals.

- Acceptable originals ► Page 2-4
- When placing an original on the glass ► Page 2-4

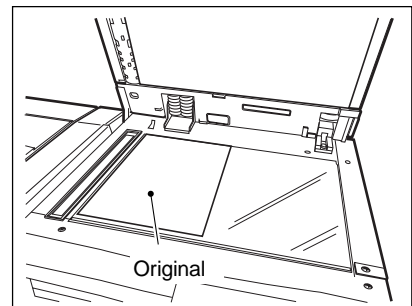

- When placing originals in the reversing automatic document feeder (optional) ► Page 2-6

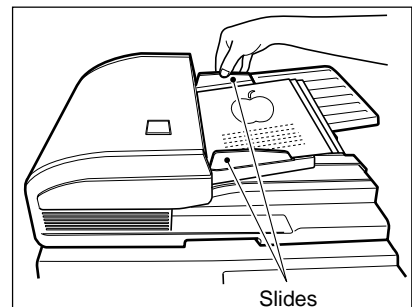

2 Select copy modes (with ② in the illustration on the page 2-3).

- Use the touch panel and the digital keys.

3 Press the **START** key (3 in the illustration below).

- Copying begins.

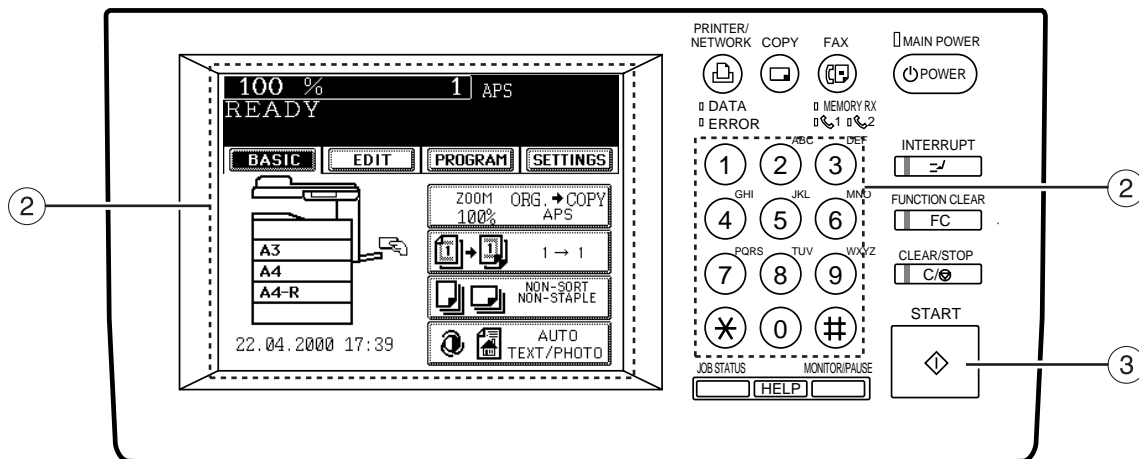

Tip

● To copy multiple original pages:

- When placing an original on the glass:
Following the general copying procedure, perform steps 1 to 3. Press the **YES** key on the displayed screen, then set the next original.
- When using the reversing automatic document feeder (optional):
Make sure that the continuous feed mode (▶ Page 5-2) is selected and set the originals.

● To make multiple sets of copies:

- Key in the copy quantity with the digital keys.
- To correct the input copy quantity, press the **C/CLEAR/STOP** key.

● When paper which is the same size as the original has not been set in the cassette:

- Setting the cassette ▶ Page 1-10
- Bypass copying ▶ Page 3-4

● When paper which is the same size as the original has run out:

The corresponding cassette key on the touch panel flashes. Add paper or select another cassette.

* If you press the **JOB STATUS** key on the control panel when copying starts, the current status of the operation can be confirmed.

2. SETTING ORIGINALS

Originals

The following specifications of originals can be used with this copier:

Setting place	Types of original	Maximum size	Size capable of automatic detection	Maximum number that can be set	Remarks
Glass	Sheets Three-dimensional objects Books	Width:297mm Length:432mm	Regular size A/B format: A3, A4, A4-R, A5, A5-R, B4, B5, B5-R, FOLIO		Do not place any heavy object (4 kg or over) on the glass
Reversing automatic document feeder (optional)	Plain paper, thermal paper, long originals, originals with filing holes (2-, 3- and 4-holes): 50~127 g/m ² (1-sided original) 50~105 g/m ² (2-sided original)	Width:297mm Length:432mm	Regular size A/B format: A3, A4, A4-R, A5-R, B4, B5, B5-R, FOLIO	100 originals (50~80 g/m ²) or stacked height of originals 16 mm or less	Some of the originals listed under "Types of original" may not be used depending on paper quality.

When Placing an Original on the Glass

Sheet Originals

- 1** Raising the original cover or the reversing automatic document feeder (optional), place the original face down on the glass.
- 2** Align the original against the left inner corner of the glass.
- 3** Lower the original cover or the reversing automatic document feeder slowly.

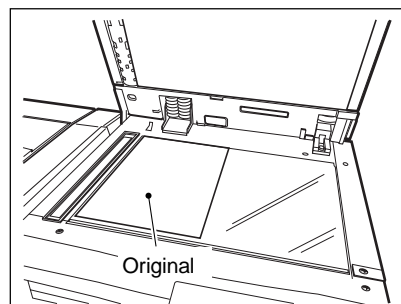

Tip

When copying originals with high transparency, such as OHP films and tracing paper, place a blank sheet of paper the size of the original or larger over the original.

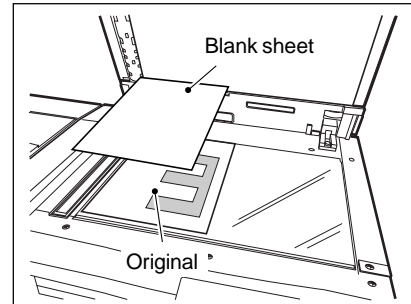

2

Book-type Originals

1 Raise the original cover or the reversing automatic document feeder (optional), set the original with its centre placed on the yellow indicator line and in the direction shown in the picture.

- If the original is not set in the correct direction, copies will not be delivered in the correct page order.

2 Lower the original cover or the reversing automatic document feeder (optional) slowly.

- Do not try to force the original cover or reversing automatic document feeder (optional) to fully close over a very thick original, such as a big book. Copies can be made even if the cover or feeder does not close fully.
- During copying, an intense light may leak out. Do not look at the original glass surface.

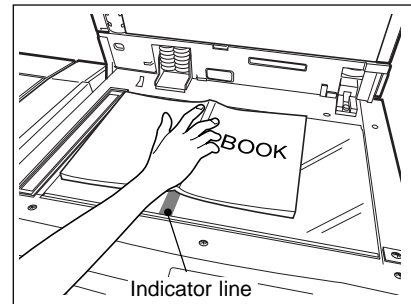

2. SETTING ORIGINALS (Cont.)

When Using the Reversing Automatic Document Feeder (optional)

Precautions for Using the Reversing Automatic Document Feeder (optional)

2

Do not use the following types of originals as they tend to misfeed or become damaged:

- (1) Badly wrinkled or folded originals; in particular, originals whose leading edge is curled may fail to be correctly fed.



- (2) Originals with carbon paper



- (5) Originals with holes or torn originals

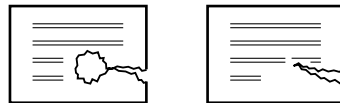

- (3) Taped, pasted or clipped (cut out) originals

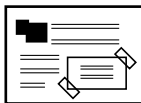

- (6) Damp originals



- (7) OHP film originals

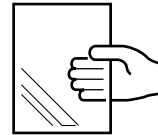

Also, the following originals should be handled carefully:

- (1) Folded or curled originals should be smoothed out before being used.

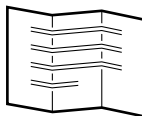

- (2) Only originals with the same width can be set at a time. (Do not mix originals with different widths.)



- (3) Originals, two of which, when pinched between two fingers, cannot be moved, or originals which are surface-treated may fail to be separated properly.

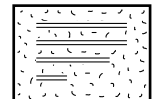

In the Continuous Feed Mode ▶ Page 5-2

1 After aligning the edges of originals well, place them face up and align the slides to the width of the originals.

- Maximum number of originals that can be set ▶ Page 2-4
- If you cannot set all the originals at one time, divide them into a few groups. ▶ Page 5-2

Tip

Be sure to set only originals with the same width. Copying mixed-sized originals ▶ Page 5-4

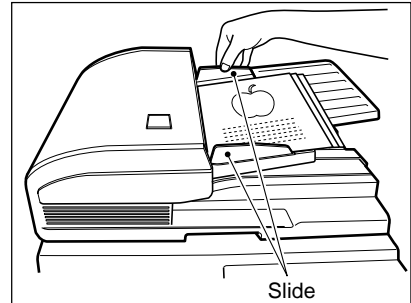

2

In the Single-feed Mode ▶ Page 5-3

1 Align the slides to the desired original size.

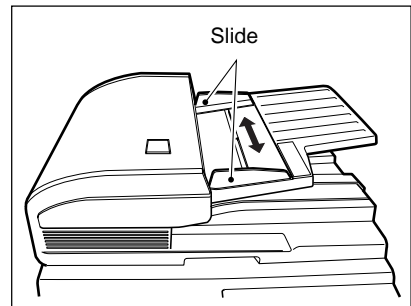

2 Insert the original face up and straight along the slides; it will then be pulled in automatically.

- When the original starts being pulled in automatically, let go of it.

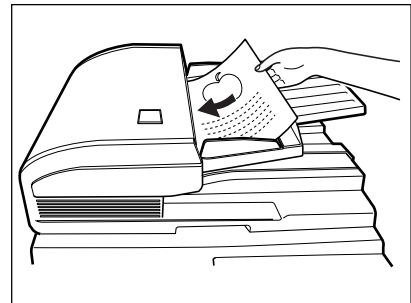

3. AUTO JOB START

While multi-copying is in progress, you can reserve the next copy.

2 1 Place the original(s). ▶ Page 2-4

- Select copy modes as required.

2 Press the **START** key.

- Up to 4 jobs can be stored in the memory during printing. Place the originals of the 5th job on the original glass or the reversing automatic document feeder (optional) and press the **START** key. The following message will appear:

Auto Start

Confirming and Cancelling Auto Job Start

● Confirming auto job start

Press the **JOB STATUS** key on the control panel, then the **JOB LIST** key on the touch panel.

User Name	Time	Paper	Pages	Sets
COPY	10:03	A4	3	2
FAX:+01	10:03		1	1
COPY	10:03	A3	2	4
SUZUKI	10:03	A4-R	10	1

● Cancelling the job while waiting for the original to be stored in the memory

If you want to cancel copying the original when it has already been set on the glass or the reversing automatic document feeder (optional) and the following message is displayed:

Auto Start

press the **FUNCTION CLEAR** or the **C/ⓄCLEAR/STOP** key.

● Cancelling the job while waiting for the original to be copied

Deleting the data waiting to be printed (except for the above case) ▶ Page 2-12

4. INTERRUPT COPYING

While multicopying is in progress, you can interrupt it and make copies from different originals.

1 Press the INTERRUPT key.

- This message appears:

Job interrupted job 1 saved

- While an original is being scanned, the interrupt job will be preset.

2 Place the original. ▶ Page 2-4

- Select other copy modes as required.

3 Press the START key.

4 After you have finished interrupt copying, press the INTERRUPT key again.

- The following message appears:

READY to resume job 1

The previous interrupted copy run will resume.

Tip

Without performing step 4, the interrupt copying mode will automatically be cancelled and the previously interrupted copy job will resume in a certain period of time after the interrupt copying has been finished.

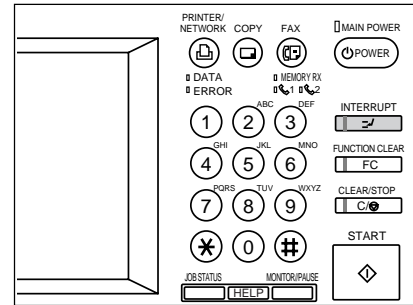

5. STOPPING THE COPY OPERATION

If you want to stop the operation during the scanning of the original or multicopying, use the **(C/☑) CLEAR/STOP** key.

2

Stopping the Scanning of the Original

1 Press the **(C/☑) CLEAR/STOP** key during the scanning.

- The original scanning operation will be interrupted.

2 If the screen on the right appears, press the **(MEMORY CLEAR)** key.

- The data that are being scanned will be deleted.

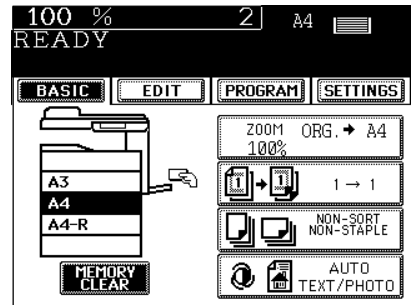

Stopping a Multicopying Operation

1 Press the **(C/☑) CLEAR/STOP** key during the multicopying operation.

- The total copy quantity returns to the default setting (1 which is set when the copier is installed).

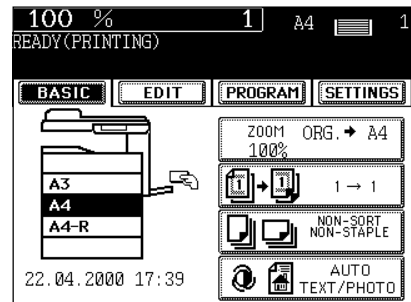

2 Press the **(C/☑) CLEAR/STOP** key again to display the printing job status list, then press the **(DELETE)** key.

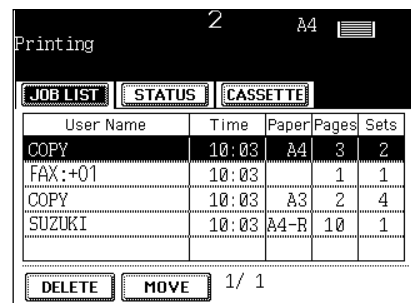

3 Press the **Delete** key.



2

4 The data will be deleted and the multicopying operation will stop.

- If there are other data waiting to be printed, those will start being output.

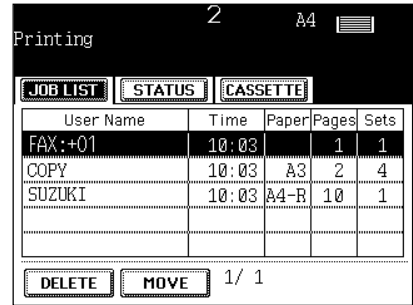

6. DELETING OR CHANGING ORDER OF PENDING JOBS

If data are waiting to be printed, you can delete those data which have become unneeded, or change the printing order.

2

Deleting the Data

In the following procedure, you can delete the data of a multi-copying operation as well.

* The received FAX data cannot be deleted (when the optional facsimile function is installed).

- 1 Press the **JOB STATUS** key on the control panel, then the **JOB LIST** key on the touch panel.

Tip

The screen on the right shows an example of the display when the optional printer and facsimile functions are installed.

User Name	Time	Paper	Pages	Sets
COPY	10:03	A4	3	2
FAX:+01	10:03		1	1
COPY	10:03	A3	2	4
SUZUKI	10:03	A4-R	10	1

- 2 Select the data you want to delete, then press the **DELETE** key.

User Name	Time	Paper	Pages	Sets
COPY	10:03	A4	3	2
FAX:+01	10:03		1	1
COPY	10:03	A3	2	4
SUZUKI	10:03	A4-R	10	1

- 3 Press the **Delete** key.



- 4 The data will be deleted.

• Pressing the **JOB STATUS** or the **FUNCTION CLEAR** key on the control panel or the **RETURN** key on the touch panel causes the basic screen to return.

User Name	Time	Paper	Pages	Sets
COPY	10:03	A4	3	2
FAX:+01	10:03		1	1
SUZUKI	10:03	A4-R	10	1

Changing the Printing Order

- 1 Press the **JOB STATUS** key on the control panel, then the **JOB LIST** key on the touch panel.

Printing 2 A4

JOB LIST **STATUS** **CASSETTE**

User Name	Time	Paper	Pages	Sets
COPY	10:03	A4	3	2
FAX:+01	10:03		1	1
COPY	10:03	A3	2	4
SUZUKI	10:03	A4-R	10	1

DELETE **MOVE** 1/ 1

- 2 Select the data you want to move.

Printing 2 A4

JOB LIST **STATUS** **CASSETTE**

User Name	Time	Paper	Pages	Sets
COPY	10:03	A4	3	2
FAX:+01	10:03		1	1
COPY	10:03	A3	2	4
SUZUKI	10:03	A4-R	10	1

DELETE **MOVE** 1/ 1

- 3 Press the **MOVE** key, then press the position where the selected data are to move to.

- The job to be moved will be shifted next to the selected data.
- The data with top priority (having been printed or suspended) cannot be moved.

Printing 2 A4

JOB LIST **STATUS** **CASSETTE**

User Name	Time	Paper	Pages	Sets
COPY	10:03	A4	3	2
FAX:+01	10:03		1	1
COPY	10:03	A3	2	4
SUZUKI	10:03	A4-R	10	1

DELETE **MOVE** 1/ 1

- 4 The changing order is completed.

- Pressing the **JOB STATUS** or the **FUNCTION CLEAR** key on the control panel or the **RETURN** key on the touch panel causes the basic screen to return.

Printing 2 A4

JOB LIST **STATUS** **CASSETTE**

User Name	Time	Paper	Pages	Sets
COPY	10:03	A4	3	2
SUZUKI	10:03	A4-R	10	1
FAX:+01	10:03		1	1
COPY	10:03	A3	2	4

DELETE **MOVE** 1/ 1

3. SETTING OF BASIC COPY MODES

1. Paper selection	3-2
• Automatic paper selection (APS)	3-2
• Manual paper selection	3-3
• Bypass copying	3-4
2. Reduction and enlargement copying	3-6
3. Selecting types of copying (1-sided, 2-sided, book-type)	3-9
4. Copy density adjustment	3-15
5. Selecting image quality types of originals (text, photo, text/photo)	3-17

1. PAPER SELECTION

Automatic Paper Selection (APS)

When you place regular-sized originals on the glass or in the reversing automatic document feeder (optional), the built-in sensors automatically work to detect the size of the originals, helping the copier select and copy on paper that is the same size as the original. (This mode is default setting.)

- * Depending on the condition of the original, automatic paper selection may not work correctly. In that case, select the paper size manually. ► Page 3-3
- * This mode can only be used for actual-size (100%) copying.
- * For automatically selectable sizes of originals ► Page 2-4

3

1 Confirm that the Automatic Paper Selection mode is selected on the basic screen.

2 Set the original(s). ► Page 2-4

- If the Automatic Paper Selection mode is not selected, press the (ZOOM...) key, then press the (APS) key on the next screen.
- If the following messages are shown, proceed as you are told to:

Change direction of original

Set correct cassette

- Select other copy modes as required.

3 Press the (START) key.

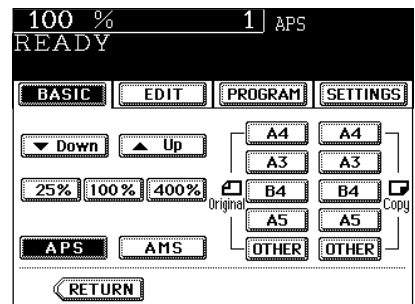
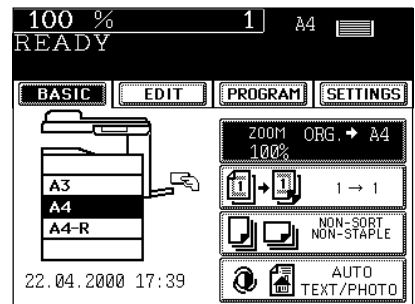
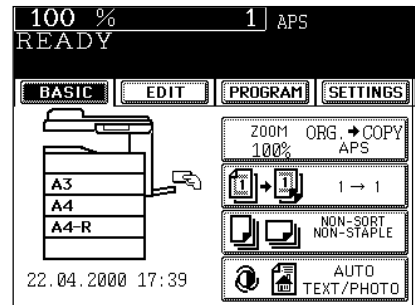

Manual Paper Selection

It may not be possible for the device to perform Automatic Paper Selection with highly transparent originals such as OHP films and tracing paper, wholly dark originals or originals with dark borders, or irregular sized originals such as newspapers and magazines. For these types of originals, use manual paper selection.

1 Set the original(s). ► Page 2-4

2 On the basic screen, press the cassette icon representing the desired paper size.

- Or, press the **ZOOM...** key to enter the next screen, and press the key of the desired paper size.
- Select other copy modes as required.

3 Press the **START** key.

Note

When sheets of paper are set on the sheet bypass, switch to the screen on the right and press the **COPY SIZE** key matching the size of the paper on the sheet bypass to specify the paper size. (Bypass copying ► Page 3-4)

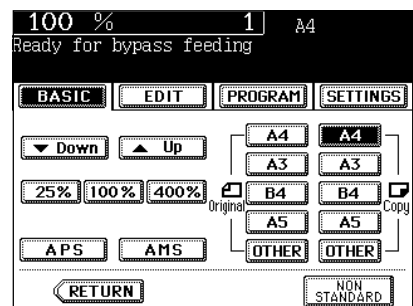
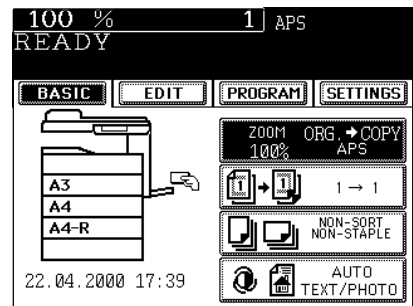
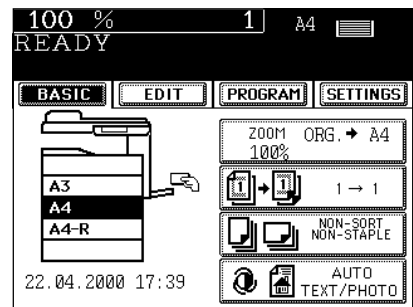

1. PAPER SELECTION (Cont.)

Bypass Copying

When the desired size of paper is not set in any of the cassettes, or when you want to make copies on non-standard size or special type of paper (thick paper, transparency film), use the sheet bypass. The following modes are not available in bypass copying without specifying the paper size: image shift, edge erase, dual-page, duplex, stapling, image editing, alternate stacking, hole punching, magazine sort, saddle stitching, 2 IN 1 / 4 IN 1, annotation or page numbering. However, if you specify the size of paper set on the sheet bypass, you can select any of the above modes in bypass copying.

3

1 Set the original(s). ▶ Page 2-4

2 Set sheets of paper on the bypass guide and align the slides with the size of the paper.

- This message appears:

Ready for bypass copying

- The paper should be placed with the side to be copied facing down.

- If the paper is long-sized, pull out the triple paper holder.
- Types of paper that can be used in bypass copying
▶ Page 1-9

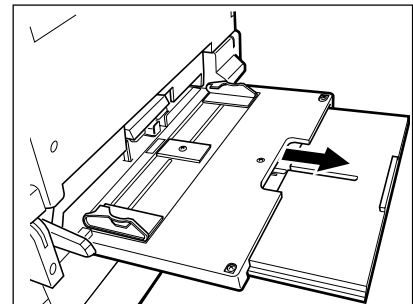
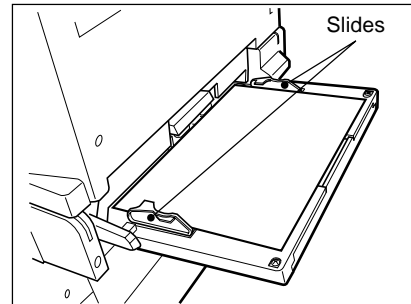

When Standard Size Paper is Set

3 Select the paper size.

- The screen on the right automatically appears when the paper is placed on the bypass guide.
- Press the **(COPY SIZE)** key corresponding to the size of the paper that has been set on the bypass guide.
- When specifying A4-R size, press the **(A4)** key twice, and the paper size displayed on the upper right of the screen will change accordingly.
- Select other copy modes as required.

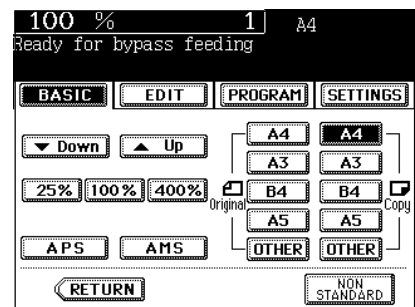

4 Press the **(START)** key.

Note

Remove copies made on special sheets of paper or OHP films one by one. They should not be allowed to stack up in the exit (inner) tray or finisher (optional).

3-4

When Non Standard Size Paper is Set

Set the paper size within the following ranges:

Length: 100 mm ~ 297 mm

Width: 148 mm ~ 432 mm

3 Press the **NON STANDARD** key.

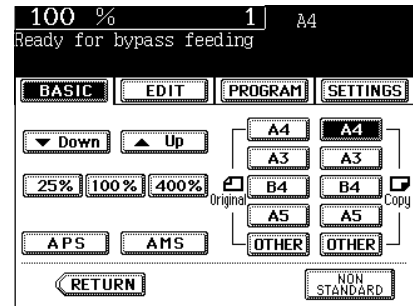

4 Key in each dimension (length, width).
• Key in the length with the digital keys and press the upper **SET** key. Similarly, set the value for width.

5 Check the input size, then press the lower **SET** key.

- Select other copy modes as required.

6 Press the **START** key.

Note

Remove copies made on special sheets of paper or OHP films one by one. They should not be allowed to stack up in the exit (inner) tray or finisher (optional).

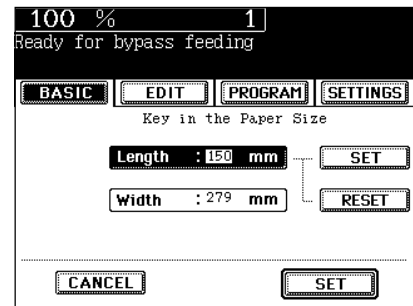

2. REDUCTION AND ENLARGEMENT COPYING

3

There are the following three ways of making copies in the reduction and enlargement mode:

- Using Automatic Magnification Selection (AMS)
 - Specifying both original size and copy size
 - Using the reduction/enlargement zoom keys or the one-touch zoom keys
- * It may not be possible for the device to perform Automatic Magnification Selection with highly transparent originals such as OHP films and tracing paper, wholly dark originals or originals with dark borders, or irregular sized originals such as newspapers and magazines. For these types of originals, use the other reduction/enlargement modes.

Using Automatic Magnification Selection (AMS)

1 Press the **ZOOM...** key on the basic screen.

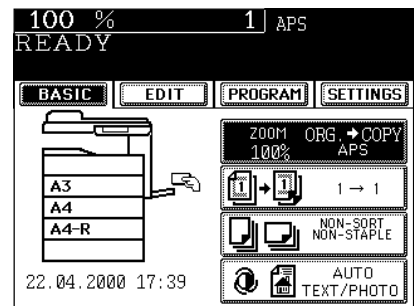

2 Press the **AMS** key, then press the desired **COPY SIZE** key.

3 Set the original(s). ► Page 2-4

- The built-in sensors automatically detect the size of the original(s) and computes the reproduction ratio using the specified paper size.
- If the following messages are shown, proceed as directed:

Change direction of original

Set reduction cassette

- Select other copy modes as required.

4 Press the **START** key.

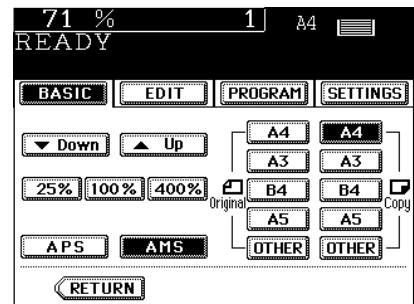

Specifying both Original Size and Copy Size

- 1** Set the original(s). ▶ Page 2-4
- 2** Press the **ZOOM...** key on the basic screen.

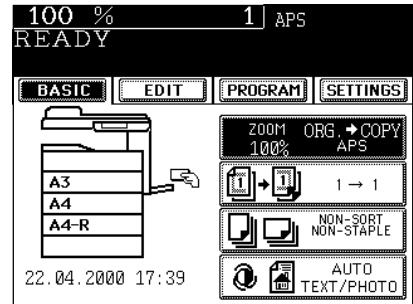

- 3** Press the **ORIGINAL SIZE** key of the same size as the original, then press the desired **COPY SIZE** key.

- Using the original size and copy size, the correct reproduction ratio is computed and displayed on the screen. (**OTHER** key ▶ Page 5-12)
- If the desired size of paper is not set in any of the cassettes, this message appears:

Set correct cassette

Then, install the correct sized cassette or use the sheet bypass.

- Select other copy modes as required.

- 4** Press the **START** key.

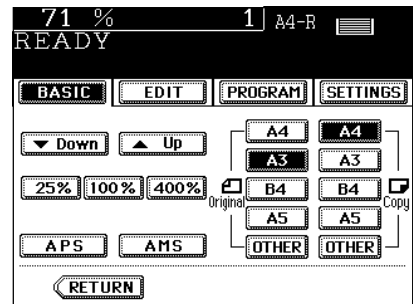

2. REDUCTION AND ENLARGEMENT COPYING (Cont.)

Using the Reduction/Enlargement Zoom Keys or One-touch Zoom Keys

1 Set the original(s). ► Page 2-4

2 Press the cassette icon representing the desired copy paper size, then press **ZOOM----** key.

- You can also select the desired copy paper size on the screen in step 3.

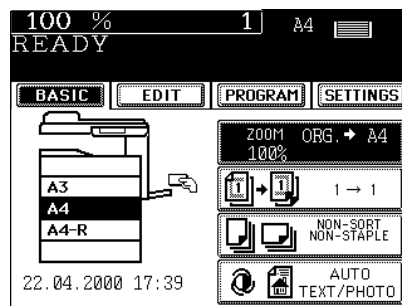

3 Press the **▲ UP** (or **▼ DOWN**) key to set the desired reproduction ratio.

- Each time you press either key, the reproduction ratio changes by 1%. Holding down the key changes it continuously.
- You can select 400%, 100% or 25% at the touch of the **400%**, **100%** or **25%** key, respectively.
- Select other copy modes as required.

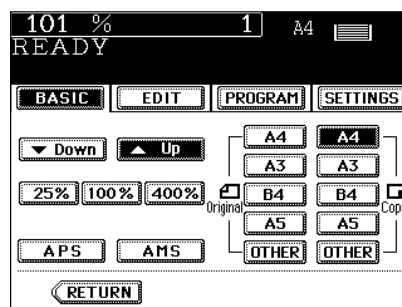

4 Press the **START** key.

3. SELECTING TYPES OF COPYING (1-SIDED, 2-SIDED, BOOK-TYPE)

This function allows you to set the type of originals (1-sided, 2-sided or book-type) and the desired type of copying (1-sided or 2-sided).



*③ and ④ require the optional reversing automatic document feeder to be installed.

3. SELECTING TYPES OF COPYING (1-SIDED, 2-SIDED, BOOK-TYPE) (Cont.)

① 1-Sided Originals ▶ 1-Sided Copies (default setting)

1 Set the original(s). ▶ Page 2-4

2 Confirm that the **1→1** mode is selected in the basic mode.

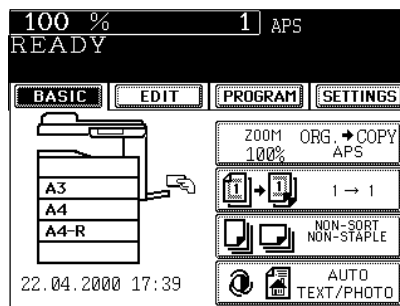

- If the “1-SIDED ▶ 1-SIDED” mode is not selected, press the key (shaded) in the figure on the right, then press the **1→1** key on the next screen.

- Select other copy modes as required.

3 Press the **START** key.

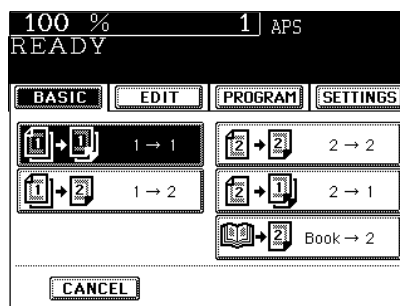
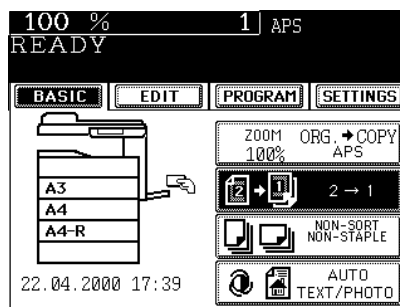

② 1-Sided Originals ▶ 2-Sided Copies

1 On the basic screen, press the key (shaded) in the figure on the right.

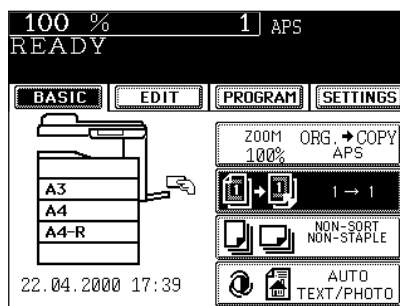

2 Press the **1→2** key.

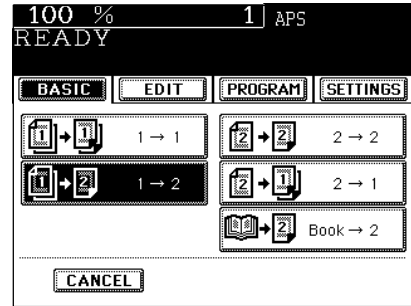

3 Place the originals. ► Page 2-4

- Changing direction of copy images ► Page 4-24
- Select other copy modes as required.

4 Press the **START** key.

When Placing an Original on the Glass

5 Place the next original (2nd side) and press the **START** key.

- You can press the **YES** key and then the **START** key to do the same operation.
- Repeat the above procedure until all your originals have been scanned.

6 When all your originals have been scanned, press the **FINISHED** key.

- Copying begins.

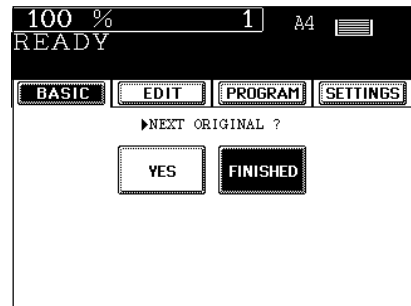

3. SELECTING TYPES OF COPYING (1-SIDED, 2-SIDED, BOOK-TYPE) (Cont.)

③ 2-Sided Originals ▶ 2-Sided Copies

The optional reversing automatic document feeder must be installed.

- 1 Set the originals.** ▶ Page 2-6
 - Changing direction of copy images ▶ Page 4-24
- 2 On the basic screen, press the key (shaded) in the figure on the right.**

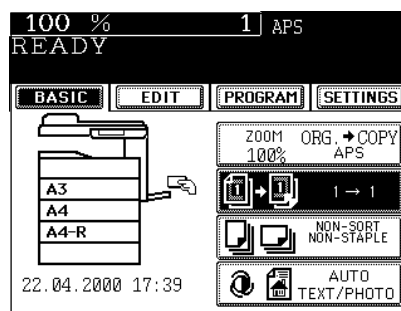

- 3 Press the **2→2** key.**
 - Select other copy modes as required.

- 4 Press the **START** key.**

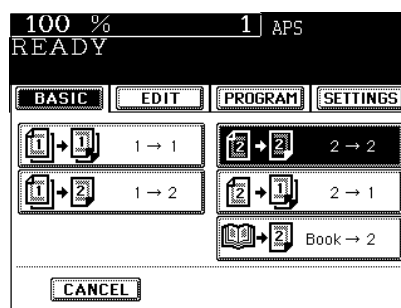

④ 2-Sided Originals ▶ 1-Sided Copies

The optional reversing automatic document feeder must be installed.

- 1 Set the originals.** ▶ Page 2-6
 - Changing direction of copy images ▶ Page 4-24
- 2 On the basic screen, press the key (shaded) in the figure on the right.**

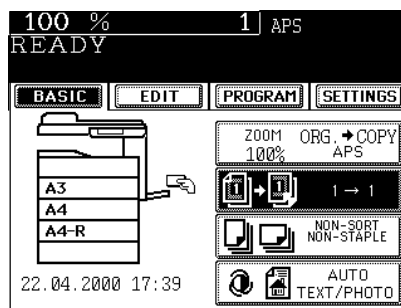

3 Press the **(2→1)** key.

- Select other copy modes as required.

4 Press the **(START)** key.

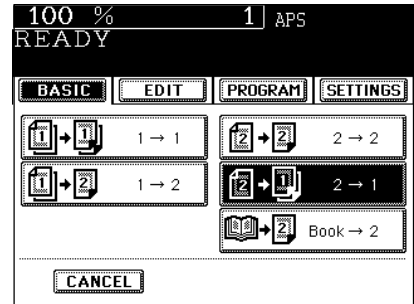

3

⑤ Book-Type Originals ▶ 2-Sided Copies

1 On the basic screen, press the key (shaded) in the figure on the right.

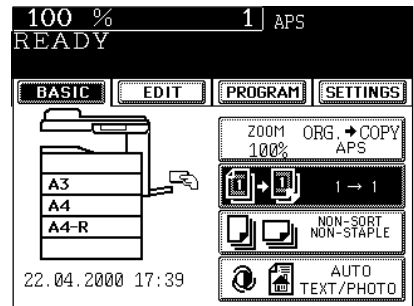

2 Press the **(BOOK→2)** key.

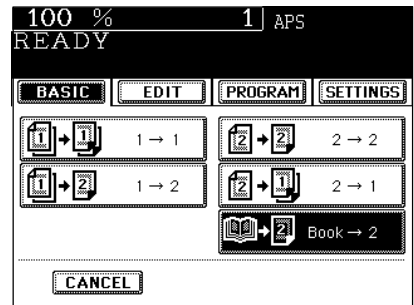

3 Select the book copying type.

- Press the **(RIGHT→RIGHT)** key if copying should start at a right-hand page and end at a right-hand page. By the same token, you can choose from among the **(RIGHT→LEFT)**, **(LEFT→LEFT)** and **(LEFT→RIGHT)** keys.

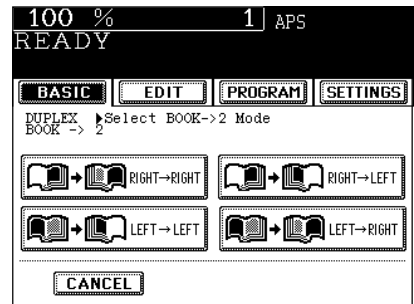

3. SELECTING TYPES OF COPYING (1-SIDED, 2-SIDED, BOOK-TYPE) (Cont.)

4 Select the paper size.

- Select A4 size of paper.
Manual paper selection ► Page 3-3

5 If you need a binding space, select the book margin mode from the image shift copying function.

- Image shift copying ► Page 4-2
- Select other copy modes as required.

3

6 Place the first page(s) to be copied on the glass, and press the **START** key.

- If you do not copy your originals from the first page, the copies will not be arranged in the same order as the original.
- Centre the book on the yellow indicator line with the bottom toward you.

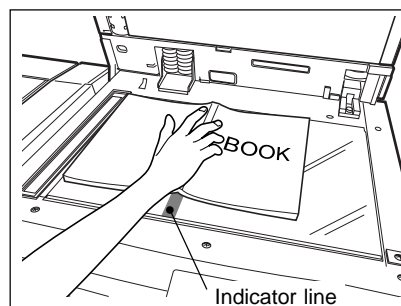

7 Turn to the next page, set the book again and press the **START** key.

- Repeat the above procedure until all your originals have been scanned.

8 After all your originals have been scanned, press the **FINISHED** key.

Press the **COPY FINAL PAGE** key if the last original has only one page.

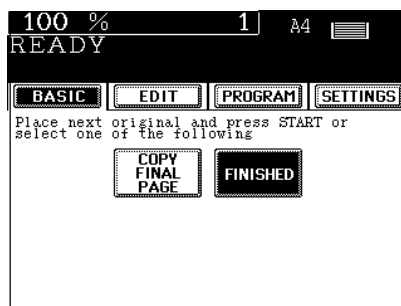

4. COPY DENSITY ADJUSTMENT

There are two types of image density adjustments: automatic mode (default setting) and manual mode. In the automatic mode, the sensors automatically detect the density of each original and select the optimum image density. In the manual mode, you can select the desired level of image density. It is recommended that lighter-density originals be copied in the manual copy density mode.

Automatic Copy Density Mode

1 Set the original(s). ▶ Page 2-4

2 Confirm that “AUTO” is displayed on the basic screen.

- If the automatic density mode is not selected, press the **MANUAL** key, then press the **AUTO** key on the next screen.
- Select other copy modes as required.

3 Press the **START** key.

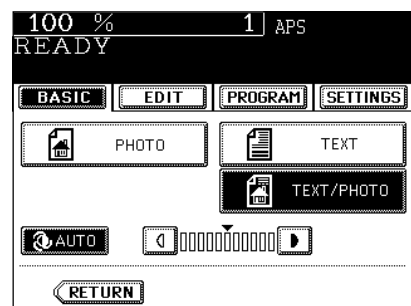
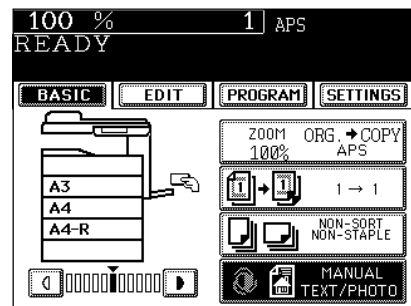
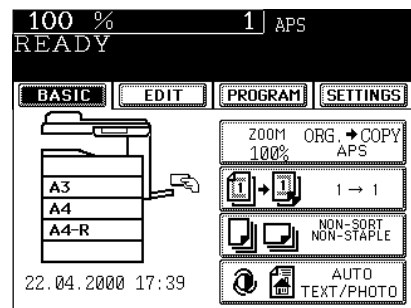

4. COPY DENSITY ADJUSTMENT (Cont.)

Manual Copy Density Mode

- 1 Set the original(s). ► Page 2-4
- 2 Press the **AUTO** on the basic screen.

3

- 3 Press either **◀** or **▶** key to adjust the copy density to the desired level.

- Each time you press the **◀** or **▶** key, your copies will become lighter or darker, respectively.

- When the DENSITY LEVEL key is shown on the lower left of the screen, you can adjust the density manually on the basic screen.

- Select other copy modes as required.

- 4 Press the **◀▶START** key.

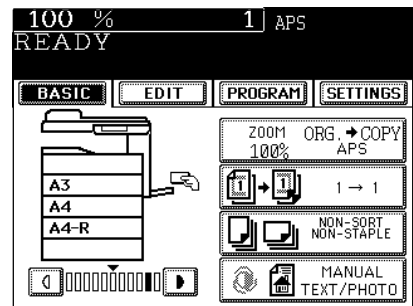
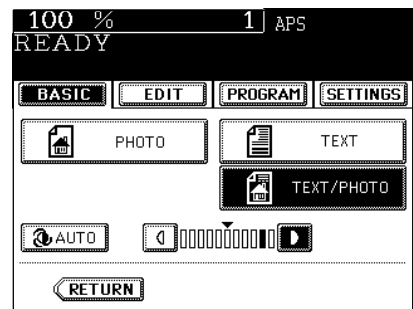
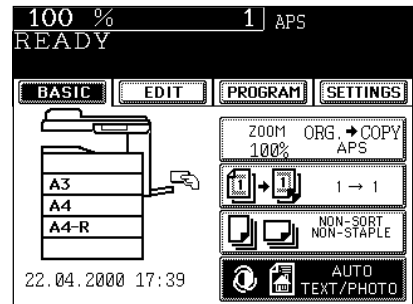

5. SELECTING IMAGE QUALITY TYPES OF ORIGINALS

According to the type of your originals, you can choose among the three image types: Photo, Text or Text/Photo (default setting). The Photo mode is suitable for copying photo originals, whereas the Text mode is preferable for copying originals containing text only (or text and line artwork only). The Text/Photo mode is to be selected for originals containing photo and text mixed together.

1 Set the original(s). ► Page 2-4

2 On the basic screen, press the key (shaded) in the figure on the right.

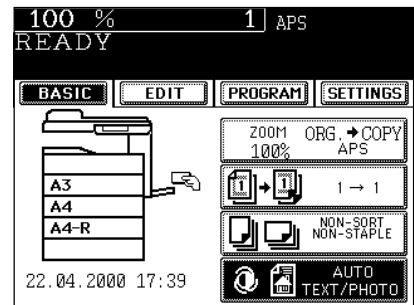

3 Choose the desired image type mode by pressing one of the **TEXT**, **PHOTO** and **TEXT/PHOTO** keys.

- Select other copy modes as required.

4 Press the **START** key.

Tip

The amount of toner consumed varies depending on the selected image quality mode. ► Page 7-9

- The amount of toner consumed by copying the same original is in the following order:
PHOTO<TEXT/PHOTO<TEXT

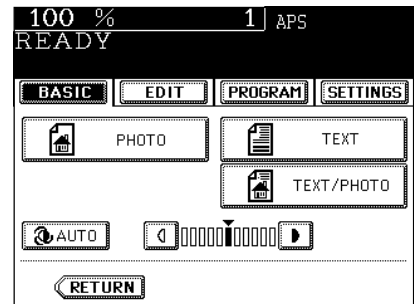

4. USING THE EDITING FUNCTIONS

1. Image shift copying	4-2
2. Edge erase copying	4-4
3. Dual-page copying	4-5
4. X-Y zoom copying	4-6
5. Image editing	4-7
• Trimming/Masking	4-7
• Mirror image	4-9
• Negative/Positive reversal	4-10
6. 2 IN 1 / 4 IN 1 copying	4-11
7. Copying with annotation added	4-13
8. Page numbering copying	4-14
9. Magazine sort copying (from editing menu)	4-16
10. Cover sheet copying	4-18
11. Sheet insertion copying	4-20
12. Document storage	4-22
13. Direction of copy images	4-24

1. IMAGE SHIFT COPYING

With this feature, a margin for binding is created on each copy. You can place a binding margin on either the right or left side of the copy. You can also create binding margins on copies of book originals if you use this mode in combination with the Dual-Page mode (double-sided) or duplex copying from book originals. The default of the binding margin is 7 mm, but it can be adjusted to between 0 to 30 mm.

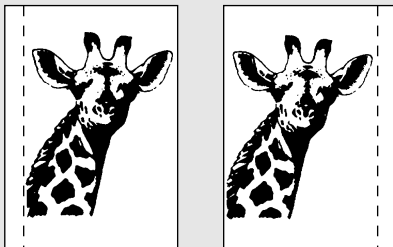

4

1 Set the original(s). ▶ Page 2-4

2 Press the **EDIT** key to enter the editing menu. Then, press the **IMAGE SHIFT** key.

- If the key for the desired function is not shown, press the **Pre** key to switch the screen.

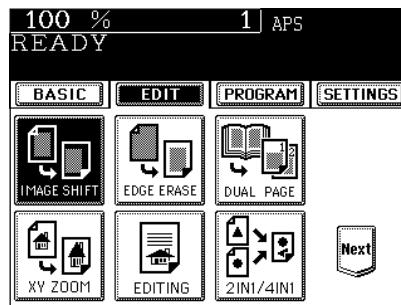

Providing Right or Left Margin

3 Press the **LEFT** (or **RIGHT**) key according to your binding side.

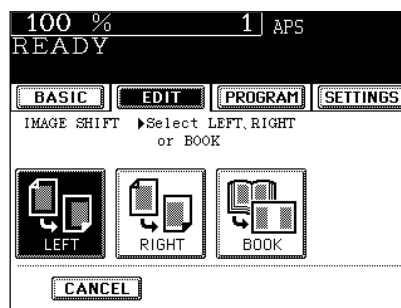

4 Adjust the width of the margin, then press the **SET** key.

- The default width of the margin is 7 mm.
- To adjust the width, press the **(◀0mm)** or **(30mm▶)** key and select the desired number, then press the **SET** key.
- In duplex copying, margins on the back are created on the other side of those in the front.
Duplex copying ▶ Page 3-10

- Select other copy modes as required.

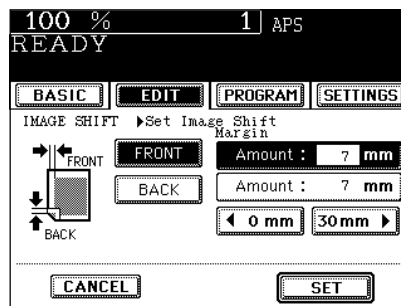

5 Press the **START** key.

Providing Book-binding Margin

When Book Margin is selected, use it in conjunction with the DUPLEX COPYING mode from book originals (▶ Page 3-13) or the Dual-Page Copying mode (double-sided) (▶ Page 4-5).

3 Press the **BOOK** key.

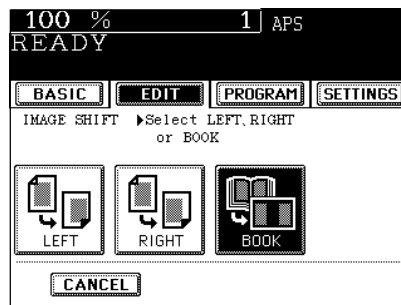

4 Adjust the width of the margin, then press the **SET** key.

- The default width of the margin is 14 mm.
- To adjust the width, press the **(◀2mm)** or **(30mm▶)** key to select the desired number, then press the **SET** key.

- Select other copy modes as required.

5 Press the **START** key.

Tip

Image shift copying can also be performed in bypass copying. To do this, after setting paper in the bypass tray (▶ Page 3-4), press the corresponding **(COPY SIZE)** key to specify the size of the paper.

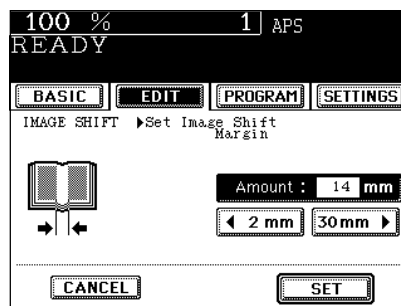

2. EDGE ERASE COPYING

If your original has a dirty or torn edge, it may be reproduced as a black stain on the copy. In that case, use Edge Erase Copying. A white border is created along the edges of the copy, eliminating those black stains. The default width of the white border is 5 mm, but it can be adjusted between 5 to 20 mm.

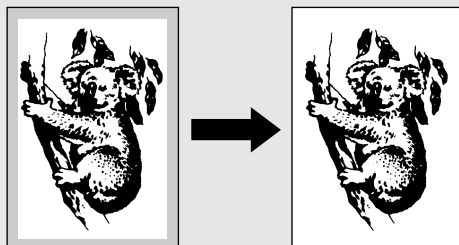

4

1 Set the original(s). ▶ Page 2-4

2 Press the **EDIT** key to enter the editing menu. Then, press the **EDGE ERASE** key.

- If the key for the desired function is not shown, press the **Pre** key to switch the screen.

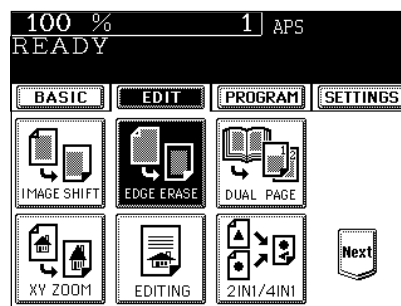

3 Adjust the width of the white border, then press the **SET** key.

- The default width of the white border is 5 mm.
- To adjust the width, press the **◀5mm** or **20mm▶** key and select the desired number, then press the **SET** key.
- Select other copy modes as required.

4 Press the **START** key.

Tip

Edge Erase copying can also be performed in bypass copying. To do this, after setting paper in the bypass tray (▶ Page 3-4), press the corresponding **COPY SIZE** key to specify the size of the paper.

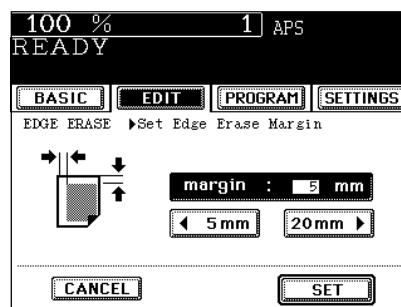

3. DUAL-PAGE COPYING

Utilizing this feature allows the facing pages of a book or magazine to be copied page by page onto two separate sheets of paper or duplex-copied on one sheet. There is no need to move the original on the glass. You can also place a pair of A4 sized originals side by side and copy them on separate sheets of paper.

* Only A4 sized sheets of paper can be used in this mode.

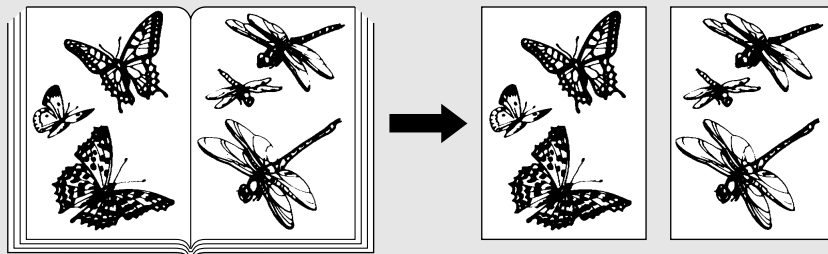

1 Set the original(s). ▶ Page 2-5

- To use this mode in combination with the enlargement or reduction function, select the reproduction ratio before setting the originals on the glass.

2 Press the **EDIT** key to enter the editing menu. Then, press the **DUAL PAGE** key.

- If the key for the desired function is not shown, press the **Pre** key to switch the screen.

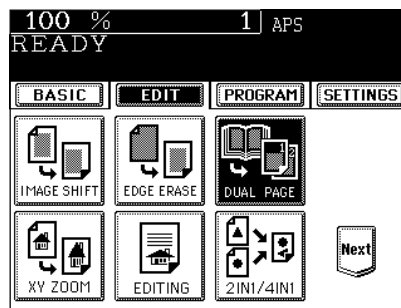

3 Press the **1 SIDE** or **2 SIDE** key.

- Select the **1 SIDE** to make copies of the facing pages on two separate sheets of paper page by page. Select the **2 SIDE** to make duplex copies of them on one sheet.

4 Press the **BASIC** key to enter the basic menu, then select A4 copy size.

- Select other copy modes as required.

5 Press the **START** key.

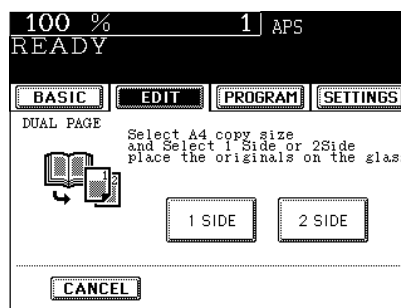

4. X-Y ZOOM COPYING

You can make copies with different reproduction ratios set for the X (horizontal) and Y (vertical) directions, respectively.

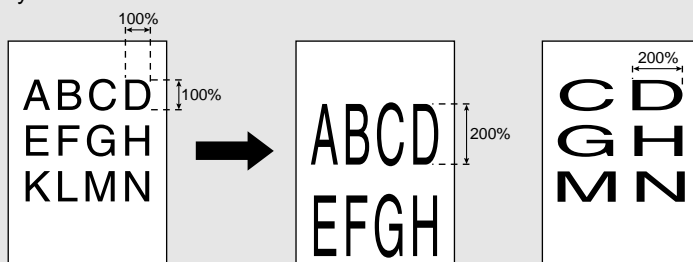

4

1 Set the original(s). ► Page 2-4

2 Press the **EDIT** key to enter the editing menu. Then, press the **XY ZOOM** key.

- If the key for the desired function is not shown, press the **Pre** key to switch between the screens.

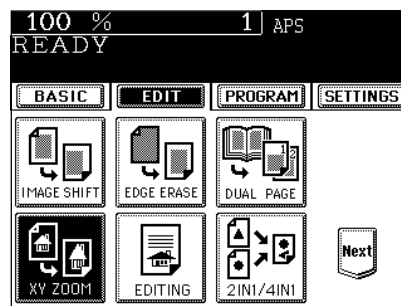

3 Select the reproduction ratios for the X (horizontal) and Y (vertical) directions, respectively.

- Using the **25%<** or **>400%** keys on the screen, select the reproduction ratio for X and press the upper **SET** key. Similarly, set the reproduction ratio for Y.

4 Press the lower **SET** key.

- Select other copy modes as required.

5 Press the **START** key.

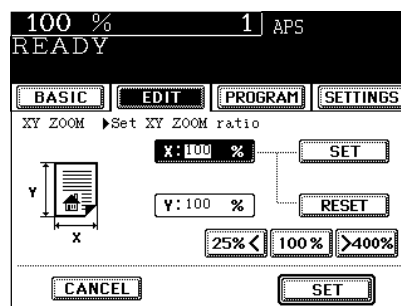

5. IMAGE EDITING

Trimming/Masking

You can select areas on an original and copy it with the areas trimmed (only the inside of the areas copied) or masked (only the outside of the areas copied). Up to four areas can be specified on an original.

- * If the settings of the original and copy sizes are not made appropriately, the image may not be copied completely.
- * When using this mode in bypass copying, be sure to specify the copy size. ► Page 3-4
- * Image editing is only possible with Standard sized originals.

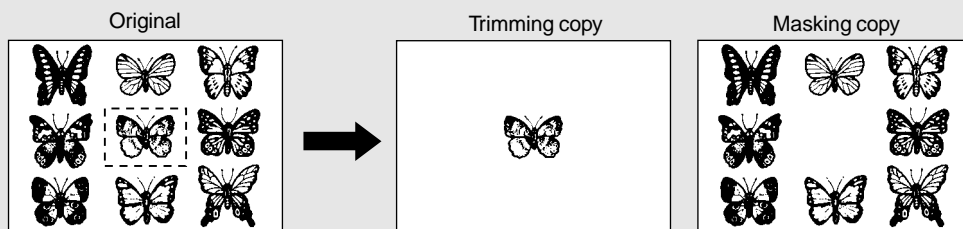

1 Place an original on the glass to specify areas.

- Set the original face up with the bottom toward you, fit its top left corner against the top left corner of the glass, and align it with the original scale.

2 Using the original scale on the left and the inner (top) scale, read the position of the desired area, as follows:

- X1 Distance from the top left to the left edge of the specified area.
- X2 Distance from the top left to the right edge of the specified area.
- Y1 Distance from the top left to the upper edge of the specified area.
- Y2 Distance from the top left to the lower edge of the specified area.

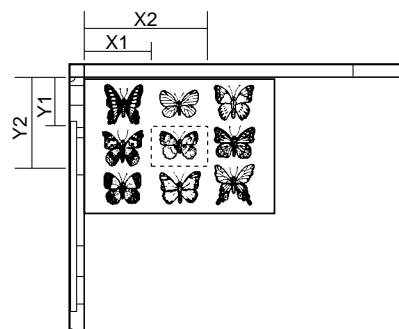

3 Press the **EDIT** key to enter the editing menu. Then, press the **EDITING** key.

- If the key for the desired function is not shown, press the **Pre** key to switch the screen.

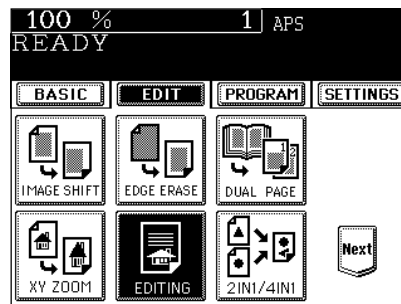

5. IMAGING EDITING (Cont.)

Trimming/Masking (Cont.)

4 Press the **TRIM** (or **MASK**) key.

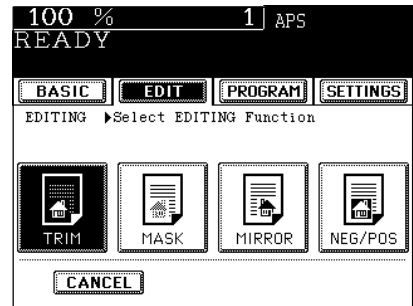

5 Enter the distance values for the specified area.

- Key in the value for X1 with the digital keys and press the upper **SET** key.
- Similarly, set the values for X2, Y1 and Y2.
- When X1, X2, Y1 and Y2 have been set, the screen automatically changes to specify the subsequent area. Subsequent areas, if any, can be set using the same procedure.

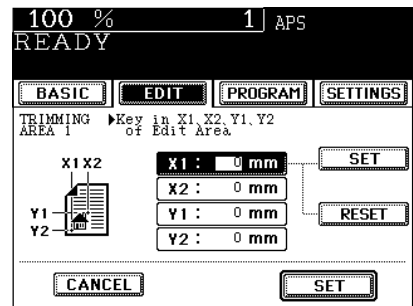

6 Press the lower **SET** key.

7 Set the original(s). ▶ Page 2-4

- Select other copy modes as required.

8 Press the **START** key.

Mirror Image

Copies are made with images completely reversed in terms of the right and the left.

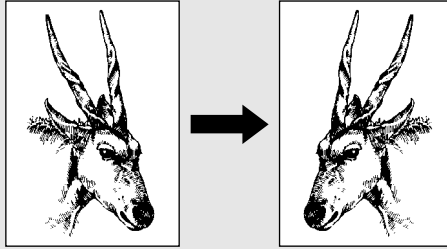

1 Set the original(s). ▶ Page 2-4

2 Press the **EDIT** key to enter the editing menu. Then, press the **EDITING** key.

- If the key for the desired function is not shown, press the **Pre** key to switch the screen.

3 Press the **MIRROR** key.

- Select other copy modes as required.

4 Press the **START** key.

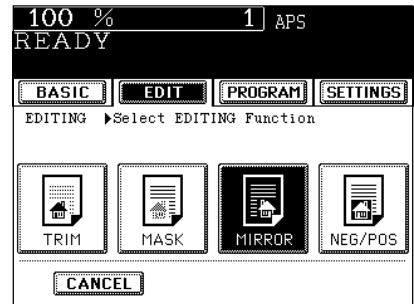
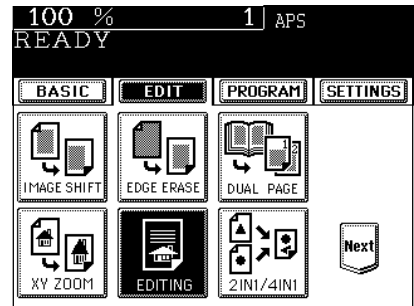

5. IMAGING EDITING (Cont.)

Negative/Positive Reversal

Originals are copied with their white areas black and black areas white.

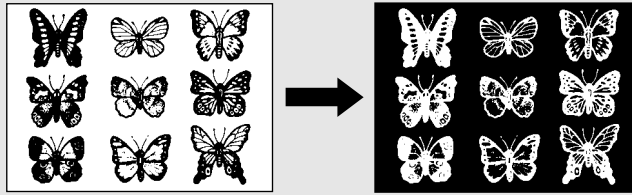

4

1 Set the original(s). ▶ Page 2-4

2 Press the **EDIT** key to enter the editing menu. Then, press the **EDITING** key.

- If the key for the desired function is not shown, press the **Pre** key to switch the screen.

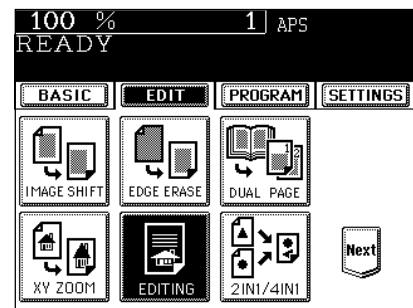

3 Press the **NEG/POS** key.

- Select other copy modes as required.

4 Press the **START** key.

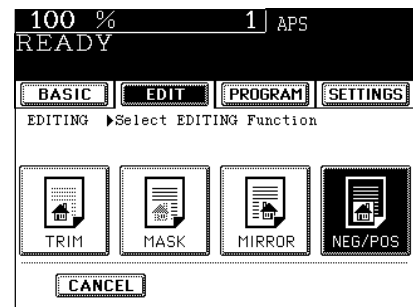

6. 2 IN 1 / 4 IN 1 COPYING

This feature allows multiple originals to be reduced and copied onto a single sheet of paper. There are two modes: 2 IN 1 copying, where two originals are reduced and copied onto a single sheet, and 4 IN 1 copying, where four originals are reduced and copied onto a single sheet. In addition, duplex 2 in 1 / 4 IN 1 modes are available, where four/eight originals can be copied to a single sheet of paper.

* This mode cannot be used in combination with reduction/enlargement copying.

● Example of 2 IN 1 1st

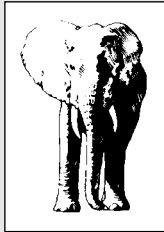

2nd

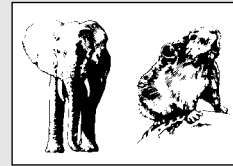

● Example of 4 IN 1 1st

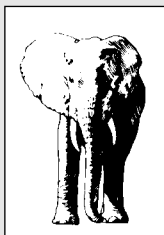

2nd



3rd

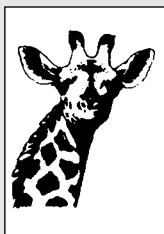

4th

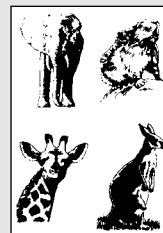

When Using the Reversing Automatic Document Feeder (optional)

1 Set the originals. ▶ Page 2-6

2 Press the **EDIT** key to enter the editing menu. Then, press the **2IN1/4IN1** key.

- If the key for the desired function is not shown, press the **Pre** key to switch the screen.

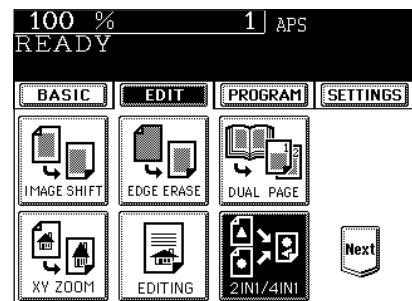

6. 2 IN 1 / 4 IN 1 COPYING (Cont.)

3 Select the type of image combination.

- Press the **2IN1** (or **4IN1** , **2IN1 DUPLEX** or **4IN1 DUPLEX**) key.

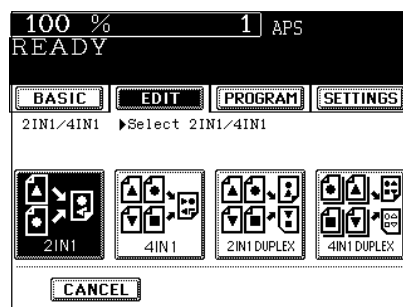

4 Select the type of the original.

- Press **1 SIDE** (or **2 SIDE**) key.
- Select other copy modes as required.

5 Press the **START** key.

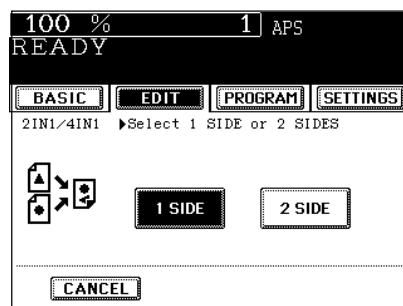

When Placing an Original on the Glass

1 Follow the steps 2 to 5 of “When Using the Reversing Automatic Document Feeder” on page 4-11.

2 Set the original (► Page 2-4), and press the **START** key.

- Set the first page of your originals first.

3 When the first page has been scanned, set the next page and press the **START** key.

- You can also press the **YES** key before pressing the **START** key to perform the same operation.

4 Repeat step 3 for the second and subsequent originals.

5 Once the final original has been scanned, press the **FINISHED** key.

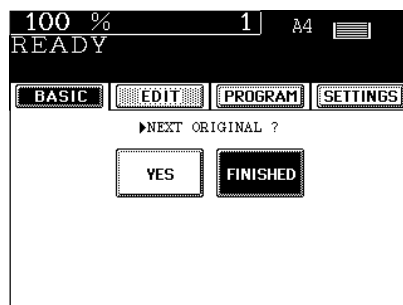

7. COPYING WITH ANNOTATION ADDED

Copies are made with the current date and time, at which they are made, printed on the copy.



Date and time printed at the bottom of the portrait copy

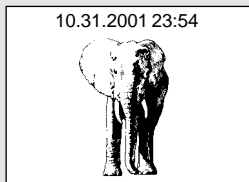

Date and time printed at the top of the landscape

1 Set the original(s). ▶ Page 2-4

2 Press the **EDIT** key to enter the editing menu. Then, press the **ANNOTATION** key.

- If the key for the desired function is not shown, press the **Next** key to switch the screen.

3 Select the orientation (**SHORT EDGE** or **LONG EDGE**) and position (**UPPER** or **LOWER**) of the date and time to be printed. Then, press the **SET** key.

- Select other copy modes as required.

4 Press the **START** key.

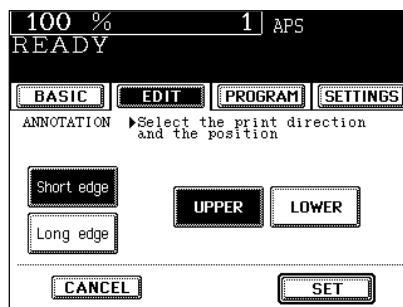
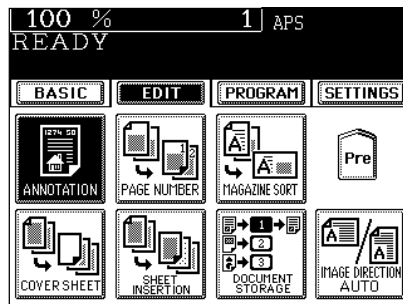

When Placing an Original on the Glass

5 When the first page has been scanned, set the next page and press the **START** key.

- You can also press the **YES** key before pressing the **START** key to perform the same operation.

6 Repeat step 5 for the second and subsequent originals.

7 Once the final original has been scanned, press the **FINISHED** key.



8. PAGE NUMBERING COPYING

This feature allows page numbers to be added at a specified position to copies.

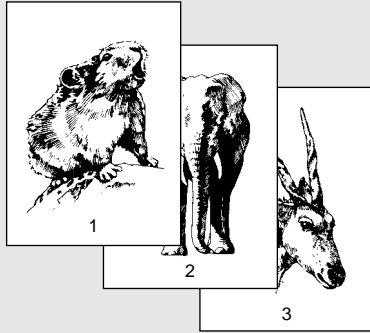

Page number printed at the bottom centre on the portrait copy

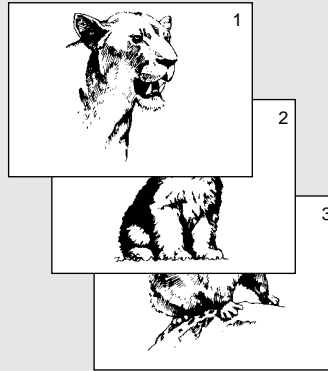

Page number printed at the top right on the landscape copy

4

- 1 Set the original(s). ▶ Page 2-4
- 2 Press the **EDIT** key to enter the editing menu. Then, press the **PAGE NUMBER** key.
 - If the key for the desired function is not shown, press the **Next** key to switch the screen.
- 3 Select the orientation (**SHORT EDGE** or **LONG EDGE**) and position of the page number to be printed. Then, press the **SET** key.
- 4 Key in the start page number with the digital keys, and press the **SET** key.
 - If the start page number is "1", just press the **SET** key.
 - Select other copy modes as required.
- 5 Press the **START** key.

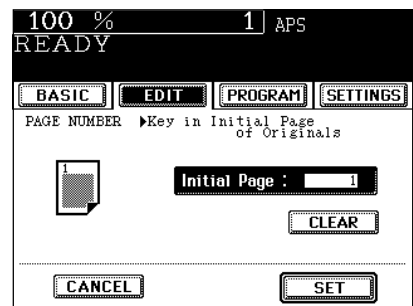
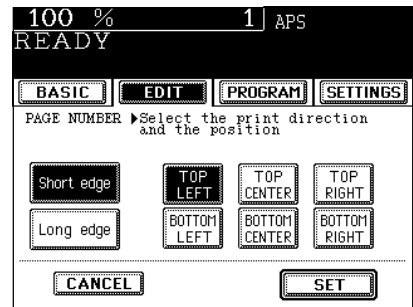
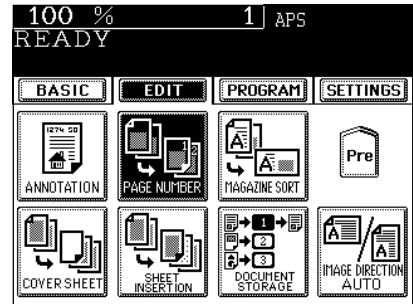

When Placing an Original on the Glass

- 6** When the first page has been scanned, set the next page and press the **START** key.
 - You can also press the **YES** key before pressing the **START** key to perform the same operation.
- 7** Repeat step 6 for the second and subsequent originals.
- 8** Once the final original has been scanned, press the **FINISHED** key.



9. MAGAZINE SORT COPYING (FROM EDITING MENU)

The magazine sort mode allows copies to be made and sorted so they can be folded and bound along a centre line like typical magazines.

- If used in combination with the optional finisher (MJ-1013) equipped with saddle stitch capabilities, copies are automatically folded in half and stapled along their centre line.
- If used in combination with the Cover Sheet mode, blank covers or copied covers can be added at the top of the copies (► Page 4-18). In this case, nothing is printed on the back of the cover sheet.
- * There are two Magazine Sort procedures available. For the mode operated from the **(BASIC)** menu when the finisher (optional) is installed, see page 6-9.
- Example of copying a 12-page document

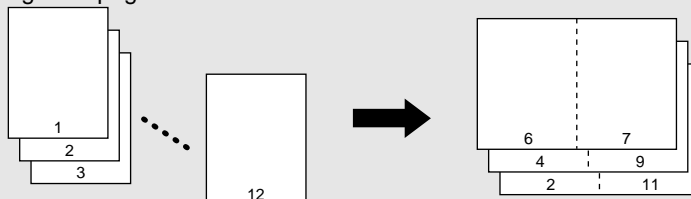

4

1 Set the original(s). ► Page 2-4

2 Press the **(EDIT)** key to enter the editing menu. Then, press the **(MAGAZINE SORT)** key.

- If the key for the desired function is not shown, press the **(Next)** key to switch the screen.

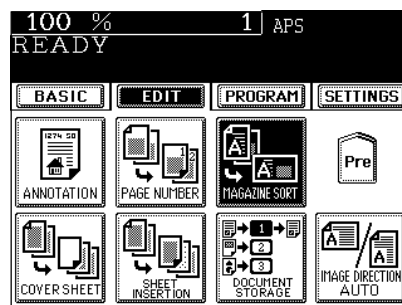

3 Adjust the binding margin and press the **(SET)** key.

- The default width of the margin is 2 mm.
- To adjust the width, press the **(◀ 2mm)** or **(30mm ▶)** key to select the desired number, then press the **(SET)** key.

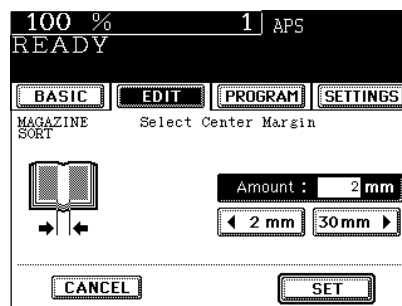

- If the optional finisher (MJ-1013) equipped with the saddle stitcher is installed, copies are automatically stapled along their centre line. To have copies stapled, press the **(STAPLE ON)** key.
- Maximum number of sheets that can be stapled ► Page 6-6
- Select other copy modes as required.

4 Press the **(START)** key.

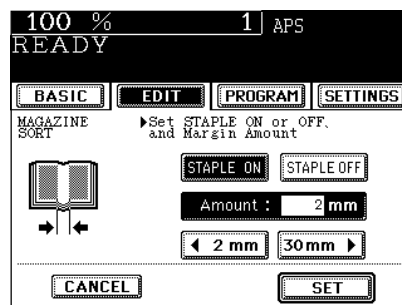

When Placing an Original on the Glass

5 When the first page has been scanned, set the next page and press the **START** key.

- You can also press the **YES** key before pressing the **START** key to perform the same operation.

6 Repeat step 5 for the second and subsequent copies.

7 Once the final original has been scanned, press the **FINISHED** key.

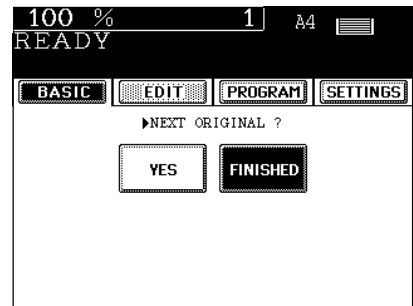

10. COVER SHEET COPYING

A top cover and/or back cover (special sheets, eg. coloured paper) can be added to each set of copies. There are four Cover Sheet modes available:

- Adding a blank top cover
- Adding a copied top cover
- Adding a blank top cover and a blank back cover
- Adding a copied top cover and a blank back cover

Example of adding a blank top cover

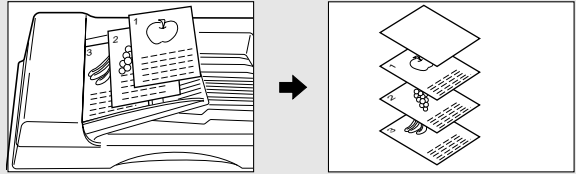

Example of adding a copied top cover

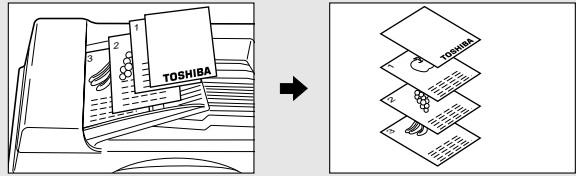

Example of adding a blank top and a back cover

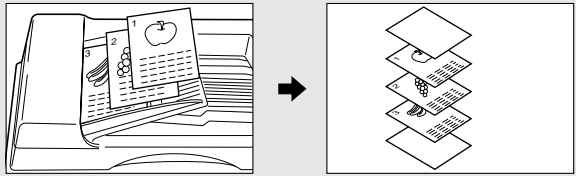

Example of adding a copied top and a blank back cover

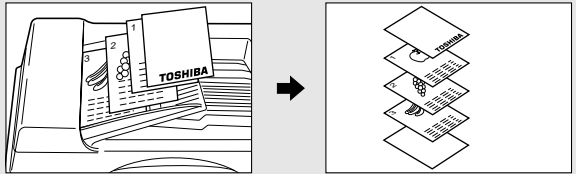

1 Set the original(s). ► Page 2-4

- When placing an original on the glass, set the first page of your originals first.

2 Press the **EDIT** key to enter the editing menu. Then, press the **COVER SHEET** key.

- If the key for the desired function is not shown, press the **Next** key to switch the screen.

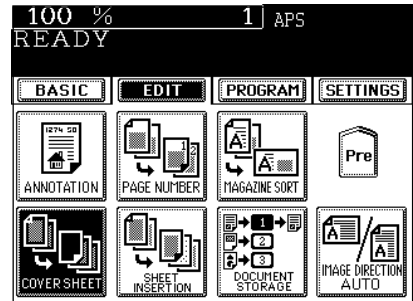

- 3 Press the desired Cover Sheet key:**
- To add a blank top cover (TOP BLANK)
 - To add a copied top cover (TOP COPIED)
 - To add blank top and back covers (BOTH BLANK)
 - To add copied top and blank back covers
..... (TOP COPIED BACK BLANK)

4 Set the cover sheet in the cassette for cover sheet or on the bypass guide.

- Setting cassette for cover sheet (special uses) ► Page 1-11
- Setting the cover sheet on the bypass guide ► Page 3-4

5 Press the (BASIC) key to enter the basic menu, and select the cassette icon representing the correct size and paper direction on the sheet bypass.

- Cassette for cover sheet

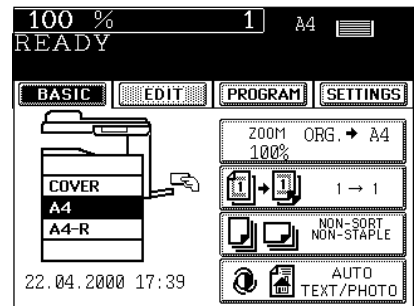
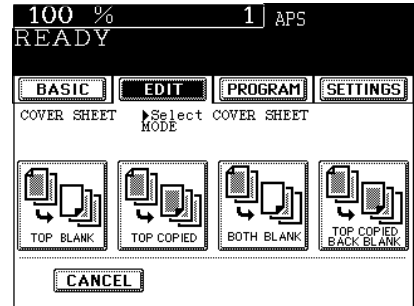

6 Press the (START) key.

Tip

When (TOP COPIED) or (TOP COPIED BACK BLANK) is selected, even if you make copies in the 2-SIDED ORIGINALS TO 2-SIDED COPIES or 1-SIDED ORIGINALS TO 2-SIDED COPIES mode, the cover sheets will only be copied on their top side.

11. SHEET INSERTION COPYING

Special sheets of paper (such as coloured paper) are inserted into a set of copies at specified pages. There are two Sheet Insertion modes available:

- Inserting blank sheets before specified pages
- Inserting copied sheets at specified pages

Example of inserting a blank sheet before the specified page

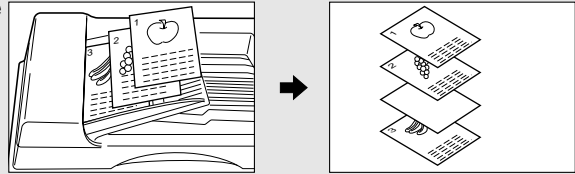

Example of inserting a copied sheet at the specified page

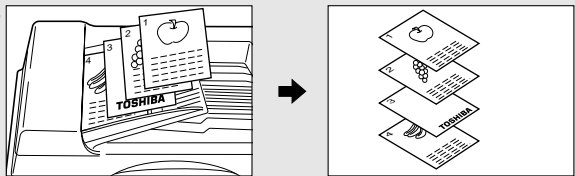

Tip

To make Sheet Insertion copies, you have to set two cassettes (or one cassette and the large-capacity feeder) in the same paper size and direction (one for special insertion sheets and the other for normal sheets of copy paper).

4

1 Set the original(s). ▶ Page 2-6

2 Place sheets of paper in the cassette for sheet insertion. ▶ Page 1-11

3 Press the **EDIT** key to enter the editing menu. Then, press the **SHEET INSERTION** key.

- If the key for the desired function is not shown, press the **Next** key to switch the screen.

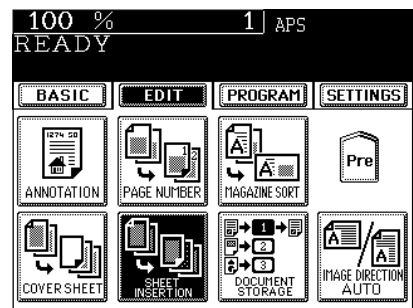

- 4** Press the desired Insertion mode key.
 To insert blank sheets before specified pages (BLANK)
 To insert copied sheets at specified pages (COPIED)

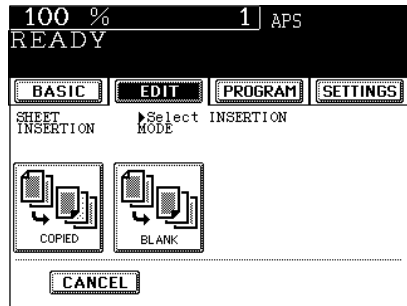

- 5** Using the digital keys, key in the desired page number for insertion and press the (NEXT) key.

- On the display, the page where the first sheet will be inserted is shown. The example on the right shows the first sheet inserted at (or before) page 10.
- To specify the next and subsequent pages, repeat step 5. Up to 15 pages can be specified.
- To have different sheets inserted than Sheet 1, select (SHEET2) and similarly key in the pages where you want the sheets inserted, then press the upper (SET) key.
- Press the (C/⊗CLEAR/STOP) key to correct the (Insert page) number.

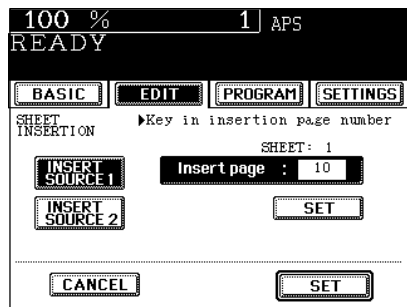

- 6** After you have finished specifying the insertion pages, press the lower (SET) key.

- 7** Press the (BASIC) key to return to the basic menu.

- 8** Press the cassette icon representing the cassette that has the same size and orientation as the special sheets placed in the sheet insertion cassette.

- 9** Set the number of copies (or sets).

- Select other copy modes as required.

- 10** Press the (START) key.

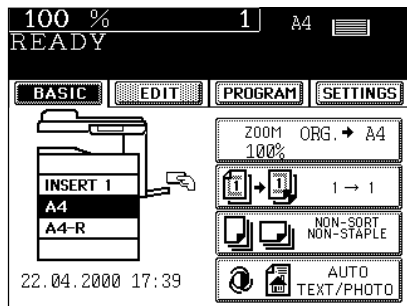

12. DOCUMENT STORAGE

This feature allows images of the originals to be stored on the hard disk of the copier, and copies can be made from the hard disk later. This copying method consists of the following two modes:

- ① MEMORIZE mode Stores original images at the specified location of the hard disk.
- ② PRINT mode Prints the originals stored in the Memorize Mode in ①.

* Originals can be stored in up to 24 locations.
 * Up to 400 original sheets can be stored in each location.

① Storing Documents in the MEMORIZE Mode

4

- 1 Set the original(s). ► Page 2-4
- 2 Press the **EDIT** key to enter the editing menu. Then, press the **DOCUMENT STORAGE** key.
 - If the key for the desired function is not shown, press the **Next** key to switch the screen.

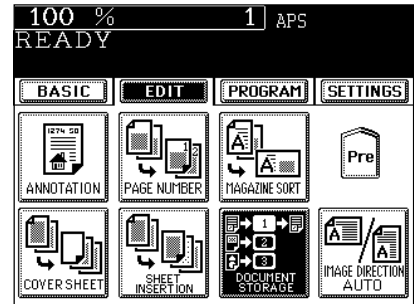

- 3 Press the **MEMORIZE** key.

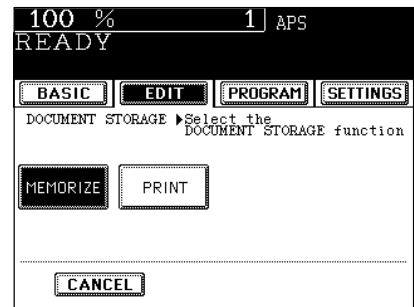

- 4 Press the file name column of the location number (ID) where you want your document stored, key in the file name and press the **SET** key.

- Select any ID where no data have been stored.
- Entering letters ► Page 5-24
- Select other copy modes as required.

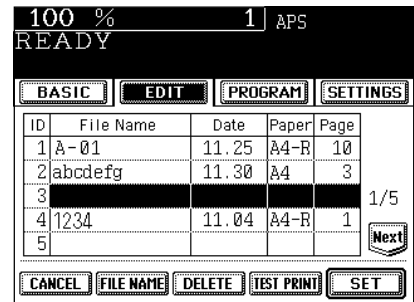

5 Press the **START** key.

- The memorization process starts automatically.

Tips

- To change the file name, select the ID you want to change in the list on the display, press the file name column, delete the file name already entered with the **Space** key in the letter entry screen, then enter a new file name, and press the **SET** key.
- Entering letters ► Page 5-24
- To delete a memorized job, select the ID from the list on the display and press the **DELETE** key. Then press the **Delete** key on the next screen.

② Making Copies in the PRINT Mode

1 Press the **EDIT** key to enter the editing menu. Then, press the **DOCUMENT STORAGE** key.

- If the key for the desired function is not shown, press the **Next** key to switch the screen.

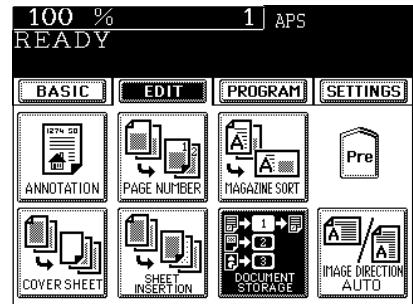

2 Press the **PRINT** key.

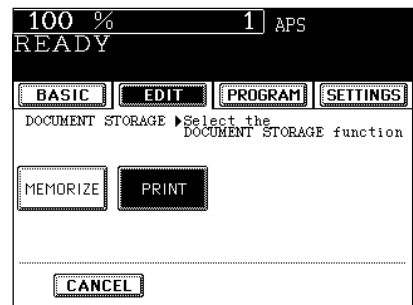

3 Select the ID of the job you want to print out, and press the **SET** key.

- The memorized functions are recalled.
- Select other copy modes as required.

4 Press the **START** key.

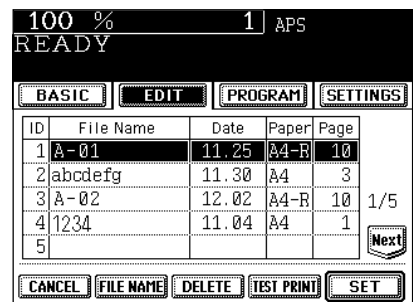

13. DIRECTION OF COPY IMAGES (ROTATION)

This mode allows you to specify the direction of images being scanned.

When copying in the 1-sided originals to 2-sided copies mode, 2-sided originals to 1-sided copies mode or dual-page mode, you can select the direction of images as shown below.

● Duplexed copying from 1-sided originals

* Depending on the combination of the orientation of the originals placed and the selection of one of the (IMAGE DIRECTION AUTO), (IMAGE DIRECTION PORTRAIT) or (IMAGE DIRECTION LANDSCAPE) key, duplex copy output differs as shown below.

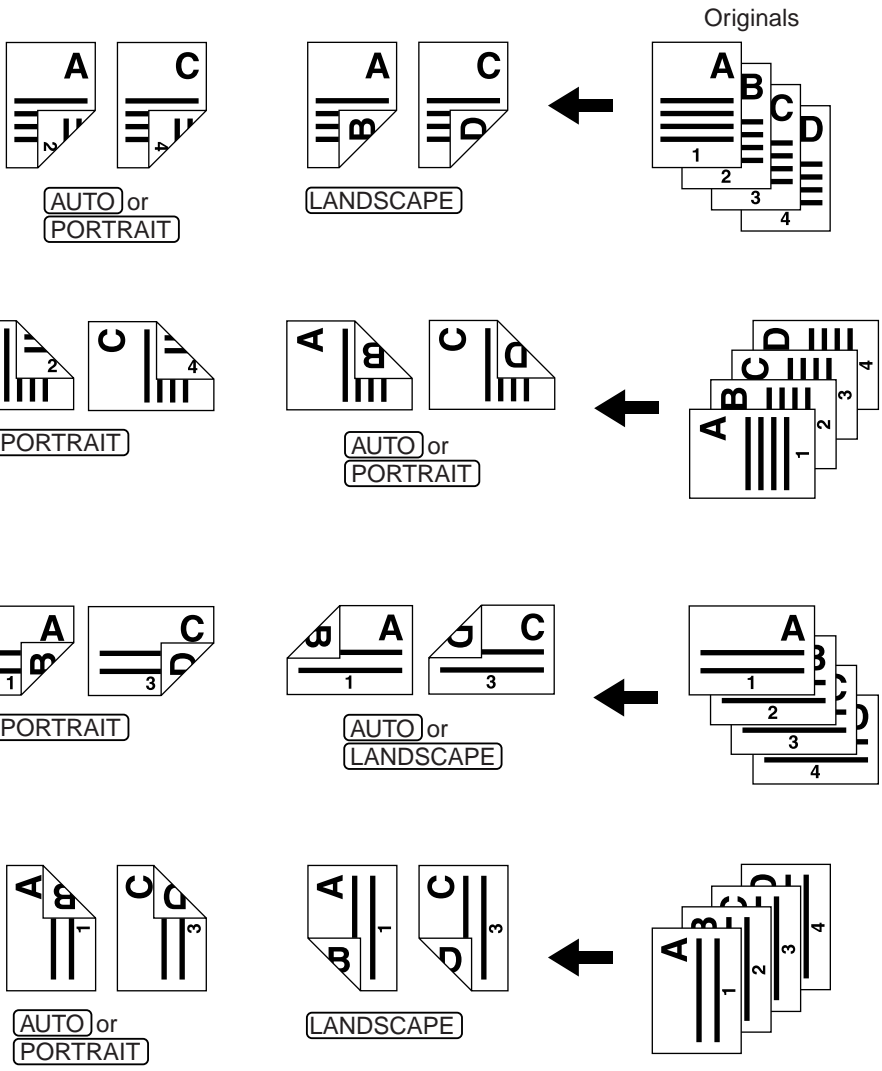

When Using the Reversing Automatic Document Feeder (optional)

- 1 Set the original(s). ► Page 2-4
- 2 Press the **EDIT** key to enter the editing menu. Then, press the **IMAGE DIRECTION** key.
 - If the key for the desired function is not shown, press the **Next** key to switch between the screen.

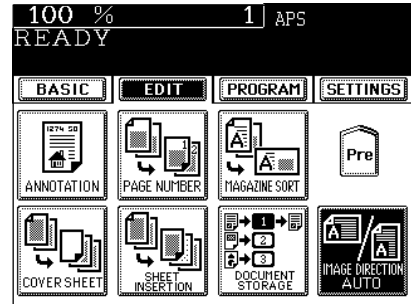

- 3 Press the **IMAGE DIRECTION PORTRAIT** (or **IMAGE DIRECTION LANDSCAPE**) key.

- Select other copy modes as required.

- 4 Press the **START** key.

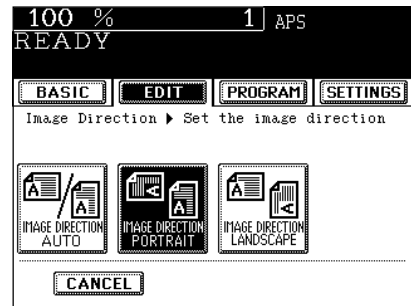

When Placing an Original on the Glass

- 1 Follow the steps 2 to 4 of “When Using the Reversing Automatic Document Feeder”.
- 2 Set the original (► Page 2-4), and press the **START** key.
 - Set the first page of your originals first.
- 3 When the first page has been scanned, set the next page and press the **START** key.
 - You can also press the **YES** key before pressing the **START** key to perform the same operation.
- 4 Repeat step 3 for the second and subsequent originals.

13. DIRECTION OF COPY IMAGES (ROTATION) (Cont.)

5 When the final original has finished being scanned, press the **FINISHED** key.



5. USING THE SPECIAL FUNCTIONS

1. Continuous original feeding/Single original feeding	5-2
2. Copying mixed-sized originals	5-4
3. Mode memory copying	5-5
4. Copying on special types of paper	5-8
5. Weekly timer	5-10
6. Setting the other paper sizes (other key)	5-12
7. Setting the date and time	5-13
8. Setting automatic energy saving mode	5-14
9. Setting automatic shutoff mode	5-15
10. Switching between languages	5-16
11. Department codes	5-17
12. Entering letters	5-24

1. CONTINUOUS ORIGINAL FEEDING/SINGLE ORIGINAL FEEDING

When using the reversing automatic document feeder (optional), you can select the continuous feed mode (default setting) where multiple (or single) originals are continuously fed in one by one, or the single-feed mode where if you insert an original, it is automatically pulled in and starts being copied.

Continuous Feed Mode

- 1 Set the original(s).** ▶ Page 2-6
 - Maximum number of originals that can be set ▶ Page 2-4
- 2 Press the **PROGRAM** key to enter the program menu, and press the **ADF** key.**
 - If the key for the desired function is not shown, press the **Pre** key to switch the display.
- 3 Press the **ADF** key.**
 - Select other copy modes as required.
- 4 Press the **START** key.**

Tip

When the number of originals is too large to be set at one time, you can divide the originals into two sets and set them one after another. To do so, press the **CONTINUE** key while the scanning of the first set is in progress. After the first set has been scanned, place the next set of originals in the reversing automatic document feeder.

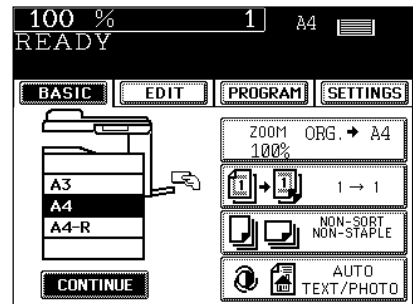
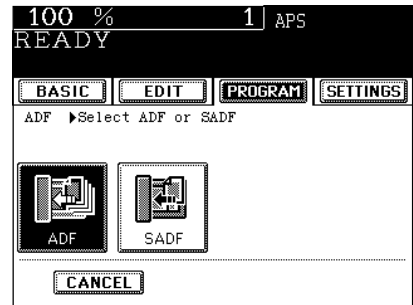
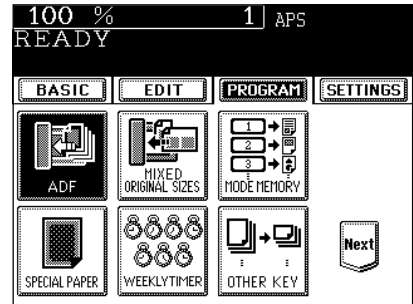

Single-feed Mode

1 Press the **PROGRAM** key to enter the program menu, and press the **ADF** key.

- If the key for the desired function is not shown, press the **Pre** key to switch the screen.

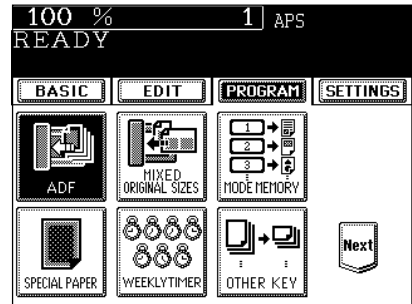

2 Press the **SADF** key.

- Select other copy modes as required.

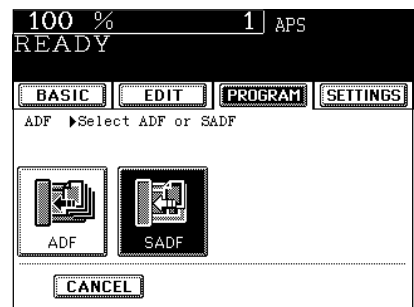

3 Set the original(s). ▶ Page 2-6

- The original is automatically pulled in and the screen changes as shown on the right.
- If there are more originals, set them in the same way. (The same operation is carried out whether or not you press the **YES** key.)

4 After all originals have been fed through the reversing automatic document feeder, press the **FINISHED** key.

- Copying begins.

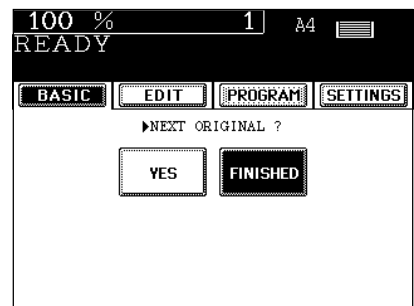

2. COPYING MIXED-SIZED ORIGINALS

When using the optional reversing automatic document feeder, different-sized originals can be copied at the same time in this copying mode, if their widths are the same.

* Do not set originals whose widths are different.

* Bypass copying is not possible.

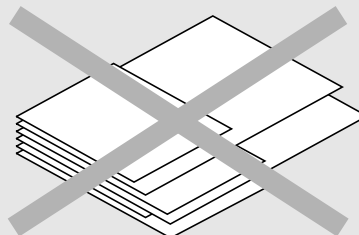
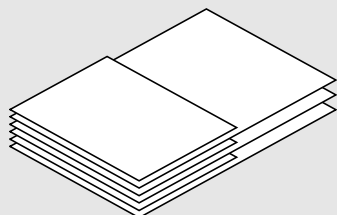

5

1 Set the original(s). ▶ Page 2-6

- A3 and A4 sized originals or B4 and B5 originals can be mixed.

2 Press the **PROGRAM** key to enter the program menu. Then, press the **MIXED ORIGINAL SIZES** key.

- If the key for the desired function is not shown, press the **Pre** key to switch the screen.

3 Press the **SET** key.

4 Select either the Automatic Paper Selection or Automatic Magnification Ratio mode and other copy modes as required.

- To make duplex copies, select the automatic magnification mode.

5 Press the **START** key.

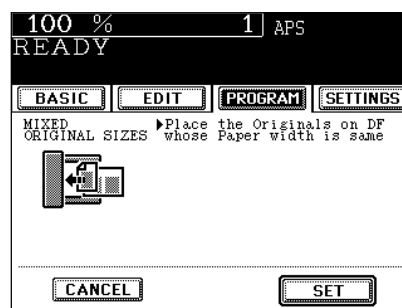
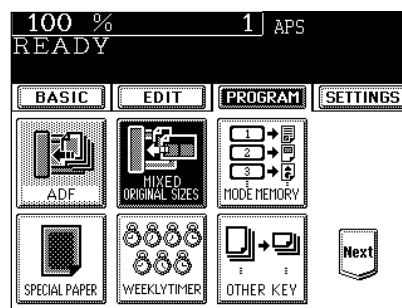

3. MODE MEMORY COPYING

You can store and recall a combination of frequently used copy modes at any time. Up to four such combinations of modes can be stored.

* You can not delete the copy modes that have already been stored in the memory, but you can rewrite new modes on the memory key in which some copy modes have already been stored.

Storing a Combination of Copy Modes

1 Select the desired copy modes.

Example:

Reproduction ratio 71%

Copy quantity 10 copies

Copy density Automatic

Paper size A4-R

- Confirm that each mode is set correctly.

2 Press the **PROGRAM** key to enter the program menu. Then, press the **MODE MEMORY** key.

- If the key for the desired function is not shown, press the **Pre** key to switch the screen.

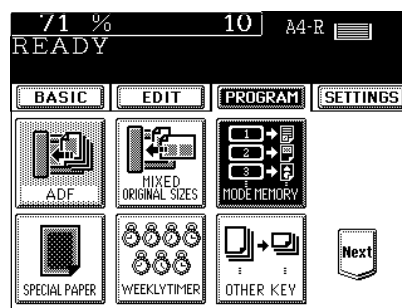

3 Press the **MEMORY** key.

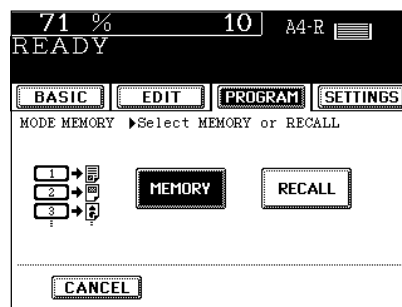

4 Press the **MEMORY 1** (**MEMORY 2**), **MEMORY 3** or **MEMORY 4**) key.

- The copy modes are stored in [MEMORY 1] ([MEMORY 2], [MEMORY 3] or [MEMORY 4]).
- The stored copy modes remain unchanged until different copy modes are entered. (They are retained even after the power switch is turned off.)

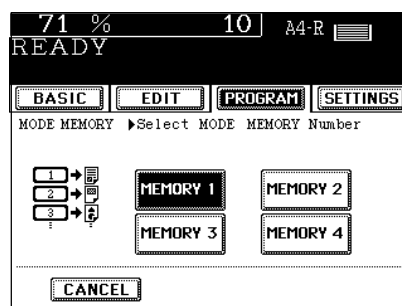

3. MODE MEMORY COPYING (Cont.)

- Memory numbers where copy modes are already stored are shown in shaded pattern.

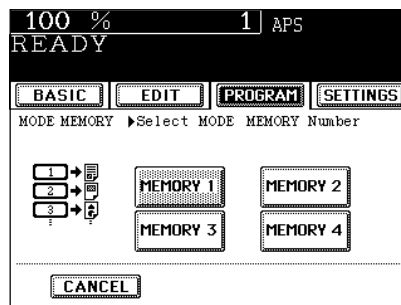

Recalling and Copying a Stored Combination of Copy Modes

5

- 1 Set the original(s). ▶ Page 2-4
- 2 Press the **PROGRAM** key to enter the program menu. Then, press the **MODE MEMORY** key.
 - If the key for the desired function is not shown, press the **PRE** key to switch the screen.
- 3 Press the **RECALL** key.
- 4 Press the Memory Number key where the desired combination of copy modes are stored.
- 5 Press the **START** key.
 - Copies will be made in the recalled copy modes.

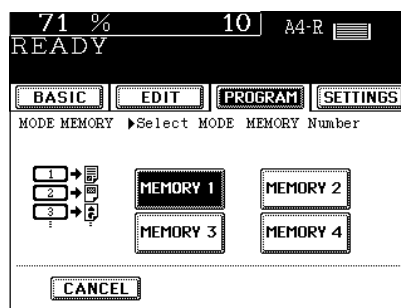
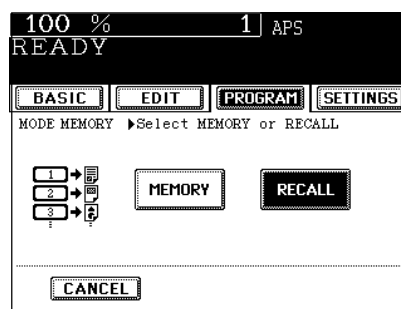
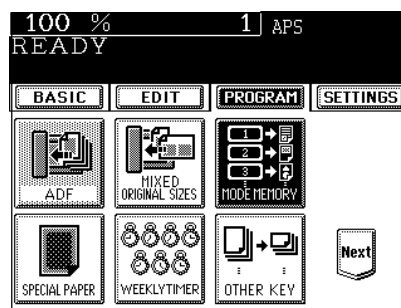

Confirming Stored Copy Modes

To confirm the copy modes stored in the **MEMORY** key, perform steps 2 to 4 on page 5-6, then press the **SETTINGS** key.

- The screen on the right is an example.

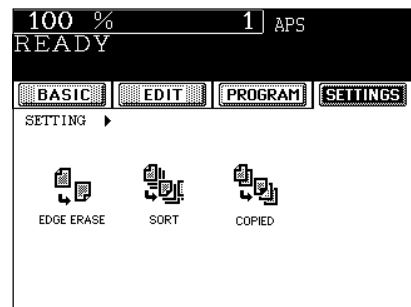
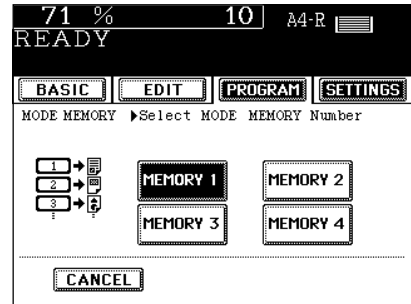

4. COPYING ON SPECIAL TYPES OF PAPER

When making copies using thick sheets of paper or transparency (OHP) film sheets, use this mode for improved toner image fusibility.

- * Be sure to set thick paper and transparency (OHP) films on the sheet bypass.
- * To output the transparency (OHP) films on the inner tray, install the guide for it. ► Page 5-9

1 Set the original(s). ► Page 2-4

2 Place the paper on the sheet bypass and set the paper size.

- Bypass copying ► Page 3-4

3 Press the **PROGRAM** key to enter the program menu. Then, press the **SPECIAL PAPER** key.

- If the key for the desired function is not shown, press the **Pre** key to switch back to the previous screen.

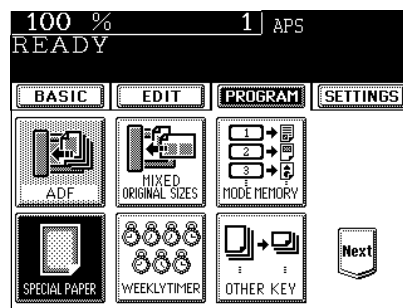

4 Press the **THICK PAPER** (or **TRANSPARENCY**) key.

- Select other copy modes as required.

5 Press the **START** key.

Tip

When outputting transparency (OHP) films, remove the films one by one every time they exit.

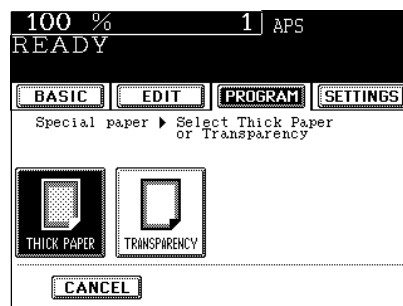

Outputting Transparency (OHP) Films on Inner Tray

To output the transparency (OHP) films on the inner tray, install the guide for it on the inner tray.

* If the optional finisher is installed, this operation is not required since the films exit on the finisher tray.

1 Remove the guide which is used for the cover.

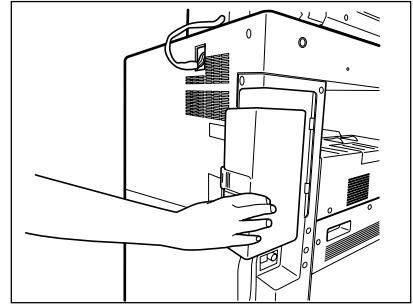

2 Fitting the pit and the projection of the guide, place the guide.

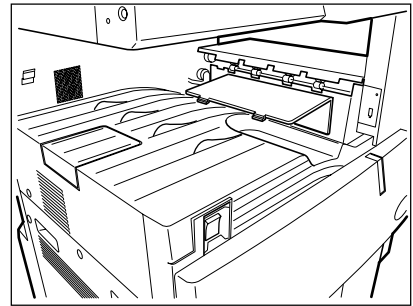

5

5. WEEKLY TIMER

Using the built-in weekly timer, you can have the copier automatically turn ON and OFF at specified times.

When the main power switch is turned off, or if used in combination with the Automatic Shutoff mode, the weekly timer does not work.

Setting the Weekly Timer

1 Press the **PROGRAM** key to enter the program menu. Then, press the **WEEKLY TIMER** key.

- If the key for the desired function is not shown, press the **Pre** key to switch between the screens.

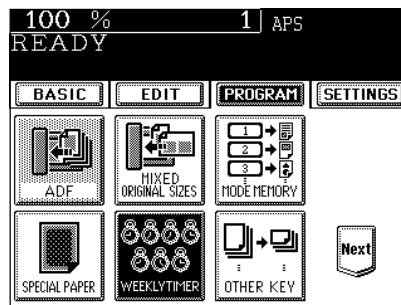

2 Check the settings on the display, and if they are all correct, press the **SET** key.

- If corrections are necessary, press the **CHANGE** key.

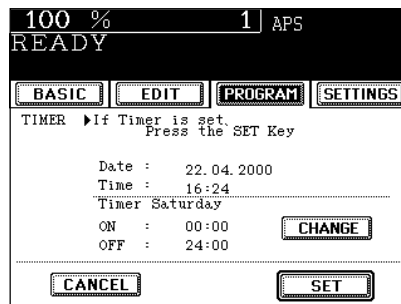

3 Set ON/OFF times for each day of the week.

- Use the **← SUN** and **SAT →** keys to switch between the days of the week.
- Key in numbers using the digital keys. After entering each number, press the upper **SET** key.
- After setting the times for all the days of week, press the lower **SET** key.
- For holidays when the copier is not turned on, key in the same times for both ON and OFF, eg. ON:00:00 and OFF:00:00.

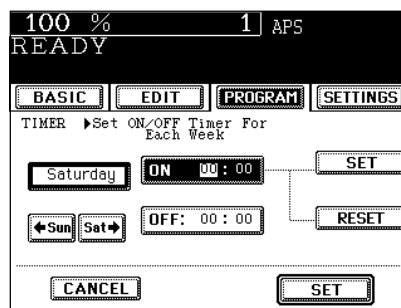

Cancelling the Use of the Weekly Timer

You can cancel the operation of the weekly timer so that the copier can be turned ON and OFF normally by the power switch.

- 1 Press the **PROGRAM** key to enter the program menu. Press the **WEEKLYTIMER** key to remove the shading pattern.

Tip

The ON/OFF times of the weekly timer are retained until they are changed. When the weekly timer is resumed, the previous settings will again become effective.

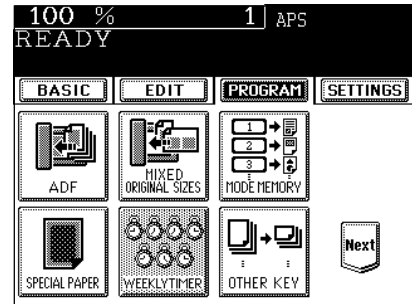

6. SETTING THE OTHER PAPER SIZES (OTHER KEY)

You can easily make copies using paper sizes other than A and B size formats, for example, Letter size format.

- 1 Set the original(s). ▶ Page 2-4
- 2 Place paper on the bypass tray, and adjust the slides to the size of the paper. ▶ Page 3-4
- 3 Press the **PROGRAM** key to enter the program menu. Then, press the **OTHER KEY** key.
 - If the key for the desired function is not shown, press the **Pre** key to switch the screen.

5

- 4 Press the **COPY SIZE** key of the paper corresponding to the size that has been set in the bypass guide.
- 5 Press the **BASIC** key to enter the basic menu, then press the **ZOOM...** key.

- 6 Press one of the **ORIGINAL SIZE** keys corresponding to the size of the originals which have been set, then the **OTHER** key for the **COPY SIZE** .
 - Select other copy modes as required.

- 7 Press the **START** key.

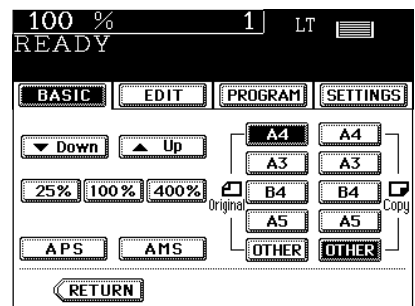
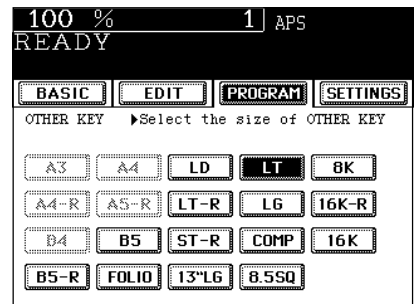
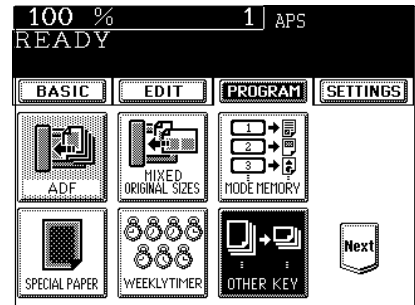

7. SETTING THE DATE AND TIME

The clock built in to the copier can be set by entering the date, day of the week and time using the digital keys. Also, you can easily change the clock to and from the daylight saving time system at the touch of a key.

1 Press the **PROGRAM** key to enter the program menu. Then, press the **DATE/TIME** key.

- If the key for the desired function is not shown, press the **Next** key to switch the screen.

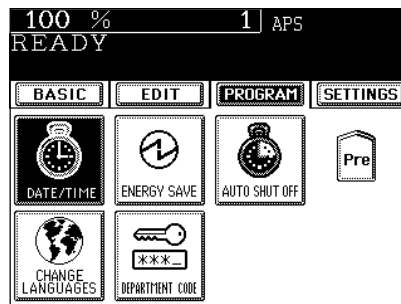

2 Key in the year (last two digits only), month, date, day of the week, time (24-hour format) and minutes with the digital keys, in this order from the left-hand column.

- Press the **Next** key to move to the next entry column.

[Ex.] To enter 2000 / November

0 → 0 → **Next** → 1 → 1 → **Next** →

* Numbers corresponding to the days of week:

Number	1	2	3	4	5	6	7
Day of week	Sun.	Mon.	Tue.	Wed.	Thu.	Fri.	Sat.

3 Check that the settings are all correct.

- If any of the settings are incorrect, press the **Previous** key to return and correct it.

4 Press the **SET** key.

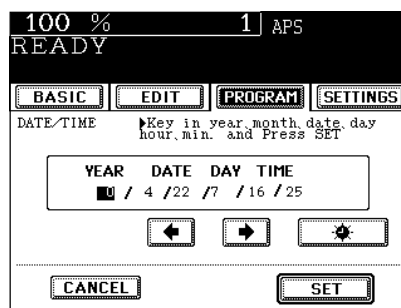

5

Tip

● Setting the Clock to the Daylight Saving Time System

- In the countries which adopt the daylight saving time system, press the **Daylight Saving** key to highlight it on the first day of summer, then press the **SET** key.
- If the time was 15:45 before setting the daylight saving time system, for example, it becomes 16:45 when the icon is shaded.

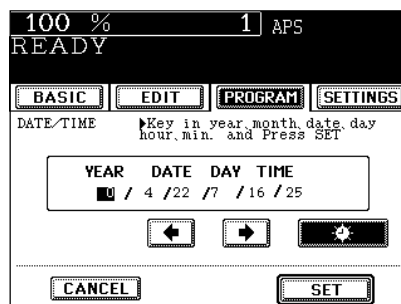

8. SETTING AUTOMATIC ENERGY SAVING MODE

If the automatic power saving mode is set, the copier will automatically go into the power saving mode if left inactive for a pre-determined period of time (default setting: 15 minutes).

* If you do not want to use the automatic power saving mode, consult your dealer or service technician.

Setting the Automatic Energy Saving Mode

1 Press the **PROGRAM** key to enter the program menu. Then, press the **ENERGY SAVE** key.

- If the key for the desired function is not shown, press the **Next** key to switch the screen.

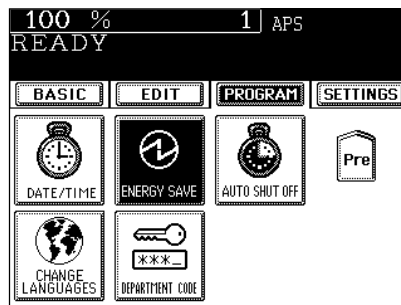

5

2 On the display, select the period of time (in minutes) allowed before the Automatic Energy Saving mode is activated.

- The setting procedure finishes and the display returns to the program menu screen.

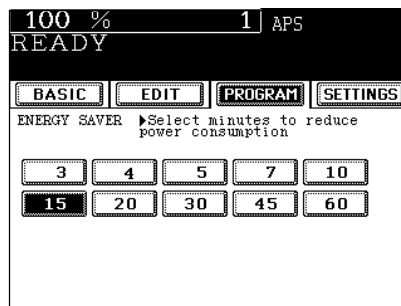

Clearing the Automatic Energy Saving Mode

Press any of the **START**, **PRINTER/NETWORK**, **COPY** and **FAX** keys.

- The copier warms itself up for a while and the following message appears.

READY

- While the copier is warming up, auto-start copying can be set.
▶ Page 1-13

9. SETTING AUTOMATIC SHUTOFF MODE

If you set an automatic shutoff time, the copier will automatically go into the OFF mode (unneeded electricity is cut off) when it is left inactive for a pre-determined period of time (default setting: 60 minutes).

The “Off mode” is the name of the function when the copier is used by itself. If the optional printer and/or facsimile function is installed, the mode name becomes the “Sleep mode”. However, the setting procedures for both modes are the same.

Note

In the regions with power requirements of 200V, if the copier does not have the optional facsimile or printer function installed, all the power is shut off when the copier goes into the auto shutoff mode. When the optional facsimile or printers function is installed, only unneeded electricity is cut off in the auto shutoff mode.

Setting the Automatic Shutoff Mode

1 Press the **PROGRAM** key to enter the program menu. Then, press the **AUTO SHUT OFF** key.

- If the key for the desired function is not shown, press the **Next** key to switch the screen.

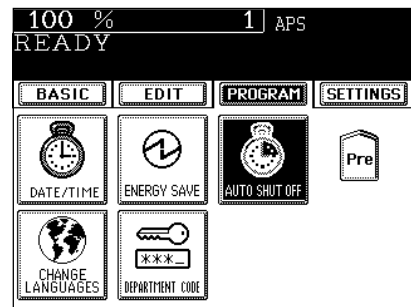

2 On the display, select the period of time (in minutes) allowed before the Automatic Shutoff mode is activated.

- The setting procedure finishes and the display returns to the program menu screen.

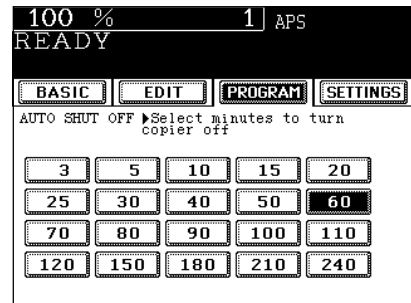

Clearing the Automatic Shutoff Mode

Press any of the **POWER**, **START**, **PRINTER/NETWORK**, **COPY** and **FAX** keys on the control panel.

- The copier warms itself up for a while and the following message appears.

READY

- While the copier is warming up, auto-start copying can be set.
▶ Page 1-13

10. SWITCHING BETWEEN LANGUAGES

The language used on the touch panel can be changed to different language.

1 Press the **PROGRAM** key to enter the program menu. Then, press the **CHANGE LANGUAGES** key.

- If the key for the desired function is not shown, press the **Next** key to switch the screen.

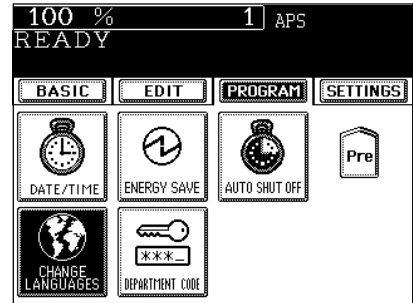

2 Press the key of the desired language.

5



11. DEPARTMENT CODES

You can administer the copy quantity of each group by setting a department code for each purpose (copying, printer and FAX). Up to 50 codes can be set.

* You need a master code to be input when you use this function for the first time.

1 Press the **PROGRAM** key to enter the program menu. Then press the **DEPARTMENT CODE** key.

- If the key for the desired function is not shown, press the **Next** key to switch the screen.

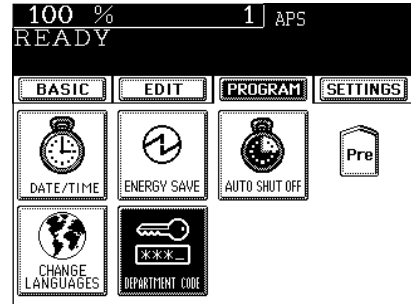

2 Key in the department code (5 digits).

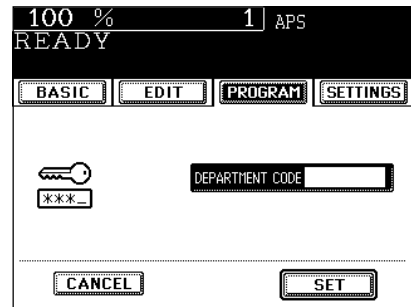

3 The department code menu appears.

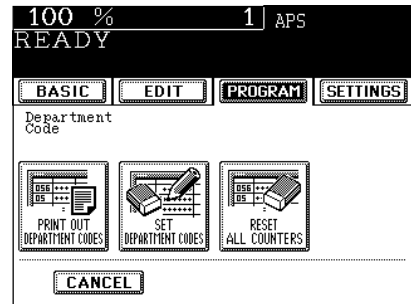

Printing the Counter

This function prints out the number of copies output for each department.

1 Press the **PRINT OUT DEPARTMENT CODES** key in the department code menu.

- Printing starts.

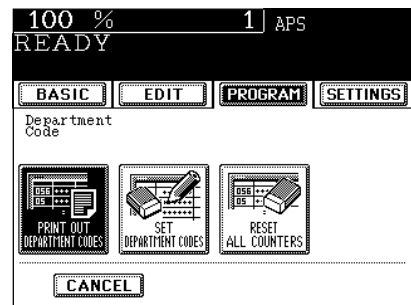

11. DEPARTMENT CODES (Cont.)

Clearing All Counters

This function clears all counters to "000000".

* The total counter (▶ Page 1-8) cannot be cleared.

- 1 Press the **RESET ALL COUNTERS** key in the department code menu.

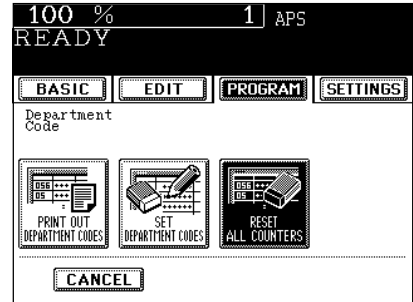

5

- 2 Press the **YES** key.
 - The counter is reset to "000000".

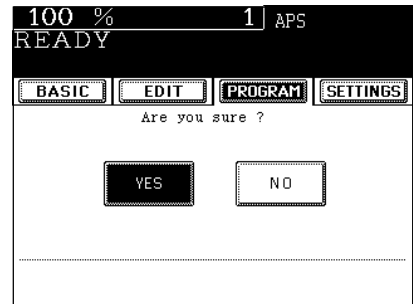

Registration/Change/Deletion of Department Code

This function registers, changes and deletes the department code.

Registering a New Department Code

- 1 Press the **SET DEPARTMENT CODES** key in the department code menu.

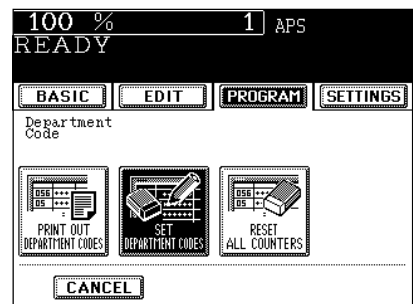

- 2 Press the **ENABLE** key, then the **SET** key.

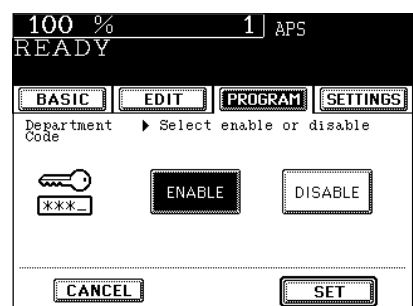

3 Press the **SET** key to register a master code.

- If the master code has already been registered, the screen on step 6 will be displayed.

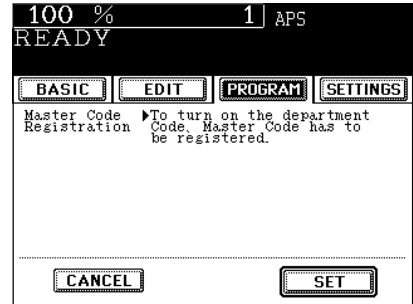

4 Input a master name and press the **SET** key.

- Entering letters ► Page 5-24

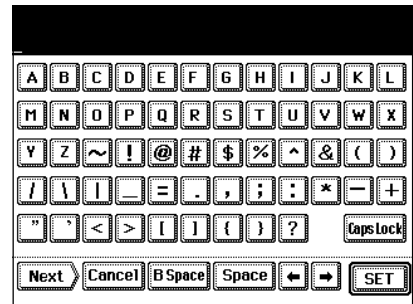

5 Using the digital keys, enter the desired master code (5 digits) both for **NEW CODE** and for **RETYPE NEW CODE**, and press the lower **SET** key.

- The master code is 5 digits ("00000" is invalid).

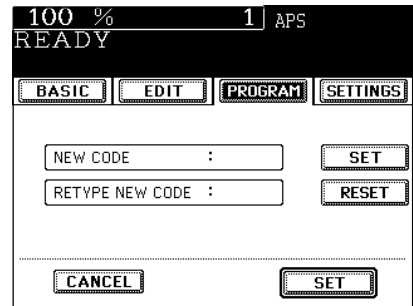

6 Select the department number where you want to register the department code, and press the **CHANGE** key.

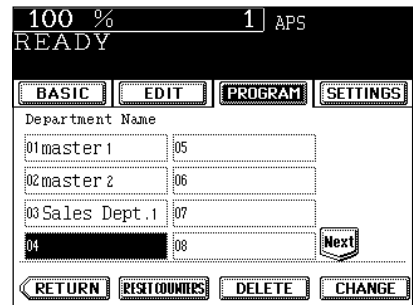

7 Input the department name and press the **SET** key.

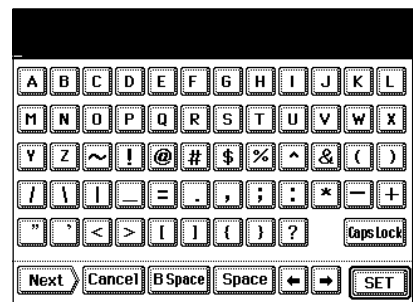

11. DEPARTMENT CODES (Cont.)

8 Using the digital keys, enter the desired department code (5 digits) both for **NEW CODE** and for **RETYPE NEW CODE**, and press the lower **SET** key.

•The department code is 5 digits (“00000” is invalid).

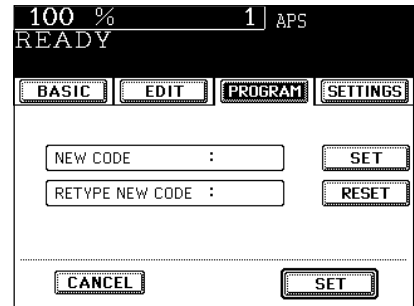

Changing the Department Code of a Specific Department

1 Press the **SET DEPARTMENT CODES** key in the department code menu.

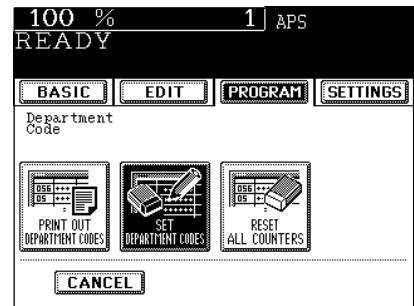

2 Select the department code number you want to change, and press the **CHANGE** key.

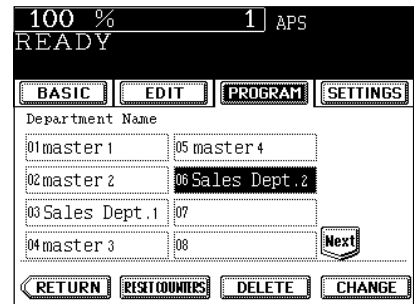

3 The confirmation screen for department code change is displayed. Press the **SET** key.

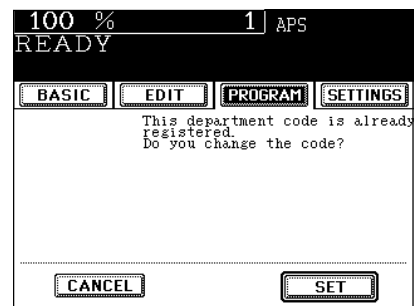

- 4** Input the department name and press the **SET** key.
- Entering letters ► Page 5-24

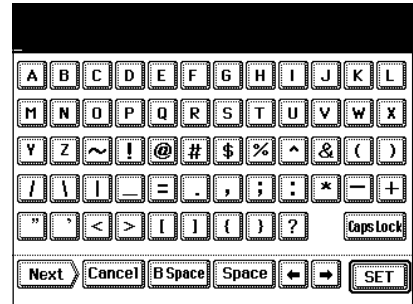

- 5** Using the digital keys, enter the current department code for **CURRENT CODE**, and the code you want to register both for **NEW CODE** and for **RETYPE NEW CODE**, and press the lower **SET** key.
- The department code is 5 digits ("00000" is invalid).

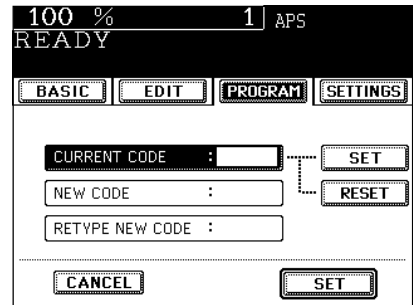

5

Deleting a Department from the Department Codes

- 1** Press the **SET DEPARTMENT CODES** key in the department code menu.

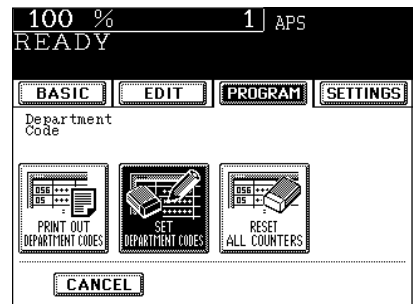

- 2** Press the **ENABLE** key, then the **SET** key.

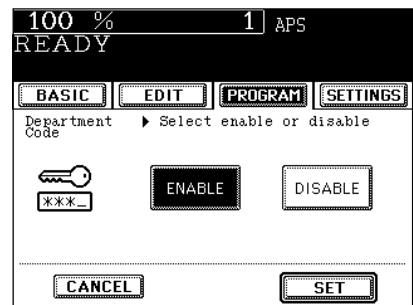

11. DEPARTMENT CODES (Cont.)

3 Select the department number you want to delete, and press the **DELETE** key.

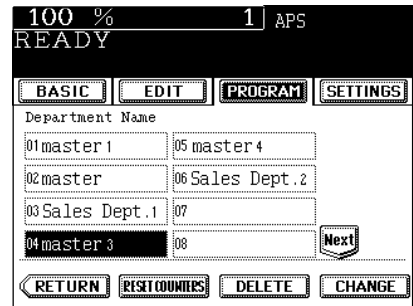

4 Press the **YES** key.

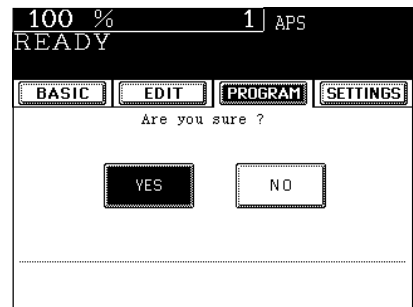

5

Clearing a Specific Department Counter

1 Press the **SET DEPARTMENT CODES** key in the department code menu.

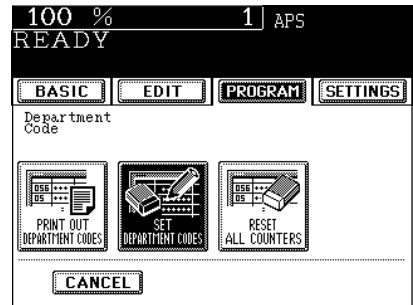

2 Press the **ENABLE** key, then the **SET** key.

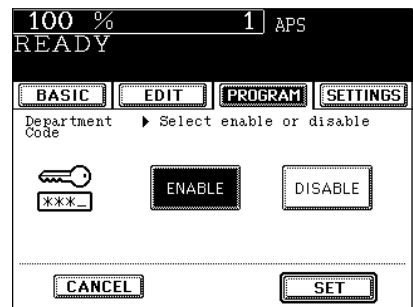

- 3** Select the department number where you want to clear the counter, and press the **RESET COUNTERS** key.

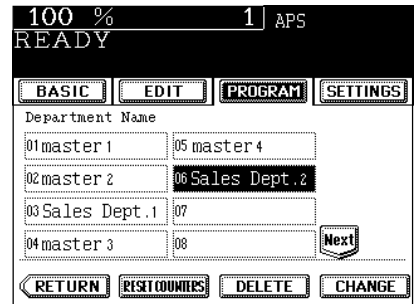

- 4** Press the **YES** key.

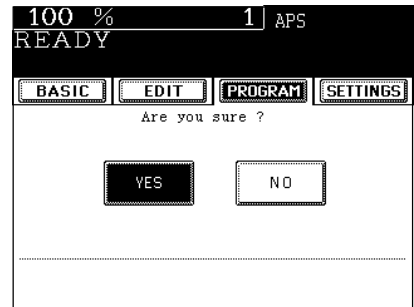

5

Disabling the Department Codes

- 1** Press the **SET DEPARTMENT CODES** key in the department code menu.

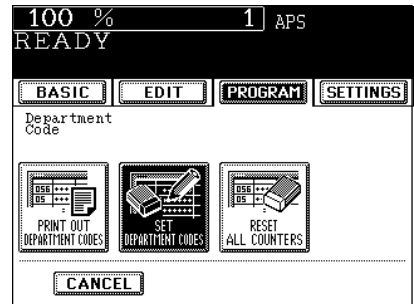

- 2** Press the **DISABLE** key.
- If you have pressed this key, you have to register the master code again.

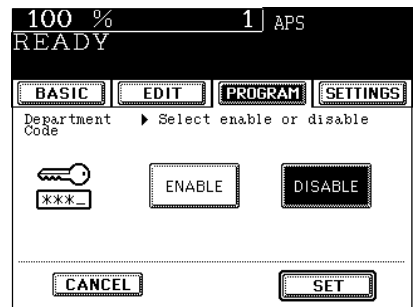

12. ENTERING LETTERS

The following screen is provided for entering letters.
* For entering numbers, use the digital keys on the control panel.

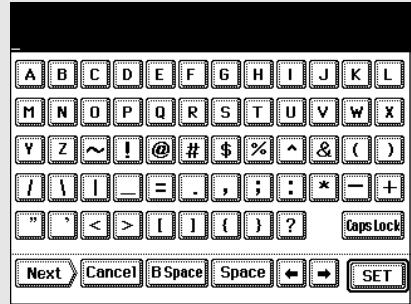

The following keys are used for entering letters.

- **CapsLock**..... Press this key to switch capital letters and small letters.
- **B Space**..... Press this key to delete the letter before the cursor.
- **Space**..... Press this key to enter a space.
- **← →**..... Press these keys to move the cursor.
- **SET**..... Press this key to fix all entered letters.
- **Cancel**..... Press this key to cancel entry of letters.

Entering Letters

Example: Enter "Toshiba".

1 Press the **T** key in the Letter Entry Screen.

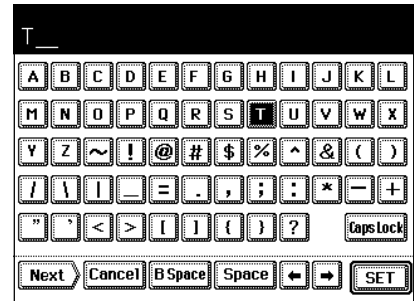

2 Press the **CapsLock** key to enter small letters, then press the **o** key.

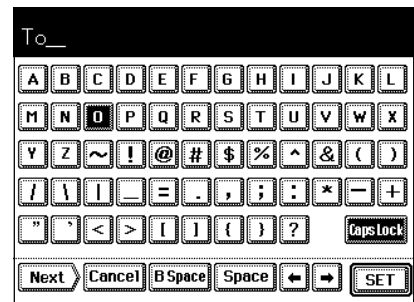

3 Press the **(S)**, **(H)**, **(I)**, **(B)** and **(A)** keys.

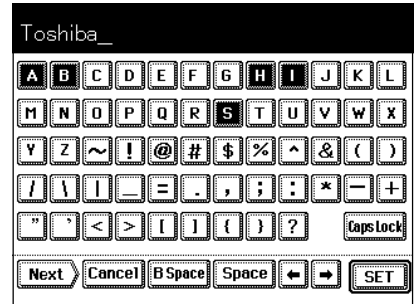

4 Press the **(SET)** key to fix the entered letters.

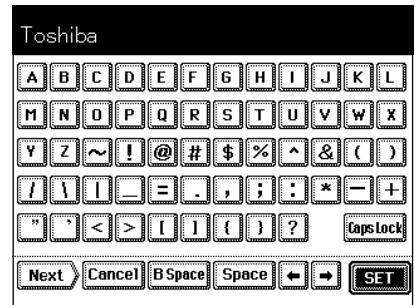

5

Correcting Entered Letters

Example : Correct "Toshiba" to "TOSHIBA".

1 Press the **(B Space)** key to delete "oshiba".

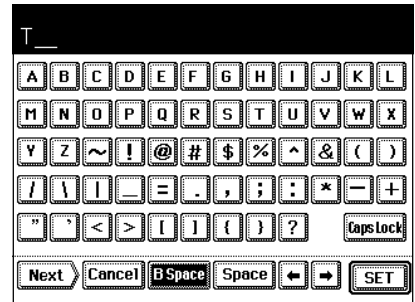

2 Press the **(CapsLock)** key to enter the capital letters.

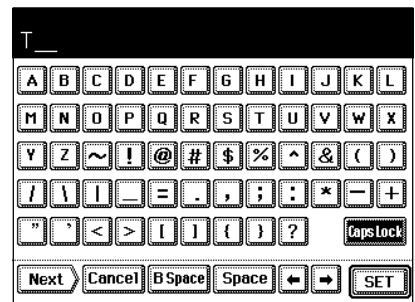

12. ENTERING LETTERS (Cont.)

3 Press the **O**, **S**, **H**, **I**, **V** and **A** keys.



4 Press the **←** key to move the cursor to (under) "A".



5

5 Press the **B Space** key to delete "V".

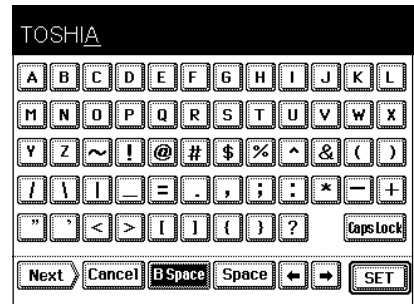

6 Press the **B** key to enter "B", then the **SET** key to fix the entered characters.



6. SELECTING FINISHING MODES (USING THE OPTIONAL FINISHERS)

1. Finishing modes and finishers (optional)	6-2
2. Sort/group copying	6-3
3. Staple mode	6-5
4. Alternate stacking mode	6-7
5. Hole punching mode	6-8
6. Magazine sort & Saddle stitching mode	6-9

1. FINISHING MODES AND FINISHERS (OPTIONAL)

There are 3 types of optional finishers (MJ-1011, MJ-1012 and MJ-1013). Functions available differ depending on the type of the finisher installed.

- Press the key on the basic screen on the right (shaded), and confirm the finishing modes on the panel.
- * The touch panel used in this chapter appears when the optional finisher (MJ-1013) and the optional hole punching unit are installed with your copier.

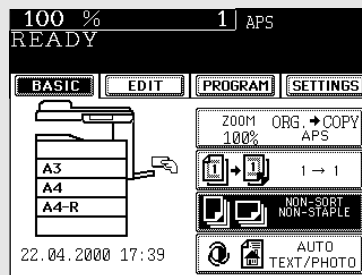

Names of the Finishers

● Console type

- MJ-1012
- MJ-1013 (with saddle stitching function)

● Hanging type

- MJ-1011

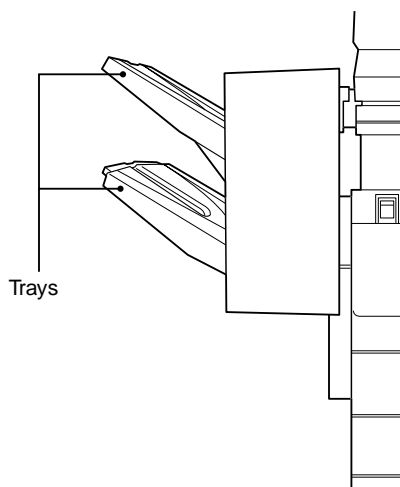
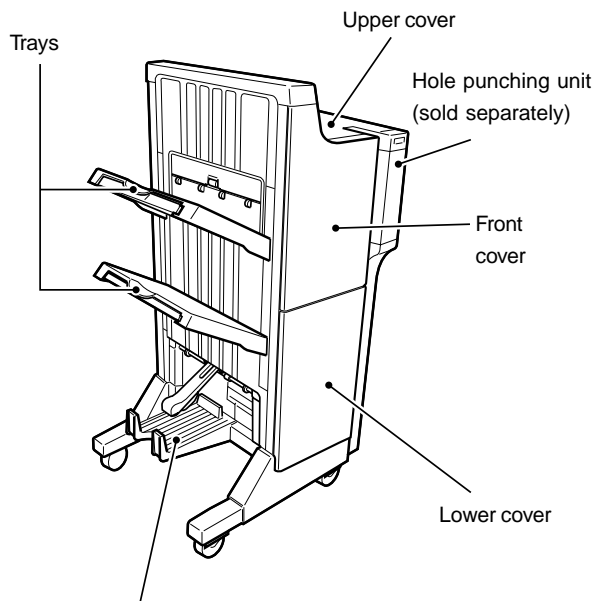

Saddle stitching tray (MJ-1013 only)

2. SORT/GROUP COPYING

The default setting for the finishers is Non-sort mode, however, you can produce sorted copies or grouped copies as required.

- Example of making 5 sets of copies from 5-page originals

• Sort copying

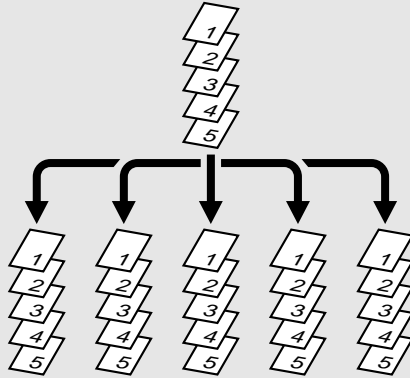

• Group copying

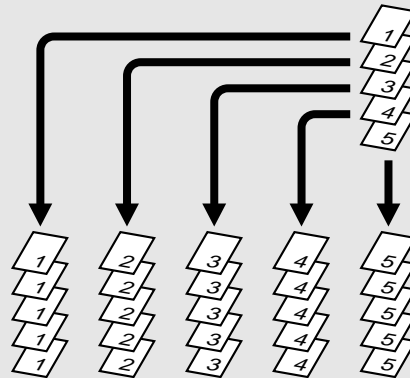

1 Set the originals. ► Page 2-4

2 Press the key on the basic screen as shown on the right (shaded).

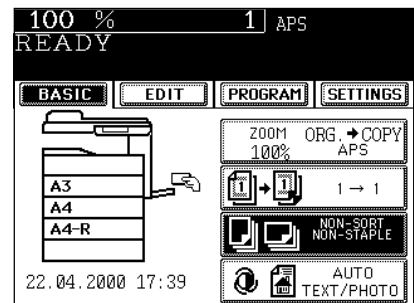

3 Press the **(SORT)** (or **(GROUP)**) key.

- Select other copy modes as required.

4 Press the **(START)** key.

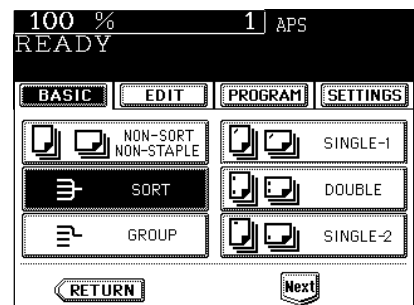

2. SORT/GROUP COPYING (Cont.)

When Placing an Original on the Glass

5 Place the next original (or 2nd side) and press the **START** key.

- You can press the **YES** key and then the **START** key to do the same operation.
- Repeat the above procedure until all your originals have been scanned.

6 After all your originals have been scanned, press the **FINISHED** key.

- Copying begins.

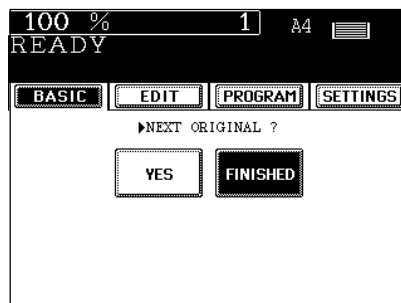

3. STAPLE MODE

When the optional finisher is installed, you can use the function that automatically staples at one of the following three positions.

* Only (SINGLE-1) is available for the hanging type finisher (MJ-1011).

- (SINGLE-1) is selected:

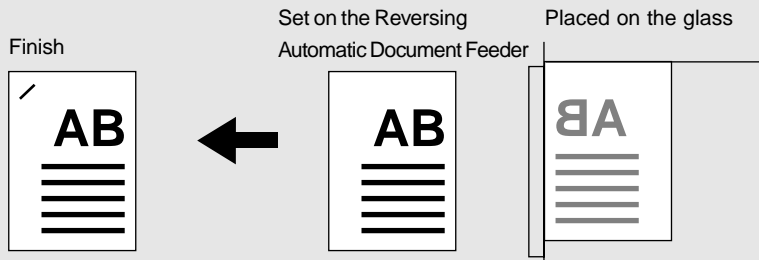

- (DOUBLE) is selected:

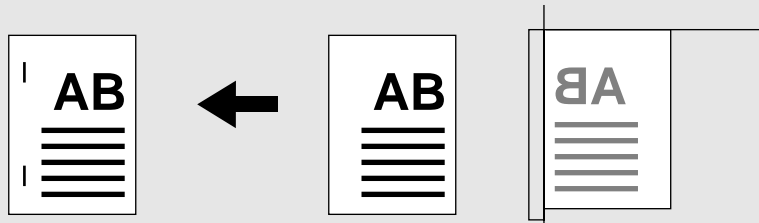

- (SINGLE-2) is selected:

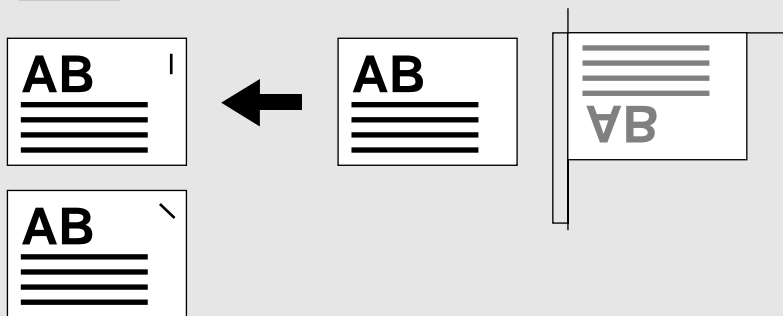

* Depending on the paper size, stapling is made either vertically or diagonally.

1 Set the originals. ▶ Page 2-4

3. STAPLE MODE (Cont.)

2 Press the key on the basic screen as shown on the right (shaded).

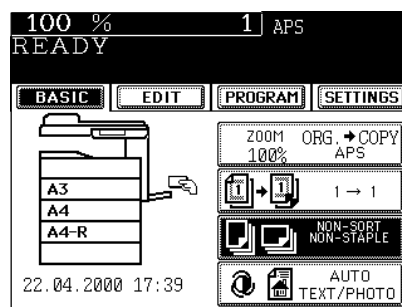

3 Press the **SINGLE-1** (or **DOUBLE** or **SINGLE-2**) key.

- Select other copy modes as required.

4 Press the **START** key.

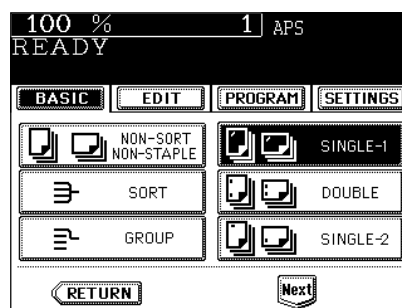

6

Maximum Number of Sheets for Stapling, Stapled Position and Available Paper Size

Model name	Maximum capacity for stapling	Stapled position and available paper size
MJ-1011	30 sheets: A4, A4-R, B5 20 sheets: B4 15 sheets: A3, FOLIO	•SINGLE-1: A3, A4, A4-R, B4, B5, FOLIO
MJ-1012 MJ-1013	50 sheets: A4, B5 30 sheets: A3, A4-R, B4, FOLIO	•SINGLE-1: A3, A4, A4-R, B4, B5, FOLIO •DOUBLE: A3, A4, A4-R, B4, B5, FOLIO •SINGLE-2: (vertical) A4-R, FOLIO (diagonal) A3, A4, B4, B5

4. ALTERNATE STACKING MODE

With A4 and A4-R paper set in the cassettes, if you select the alternate stacking mode and produce sorted or grouped copies, each set of copies is alternately stacked in different directions, which makes it easier to handle paper after making copies. Even when the optional finisher is installed, paper exits on the inner tray in this mode.

* This mode cannot be used in the Automatic Paper Selection mode.

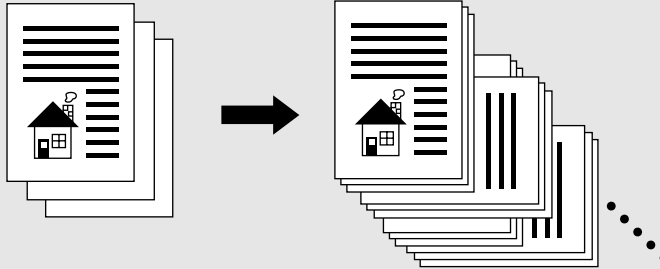

1 Set the originals. ► Page 2-4

2 Press the key on the basic screen as shown on the right (shaded).

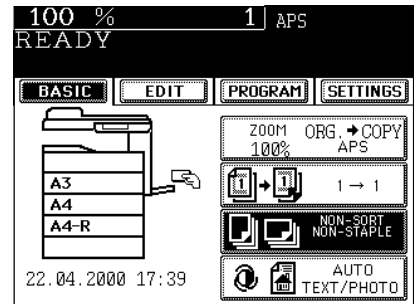

3 Press the **ALTERNATION** key.

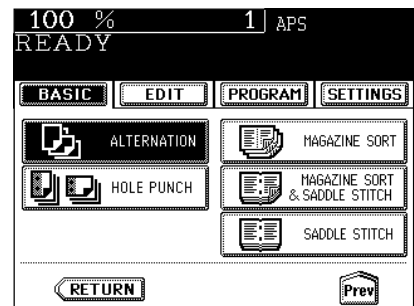

4 Select A4 size of paper.

- When you select A4, make sure that an A4-R cassette is also installed.

- Select other copy modes as required.

5 Press the **START** key.

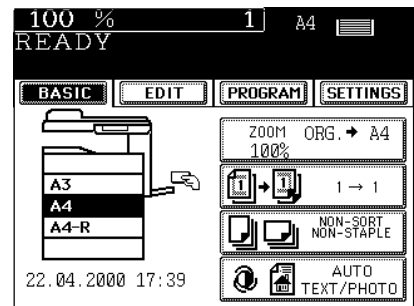

5. HOLE PUNCHING MODE

With the optional punching unit attached to the optional finisher (MJ-1012 or MJ-1013 only), you can have your copies punched with holes.

* The thickness of paper should be in the range of 64 to 200 g/m². Special paper such as OHP film is excluded.

1 Set the originals. ► Page 2-4

2 Press the key on the basic screen as shown on the right (shaded).

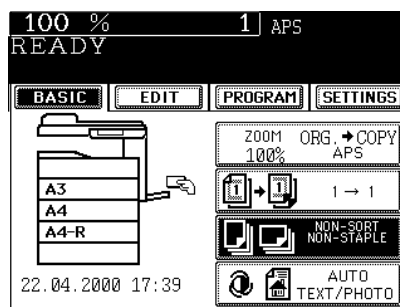

6 **3** Press the **HOLE PUNCH** key.

- If the key for the desired function is not shown, press the **Next** key to switch the screen.
- Select other copy modes as required.

4 Press the **START** key.

Tip

Number of punch holes and available paper sizes:

Since the number of punch holes and the distance between the holes vary depending on countries, purchase a punching unit that meets your requirements. (For details, consult your service technician.)

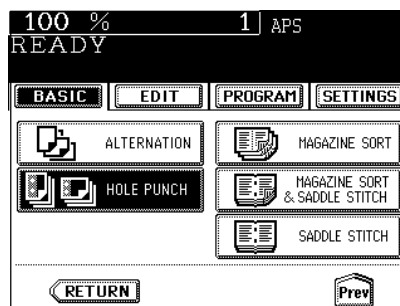

	Number of punch holes and hole diameter	Available paper sizes
Japan and most of Europe (MJ-6001E)	2 holes (6.5 mm dia.)	A3, A4, A4-R, B4, B5, B5-R, FOLIO
North America (MJ-6001N)	2/3 holes switchable (8.0 mm dia.)	2 holes: LG, LT-R, COMP 3 holes: LD, LT
France (MJ-6001F)	4 holes (6.5 mm dia.; 80 mm pitch)	A3, A4
Sweden (MJ-6001S)	4 holes (6.5 mm dia; 70, 21 mm pitch)	A3, A4, A4-R, B4, B5, B5-R, FOLIO

6. MAGAZINE SORT & SADDLE STITCHING MODE

When the Magazine Sort mode is selected, copies are made so that they can be bound like magazines. When the finisher with saddle stitcher (optional, MJ-1013) is installed, you can select the saddle stitching mode which will automatically staple in the centre of the document.

* Blank covers or copied covers can be added at the top of the copies if the cover sheet mode is used in combination (► Page 4-18). In this case, nothing is printed on the back of the cover sheet.

* Two procedures are available for making copies in the Magazine Sort mode. See page 4-16 for the **EDIT** menu process.

● Example of copying a 12-page document

- When **MAGAZINE SORT** is selected

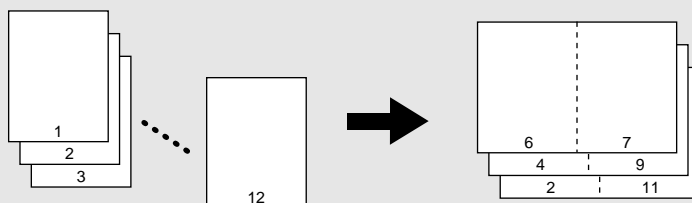

- When **MAGAZINE SORT & SADDLE STITCH** is selected

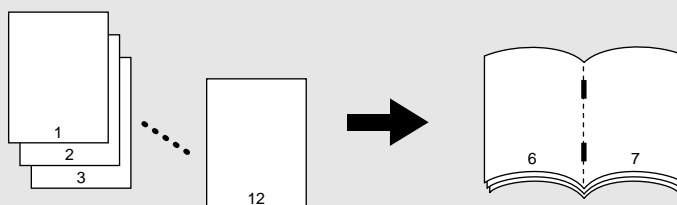

- When **SADDLE STITCH** is selected

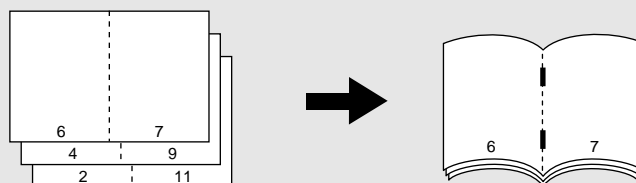

1 Set the originals. ► Page 2-4

2 Press the key on the basic screen as shown on the right (shaded).

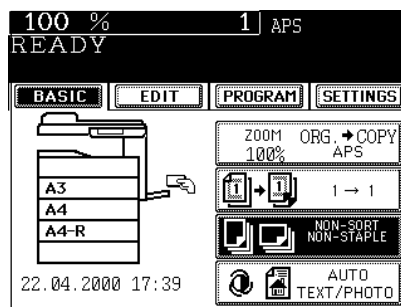

6. MAGAZINE SORT & SADDLE STITCHING MODE (Cont.)

3 Press the **MAGAZINE SORT** (or **MAGAZINE SORT & SADDLE STITCH** or **SADDLE STITCH**) key.

- Select other copy modes as required.

4 Press the **START** key.

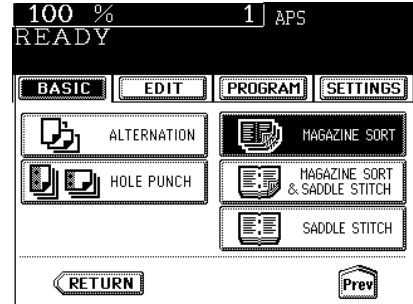

7. WHEN GRAPHIC SYMBOLS FLASH ON THE TOUCH PANEL

1. Description of the flashing graphic symbols	7-2
2. Add paper symbol	7-3
• Adding paper to the cassettes	7-3
• Adding paper to the large-capacity feeder (optional)	7-4
3. Replace toner cartridge symbol	7-5
4. Clear paper symbol	7-10
① Reversing automatic document feeder (optional)	7-10
② Cassette feeding area	7-12
③ Large-capacity feeder (optional)	7-13
④ Bypass feed unit	7-13
⑤ Automatic duplexer	7-14
⑥ Jam releasing unit	7-14
⑦ Fuser unit	7-15
⑧ Relay unit	7-16
⑨ Hole punching unit (optional)	7-17
⑩ Finisher (optional)	7-17
⑪ Saddle stitching unit (optional)	7-19
5. Adding staples	7-21
6. Removing jammed staples	7-25
7. Clearing accumulated punched paper bits	7-28
8. Call service symbol	7-29
9. Periodic maintenance message	7-30

1. DESCRIPTION OF THE FLASHING GRAPHIC SYMBOLS

The graphic display on the touch panel shows the status of the copier. When one of the graphic symbols flashes, take the appropriate action referring to page shown.

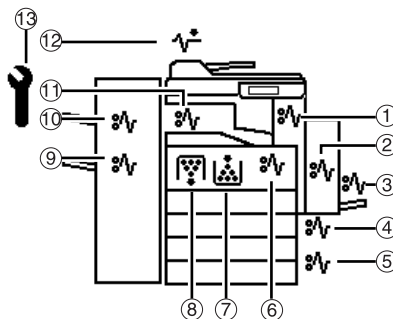

- ① **[Symbol]** **FUSER MISFEED** Symbol
Flashes when a paper misfeed occurs on the paper path inside the copier (near the fuser unit).
▶ Page 7-15
- ② **[Symbol]** **DUPLEXER MISFEED** Symbol
Flashes when a paper misfeed occurs inside the automatic duplexer. ▶ Page 7-14
- ③ **[Symbol]** **BYPASS MISFEED** symbol
Flashes when a sheet of paper fails to be fed into the copier during bypass copying. Replace the sheets of paper on the bypass guide. ▶ Page 7-13
- ④ **[Symbol]** **CASSETTE MISFEED** symbol
Flashes when paper fed from one of the cassettes is misfed. ▶ Page 7-12
- ⑤ **[Symbol]** **OPTIONAL FEEDER MISFEED** symbol
Flashes when paper fed from the large-capacity feeder (optional) or a selected cassette (optional) is misfed. ▶ Page 7-13
- ⑥ **[Symbol]** **JAM RELEASING UNIT MISFEED** symbol
Flashes when a misfeed occurs in the jam releasing unit on the paper path inside the copier.
▶ Page 7-14
- ⑦ **[Symbol]** **REPLACE TONER CARTRIDGE** symbol
Flashes when the toner cartridge runs out of toner. ▶ Page 7-5
- ⑧ **[Symbol]** **REPLACE TONER BAG** symbol
Flashes when the toner bag becomes full of used toner. ▶ Page 7-8
- ⑨ **[Symbol]** **SADDLE STITCHING UNIT MISFEED** symbol
Flashes when a paper misfeed occurs inside the saddle stitching unit. ▶ Page 7-19
- ⑩ **[Symbol]** **FINISHER/PUNCHING UNIT MISFEED** symbol
Flashes when a paper misfeed occurs inside the finisher or punching unit. ▶ Page 7-17
- ⑪ **[Symbol]** **RELAY UNIT MISFEED** symbol
Flashes when a paper misfeed occurs on the paper path (near the relay unit) inside the copier.
▶ Page 7-16
- ⑫ **[Symbol]** **CHECK ORIGINALS** symbol
Flashes when an original misfeed occurs inside the reversing automatic document feeder.
▶ Page 7-10
- ⑬ **[Symbol]** **CALL SERVICE** symbol
Flashes when inspection and maintenance by a service technician become necessary.
▶ Page 7-29

2. ADD PAPER SYMBOL

Adding Paper to the Cassettes

When the paper supply in the selected cassette or the large-capacity feeder (optional) runs out, the cassette or large-capacity feeder shown on the display flashes, and the following message appears:

Add paper

Add paper as follows.

- 1 Pulling up the cassette grip, draw out the cassette carefully until it comes to a stop.**

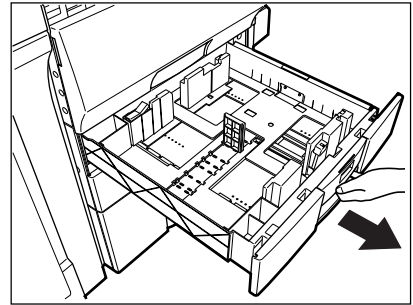

- 2 Open a paper package, take out whole ream of paper and place it in the cassette.**

- Up to 550 sheets of paper (60 mm high) (recommended by Toshiba) can be set.
- Do not add paper above the line indicated on the guide.
- Do not use creased, folded, wrinkled or damp sheets of paper.

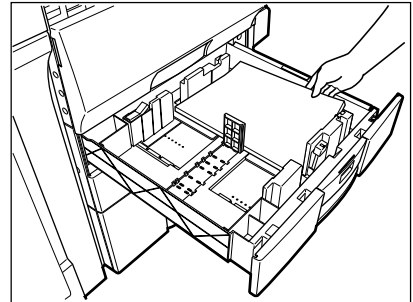

Note

Make sure that a gap of approx. 0.5 mm (less than 1 mm in total) is left between the paper and the side guide. If there is no gap, this would cause paper misfeeding.

- 3 Push the cassette straight in until it comes to a stop.**
- Be sure to push the cassette fully in, taking care.
 - The same procedure can be used to add paper to any of the cassettes in the paper feed pedestal (optional).

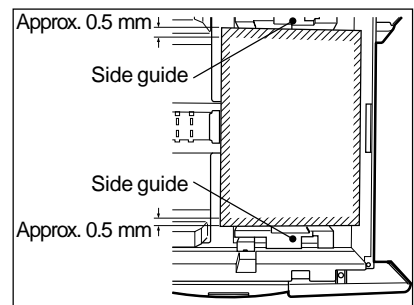

2. ADD PAPER SYMBOL (Cont.)

Adding Paper to the Large-Capacity Feeder (optional)

- 1** Pulling up the grip, draw out the large-capacity feeder carefully until it comes to a stop.

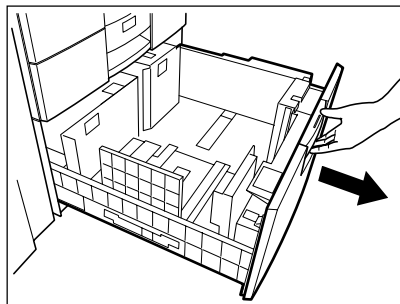

- 2** Open some paper packages, take out entire reams of paper and set them aligned in tray ① and tray ②.

- When setting the paper, set the paper for ① to the right aside, and set it for ② to the left aside. (The paper can be set neatly if you pile up the paper little by little alternately in the tray ① and ②.) Be sure that the centre lever is not open (Refer to the labels attached in the large-capacity feeder).
- Do not add paper above the line indicated on the guide.
- Up to 2500 sheets of paper (recommended by Toshiba) can be set.
- Paper starts being fed from the elevator tray ① at first, and when it runs out of paper, the paper on tray ② moves to the position ①.
- Do not use creased, folded, wrinkled or damp sheets of paper.

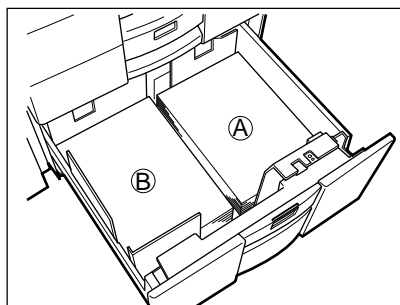

- 3** Close the cover of the large-capacity feeder.

- Close the cover completely. The elevator tray automatically moves up to the paper feeding position.

3. REPLACE TONER CARTRIDGE SYMBOL

When the toner cartridge runs out of toner, the REPLACE TONER CARTRIDGE  symbol flashes, and the following message appears:

Add toner

Then replace both the toner cartridge and the toner bag at the same time.

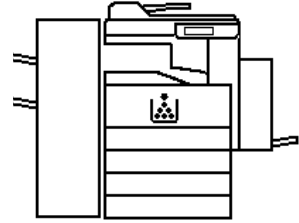

Here at Toshiba dependable high quality image output is what we do. By using genuine Toshiba toners you can ensure that you are not only receiving quality output but also output that is friendly to mother earth and human beings.

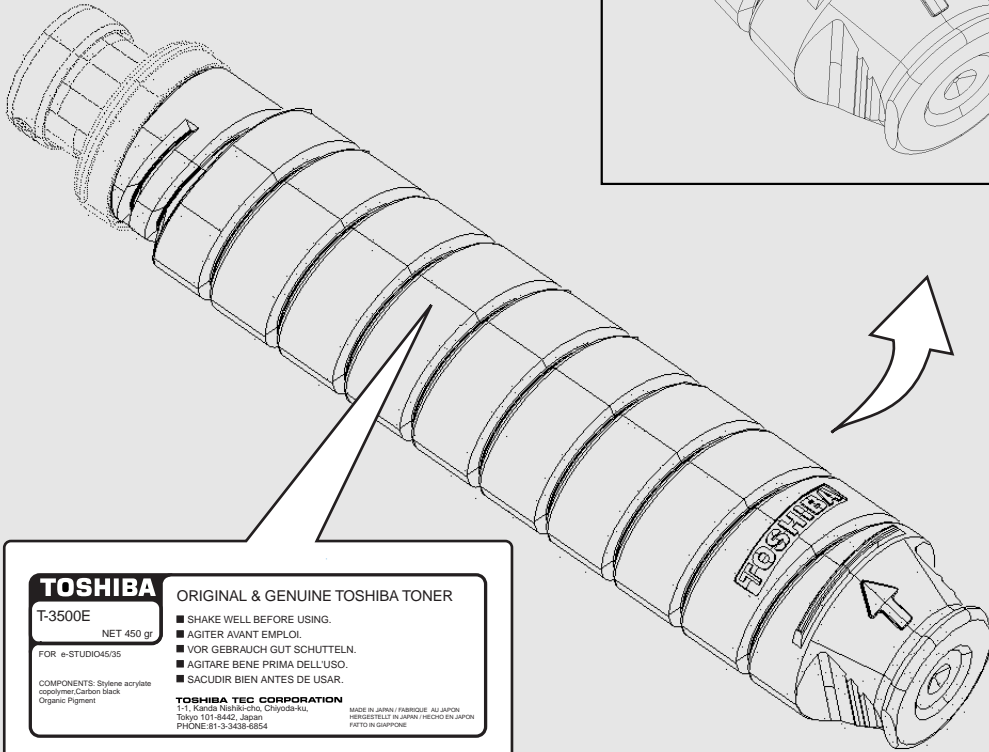
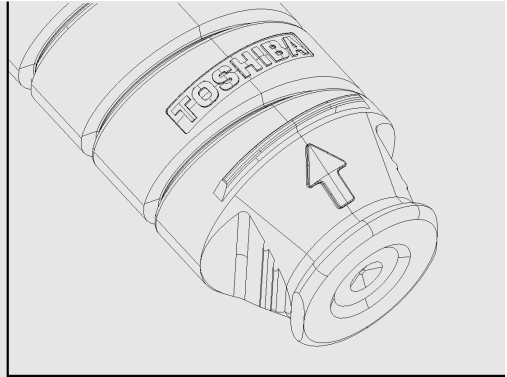

TOSHIBA

T-3500E

NET 450 gr

FOR e-STUDIO4535

COMPONENTS: Styrene acrylate
copolymer, Carbon black,
Organic Pigment

ORIGINAL & GENUINE TOSHIBA TONER

- SHAKE WELL BEFORE USING.
- AGITER AVANT EMPLOI.
- VOR GEBRAUCH GUT SCHÜTTELN.
- AGITARE BENE PRIMA DELL'USO.
- SACUDIR BIEN ANTES DE USAR.

TOSHIBA TEC CORPORATION

1-1, Kanda Nishi-cho, Chiyoda-ku, Tokyo

101-8442, Japan

PHONE: 81-3-3438-8554

MADE IN JAPAN / FABRIQUE AU JAPON
HERGESTELLT IN JAPAN / HECHO EN JAPON
FATTO IN GIAPPONE

1 Open the front cover.

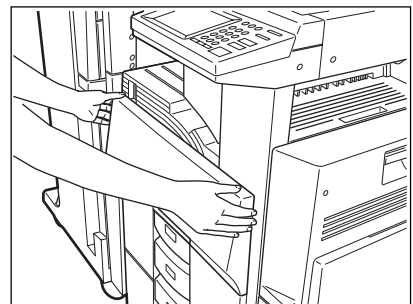

7

7-5

3. REPLACE TONER CARTRIDGE SYMBOL (Cont.)

Removing the Toner Bag

- 2** Move the toner bag in the direction of the arrow and release it from part **A**.

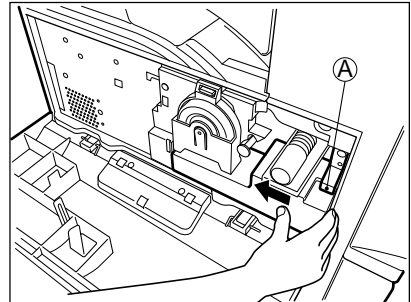

- 3** Holding part **B** with your one hand, pull the toner bag toward you to pull it out of its holder.

- Put the lid on the toner bag and return it to your service technician.

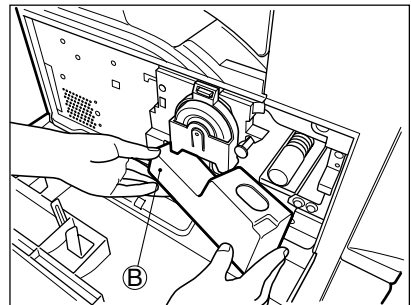

Removing the Toner Cartridge

- 4** Pushing on the claw, lower the cartridge holder toward you.

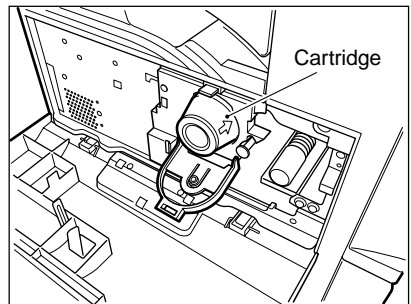
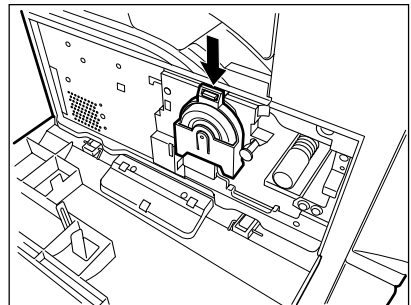

5 Rotate the cartridge so that the arrow on its side appears in the position shown on the right.

6 Pull the cartridge out carefully.

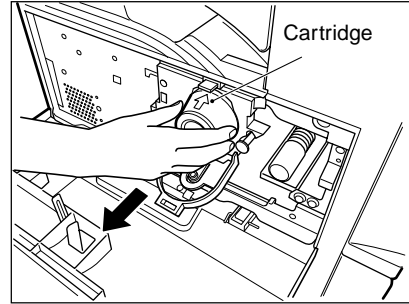

Note

Please return the used toner cartridges and toner bags to your service technician.

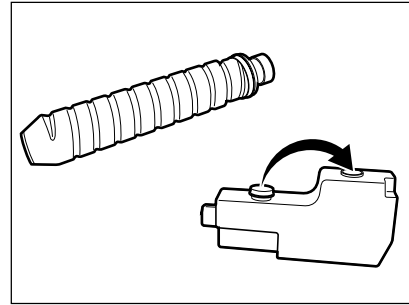

Installing a New Toner Cartridge

7 Shake the new toner cartridge up and down several times.

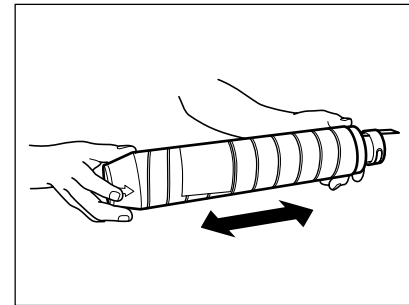

8 Pull out the seal in the direction of the arrow as shown on the right.

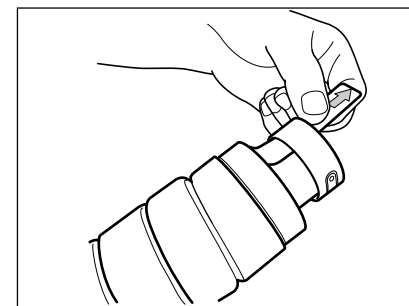

3. REPLACE TONER CARTRIDGE SYMBOL (Cont.)

- 9** Holding the cartridge so that the arrow on its lower side is kept in the position shown on the right, insert the cartridge completely.

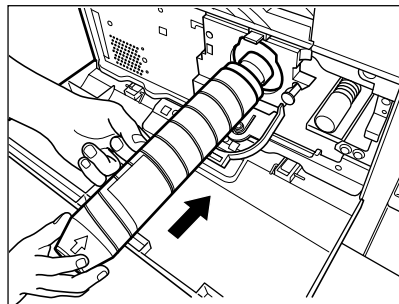

- 10** Return the cartridge holder back to its original position.

Tip

The amount of toner consumed varies depending on the originals and the image quality mode.

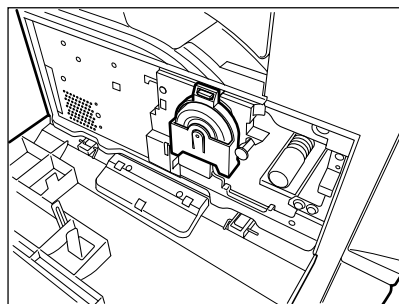



Installing a New Toner Bag

7

- 11** Install the new toner bag by reversing the procedure used for removing one.

- Refer to the procedure in steps 2 and 3 on page 7-6.

- **When the REPLACE TONER BAG  symbol flashes:** When the toner bag becomes full of used toner, the REPLACE TONER BAG  symbol flashes and this message appears:

Dispose of used
toner

Replace the toner bag by following the instructions on page 7-6.

Note

It is recommended that the used toner bag be replaced at the same time as the toner cartridge.

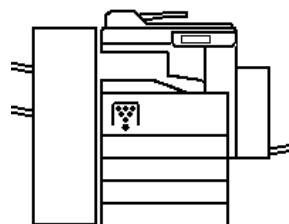

Additional Explanation

The life of the toner cartridge (number of copies) varies depending on the following conditions.

1. Coverage of originals (printing image ratio of the original size) and density of original background
2. Size and density of originals
3. The existence of solid black when making copies (when a book is copied and the original cover is partially opened)
4. Temperature and humidity in the room when making copies
5. Copy density and image quality mode

As indicated in the figure below, the life of the toner cartridge varies depending on the copy mode and coverage of originals.

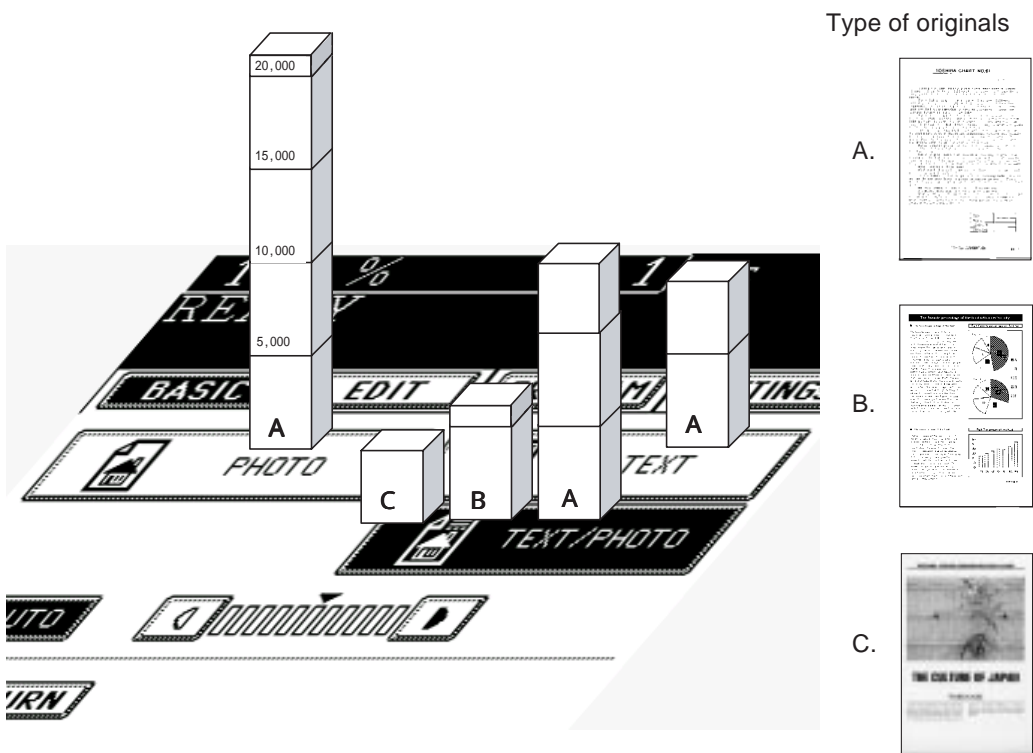

4. CLEAR PAPER SYMBOL

When a paper misfeed occurs in the copier, the CLEAR PAPER  symbol flashes in the positions where paper is misfed. If any of ①~⑧ flashes, the following message will appear:

Misfeed in copier

If any of ⑨~⑪ flashes, the following message will appear:

Misfeed in finisher

Remove the misfed paper by referring to the diagram shown on the right.

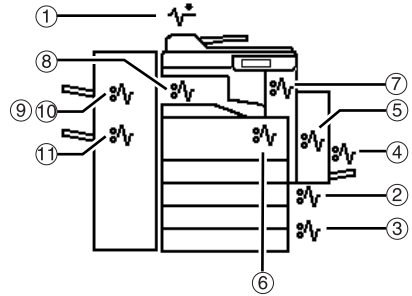

① Paper Misfeed in the Reversing Automatic Document Feeder (optional)

1 Push the button on the reversing automatic document feeder.

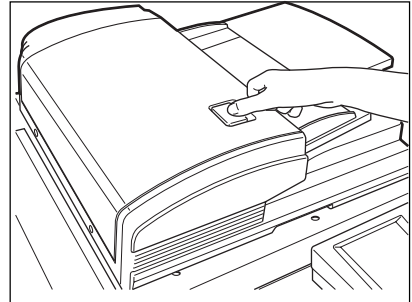

- Remove any misfed originals.

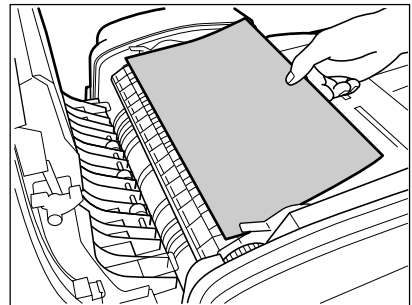

2 Rotate the blue knob on your side in the direction of the arrow and remove any misfed originals.

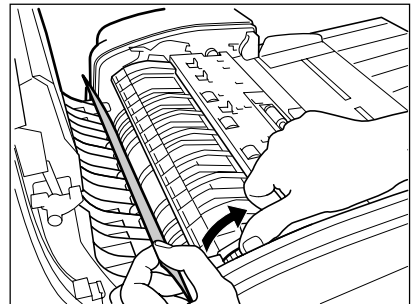

- By rotating the knob in the direction in the opposite direction of previous illustration, you can also remove misfed originals from the side shown.

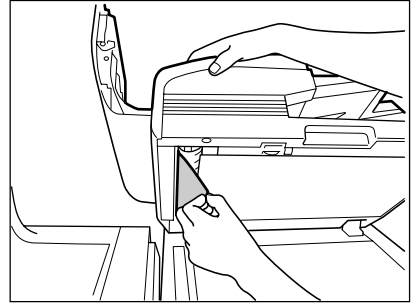

3 Lift the blue handle.

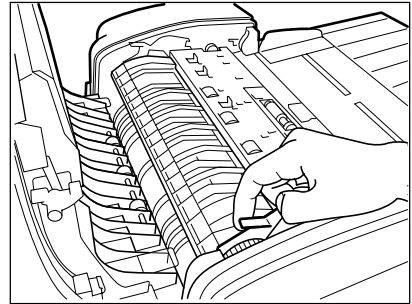

4 Rotate the blue knob on your side to remove any misfed originals.

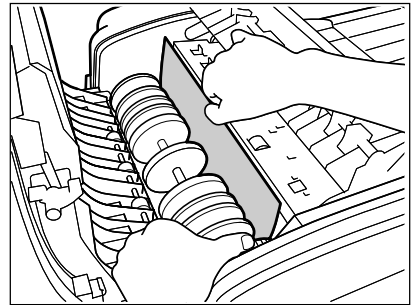

5 Lift the original feeding tray.

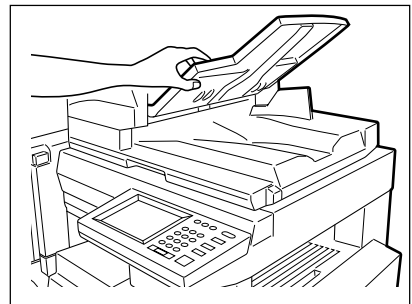

6 Remove any misfed originals.

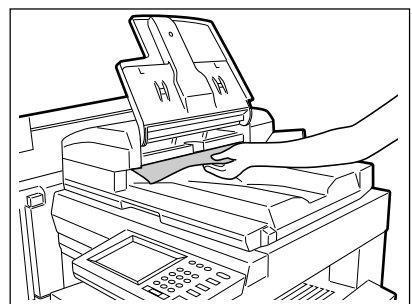

4. CLEAR PAPER SYMBOL (Cont.)

7 Move the blue knob toward the front.

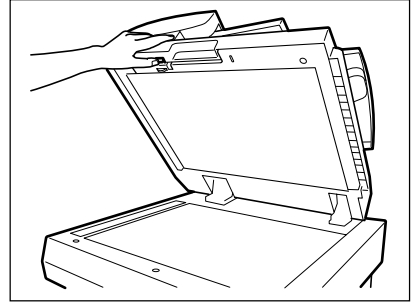

8 Remove any misfed originals.

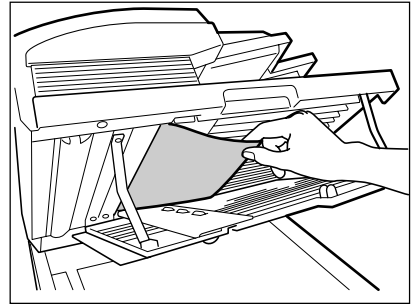

② Paper Misfed in the Cassette Feeding Area

7

1 Open the cover .

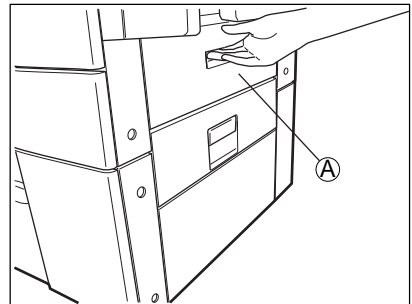

2 Remove any misfed paper.

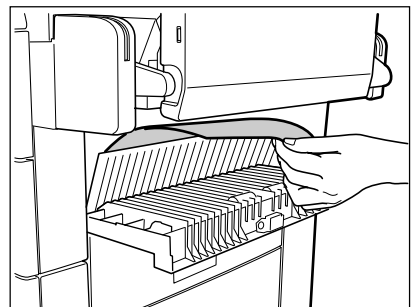

③ Paper Misfeed in the Large-Capacity Feeder (optional)

1 Open the cover **Ⓑ**.

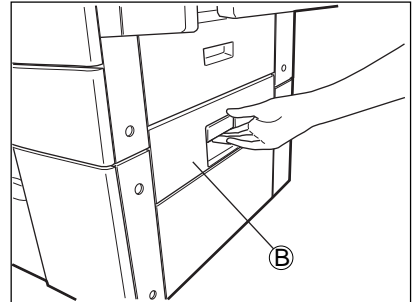

2 Remove any misfed paper.

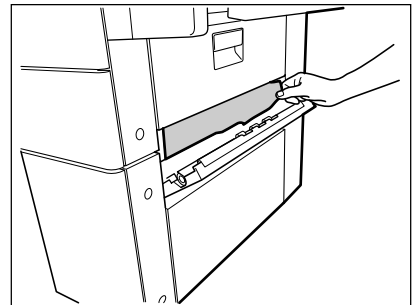

Tip

- **Paper Misfeed in the Paper Feed Pedestal (optional)**
- Open the cover as shown on the right, and remove any misfed paper.
- If the paper is jammed in the upper cassette, open the cover **Ⓐ** and remove it.

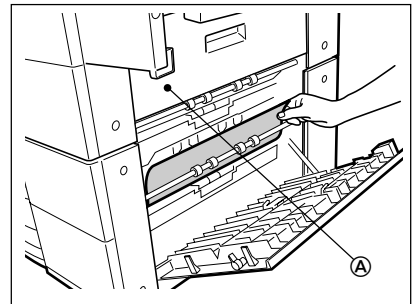

④ Paper Misfeed on the Bypass Feed Unit

1 Pull out misfed paper on the bypass guide.
• Reset the sheets of paper on the bypass guide.

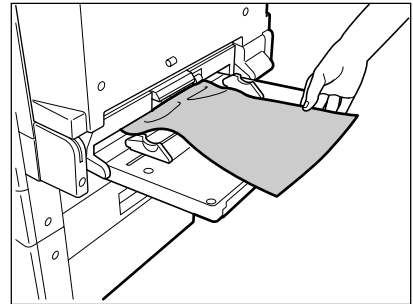

4. CLEAR PAPER SYMBOL (Cont.)

⑤ Paper Misfeed in the Automatic Duplexer

1 Make sure that the bypass guide is opened. Then, hold the handle of the automatic duplexer to lift and open it.

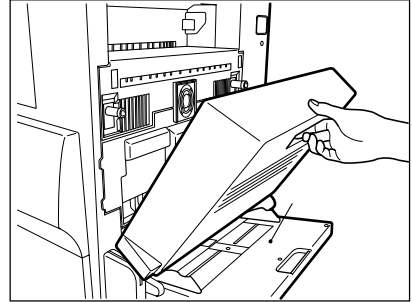

2 Lifting the blue handle indicated with an arrow, remove any misfed paper.

- After having removed the paper, be sure to close the both sides of the automatic duplexer firmly.

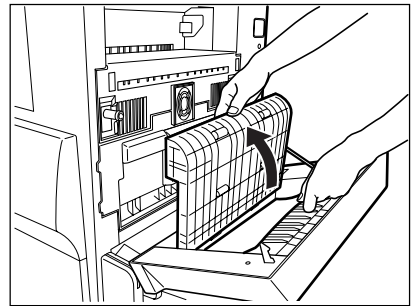

7

⑥ Paper Misfeed in the Jam Releasing Unit

1 Making sure that the bypass guide and the automatic duplexer are opened, pull out the two blue knobs and push down the two fuser pressure release levers.

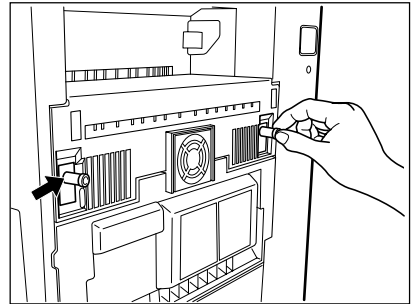

2 Holding the jam releasing unit, open it.

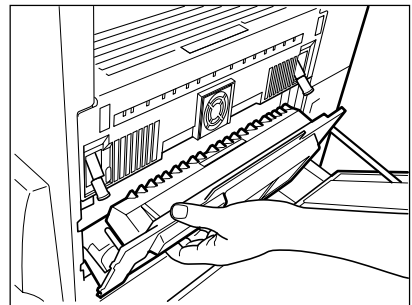

3 Rotate the blue knob indicated with an arrow toward the inside and remove any misfed paper.

- After having removed the paper, be sure to close the both sides of the jam releasing unit cover firmly.

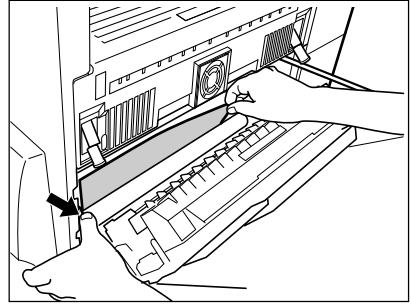

⑦ Paper Misfeed in the Fuser Unit

1 Making sure that the bypass guide, the automatic duplexer and the jam releasing unit are opened, open the fuser unit cover.

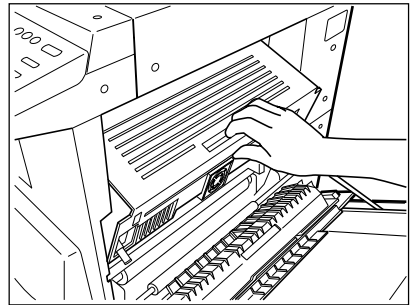

2 Remove any misfed paper inside the fuser unit.

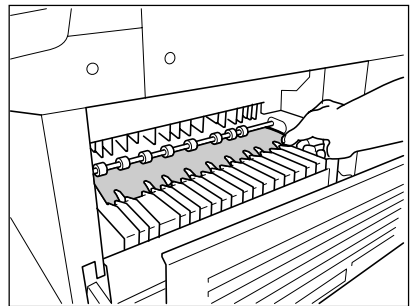

4. CLEAR PAPER SYMBOL (Cont.)

⑧ Paper Misfeed in the Relay Unit

1 Holding the cover handle of the relay unit, open it.

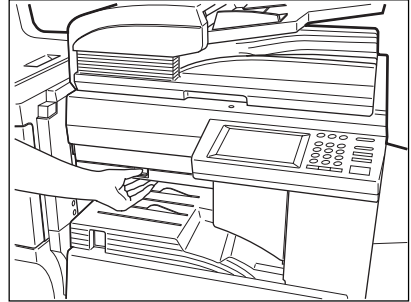

2 Remove any misfed paper inside the relay unit.

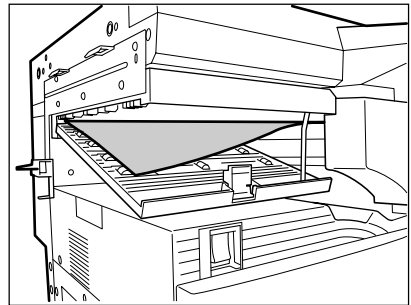

- If paper is misfed at the inner part of the relay unit, remove it pushing down the blue lever.

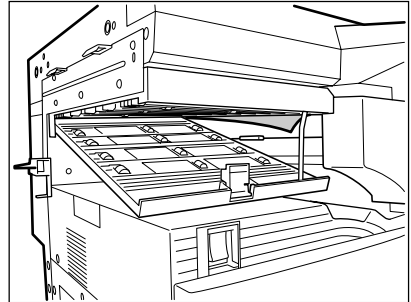

- Remove the misfed paper from the fuser unit side if it is easier.

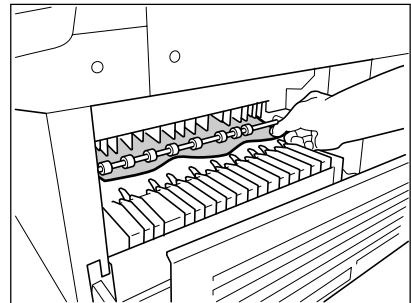

⑨ Paper Misfeed in the Hole Punching Unit (optional)

- 1 While pressing the button indicated with an arrow, pull out the finisher slowly away from the copier.

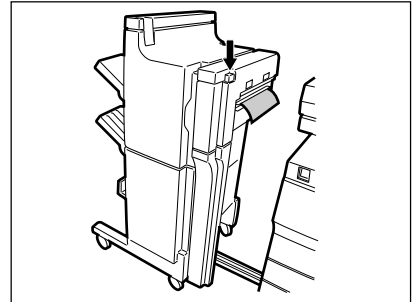

- 2 Open the cover of the hole punching unit.

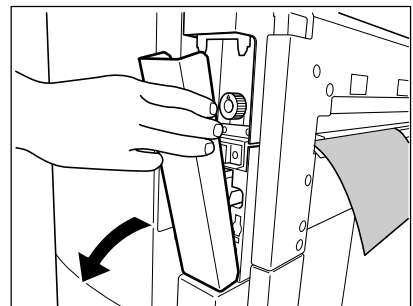

- 3 Rotate the blue knob to locate the arrow within the // area on the label.

- Under this condition, the punchers are up, allowing the paper shown in the figure to be removed.

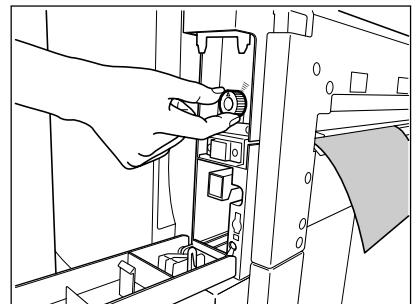

⑩ Paper Misfeed in the Finisher (optional)

- When using the console type:

- 1 Raise the hole punching unit (optional).

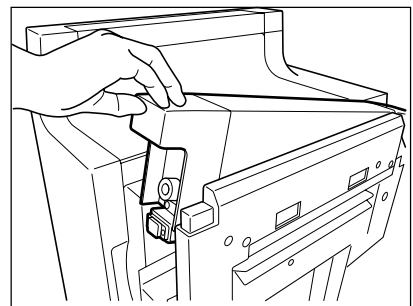

4. CLEAR PAPER SYMBOL (Cont.)

2 Open the upper finisher cover.

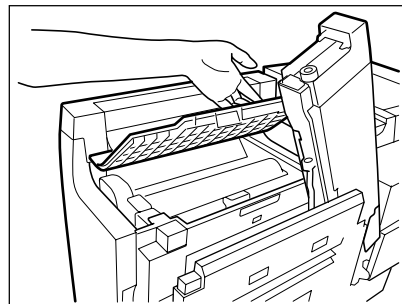

3 Lifting knob ① or knobs ① and ②, remove any misfed paper.

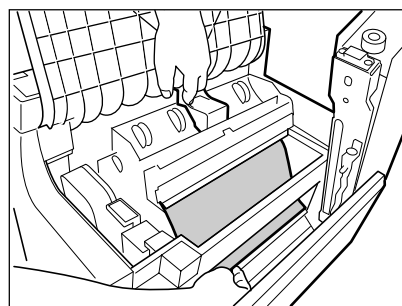
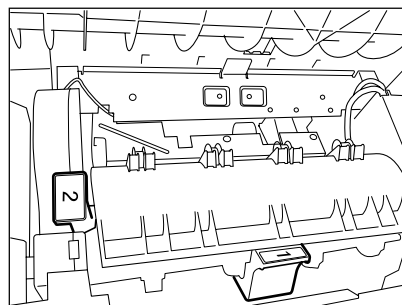

4 Remove any misfed paper in the paper exit area.

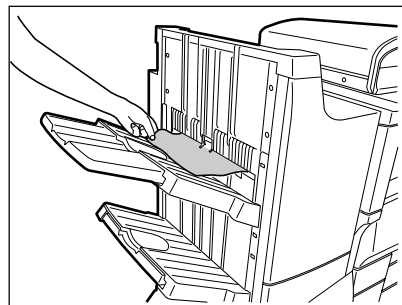

● When using the hanging type:

1 By pulling the lever, move the finisher carefully away from the copier.

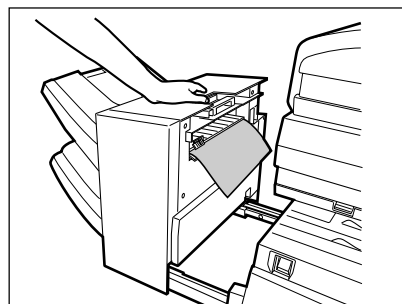

2 Lifting the blue lever, pull out any misfed paper.

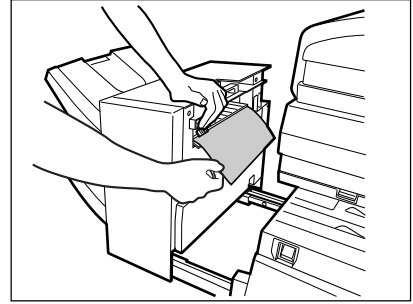

3 Remove any misfed paper in the paper exit area.

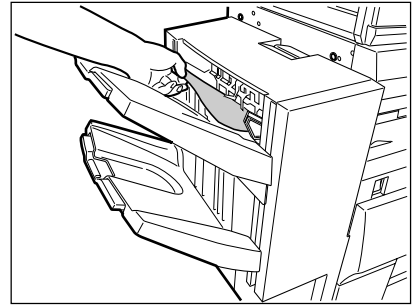

⑪ Paper Misfeed in the Saddle Stitching Unit (optional)

1 Pressing the button shown with the arrow, move the finisher away from the copier.

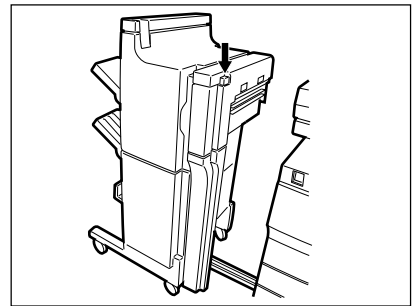

2 Open the saddle stitcher cover and remove any misfed paper.

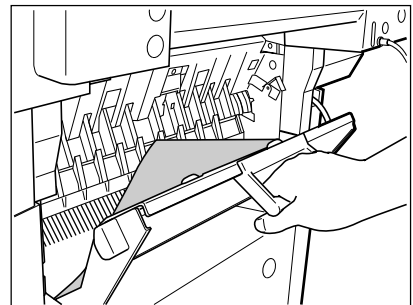

4. CLEAR PAPER SYMBOL (Cont.)

3 Open the lower cover of the finisher.

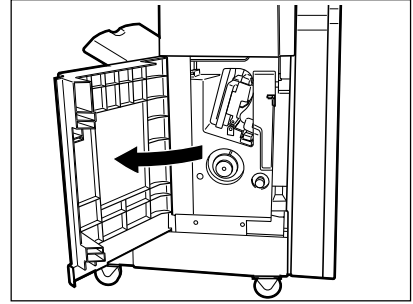

4 Turn the right-hand knob anticlockwise.

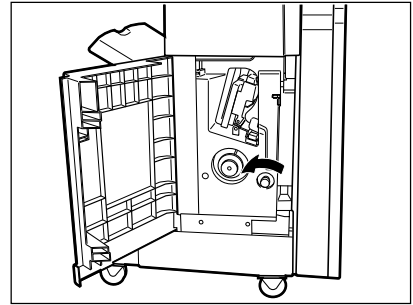

5 Pushing the left-hand knob, turn it clockwise.

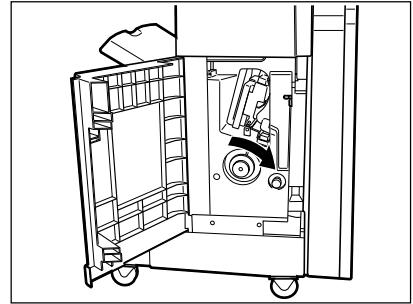

7

6 Remove any paper misfed on the exit side of the saddle stitcher.

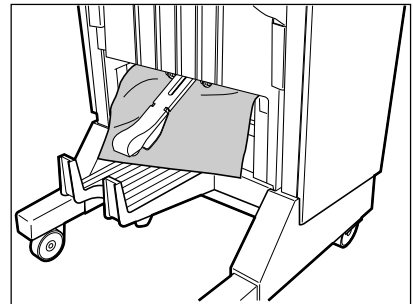

7 Open the exit cover of the saddle stitcher and remove any misfed paper.

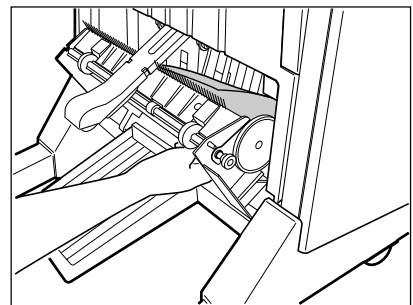

5. ADDING STAPLES

When the staple cartridge runs out of staples, the following message appears:

Set staple cartridge

Add staples to the cartridge according to the procedure below.

Console-Type Finisher

- 1 Open the front finisher cover.

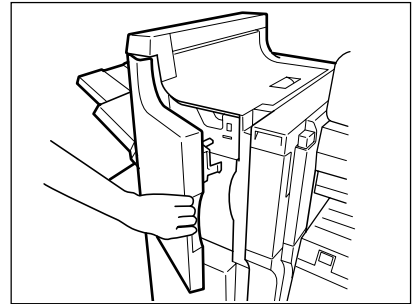

- 2 Lower the blue lever in the stapler and slide out the staple cartridge.

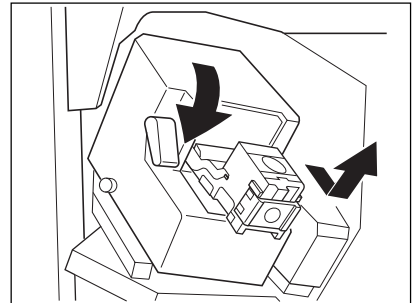

- 3 Remove the empty staple case upward from the staple cartridge.

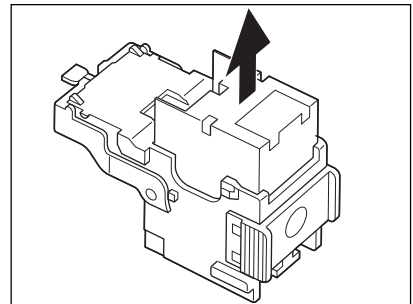

5. ADDING STAPLES (Cont.)

4 Push in a new staple case into the staple cartridge completely inside until a click is heard.

- Do not remove the seal holding the staples before the staple case is set in the cartridge.

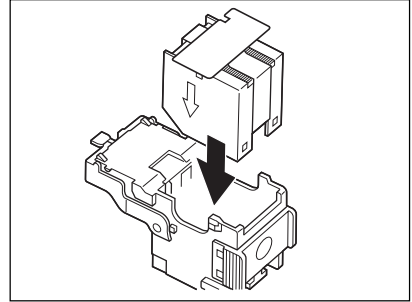

5 Pull out the seal holding the staples straight.

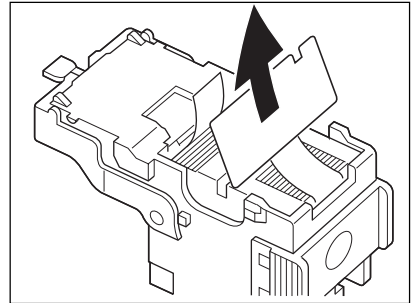

6 Return the staple cartridge to its original position.

- Insert the cartridge until it is caught by the claw and fixed with a click sound.

Note

If the following message remains displayed, repeat the above procedure from steps 1 to 6.

Set staple cartridge

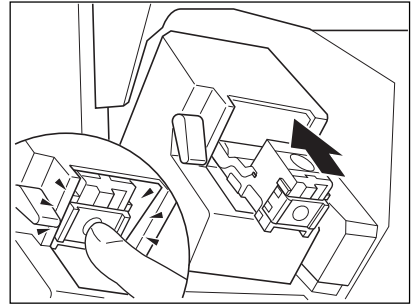

Saddle Stitching Unit

1 Open the lower cover of the finisher.

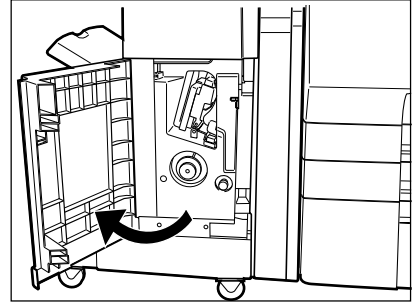

2 Slide out the saddle stitching unit carefully toward the front.

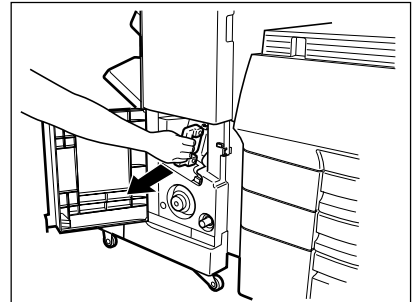

3 Pull out the grip of the saddle stitch holder toward you and turn it 90 degrees clockwise.

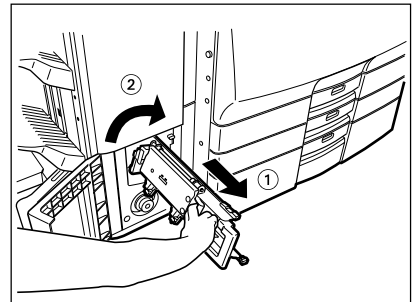

4 Remove the empty staple case and set a new one.
• Replace both staple cases with new ones.

5 Return the saddle stitch holder and the saddle stitching unit to their respective original positions.

6 Make sure that the finisher is attached to the copier firmly and that either of A3, B4 or A4-R size of paper is set in the copier.

- If any of the above paper sizes is not set, test stapling cannot be performed. Set either A3, B4 or A4-R size of paper.

7 Close the lower finisher cover. Then, test stapling is automatically carried out on a blank sheet.

- This operation is carried out to avoid empty stitching.

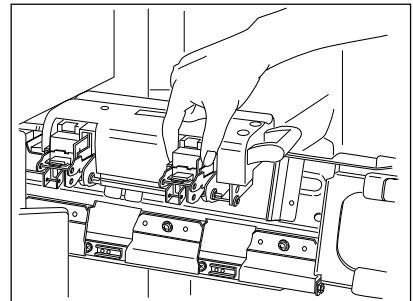

5. ADDING STAPLES (Cont.)

Note

If test stapling fails to be performed and the following message remains displayed, repeat the above procedure from steps 1 to 7.

Set staple cartridge

Hanging-Type Finisher

- 1** By pulling the lever, move the finisher away carefully from the copier.

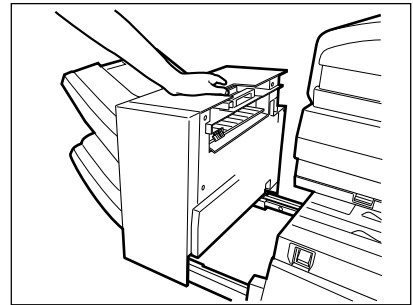

- 2** Holding the sides of the staple cartridge, slide it out.

- 3** Turn the staple cartridge upside down, and perform steps 3 to 5 of the procedure for adding staples to the **Console-Type Finisher** (▶ Page 7-21).

- 4** Turn the staple cartridge to its normal position and push it back into the stapler.

- Insert the cartridge until it is caught by the claw and fixed with a click sound.

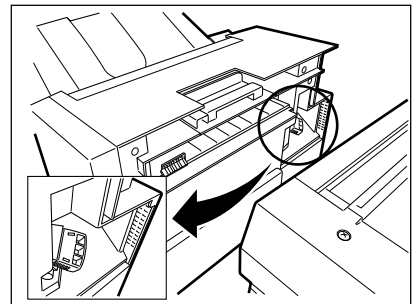

Note

If the following message remains displayed, repeat the above procedure from steps 1 to 4.

Set staple cartridge

6. REMOVING JAMMED STAPLES

When copies have not been stapled in the staple mode, check if the following message is shown on the display:

Examine stapler

If the message is shown, staples have been jammed. Remove them as described below.

Console-Type Finisher

1 Perform steps 1 and 2 of the procedure for “5. ADDING STAPLES (Console-Type Finisher)” (▶ Page 7-21).

2 Holding the knob, lower part Ⓐ.

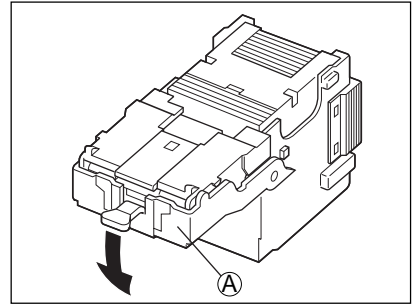

3 Remove any jammed staples using your fingertip or something sharp.

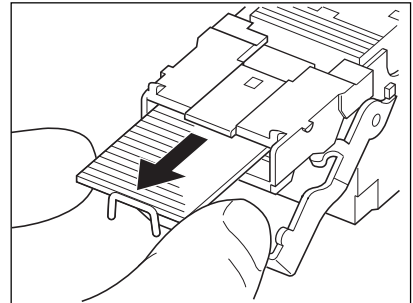

4 Holding the knob, return part Ⓐ to its original position.

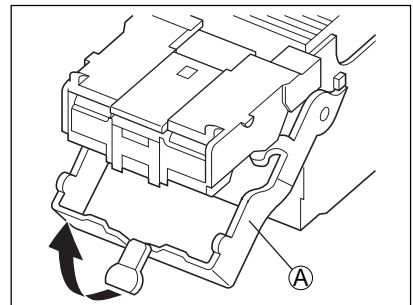

6. REMOVING JAMMED STAPLES (Cont.)

- 5** Slide the staple cartridge back into the stapler.
 - Push the staple cartridge in until it is caught by the claw and fixed with a click sound.
- 6** Close the front finisher cover.

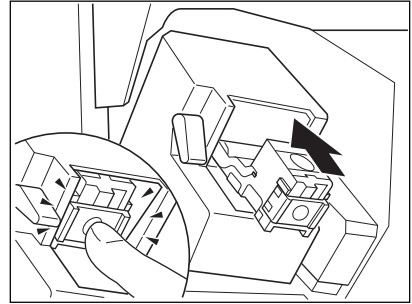

Saddle Stitching Unit

- 1** Perform steps 1 to 3 of the procedure for “5. ADDING STAPLES (Saddle Stitching Unit)” (▶ Page 7-23).

- 2** Remove the empty staple case.

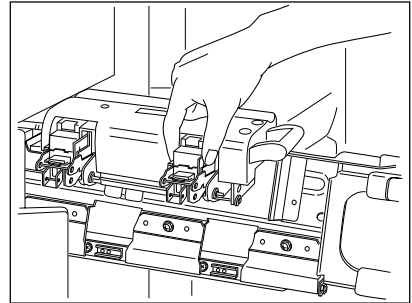

- 3** While pushing down on lever ①, pull up knob ②.

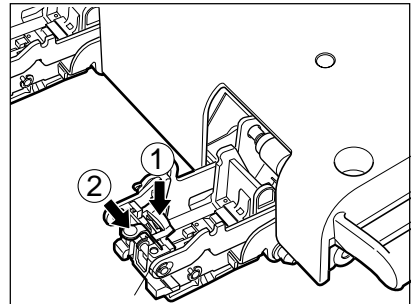

- 4** Remove any jammed staples, and then return knob ② to its original position.

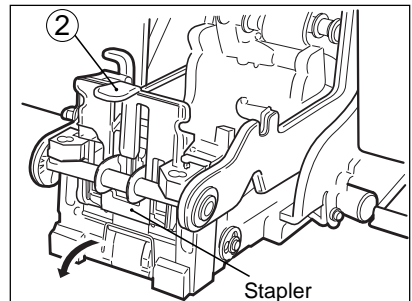

5 Return the staple case to its original position.

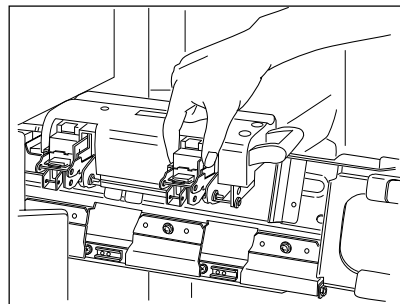

6 Return the saddle stitch holder and the saddle stitching unit to their original positions.

7 Close the lower finisher cover.

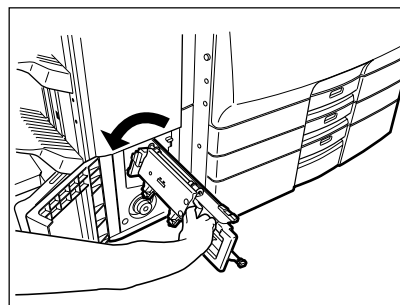

Hanging-Type Finisher

1 Perform steps 1 and 2 of the procedure for “5. ADDING STAPLES (Hanging-Type Finisher)” (► Page 7-24).

2 Perform steps 2 to 4 of the procedure for “6. REMOVING JAMMED STAPLES (Console-Type Finisher)” (► Page 7-25).

3 Return the staple cartridge to its original position.

- Insert the cartridge until it is caught by the claw and fixed with a click sound.

4 Attach the finisher to the copier.

7. CLEARING ACCUMULATED PUNCHED PAPER BITS

When paper bits punched from copies have accumulated to a certain level, the following message appears.

Please Dispose of Hole Punch Dust

Dispose of the paper bits as described below.

Inside the Finisher

- 1** Open the cover of the hole punching unit.

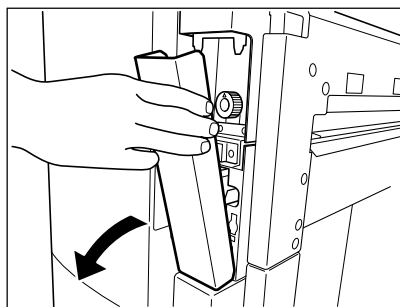

- 2** Holding the black handle, slide out the case containing the paper bits, and dispose of them properly.

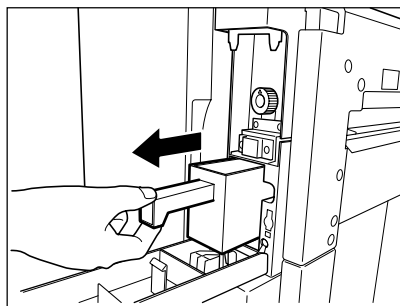

- 3** Return the waste case to its original position.





- 4** Close the cover of the hole punching unit.

7

8. CALL SERVICE SYMBOL

When the CALL SERVICE  symbol flashes, the following message appears and copying is no longer possible. Turn off the POWER switch and call your service technician.

Call for service

When the CALL SERVICE  or CLEAR PAPER  symbol is flashing, if you press the  key and the digital key  together, the corresponding error code will appear on the copy quantity display only while both keys are held down. Please inform of the error code in addition when you are asking for service.

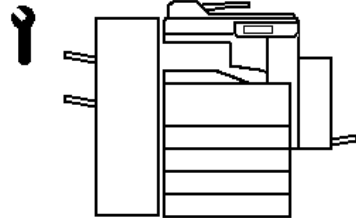

Note

Since heaters are used to fix toner images to the copy paper, a safety circuit is incorporated in this copier. After you turn on the main power switch (* press the  key on the control panel when the copier is in the auto shutoff mode), if a certain temperature is not attained within a certain period of time, the safety circuit assumes that something abnormal has happened, causing the copier to stop its operation. This can possibly occur when the temperature is low even if the copier is not malfunctioning. If this occurs, turn the power switch off and then on again (* same as above). Repeat this procedure twice, and if the problem still persists, turn off the power switch and call for service.

9. PERIODIC MAINTENANCE MESSAGE

When the following message has appeared on the display panel:

Time for periodic maintenance

This indicates that assistance from a qualified service technician is required. Call your service technician for assistance.

8. MAINTENANCE

- 1. Daily inspection 8-2
- 2. Simple troubleshooting 8-4

1. DAILY INSPECTION

Items for Daily Check

Main power switch ON/OFF status

- We recommend turning the main power switch ON at startup everyday so that copies can be made whenever you want. Also, be sure to turn the main power switch OFF when you leave the office.
- Do not turn the main power off when using the auto shutoff and/or weekly timer, and optional functions such as a network printer and/or facsimile.

Weekly Maintenance

To maintain copy quality, the following cleanings are recommended preferably once a week.

- * When cleaning, be careful not to scratch the parts that are cleaned.

Cleaning the Original Glass

If the original glass of the copier is dirty, the stains may be copied.

- Clean the original glass with a cloth moistened with small amount of water or cleaning liquid, then wipe a dry cloth over the glass.

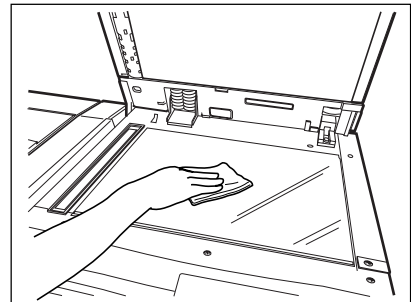

Cleaning the Original Cover

If the back face of the original cover is dirty, the copy may get dirty or the original size may be incorrectly detected.

- Clean the original cover with a cloth moistened with small amount of water, alcohol or a neutral detergent, then wipe off the detergent completely with a dry cloth.

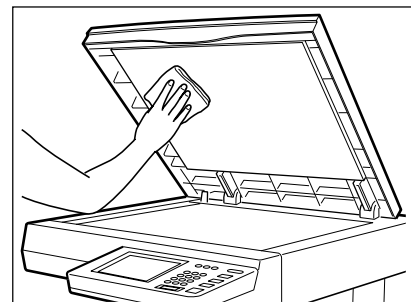

Cleaning the Reversing Automatic Document Feeder (optional)

If the scanning area (transport belt) is dirty, it may cause the original jam or dirty copies. A dirty Mylar may also create dirty copies.

- Clean the transport belt with a cloth moistened with small amount of water, alcohol or a neutral detergent, then wipe off the detergent completely with a dry cloth.

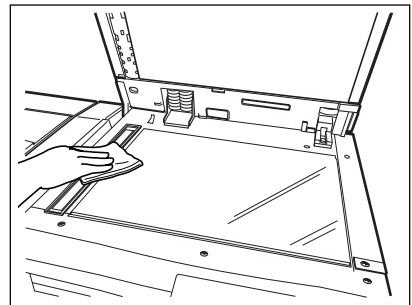
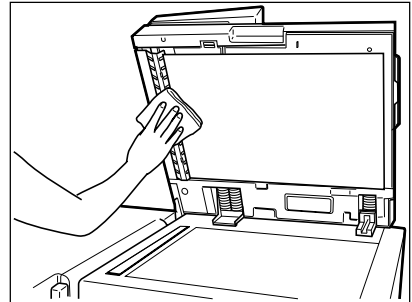

Cleaning the Charger

If the inside of the charger and the wire become dirty, the dirt may appear on the copy.

- * Before start cleaning, BE SURE TO TURN OFF THE MAIN POWER SWITCH, then open the front cover.

1 Open the front cover.

2 Clean the charger.

- Hold the cleaning knob, pull it out slowly and fully to the front and then push it back to the inside carefully and completely. Repeat this 2 or 3 times.

Note

Make sure that the charger knob is pushed in fully inside.

3 Close the front cover.

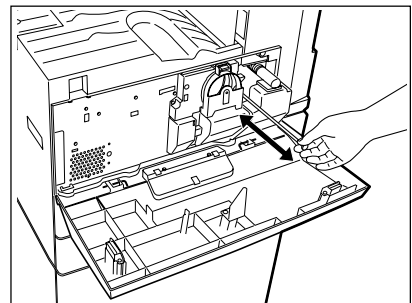





2. SIMPLE TROUBLESHOOTING

Check the following items, and if the problem still occurs, call service for assistance.

Copier does not start

Items to be checked	Countermeasure	Reference page
Is the power cord plug firmly inserted in the outlet?	Insert the power cord plug firmly.	Page 1-2, 7-5, 8-3
Is the front cover firmly closed?	Close the covers properly.	

Display does not change when keys or icons are pressed

Is the copier in the Energy Saving mode?	Press the  START,  PRINTER/NETWORK,  COPY or  FAX or key on the control panel to clear the mode. (It takes a while until the copier becomes ready.)	Page 5-14
Is the department code input? Is the code correct?	Input the correct department code.	Page 1-14
Is a key copy counter used?	If you are using a key copy counter, insert it into the slot.	Page 1-15
Is the "Warming up" message displayed?	Wait until the copier becomes ready.	Page 1-13

Copy density is too low

Has the message "Add toner" appeared on the screen?	Replace the toner cartridge.	Page 7-5
Is the image density set properly?	Set the image density properly with the manual density keys.	Page 3-16

Copy density is too high

Is the image density set properly?	Set the image density properly with the manual density keys.	Page 3-16
------------------------------------	--	-----------

Copies are stained

Items to be checked	Countermeasure	Reference page
Is the original cover firmly closed?	Close the cover firmly to shut out any outer light.	Page 1-2
Is the original glass dirty?	Clean the original glass with a cloth moistened with cleaning liquid, then wipe a dry cloth over the glass.	Page 8-2
Is the original cover dirty?	Clean the original cover or transport belt with a cloth moistened with a neutral detergent.	Page 8-2
Is the transport belt of the optional reversing automatic document feeder dirty?	Then wipe the detergent completely off with a dry cloth.	Page 8-3
Is the image density set properly?	Set the image density properly with the AUTO key or manual density keys.	Page 3-15

Copy images are blurred

Does the entire original lie properly on the surface of the glass?	Place the original firmly on the glass and close the original cover.	Page 1-2
Is the copy paper moist?	Replace with new paper.	Page 1-9

Images are partially missing

Are the original size and direction, as well as the reproduction ratio suitable for the paper size?	Select the same size of copy paper as the original, or set the reproduction ratio suitable for the paper size.	Page 3-6
Is the margin on the copy set properly?	Set a smaller image shift value.	Page 4-2

Touch panel screen is not easy to see

Is the brightness adjusted?	Use the touch panel contrast adjustment knob on the back side of the control panel.	Page 1-2
-----------------------------	---	----------



9. SPECIFICATIONS & OPTIONS

1. e-STUDIO45/35 specifications	9-2
2. Specifications of options	9-3
3. Packing list.....	9-6

1. e-STUDIO45/35 SPECIFICATIONS

Model Name	DP-4500/3500
Type	Desktop type (Console type when the paper feed pedestal is installed)
Original Glass	Fixed (original referenced to top left , referenced to centre when using reversing automatic document feeder)
Copying System	Indirect electrophotographic method
Developing System	2-component magnetic brush developing
Fixing method	Induction heating
Photosensor Type	OPC
Original Scanning System	Linear CCD sensor
Resolution	2400dpi X 600dpi with smoothing
Acceptable Originals	Sheets, books and three-dimensional objects
Acceptable Copy Paper Size	Automatic feeding: A3, A4, A4-R, A5-R, B4, B5, B5-R
	Manual feeding: Paper size within 100~297 mm (Length), 148~432 mm (Width)
Warm-up Time	Approx. 30 seconds
First Copy Time	Approx. 3.9 seconds
Multiple Copying	Up to 999 copies (digital key entry)
Reproduction Ratio	Actual size: 100±0.5%
	Original size: A3, A4, A5, B4, B5
	Paper size: A3, A4, A5, B4, B5, FOLIO
	25~400% (in 1% increments) (Up to 200% when using the reversing automatic document feeder)
Paper Supply	Cassette: 550 sheets
	Sheet bypass: 100 sheets
	Large-capacity feeder: 2500 sheets
Toner Density Adjustment	Magnetic auto-toner system
Exposure Control	Automatic plus manual selection from 11 exposure step
Light Source	Xe lamp
Power Requirements	220-240V, 50/60Hz, 8A
Power consumption	1.5 kW max.
Dimensions	660mm(W) X 673mm(D) X 741mm(H) (copier only)
	1400mm(W) X 755mm(D) X 1222mm(H) (full options)
Weight	approx. 73kg (copier only) 180kg (full options)
Storage Capacity	Max. 2000 images (A4) (Toshiba's own chart)

* Specifications and appearance are subject to change without notice in the interest of product improvement.

2. SPECIFICATION OF OPTIONS

Reversing Automatic Document Feeder

Model Name	MR-3012
Copy Sides	Single-side, Duplex
Number of Originals	Up to 100 originals (50~80g/m ²) or up to 16mm of height of originals
Feeding Speed (A4, single-side)	approx. 45 originals/min. (e-STUDIO45), approx. 35 originals/min. (e-STUDIO35)
Acceptable Original Size	Minimum A5-R
	Maximum A3
	Paper weight 50~127g/m ² (single), 50~105g/m ² (duplex)
Power Source	Supplied from the copier
Dimensions	545mm(W) X 500mm(D) X 165mm(H)
Weight	13.6kg

Paper Feed Pedestal/Large-capacity Feeder

Model Name	KD-1009 (Paper Feed Pedestal)	KD-1010 (Large-capacity feeder)
Type	Console Type	
Number of Cassettes	One	
Acceptable Paper Size	A3, B4, A4, A4-R, B5, B5-R, A5-R, FOLIO	A4
Acceptable Paper Weight	64~80 g/m ²	
Maximum Capacity	550 sheets (60.5mm or less height when loaded)	2500 sheets
Power Source	Supplied from the copier	
Dimension	530mm(W) X 536mm(D) X 305mm(H)	
Weight	17kg	23kg

Cassette Module Device (An option for KD-1009)

Model Name	MY-1017
Acceptable Paper Size	A3, B4, A4, A4-R, B5, B5-R, A5-R, FOLIO
Acceptable Paper Weight	64~80 g/m ²
Maximum Capacity	550 sheets (60.5mm or less height when loaded)
Power Source	Supplied from the copier
Dimension	525mm(W) X 529mm(D) X 107mm(H)
Weight	3.7kg

*Specifications and appearance are subject to change without notice in the interest of product improvement.

2. SPECIFICATION OF OPTIONS (Cont.)

Finisher

Model Name		MJ-1011	MJ-1012	MJ-1013
Type		Hanging Type	Floor Type	Floor Type
Copy	Size	A3, A4, A4-R, A5-R, B4, B5, B5-R		
Paper	Thickness	64~80g/m ²	60~200g/m ²	
Number of Copies		30 sheets (A4, A4-R, B5)	50 sheets (A4, B5)	
Staple at a Time (64~80 g/m ²)		20 sheets (B4) 15 sheets (A3)	30 sheets (A3,A4-R, B4)	
Stapling Position		Rear	Rear, Front, Front diagonal, Double	
Power Source		Supplied from the copier		
Dimensions		431 X 541 X 413 mm	641 X 582 X 1200 mm	641 X 582 X 1200 mm
Weight		18.6 kg	37 kg	57 kg
Saddle Stitcher		No	No	Yes
Puncher		No	Optional	

Tray Loading Capacity (MJ-1012 / MJ-1013)

The tray loading capacity is determined by the loading height in each mode.

Units of mm ± 7mm

* Values in parentheses () = the equivalent number of sheets of paper.

Mode	Non-Sort		Sort/Group		Staples loaded	
					Mixed paper loaded	Mixed paper not loaded
Tray No.	1	2	1	2	1, 2	1, 2
A5-R	147 (1000)	147 (1000)	X	X	X	X
B5-R	74 (500)	74 (500)	X	X	X	X
A4,B5	147 (1000)	147 (1000)	147 (1000)	147 (1000)	Whichever of 110 mm, 750 sheets or 50 cop- ies is reached first	Whichever of 74 mm, 500 sheets or 50 cop- ies is reached first
A3,B4,A4-R, FOLIO	74 (500)	74 (500)	74 (500)	74 (500)	Whichever of 74 mm, 500 sheets or 50 cop- ies is reached first	Whichever of 74 mm, 500 sheets or 50 cop- ies is reached first

When the staples loaded and mixed paper loaded, the maximum number of stapled sheets is 30.

When paper of different widths is mixed, stapling is not possible.

* Specifications and appearance are subject to change without notice in the interest of product improvement.

(MJ-1011 with mixed paper not loaded)

Mode	Non-sort		Sort/Group		Staples loaded	
	1	2	1	2	1	2
B5-R, A5-R	30 (200)	99 (700)	X	X	X	X
A4, A4-R, B5	30 (200)	99 (700)	30 (200)	99 (700)	Whichever of 50 copies or 170 sheets is reached first	Whichever of 50 copies or 600 sheets is reached first
B4	20 (140)	70 (490)	20 (140)	70 (490)	Whichever of 15 copies or 110 sheets is reached first	Whichever of 50 copies or 400 sheets is reached first
A3, FOLIO	15 (100)	49 (350)	15 (100)	49 (350)	Whichever of 15 copies or 80 sheets is reached first	Whichever of 50 copies or 300 sheets is reached first

(MJ-1011 with mixed paper loaded)

Mode	Non-sort		Sort/Group		Staples loaded	
	1	2	1	2	1	2
Mixture of pa- per with dif- ferent width			X	X	X	X
A3 and A4 mixed	15 (100)	49 (350)	15	49	Whichever of 15 copies or 80 sheets is reached first	Whichever of 15 copies or 300 sheets is reached first
B4 and B5 mixed			(100)	(350)	Whichever of 15 copies or 110 sheets is reached first	Whichever of 15 copies or 400 sheets is reached first

Hole Puncher (Options for MJ-1012/MJ-1013)

	Number of punch holes and hole diameter	Available paper sizes
Japan and most of Europe (MJ-6001E)	2 holes (6.5 mm dia.)	A3, B4, A4, A4-R, B5, B5-R, FOLIO
North America (MJ-6001N)	2/3 holes switchable (8.0 mm dia.)	2 holes: LG, LT-R, COMP 3 holes: LD, LT
France (MJ-6001F)	4 holes (6.5 mm dia.; 80 mm pitch)	A3, A4
Sweden (MJ-6001S)	4 holes (6.5 mm dia; 70, 21 mm pitch)	A3, B4, A4, A4-R, B5, B5-R, FOLIO

*Specifications and appearance are subject to change without notice in the interest of product improvement.

3. PACKING LIST

Packing List	Unpacking Instructions
	Set-up Instructions
	Customer Satisfaction Card
	Operator's Manual Pocket

PERIODIC MAINTENANCE

PREVENTATIVE MAINTENANCE

Toshiba copiers are manufactured to the highest technical standards, using quality parts and components, and are designed to meet all electrical safety and environmental requirements.

To ensure that optimum levels of performance and reliability are maintained, we strongly advise that your machine receives regular visits for Periodic Maintenance at the copy intervals prescribed by Toshiba, which are:

150,000 copies (e-STUDIO45) / 116,000 copies (e-STUDIO35) Main Service

On models which incorporate a periodic maintenance message "TIME FOR PERIODIC MAINTENANCE" on the message display, this message will notify you that periodic maintenance has become necessary, when pre-programmed by your dealer technician.

To ensure that the aforementioned quality standards are maintained, we strongly recommended that only Original Toshiba supplies and parts are used in your copier.

How to affix the PM labels

The labels have to be replaced by Service Technicians at the time of setup and each PM time.

To Service Technicians:

At the time of setup and each PM, fill in the appropriate label with the current Total Counter reading, the date and your signature, then peel off and affix the upper part of the next PM sticker to the copier as shown.

1. How to fill in the labels:

Counter		
Date		
Signature		

2. Affixing position

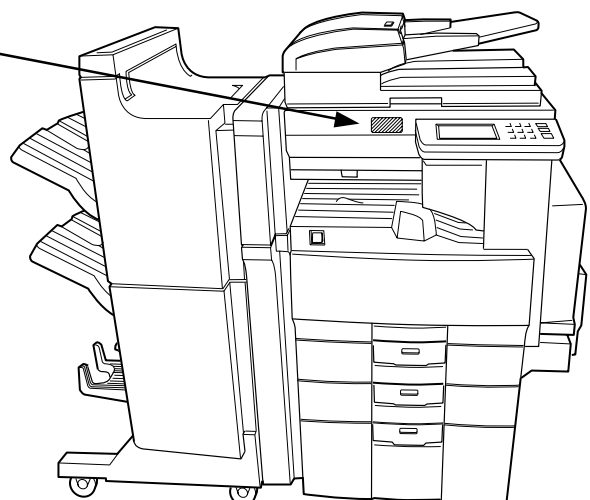

Recycled paper is used for the inside pages of this book.

This Operator's Manual is printed with ink containing soya bean oil.

TOSHIBA TEC CORPORATION

1-1, KANDA NISHIKI-CHO, CHIYODA-KU, TOKYO, 101-8442, JAPAN

Free Manuals Download Website

<http://myh66.com>

<http://usermanuals.us>

<http://www.somanuals.com>

<http://www.4manuals.cc>

<http://www.manual-lib.com>

<http://www.404manual.com>

<http://www.luxmanual.com>

<http://aubethermostatmanual.com>

Golf course search by state

<http://golfingnear.com>

Email search by domain

<http://emailbydomain.com>

Auto manuals search

<http://auto.somanuals.com>

TV manuals search

<http://tv.somanuals.com>