

TOSHIBA

OWNER'S MANUAL

Color Television

Set up

Basic Operation

Advanced Operation

Reference Selection

19A20

Dear Customer

Congratulations! You have purchased one of the finest Color TV's on the market!

This manual will help you use the many exciting and useful features to make your TV viewing more enjoyable than ever before.

Before operating your TV set, please read all these safety and operating instructions completely and then retain for future reference.

Customer's Record

You will find the model number and serial number on the back of your TV set.

Record these numbers in the spaces provided below. Refer to them whenever you call upon your TOSHIBA dealer regarding this product.

Model Number 19A20

Serial Number _____

Safety Precautions

WARNING:

TO REDUCE THE RISK OF FIRE OR ELECTRIC SHOCK, DO NOT EXPOSE THIS APPLIANCE TO RAIN OR MOISTURE.

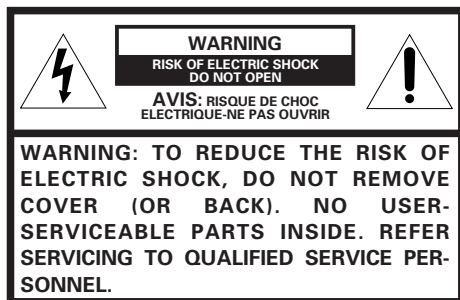

The lightning symbol in the triangle tells you that the voltage inside this product may be strong enough to cause an electric shock. **DO NOT TRY TO SERVICE THIS PRODUCT YOURSELF.**



The exclamation point in the triangle tells you that important operating and maintenance instructions follow this symbol.

CAUTIONS:

TO PREVENT ELECTRIC SHOCK, DO NOT USE THIS POLARIZED PLUG WITH AN EXTENSION CORD RECEPTACLE OR OTHER OUTLET UNLESS THE PRONGS CAN BE FULLY INSERTED INTO THE OUTLET TO PREVENT ANY EXPOSURE OF THE PRONGS ON THE POLARIZED PLUG.

ATTENTION:

POUR PRÉVENIR LES CHOCS ÉLECTRIQUES, NE PAS UTILISER CETTE FICHE POLARISÉE AVEC UN PROLONGATEUR, UNE PRISE DE COURANT OU UNE AUTRE SORTIE DE COURANT, SAUF SI LES LAMES PEUVENT ÊTRE INSÉRÉS À FOND SANS EN LAISSER AUCUNE PARTIE À DÉCOUVERT.

Avoid displaying stationary images on your TV screen for extended periods of time. Stationary patterns generated by computer displays, video games, stock market reports, etc. can become permanently engrained on the picture tube. This damage is not protected by your warranty as it is the result of misuse. Should you wish to use your TOSHIBA Television to display still images, it is always advisable to reduce brightness and contrast settings. Never leave a computer or video game display unattended.

Note to CATV system installer in the USA:

This reminder is provided to call the CATV system installer's attention to Article 820-40 of the NEC that provides guidelines for proper grounding and, in particular, specifies that the cable ground shall be connected to the grounding system of the building, as close to the point of cable entry as practical.

Table of Contents

Set Up

Installing Your TV Set	3
Antenna/Cable TV Connection	4

Basic Operation

Operation of Controls (TV Set)	5
Operation of Controls (Remote Control)	6
Menu Function (General Instructions)	7
Programming Channel Memory	8
Convenient Remote Functions	10
Setting the Off-Timer (Sleep Timer)	11
Adjusting the Picture	12

Advanced Operation

Operating Closed Caption Feature	13
Using V-CHIP Control	14
To select the V-CHIP CONTROL menu ...	14
To adjust the V-CHIP CONTROL menu ...	15
To temporarily unblock programs	17
BLOCK CHANNEL function	17

Reference Section

Cleaning and Care	18
Before Calling Service Personnel	18
Limited United States Warranty	19
Specifications	Back cover

Installing Your TV Set

Where to install

Place the TV on the floor or on a sturdy platform. The mounting surface should be flat and steady.

Lighting

Do not place the TV in a room where direct lighting strikes the screen. Use soft and indirect lighting.

Air circulation

Place the TV far enough from the walls to allow proper ventilation. This will prevent the TV from overheating and avoid possible damage to the TV. Avoid dusty places too.

Power supply

Plug into an electrical outlet with standard household power (120 volt AC, 60Hz). Do not change the plug's safety prong. See the right column.

WARNING : TO AVOID PERSONAL INJURY

- Do not stand or climb on the TV.
- Do not put a VCR or any heavy object on top of the TV.

CAUTION :

As a safety feature, the plug has one prong wider than the other. It will fit only one way into a standard electrical outlet. If the plug will not fit into the outlet, try turning it around. If the plug will not fit either way, the outlet is probably old and non-standard.

You will need to have a new outlet installed by an electrician.

DO NOT CHANGE THE SAFETY FEATURE OF THE PLUG.

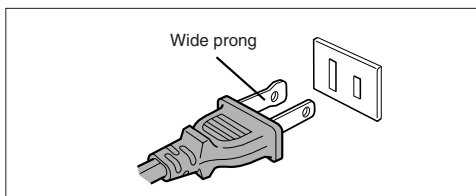

Antenna/Cable TV Connection

You can use either an indoor or outdoor antenna to receive VHF and/or UHF channels.

Channels 2 - 13 are VHF channels, and channels 14 - 69 are UHF channels.

We recommend using an outdoor antenna for better picture quality.

You can receive Cable TV by connecting a cable supplied by your local cable company.

To connect an antenna or Cable without a decoder box

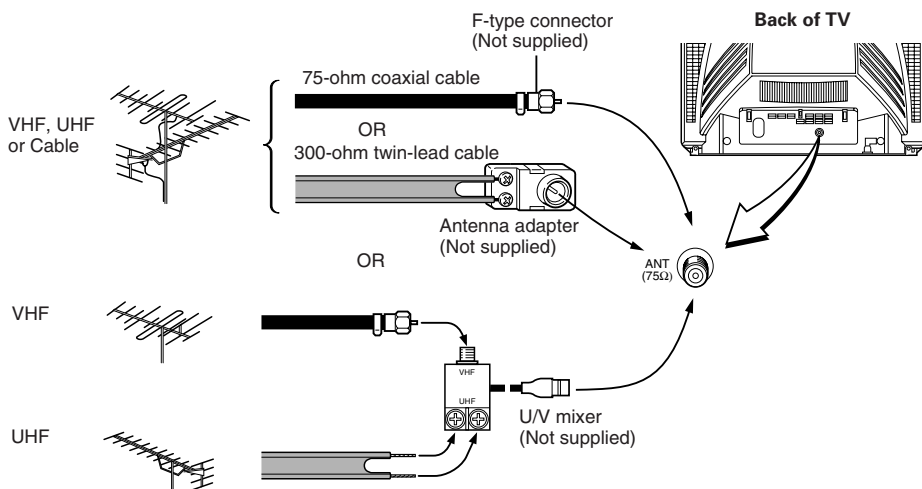

To connect a Cable box or VCR

- Follow this diagram if your cable company requires you to connect a cable box.
- Follow this diagram if you use a VCR.

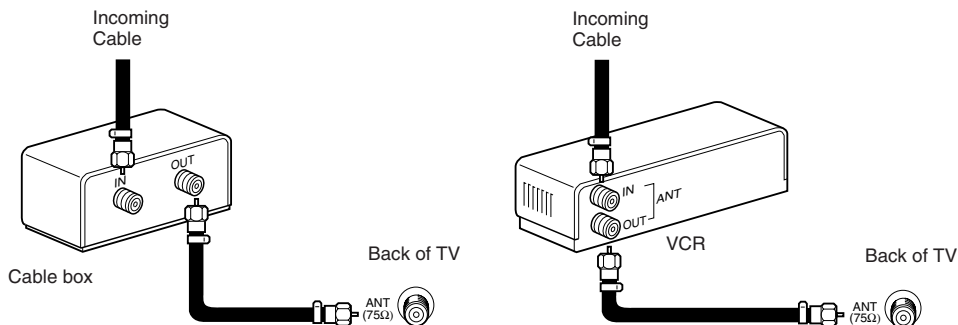

When selecting channels in the cable box, first tune your TV to the output channels of the cable box (usually 3 or 4).

To watch video tapes, tune your TV to the output channel of the VCR (usually 3 or 4), then begin viewing the video tape.

Operation of Controls (TV Set)

Front view

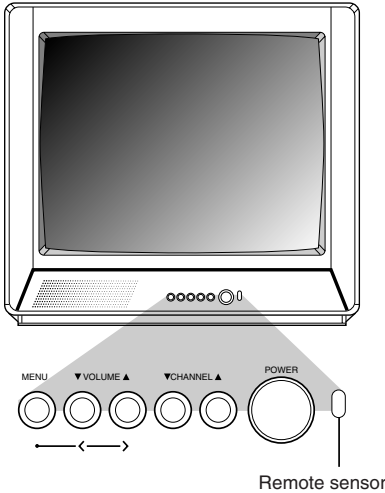

To select on-screen display language

You can choose from three different languages (english, french, and spanish) for the on-screen displays (adjustment menus and messages).

- 1 Press **MENU** (then **▲** or **▼** on Remote) repeatedly until “LANGUAGE” in the Set up menu is displayed in purple.

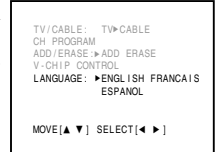

- 2 Press **◀**(<) or **▶**(>) until your desired language is displayed in purple. If you select “FRANCAIS” for example, the display language changes to French.

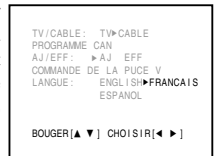

First-Time Operation

Turn on TV and place channels in memory.
See page 8.

POWER button

Press to turn on the TV.
Press again to turn off the TV.

CHANNEL ▼/▲ buttons

Press **▲** to select next higher channel.
Press **▼** to select next lower channel.

VOLUME ▼/▲ buttons (Dual functions with Menu </>)

Press **▲** to increase the volume.
Press **▼** to decrease the volume.

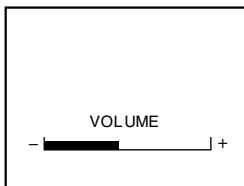

MENU button

Refer to the “Menu Function” on page 7.

MENU </> buttons

Refer to the “Menu Function” on page 7.

Demonstration mode

When this function is activated, your TV will automatically display a variety of its on-screen menus and special features. This function is provided for demonstration purpose only.

- 1 Press **MENU** (then **▲** or **▼** on Remote) repeatedly until “DEMO” in the Option menu is displayed in purple.



- 2 Press **◀**(<) or **▶**(>) to select “START”.

The on-screen demonstration will start after about 15 seconds.

To stop the demonstration

Press **EXIT** on the Remote or select “STOP” in the menu.

Auto-Power-Off feature

If a vacant channel is tuned in or a TV broadcast has finished for the day, the TV automatically turns off after about 15 minutes.

Last Mode Memory feature

If the power is cut off while you are watching the TV and then later restored, the TV will turn back on automatically by the *Last Mode Memory* feature. To ensure that the power does not turn on, when you are away from home for a long time, unplug the power cord from the wall outlet.

Operation of Controls (Remote Control)

This Remote Control allows you to control the functions of your TV set from 16 feet (5m) away. Before attempting to operate the Remote Control, install the batteries according to “Installing and replacing batteries” below. For specific use of each control, consult the corresponding page numbers in brackets.

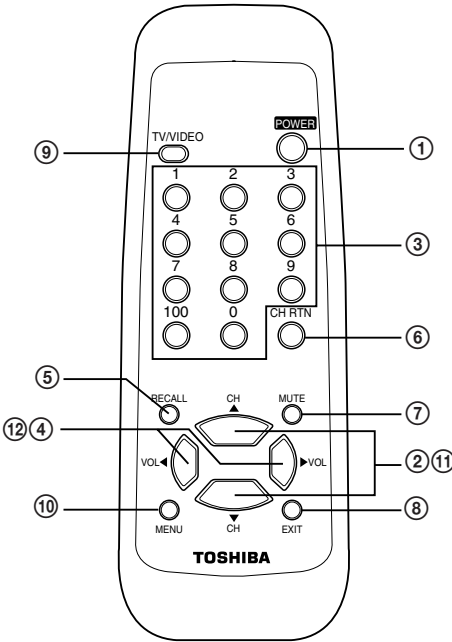

- ① **POWER button**
Press to turn on the TV.
Press again to turn off the TV.
- ② **CHANNEL ▲/▼ buttons (Dual functions with ⑪)**
Press ▲ to select next higher channel.
Press ▼ to select next lower channel.
- ③ **Channel Number buttons**
To select channel 4, press “4” (or press “0”, “4”).
To select channel 38, press “3”, “8”.
To select channel 125, press “100”, “2”, “5” in sequence.
- ④ **VOLUME ◀/▶ buttons (Dual functions with ⑫)**
Press ▶ to increase the volume.
Press ◀ to decrease the volume.
- ⑤ **RECALL button [10]**
- ⑥ **CH RTN button [10]**
- ⑦ **MUTE button [10]**
- ⑧ **EXIT button [7]**
- ⑨ **TV/VIDEO button [10]**
- ⑩ **MENU button [7]**
- ⑪ **Menu ▲/▼ buttons [7]**
- ⑫ **Menu ◀/▶ buttons [7]**

To install and to replace batteries

- 1 Place the Remote Control with the face down, then press down on the ridged area of the battery cover and slide it off.
- 2 Place the two “AA” size batteries, matching the + and – signs on each battery to the + and – signs of the battery compartment.

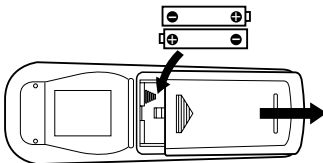

- 3 Replace the battery cover until the lock snaps.

Caution:

- Do not throw your batteries into a fire. Dispose of your batteries in a designated disposal area.
- Do not combine used old batteries with new ones.
- Do not mix battery types.

Note:

- If your Remote Control does not always adjust the set as you wish, you probably need to replace the batteries. The life expectancy of the battery is about one year.
- Remove dead batteries immediately to prevent battery acid from leaking into the battery compartment.
- If you do not intend to use the Remote Control for a long period, remove the batteries.

Menu Function (General Instructions)

We suggest you familiarize yourself with the procedure before using the Menu function.

To adjust any TV feature, the use of the Menu function is required. The adjustments that can be made to the TV appear on the screen.

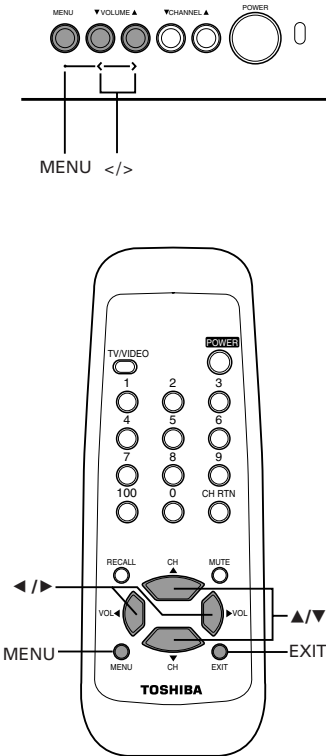

MENU button (on Remote)

Each time you press **MENU**, the Picture, Setup or Option menu on-screen display is selected in order, then press **▲** or **▼**.

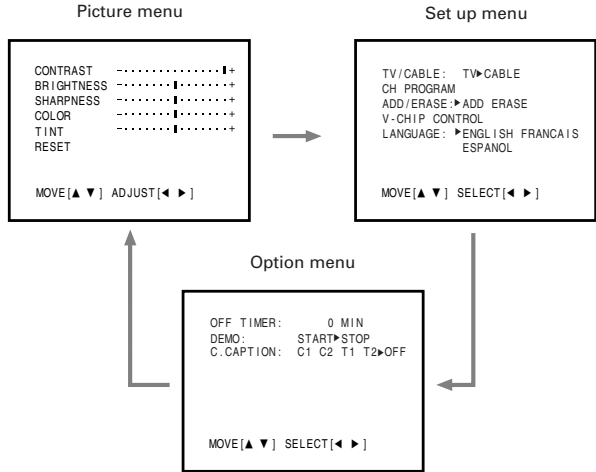

MENU button (on TV)

Each time you press **MENU**, each item will be selected in order, then press **<** or **>**.

Note:

- The **</>** buttons on the TV will function as the **VOLUME ▲/▼** buttons when no menu display is on the screen.
- The **▼/▲** buttons on the Remote will function as the **CHANNEL ▼/▲** buttons when no menu display is on the screen.
- The **◀/▶** buttons on the Remote will function as the **VOLUME ◀/▶** buttons when no menu display is on the screen.

▲/▼ buttons (on Remote)

Use s/t after you have selected the on-screen menu you want to adjust with the **MENU** button.

Each time you press **▲** or **▼**, the function to be adjusted will be selected in order.

ADV **▲** button from bottom to top

ADV **▼** button from top to bottom

The selected function will be displayed in purple.

◀/▶ (</>) buttons (on Remote and on TV)

Use **◀/▶ (</>)** to adjust the function you have selected with the **▲/▼** buttons on the Remote (or **MENU** button on the TV).

EXIT button (on Remote)

The menu display will disappear automatically if you do not press a button within 15 seconds.

If you want to erase the screen of all on-screen displays instantly, press **EXIT**.

Programming Channel Memory

The channel memory is the list of TV channel numbers your TV will stop on when you press the **CHANNEL ▲** or **▼** button. **First, use the TV/CABLE and CH PROGRAM functions to preset all active channels in your area.** If necessary, arrange the preset channels with the ADD/ERASE functions so that you can tune into only desired channels.

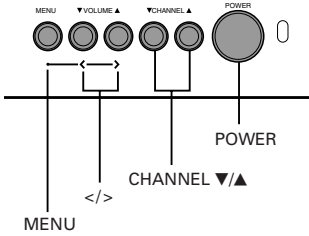

TV/CABLE function

- 1 Press **POWER** to turn on the TV.
- 2 Press **MENU** (then **▲** or **▼** on Remote) repeatedly until “TV/CABLE” in the Set up menu is displayed in purple.



- 3 Press **◀** (<) or **▶** (>) until the mode that corresponds to your TV signal system is displayed in purple.

TV: TV broadcasts signals.
 (VHF channels 2 through 13 and UHF channels 14 through 69)
CABLE: Cable TV signals.
 (Cable channels 1 through 125)

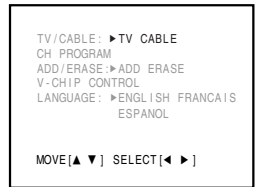

CH PROGRAM function

- 1 Press **MENU** (then **▲** or **▼** on Remote) repeatedly until “CH PROGRAM” in the Set up menu is displayed in purple.



- 2 Press **◀** (<) or **▶** (>) to start channel programming. The TV will automatically cycle through all the TV or CABLE channels depending on the mode selected, and store active channels in the channel memory.

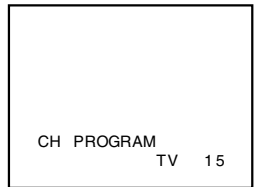

- 3 When channel programming is complete, you will see the message at the right.

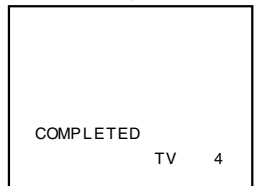

- 4 Press **CHANNEL ▲** or **▼** to make sure the channel programming has been done properly.

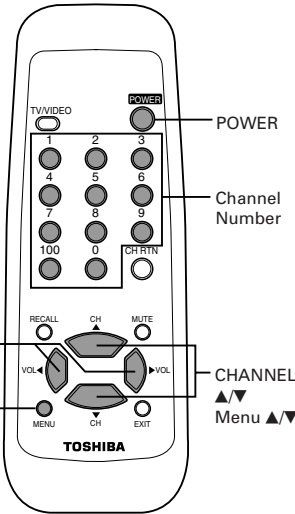

ADD/ERASE function

After performing the CH PROGRAM function, you can add or erase specific channels.

- 1 Select the channel you want to erase using the **CHANNEL ▲** or **▼** button, or select the channel you want to add using the **Channel Number** buttons.

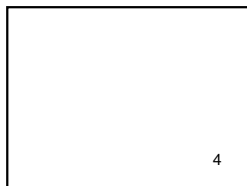

- 2 Press **MENU** (then **▲** or **▼** on Remote) repeatedly until "ADD/ERASE" in the Set up menu is displayed in purple.



- 3 Press **◀** (<) or **▶** (>):
To erase the channel
 Press the button until "ERASE" is displayed in purple indicating that the channel has been erased from the memory.



- To add the channel**
 Press the button until "ADD" is displayed in purple indicating that the channel has been memorized.



- 4 Repeat steps 1 to 3 for other channels.

You have now completed the channel programming.

Convenient Remote Functions

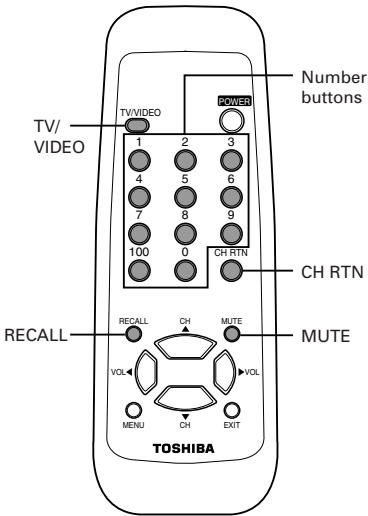

To select VCR channel

Press **TV/VIDEO** once to select channel 3 (VCR channel).
Use this button to watch a video tape playing.
To restore the channel, press **TV/VIDEO** again.



To mute the sound

Press **MUTE** to mute the sound. The word "MUTE" will be displayed on the screen as shown. This is useful during telephone calls or other interruptions.
To restore the sound, press **MUTE** again.



Note: When the MUTE button is pressed, the Closed-Captioned feature "CI" is activated. ("MUTE" on-screen display will disappear.) To deactivate, press the MUTE button again. (This feature only functions when the Closed Caption mode is set to "OFF".)

To display on-screen information

Press **RECALL** to display the following on-screen information.

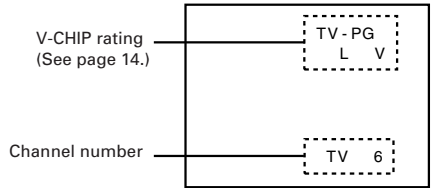

To change quickly between two channels

Press **CH RTN** to return to the last channel viewed. This is useful should you want to view two channels. This allows you to view two programs without entering an actual channel number each time.

To operate this function

- 1 Select the first channel you want to view.
- 2 Select the other channel with the **Channel Number** buttons.
- 3 Press **CH RTN**.
The previous channel will return.

Each time you press **CH RTN**, the TV will switch back and forth between the two channels.

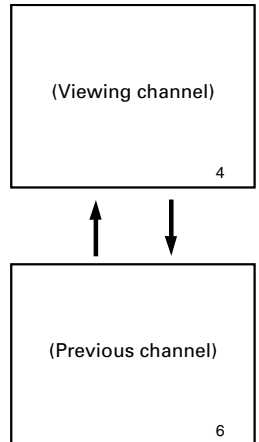

Setting the Off-Timer (Sleep Timer)

With the off-timer, you can set the TV to turn off automatically after a pre-determined period of time (up to 180 minutes in 10 minute units).

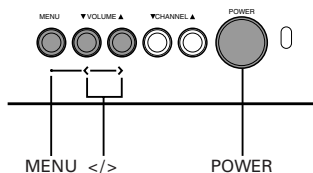

To set the OFF-timer

1 Press **MENU** repeatedly until the Option menu is displayed on the screen.

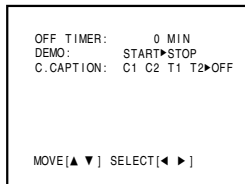

2 Press **MENU** on the TV or **▼** or **▲** on the Remote until "OFF TIMER" is displayed in purple.

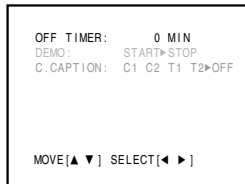

3 Press **◀** (<) or **▶** (>) to enter the length of time you want the TV to stay on. Each time you press the button, the time display will increase (▶) or decrease (◀) by 10 minutes.

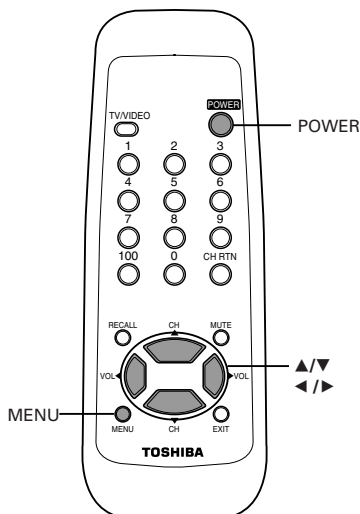
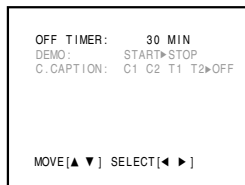
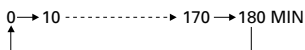

To cancel the setting

Press **POWER** twice, once to turn the TV off and once to turn it on again.

Adjusting the Picture

You can adjust the picture quality (CONTRAST, BRIGHTNESS, SHARPNESS, COLOR and TINT) to suit your personal preference.

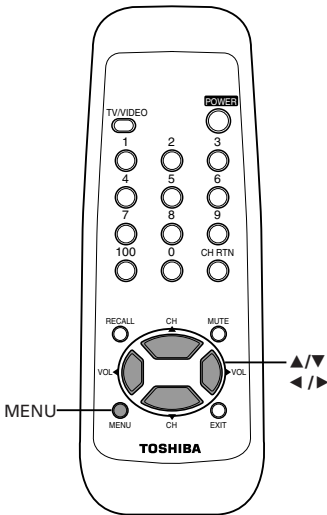
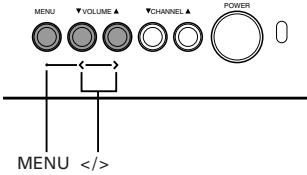

To adjust the picture quality

1 Press **MENU** (then **▲** or **▼** on Remote) repeatedly until the selection in the Picture menu is displayed in purple.

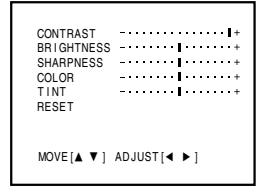

2 Press **◀** (<) or **▶** (>) to adjust the level.

Example: CONTRAST adjustment mode display

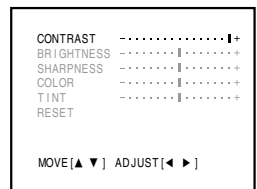

Selection	Pressing	
	◀	▶
CONTRAST	lower	higher
BRIGHTNESS	darker	lighter
SHARPNESS	softer	sharper
COLOR	paler	deeper
TINT	reddish	greenish

To reset the PICTURE adjustment to the factory-preset level
(maximum CONTRAST and all other adjustments centered)

1 Press **MENU** (then **▲** or **▼** on Remote) repeatedly until “RESET” in the Picture menu is displayed in purple.

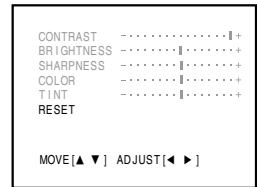

2 Press **◀** (<) or **▶** (>).



Operating Closed Caption Feature

You have two options with the closed caption feature: captions or text.

A caption is a printed version of the dialogue, narration and/or sound effect of a TV program. Text is information not related to the program that appears on the lower half of the TV screen.

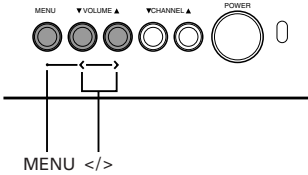

To view captions or text

- 1 Select the desired program.
The captioned programs are usually noted in your local TV listings by service marks such as "CC".
- 2 Press **MENU** (then **▲** or **▼** on Remote) repeatedly until "C. CAPTION" in the Option menu is displayed in purple.
- 3 Press **◀** or **▶** to select the closed caption mode.

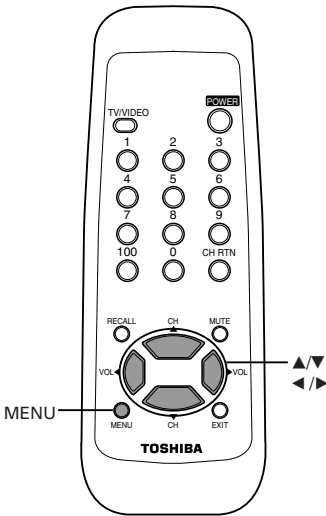
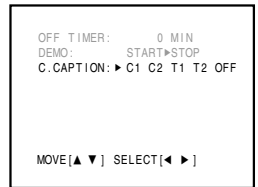
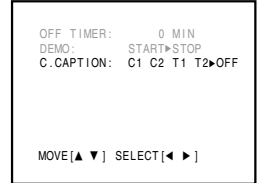

- Select C1 or C2 to view captions. Select C1 for translation of the primary language in your area.
- Select T1 or T2 to view Text.

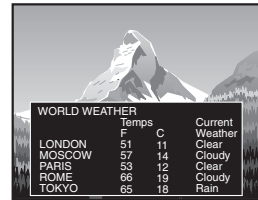

To turn off the closed-captioned feature

Select "OFF" in step 3 above.

Note:

- A closed-captioned signal may not be decoded in the following situations.
 - When a video tape has been dubbed.
 - When the signal reception is weak.
 - When the signal reception is non-standard.
- If you select a closed-captioned channel and the Text mode, the text screen always appears.
However, text characters are not displayed when no signal is aired.

Using V-CHIP Control

Some TV programs and movies includes signals that classify the content of the program (violence, sex, dialog, language). The V-CHIP Control feature in this TV detects then signals and blocks the programs according to selections. To use this feature, perform the following setup.

To select the V-CHIP CONTROL menu

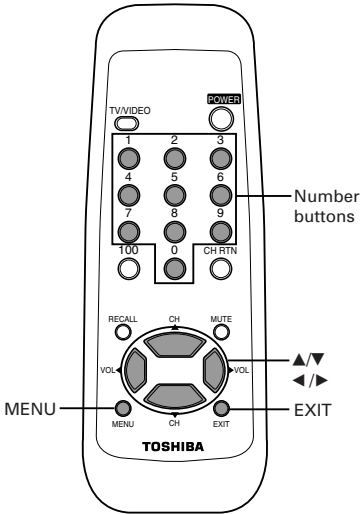

1 Press **MENU** (then **▲** or **▼** on Remote) repeatedly until “V-CHIP CONTROL” in the Set up menu is displayed in purple.



2 Press **◀** (<) or **▶** (>) to display the pin code entering mode.

• Factory reset status

Set your 4 digit code by pressing the Number buttons (0-9).

Example: To enter “1110”
Press 1, 1, 1, and 0 in order.

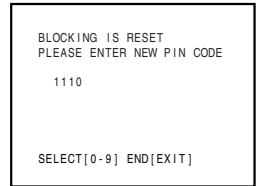

• When the pin code is already stored

Press the **Number** buttons (0-9) to enter the 4-digit pin code used to block channels.

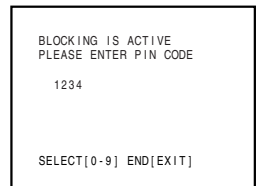

If a wrong pin code has been entered

this message will appear. Try to enter the correct code again.

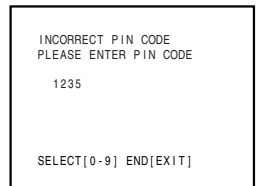

If you can not remember the pin code you have stored, while in the pin code entering mode, press the **RECALL** button four times within 5 seconds.

The pin code you have stored will be released. (Factory reset status).

3 After about 1 second, the screen changes to the V-CHIP CONTROL menu as shown.

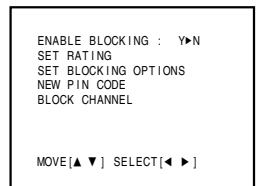

To return to the normal picture,
Press **EXIT**.

Continue to set each item following the steps on the next page.

V-CHIP CONTROL menu

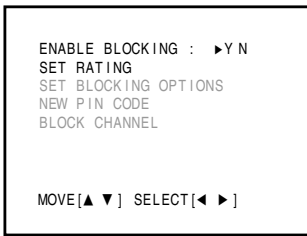

To select each item,
Press ▼ or ▲.

To adjust the V-CHIP CONTROL menu

ENABLE BLOCKING

Press ◀ or ▶ to select “Y” or “N”.

Y: To enable your setting (Block)

N: To release your setting (Unblock)

Note: The BLOCK CHANNEL function is not affected with this selection.

SET RATING (Setting the movie or TV ratings for your choice)

1 Press ◀ or ▶ to display the SET RATING menu.

2 Press ▼ (or ▲) to select item.

3 Press ▶ to block (display “X”)

Press ◀ to unblock (display “✓”)

4 Repeat steps 2 and 3 to set the next item.

1st menu

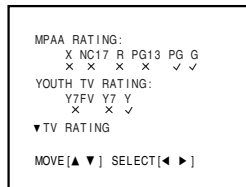

2nd menu

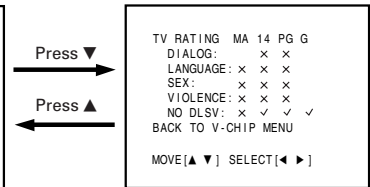

About Rating

The rating of the TV programs you are now watching can be confirmed by pressing the **RECALL** button.

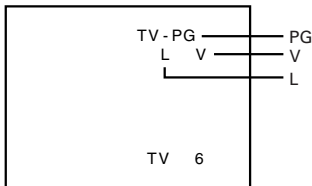

MPAA RATING: Independent rating system for movies

G: General Audience (Appropriate for all ages)

PG: Parental Guidance Suggested (Some material may not be suitable for children)

PG13: Parents Strongly Cautioned (Some material may be inappropriate for children under 13)

R: Restricted (Under 17 requires accompanying parent or adult guardian.)

NC17: Not intended for anyone 17 and under

X: X-rated (For adults only)

TV RATING: Independent rating system for Broadcasters

Y: All Children (This program is designed to be appropriate for all children)

Y7, Y7FV: Directed to Older Children (This program is designed for children age 7 and above. Note: For those programs where fantasy violence may be more intense or more combative than other programs in this category, such programs will be designated TV-Y7-FV.)

G: General Audience (Most parents would find this program suitable for all ages.)

PG: Parental Guidance Suggested (This program contains material that parents may find unsuitable for younger children.)

D) Some suggestive dialog

L) Infrequent coarse language

S) Some sexual situations

V) Moderate violence

14: Parents Strongly Cautioned (This program contains some material that many parents would find unsuitable for children under 14 years of age.)

D) Intensely suggestive dialog

L) Strong coarse language

S) Intense sexual situations

V) Extreme violence

MA: Mature Audience Only (This program is specifically designed to be viewed by adults and therefore may be unsuitable for children under 17.)

L) Crude or indecent language

S) Explicit sexual activity

V) Graphic violence

Using V-CHIP Control (continued)

V-CHIP CONTROL menu

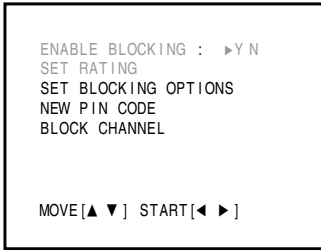

To select each item,
Press ▼ or ▲.

To adjust the V-CHIP CONTROL menu (continued)

SET BLOCKING OPTIONS

Press ◀ or ▶ to display the SET BLOCKING OPTIONS menu, then press ▼ or ▲ to select item.

BLOCK MPAA UNRATED

Press ◀ or ▶ to select “Y”(Block) or “N”(Unblock) for unrated programs on MPAA rating system.

BLOCK TV NONE RATING

Press ◀ or ▶ to select “Y”(Block) or “N”(Unblock) for unrated programs on TV PARENTAL GUIDELINES. If you select “Y”, the NOTICE shown below will be displayed since the emergency information will also be blocked.

SET BLOCKING OPTION menu

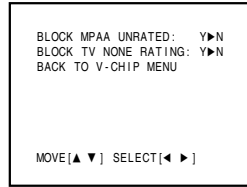

If you select “Y” on TV rating

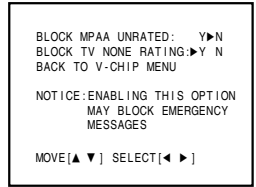

Advanced Operation

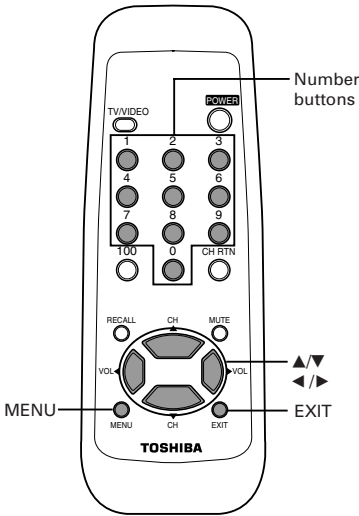

BACK TO V-CHIP MENU

Press ◀ or ▶ to return to the V-CHIP CONTROL menu.

NEW PIN CODE (Changing Pin Code)

1 Press ◀ or ▶ to display the NEW PIN CODE menu.

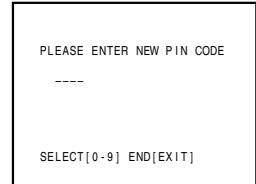

2 Press the **Number** buttons (0-9) to enter a 4-digit code. The numbers you enter will replace the dashes in the display.

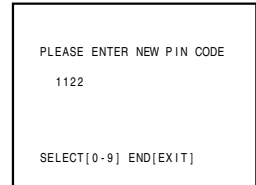

Example: To enter “1122”
Press 1, 1, 2, and 2 in order.

3 After about 1 second, the display will return to the V-CHIP CONTROL menu.

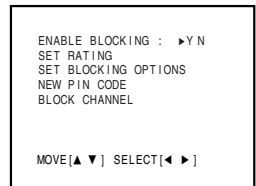

NOTE:
See page 14 for more
Pin Code information.

To temporarily unblock programs

- 1 If you try to watch a TV program that exceeds the rating limits you set, the TV will enter into the program block mode.

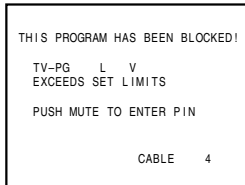

- 2 If you want to watch the blocked program temporarily, press **MUTE**.

Press the **Number** buttons (0-9) to enter the 4-digit code you have stored.

If the number is correct, the block mode will be released. After 1 second, normal picture will appear.

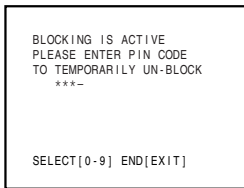

All blocking is disabled until the TV is turned off. It will be enabled when the power is reapplied.

If a wrong pin code is entered, the message appears. Enter the correct code again.

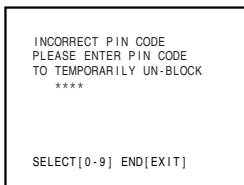

BLOCK CHANNEL function

With the CHANNEL BLOCK function, you can block specific channels. The TV will not be able to tune these channels with the **CHANNEL ▲/▼** buttons or **Channel Number** buttons, unless you clear the setting.

This TV has 8 memory spaces total, 4 for TV mode and 4 for CABLE mode.

To block channels

- 1 Select a channel you want to block.

- 2 Select "BLOCK CHANNEL" in the V-CHIP CONTROL menu by pressing ▼ or ▲.

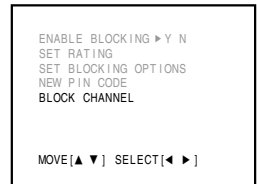

- 3 Press ◀ or ▶ to display the BLOCK CHANNEL menu.

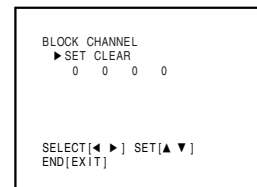

- 4 Press ◀ or ▶ to select "SET", then press ▼ or ▲ until the channel number to be blocked ("2" in this example) replaces "0" on the display.

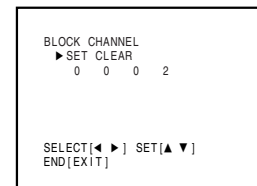

- 5 Repeat steps 1 to 4 for other channels.

- 6 Select another channel before turning off the TV.

To restore channels

- 1 Select "CLEAR" following the above steps 2 to 4.

- 2 Press ▼ or ▲ until "0" replaces the channel numbers.

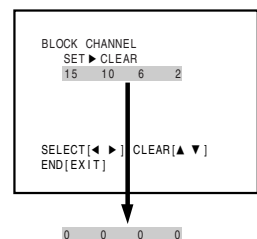

- 3 Press **EXIT** to erase the display.

Cleaning and Care

WARNING: TV sets use High Voltage. Do not try to remove the cabinet back. Refer servicing to qualified service personnel.

- To clean the TV screen:
 1. First remove the plug from the power outlet to avoid possible shock hazard.
 2. Use a clean cellulose sponge or chamois cloth dampened with a solution of mild detergent and warm water to clean TV screen and trim. Do not use too much water on the TV screen. Water spills into the cabinet and may cause damage to the TV. Avoid excess water.
 3. Remove any extra moisture with the same cloth or a dry one.
- To maintain the finish and appearance of the cabinet, polish it from time to time with a quality furniture polish.

Caution: *Never use strong solvents such as thinner, benzene or other chemicals on or near cabinet, as they might damage the finish of the cabinet.*

Before Calling Service Personnel

Before calling service personnel, please check the following chart for a possible cause of the problem you are experiencing. A minor adjustment on your part may eliminate the problem and restore your TV reception.

Problem	Checks and Adjustments	Page
TV will not turn on	<ul style="list-style-type: none"> ● Make sure the power cord is plugged in, then press POWER button. ● Check battery in remote. (Maybe batteries are “dead”.) 	6
No picture, no sound	<ul style="list-style-type: none"> ● If watching VCR, make sure TV is tuned to channel 3 or 4. ● Check antenna/cable connections. 	
No sound, picture OK	<ul style="list-style-type: none"> ● Maybe sound is muted. Try pressing VOLUME ▲ button. ● Try another channel. (Maybe station trouble.) 	
Poor sound, picture OK	<ul style="list-style-type: none"> ● Try another channel. (Maybe station trouble or local interference from appliance.) 	
Poor picture, sound OK	<ul style="list-style-type: none"> ● Check antenna/cable connections. ● Try another channel. (Maybe station trouble or local interference.) ● Adjust Picture menu. 	12
Poor reception of broadcast channels	<ul style="list-style-type: none"> ● Try another channel. ● Check antenna connections. ● If using VCR, check TV/VCR switch on the VCR. 	
No UHF, VHF OK	<ul style="list-style-type: none"> ● Make sure TV/CABLE function is in “TV” mode. 	8
Unable to select a certain channel	<ul style="list-style-type: none"> ● That channel may be locked out with BLOCK CHANNEL function, or erased with the ADD/ERASE function. 	17 9
Black box appears on the screen	<ul style="list-style-type: none"> ● Text may be turned on. 	13
Multiple images (ghosts)	<ul style="list-style-type: none"> ● Try another channel. (Maybe station trouble.) ● Use a highly directional outdoor antenna. 	
Poor color or no color	<ul style="list-style-type: none"> ● Try another channel. (Maybe station trouble or local interference.) ● Adjust TINT and/or COLOR in the Picture menu. ● If you change the direction of the TV while the TV is activated, the picture may suffer from color shading. If so, turn off the TV and allow for about 30 minutes to cool, then turn on the TV again. The picture should improve. 	12
The Remote Control does not operate	<ul style="list-style-type: none"> ● Maybe something was between the Remote and the remote sensor. ● Maybe batteries are dead. Try replacing batteries with new ones. Insert them with the correct polarity. 	6

Limited United States Warranty

Toshiba America Consumer Products, Inc. ("TACP") and Toshiba Hawaii Inc. ("THI") make the following limited warranties. These limited warranties extend to the original consumer purchaser or any person receiving this set as a gift from the original consumer purchaser and to no other purchaser or transferee.

Limited Ninety (90) Day Warranty

TACP and THI warrant this product and its parts against defects in materials or workmanship for a period of ninety (90) days after the date of original retail purchase. During this period, TACP and THI will repair or replace a defective part, at their option, with a new or refurbished part, without charge to you. You must deliver the entire set to an TACP/THI Authorized Service Station. You are responsible for all transportation and insurance changes for the set to and from the Authorized Service Station.

Limited One (1) Year Warranty

TACP / THI further warrant the parts in this product against defects in materials or workmanship for a period of one year after the date of original retail purchase. During this period, TACP/ THI will repair or replace a defective part, at their option, with a new or refurbished part, without charge to you, except that if a defective part is replaced after ninety (90) days from the date of original retail purchase you pay labor charges involved in the replacement. You must also deliver the entire product to a TACP/THI Authorized Service Station. You are responsible for all transportation for the set to and from the Authorized Service Station.

Limited Two (2) Year Warranty of Picture Tube

TACP and THI further warrant the picture tube in this product against defects in materials or workmanship for a period of two (2) years after the date of original retail purchase. During this period, TACP/ THI will replace a defective picture tube, at their option, with a new or refurbished picture tube, without charge to you, except that if a defective picture tube is replaced after ninety (90) days from the date of the original retail purchase, you pay labor charges involved in the replacement. You are responsible for all transportation and insurance charges for the set to and from the Authorized Service Station.

Rental Units

The warranty for rental units begins with the first rental or thirty (30) days from the date of shipment to the rental firm, whichever comes first.

How to Obtain Warranty Service

If after following all of the operating instructions in this manual and checking the section "BEFORE CALLING SERVICE PERSONNEL", you find that service is needed:

- (1) In the U.S.A. call the TACP toll free number **1-800-631-3811** after you find a defective product or part to find the nearest Toshiba Authorized Service Station.
- (2) Arrange for the delivery of the product to the TACP/THI Authorized Service Station. Products shipped to the Authorized Service Station must be insured and safely and securely packed, preferably in the original carton, and a letter explaining the problem must be enclosed. You are responsible for all transportation and insurance charges to and from the Authorized Service Station.

In the Continental United States contact:



In Hawaii contact:
Toshiba Hawaii, Inc.
327 Kamakee Street, Honolulu, Hawaii 96814
(808) 591-8377

®

All warranties implied by state law, including the implied warranties of merchantability and fitness for a particular purpose, are expressly limited to the duration of the limited warranties set forth above. With the exception of any warranties implied by state law as hereby limited, the foregoing warranty is exclusive and in lieu of all other warranties, guarantees, agreements and similar obligations of manufacturer or seller with respect to the repair or replacement of any parts. In no event shall TACP or THI be liable for consequential or incidental damages.

No person, agent, distributor, dealer or company is authorized to change, modify or extend the terms of these warranties in any manner whatsoever. The time within which action must be commenced to enforce any obligation of TACP or THI arising under this warranty or under any statute, or law of the United States or any state thereof, is hereby limited to 90 days from the date you discover or should have discovered, the defect. This limitation does not apply to implied warranties arising under state law.

This warranty gives you specific legal rights and you may also have other rights which may vary from state to state. Some states do not allow limitation on how long an implied warranty lasts, when an action may be brought, or the exclusion or limitation of incidental or consequential damages, so the above provisions may not apply to you.



ATTENTION CANADIAN CONSUMERS:

Canadian consumers are requested to complete the special Canadian "Warranty Registration Form" enclosed, and forward this completed form with a copy of bill of sale to TOSHIBA OF CANADA to "Register and Validate" their warranty. Products must be purchased from an Authorized Canadian Dealer.

Products purchased in the U.S.A. and used in Canada are not covered by these warranties.
Products purchased in Canada and used in the U.S.A. are not covered by these warranties.

Rev. 7-20-98

Specifications

TELEVISION SYSTEM	NTSC standard
CHANNEL COVERAGE	VHF; 2 through 13 UHF; 14 through 69 Cable TV; mid band (A-8 through A-1, A through I) super band (J through W) hyper band (AA through ZZ, AAA, BBB) ultra band (65 through 94, 100 through 125)
POWER SOURCE	120V AC, 60Hz
POWER CONSUMPTION	61 W (average)
AUDIO POWER	1W
SPEAKER TYPE	2 x 3-1/2 inches (50 x 90mm)
DIMENSIONS	Width 20-3/16 inches (512mm) Height 17-13/16 inches (452mm) Depth 18-1/4 inches (463mm)
MASS	38 lbs (23kg)
SUPPLIED ACCESSORIES	Remote Control with 2 size "AA" batteries

Design and specifications are subject to change without notice

TOSHIBA AMERICA CONSUMER PRODUCTS, INC.

HEAD OFFICE/82 TOTOWA ROAD, WAYNE, NEW JERSEY 07470
FACTORY SERVICE CENTER 1420B TOSHIBA DRIVE, LEBANON, TENNESSEE 37087

TOSHIBA HAWAII, INC.

HEAD OFFICE/327 KAMAKEE STREET, HONOLULU, HAWAII 96814, U.S.A.

TOSHIBA OF CANADA LTD.

HEAD OFFICE/191 McNABB STREET, MARKHAM, ONTARIO, L3R 8H2, CANADA TEL: (905) 470-5400
SERVICE CENTERS/TORONTO: 191 McNABB STREET, MARKHAM, ONTARIO, L3R 8H2, CANADA TEL: (905) 470-5400
MONTREAL: 1643, NORTH SERVICE RD., TRANS-CANADA HIGHWAY, DORVAL QUEBEC, H9P 1J1, CANADA
TEL: (514) 856-4100
VANCOUVER: 22171 FRASERWOOD WAY, RICHMOND, B.C. V6W 1J5
TEL: (604) 303-2500

MANUFACTURED BY

TOSHIBA AMERICA CONSUMER PRODUCTS INC.

Printed in USA
(00-03)B

TOSHIBA
23563888

Free Manuals Download Website

<http://myh66.com>

<http://usermanuals.us>

<http://www.somanuals.com>

<http://www.4manuals.cc>

<http://www.manual-lib.com>

<http://www.404manual.com>

<http://www.luxmanual.com>

<http://aubethermostatmanual.com>

Golf course search by state

<http://golfingnear.com>

Email search by domain

<http://emailbydomain.com>

Auto manuals search

<http://auto.somanuals.com>

TV manuals search

<http://tv.somanuals.com>