



# TOSHIBA



Important  
Safeguards

Welcome to  
Toshiba

Connecting  
your TV

Using the  
Remote Control

Setting up  
your TV

Using the TV's  
Features

Appendix

# OWNER'S MANUAL

## Color Television

### FST PURE<sup>®</sup>

COLOR STREAM<sup>®</sup>

CINEMA SERIES **HD**

**BBE**  
DIGITAL

**HDTV**  
MONITOR

#### Owner's Record

The model number and serial number are on the back of your TV. Record these numbers in the spaces below. Refer to these numbers whenever you communicate with your Toshiba dealer about this TV.

Model number:

Serial number:

# 30HFX85

© 2005 TOSHIBA CORPORATION  
All Rights Reserved

## Dear Customer,

Thank you for purchasing this Toshiba TV. This manual will help you use the many exciting features of your new TV. **Before operating the TV, please read this manual completely, and keep it nearby for future reference.**

## Safety Precautions

### WARNING

**TO REDUCE THE RISK OF FIRE OR ELECTRIC SHOCK, DO NOT EXPOSE THIS APPLIANCE TO RAIN OR MOISTURE.**

	<b>WARNING</b> RISK OF ELECTRIC SHOCK DO NOT OPEN	
<b>WARNING: TO REDUCE THE RISK OF ELECTRIC SHOCK, DO NOT REMOVE COVER (OR BACK). NO USER-SERVICEABLE PARTS INSIDE. REFER SERVICING TO QUALIFIED SERVICE PERSONNEL.</b>		

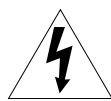

The lightning symbol in the triangle tells you that the voltage inside this product may be strong enough to cause an electric shock. **DO NOT TRY TO SERVICE THIS PRODUCT YOURSELF.**



The exclamation mark in the triangle tells you that important operating and maintenance instructions follow this symbol.

### CAUTION

**TO PREVENT ELECTRIC SHOCK DO NOT USE THIS POLARIZED PLUG WITH AN EXTENSION CORD, RECEPTACLE OR OTHER OUTLET UNLESS THE BLADES CAN BE FULLY INSERTED TO PREVENT BLADE EXPOSURE.**

### NOTE TO CATV INSTALLERS

This is a reminder to call the CATV system installer's attention to Article 820-40 of the NEC, which provides guidelines for proper grounding and, in particular, specifies that the cable ground shall be connected to the grounding system of the building, as close to the point of cable entry as practical. For additional antenna grounding information, see items 25 and 26 on page 4.

### NOTICE OF POSSIBLE ADVERSE EFFECTS ON TV PICTURE DISPLAY

If a fixed (non-moving) pattern or image remains on the TV screen for extended periods of time, the image can become permanently ingrained in the cathode ray tube(s) of the TV and cause subtle but permanent ghost images. This type of damage is **NOT COVERED BY YOUR WARRANTY.** (See item 33 on page 4 for details.)



ENERGY STAR

ENERGY STAR® qualified TV. Products that earn the ENERGY STAR prevent green house gas emissions by meeting strict energy efficiency guidelines set by the U.S. Environmental Protection Agency and the U.S. Department of Energy. ENERGY STAR and the ENERGY STAR mark are registered U.S. marks.



**NEVER CONNECT THIS TV TO A PERSONAL COMPUTER (PC.) This TV is not intended for use with a PC.**

## Child Safety

### It Makes A Difference Where Your TV Stands



**Congratulations on your purchase! As you enjoy your new TV, keep these safety tips in mind:**

### The Issue

- If you are like most consumers, you have a TV in your home. Many homes, in fact, have more than one TV.
- The home theater entertainment experience is a growing trend, and larger TVs are popular purchases; however, they are not always supported on the proper TV stands.
- Sometimes TVs are improperly secured or inappropriately situated on dressers, bookcases, shelves, desks, audio speakers, chests, or carts. As a result, TVs may fall over, causing unnecessary injury.

### Toshiba Cares!

- The consumer electronics industry is committed to making home entertainment enjoyable and safe.
- The Consumer Electronics Association formed the Home Entertainment Support Safety Committee, comprised of TV and consumer electronics furniture manufacturers, to advocate children's safety and educate consumers and their families about television safety.

### Tune Into Safety

- One size does NOT fit all! Use appropriate furniture large enough to support the weight of your TV (and other electronic components).
- Use appropriate angle braces, straps, and anchors to secure your furniture to the wall (but never screw anything directly into the TV).
- Carefully read and understand the other enclosed instructions for proper use of this product.
- Do not allow children to climb on or play with furniture and TVs.
- Avoid placing any item on top of your TV (such as a VCR, remote control, or toy) that a curious child may reach for.
- Remember that children can become excited while watching a program and can potentially push or pull a TV over.
- Share our safety message about this hidden hazard of the home with your family and friends. Thank you!



2500 Wilson Blvd.  
Arlington, VA 22201 U.S.A.  
Tel. 703-907-7600 Fax 703-907-7690  
www.CE.org

*CEA is the Sponsor, Producer and Manager of the International CES®*

0303



## Important Safety Instructions

- 1) Read these instructions.
- 2) Keep these instructions.
- 3) Heed all warnings.
- 4) Follow all instructions.



- 5) Do not use this apparatus near water.

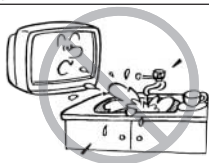

- 6) Clean only with a dry cloth.

- 7) Do not block any ventilation openings. Install in accordance with the manufacturer's instructions.



- 8) Do not install near any heat sources such as radiators, heat registers, stoves, or other apparatus (including amplifiers) that produce heat.

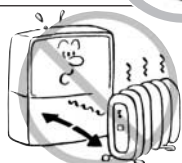

- 9) Do not defeat the safety purpose of the polarized or grounding type plug. A polarized plug has two blades with one wider than the other. A grounding type plug has two blades and a third grounding prong. The wide blade or the third prong are provided for your safety. If the provided plug does not fit into your outlet, consult an electrician for replacement of the obsolete outlet.

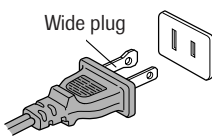

- 10) Protect the power cord from being walked on or pinched, particularly at plugs, convenience receptacles, and the point where it exits the apparatus.

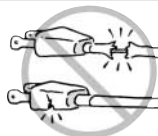

- 11) Only use attachments/accessories specified by the manufacturer.

- 12) Use only with the cart, stand, tripod, bracket, or table specified by the manufacturer, or sold with the apparatus. When a cart is used, use caution when moving the cart/apparatus combination to avoid injury from tip-over.



- 13) Unplug this apparatus during lightning storms or when unused for long periods of time.



- 14) Refer all servicing to qualified service personnel.

Servicing is required when the apparatus has been damaged in any way, such as power supply cord or plug is damaged, liquid has been spilled or objects have fallen into the apparatus, the apparatus has been exposed to rain or moisture, does not operate normally, or has been dropped.



- 15) **CAUTION:** To reduce the risk of electric shock, do not use the polarized plug with an extension cord, receptacle, or other outlet unless the blades can be inserted completely to prevent blade exposure.



## Installation, Care, and Service

### Installation

Follow these recommendations and precautions and heed all warnings when installing your TV:

- 16) Never modify this equipment. Changes or modifications may void: a) the warranty, and b) the user's authority to operate this equipment under the rules of the Federal Communications Commission.

- 17) **DANGER: RISK OF SERIOUS PERSONAL INJURY, DEATH, OR EQUIPMENT DAMAGE!** Never place the TV on an unstable cart, stand, or table. The TV may fall, causing serious personal injury, death, or serious damage to the TV.



- 18) Never place or store the TV in direct sunlight; hot, humid areas; areas subject to excessive dust or vibration; or locations with temperatures at or below 41°F (5°C).



- 19) Always place the TV on the floor or a sturdy, level, stable surface that can support the weight of the unit.



- 20) Never place items such as vases, aquariums, or candles on top of the TV.



- 21) Never block or cover the slots or openings in the TV cabinet back, bottom, and sides. Never place the TV:
  - on a bed, sofa, rug, or similar surface;
  - too close to drapes, curtains, or walls; or
  - in a confined space such as a bookcase, built-in cabinet, or any other place with poor ventilation.



The slots and openings are provided to protect the TV from overheating and to help maintain reliable operation of the TV.



- 22) Never allow anything to rest on or roll over the power cord, and never place the TV where the power cord is subject to wear or abuse.

- 23) Never overload wall outlets and extension cords.



Important Safeguards

Welcome to Toshiba

Connecting your TV

Using the Remote Control

Setting up your TV

Using the TV's Features

Appendix

0303

3

24) Always operate this equipment from a 120 V AC, 60 Hz power source only.

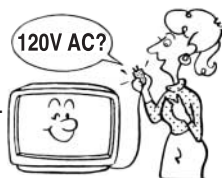

25) Always make sure the antenna system is properly grounded to provide adequate protection against voltage surges and built-up static charges (see Section 810 of the National Electric Code).

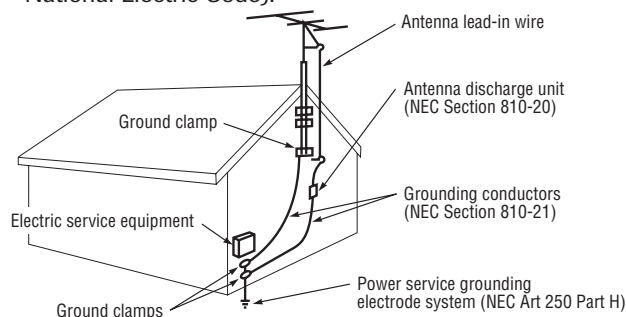

26) **! DANGER: RISK OF SERIOUS PERSONAL INJURY OR DEATH!**

- Use extreme care to make sure you are never in a position where your body (or any item you are in contact with, such as a ladder or screwdriver) can accidentally touch overhead power lines. Never locate the antenna near overhead power lines or other electrical circuits.
- Never attempt to install any of the following during lightning activity:
  - a) an antenna system; or b) cables, wires, or any home theater component connected to an antenna or phone system.

## Care

For better performance and safer operation of your TOSHIBA TV, follow these recommendations and precautions:

27) Always sit approximately 10–25 feet away from the TV and as directly in front of it as possible. The picture can appear dull if you sit too far to the left or right of the TV, or if sunlight or room lights reflect on the screen. Turn the TV off to check for reflections on the screen, and then remove the source of reflections while viewing the TV.

28) Always unplug the TV before cleaning. Never use liquid or aerosol cleaners.

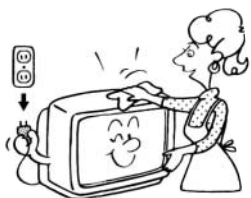

29) **! WARNING: RISK OF ELECTRIC SHOCK!** Never spill liquids or push objects of any kind into the TV cabinet slots.

30) [This item applies to projection TVs only.] If the air temperature rises suddenly (for example, when the TV is first delivered), condensation may form on the lenses. This can make the picture appear distorted or the color appear faded. If this happens, turn off the TV for 6 to 7 hours to allow the condensation to evaporate.

31) For added protection of your TV from lightning and power surges, always unplug the power cord and disconnect the antenna from the TV if you leave the TV unattended or unused for long periods of time.

32) During normal use, the TV may make occasional snapping or popping sounds. This is normal, especially when the unit is being turned on or off. If these sounds become frequent or continuous, unplug the power cord and contact a Toshiba Authorized Service Center.

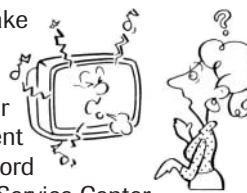

33) **Possible Adverse Effects on TV Picture Display:** If a fixed (non-moving) pattern or image remains on the TV screen for extended periods of time, the image can become permanently ingrained in the cathode ray tube(s) of the TV and cause subtle but permanent ghost images. **This type of damage is NOT COVERED BY YOUR WARRANTY.** Never leave the TV on for extended periods of time while it is displaying the following images or formats:

- **Fixed Images**, including but not limited to PIP/POP windows, closed captions, video game patterns, TV station logos, stock tickers, and websites.
- **Special Formats** that do not use the entire screen, including but not limited to widescreen or letterbox format media viewed on a 4:3 aspect ratio display (with gray or black bars at the top and bottom of the screen); or 4:3 aspect ratio format media viewed on a widescreen/16:9 aspect ratio display (with gray or black bars on the left and right sides of the screen).

## Service

34) **! WARNING: RISK OF ELECTRIC SHOCK!** Never attempt to service the TV yourself. Opening and removing the covers may expose you to dangerous voltage or other hazards. Refer all servicing to a Toshiba Authorized Service Center.

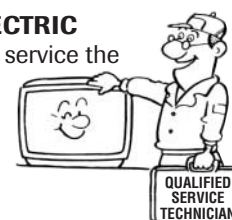

35) If you have the TV serviced:

- Ask the service technician to use only replacement parts specified by the manufacturer.
- Upon completion of service, ask the service technician to perform routine safety checks to determine that the TV is in safe operating condition.



36) When the TV reaches the end of its useful life, ask a qualified service technician to properly dispose of the TV. Improper disposal may result in a picture tube implosion and possible personal injury.

0303



<b>Important Safety Information .....</b>	<b>2-4</b>
<b>Welcome to Toshiba .....</b>	<b>6</b>
Exploring your new TV .....	6
Selecting a location for the TV .....	6
<b>Connecting your TV .....</b>	<b>7</b>
Connecting a VCR .....	7
Connecting a cable converter box or Antenna .....	8
Connecting a DVD player/satellite receiver and a VCR .....	9
Connecting a DVD player with ColorStream® (component video) and a VCR .....	10
Connecting a DTV receiver / set-top box with ColorStream® (component video) and a VCR .....	11
Connecting two VCRs .....	12
Connecting a camcorder .....	13
Connecting an HDMI™ or a DVI device to the HDMI input .....	14
Connecting an audio system .....	15
<b>Using the remote control .....</b>	<b>16</b>
Preparing the remote control for use .....	16
Installing the remote control batteries .....	16
Remote control functional key chart .....	17
Programming the remote control for use with your audio/video devices .....	19
Device code setup .....	19
Searching and sampling the code of a device (8500) .....	19
Using the volume lock feature (8000) .....	20
Operational feature reset (8900) .....	20
Device code table .....	21
Learning about the remote control .....	23
<b>Setting up your TV .....</b>	<b>24</b>
Starting setup .....	24
Changing the on-screen display language .....	24
Image tilt correction .....	25
Adding channels to the TV's memory .....	25
<b>Using the TV's features .....</b>	<b>26</b>
Adjusting the channel settings .....	26
Using the LOCKS menu .....	27
Selecting a password .....	27
Using the V-Chip (parental control) feature .....	28
Locking channels .....	29
Locking the video inputs .....	30
Setting the GameTimer™ .....	30
Using the front panel lock feature .....	31
Labeling channels .....	31
Selecting the video input source .....	32
Labeling the video input sources .....	32
Setting the clock .....	33
Setting the ON/OFF timer .....	33
Viewing the wide-screen picture formats (480i and 480p signals only) .....	34
Scrolling the TheaterWide® picture (TheaterWide 2 and 3 only) .....	36
Selecting the cinema mode .....	37
Using the ASPECT feature .....	37
Selecting the display format (for 480p signals only) .....	37
Adjusting the picture .....	38
Selecting the picture mode .....	38
Adjusting the picture quality .....	38
Selecting the color temperature .....	39
Using the CableClear® feature .....	39
Selecting the Scan Velocity Modulation (SVM) .....	39
Resetting your picture adjustments .....	40
Setting the sleep timer .....	40
Using the closed caption feature .....	40
Adjusting the sound .....	41
Muting the sound .....	41
Selecting stereo/SAP broadcasts .....	41
Adjusting the sound quality .....	41
Resetting your audio adjustments .....	42
Using the StableSound® feature .....	42
Using the BBE sound feature .....	42
Turning off the built-in speakers .....	43
Selecting the HDMI audio input source .....	43
Displaying TV status information on-screen .....	43
Auto power off .....	44
Understanding the Power Return feature .....	44
<b>Appendix .....</b>	<b>44</b>
Troubleshooting .....	44
Specifications .....	45
Limited Warranty .....	46

Important  
Safeguards

Welcome to  
Toshiba

Connecting  
your TV

Using the  
Remote Control

Setting up  
your TV

Using the TV's  
Features

Appendix



Welcome to Toshiba

## Welcome to Toshiba

Congratulations! You have purchased one of the finest color TVs on the market. The goal of this manual is to guide you through setting up and operating your Toshiba TV as quickly as possible.

You may need to purchase other audio or video cables to connect your equipment. See "Connecting your TV" on page 7 for more information.

Please read all the safety and operating instructions carefully before you begin.

The STARTING SETUP feature appears the first time you turn on the TV. See page 24 for details.

## Exploring your new TV

You can operate your TV by using the buttons on the front panel or the remote control. The front and back panels provide all the inputs you will need to connect other equipment to your TV.

### TV front panel

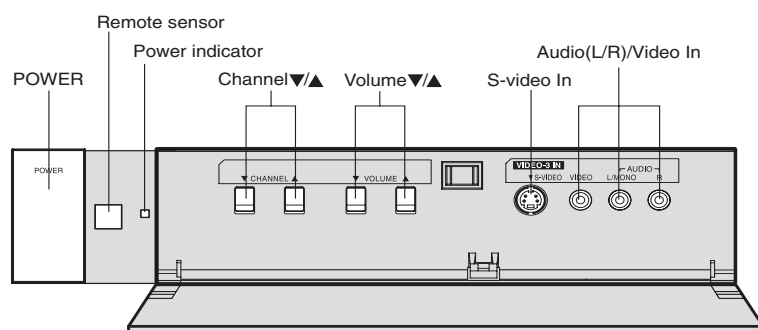

### TV back panel

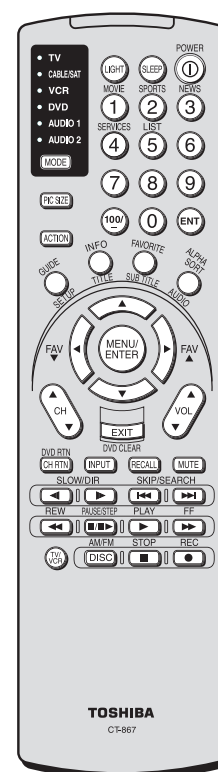
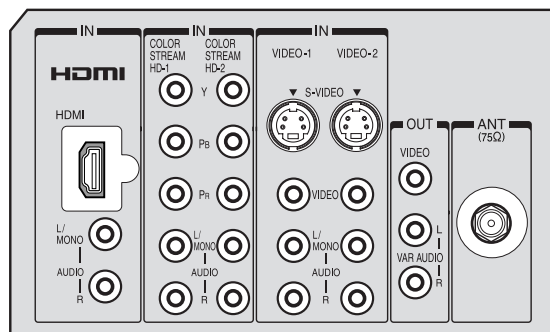

## Selecting a location for the TV

- Place the TV on the floor or on a sturdy platform in a location where light does not directly hit the screen.
- Place the TV far enough from the walls to allow proper ventilation. Inadequate ventilation may cause overheating, which may damage the TV.



## Connecting your TV

- A coaxial cable is the standard cable that comes in from your antenna or cable converter box. Coaxial cables use “F” connectors.
- Standard A/V (audio/video) cables are usually color coded according to use: yellow for video and red and white for audio. The red audio cable is for the stereo right channel, and the white audio cable is for the stereo left (or mono) channel. If you look at the rear panel of the TV, you will see that the terminals are color coded in the same manner as the cables.
- S-video cables provide better picture performance than standard video cables. S-video cables can only be used with S-video compatible components.
- Component video cables provide better picture performance than S-video cables. Component video cables can only be used with component video compatible components.
- HDMI (High Definition Multimedia Interface) cable is for use with video equipment that has HDMI output (see page 14).

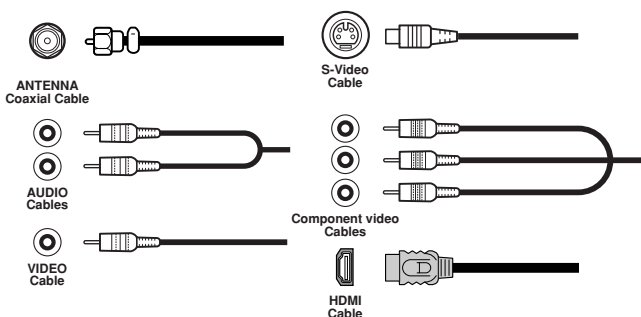

**NEVER CONNECT THIS TV TO A PERSONAL COMPUTER (PC). This TV is not intended for use with a PC.**



### NOTICE: RISK OF EQUIPMENT DAMAGE!

*Do not plug in any power cords until you have finished connecting all equipment.*

Important Safeguards

Welcome to Toshiba

Connecting your TV

Using the Remote Control

Setting up your TV

Using the TV's Features

Appendix

## Connecting a VCR

This connection allows you to watch local channels and video programs, play or record on the VCR while watching TV, and record from one channel while watching another channel.

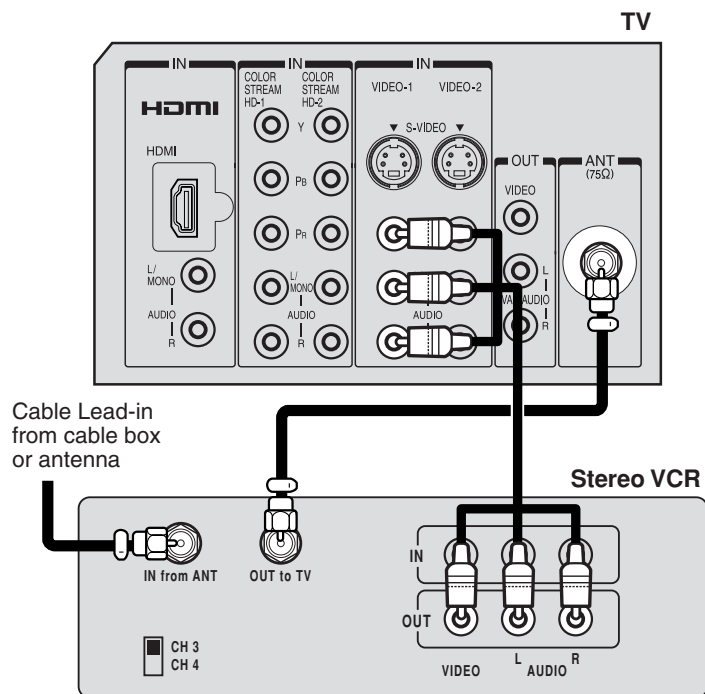

7

You will need:

- two coaxial cables
- one set of standard A/V cables

### Note:

*If using a mono VCR, connect L/Mono to VCR Audio OUT using only one audio cable. For better picture quality, if your VCR has S-video, you can use an S-video cable instead of the standard video cable.*

*Do not connect a standard video cable and an S-video cable to VIDEO-1 (or VIDEO-2) simultaneously.*

The unauthorized recording, use, distribution or revision of television programs, videotapes, DVDs, and other materials is prohibited under the Copyright Laws of the United States and other countries, and may subject you to civil and criminal liability.



## Connecting a cable converter box or Antenna

This television has an extended tuning range and can tune most cable channels without using a cable company supplied converter box. Some cable companies offer “premium pay channels” in which the signal is scrambled. Descrambling these signals for normal viewing requires the use of a descrambler device, which is generally provided by the cable company.

### Option 1 : For Subscribers to Basic Cable TV Service

For basic cable service not requiring a Converter/Descrambler box, connect the incoming 75 ohm Coaxial Cable directly to the Antenna Jack on the back of the television.

### Option 2 : For Subscribers to Scrambled Cable TV Service

If you subscribe to a cable service that requires the use of a Converter/Descrambler box, connect the incoming cable to the Converter/Descrambler box and connect the output of the box to the Antenna Jack on the back of the television. Follow the connections shown below. Set the television to the output of the Converter/Descrambler box (usually channel 3 or 4) and use the Converter/Descrambler box to select channels.

### Option 3 : For Subscribers to Unscrambled Basic Cable with Scrambled Premium Channels

If you subscribe to a cable service in which basic cable channels are unscrambled and premium channels require the use of a Converter/Descrambler box, you may wish to use a two-set signal splitter (sometimes called a “two-set coupler”) and an A/B Switch box from the cable installer or an electronics supply store. Follow the connections shown below. With the switch in the “B” position, you can directly tune any nonscrambled channels on your TV. With the switch in the “A” position, tune your TV to the output of the Converter/Descrambler box (usually channel 3 or 4) and use the box to tune scrambled channels.

#### Note:

When you use a converter box with your TV, there may be features that you cannot program using the remote control, such as labeling channels, blocking channels, and programming your favorite channels.

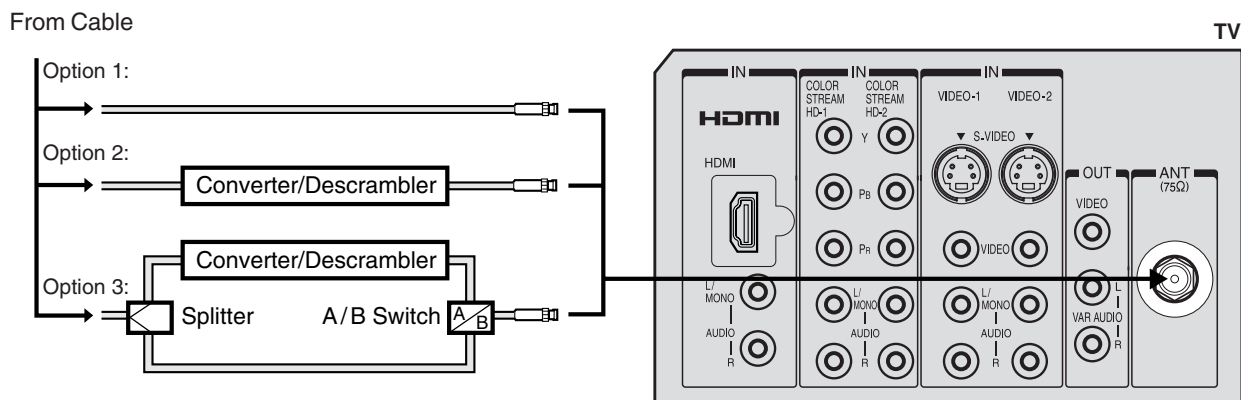





## Connecting a DVD player/satellite receiver and a VCR

This connection allows you to watch DVD/satellite, VCR, or TV programs. You can record from the satellite receiver and TV, as well as record one TV channel while watching another channel.

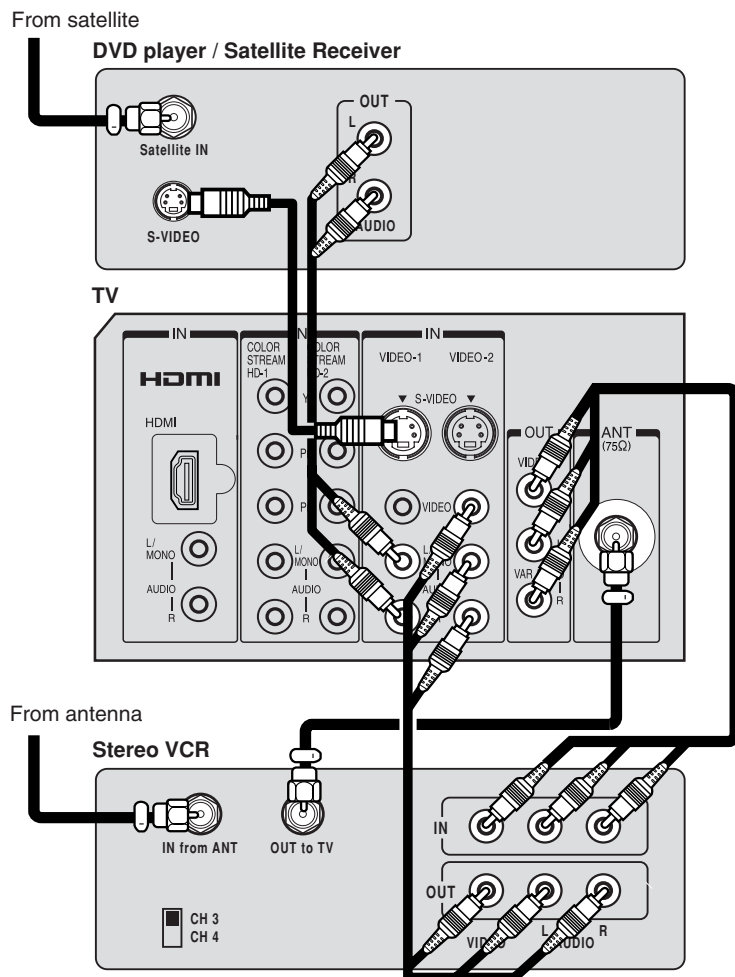

You will need:

- three coaxial cables
- two sets of standard A/V cables
- one S-video cable
- one pair of standard audio cables

### Note:

*You can use a standard video cable instead of the S-video cable, but the picture quality will decrease. If you use an S-video cable between the TV and DVD player/satellite receiver, make the audio connections but remove the standard video cable. Do not connect both an S-video and a standard video cable to VIDEO1 (or VIDEO2) at the same time or the picture performance will be unacceptable.*

The unauthorized recording, use, distribution or revision of television programs, videotapes, DVDs, and other materials is prohibited under the Copyright Laws of the United States and other countries, and may subject you to civil and criminal liability.

Important Safeguards

Welcome to Toshiba

Connecting your TV

Using the Remote Control

Setting up your TV

Using the TV's Features

Appendix



## Connecting a DVD player with ColorStream® (component video) and a VCR

This connection allows you to watch DVD, VCR, or TV programs and record TV programs. You can record from one source while watching a program from another source. Your TV is capable of using ColorStream (component video.) Connecting your TV to a component video compatible DVD player, such as a Toshiba DVD player with ColorStream®, can greatly enhance picture quality and performance.

Connecting your TV

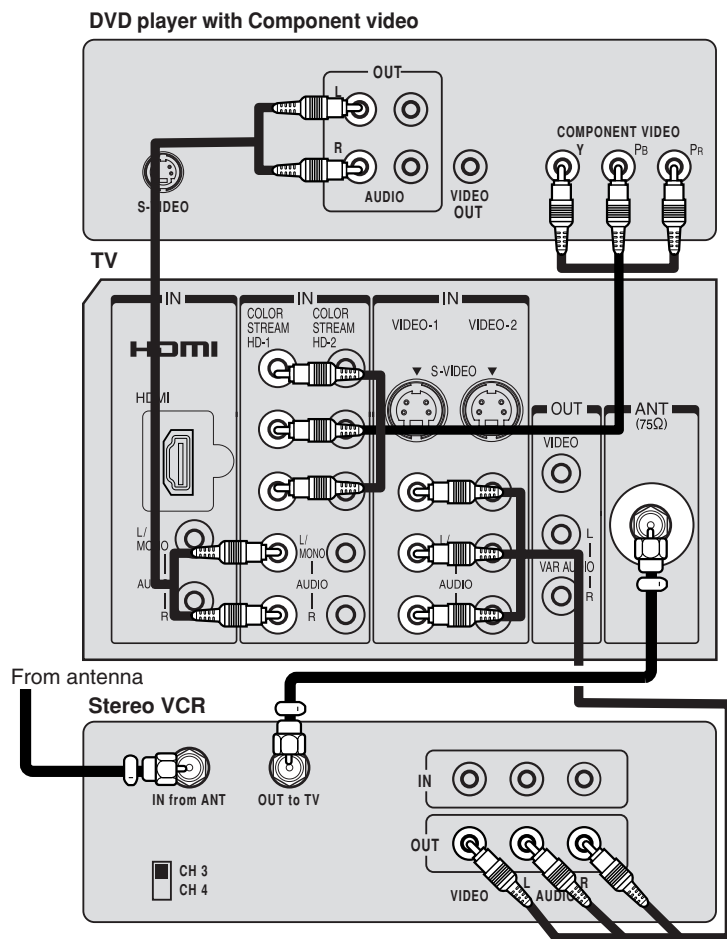

You will need:

- two coaxial cables
- one set of standard A/V cables
- one set of component video cables
- one pair of standard audio cables

### Note:

You can connect the component video cables to either set of ColorStream jacks on the TV (HD-1 or HD-2).

The ColorStream HD-1 and HD-2 jacks can be used with Progressive (480p, 720p) and Interlaced (480i, 1080i) scan systems.

A 1080i signal will provide the best picture performance.

The unauthorized recording, use, distribution or revision of television programs, videotapes, DVDs, and other materials is prohibited under the Copyright Laws of the United States and other countries, and may subject you to civil and criminal liability.



## Connecting a DTV receiver / set-top box with ColorStream® (component video) and a VCR

This connection allows you to watch DTV (digital TV), VCR, and TV programs, and record DTV and TV programs. Your TV has ColorStream® (component video) inputs. Connecting your TV to a DTV receiver with component video can greatly enhance picture quality and realism.

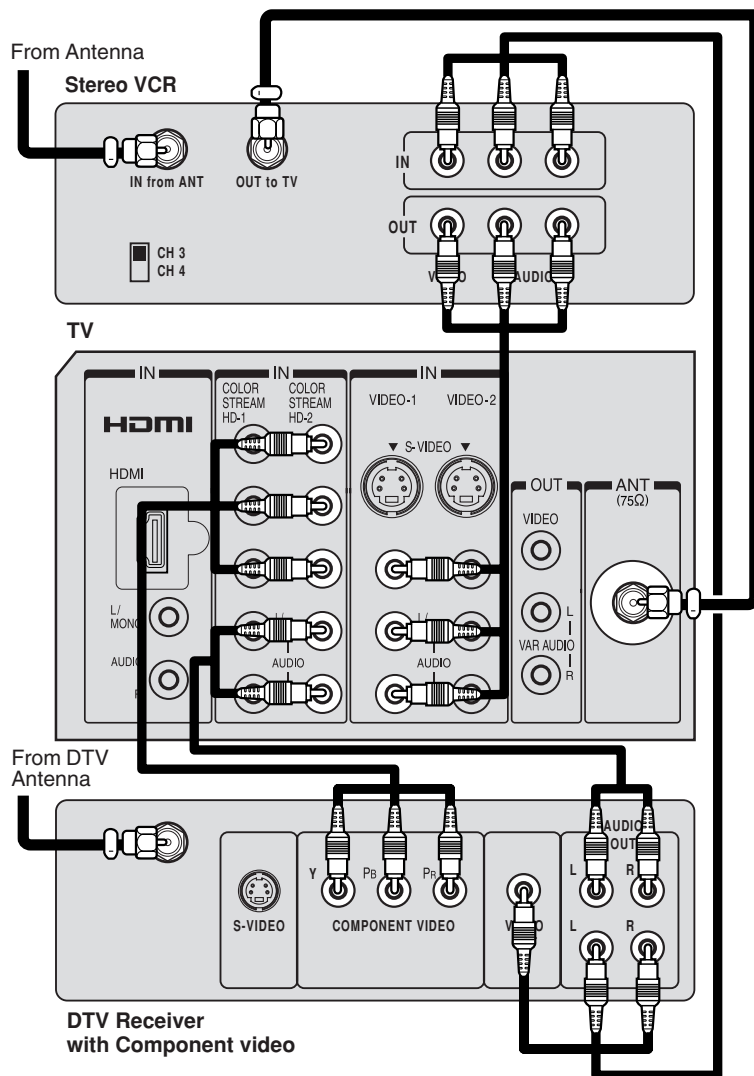

You will need:

- three coaxial cables
- two sets of standard A/V cables
- one set of standard audio cables
- one set of component video cables

### Note:

You can connect the component video cables to either set of ColorStream jacks on the TV (HD-1 or HD-2.) For HDMI connection see page 14.

The ColorStream HD-1 and HD-2 jacks and HDMI jacks can be used with Progressive (480p, 720p) and Interlaced (480i, 1080i) scan systems. A 1080i signal will provide the best picture performance.

If your DTV receiver does not have component video, use the S-video and standard audio connections instead. Do not connect both an S-video and a standard video cable to VIDEO1 (or VIDEO2) at the same time or the picture performance will be unacceptable.

The unauthorized recording, use, distribution, or revision of television programs, videotapes, DVDs, and other materials is prohibited under the Copyright Laws of the United States and other countries, and may subject you to civil and criminal liability.

Important Safeguards

Welcome to Toshiba

Connecting your TV

Using the Remote Control

Setting up your TV

Using the TV's Features

Appendix



## Connecting two VCRs

This connection allows you to record (dub/edit) from one VCR to another VCR.

You will also be able to record from one TV channel while watching another channel.

You will need:

- two coaxial cables
- two sets of standard A/V cables

### Note:

Do not connect the same VCR to the output and input jacks on the TV at the same time. For better picture quality, if your VCR has S-video, you can use an S-video cable instead of the standard video cable. Do not connect a standard video cable and an S-video cable to VIDEO-1 (or VIDEO-2) simultaneously.

Connecting your TV

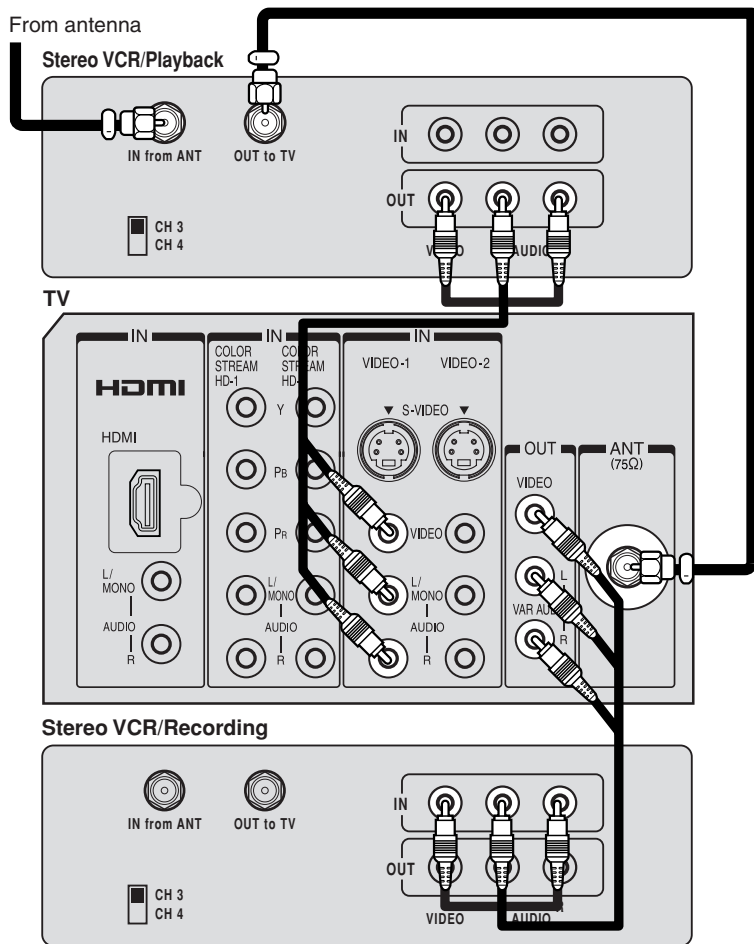

The unauthorized recording, use, distribution or revision of television programs, videotapes, DVDs, and other materials is prohibited under the Copyright Laws of the United States and other countries, and may subject you to civil and criminal liability.



## Connecting a camcorder

This connection allows you to watch videos recorded on a camcorder.

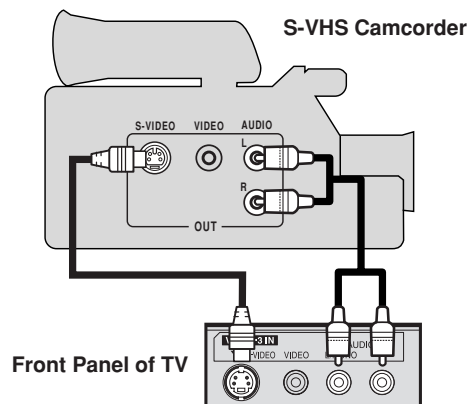

You will need:

- one S-video cable
- one pair of standard audio cables

### Note:

For better picture quality, if your camcorder has S-video, you can use an S-video cable (plus the standard audio cables) instead of a standard video cable.

Do not connect both a standard video cable and an S-video cable at the same time, or the picture performance will be unacceptable.

Important Safeguards

Welcome to Toshiba

Connecting your TV

Using the Remote Control

Setting up your TV

Using the TV's Features

Appendix



Connecting your TV

## Connecting an HDMI™ or a DVI device to the HDMI input

The HDMI<sup>[1]</sup> input on your TV receives digital audio and uncompressed digital video from an HDMI device or uncompressed digital video from a DVI<sup>[2]</sup> device.

This input is designed to accept HDCP<sup>[3]</sup> program material in digital form from EIA/CEA-861/861B-compliant<sup>[4]</sup> consumer electronic devices (such as a set-top box or DVD player with HDMI or DVI output).

The HDMI input is designed for best performance with high definition video signals. It will accept and display 480i, 480p, 720p and 1080i signals.



**NEVER CONNECT THIS TV TO A PERSONAL COMPUTER (PC). This TV is not intended for use with a PC.**

### To connect an HDMI device, you will need:

- one HDMI cable (type A connector)

For proper operation, it is recommended that you use as short an HDMI cable as possible. You should not encounter difficulty if you use an HDMI cable that is shorter than 16.4 ft (5m).

HDMI cable transfers both video and audio. Separate analog audio cables are not required (see illustration below).

**You must set the HDMI audio input setting to "HDMI" in the AUDIO menu (see page 43).**

Some CDVs (Video CDs) may not output digital audio signals. In that case, you may hear sound by connecting analog audio cables. If you do use analog audio cables for this reason, you will need to set the HDMI audio input setting to "DVI" to hear the analog audio (see page 43).

**Note:** If you connect an HDMI device and analog audio cables and play media with digital audio output, to hear digital audio you must set the HDMI audio input setting to "HDMI" (page 43).

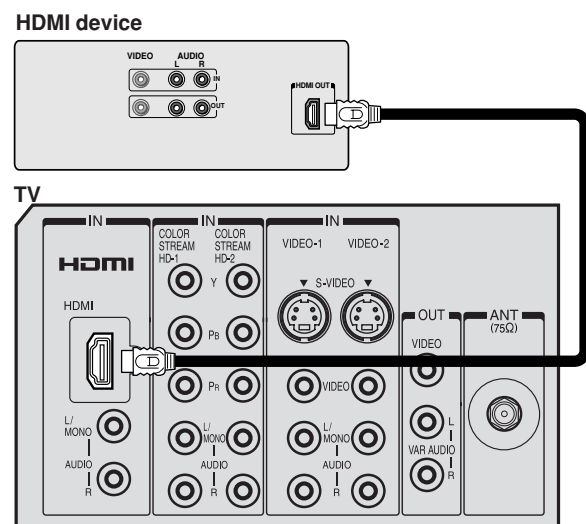

HDMI, the HDMI logo, and High-Definition Multimedia Interface are trademarks or registered trademarks of HDMI Licensing, LLC.

[1] HDMI = High-Definition Multimedia Interface.

[2] DVI = Digital Video Interface.

[3] HDCP = High-bandwidth Digital Content Protection.

[4] EIA/CEA-861/861B compliance covers the transmission of uncompressed digital video with high-bandwidth digital content protection, which is being standardized for reception of high-definition video signals. **Because this is an evolving technology, it is possible that some devices may not operate properly with the TV.**

To ensure that the HDMI or DVI device is reset properly, it is recommended that you follow these procedures:

- When turning on your electronic components, **turn on the TV first**, and then the HDMI or DVI device.
- When turning off your electronic components, **turn off the HDMI or DVI device first**, and then the TV.

### To connect a DVI device, you will need:

- one HDMI-to-DVI adapter cable (HDMI type A connector)

For proper operation, the length of an HDMI-to-DVI adapter cable should not exceed 9.8 ft (3m). The recommended length is 6.6 ft (2m).

- one pair of standard analog audio cables

An HDMI-to-DVI adapter cable transfers only video. Separate analog audio cables are required (see illustration below.)

**You must set the HDMI audio input setting to "DVI" in the AUDIO menu (see page 43).**

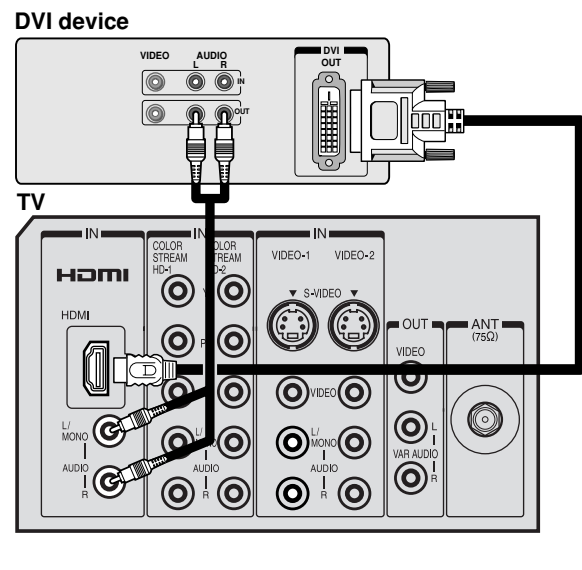



## Connecting an audio system

This connection allows you to use an audio amplifier and external speakers, and adjust the audio level using the TV's remote control. To control the audio, turn on the TV and the stereo amplifier, and turn off the TV's built-in speakers (see "Turning off the built-in speakers" on page 43).

### Note:

To hear sound when using an external audio amplifier, the volume of both the TV and the amplifier must be set above 0 (zero.) For example, if the volume of the TV is set to 0, you will not be able to hear any sound, even the volume of the amplifier is at its highest level.

You will need:

- one pair of standard audio cables

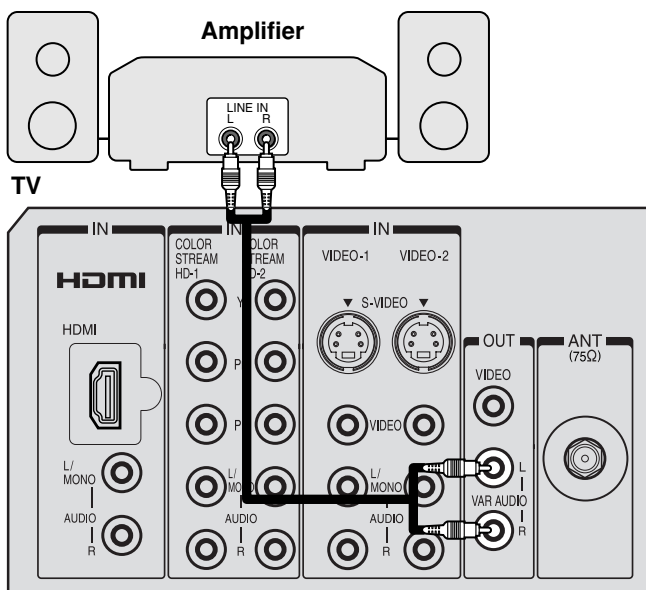

Important Safeguards

Welcome to Toshiba

Connecting your TV

Using the Remote Control

Setting up your TV

Using the TV's Features

Appendix



## Using the remote control

### Preparing the remote control for use

Your Toshiba TV remote control has one dedicated TV mode and five universal modes: VCR, Cable/SAT, DVD, Audio1, and Audio2. The target devices and default devices being programmed for each mode are as follows:

Target device/Mode mapping

Mode	Device
TV	Toshiba TV
CABLE/SAT	Universal Cable, Satellite
VCR	Universal VCR, DVD, LD, Cassette
DVD	Universal DVD, VCR, LD, Cassette
AUDIO1	Universal Audio: Amp., Tuner, Misc.Audio, CD/MD
AUDIO2	Universal Audio: CD/MD, Amp., Tuner, Misc.Audio

Default device codes

Mode	Default device
TV	Toshiba TV
CABLE/SAT	Toshiba Satellite receiver
VCR	Toshiba VCR
DVD	Toshiba DVD
AUDIO1	Pioneer Audio receiver
AUDIO2	Pioneer LD

Using the Remote Control

Repeatedly press MODE to cycle among the modes. If you own different brands of audio/video devices, you must first program your remote control for use with your audio/video devices" on page 19).

### Installing the remote control batteries

To install the batteries:

1. Slide the battery cover off the back of the remote control.

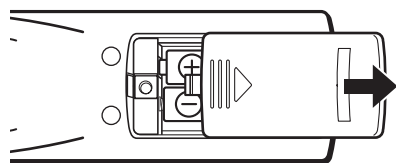

2. Install two "AA" size alkaline batteries. Match the + and - signs on the batteries to the signs on the battery compartment.

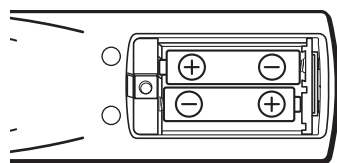

3. Slide the battery cover back on to the remote control until the lock snaps.

#### Note:

Your TV's remote control may not operate certain features on your VCR, cable TV converter, or other electronic device.

Refer to the owner's manuals for your other devices to determine their available features. If your TV's remote control does not operate a specific feature on a device, use the remote control that came with the device.

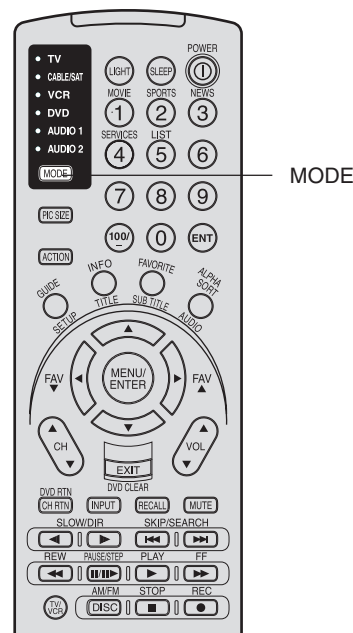

#### Caution:

- Never throw batteries into a fire.

#### Notes:

- Be sure to use AA size batteries.
- Dispose of batteries in a designated disposal area.
- Batteries should always be disposed of with the environment in mind. Always dispose of batteries in accordance with applicable laws and regulations.
- If the remote control does not operate correctly, or if the operating range becomes reduced, replace batteries with new ones.
- When necessary to replace batteries in the remote control, always replace both batteries with new ones. Never mix battery types or use new and used batteries in combination.
- Always remove batteries from remote control if they are dead or if the remote control is not to be used for an extended period of time. This will prevent battery acid from leaking into the battery compartment.





## Remote control functional key chart

Key Label	Toshiba TV (TV)	Cable (CBL/SAT)	Satellite (CBL/SAT)	VCR	DVD/LD	Receiver (AUDIO)	CD/MD (AUDIO)	Cassette (VCR)
LIGHT	Lights the remote key, and toggles between enabled and disabled Illumination mode.							
SLEEP	Sleep timer	---	---	---	---	---	---	---
POWER	Power	Power	Power	Power	Power	Power	Power	Power
1/MOVIE	Digit 1	Digit 1	Digit 1	Digit 1	Digit 1	AV input 1	Digit 1	Digit 1
2/SPORTS	Digit 2	Digit 2	Digit 2	Digit 2	Digit 2	AV input 2	Digit 2	Digit 2
3/NEWS	Digit 3	Digit 3	Digit 3	Digit 3	Digit 3	AV input 3	Digit 3	Digit 3
4/SERVICES	Digit 4	Digit 4	Digit 4	Digit 4	Digit 4	AV input 4	Digit 4	Digit 4
5/LIST	Digit 5	Digit 5	Digit 5	Digit 5	Digit 5	CD	Digit 5	Digit 5
6	Digit 6	Digit 6	Digit 6	Digit 6	Digit 6	Tuner	Digit 6	Digit 6
MODE	Remote control device mode selection							
PIC SIZE	Selects the image shape.	← TV	← TV	← TV	← TV	← TV	← TV	← TV
7	Digit 7	Digit 7	Digit 7	Digit 7	Digit 7	Phono	Digit 7	Digit 7
8	Digit 8	Digit 8	Digit 8	Digit 8	Digit 8	Cassette	Digit 8	Digit 8
9	Digit 9	Digit 9	Digit 9	Digit 9	Digit 9	Aux	Digit 9	Digit 9
ACTION	---	---	Action, Menu	---	Menu	---	---	---
100/-	100	---	100	100	100	100	100	100
0	Digit 0	Digit 0	Digit 0	Digit 0	Digit 0	Digit 0	Digit 0	Digit 0
ENT	---	CH Enter	CH Enter	CH Enter	---	---	---	---
GUIDE/SETUP	---	---	Guide	---	DVD setup	---	---	---
INFO/TITLE	---	---	INFO	---	TITLE= Top menu	---	---	---
FAVORITE/ SUBTITLE	Favorite CH	---	Favorite CH	---	Subtitle	---	---	---
ALPHASORT/ AUDIO	---	---	Alphasort	---	Audio	---	---	---
MENU ENTER	Menu open/ Enter	---	Select	---	Enter	---	---	---
▲▼	Menu select	---	Menu select	---	Menu select	---	---	---
◀▶/(FAV▲▼)	Menu select/ FAV▲▼	---	Menu select	---	Menu select	---	---	---
VOL ▲▼	Volume up/down*	Volume up/down*	Volume up/down*	Volume up/down*	Volume up/down*	Volume up/down*	Volume up/down*	---
EXIT/ DVD CLEAR	Exit	Exit	Exit	Exit	DVD clear	Exit/ Clear	Exit/ Clear	Exit/ Clear
CH ▲▼	Channel up/down	Channel up/down	Channel up/down	Channel up/down	---	Channel up/down	---	---
INPUT	TV/Video select	← TV	← TV	VCR input	← TV	Input	← TV	← TV
MUTE	Sound mute*	Sound mute*	Sound mute*	Sound mute*	Sound mute*	Sound mute*	Sound mute*	---
RECALL	On-screen display	---	On-screen display	On-screen display	On-screen display	---	---	---
CH RTN/ DVD RTN	Previous channel	Previous channel	Previous channel	Previous channel	DVD return	---	---	---
SLOW/ DIR ▶▶	---	---	---	Forward	Forward Reverse	---	---	---
SKIP/ SEARCH ▶▶	---	---	---	---	Forward Reverse	---	Forward Reverse	Forward Reverse
REW	VCR →	VCR →	VCR →	Rewind	Rewind	Rewind	Rewind	Rewind
PAUSE/STEP	VCR →	VCR →	VCR →	Pause	Pause	Pause	Pause	Pause
PLAY	VCR →	VCR →	VCR →	Play	Play	Play	Play	Play
FF	VCR →	VCR →	VCR →	F.Forward	F.Forward	F.Forward	F.Forward	F.Forward

Important Safeguards

Welcome to Toshiba

Connecting your TV

Using the Remote Control

Setting up your TV

Using the TV's Features

Appendix



Key Label	Toshiba TV (TV)	Cable (CBL/SAT)	Satellite (CBL/SAT)	VCR	DVD/LD	Receiver (AUDIO)	CD/MD (AUDIO)	Cassette (VCR)
TV/VCR	VCR →	---	TV/SAT	TV/VCR	---	---	---	Reverse
AM/FM DISC	---	---	---	---	Disc shift	AM/FM	Disc shift	Deck side A/B switch
STOP	VCR →	VCR →	VCR →	Stop	Stop	Stop	Stop	Stop
REC**	VCR →	VCR →	VCR →	Record	---	Record	Record	Record

**Notes:**

- “---” will send nothing.
- “ ← TV” will jump to TV.
- “ → VCR” will jump to last active VCR or DVD. Active VCR/DVD is defined as the mode that remains for a minimum of 5 seconds, or if a key is pressed in that mode.
- \* The VOLUME and MUTE will jump to “TV” by default. When the volume is unlocked, all the devices will have their own volume. The AUDIO1/2 (Receiver, CD) modes will have their own volume even if Volume Lock is on TV, CABLE/SAT, VCR, or DVD. See “Using the volume lock feature” on page 20.
- \*\* Press the REC button twice within 5 seconds to record each audio/video source.

Using the Remote Control



## Programming the remote control for use with your audio/video devices

### Device code setup

1. Refer to the Device code table on pages 21–22 to find the code for your device.  
If more than one number is listed, try each one separately until you find one that works.
2. Press MODE until the Mode indicator for the device (CABLE/SAT, VCR, DVD, AUDIO1, AUDIO2) lights up.
3. While holding down the RECALL button, press the Channel Number buttons to enter the four-digit code of your blank of device.  
If a valid code is entered, the mode indicator will blink twice.  
If an invalid code is entered, the mode indicator will blink one long blink.
4. Point the remote control at the device and press POWER to test the code.  
If the device turns on, you have entered the correct code.  
If the device does not respond to the remote control, you may have entered the wrong code. Repeat steps 3 and 4 using another code.
5. Press MODE to select the TV mode to control the TV.

### Searching and sampling the code of a device (8500)

If you do not know the device code for a particular target unit, you can cycle the remote control through the available codes for that device mode and sample the functions to find the code that properly operates the target device. The keys available to be sampled, provided they are applicable to that mode, are 0, 1, 2, 3, POWER, VOL ▲, CH ▲, PLAY and STOP. Invalid keys will be ignored while in program mode.

To cycle through each available device code and sample its functions:

1. Press MODE to select the mode you want to set up.
2. While holding down the RECALL button, press 8 –5 –0 –0.  
The remote control will enter program mode.
3. Point the remote control at the target device and press POWER (or other function buttons that are available to be sampled).
4. If the device responds to the remote control:  
Press RECALL to store the device code.  
The mode indicator will blink twice and the remote control will exit the program mode.  
If the device does not respond to the remote control:  
Press ▲, and then press POWER.  
Repeat this step until the device responds to the remote control, and then press RECALL.

**Note:** When a search cycle is completed, the mode indicator will blink three times. The remote control will begin to cycle through the available codes again. If no key is pressed within 10 seconds while programming, the remote control will exit the program mode and return to the previous code.

#### Notes:

- Every time you replace the batteries, you must reprogram the remote control.
- Some newer VCRs are capable of working on either of two remote codes. These VCRs have a switch labeled "VCR1/VCR2." If your VCR has this kind of switch and does not respond to any of the codes for your VCR brand, set the switch to the other position (VCR1 or VCR2) and reprogram the remote control.

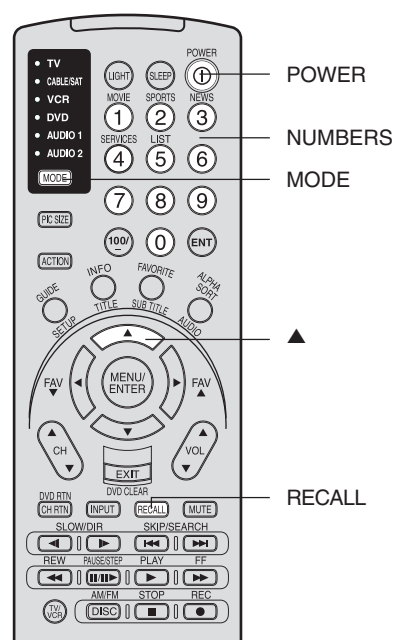

Important Safeguards

Welcome to Toshiba

Connecting your TV

Using the Remote Control

Setting up your TV

Using the TV's Features

Appendix



## Using the volume lock feature (8000)

For the TV, CABLE/SAT, VCR, and DVD modes, the volume controls (VOL ▲▼ and MUTE) can be programmed (locked) to the selected device mode. This feature does not apply to the AUDIO1/2 modes.

For example, to lock the volume controls to always jump to the CABLE/SAT mode:

1. Repeatedly press MODE to select the CABLE/SAT mode.
2. While holding down the RECALL button, press 8 -0 -0 -0.
3. Press VOL ▲.

The Mode indicator will blink two times (locked).

The following table describes in more detail the Volume Lock implementation.

Volume Locked to	TV	CBL/SAT	VCR	DVD	AUD1	AUD2
TV (default)	TV	TV	TV	TV	AUD1	AUD2
CBL/SAT	CBL/SAT	CBL/SAT	CBL/SAT	CBL/SAT	AUD1	AUD2
VCR	VCR	VCR	VCR	VCR	AUD1	AUD2
DVD	DVD	DVD	DVD	DVD	AUD1	AUD2
AUD1	AUD1	AUD1	AUD1	AUD1	AUD1	AUD1
AUD2	AUD2	AUD2	AUD2	AUD2	AUD2	AUD2

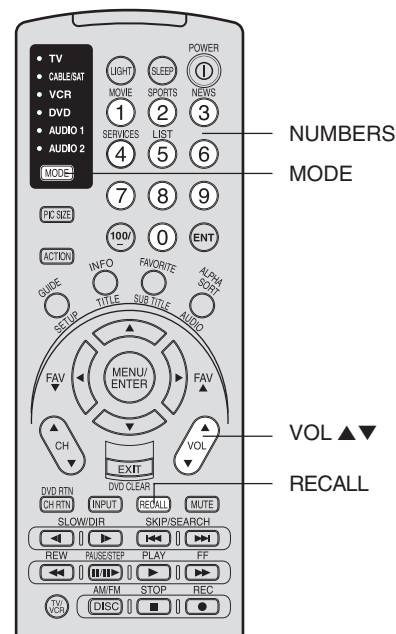

### Using the Remote Control

To reset the volume controls to the original device code:

1. While holding down the RECALL button, press 8 -0 -0 -0.
2. Press VOL ▼.

The Mode indicator will blink four times (unlocked).

## Operational feature reset (8900)

This feature clears all setup features not related to "Device code set up" and resets the Volume Lock to "TV."

To reset the features:

- While holding down the RECALL button, press 8 -9 -0 -0.  
The Mode indicator will blink two times, and then pause and blink two more times.



## Device code table

### VCR setup codes

Brand	Code
ADMIRAL	0135
AIWA	0127, 0132, 0181
AKAI	0129, 0114, 0115, 0116
AUDIO DYNAMIC	0139, 0111
BELL&HOWELL	0105, 0113
BROKSONIC	0120, 0126, 0180
CANON	0123, 0125
CCE	0143
CITIZEN	0106
CRAIG	0105, 0129, 0106
CURTIS MATHES	0145, 0124, 0127
DAEWOO	0143, 0101, 0124, 0175
DBX	0139, 0110, 0111
DIMENSIA	0145
EMERSON	0143, 0126, 0119, 0103, 0125, 0142, 0120, 0118
FISHER	0105, 0108, 0109, 0107, 0113, 0165
FUNAI	0127, 0126, 0120, 0134
GE	0133, 0145, 0124
GO VIDEO	0137, 0151, 0163, 0149, 0150, 0182
GOLDSTAR	0106
GRADIENTE	0170, 0171, 0168, 0134, 0156
HITACHI	0123, 0145, 0100, 0127, 0168
INSTANT REPLAY	0124, 0123
JENSEN	0139
JVC	0139, 0110, 0111, 0134, 0157, 0158, 0184, 0185
KENWOOD	0139, 0110, 0106, 0111
LG	0159
LXI	0127, 0106, 0100, 0107, 0108, 0105, 0109
MAGNAVOX	0131, 0123, 0124, 0173
MARANTZ	0139, 0110, 0111
MARTA	0106
MEMOREX	0124, 0109
MGA	0138, 0140, 0147, 0148, 0141, 0142
MINOLTA	0100, 0145
MITSUBISHI	0138, 0140, 0147, 0148, 0141, 0142, 0161, 0164
MULTITECH	0147, 0127, 0104
NEC	0139, 0110, 0111, 0134
OLYMPIC	0124, 0123
OPTIMUS	0128, 0121, 0135, 0106
ORION	0126, 0120, 0132
PANASONIC	0123, 0124, 0121, 0122
PENNEY	0124, 0100, 0145, 0105, 0139, 0110, 0111
PENTAX	0100, 0111, 0145

PHILCO	0131, 0124, 0127, 0123, 0126, 0120, 0143
PHILIPS	0131, 0123, 0124, 0173
PIONEER	0123
PROSCAN	0145, 0100, 0123, 0124, 0131, 0146, 0101, 0102, 0133, 0174
QUASAR	0121, 0122, 0123, 0124
RADIO SHACK	0133, 0124, 0105, 0136, 0109, 0140, 0127
RCA	0133, 0145, 0100, 0123, 0124, 0131, 0146, 0101, 0102, 0170, 0172, 0174, 0176, 0183
REALISTIC	0124, 0105, 0136, 0109, 0140, 0127
SAMSUNG	0137, 0102, 0104, 0133
SAMTRON	0163
SANSUI	0139, 0126, 0120, 0152
SANYO	0105, 0109, 0113
SCOTT	0101, 0102, 0104, 0109, 0138, 0140, 0147, 0148, 0126, 0120
SEARS	0105, 0106, 0107, 0108, 0100
SHARP	0135, 0136, 0167, 0162
SHINTOM	0117
SIGNATURE	2000 0127, 0135
SINGER	0117
SONY	0128, 0129, 0130, 0153, 0154, 0155
SV2000	0127
SYLVANIA	0131, 0123, 0124, 0127, 0178
SYMPHONIC	0127, 0168, 0177
TASHIRO	0106
TATUNG	0139, 0110, 0111
TEAC	0139, 0110, 0127, 0111
TECHNICS	0121, 0122, 0123, 0124
TEKNICA	0124, 0127, 0112
THOMSON	0179, 0183
TOSHIBA	0101, 0146, 0166, 0160
VECTOR RESEARCH	0111
WARDS	0135, 0136, 0109, 0144, 0106
YAMAHA	0105, 0139, 0110, 0111
ZENITH	0144, 0106, 0169, 0180

### Cable box setup codes

Brand	Code
ABC	1124
ARCHER	1132, 1125
CABLEVIEW	1105, 1132
CITIZEN	1122, 1105
CURTIS	1112, 1113
DIAMOND	1124, 1132, 1125
EAGLE	1129
EASTERN	1134
GCBRAND	1132, 1105
GEMINI	1122, 1143
G.I./JERROLD	1119, 1124, 1125, 1126, 1127, 1120, 1121, 1122, 1111, 1123, 1152
HAMLIN	1140, 1141, 1142, 1145, 1118, 1112
HITACHI	1103, 1124
MACOM	1103, 1104, 1105, 1108
MAGNAVOX	1133
MEMOREX	1130
MOVIETIME	1132, 1105
OAK	1139, 1137, 1102
PANASONIC	1109, 1110, 1114, 1151, 1153
PHILIPS	1128, 1129, 1130, 1106, 1107, 1150, 1131
PIONEER	1101, 1116
PULSAR	1105, 1132
PUSER	1132
RCA	1115
REALISTIC	1132
REGAL	1112, 1118, 1140, 1141, 1142, 1145, 1149
REGENCY	1134
REMBRANT	1137, 1132, 1105, 1138
SAMSUNG	1105
S.A.	1111, 1112, 1113
SLMARK	1105, 1101
SPRUCER	1105, 1110
STARGATE	1132, 1105
TELECAPTION	1148
TELEVIEW	1101, 1105
TEXSCAN	1144
TOCOM	1135, 1136, 1147
TOSHIBA	1104, 1146
UNIKA	1132, 1125
UNIVERSAL	1122, 1132
VIDEOWAY	1106
VIEWSTAR	1129, 1130
ZENITH	1117, 1100
ZENITH/DRAKE	
SATELLITE	1100

Important Safeguards

Welcome to Toshiba

Connecting your TV

Using the Remote Control

Setting up your TV

Using the TV's Features

Appendix



## Device code table

### CD Player setup codes

Brand	Code
ADMIRAL	6126
AIWA	6133, 6135
CARVER	6129
DENON	6142, 6151
EMERSON	6139
FISHER	6105, 6106
GARRARD	6117
HARMAN KARDON	6120, 6121, 6123, 6119
HITACHI	6107
JENSEN	6134
JVC	6140, 6141, 6145, 6148, 6151
KENWOOD	6100, 6101, 6111, 6145
LXI	6136
MAGNAVOX	6129, 6132
MARANTZ	6129
MCINTOSH	6121
NAKAMICHI	6110
ONKYO	6114, 6115
OPTIMUS	6108, 6118, 6120, 6122
PANASONIC	6124, 6125, 6127, 6150
PHILIPS	6129, 6130, 6149
PIONEER	6108
QUASAR	6125, 6127, 6124
RCA	6147, 6137, 6138, 6131, 6152
SANSUI	6110, 6146, 6113
SANYO	6105
SCOTT	6110, 6146
SHARP	6142, 6143
SHERWOOD	6120
SONY	6128
SOUNDE-SIGH	6144
TEAC	6112, 6116, 6118
TECHNICS	6127, 6124, 6125
VICTOR	6140, 6141, 6145
YAMAHA	6102, 6103, 6104

### Receiver setup codes

Brand	Code
ADMIRAL	4120
AIWA	4125, 4126, 4146
DENON	4134, 4135, 4136, 4143
FISHER	4104
GARRARD	4113
HARMAN KARDON	4115, 4123, 4145
JENSEN	4129
JVC	4132, 4133, 4140, 4144
KENWOOD	4100, 4108, 4141, 4142, 4147
MAGNAVOX	4127, 4128
MARANTZ	4124
MCINTOSH	4116
mitsubishi	4148
NAKAMICHI	4106, 4117
ONKYO	4109, 4114
OPTIMUS	4103, 4127, 4131, 4130
PANASONIC	4119, 4118, 4121
PHILIPS	4123
PIONEER	4105, 4107, 4150

QUASAR	4119, 4118, 4121
RCA	4103, 4105, 4127, 4131, 4130, 4149
SANSUI	4103, 4111, 4139
SHARP	4134, 4137
SONY	4122
SOUNDE-SIGH	4138
TEAC	4112, 4113, 4111, 4110
TECHNICS	4121, 4118, 4119
VICTOR	4132, 4133
YAMAHA	4101, 4102

### Cassette Player setup codes

Brand	Code
AIWA	7123, 7124, 7125
DENON	7131
FISHER	7103
JENSEN	7114
JVC	7129, 7130, 7132, 7133
KENWOOD	7100, 7107
MARANTZ	7102
NAKAMICHI	7105
ONKYO	7108, 7109, 7113
PANASONIC	7116, 7118
PHILIPS	7122, 7121
PIONEER	7104, 7106
RCA	7126, 7127, 7128, 7134, 7135
SANSUI	7105, 7110, 7112
SHARP	7131
SONY	7119, 7120
TEAC	7110, 7111, 7115
TECHNICS	7116, 7118, 7117
YAMAHA	7101, 7102

### Laser Disc setup codes

Brand	Code
DENON	5114
HITACHI	5100
KENWOOD	5102, 5103
MAGNAVOX	5101
MARANTZ	5114
MITSUBISHI	5114, 5118, 5119
NEC	5114
PANASONIC	5104, 5105, 5106, 5115
PHILIPS	5111
PIONEER	5114
PROSCAN	5114
QUASAR	5104, 5105, 5106, 5115
RCA	5114
SAMSUNG	5112
SANYO	5114, 5117
SHARP	5113, 5116
SONY	5107, 5108, 5109, 5110
TEAC	5114
TOSHIBA	5114
YAMAHA	5101

### DVD setup codes

Brand	Code
AIWA	3123
APEX	3120
DENON	3100, 3117
FERGUSON	3101
HITACHI	3111
JVC	3109
KENWOOD	3115, 3129
KONKA	3119
MITSUBISHI	3105
NORDMENDE	3101
ONKYO	3121
ORITRON	3124
PANASONIC	3100
PHILIPS	3103, 3116
PIONEER	3102
RAITE	3113
RCA	3101, 3106
SABA	3101
SAMPO	3114
SAMSUNG	3110
SHARP	3108
SILVANIA	3132, 3118
SMC	3125
SONY	3104, 3126, 3127, 3128
TECHNICS	3100
THOMSON	3101
TOSHIBA	3103
WAVE	3122
YAMAHA	3100, 3130
ZENITH	3107, 3112
VIALTA	3131
FUNAI	3132, 3118

### Satellite Receiver setup codes

Brand	Code
DISH NETWORK (EchoStar)	2105, 2115, 2116, 2117
ECHOSTAR	2105
EXPRESS VU	2105, 2115
G.E.	2106
G.I. (GENERAL INSTRUMENT)	2108
GRADIENTE	2114
HITACHI	2103, 2111, 2112
HNS (Hughes)	2103
MAGNAVOX	2101, 2102
PANASONIC	2104
PHILIPS	2101, 2102, 2118
PRIMESTAR	2108
PROSCAN	2106, 2109, 2110, 2113
RCA	2106, 2109, 2110, 2113
SONY	2107
STAR CHOICE	2103, 2108
TOSHIBA	2100, 2103, 2119, 2120, 2121
UNIDEN	2101, 2102

Using the Remote Control



## Learning about the remote control

The buttons used for operating the TV only are described here. For a complete list of the remote control's functions, see the "Remote control functional key chart" on pages 17-18.

**POWER** turns the TV on and off

**SLEEP** allows access to the automatic TV shut-off function (page 40)

**LIGHT** The first press of the LIGHT button lights the keypad and turns on the Illumination mode. With the Illumination mode on, pressing any other key lights the keypad for 5 seconds (10 seconds if you're in programming mode). Subsequent presses of the LIGHT button toggle between turning the Illumination mode on and off.

**CHANNEL NUMBERS (0-9, 100)** allow direct access to channels (page 26)

**MODE** cycles through the six device modes: TV, CABLE/SAT, VCR, DVD, AUDIO1, and AUDIO2. The mode indicator light will remain lit for a few seconds (page 19).

**PIC SIZE** cycles through the five pictures sizes: Natural, TheaterWide 1, 2, 3, and Full (page 34)

**MENU** allows access to on-screen programming menus (page 24)

**ENTER** sets programming menu information (page 24)

**▲▼▶◀** select or adjust programming menus (page 24)

**FAV▲▼** cycles through favorite channels (page 26)

**CH▲▼** cycles through programmed channels (page 26)

**VOL▲▼** adjusts the volume level

**EXIT** exits the programming menus (page 24)

**INPUT** selects the video input source (page 32)

**MUTE** mutes the sound (page 41)

**RECALL** displays on-screen information (page 43)

**CH RTN** returns to the last viewed channels (page 26)

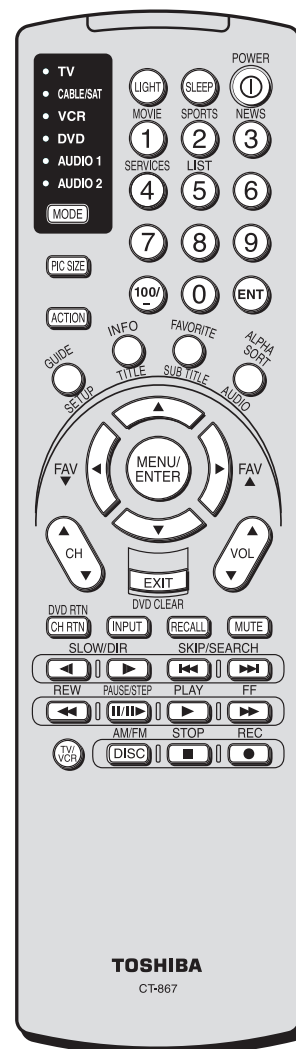

Important Safeguards

Welcome to Toshiba

Connecting your TV

Using the Remote Control

Setting up your TV

Using the TV's Features

Appendix

## Setting up your TV

After you have installed the batteries and programmed the remote control, you need to set some preferences on the TV using the menu system. You can access the menu system with the buttons on the remote control.

- When you make a menu selection, your changes occur immediately. You do not have to press MENU or EXIT to save your changes.
- After 15 seconds, the menu screen will automatically close if you do not make a selection. Your changes will still be saved.
- When you are finished programming the menus, press EXIT.

### Starting setup

The STARTING SETUP feature appears the first time you turn on the TV, and helps you select the menu language, specify the TV/CABLE setting, and program channels automatically.

**IMPORTANT: You must connect an antenna or cable TV system first. See “Connecting your TV” on pages 7-15 for details.**

1. Press POWER to turn on the TV. The starting setup function begins and the language setup menu appears on the screen. Press ▲ or ▼ to select your desired language, then press ENTER.
2. Press ▲ or ▼ to select “TV” or “CABLE,” then press ENTER.
3. Press ▲ or ▼ to select “START,” then press ENTER. If you select “CANCEL” and press ENTER, the STARTING SETUP stops and changes to the TV screen.
4. Now the “AUTO SETUP” starts. After the starting setup is completed, the TV channel appears on the screen.
  - If you press the EXIT button during the “AUTO SETUP” process, the STARTING SETUP stops and changes to the TV screen.

### Changing the on-screen display language

You can choose from three different languages (English, French, and Spanish) for the on-screen displays of adjustment menus and messages.

**To select a language:**

1. Press MENU, then press ◀ or ▶ until the SETUP menu appears.

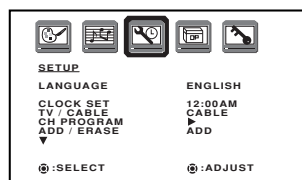

2. Press ▲ or ▼ to highlight LANGUAGE.

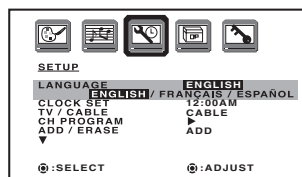

3. Press ◀ or ▶ to highlight your desired language.

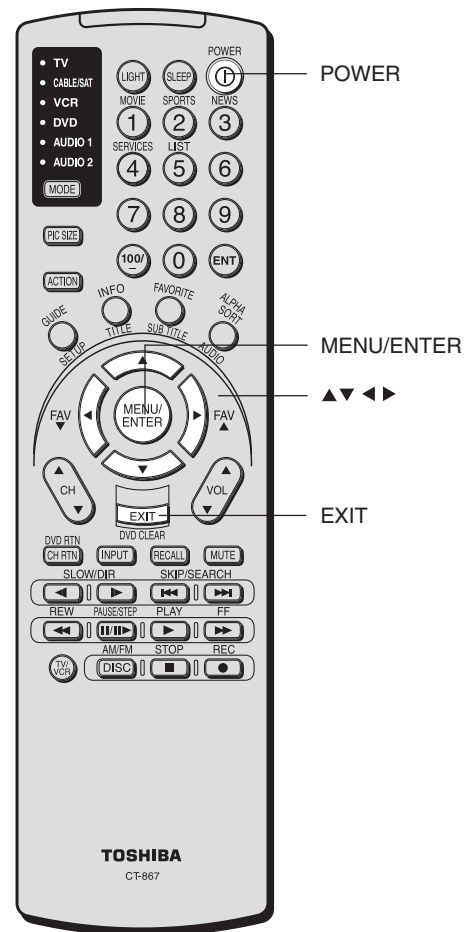

**Note:**

The position and size of the on-screen menus change for some program formats (such as 1080i or 720p.)

Setting up your TV





## Image tilt correction

When you install or change the direction of the TV, the picture may become tilted (caused by the Earth's magnetism). If this happens, use the image tilt correction feature to obtain the best possible picture.

### To adjust the image tilt:

1. Press MENU, then press ◀ or ▶ until the SETUP menu appears.
2. Press ▲ or ▼ to highlight IMAGE TILT.
3. Press ◀ or ▶ to adjust the picture tilt (from -10 to 10.)

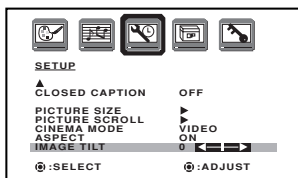

## Adding channels to the TV's memory

When you press CH ▲ or ▼, your TV will stop only on the channels you have programmed into the TV's channel memory. Follow the steps below to program channels into the channel memory.

### Programming channels automatically

Your TV can automatically detect all active channels and store them in its memory. After the TV has stored the channels in its memory automatically, you can add or erase channels manually.

#### To add channels automatically:

1. Press MENU, then press ◀ or ▶ to display the SETUP menu.
2. Press ▲ or ▼ until the TV/CABLE selection is highlighted.
3. Press ◀ or ▶ to highlight either TV or CABLE, depending on which you use.  
If you use an antenna, choose TV.  
If you use cable, choose CABLE.
4. Press ▼ until the CH PROGRAM selection is highlighted.
5. Press ◀ or ▶ to start channel programming. The TV will automatically cycle through all the TV or Cable channels (depending on which you selected), and store all active channels in the channel memory. While the TV is cycling through the channels, the message "PROGRAMMING NOW-PLEASE WAIT" appears.
6. When channel programming is complete, the message "COMPLETED" appears.
7. Press CH ▲ or ▼ to view the programmed channels.

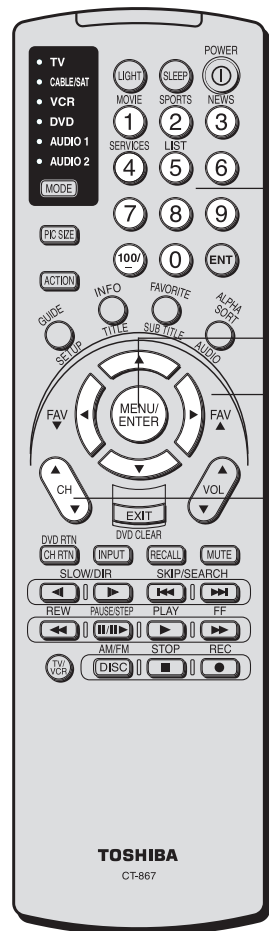
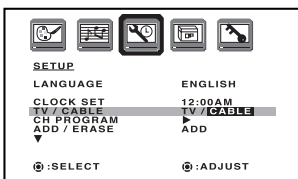

CHANNEL NUMBERS

MENU

▶▶▶▶

CHANNEL ▲▼

Important Safeguards

Welcome to Toshiba

Connecting your TV

Using the Remote Control

Setting up your TV

Using the TV's Features

Appendix

## Adding and erasing channels manually

After you have programmed the channels automatically, you can add or erase specific channels manually.

#### To add or erase channels manually:

1. Select the channel you want to add or erase. If you are adding a channel, you must select the channel using the Channel Number buttons.
2. Press MENU, then press ◀ or ▶ to display the SETUP menu.
3. Press ▲ or ▼ to highlight ADD/ERASE.
4. Press ◀ or ▶ to select ADD or ERASE, whichever function you want to perform.
5. Repeat steps 1-4 for other channels you want to add or erase.

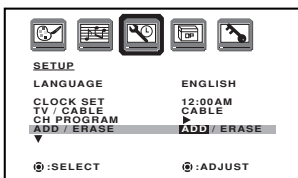



## Changing channels

### To change to the next programmed channel:

Press Channel ▲/▼ on the TV or CH ▲/▼ on the remote control.

### To change to a specific channel (programmed or unprogrammed):

Press the Channel Number buttons (0-9 and 100) on the remote control.

For example, to select channel 125, press 100, 2, 5.

## Using the TV's features

### Adjusting the channel settings

#### Switching between two channels

You can switch between two channels without entering an actual channel number each time.

#### To switch between two channels:

1. Select the first channel you want to view.
2. Select a second channel using the Channel Number buttons (0-9, 100).
3. Press CH RTN. The previous channel will be displayed.

Each time you press CH RTN, the TV will switch back and forth between the two channels.

#### Programming your favorite channels

You can preset up to 12 of your favorite channels using the Favorite Channel Programming feature. Because this feature scans through only your favorite channels, it allows you to skip other channels you do not normally watch.

You can still use Channel ▲/▼ to scan through all the channels you programmed in the TV's memory.

#### To program your favorite channels:

1. Select a channel you want to program as a favorite channel.
2. Press MENU, then press ◀ or ▶ to display the OPTION menu.
3. Press ▲ or ▼ to highlight FAVORITE CH.

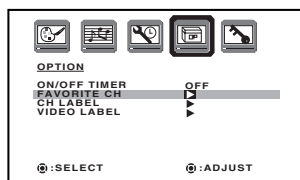

4. Press ◀ or ▶ to display the FAVORITE CH menu. SET/CLEAR will be highlighted.

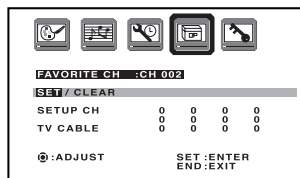

5. Press ◀ or ▶ to highlight SET and press ENTER.
6. Press EXIT to return to normal viewing.
7. Repeat steps 1-6 for up to 12 channels.

#### To select your favorite channels:

Press the FAV ▲ ▼ buttons on the remote control to select your favorite channels.

The FAV ▲ ▼ buttons will not work until you have programmed your favorite channels.

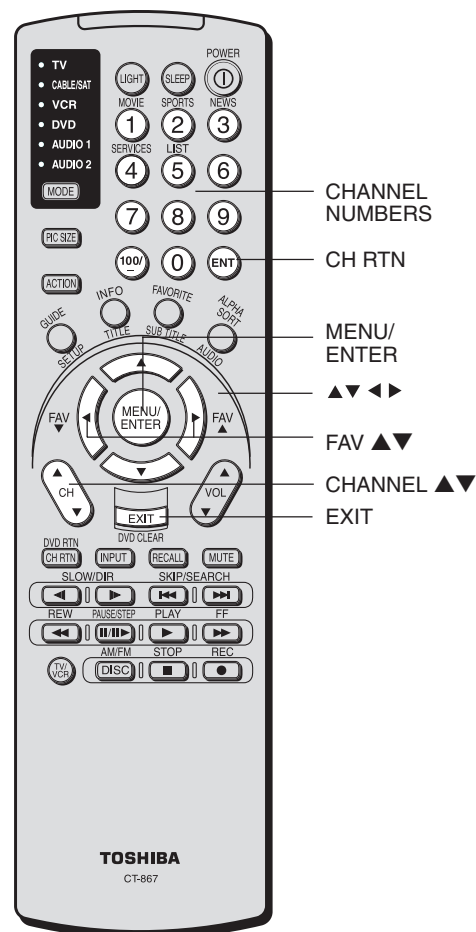



### To clear your favorite channels:

1. Select a channel you want to clear.
2. Press MENU, then press ◀ or ▶ to display the OPTION menu.
3. Press ▲ or ▼ to highlight FAVORITE CH.
4. Press ◀ or ▶ to display the FAVORITE CH menu. SET/CLEAR will be highlighted.
5. Press ◀ or ▶ to highlight CLEAR.

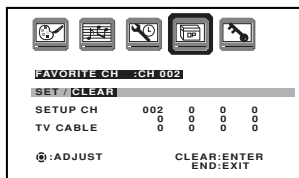

6. Press ENTER until "0" replaces the channel number you want to erase.
7. Press EXIT to return to normal viewing.
8. Repeat steps 1-6 for the other channels.

### Using the LOCKS menu

**Note: The V-Chip feature is available for the U.S. V-Chip system only. The Canadian V-Chip system is not supported.**

You can prevent others from viewing certain programs or channels by blocking them using the V-Chip feature.

### Selecting a password

Before you can use the V-Chip feature to block programs and channels, you must select a password. The password you select prevents others from changing the rating limits you set.

#### To select your password and access the LOCKS menu:

1. Press MENU, then press ◀ or ▶ to highlight the LOCKS menu.
2. Press ▲ or ▼ to display the password entering mode.

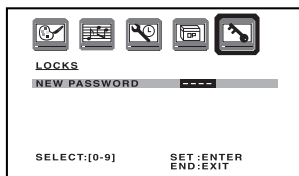

3. Use the Channel Number buttons (0-9) to enter your password. If you are accessing the LOCKS menu for the first time, select a four-digit number to be your password. Press ENTER.

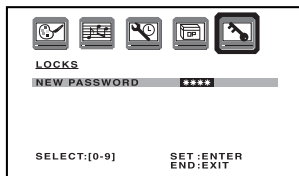

4. Enter the password again to confirm it, and then press ENTER. The LOCKS menu appears.

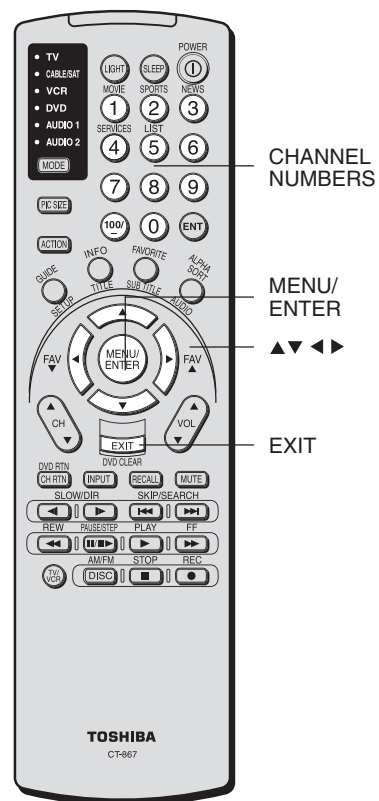
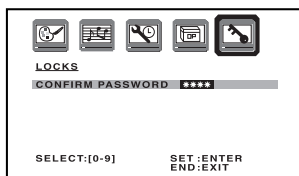

Important Safeguards

Welcome to Toshiba

Connecting your TV

Using the Remote Control

Setting up your TV

Using the TV's Features

Appendix



- You may now set up the LOCKS menu. See “Using the V-Chip (parental control) feature” (below), “Locking channels” (page 29), “Locking the video inputs” (page 30), “Setting the GameTimer™” (page 30), and “Using the front panel lock feature” (page 31).

**To change your password:**

- Press MENU, then press ◀ or ▶ to display the LOCKS menu.
- Press ▲ or ▼ to display the password entering mode.
- Use the Channel Number buttons (0-9) to enter your password. Press ENTER. The LOCKS menu appears.
- Press ▲ or ▼ to highlight NEW PASSWORD and press ◀ or ▶ to display the NEW PASSWORD menu.
- Use the Channel Number buttons (0-9) to enter a new code. Press ENTER.
- Enter the password again to confirm it, and then press ENTER.
- Press EXIT to return to normal viewing.

**Using the V-Chip (parental control) feature**

The Motion Picture Association of America (MPAA) uses a rating system to qualify motion picture content. Television broadcasters also employ a rating system to qualify the content of television programs. The TV and MOVIE ratings work with the V-Chip feature and allow you to block programs according to the rating limits you set.

**To use the V-Chip to block programs by rating:**

- Press MENU, then press ◀ or ▶ to display the LOCKS menu.
- Press ▲ or ▼ to display the password entering mode.
- Use the Channel Number buttons (0-9) to enter your password. Press ENTER. The LOCKS menu appears.
- Press ▲ or ▼ to highlight V-CHIP.
  - Press ◀ or ▶ to highlight ON to enable V-Chip program blocking by rating.
  - Press ◀ or ▶ to highlight OFF to disable V-Chip program blocking by rating.
- Press ▲ or ▼ to highlight TV RATING. Then, press ◀ or ▶ to display the desired rating.

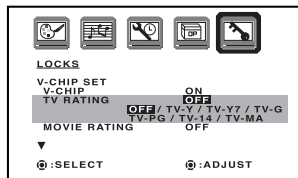
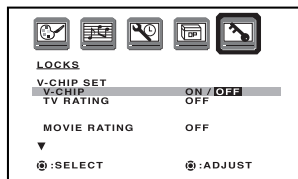

- Then, press ◀ or ▶ to display the desired rating.
- OFF** : TV RATING is not set
  - TV-Y** : All children
  - TV-Y7** : 7 years old and above
  - TV-G** : General audience
  - TV-PG** : Parental guidance
  - TV-14** : 14 years old and above
  - TV-MA** : 17 years old and above
- When you select TV-Y7, TV-PG, TV-14, or TV-MA, press **RECALL** to explain the rating. Press ▲ or ▼ to select the desired rating you want. Press ◀ or ▶ to select the setting “ON” or “OFF”.

- Press ▲ or ▼ to highlight MOVIE RATING. Then, press ◀ or ▶ to display the desired rating.

- OFF** : MOVIE RATING is not set (no movies will be blocked)
- G** : All ages
- PG** : Parental guidance
- PG-13** : Parental guidance less than 13 years old
- R** : Under 17 years old Parental guidance suggested
- NC17** : 17 years old and above
- X** : Adult only

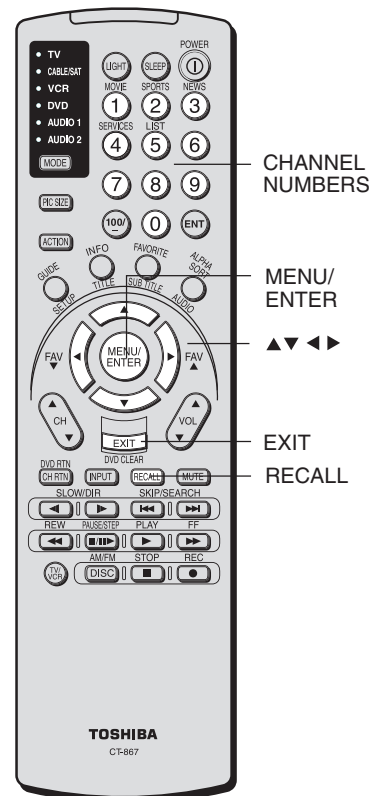
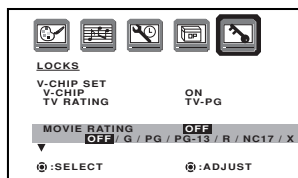

**Note:**

If you forget your password, press **RECALL** four times within five seconds while the TV is in password entering mode. This allows you to reset your password.



- When you are done selecting the ratings, press EXIT to return to normal viewing.

When you try to view a program with a ratings block, a message will appear listing the program's ratings. The program can still be viewed if you press MUTE and then enter your password to temporarily bypass the block.

## Locking channels

With the CH LOCK feature, you can lock specific channels. You will not be able to tune locked channels unless you clear the setting. You can choose to lock up to nine TV channels and nine cable channels.

### To lock channels:

- Select a channel you want to lock.
- Press MENU, then press ◀ or ▶ to display the LOCKS menu.
- Press ▲ or ▼ to display the password entering mode.
- Use the Channel Number buttons (0-9) to enter your password, then press ENTER. The LOCKS menu appears.

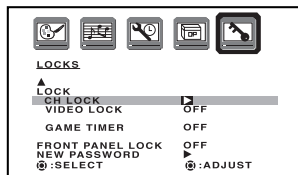

- Press ▲ or ▼ to highlight CH LOCK and press ◀ or ▶ to display the CH LOCK menu.

- Press ◀ or ▶ to select the following:
  - SET: to set the channel as one to be locked. Then press ENTER.
  - CLEAR: to clear all channels from the list of locked channels. Then press ENTER.

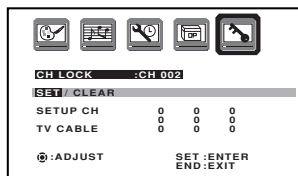

- Repeat steps 1 through 6 to lock other channels. When you are finished locking channels, press EXIT to return to normal viewing.

If you try to tune a locked channel, the TV will not display it, but will display the nearest unlocked channel.

### To unlock channels:

- Press MENU, then press ◀ or ▶ to display the LOCKS menu.
- Press ▲ or ▼ to display the password entering mode.
- Use the Channel Number buttons (0-9) to enter your password, then press ENTER. The LOCKS menu appears.
- Press ▲ or ▼ to highlight CH LOCK and press ◀ or ▶ to display the CH LOCK menu.
- Press ◀ or ▶ to highlight CLEAR and clear all channels from the list of locked channels. Press ENTER.
- Press EXIT to return to normal viewing.

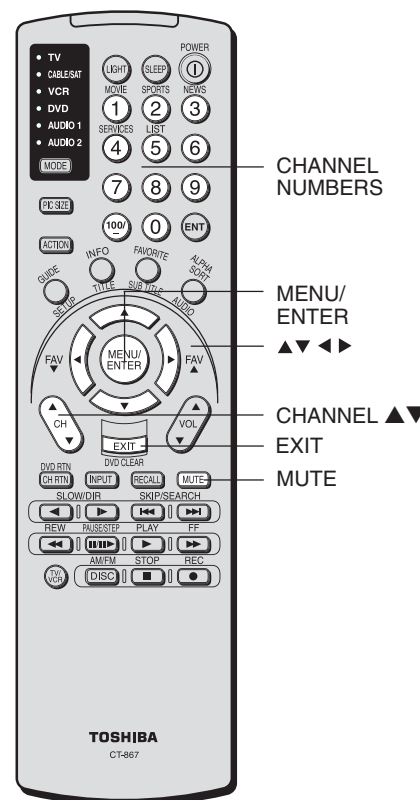

Important Safeguards

Welcome to Toshiba

Connecting your TV

Using the Remote Control

Setting up your TV

Using the TV's Features

Appendix

### Note:

After programming CH LOCK, change channels before turning off the television.



## Locking the video inputs

With the VIDEO LOCK feature, you can lock out the input sources (VIDEO1, VIDEO2, VIDEO3, COLORSTREAM HD1, COLORSTREAM HD2, HDMI) and channels 3 and 4.

You will not be able to select the input sources with the INPUT button or Channel Number unless you clear the setting.

### To set up the video lock:

1. Press MENU, then press ◀ or ▶ to display the LOCKS menu.
2. Press ▲ or ▼ to display the password entering mode.
3. Use the Channel Number buttons (0-9) to enter your password, then press ENTER. The LOCKS menu appears.
4. Press ▲ or ▼ to highlight VIDEO LOCK.
5. Press ◀ or ▶ to select:

- **OFF:** Unlocks all video input sources.
- **VIDEO:** Locks VIDEO1, VIDEO2, VIDEO3, COLORSTREAM HD1, COLORSTREAM HD2, and HDMI.
- **VIDEO +:** Locks VIDEO1, VIDEO2, VIDEO3, COLORSTREAM HD1, COLORSTREAM HD2, HDMI, channel 3, and channel 4. This option should be used if you use the antenna terminal to play a video tape.

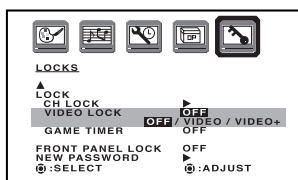

6. Press EXIT to return to normal viewing.

### To unlock the video inputs:

1. Press MENU, then press ◀ or ▶ to display the LOCKS menu.
2. Press ▲ or ▼ to display the password entering mode.
3. Use the Channel Number buttons (0-9) to enter your password, then press ENTER. The LOCKS menu appears.
4. Press ▲ or ▼ to highlight VIDEO LOCK and press ◀ or ▶ to highlight OFF.
5. Press EXIT to return to normal viewing.

## Setting the GameTimer™

With the GameTimer™ feature, you can automatically activate the VIDEO LOCK feature (VIDEO setting) to set a time limit for playing a video game (30, 60, 90, or 120 minutes).

### To set up the GameTimer:

1. Press MENU, then press ◀ or ▶ to display the LOCKS menu.
2. Press ▲ or ▼ to display the password entering mode.
3. Use the Channel Number buttons (0-9) to enter your password, then press ENTER. The LOCKS menu appears.
4. Press ▲ or ▼ to highlight GAME TIMER.
5. Press ◀ or ▶ to select a time limit (30 minutes, 60 minutes, 90 minutes, 120 minutes, or OFF).
6. Press EXIT to return to normal viewing. After the GameTimer is programmed, the display will appear briefly every ten minutes to remind you that the GameTimer is operating.

When the programmed time is reached, the TV will change channels automatically and enter VIDEO LOCK mode.

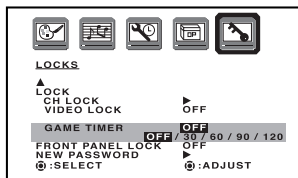

### To deactivate the GameTimer and unlock the VIDEO LOCK:

Set the VIDEO LOCK to OFF (see "Locking the video inputs" above.)

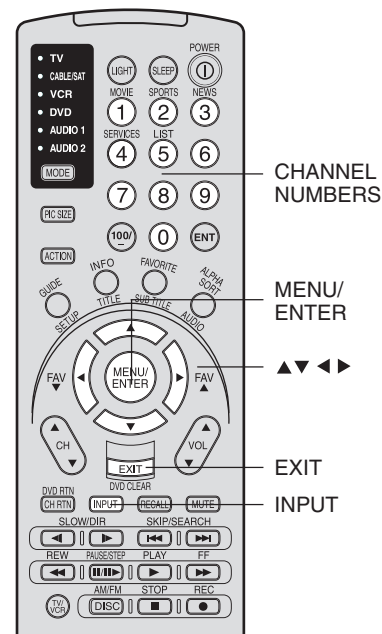

### Note:

After programming VIDEO LOCK, change channels or press the INPUT key before turning off the television.

### Note:

Interactive video games that involve shooting a gun type of joy-stick at an on-screen target may not work on this TV.



## Using the front panel lock feature

You can lock the front panel buttons to prevent your settings from being changed accidentally (by children, for example). When the front panel lock is in ON, all control buttons on the TV front panel (except POWER) do not operate.

### To lock the front panel:

1. Press MENU, then press ◀ or ▶ to display the LOCKS menu.
2. Press ▲ or ▼ to display the password entering mode.
3. Use the Channel Number buttons (0-9) to enter your password, then press ENTER. The LOCKS menu appears.
4. Press ▲ or ▼ to highlight FRONT PANEL LOCK and press ◀ or ▶ to highlight ON.
5. Press EXIT to return to normal viewing. If a button on the front panel is pressed, the message "NOT AVAILABLE" appears.

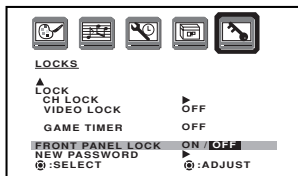

### To unlock the front panel:

Press and hold the VOL ▼ button on the TV front panel for about 10 seconds until the message "FRONT PANEL LOCK: OFF" appears on-screen.

### You also can unlock the front panel using the menus:

1. Press MENU, and then press ◀ or ▶ to display the LOCKS menu.
2. Press ▲ or ▼ to display the password entering mode.
3. Use the Channel Number buttons (0-9) to enter your password, then press ENTER. The LOCKS menu appears.
4. Press ▲ or ▼ to highlight FRONT PANEL LOCK, and then press ◀ or ▶ to highlight OFF.

## Labeling channels

Channel labels appear above the channel number display each time you turn on the TV, select a channel, or press the RECALL button. You can choose any four characters to create a channel label.

### To create channel labels:

1. Select a channel you want to label.
2. Press MENU, then press ◀ or ▶ until the OPTION menu appears.
3. Press ▲ or ▼ to highlight CH LABEL.
4. Press ◀ or ▶ to display the CH LABEL menu. SET/CLEAR will be highlighted.
5. Press ◀ or ▶ to highlight SET.
6. Press ▲ or ▼ to highlight LABEL.
7. Repeatedly press ◀ or ▶ until the character you want appears. Press ENTER.
8. Repeat step 7 to enter the rest of the characters. If you would like a blank space in the label name, you must choose an empty space from the list of characters; otherwise, a dash will appear in that space.
9. Repeat steps 1-8 for other channels. You can assign a label to each channel.
10. Press EXIT to return to normal viewing.

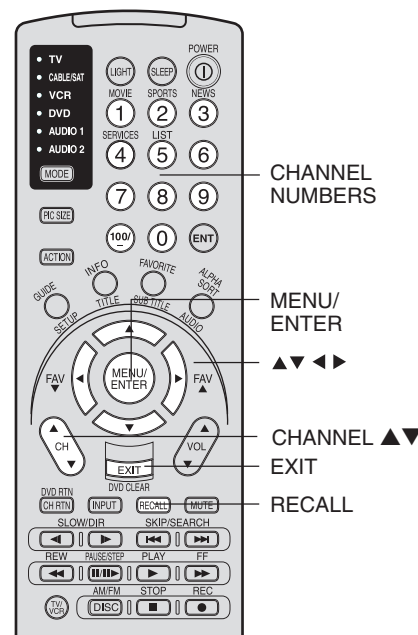
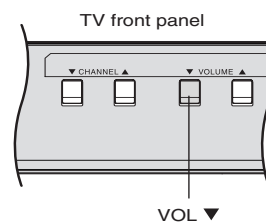
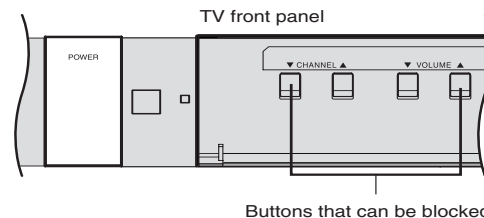
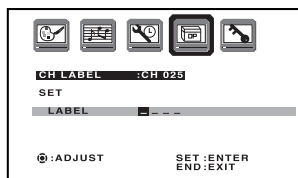
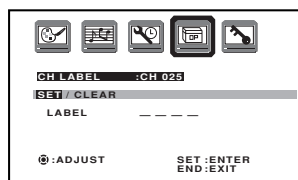
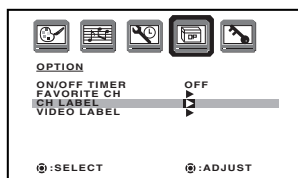

### Note:

The character will change as below.

←→ 0...9 ←→ A...Z

←→ SPACE ←→ + ←→ -

### To erase channel labels:

1. Tune the TV to the channel whose label you want to erase.
2. Press MENU, then press ◀ or ▶ until the OPTION menu appears.
3. Press ▲ or ▼ to highlight CH LABEL.
4. Press ◀ or ▶ to display the CH LABEL menu. SET/CLEAR will be highlighted.
5. Press ◀ or ▶ to highlight CLEAR.
6. Press ENTER.
7. Repeat steps 1-6 to erase other channel labels.

Important  
Safeguards

Welcome to  
Toshiba

Connecting  
your TV

Using the  
Remote Control

Setting up  
your TV

Using the TV's  
Features

Appendix



## Selecting the video input source

Press INPUT to view a signal from another device connected to your TV, such as a VCR or DVD player. You can select ANT, VIDEO 1, VIDEO 2, VIDEO 3, ColorStream HD1, ColorStream HD2, or HDMI depending on which input jacks you used to connect your devices (see "Connecting your TV" on page 7).

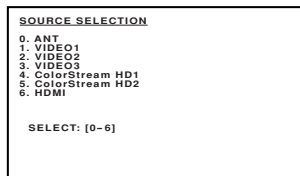

Pressing INPUT on the remote control displays the current signal source (press INPUT again or 0-6 to change)

### Note:

When ColorStream HD 1, ColorStream HD 2, or HDMI is selected, the video OUT jack does not output a signal. To receive a video OUT signal, you must use a standard video or S-video connection instead.



**NEVER CONNECT THIS TV TO A PERSONAL COMPUTER (PC). This TV is not intended for use with a PC.**

## Labeling the video input sources

The video label feature allows you to label each input source for your TV from the following preset list of labels:

- : Uses the default label name
- VCR** : Video cassette recorder
- DVD** : DVD video
- DTV** : Digital TV set-top box
- SAT** : Satellite box
- CBL** : Cable box

### To label the video input sources:

1. Press MENU, and then press ◀ or ▶ to display the OPTION menu.
2. Press ▲ or ▼ to highlight VIDEO LABEL.
3. Press ▶ to display the VIDEO LABEL menu.
4. Press ▲ or ▼ to highlight the video source you want to label.
5. Press ◀ or ▶ to select the desired label for that input source.
6. Press EXIT to return to normal viewing.

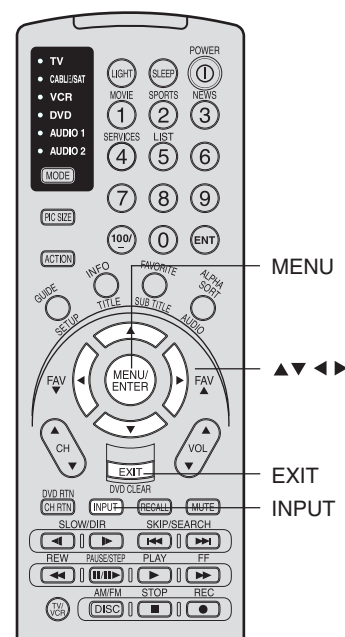
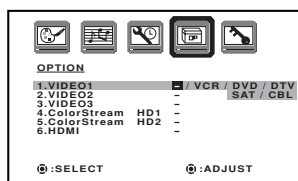
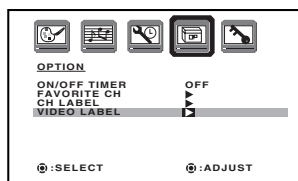







## Viewing the wide-screen picture formats (480i and 480p signals only)

You can view 480i and 480p format programs in a variety of picture sizes—Natural, TheaterWide 1, TheaterWide 2, TheaterWide 3, and Full.

The way the image displays in any of the picture sizes will vary depending on the format of the program you are viewing. Select the picture size that displays the current program the way that looks best to you.

### Selecting the picture size

1. Press PIC SIZE on the remote control.
2. Press the corresponding number button (0-4) to select the desired picture size, as described below and on the next page.

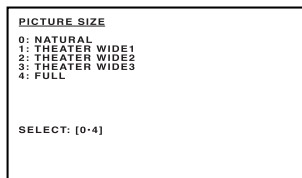

### Natural picture size

- The image is displayed close to its originally formatted proportion. Some program formats will display with side bars and/or bars at the top and bottom.

Natural picture size example: The way the image displays will vary depending on the format of the program you are currently watching.

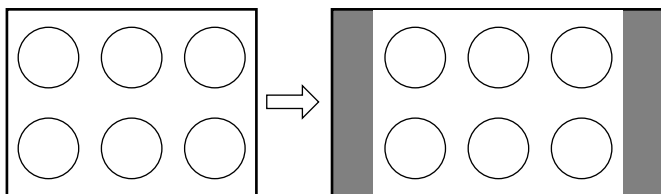

Conventional (4:3) picture on a conventional TV screen

Conventional (4:3) picture in Natural size on your wide-screen TV

### TheaterWide 1 picture size (for 4:3 format programs)

- The center of the picture remains close to its original proportion, but the left and right edges are stretched wider to fill the screen.
- The top and bottom edges of the picture may be hidden; however, this mode cannot be scrolled.

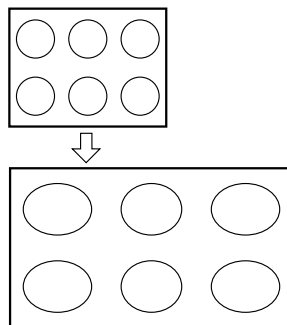

TheaterWide 1 picture size example

Using the TV's Features

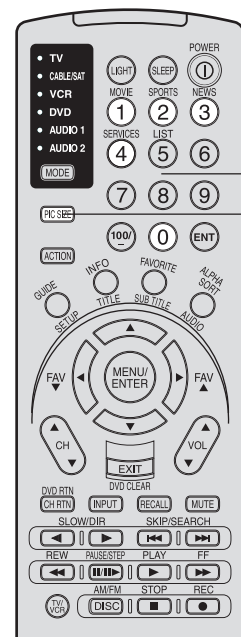

0-4

PIC SIZE

### Note:

You also can change the picture size by selecting PICTURE SIZE in the SETUP menu.

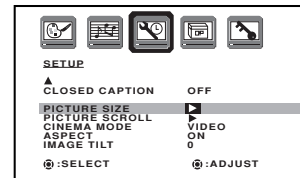

### Notes:

- The PICTURE SIZE feature is not available for some program formats (such as 1080i or 720p.) Such formats will display in Natural picture size.
- If you select TheaterWide 2 or 3, the top and bottom edges of the picture may be hidden. To see the hidden edges, either scroll the picture (see page 36) or try viewing the program in Full picture size.

### NOTICE OF POSSIBLE ADVERSE EFFECTS ON TV PICTURE DISPLAY

Avoid displaying stationary images on your TV screen for extended periods of time. Fixed (non-moving) patterns or images (including but not limited to PIP/POP windows, closed captions, video game patterns, TV station logos, stock tickers, websites, and special formats that do not use the entire screen) can become permanently ingrained in the cathode ray tube(s) of the TV and cause subtle but permanent ghost images. **This type of damage is NOT COVERED BY YOUR WARRANTY.**

- Using these functions to change the picture size (i.e., changing the height/width ratio) for any purpose other than your private viewing may be prohibited under the Copyright Laws of the United States and other countries, and may subject you to civil and criminal liability.



### TheaterWide 2 picture size (for letter box programs)

- The picture is stretched the same amount both wider and taller (retains its original proportion).
- The top and bottom edges of the picture may be hidden. To view the hidden areas, see "Scrolling the TheaterWide picture" on page 36.

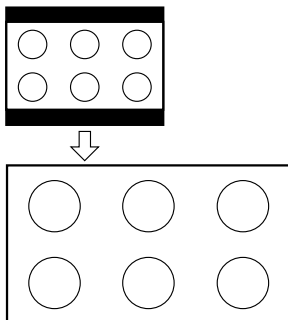

TheaterWide 2 picture size example

### TheaterWide 3 picture size (for letter box programs with subtitles)

- The picture is stretched wider to fill the width of the screen, but only slightly stretched taller.
- The top and bottom edges of the picture may be hidden. To view the hidden areas (such as subtitles or captions), see "Scrolling the TheaterWide picture" on page 36.

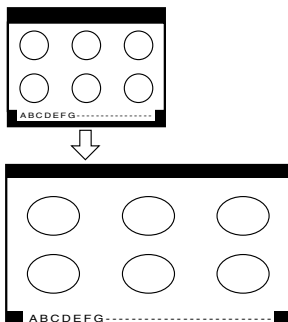

TheaterWide 3 picture size example

### Full picture size (for 16:9 source programs)

- If receiving a 4:3 format program, the picture is stretched wider to fill the width of the screen, but not stretched taller.
- None of the picture is hidden.

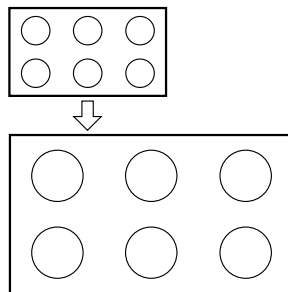

Full picture size example

#### Note:

Using these functions to change the picture size (i.e., changing the height/width ratio) for any purpose other than your private viewing may be prohibited under the Copyright Laws of the United States and other countries, and may subject you to civil and criminal liability.

#### NOTICE OF POSSIBLE ADVERSE EFFECTS ON TV PICTURE DISPLAY

Avoid displaying stationary images on your TV screen for extended periods of time. Fixed (non-moving) patterns or images (including but not limited to PIP/POP windows, closed captions, video game patterns, TV station logos, stock tickers, websites, and special formats that do not use the entire screen) can become permanently ingrained in the cathode ray tube(s) of the TV and cause subtle but permanent ghost images. **This type of damage is NOT COVERED BY YOUR WARRANTY.**

Important Safeguards

Welcome to Toshiba

Connecting your TV

Using the Remote Control

Setting up your TV

Using the TV's Features

Appendix



## Scrolling the TheaterWide® picture (TheaterWide 2 and 3 only)

1. Press PIC SIZE to select the TheaterWide 2 or 3 mode.
2. Press MENU, and then press ◀ or ▶ until the SETUP menu appears.
3. Press ▲ or ▼ to highlight PICTURE SCROLL.

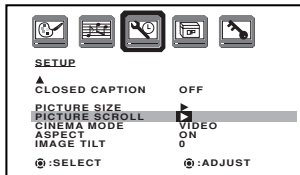

4. Press ◀ or ▶ to display the Scroll Adjustment mode.

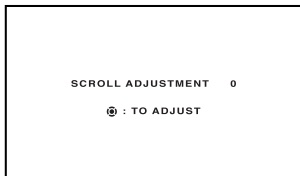

5. Press ▲ or ▼ to adjust the vertical position of the picture.
  - Normal (center) position

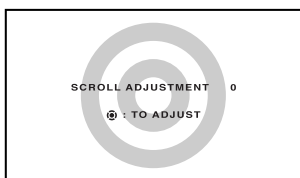

- To raise the picture, press ▲.

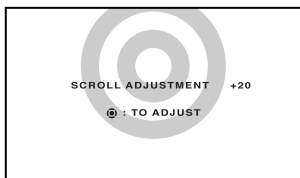

- To lower the picture, press ▼.

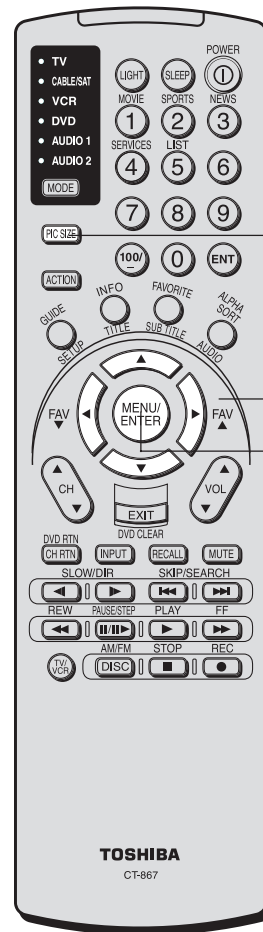
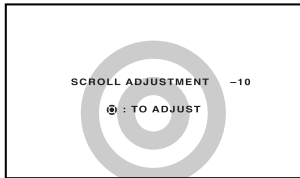

PIC SIZE

▲▼▶◀

MENU

### Note:

You can scroll the picture in TheaterWide 2 and TheaterWide 3 only. The scroll amounts are as follows:

- 480i/480p signal source:
  - Wide 1 : Not adjustable
  - Wide 2 : -10 to +20
  - Wide 3 : -10 to +20



## Selecting the cinema mode

When you view a DVD movie (3:2 pulldown processed) from a DVD player connected to the ColorStream (component video) inputs on the TV, smoother and more natural motion can be obtained by setting the CINEMA MODE to FILM.

### To set the CINEMA MODE to FILM:

1. Press MENU, and then press ◀ or ▶ until the SETUP menu appears.
2. Press ▲ or ▼ to highlight CINEMA MODE, and then press ◀ or ▶ to select FILM.

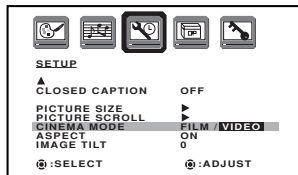

### To set the CINEMA MODE to VIDEO (off):

Press ◀ or ▶ to select VIDEO in step 2 above.

## Using the ASPECT feature

When the ASPECT feature is set to ON and the TV receives a 480i signal, the picture size is automatically selected (as described in the following table.)

Aspect ratio of signal source	Automatic aspect size (automatically selected when ASPECT is ON)
4:3 Normal	Natural
16:9 Full	Full
4:3 Letter box	TheaterWide 2
Not defined	User-set mode

If the signal does not include aspect information, the picture size you selected on pages 34 and 35 is displayed.

### To turn on the ASPECT feature:

1. Press MENU, and then press ◀ or ▶ until the SETUP menu appears.
2. Press ▲ or ▼ to highlight ASPECT, and then press ◀ or ▶ to select ON.

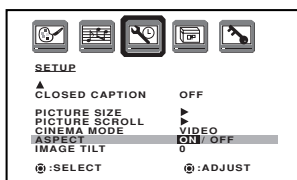

## Selecting the display format (for 480p signals only)

This feature converts a 480p input signal to 540p or 1080i.

### To select the display format:

1. Press MENU, and then press ◀ or ▶ until the PICTURE menu appears.
2. Press ▲ or ▼ to highlight DISPLAY FORMAT.
3. Press ◀ or ▶ to select 540p or 1080i.

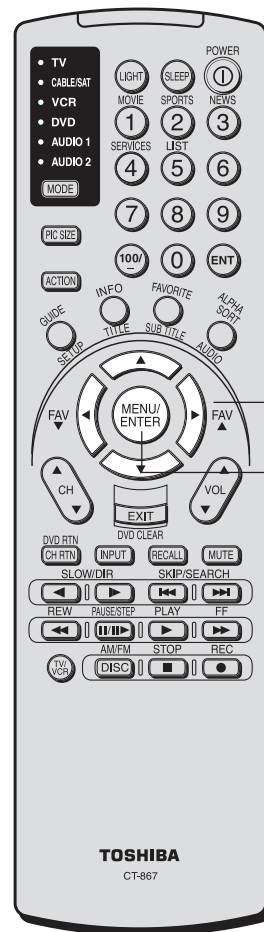
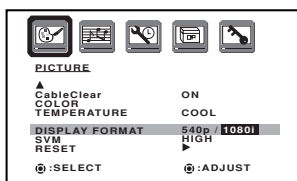

Important Safeguards

Welcome to Toshiba

Connecting your TV

Using the Remote Control

Setting up your TV

Using the TV's Features

Appendix

### Notes:

- The DISPLAY FORMAT feature is available only for 480p input. 1080i is always output when a signal other than 480p is input.
- If you notice flickering in a 480p image, try setting the DISPLAY FORMAT to 540p.



## Adjusting the picture

### Selecting the picture mode

You can select from four picture modes—Sports, Standard, Movie, and Memory—as described in the following table:

Mode	Picture Quality
SPORTS	Bright and dynamic picture (factory-set)
STANDARD	Standard picture quality (factory-set)
MOVIE	Movie-like picture setting (factory-set)
MEMORY	Your personal preferences (set by you; see “Adjusting the picture quality”)

#### To select the picture mode:

1. Press MENU, then press ◀ or ▶ to display the PICTURE menu.
2. Press ▲ or ▼ to highlight MODE.

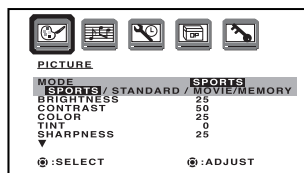

3. Press ◀ or ▶ to highlight the mode you prefer.
4. Press EXIT to return to normal viewing.

### Adjusting the picture quality

You can adjust the picture quality to your personal preferences, including the brightness, contrast, color, tint, and sharpness. The qualities you choose will be stored automatically in the PICTURE menu's MEMORY mode so you can recall them at any time.

#### To adjust the picture quality:

1. Press MENU, then press ◀ or ▶ to display the PICTURE menu.
2. Press ▲ or ▼ until the item you want to adjust is highlighted.

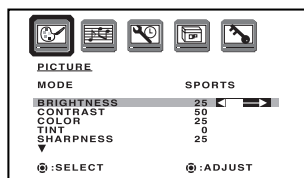

3. Press ◀ or ▶ to adjust the level.

Selection	◀ Pressing	▶
BRIGHTNESS	darker	lighter
CONTRAST	lower	higher
COLOR	paler	deeper
TINT	reddish	greenish
SHARPNESS	softer	sharper

4. Press EXIT to return to normal viewing.

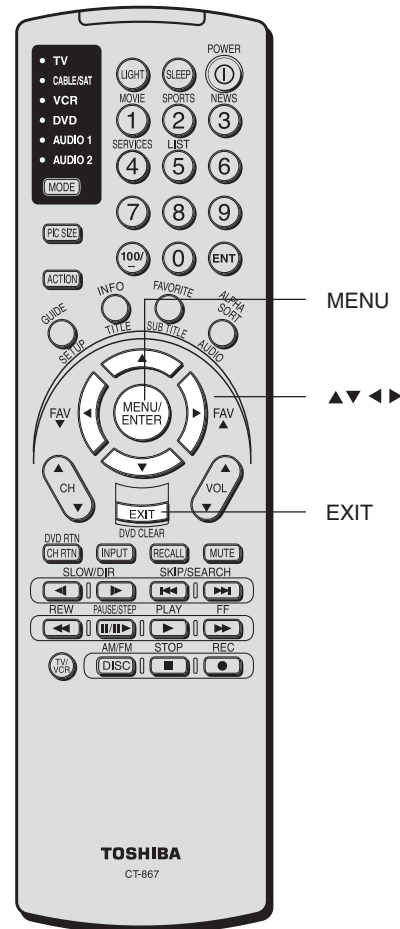



## Selecting the color temperature

Change the picture quality by selecting from three preset color temperatures—cool, medium, and warm—as described in the following table:

Mode	Picture Quality
COOL	Blueish
MEDIUM	Neutral
WARM	Reddish

### To select the color temperature:

1. Press MENU, then press ◀ or ▶ to display the PICTURE menu.
2. Press ▲ or ▼ to highlight COLOR TEMPERATURE.

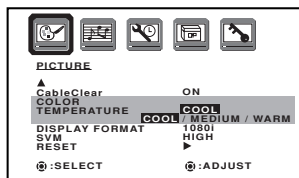

3. Press ◀ or ▶ to highlight the mode you prefer.
4. Press EXIT to return to normal viewing.

## Using the CableClear® feature

CableClear® reduces visible interference in your TV picture. This is useful when receiving a broadcast with a weak signal (especially a Cable channel) or playing a video cassette or disc damaged by repeated use.

### To turn on the CableClear® feature:

1. Press MENU, then press ◀ or ▶ to display the PICTURE menu.
2. Press ▲ or ▼ to highlight CableClear.

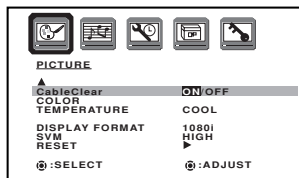

3. Press ◀ or ▶ to select ON.

### To turn off the CableClear® feature:

Select OFF in step 3.

## Selecting the Scan Velocity Modulation (SVM)

The SVM feature enhances picture contrast and sharpness. This feature has three modes: HIGH, LOW, and OFF.

### To select the SVM feature:

1. Press MENU, then press ◀ or ▶ to display the PICTURE menu.
2. Press ▲ or ▼ to highlight SVM.

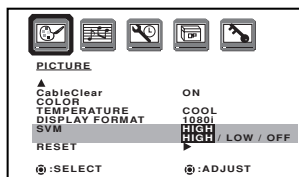

3. Press ◀ or ▶ to select the mode you prefer.

### To turn off the SVM:

Select OFF in step 3.

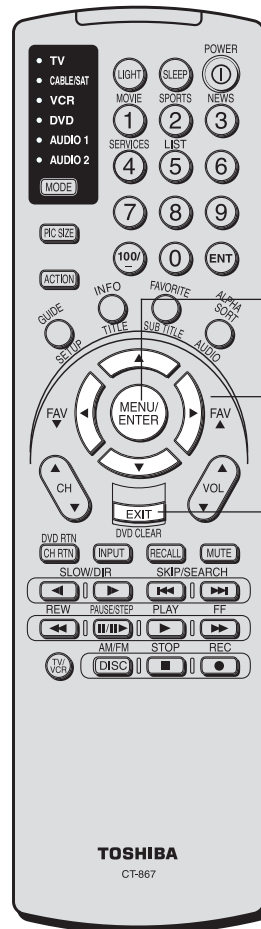

MENU

▲▼◀▶

EXIT

Important Safeguards

Welcome to Toshiba

Connecting your TV

Using the Remote Control

Setting up your TV

Using the TV's Features

Appendix



## Resetting your picture adjustments

The RESET function returns your picture quality adjustments to the following factory settings:

Mode .....	sports	Tint .....	center (0)
Brightness .....	center (25)	Sharpness .....	center (25)
Contrast .....	max (50)	Color temperature .....	cool
Color .....	center (25)	SVM .....	high

### To reset your picture adjustments:

1. Press MENU, then press ◀ or ▶ to display the PICTURE menu.
2. Press ▲ or ▼ to highlight RESET, and then press ▶.

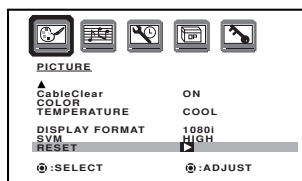

## Setting the sleep timer

You can use the sleep timer to automatically turn off the TV at a set time.

### To set the sleep timer:

Repeatedly press SLEEP on the remote control to set the length of time until the TV turns off. The clock will increase 10 minutes for each press of the SLEEP button (0h00m, 0h10m, ...1h50m, 2h00m.) After the sleep timer is programmed, the display will appear briefly every ten minutes to remind you that the sleep timer is operating.

### To confirm the sleep timer setting:

Press SLEEP one time. The remaining time will be momentarily displayed.

### To cancel the sleep timer:

Repeatedly press SLEEP until the display turns to 0h00m.

## Using the closed caption feature

The Closed Caption feature has two options:

- Captions—An on-screen display of the dialogue, narration, and sound effects of programs and videos that are closed-captioned (usually identified in your local TV listings as “CC”).
- Text—An on-screen display of information not related to the program, such as weather or stock data (if available in your viewing area).

### To view captions or text:

1. Tune the TV to the desired program.
2. Press MENU, and then press ◀ or ▶ to display the SETUP menu.
3. Press ▲ or ▼ to highlight CLOSED CAPTION.

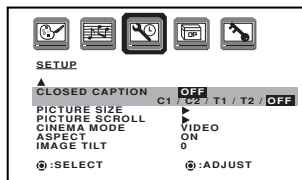

4. Press ◀ or ▶ to select the desired Closed Caption mode, as follows:
  - To view captions, select C1 or C2 (C1 displays translation of the primary language in your area.)  
Note: If the program or video you selected is not closed-captioned, no captions will display on-screen.
  - To view text, select T1 or T2. Note: If text is not available in your viewing area, a black rectangle may appear on-screen. If this happens, set the Closed Caption feature to OFF.
  - To turn the Closed Caption feature off, highlight OFF in the Closed Caption menu.

Using the TV's Features

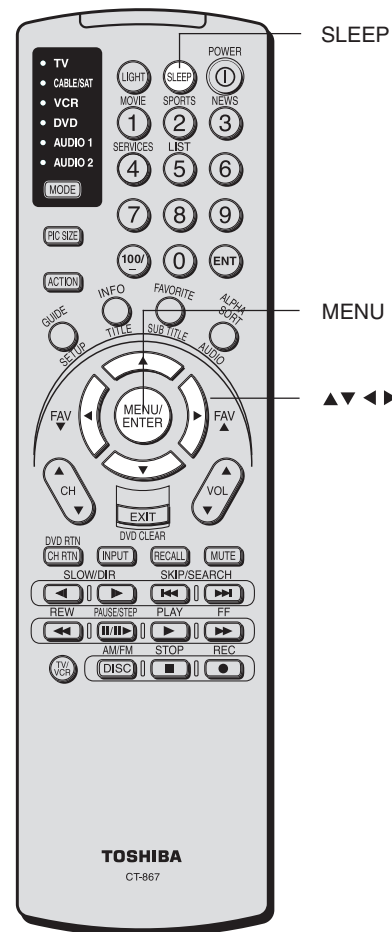

### Note:

A closed caption signal may not be decoded in the following situations:

- when a video tape has been dubbed
- when the signal reception is weak
- when the signal reception is non-standard

### NOTICE OF POSSIBLE ADVERSE EFFECTS ON TV PICTURE DISPLAY

Avoid displaying stationary images on your TV screen for extended periods of time. Fixed (non-moving) patterns or images (including but not limited to PIP/POP windows, closed captions, video game patterns, TV station logos, stock tickers, websites, and special formats that do not use the entire screen) can become permanently ingrained in the cathode ray tube(s) of the TV and cause subtle but permanent ghost images. **This type of damage is NOT COVERED BY YOUR WARRANTY.**





## Adjusting the sound

### Muting the sound

Press MUTE to temporarily turn off the sound. While the sound is off, the screen will display the word MUTE in the lower right-hand corner. To restore the sound, press MUTE again.

### Selecting stereo/SAP broadcasts

The multi-channel TV sound (MTS) feature provides high-fidelity stereo sound. MTS also can transmit a second audio program (SAP) containing a second language or other audio information (when available).

**Note:** The MTS feature is not available in VIDEO mode.

When the TV receives a stereo or SAP broadcast, the word "STEREO" or "SAP" displays on-screen every time you turn on the TV, change the channel, or press RECALL.

#### To listen to stereo sound:

1. Press MENU, then press ◀ or ▶ to display the AUDIO menu.
2. Press ▲ or ▼ to highlight MTS.
3. Press ◀ or ▶ to highlight STR (stereo).

**Note:**

- In general, you can leave your TV in stereo mode because the TV automatically outputs the type of sound being broadcast (stereo or mono.)
- If the stereo sound is noisy, select MONO to reduce the noise.

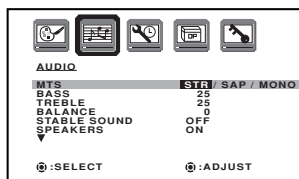

4. Press EXIT to return to normal viewing.

#### To listen to a second audio program (SAP):

1. Press MENU, then press ◀ or ▶ to display the AUDIO menu.
2. Press ▲ or ▼ to highlight MTS.
3. Press ◀ or ▶ to highlight SAP. The TV speakers will output the second audio program instead of normal audio.
4. Press EXIT to return to normal viewing.

### Adjusting the sound quality

You can change the sound quality of your TV by adjusting the bass, treble, and balance.

#### To adjust the sound quality:

1. Press MENU, then press ◀ or ▶ until the AUDIO menu appears.
2. Press ▲ or ▼ to highlight the item you want to adjust.

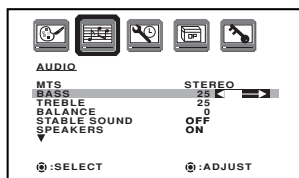

3. Press ◀ or ▶ to adjust the level.
  - ◀ makes the sound quality weaker or increases the balance in the left channel, depending on the item selected.
  - ▶ makes the sound quality stronger or increases the balance in the right channel, depending on the item selected.

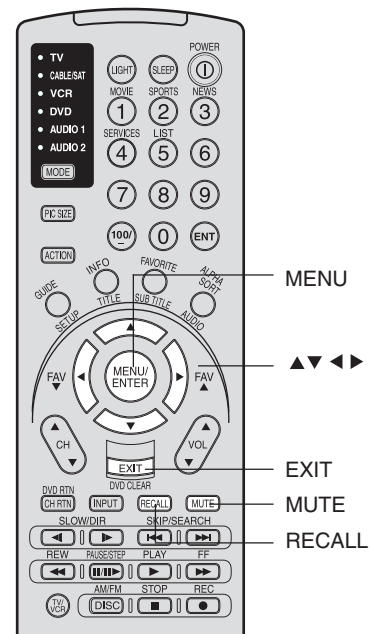

**Note:**

A second audio program (SAP) can be heard only on those TV stations that offer it.

For example, a station might broadcast music as a second audio program. If you have SAP on, you will see the current program on the screen but hear music instead of the program's normal audio.

However, if you have SAP on, and the station you are watching is not currently broadcasting a second audio program, the station's normal audio will be output; however, occasionally there is no sound at all in SAP mode. If this happens, set the MTS feature to STEREO mode.

Adjusting the sound quality (bass, treble, and balance) does not affect the sound that is output from the variable audio OUT jacks.

Important Safeguards

Welcome to Toshiba

Connecting your TV

Using the Remote Control

Setting up your TV

Using the TV's Features

Appendix

## Resetting your audio adjustments

The RESET function returns your audio adjustments to the following factory settings:

Bass ..... center (25)  
 Treble ..... center (25)  
 Balance ..... center (0)

### To reset your audio adjustments:

1. Press MENU, then press ◀ or ▶ to display the AUDIO menu.
2. Press ▲ or ▼ to highlight RESET, and then press ▶.

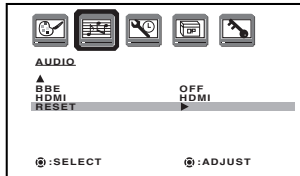

## Using the StableSound® feature

The StableSound feature limits the highest volume level to prevent extreme changes in volume when the signal source is changed.

### To turn on the StableSound® feature:

1. Press MENU, then press ◀ or ▶ to display the AUDIO menu.
2. Press ▲ or ▼ to highlight STABLE SOUND.
3. Press ◀ or ▶ to highlight ON.

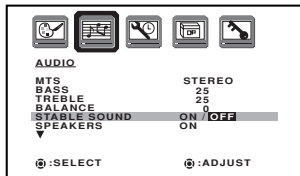

### To turn off the StableSound® feature:

Highlight OFF in step 3 above.

## Using the BBE sound feature

By correcting the phase delay and distortion naturally generated by speaker systems, the BBE sound feature ensures that the sound that reaches your ears is as natural as the original sound. Human voices are clearer and music is natural and well-defined.

### To turn on the BBE sound feature:

1. Press MENU, then press ◀ or ▶ until the AUDIO menu appears.
2. Press ▲ or ▼ to highlight BBE.
3. Press ◀ or ▶ to highlight ON.

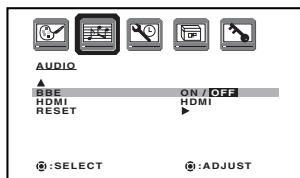

### To turn off the BBE sound feature:

Highlight OFF in step 3 above.

Licensed by BBE Sound, Inc., under USP5510752 and 5736897.  
 BBE and BBE symbol are registered trademarks of BBE Sound, Inc.

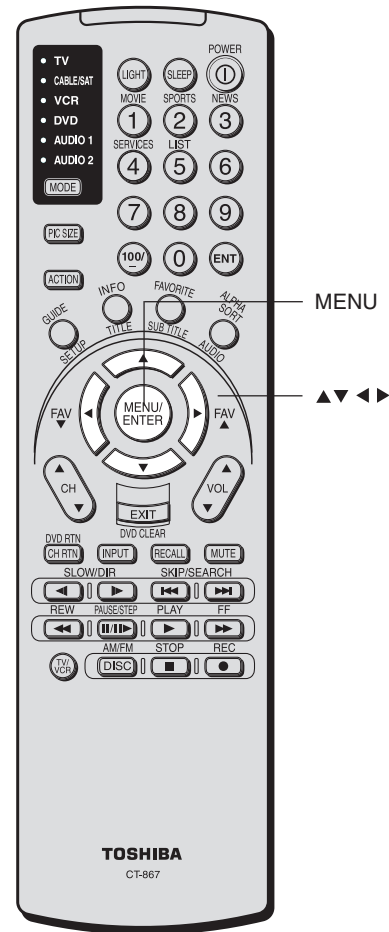

### Note:

Make sure the volume control of your audio amplifier is set to a moderate listening level.



## Turning off the built-in speakers

Use this feature to turn off the TV speakers when you connect an audio system (see “Connecting an audio system” on page 15).

### To turn off the built-in speakers:

1. Press MENU, then press ◀ or ▶ to display the AUDIO menu.
2. Press ▲ or ▼ to highlight SPEAKERS, and then press ◀ or ▶ to select OFF.



### To turn on the built-in speakers:

Select ON in step 2 above.

## Selecting the HDMI audio input source

See page 14 for details on connecting an HDMI or a DVI device to the TV's HDMI input.

If you connect a DVI device, to hear audio you must also connect the analog audio cables to the HDMI audio IN jacks (see page 14). Set the HDMI audio input setting to “DVI” with this connection.

If you connect an HDMI device and play media with digital audio output, to hear digital audio, set the HDMI audio input setting to “HDMI” with this connection.

If you connect an HDMI device but play media with analog audio output (for example, certain CDVs do not output digital audio), to hear audio you must also connect the analog audio cables to the HDMI audio IN jacks (see page 14). Set the HDMI audio input setting to “DVI” with this connection.

### To select the HDMI audio input source:

1. Press MENU, and then press ◀ or ▶ to display the AUDIO menu.
2. Press ▼ or ▲ to highlight HDMI.
3. Press ◀ or ▶ to select HDMI or DVI.

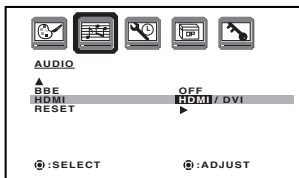

## Displaying TV status information on-screen

Press RECALL to display the following information on-screen:

- Clock
- Channel number or VIDEO mode selected
- Channel label (if set)
- Stereo or SAP (second audio program) audio status
- Content rating
- On timer, Sleep timer (if set)
- Picture size

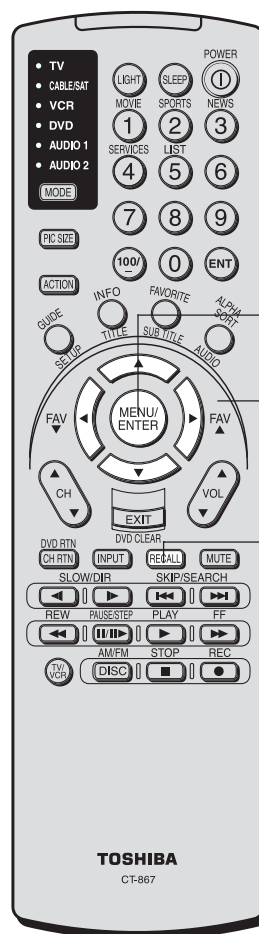
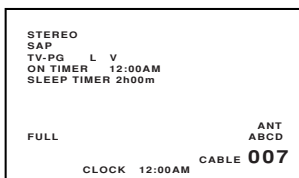

MENU

RECALL

Important Safeguards

Welcome to Toshiba

Connecting your TV

Using the Remote Control

Setting up your TV

Using the TV's Features

Appendix



## Auto power off

The TV will automatically turn off after approximately 15 minutes if it is tuned to a vacant channel or a station that completes its broadcast for the day and stops broadcasting on that channel. This feature does not work in VIDEO mode.

## Understanding the Power Return feature

If the power is cut off while you are viewing the TV and the power is resupplied, the Power Return feature will turn the TV on automatically.

If the power is going to be off for a long time or you are going to be away from the TV for a long time, unplug the power cord from the wall outlet to prevent the TV from turning on in your absence.

## Appendix Troubleshooting

Before calling a service technician, please check the following table for a possible cause of the symptom and some solutions.

Symptom	Solution
TV will not turn on	<ul style="list-style-type: none"> <li>Make sure the power cord is plugged in, then press POWER.</li> <li>The remote control batteries may be dead. Replace the batteries.</li> </ul>
No picture, no sound	<ul style="list-style-type: none"> <li>Check the antenna/cable connections.</li> </ul>
No sound, picture OK	<ul style="list-style-type: none"> <li>The sound may be muted. Press VOLUME.</li> <li>The station may have broadcast difficulties. Try another channel.</li> <li>The MTS feature may be in SAP mode. Select STR or MONO in the MTS menu.</li> </ul>
Poor sound, picture OK	<ul style="list-style-type: none"> <li>The station may have broadcast difficulties. Try another channel.</li> <li>The MTS feature may be in SAP mode. Select STR or MONO in the MTS menu.</li> </ul>
Poor picture, sound OK	<ul style="list-style-type: none"> <li>Check the antenna connections.</li> <li>The station may have broadcast difficulties. Try another channel.</li> <li>Adjust the PICTURE menu.</li> </ul>
Poor reception of broadcast channels	<ul style="list-style-type: none"> <li>The station may have broadcast difficulties. Try another channel.</li> <li>Check the antenna connections.</li> <li>If you are using a video input, make sure the TV/VIDEO button is set correctly.</li> </ul>
Cannot receive above channel 13	<ul style="list-style-type: none"> <li>Make sure the TV/CABLE feature in the SETUP menu is set to "CABLE."</li> </ul>
Unable to select a certain channel	<ul style="list-style-type: none"> <li>The channel may be blocked by the V-Chip feature or CH LOCK feature, or erased with the add/erase feature.</li> </ul>
Cannot access signal input sources (Video1, Video2, Video3, ColorStream HD1, ColorStream HD2, and HDMI) and/or Channels 3 and 4	<ul style="list-style-type: none"> <li>Check the VIDEO LOCK feature.</li> </ul>
Multiple images	<ul style="list-style-type: none"> <li>The station may have broadcast difficulties. Try another channel.</li> <li>Use a highly directional outdoor antenna.</li> </ul>
Poor color or no color	<ul style="list-style-type: none"> <li>The station may have broadcast difficulties. Try another channel.</li> <li>Adjust the TINT and/or COLOR in the PICTURE menu.</li> <li>If you change the direction of the TV while it is turned on, the picture could suffer from color shading. If so, turn off the TV and allow it to cool for several hours before turning it on again.</li> </ul>
Black box on screen	<ul style="list-style-type: none"> <li>Select OFF in the Closed Caption menu to turn off the Closed Caption Text mode.</li> </ul>
No stereo or SAP sound from a known MTS broadcast	<ul style="list-style-type: none"> <li>Make sure the MTS feature (in the AUDIO menu) is set properly.</li> </ul>
The V-Chip password does not work (U.S. V-Chip system only)	<ul style="list-style-type: none"> <li>Change or reset your password.</li> </ul>
The remote control does not operate	<ul style="list-style-type: none"> <li>Make sure the TV • CBL/SAT • VCR • DVD • AUDIO 1 • AUDIO 2 mode is set properly on the remote control.</li> <li>Remove all obstructions between the remote control and the TV.</li> <li>The remote control batteries may be dead. Replace the batteries.</li> </ul>
The front panel buttons do not operate	<ul style="list-style-type: none"> <li>Check the FRONT PANEL LOCK feature.</li> </ul>



## Specifications

- This model complies with the specifications below.
- Design and specifications are subject to change without notice.
- This model may not be compatible with features and/or specifications that may be added in the future.

	<b>30HFX85</b>
Picture Tube	30 in. (760 mm) diagonal (Screen size is approximate.)
Television system	NTSC standard
Channel coverage	VHF: 2–13 UHF: 14–69 Cable TV: 4A, A-5–A-1, A-I, J–W, W+1–W+84
Power source	120V AC, 60 Hz
Power consumption	185 W
Audio power	10 W + 10 W
Speaker type	1-13/16 x 3-7/8 in. (45.7 x 99.1 mm) x 2 pcs.
Video/Audio terminals	<p><b>S-VIDEO INPUT</b> Y-INPUT: 1V (p-p), 75 ohm, negative sync. C-INPUT: 0.286V (p-p) (burst signal), 75 ohm</p> <p><b>VIDEO/AUDIO INPUT</b> VIDEO: 1V (p-p), 75 ohm, negative sync. AUDIO: 150 mV (rms) (30% modulation equivalent, 47k ohm)</p> <p><b>ColorStream® (component video) INPUT</b> Y: 1V (p-p), 75 ohm PR: 0.7V (p-p), 75 ohm PB: 0.7V (p-p), 75 ohm</p> <p><b>VIDEO/AUDIO OUTPUT</b> VIDEO: 1V (p-p), 75 ohm, negative sync. AUDIO: 150 mV (rms) (30% modulation equivalent, 47k ohm)</p> <p><b>HDMI INPUT: HDMI compliant (type A connector)</b> HDCP compliant E-EDID compliant Suggested scan rates: 1080i, 480p, 480i, 720p HDMI Audio: 2-channel PCM 32/44.1/48 kHz sampling frequency 16/20/24 bits per sample</p>
Dimensions	Width: 31-5/16 in. (796 mm) Height: 21-5/8 in. (549.2 mm) Depth: 22-3/16 in. (563 mm)
Weight	111.4 lbs. (50.5 kg)
Supplied accessories	Remote control with two size "AA" batteries

Important  
Safeguards

Welcome to  
Toshiba

Connecting  
your TV

Using the  
Remote Control

Setting up  
your TV

Using the TV's  
Features

Appendix



## Limited United States Warranty

for all FST PURE® CRT-based TVs and Projection TVs, 26" and Larger

Toshiba America Consumer Products, L.L.C. ("TACP") makes the following limited warranties to original consumers in the United States. THESE LIMITED WARRANTIES EXTEND TO THE ORIGINAL CONSUMER PURCHASER OR ANY PERSON RECEIVING THIS TELEVISION AS A GIFT FROM THE ORIGINAL CONSUMER PURCHASER AND TO NO OTHER PURCHASER OR TRANSFEREE. TELEVISIONS PURCHASED IN THE U.S.A. AND USED ANYWHERE OUTSIDE OF THE U.S.A., INCLUDING, WITHOUT LIMITATION, CANADA AND MEXICO, ARE NOT COVERED BY THESE WARRANTIES.

TELEVISIONS PURCHASED ANYWHERE OUTSIDE OF THE U.S.A., INCLUDING, WITHOUT LIMITATION, CANADA AND MEXICO, AND USED IN THE U.S.A., ARE NOT COVERED BY THESE WARRANTIES.

### Limited One (1) Year Warranty on Parts and Labor

TACP warrants this television and its parts against defects in materials or workmanship for a period of one (1) year after the date of original retail purchase. DURING THIS PERIOD, TACP WILL, AT TACP'S OPTION, REPAIR OR REPLACE A DEFECTIVE PART WITH A NEW OR REFURBISHED PART WITHOUT CHARGE TO YOU FOR PARTS OR LABOR. During this period, TACP Authorized Service Station personnel will come to your home when warranty service is required. Depending on the type of repair required, the service will either be performed in your home or the television will be taken to a TACP Authorized Service Station for repair and returned to your home at no cost to you.

### Limited Two (2) Year Warranty on Picture Tube

TACP warrants the picture tube in this television against defects in materials or workmanship for a period of two (2) years after the date of original retail purchase. DURING THIS PERIOD, TACP WILL, AT TACP'S OPTION, REPAIR OR REPLACE A DEFECTIVE PICTURE TUBE WITH A NEW OR REFURBISHED PICTURE TUBE WITHOUT CHARGE TO YOU, PROVIDED THAT IF A DEFECTIVE PICTURE TUBE IS REPAIRED OR REPLACED AFTER ONE (1) YEAR AFTER THE DATE OF ORIGINAL RETAIL PURCHASE, YOU MUST PAY FOR ALL LABOR CHARGES IN CONNECTION WITH THE REPAIR OR REPLACEMENT THEREOF. During this period, TACP Authorized Service Station personnel will come to your home when warranty service is required. Depending on the type of repair required, the service will either be performed in your home or the television will be taken to a TACP Authorized Service Station for repair and returned to your home at no cost to you.

### Rental Units

The warranty for television rental units begins on the date of the first rental or thirty (30) days after the date of shipment to the rental firm, whichever comes first.

### Limited Warranty for Commercial Units

TACP warrants televisions that are sold and used for commercial purposes as follows: all parts are warranted against defects in materials or workmanship for a period of ninety (90) days after the date of original retail purchase. DURING THIS PERIOD, TACP WILL, AT TACP'S OPTION, REPAIR OR REPLACE A DEFECTIVE PART WITH A NEW OR REFURBISHED PART WITHOUT CHARGE TO YOU.

### Owner's Manual and Product Registration Card

Read this owner's manual thoroughly before operating this television.

Complete and mail the enclosed product registration card or register your television online at [www.tacp.toshiba.com/service](http://www.tacp.toshiba.com/service) as soon as possible. By registering your television you will enable TACP to bring you new products specifically designed to meet your needs and help us to contact you in the unlikely event a safety notification is required under the U.S. Consumer Product Safety Act. Failure to complete and return the product registration card does not diminish your warranty rights.

### Your Responsibility

THE ABOVE WARRANTIES ARE SUBJECT TO THE FOLLOWING CONDITIONS:

- (1) You must retain your original bill of sale or provide other proof of purchase.
- (2) All warranty servicing of this television must be performed by a TACP Authorized Service Station.
- (3) The warranties from TACP are effective only if this television is purchased and operated in the Continental U.S.A. or Puerto Rico.
- (4) Labor service charges for set installation, setup, adjustment of customer controls, and installation or repair of antenna systems are not covered by this warranty. Reception problems caused by inadequate antenna systems, misaligned satellite dishes, cable television distribution, VCRs, DVD players/recorders, personal computer level IEEE-1394 devices, and any other connected signal source device are your responsibility.
- (5) Warranties extend only to defects in materials or workmanship as limited above, and do not extend to any television or parts that have been lost or discarded by you or to damage to the television or parts caused by fires, misuse, accident, Acts of God (such as lightning or fluctuations in electric power), improper installation, improper maintenance, or use in violation of instructions furnished by TACP; use or malfunction through simultaneous use of this television and connected equipment; or to units that have been modified or had the serial number removed, altered, defaced, or rendered illegible.

### How to Obtain Warranty Service

If, after following all of the operating instructions in this manual and reviewing the section entitled "Troubleshooting," you find that service is needed:

- (1) To find the nearest TACP Authorized Service Station, visit TACP's website at [www.tacp.toshiba.com/service](http://www.tacp.toshiba.com/service) or contact TACP's Consumer Solution Center toll free at 1-800-631-3811.
- (2) You must present your original bill of sale or other proof of purchase to the TACP Authorized Service Station.

For additional information, visit TACP's website:  
[www.tacp.toshiba.com](http://www.tacp.toshiba.com)

ALL WARRANTIES IMPLIED BY THE LAW OF ANY STATE OF THE U.S.A., INCLUDING THE IMPLIED WARRANTIES OF MERCHANTABILITY AND FITNESS FOR A PARTICULAR PURPOSE, ARE EXPRESSLY LIMITED TO THE DURATION OF THE LIMITED WARRANTIES SET FORTH ABOVE. WITH THE EXCEPTION OF ANY WARRANTIES IMPLIED BY THE LAW OF ANY STATE OF THE U.S.A. AS HEREBY LIMITED, THE FOREGOING WARRANTY IS EXCLUSIVE AND IN LIEU OF ALL OTHER WARRANTIES, GUARANTEES, AGREEMENTS, AND SIMILAR OBLIGATIONS OF TACP WITH RESPECT TO THE REPAIR OR REPLACEMENT OF ANY PARTS. IN NO EVENT SHALL TACP BE LIABLE FOR CONSEQUENTIAL OR INCIDENTAL DAMAGES (INCLUDING, BUT NOT LIMITED TO, LOST PROFITS, BUSINESS INTERRUPTION, OR MODIFICATION OR ERASURE OF RECORDED DATA CAUSED BY USE, MISUSE, OR INABILITY TO USE THIS TELEVISION).

No person, agent, distributor, dealer, or company is authorized to change, modify, or extend the terms of these warranties in any manner whatsoever. The time within which an action must be commenced to enforce any obligation of TACP arising under the warranty or under any statute or law of the United States or any state thereof is hereby limited to ninety (90) days from the date you discover, or should have discovered, the defect. This limitation does not apply to implied warranties arising under the law of any state of the U.S.A. THIS WARRANTY GIVES YOU SPECIFIC LEGAL RIGHTS AND YOU MAY ALSO HAVE OTHER RIGHTS WHICH MAY VARY FROM STATE TO STATE IN THE U.S.A. SOME STATES OF THE U.S.A. DO NOT ALLOW LIMITATIONS ON THE DURATION OF AN IMPLIED WARRANTY, WHEN AN ACTION MAY BE BROUGHT, OR THE EXCLUSION OR LIMITATION OF INCIDENTAL OR CONSEQUENTIAL DAMAGES. THEREFORE, THE ABOVE PROVISIONS MAY NOT APPLY TO YOU UNDER SUCH CIRCUMSTANCES. [0305]



# MEMO

---





**TOSHIBA AMERICA CONSUMER PRODUCTS, L.L.C.**

**Head Office**

82 Totowa Road, Wayne, NJ 07470

**National Service Division**

1420B Toshiba Drive, Lebanon, TN 37087

Cinema Series, CableClear, ColorStream, FST Pure, TheaterWide, and StableSound are registered trademarks of Toshiba America Consumer Products, L.L.C.  
GameTimer is a trademark of Toshiba America Consumer Products, L.L.C.

**TOSHIBA**

PRINTED IN THAILAND





## Free Manuals Download Website

<http://myh66.com>

<http://usermanuals.us>

<http://www.somanuals.com>

<http://www.4manuals.cc>

<http://www.manual-lib.com>

<http://www.404manual.com>

<http://www.luxmanual.com>

<http://aubethermostatmanual.com>

Golf course search by state

<http://golfingnear.com>

Email search by domain

<http://emailbydomain.com>

Auto manuals search

<http://auto.somanuals.com>

TV manuals search

<http://tv.somanuals.com>