

TOSHIBA



Color Television

CN36V51

Owner's Manual

Index

Appendix

Using the TV's
Features

Setting up
your TV

Using the
Remote Control

Connecting
your TV

Welcome to
Toshiba

SAFETY PRECAUTIONS

WARNING

TO REDUCE THE RISK OF FIRE OR ELECTRIC SHOCK, DO NOT EXPOSE THIS APPLIANCE TO RAIN OR MOISTURE.



The lightning symbol in the triangle tells you that the voltage inside this product may be strong enough to cause an electric shock. **DO NOT TRY TO SERVICE THIS PRODUCT YOURSELF.**



The exclamation mark in the triangle tells you that important operating and maintenance instructions follow this symbol.

CAUTIONS

TO PREVENT ELECTRIC SHOCK, DO NOT USE THIS POLARIZED PLUG WITH AN EXTENSION CORD RECEPTACLE OR OTHER OUTLET UNLESS THE PRONGS CAN BE FULLY INSERTED INTO THE OUTLET TO PREVENT ANY EXPOSURE OF THE PRONGS ON THE POLARIZED PLUG.

PRECAUCIONES

PARA EVITAR DESCARGAS ELÉCTRICAS, NO UTILICE ESTE ENCHUFE POLARIZADO CON UN RECEPTÁCULO DE CABLE DE EXTENSIÓN U OTRA TOMA SALVO QUE LA CLAVIJA ESTÉ COMPLETAMENTE INSERTADA EN LA TOMA PARA EVITAR CUALQUIER EXPOSICIÓN DE LOS VÁSTAGOS DEL ENCHUFE POLARIZADO.

WARNING

To avoid personal injury:

- Do not stand or climb on the TV.
- Do not put a VCR or any heavy object on top of the TV.

ADVERTENCIA

Para evitar daños personales:

- No se ponga de pie en el TV ni suba a él.
- No coloque el video (p. ej. VCR) ni otro objeto pesado en la parte superior del TV.

Avoid displaying stationary images on your TV screen for extended periods of time. Stationary patterns generated by a picture-in-picture (PIP) display, computer displays, video games, stock market reports, etc., can become permanently engrained on the picture tube. This damage is not protected by your warranty because it is the result of misuse. If you wish to use your TV to display still images, reduce brightness and contrast settings. Never leave a PIP, computer, or video game display unattended.

This TV set may be used with the Toshiba stand listed on page 31. Use with other stands may result in instability, causing possible injury.

Note to CATV system installers in the USA

This reminder is provided to call the CATV system installer's attention to Article 820-40 of the NEC, which provides guidelines for proper grounding, and, in particular, specifies that the cable ground shall be connected to the grounding system of the building, as close to the point of cable entry as practical.

IMPORTANT SAFETY INSTRUCTIONS

INSTRUCCIONES DE SEGURIDAD

CAUTION

PLEASE READ AND OBSERVE ALL WARNINGS AND INSTRUCTIONS CONTAINED IN THIS SECTION AND THOSE ON YOUR TV SET.

RETAIN THIS SECTION FOR REFERENCE.

PRECAUCIÓN

LEA Y TENGA EN CUENTA TODAS LAS ADVERTENCIAS E INSTRUCCIONES QUE SE ENCUENTRAN EN ESTE PANFLETO Y LAS DE LOS APARATOS DE TELEVISIÓN.

MANTENGA ESTE PANFLETO PARA FUTURAS REFERENCIAS.

Electrical energy can perform many useful functions. This TV set has been engineered and manufactured to assure your personal safety. However, improper use can result in potential electrical shock or fire hazards. In order not to defeat the safeguards incorporated in this TV set, observe the following basic rules for antenna/TV installation, use and servicing.

Do not remove the cabinet cover. This may expose you to dangerous voltages. Refer all servicing to qualified service personnel.

La energía eléctrica puede realizar funciones muy útiles. Este televisor ha sido diseñado y fabricado para asegurar su seguridad personal. Sin embargo, la utilización inadecuada del mismo puede resultar en descargas eléctricas o en el riesgo de incendios. Para no anular las protecciones incorporadas en este televisor, tenga en cuenta las reglas básicas de instalación de la antena/televisor, y en caso de problemas póngase en contacto con un centro de reparaciones.

No extraiga de la cubierta de la caja. Esto podría dejarle expuesto a tensiones peligrosas. En caso de avería, consulte los servicios de personal cualificado.

INSTALLATION / INSTALACIÓN

Power Sources — The TV set should be operated only from the type of power source indicated on the TV set or as indicated in the Owner's Manual. If you are not sure of the type of power supply in your home, consult your sales person or your local power company. For TV sets designed to operate from battery power, refer to the operating instructions.

Fuentes de alimentación — Este televisor solamente deberá alimentarse con la fuente de alimentación indicada en la etiqueta de características. Si no está seguro del tipo de fuente de alimentación de su hogar, consulte al proveedor de su televisor o a la compañía eléctrica local. Para productos destinados a alimentarse con pilas, u otras fuentes, consulte las instrucciones de operación.

Grounding or Polarization — The TV set is equipped with one of the following type plugs. If the plug should fail to fit the power outlet, contact your electrician to replace your obsolete outlet. **DO NOT** defeat the safety purpose of the type plug on the TV set.

Puesta a tierra o polarización — Este televisor puede poseer un enchufe de los tipos siguientes. Si el enchufe no entra en la toma de la red, póngase en contacto con un electricista para que le cambie la toma anticuada. **NO** anule el fin de seguridad de sete tipo de enchufe del televisor.

A polarized alternating current line plug — having one blade wider than the other. This plug will fit into the power outlet only one way. If you are unable to insert the plug into the outlet, try reversing the plug.

Un enchufe de línea de corriente alterna polarizado — posee una cuchilla más ancha que la otra. Este enchufe entrará en la toma de la red de una sola forma. Si no puede insertar el enchufe en la toma de la red, trate de invertirlo.

Alternate Warnings — A three-wire grounding-type plug — a plug having a third (grounding) pin. This plug will only fit into grounding-type power outlet.

Advertencias alternativas — Enchufe de tipo puesta a tierra de tres conductores — enchufe que posee un tercer terminal (de puesta a tierra). Este enchufe solamente encajará en una toma de la red de tipo puesta a tierra.

Water and Moisture — Do not use the TV set near water — for example, near a bath tub, wash bowl, kitchen sink, or laundry tub; in a wet basement; or near a swimming pool; and the like.

Agua y humedad — No utilice el televisor cerca del agua — por ejemplo, cerca de una bañera, un lavabo, un fregadero, una lavadora, en un sótano húmedo, cerca de una piscina, ni lugares por el estilo.

Ventilation — The slots and openings in the cabinet and in the back or bottom are provided for necessary ventilation. Never block or cover these slots and openings to ensure reliable operation of the TV set and to protect it from overheating.

Ventilación — Las ranuras y aberturas de la caja y de la parte posterior o de la base son para proporcionar la ventilación necesaria. Para asegurar la operación fiable del televisor para protegerlo contra el recalentamiento. No bloquee ni cubra nunca estas ranuras y aberturas.

- a. Never cover the slots and openings with a cloth or other materials.
- a. No cubra nunca las ranuras ni las aberturas con paños ni otros materiales.
- b. Never block the slots and openings by placing the TV set on a bed, sofa, rug or other similar surface.
- b. No bloquee nunca las ranuras ni las aberturas colocando el televisor sobre una cama, un sofá, una alfombra, ni demás superficies similares.
- c. Never place the TV set in a confined space such as a bookcase, built-in cabinet, or any other place of poor ventilation.
- c. No coloque nunca el televisor en un espacio cubierto, como una librería o un estante empotrados, ni en un lugar de mala ventilación.

Heat — Do not place the TV set near or over a radiator or heat register, or where it is exposed to direct sunlight.

Calor — No coloque el televisor cerca ni sobre un radiador ni un registro de calor, ni expuesto a la luz solar directa.

Power-Cord Protection — Do not allow anything to rest on or roll over the power cord, and do not place the TV set where the power cord is subject to wear or abuse.

Protección del cable de alimentación — No coloque ni pase sobre el cable de alimentación, ni coloque el televisor donde su cable de alimentación pueda sufrir cualquier tipo de daños.

Accessories — Do not place the TV set on an unstable cart, stand, tripod, bracket, or table. The TV set may fall, causing serious injury to a child or adult, and serious damage to the TV set. Use only with a cart, stand, tripod, bracket, or table recommended by the manufacturer, or sold with the TV set, and should use a mounting accessory recommended by the manufacturer.

Accesorios — No coloque el televisor sobre un carrito, una base, un trípode, un soporte ni una mesa inestable. El televisor podría caerse, causando serios daños a niños o adultos, o al propio televisor. Utilice solamente el carrito, la base, el trípode, el soporte, o la mesa que recomiende el fabricante, o que se venda con el televisor, y utilice un accesorio de montaje recomendado por el fabricante.

A product and cart combination should be moved with care. Quick stops, excessive force, and uneven surfaces may cause the product and cart combination to overturn.

La combinación de un producto y un carrito deberá moverse con cuidado. Las paradas repentinas, la fuerza excesiva, y las superficies desiguales pondrían hacer que volcarse la combinación del carrito y del producto.



USE / UTILIZACIÓN

Overloading — Do not overload wall outlets, extension cords or convenience receptacles beyond their capacity, since this can result in fire or electric shock.

Sobrecarga — No sobrecargue las tomas de la red, los cables prolongadores, ni los adaptadores para múltiples tomas, ya que esto supondría el riesgo de incendios o de descargas eléctricas.

During lightning storms, or when the TV set will be left unattended and unused for a long period of time, unplug the power cord from the wall outlet and disconnect the antenna or cable system. This will prevent damage to the TV set due to lightning and power-line surges.

Durante tormentas eléctricas, o cuando no vaya a utilizar el televisor durante mucho tiempo, desenchufe el cable de alimentación de la toma de la red y desconecte la antena o el sistema de cablevisión. Esto evitará que se dañe el televisor debido a rayos y a sobretensiones repentinas en la red.

Object and Liquid Entry — Never push objects of any kind into the TV set through the cabinet slots as they may touch dangerous voltage points or short out parts that could result in a fire or electric shock. Never spill liquid of any kind on the TV set.

Entrada de objetos y líquidos — No introduzca nunca objetos de ningún tipo en este televisor a través de las aberturas, ya que podrían tocar puntos de tensión peligrosa o cortocircuitar piezas, lo que podría resultar en incendio o descarga eléctrica. No vierta nunca líquidos de ningún tipo sobre este televisor.

Cleaning — Unplug the TV set from the wall outlet before cleaning or polishing it. Do not use liquid cleaners or aerosol cleaners. Use a cloth lightly dampened with water for cleaning the exterior of the TV set.

Limpieza — Desenchufe el televisor de la toma de la red antes de limpiarlo. No utilice limpiadores líquidos ni aerosoles. Para limpiar el exterior del televisor, utilice un paño ligeramente humedecido en agua.

Attachments — Never add accessories that have not been specifically designed for the TV set. Never remodel the TV set by yourself as this can result in a fire hazard or electric shock.

Aditamentos — No utilice aditamentos no recomendados por el fabricante del televisor, ya que podrían suponer un peligro. No remodele nunca el televisor usted mismo, ya que esto podría causar el riesgo de incendios o descargas eléctricas.

If a snapping or popping sound from a TV set is heard continuously or frequently while the TV set is operated, unplug the TV set and consult your dealer or service technician. It is normal for some TV sets to make occasional snapping or popping sounds, particularly when being turned on or off.

Si se oye un sonido seco de un televisor continuo o frecuente mientras el televisor esté funcionando, desenchúfelo y consulte a su proveedor o a un técnico de servicio. Es normal que algunos televisores produzcan sonidos secos, particularmente cuando conecte o desconecte su alimentación.

SERVICE / SERVICIO DE REPARACIÓN

Damage Requiring Service — Unplug the TV set from the wall outlet and refer servicing to qualified service personnel under the following conditions:

Daños que requieren el servicio de reparación — En los casos siguientes, desenchufe el televisor de la toma de la red y solicite los servicios de personal de reparación especializado:

- a. When the power cord or plug is damaged or frayed.
- a. Cuando se haya dañado el cable de alimentación o el enchufe.
- b. When liquid has been spilled into the TV set.
- b. Cuando se haya vertido líquido dentro del televisor.
- c. When the TV set has been exposed to rain or water.
- c. Cuando el televisor haya estado expuesto a la lluvia o al agua.
- d. When the TV set has been subject to excessive shock by being dropped, or the cabinet has been damaged.
- d. Cuando el televisor haya estado expuesto a golpes excesivos o haya caído, o su caja se haya dañado.
- e. When the TV set does not operate normally even though you follow the operating instructions. Adjust only those controls that are specified in the operating instructions. Improper adjustment of other controls may result in damage and will often require extensive work by a qualified technician to restore the TV set to normal operation.

When the TV set exhibits a distinct change in performance. This indicates a need for service.

- e. Cuando el televisor no funcione normalmente incluso al seguir las instrucciones de operación. Ajuste solamente los controles indicados en las instrucciones de operación, ya que un ajuste inadecuado de otros controles podría resultar en daños y a menudo requerirán un trabajo difícil por un técnico cualificado para devolver el televisor a su funcionamiento normal.

Quando el funcionamiento del televisor haya cambiado notablemente — esto indica la necesidad del servicio de reparación.

Service — Do not attempt to service the TV set yourself. To open or remove the covers may expose you to dangerous voltage or other hazards. Refer all servicing to qualified service personnel.

Reparación — No intente nunca reparar el televisor por sí mismo. La apertura o extracción de cubiertas podría exponerle a tensiones peligrosas u otros peligros. En caso de avería solicite los servicios de personal de reparación cualificado.

Replacement Parts — When replacement parts are required, be sure the service technician certifies in writing that he has used replacement parts specified by the manufacturer that have the same characteristics as the original parts. Unauthorized substitutions may result in fire, electric shock, or other hazards.

Reemplazo de piezas — Cuando sea necesario reemplazar piezas, cerciórese de que el técnico de reparación utilice las piezas de reemplazo especificadas por el fabricante u otras que posean las mismas características que las originales. Las substituciones no autorizadas podrían resultar en incendios, descargas eléctricas, u otros peligros.

Safety Check — Upon completion of any service or repairs to the TV set, ask the service technician to perform routine safety checks (as specified by the manufacturer) to determine that the TV set is in safe operating condition, and to so certify.

Comprobación de seguridad — Al finalizar cualquier reparación de este televisor, solicite al técnico de reparación que realice las comprobaciones de seguridad (especificadas por el fabricante) para determinar y certificar si el producto se encuentra en las condiciones de operación apropiadas.

When the TV set reaches the end of its useful life, improper disposal could result in a picture tube implosion. Ask a qualified service technician to dispose of the TV set.

Quando el televisor llegue al final de su vida útil, si se deshace de él de forma inapropiada, el tubo de imagen puede explotar. Cuando desee deshacerse de un televisor, solicite este servicio a un técnico de reparación especializado.

ANTENNA / ANTENA

Outdoor Antenna Grounding — If an outdoor antenna is installed, follow the precautions below.

An outdoor antenna system should not be located in the vicinity of overhead power lines or other electric light or power circuits, or where it can come in contact with such power lines or circuits.

WHEN INSTALLING AN OUTDOOR ANTENNA SYSTEM, EXTREME CARE SHOULD BE TAKEN TO KEEP FROM CONTACTING SUCH POWER LINES OR CIRCUITS AS CONTACT WITH THEM IS ALMOST INVARIABLY FATAL.

Be sure the antenna system is grounded so as to provide some protection against voltage surges and built-up static charges. Section 810 of the National Electrical Code in the USA and Section 54 of the Canadian Electrical Code in Canada provides information with respect to proper grounding of the mast and supporting structure, grounding of the lead-in wire to an antenna discharge unit, size of grounding conductors, location of antenna discharge unit, connection to grounding electrodes, and requirements for the grounding electrode.

Puesta a tierra de la antena exterior — Cuando instale una antena exterior, tenga en cuenta las precauciones siguientes.

Un sistema de antena exterior no deberá colocarse cerca de líneas de alta tensión ni otros circuitos de iluminación o alimentación, ni donde pueda entrar en contacto con tales líneas o circuitos.

CUANDO INSTALE UN SISTEMA DE ANTENA EXTERIOR, TENGA EXTREMADO CUIDADO PARA EVITAR QUE ENTRE EN CONTACTO CON TALES LÍNEAS DE ALIMENTACIÓN O CIRCUITOS, YA QUE TAL CONTACTO PODRÍA RESULTAR INVARIABLEMENTE FATAL.

Cerciórese de que el sistema de antena esté puesto a tierra a fin de que proporcione cierta protección contra sobretensiones y cargas estáticas. La Sección 810 del Código Eléctrico Nacional (NEC) de EE.UU. y la Sección 54 del Código Eléctrico Canadiense ofrecen información con respecto a la puesta a tierra adecuada de una unidad de descarga de antena, el tamaño de los conductores de puesta a tierra, la ubicación de la unidad de descarga de la antena, la conexión de los electrodos de puesta a tierra, y los requisitos de tales electrodos.

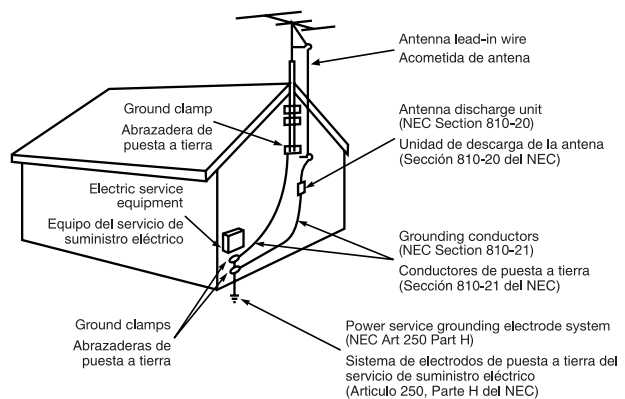

Welcome to Toshiba	1
Exploring your new TV	1
Selecting a location for the TV	1
Connecting your TV	2
Connecting a VCR.....	2
Connecting a cable converter box	3
Connecting a cable converter box and a VCR	3
Connecting a DVD/satellite receiver and a VCR	4
Connecting a DVD with ColorStream™ and a VCR	4
Connecting two VCRs	5
Connecting a camcorder	6
Connecting an audio amplifier	6
Using the remote control	7
Preparing the remote control for use	7
Installing the remote control batteries	7
Using the remote control with a VCR or a cable TV converter	7
Programming the remote control for use with a VCR or a cable TV converter	8
VCR code table	9
Cable TV converter code table	9
Learning about the remote control	11
Setting up your TV	12
Changing the on-screen display language	12
Using the TV/VIDEO button	12
Adding channels to the TV's memory	13
Programming channels automatically	13
Adding and erasing channels manually	13
Changing channels	14
Using the TV's features	15
Adjusting the channel settings	15
Switching between two channels	15
Programming your favorite channels	15
Using the V-Chip	16
Selecting a PIN code	16
Blocking programs by ratings	17
Blocking unrated movies or programs	20
Blocking channels	20
Labeling channels	21

Watching picture-in-picture (PIP)	22
Switching the main and small pictures	23
Changing the position of the small picture	23
Freezing the small picture	23
Adjusting the picture	24
Adjusting the picture quality	24
Selecting the color temperature	24
Adjusting the picture preferences	24
Watching video input	25
Displaying on-screen information	25
Setting the off-timer	25
Auto power off	25
Using the closed caption feature	26
Adjusting the sound	27
Muting the sound	27
Selecting stereo/SAP broadcasts	27
Adjusting the sound quality	28
Using the surround sound feature	28
Viewing the demonstration mode	29
Understanding the last mode memory feature	29
Appendix	30
Cleaning and care	30
Troubleshooting	30
Specifications	31
Limited United States warranty	32
Attention Canadian customers	33
Index	34

Welcome to Toshiba

Congratulations! You have purchased one of the finest color TVs on the market. The goal of this manual is to guide you through setting up and operating your Toshiba TV as quickly as possible. Please make sure you've received the following items: TV, remote control, batteries, manual, registration card, and extended service plan literature. If you did not receive all of the items, or any of the items are damaged or broken, please contact your Toshiba dealer. In addition, you may need to purchase other audio or video cables to connect your equipment. See "Connecting your TV" on page 2 for more information.

Please read all the safety and operating instructions carefully before you begin.

Exploring your new TV

You can operate your TV by using the buttons on the front panel or the remote control. The back panel provides all the terminal connections you will need to connect other equipment to your TV.

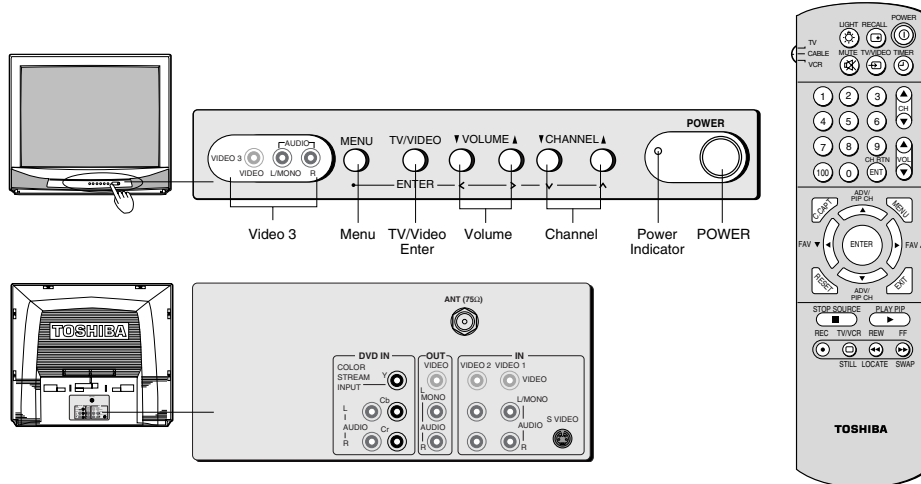

Selecting a location for the TV

- Place the TV on the floor or on a sturdy platform in a location where light does not directly hit the screen.
- Place the TV far enough from the walls to allow proper ventilation. Inadequate ventilation may cause overheating, which may damage the TV.

The model number and serial number are on the back of your TV. Record these numbers in the spaces below. Refer to these numbers whenever you communicate with your Toshiba dealer about this TV.

Model number: CN36V51

Serial number: _____

Caution:

The plug has one prong wider than the other and will fit only one way into a standard electrical outlet (120 volt AC, 60 Hz). If the plug does not fit into the outlet, try turning it around. If the plug still does not fit, the outlet is probably non-standard and must be replaced by a qualified electrician. **Do not tamper with the plug or try to force it into a non-standard outlet.**

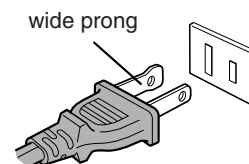

Connecting your TV

If you haven't connected electronic equipment before, or you have been frustrated by it in the past, you may wish to read this section. (Cables, switches and splitters are not supplied.)

- A coaxial cable is the standard cable that comes in from your antenna or cable converter box. Coaxial cables use "F" connectors.
- Audio and video cables are usually color coded according to use: yellow for video and red and white for audio. The red audio cable is for the stereo right channel, and the white audio cable is for the stereo (or mono) left channel. If you look at the rear panel of the TV, you will see that the terminals are color coded in the same manner as the cables.
- S-video cables provide better picture performance. S-video cables can only be used with S-video compatible components.
- ColorStream™ cables come in sets of three and provide the best picture performance. ColorStream cables can only be used with ColorStream compatible components.

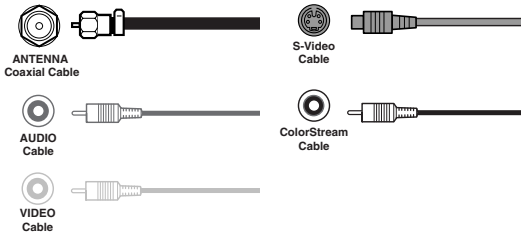

Caution:

Do not plug the TV in until you have finished connecting all of your equipment.

Connecting a VCR

This connection allows you to watch local channels and video programs, play or record on the VCR while watching TV, and to record from one channel while watching another channel.

You will need:

- one coaxial cable
- one pair of audio cables (only one cable for a mono VCR)
- one video cable

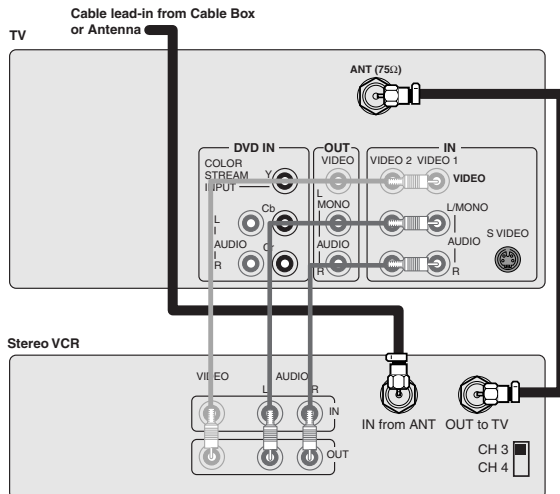

Caution:

If using a mono VCR, connect L/Mono to VCR Audio OUT using only one audio cable. If you have a S-VHS VCR, use the S-video connections and remove the video cable.

Do not connect the video cable and the S-video cable to Video-1 simultaneously.

Connecting a cable converter box

This connection allows you to watch cable and premium channels. You should place the A/B switch in the “A” position so that you can use the TV features. When viewing premium channels, switch to “B” and tune the TV to channel 3 or 4 (whichever channel is vacant in your area), then use the converter box to change channels.

You will need:

- one two-way signal splitter
- one A/B switch
- four coaxial cables

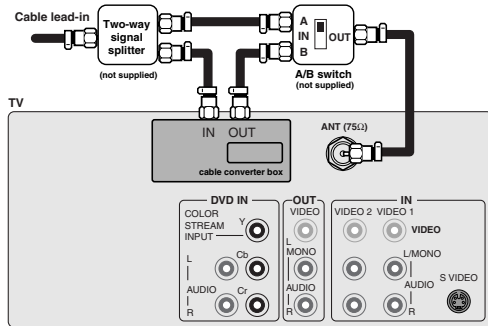

Note:

When you use a converter box with your TV, there may be features that you cannot program using the remote control, such as labeling channels, blocking channels, and programming your favorite channels.

Connecting a cable converter box and a VCR

This connection allows you to watch and record basic and premium cable channels, as well as watch videotapes. You should keep your TV selected to TV so that you can use the TV's features. When viewing premium channels or recording with the VCR, select Video-1, turn on the VCR and set the channel to 3 or 4 (whichever channel is vacant in your area), then use the cable converter box to change channels. To watch a basic cable channel while recording with the VCR, the TV should be left in TV mode.

You will need:

- one two-way splitter
- three coaxial cables
- one pair of audio cables (only one cable for a mono VCR)
- one video cable

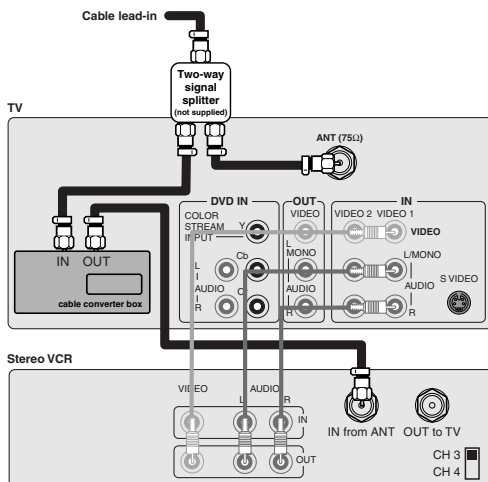

Caution:

If you have a mono VCR, connect L/Mono to VCR Audio OUT using only one audio cable. If you have a S-VHS VCR, use the S-video connections and remove the video cable. Do not connect the video cable and the S-video cable to Video-1 simultaneously. When you use a converter box with your TV, there may be features that you cannot program using the remote control, such as labeling channels, blocking channels, and programming your favorite channels.

Connecting a DVD/satellite receiver and a VCR

This connection allows you to watch DVD/satellite, video and TV programs. You can record from the DVD/satellite receiver and TV, as well as record one TV channel while watching another channel.

You will need:

- one coaxial cable
- three pairs of audio cables (only one cable for a mono VCR)
- two video cables
- one S-video cable

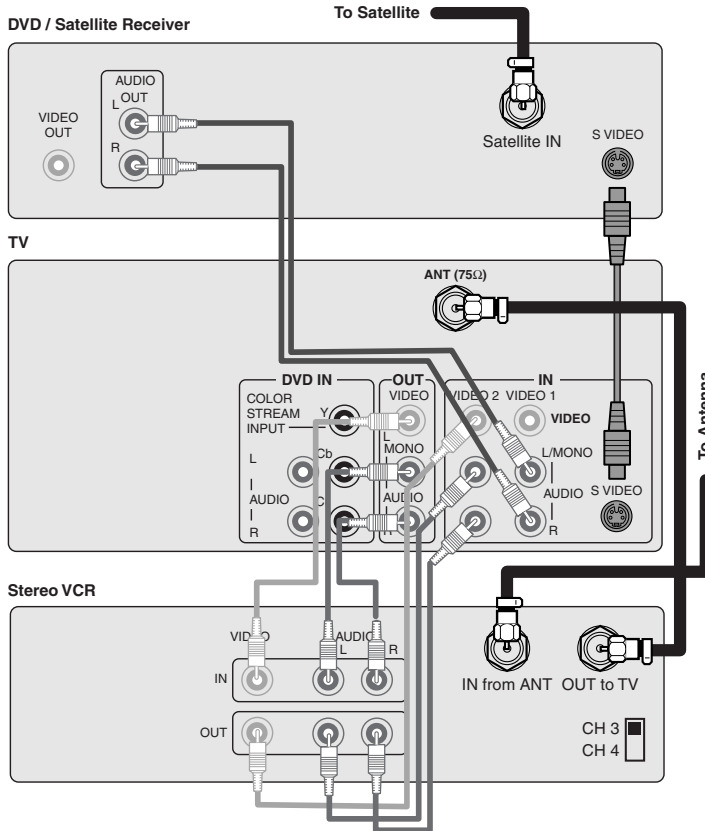

Caution:

You can use a video cable instead of the S-video cable, but the picture quality will decrease. If you use a S-video cable between the TV and DVD/satellite receiver, make the audio connections only and remove the video connection.

Do not connect the video cable and the S-video cable to Video-1 simultaneously.

Connecting a DVD with ColorStream™ and a VCR

This connection allows you to watch DVD, video or TV programs and to record DVD or TV programs. You can record from one source and watch a program from another source. Your TV is capable of using ColorStream (color difference). Connecting your TV to a ColorStream compatible DVD, such as a Toshiba DVD, can greatly enhance picture quality and performance.

You will need:

- one coaxial cable
- three pairs of audio cables (only one cable for a mono VCR)
- two video cables
- one set of ColorStream video cables

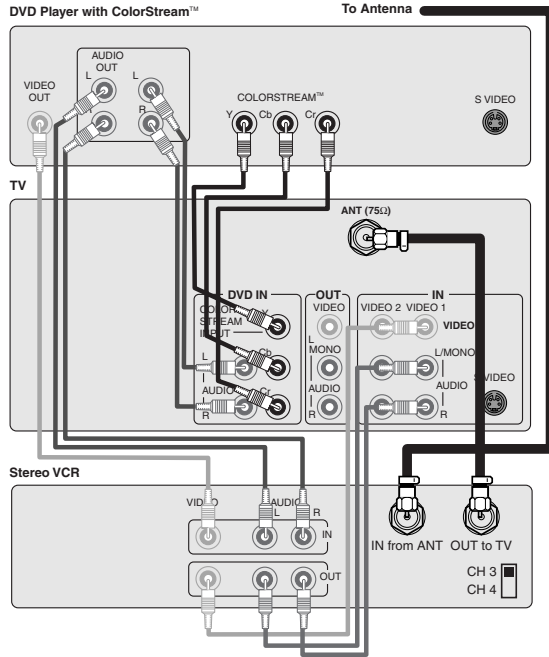

Caution:

To play from the DVD, the DVD and TV must use ColorStream connections. To record from the DVD, the DVD and TV must select Video.

Connecting two VCRs

This connection allows you to record from one VCR to another VCR while watching a video program. You will also be able to record from one TV channel while watching another channel.

You will need:

- one coaxial cable
- two pairs of audio cables (only two cables for mono VCRs)
- two video cables

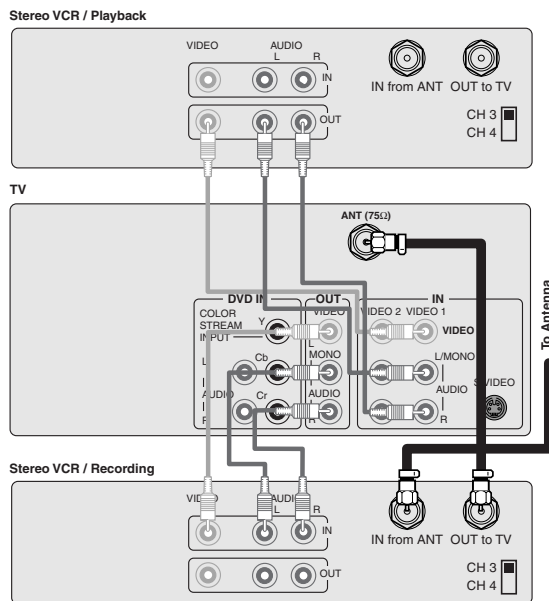

Caution:

Do not connect one VCR to the output and input jacks on the TV at the same time. If you are using a S-VHS VCR, use the S-video connections and remove the video cable. Do not connect the video cable and the S-video cable to Video-1 simultaneously.

Connecting a camcorder

This connection allows you to watch video materials recorded on a camcorder.

You will need:

- one pair of audio cables
- one video cable

Caution:

If you are using a S-VHS camcorder with a S-video output, connect this to the S-video input on the TV and remove the video cable. Do not connect the video cable and the S-video cable to Video-1 simultaneously.

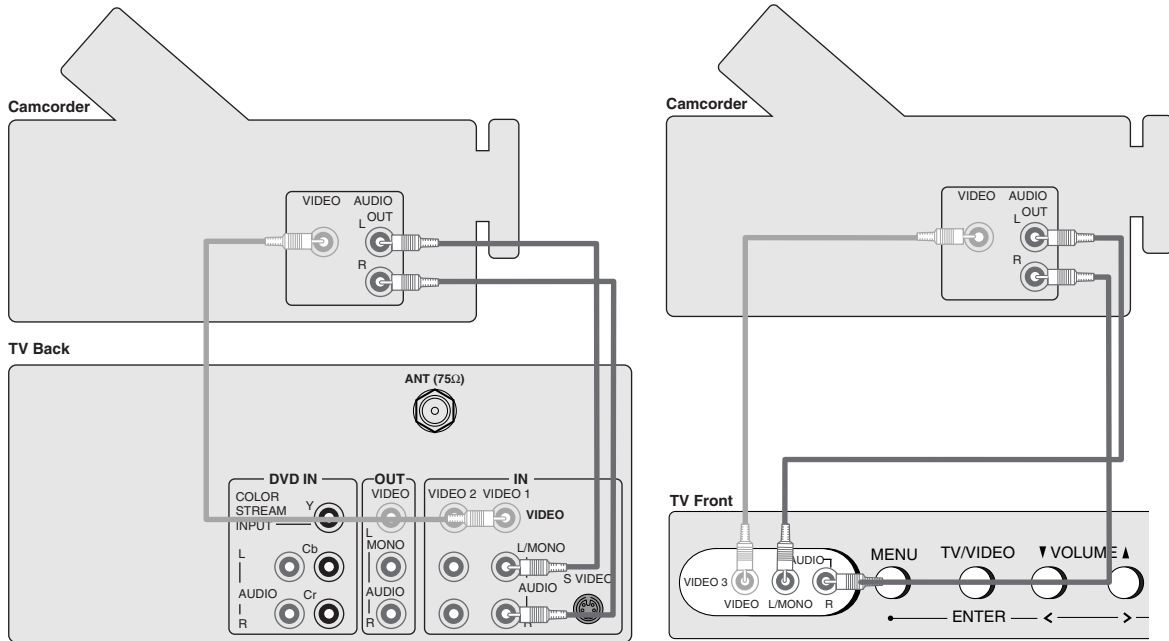

Connecting an audio amplifier

This connection allows you to use an audio amplifier to adjust the audio level. This also allows you to use external speakers.

To control the audio, turn on the TV and the stereo amplifier.

You will need one pair of audio cables.

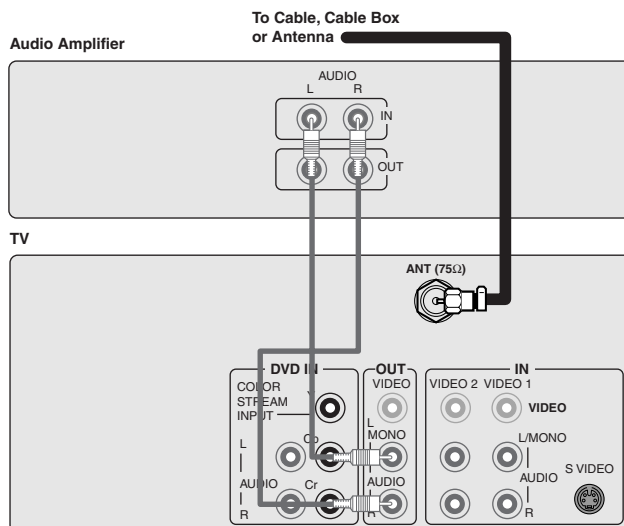

Using the remote control

Preparing the remote control for use

With the remote control, you can operate your TV, most VCR models, and cable TV converters together, even if they are different brands. If you will be using your TV with a Toshiba VCR, your remote control is already programmed and ready to use. If you own different brands of VCRs and/or converters, you first have to program your remote control. (See “Programming the remote control for use with a VCR or a cable TV converter” on page 8.)

Installing the remote control batteries

To install the batteries:

1. Slide the battery cover off of the back of the remote control.

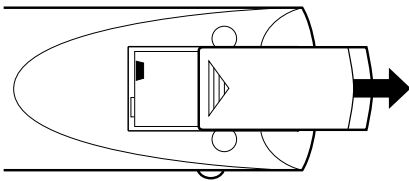

2. Install two “AA” size alkaline batteries. Match the + and - signs on the batteries to the signs on the battery compartment.

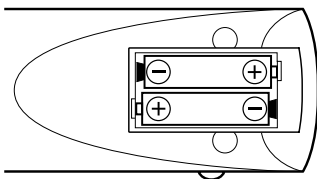

3. Slide the battery cover back on to the remote control until the lock snaps.

Using the remote control with a VCR or a cable TV converter

To control a Toshiba VCR:

Set the TV/CABLE/VCR switch to the VCR position. The buttons shown to the right will then control the VCR. The rest of the buttons will operate the TV as usual.

Note:

This remote control's functions may or may not operate your VCR or cable TV converter. Refer to the owner's manuals supplied with the equipment to see which features are available. In addition, the original controllers may have features not available on this remote control. If you would like to continue to use these features, you may want to use the original remote control.

Caution:

- Dispose of your batteries in a designated disposal area. Do not throw your batteries into a fire.
- Do not mix battery types or combine used batteries with new ones.
- Remove dead batteries immediately to prevent battery acid from leaking into the battery compartment.
- If you do not intend to use the remote control for a long time, remove the batteries.

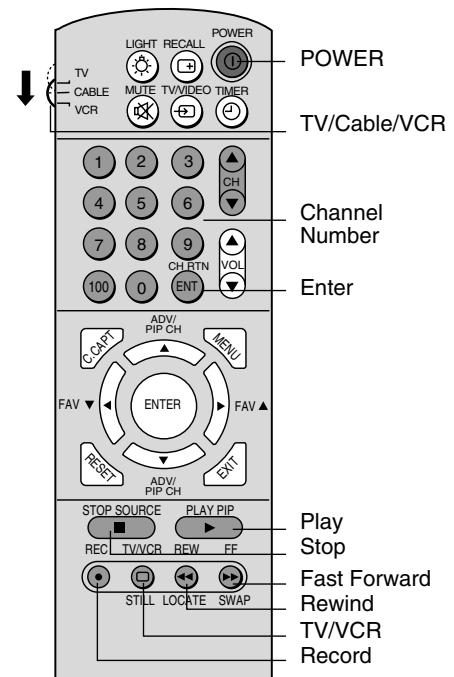

To control a cable TV converter:

Program the remote control to recognize the brand of your converter (see “Programming the remote control for use with a VCR or cable TV converter,” below). The shaded buttons shown on the right will control the cable TV converter.

Set the TV/CABLE/VCR switch to the CABLE position.

Programming the remote control for use with a VCR or a cable TV converter

This remote control is pre-programmed to operate Toshiba VCRs. To use VCRs or cable converters other than Toshiba models, you must follow the steps below before you operate your remote control.

1. Refer to the “VCR code table” or “Cable TV converter code table” on pages 9-10 to find the number that corresponds to the brand name of your VCR or converter.

If more than one number is listed, try each one separately until you find the one that works.

2. If you are reprogramming the remote control to operate your:
 - **VCR**, set the TV/CABLE/VCR switch on the remote control to VCR.
 - **cable converter**, set the TV/CABLE/VCR switch on the remote control to CABLE.
3. Hold down the RECALL button while using the Channel Number buttons to enter the three-digit code number of your brand of VCR or converter.

4. Point the remote control at the VCR or converter and press POWER to test the code number.

If the VCR or converter turns on, you have entered the right number.

If the VCR or converter does not respond to the remote control, you may have entered the wrong number. Repeat steps 1-4 with another code number.

For future reference, write down the code numbers you used:

VCR code _____

Cable code _____

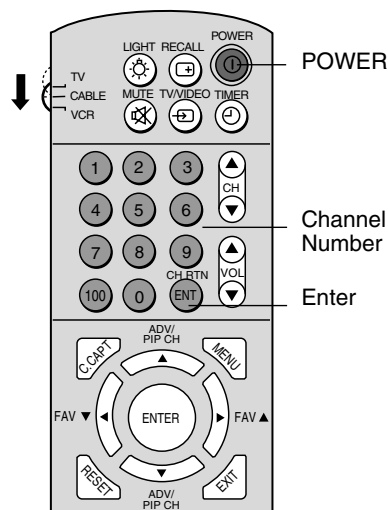

Note:

- Each time you replace the batteries, you must reprogram the remote control.
- Some newer VCRs are capable of working on either of two remote codes. These VCRs have a switch labeled “VCR1/VCR2.” If your VCR has this kind of switch, it may not respond to any of the code numbers for your VCR brand name. In this case, set the switch to the other position (VCR1 or VCR2) and reprogram the remote control.

VCR code table

Brand name Code number

Adventura	019
Aiko	297
Aiwa	019
Akai	060, 068, 080, 125, 261
American High	054
Asha	259
Audiovox	056
Beaumarck	259
Bell & Howell	123
Brandt	206
Broksonic	140, 203, 230, 314, 380
Calix	056
Canon	054
Capehart	039
Carver	100
CCE	091, 297
Citizen	056, 297
Colt	091
Craig	056, 066, 091, 259
Curtis Mathes	054, 060, 079
Cybernex	259
Daewoo	039, 064, 297
Daytron	039
Dynatech	019
Electrohome	056
Electroponic	056
Emerex	051
Emerson	019, 021, 056, 062, 080, 087, 140, 203, 227, 228, 230, 231, 297, 313, 314, 380, 498
Fisher	066, 073, 085, 123
Fuji	052, 054
Funai	019, 344
Garrard	019, 344
GE	054, 079, 084, 221
Goldstar	037, 056, 057
Gradiente	019
Harley Davidson	019
Harman/Kardon	057, 094
Harwood	087, 091
Headquarter	065
HI-Q	066
Hitachi	060, 061, 084, 124, 185, 254
Jensen	060
JVC	027, 060, 086
Kenwood	057, 060, 086
KLH	091
Kodak	054, 056
Lloyd	019, 227
Logik	091
LXI	056
Magnavox	054, 058, 100, 129, 168

Magnin	259
Marantz	054, 100
Marta	056
Matsushita	054
MEI	054
Memorex	019, 054, 056, 058, 065, 066, 067, 123, 259
MGA	062, 080
MGN Technology	259
Minolta	061, 124
Mitsubishi	062, 080, 086, 094, 192, 233, 261
Motorola	054, 067
MTC	019, 259
Multitech	019, 091
NAD	077
NEC	057, 059, 060, 069, 086
Nikko	056
Noblex	259
Olympus	054
Optimus	056, 067, 077, 123
Optonica	081
Orion	498
Panasonic	054, 096, 181, 244, 473
Penney	054, 056, 057, 059, 061, 073, 259
Pentax	061, 084, 124
Philco	054
Philips	054, 081, 100, 129
Pilot	056
Pioneer	077, 086
Portland	039
Protec	091
Pulsar	058
Quarter	065
Quartz	065
Quasar	054, 096
Radio Shack	019, 056, 344
Radix	056
Randex	056
RCA	061, 079, 084, 096, 124, 125, 168, 221
Realistic	019, 054, 056, 065, 066, 067, 081, 085, 123, 259
Ricoh	053
Runco	058
Samsung	064, 259
Sanky	058, 067
Sansui	060, 086
Sanyo	065, 066, 123, 259
Scott	062, 064, 140, 203, 229, 230, 231
Sears	054, 056, 061, 065, 066, 073, 085, 123, 124

Sharp	067, 081
Shintom	091
Shogun	259
Singer	091
Sony	051, 052, 053, 054
STS	061
Sylvania	019, 054, 062, 100, 129
Symphonic	019, 344
Tatung	060
Teac	019, 060
Technics	054, 181
Teknika	019, 054, 056, 071
Telefunken	206
TMK	227, 259
Toshiba	062, 064, 085, 229, 231, 385
Totevision	056, 259
Unitech	259
Vector	064
Vector Research	057, 059
Video Concepts	059, 064, 080
Videosonic	259
Wards	019, 054, 061, 066, 067, 081, 091, 168, 231, 259
XR-1000	019, 054, 091
Yamaha	057
Zenith	052, 053, 058

Cable TV converter code table

Brand name	Code number
ABC	020, 022, 027, 030, 032, 033, 036, 066
Antronix	041
Archer	041, 058, 172
Belcor	075
Cable Star	075
Cabletenna	041
Cableview	041
Century	172
Citizen	172
Colour Voice	044, 050
Comtronics	059, 079
Contec	038
Eastern	021
Focus	419
Garrard	172
CG Electronics	075
Gemini	034, 089
General Instrument	030, 295
Gold Star	059, 163
Hamlin	028, 039, 053, 278, 292
Hitachi	030

Hytex	026
Jasco	172
Jerrold	022, 030, 031, 033, 034, 066, 295
Macom	052
Magnavox	046
Memorex	019
Movietime	175
NSC	089, 175
Oak	026, 038, 267
Panasonic	019, 040, 126
Paragon	019
Philips	044, 046, 047, 048, 049, 050, 172
Pioneer	042, 163, 552
Popular Mechanics	419
Pulsar	019
RCA	040
Regal	039, 278, 292
Recoton	419
Regency	021
Rembrandt	030, 089
Runco	019
Samsung	059, 163
Scientific Atlanta	025, 027, 036, 296
Signal	034, 059
Signature	030
SL Marx	059
Sprucer	040
Standard Components	174
Starcom	022, 034, 066
Stargate	034, 059
Starquest	034
Sylvania	020
Televue	059
Texscan	020
Tocom	031, 032, 078
Toshiba	019
Tusa	034
Unika	041, 172
United Artists	026
United Cable	022
Universal	041, 058, 075, 096, 172, 210
Viewstar	046, 079, 230
Zenith	019
Zentek	419

Learning about the remote control

POWER turns the TV on and off (pages 8, 25, 29 and 30)

Timer sets the TV to go off at a set time (page 25)

TV/Video selects video input source (page 25)

Channel ▲ ▼ cycles through programmed channels (page 13)

TV/Cable/VCR switches between TV, Cable and VCR (page 7)

Channel Numbers allow direct access to channels (page 13)

Volume ▲ ▼ adjusts the volume level

Channel Return returns to the last viewed channel (page 15)

Menu allows access to programming menus (page 12)

PIP Channels ▲ ▼ cycles through PIP channels when the main picture is selected to Video and the PIP source is TV (pages 22-23)

Favorite Channels ▲ ▼ cycles through favorite channels (page 15)

Enter sets programmed menu information (pages 15-22)

Exit exits programming menus (pages 15-17, 19-22 and 29)

PIP Functions allow access to PIP functions (pages 22-23)

STOP press to stop a videotape

REC press to start recording a videotape

PLAY press to play a videotape

FF press to fast forward a videotape

RR press to rewind a videotape

TV/VCR toggles between TV and VCR when viewing while recording

Reset resets settings to preset factory formats (pages 24 and 27)

Closed Captioning turns closed captioning on or off (page 26)

Mute mutes the sound (pages 19 and 27)

Light press to back-light buttons for five seconds

Recall displays screen information (pages 8, 17-18, 21, 25, 27 and 29)

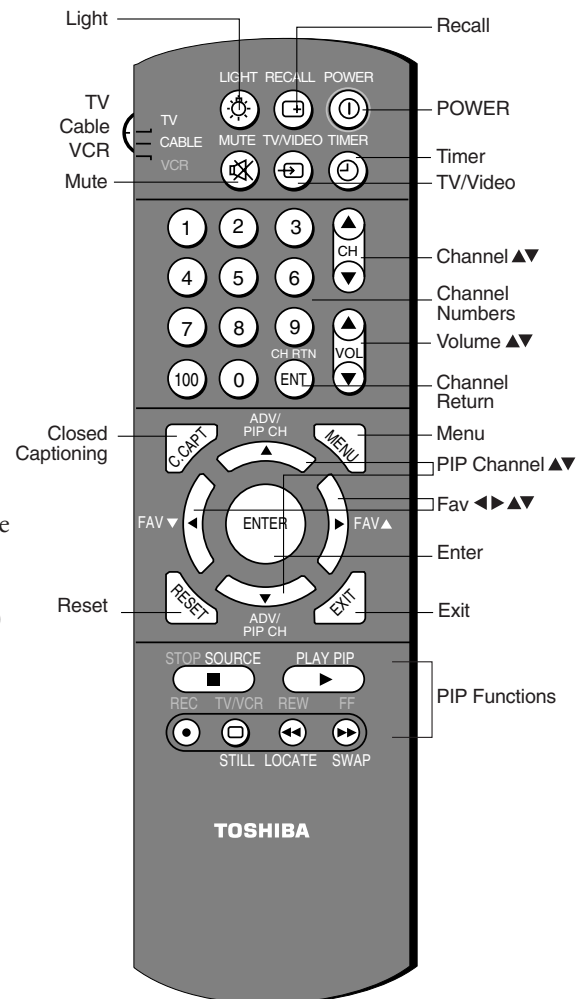

Setting up your TV

After you've installed the batteries and programmed the remote control, you need to set some preferences on the TV using the menu. You can access the menu with the buttons on your TV or by using the remote control.

- When you make a menu selection, your changes occur immediately. You do not have to press MENU or EXIT to see your changes.
- After fifteen seconds, the menu screen will automatically disappear if you do not make a selection. Your changes will still be saved.
- When you are finished programming the menus, press EXIT.

Changing the on-screen display language

You can choose from three different languages (English, French and Spanish) for the on-screen displays. Adjustment menus and messages will appear in the language of your choice.

To select a language:

1. Press MENU, then press ◀ or ▶ until the SET UP menu appears.

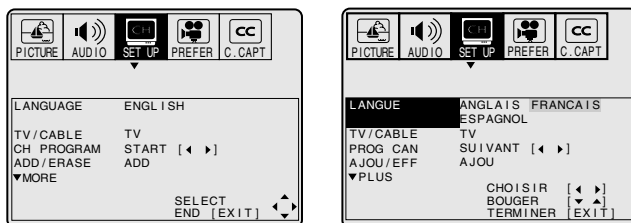

2. Press ▲ or ▼ to highlight LANGUAGE.
3. Press ◀ or ▶ to highlight your desired language.

Using the TV/VIDEO button

You can monitor or change the signal source that is connected to the TV. By pressing the TV/VIDEO button on your TV, you can select the VIDEO 1, VIDEO 2, VIDEO 3, ColorStream, or TV mode. The signal source you are currently connected to will be displayed in purple.

To select the signal source:

1. Press the TV/VIDEO button. The signal source you are connected to is displayed in purple.

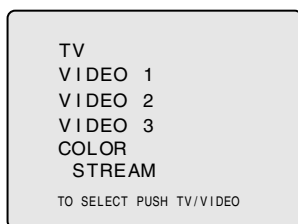

2. Press the button until TV is displayed in purple, indicating the source you wish to use.

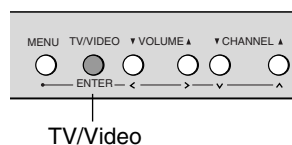
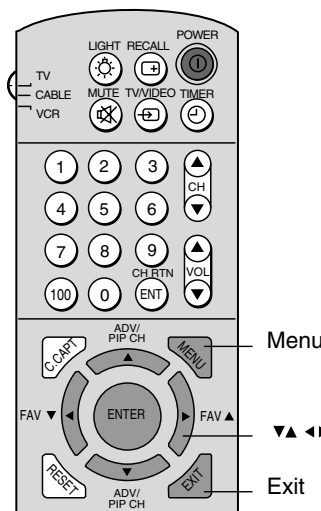
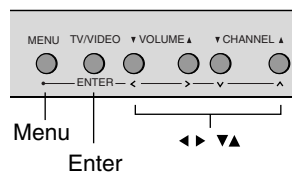

Adding channels to the TV's memory

Your TV will stop on specific channels that are stored in the TV's channel memory when you press Channel ▲ or ▼. Use the steps below to set all active channels in your area automatically.

Programming channels automatically

Your TV can automatically detect all active channels and store them in its memory. After the TV has stored the channels in its memory, you can erase channels or add your favorite channels.

To add channels:

1. Press MENU, then press ◀ or ▶ to highlight the SET UP menu.
2. Press ▲ or ▼ until the TV/CABLE selection is highlighted.
3. Press ◀ or ▶ to highlight either TV or CABLE, depending on which you use.

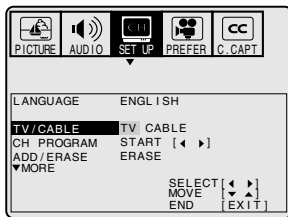

If you use an antenna, choose TV.

If you use cable, choose CABLE.

4. Press ▼ to select CH PROGRAM.
5. Press ◀ or ▶ to start channel programming. The TV will automatically cycle through all the TV or Cable channels (depending on which you selected), and store all active channels in the channel memory.

While the TV is cycling through the channels, the message "Programming Now Please Wait" appears.

6. When channel programming is complete, the message "Completed (channel or cable number)" appears.
7. Press Channel ▲ or ▼ to view the programmed channels.

Adding and erasing channels manually

After you've programmed the channels, you can add or erase specific channels.

To add or erase channels:

1. Select the channel you want to add or erase using Channel ▲ or ▼. If adding channels, you must select the channel to add by using the Channel Number buttons.
2. Press MENU, then press ◀ or ▶ to highlight the SET UP menu.
3. Press ▲ or ▼ to highlight ADD/ERASE.

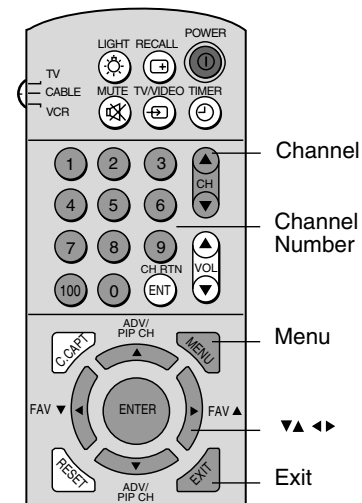
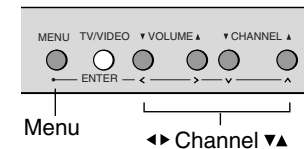
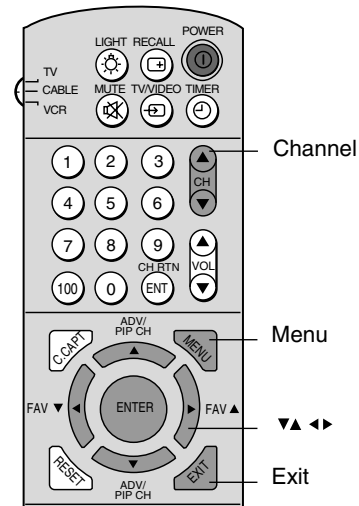
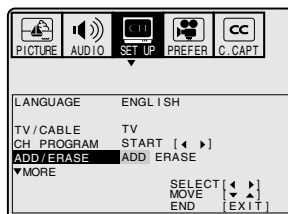

4. Press ◀ or ▶ to select ADD or ERASE, whichever function you want to perform.
5. Repeat steps 1-4 for other channels you want to add or erase.

Changing channels

To change the channel, you can:

- change the programmed channels using the remote control
- select a channel directly using the remote control
- scan the channels using the TV buttons

To change to the next programmed channel:

Press Channel ▲ or ▼ on the TV or remote control.

To change to a specific channel (programmed or unprogrammed):

Press the Channel Number buttons (0-9 and 100).

For example, to select channel 125, press the 100 button, the 2 button, and the 5 button.

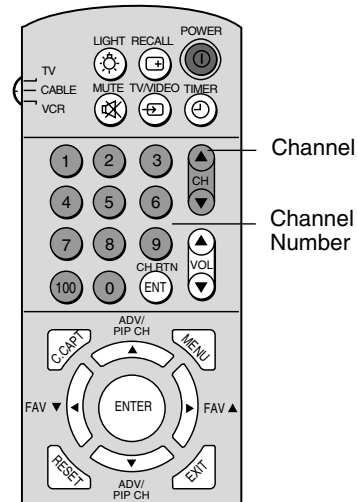
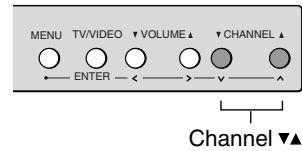

Using the TV's features

Adjusting the channel settings

Switching between two channels

You can switch between two channels without entering an actual channel number each time.

To switch between two channels:

1. Select the first channel you want to view.
2. Select a second channel with the Channel Number buttons (0-9, 100).
3. Press CH RTN. The previous channel will be displayed.

Each time you press CH RTN, the TV will switch back and forth between the two channels.

Programming your favorite channels

You can preset up to 12 of your favorite channels using the Favorite Channel Programming feature. Because this feature scans through only your favorite channels, it allows you to skip other channels you do not normally watch.

You can still use Channel ▲▼ to scan through all the channels you programmed in the TV's memory.

To program your favorite channels:

1. Select a channel you want to program.
2. Press MENU, then press ◀ or ▶ to highlight the SET UP menu.
3. Press ▲ or ▼ to highlight FAVORITE CH.

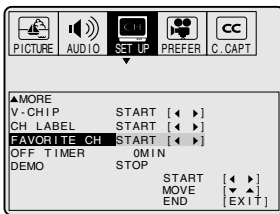

4. Press ◀ or ▶ to display the FAVORITE CH menu. SET/CLEAR will be highlighted.

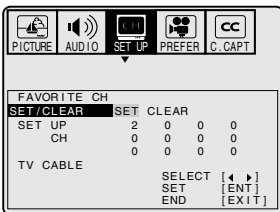

5. Press ◀ or ▶ to highlight SET and press ENTER.
6. Press EXIT to clear the screen.
7. Repeat steps 1 through 6 for up to 11 other channels.

To select your favorite channels:

Press the FAV ▲▼ buttons on the remote control to select your favorite channels.

The FAV ▲▼ buttons will not work until you have programmed your favorite channels.

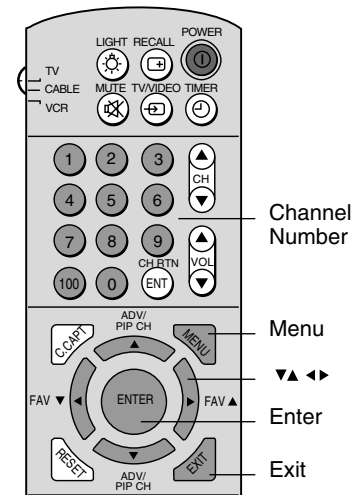
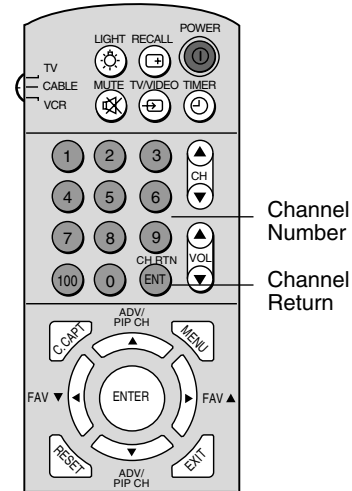

To clear your favorite channels:

1. Select a channel you want to clear.
2. Press MENU, then press ◀ or ▶ to highlight the SET UP menu.
3. Press ▲ or ▼ to highlight FAVORITE CH.
4. Press ◀ or ▶ to display the FAVORITE CH menu.
SET/CLEAR will be highlighted.

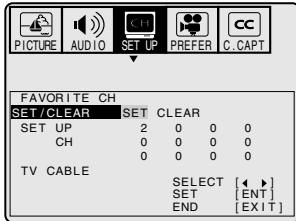

5. Press ◀ or ▶ to highlight CLEAR.

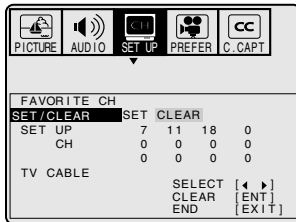

6. Press ENTER until "0" replaces the channel number you want to erase.
7. Press EXIT to clear the screen.
8. Repeat steps 1 through 6 for the other channels.

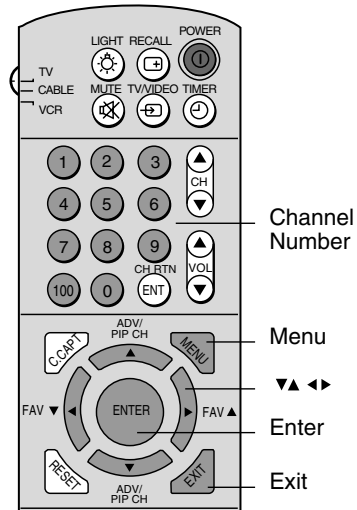

Using the V-Chip

You can prevent others from viewing certain programs or channels by using the V-Chip feature.

Selecting a PIN code

Before you can block programs and channels, though, you must select a personal identification number (PIN) code. The PIN code you select prevents others from changing the rating limits you set.

To select your PIN code and access the V-Chip menus:

1. Press MENU, then press ◀ or ▶ to highlight the SET UP menu.
2. Press ▲ or ▼ to highlight V-CHIP.

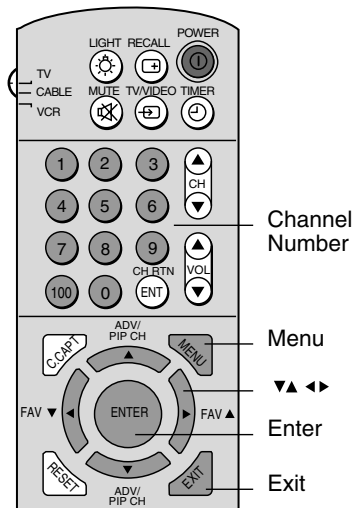

- Press to ◀ or ▶ display the V-CHIP menu.

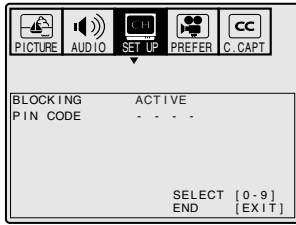

- Use the Channel Number buttons (0-9) to enter your PIN code. If you are accessing the V-Chip menus for the first time, select a four-digit number to be your PIN code. Press ENTER. The BLOCKING menu appears.

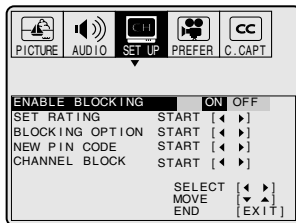

Note:

If you forget your PIN code, press **RECALL** four times within five seconds from the V-CHIP menu. This allows you to proceed to the **BLOCKING** menu and reset your PIN code.

- You may now enable blocking — “Blocking programs by ratings” (see below), “Blocking channels” (see page 20), “To change your PIN code” (below) or “Blocking unrated movies or programs” (see page 20).

To change your PIN code:

- Press MENU, then press ◀ or ▶ to highlight the SET UP menu.
- Press ▲ or ▼ to highlight V-CHIP.
- Press ◀ or ▶ to display the V-CHIP menu.
- Use the Channel Number buttons (0-9) to enter your PIN code. If you are accessing the V-Chip menus for the first time, select a four-digit number to be your PIN code. Press ENTER. The BLOCKING menu appears.
- Press ▲ or ▼ to highlight NEW PIN CODE and press ◀ or ▶ to display the NEW PIN CODE menu.
- Use the Channel Number buttons (0-9) to enter a new code. Press ENTER.
- Press EXIT to return to normal viewing.

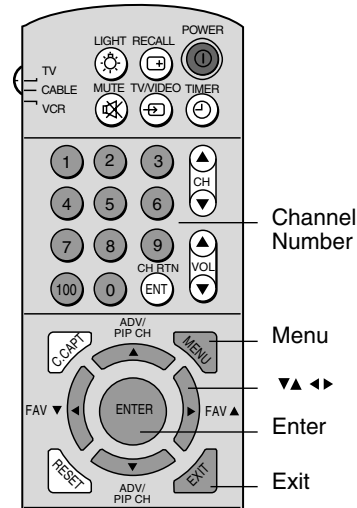

Blocking programs by ratings

The Motion Picture Association of America (MPAA) uses a rating system to qualify motion picture content. Television broadcasters employ a rating system to qualify the content of television programs, as well. The MPAA, Youth TV and TV ratings work with the V-Chip feature and allow you to block out programming above the rating limits you determine.

MPAA Ratings

- X** For adults only.
- NC17** Not intended for anyone 17 or under.
- R** Restricted. Under 17 requires an accompanying parent or adult guardian.
- PG13** Parents strongly cautioned. Some material may be inappropriate for children under 13.
- PG** Parental guidance suggested. Some material may not be appropriate for children.
- G** General audience. Appropriate for all ages.

Youth TV Ratings

- Y7, Y7 FV** Directed to older children. This program is designed for children age 7 and above. For those programs where fantasy violence may be more intense or more combative than other programs in this category, such programs are designated TV-Y7-FV.
- Y** All children. This program is designed to be appropriate for all children.

TV Ratings

- MA** Mature audience only. This program is specifically designed to be viewed by adults and therefore may be unsuitable for children under 17.
- Language Crude or indecent language.
- Sex Explicit sexual activity.
- Violence Graphic violence.
- 14** Parents strongly cautioned. This program contains some material that many parents would find unsuitable for children under 14 years of age.
- Dialog Intensely suggestive dialog.
- Language Strong, coarse language.
- Sex Intense sexual situations.
- Violence Intense violence.
- PG** Parental guidance suggested. This program contains material that parents may find unsuitable for younger children.
- Dialog Some suggestive dialog.
- Language Infrequent coarse language.
- Sex Some sexual situations.
- Violence Moderate violence
- G** General audience. Most parents would find this program suitable for all ages.
- No DLSV** Programs without any Dialog, Language, Sex or Violence ratings.

Note:

To see the rating of the program you are viewing, press RECALL at any time.

To use the V-Chip to block programs by rating:

1. Press MENU, then press ◀ or ▶ to highlight the SET UP menu.
2. Press ▲ or ▼ to highlight V-CHIP.
3. Press ◀ or ▶ to display the V-CHIP menu.
4. Use the Channel Number buttons (0-9) to enter your PIN code. If you are accessing the V-Chip menus for the first time, select a four-digit number to be your PIN code. Press ENTER. The BLOCKING menu appears.

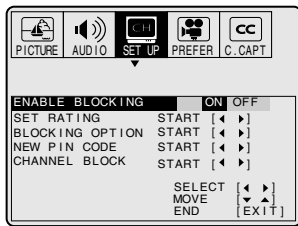

5. Press ▲ or ▼ to highlight ENABLE BLOCKING.
 - Press ◀ or ▶ to highlight ON to enable the V-Chip and program blocking by rating.
 - Press ◀ or ▶ to highlight OFF to disable the V-Chip and program blocking by rating.
6. Press ▲ or ▼ to highlight SET RATING. Then, press ◀ or ▶ to display the SET RATING menu.

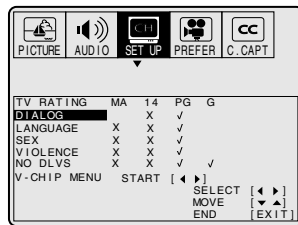
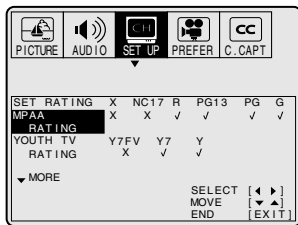

7. Press ▲ or ▼ to highlight MPAA Rating, Youth TV Rating or individual TV Ratings.
8. Press ◀ or ▶ to select the ratings which will be blocked. Blocked ratings are signified by a red "X." Unblocked ratings are signified by a green "✓." As you block ratings, all ratings higher than the ones you select are blocked, as well. For example, if you choose to block the MPAA rating R, the higher ratings, NC17 and X, are automatically blocked, too.
9. When you are done selecting the ratings to be blocked, press EXIT to return to normal viewing.

When you try to view a program with a ratings block, a message will appear listing the program's ratings. The program can still be viewed if you press MUTE and then enter your PIN code to temporarily bypass the block.

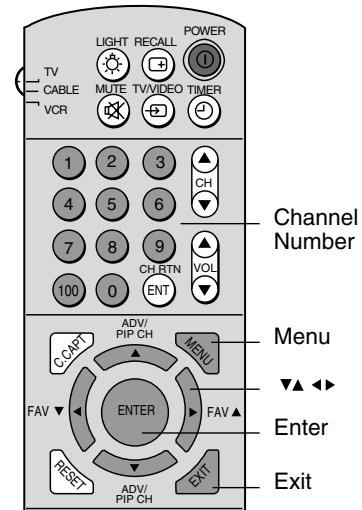

Note:

Not all programs are rated. To block programs or movies that are unrated, see "Blocking unrated movies or programs," page 20.

Blocking unrated movies or programs

Some movies and programs are not rated. You can block these movies and programs using the V-Chip.

To block unrated movies or programs:

1. Press MENU, then press ◀ or ▶ to highlight the SET UP menu.
2. Press ▲ or ▼ to highlight V-CHIP.
3. Press ◀ or ▶ to display the V-CHIP menu.
4. Use the Channel Number buttons (0-9) to enter your PIN code.
If you are accessing the V-Chip menus for the first time, select a four-digit number to be your PIN code. Press ENTER. The BLOCKING menu appears.
5. Press ▲ or ▼ to highlight BLOCKING OPTION.
6. Press ◀ or ▶ to display the BLOCKING OPTION menu.
7. Press ▲ or ▼ to highlight MPAA UNRATED.
 - Press ◀ or ▶ to highlight ON to block unrated movies.
 - Press ◀ or ▶ to highlight OFF to unblock unrated movies.
8. Press ▲ or ▼ to highlight TV NONE RATING.
 - Press ◀ or ▶ to highlight ON to block programs with a rating of "TV NONE."
 - Press ◀ or ▶ to highlight OFF to unblock programs with a rating of "TV NONE."
9. Press EXIT to return to normal viewing.

Note:

Blocking television programs with a rating of "TV NONE" may block emergency messages.

Blocking channels

You can also choose to block individual channels. These channels will not be seen regardless of the ratings of their programming. You can choose to block up to four TV channels and four cable channels.

To block channels:

1. Use the Channel Number Buttons (0-9) display the television channel you wish to block.
2. Press MENU, then press ◀ or ▶ to highlight the SET UP menu.
3. Press ▲ or ▼ to highlight V-CHIP and then press ◀ or ▶ to display the V-CHIP menu.
4. Use the Channel Number buttons (0-9) to enter your PIN code.
If you are accessing the V-Chip menus for the first time, choose a four-digit number to be your PIN code. Press ENTER.
5. Press ▲ or ▼ to highlight CHANNEL BLOCK and then press ◀ or ▶ to display the CHANNEL BLOCK menu.

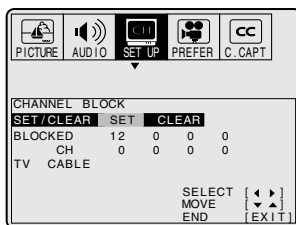

6. Press ◀ or ▶ to:
 - SET the channel as one to be blocked.
 - CLEAR all channels from the list of blocked channels.

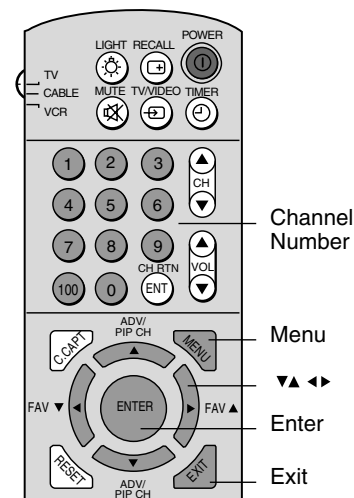

7. Press ENTER.
8. Repeat steps 1 through 7 to block other channels. When you are finished blocking channels, press EXIT to return to normal viewing.

If you try to display a blocked channel, the TV will not display it, but will display the nearest unblocked channel.

To unblock channels:

1. Press MENU, then press ◀ or ▶ to highlight the SET UP menu.
2. Press ▲ or ▼ to highlight V-CHIP and then press ◀ or ▶ to display the V-CHIP menu.
3. Use the Channel Number buttons (0-9) to enter your PIN code. If you are accessing the V-Chip menus for the first time, choose a four-digit number to be your PIN code. Press ENTER.
4. Press ▲ or ▼ to highlight CHANNEL BLOCK and then press ◀ or ▶ to display the CHANNEL BLOCK menu.
5. Press ◀ or ▶ to highlight CLEAR and clear all channels from the list of blocked channels. Press ENTER.
6. Press EXIT to return to normal viewing.

Labeling channels

Channel labels will appear over the channel number display each time you turn on the TV, select a channel, or press the RECALL button. You can choose any four characters to identify the channels.

To create channel labels:

1. Select a channel you want to label.
2. Press MENU then press ◀ or ▶ until the SET UP menu appears.
3. Press ▲ or ▼ to highlight CH LABEL.

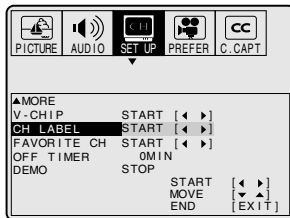

4. Press ◀ or ▶ to display the CH LABEL menu. SET/CLEAR will be highlighted.
5. Press ◀ or ▶ to highlight SET.

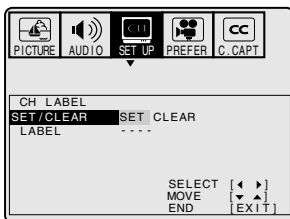

Note:

After programming CHANNEL BLOCK, change channels before turning off the television.

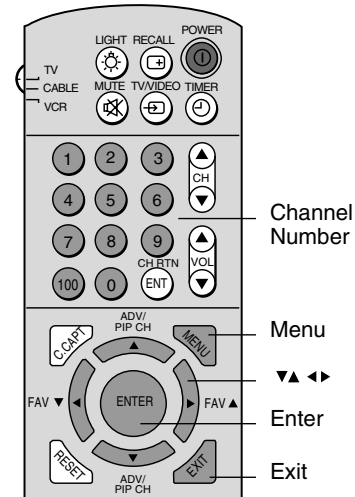

- Press ▼ to highlight LABEL.

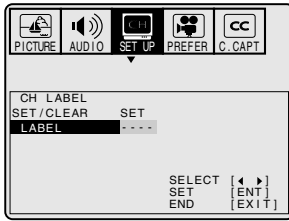

- Assign the label to the channel. Press ◀ or ▶ to enter a character in the first space. Press the button repeatedly until the character you want appears on the screen. Press ENTER.
- Repeat step 7 to enter the rest of the characters.
If you would like a blank space in the label name, you must choose an empty space from the list of characters. Otherwise, a dash will appear in that space.
- Press EXIT to clear the screen.
- Repeat steps 1 through 8 for other channels. You can assign up to 32 labels.

To erase channel labels:

- Select a channel with a label.
- Press MENU then press ◀ or ▶ until the SET UP menu appears.
- Press ▲ or ▼ to highlight CH LABEL.
- Press ◀ or ▶ to display the CH LABEL menu.
SET/CLEAR will be highlighted.
- Press ◀ or ▶ to highlight CLEAR.
- Press ENTER.
- Repeat steps 1 through 6 to erase other channel labels.

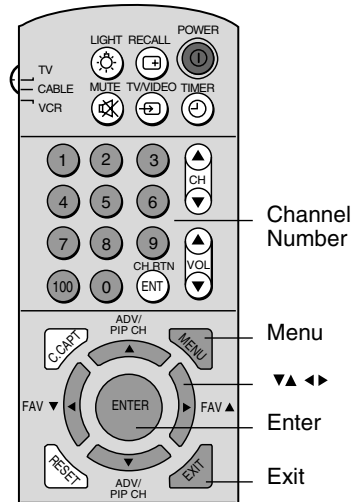

Watching picture-in-picture (PIP)

The picture-in-picture (PIP) feature allows you to watch two pictures at the same time. The smaller picture comes from an external source, such as a VCR.

To display a picture from an external source as a small picture:

- Make sure you have connected the external source equipment properly. For more information, see the “Connecting your TV” on page 2.
- Turn on the TV and select the program you want to watch.
- Press the PIP button once to display a small picture. A window 1/9 the size of the screen will appear. Press PIP a second time to display a 1/16 size window.
- Press SOURCE repeatedly to select the input source (VIDEO 1, VIDEO 2 or VIDEO 3) for the small picture. The selected source will be displayed in purple. ColorStream cannot be selected.

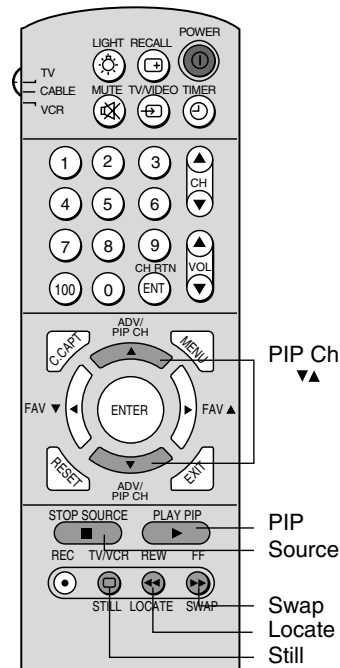

- The Swap feature described below allows you to view TV channels in the PIP. Press PIP CH ▲▼ to change the TV channel displayed in the PIP.

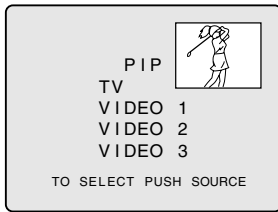

To turn PIP off:

Press PIP once or twice, depending on the size of the small picture screen you selected.

Switching the main and small pictures

Press SWAP while you are using the PIP feature to switch the main and small pictures. The main and small pictures will switch each time you press the SWAP button.

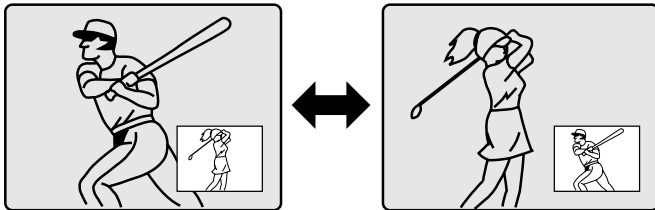

Changing the position of the small picture

Press LOCATE repeatedly while you are watching a small picture. The display position of the small picture will change in the following order:

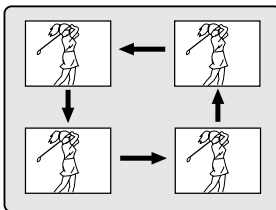

Freezing the small picture

Press STILL while you are watching a small picture. The small picture will become a still picture. To return to the moving picture, press STILL again.

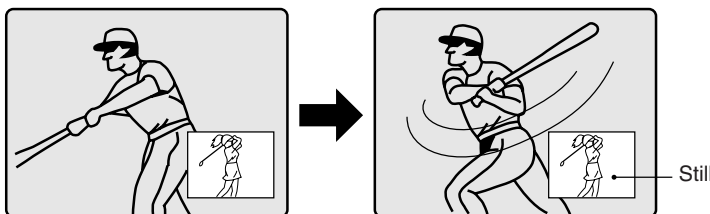

Note:

PIP cannot be turned on when the ColorStream input is being viewed.

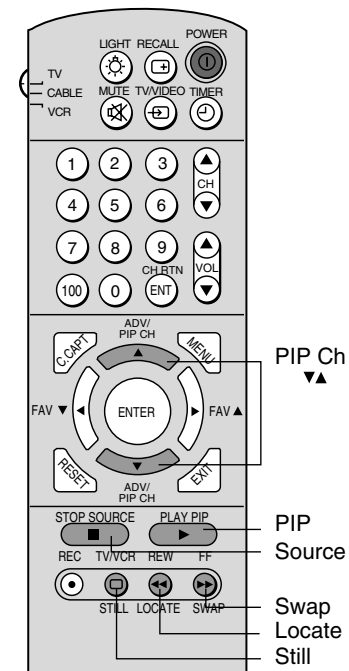

Adjusting the picture

Adjusting the picture quality

You can adjust the picture quality to your personal preferences, including the contrast, brightness, color, tint, and sharpness. The qualities you choose will be stored automatically in your TV's memory so that you can recall them at any time.

To adjust the picture quality:

1. Press MENU, then press ◀ or ▶ to highlight the PICTURE menu.

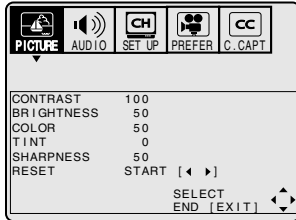

2. Press ▲ or ▼ until the item you want to adjust is highlighted.
3. Press ◀ or ▶ to adjust the level.

The PICTURE items you have adjusted will be stored in the TV's memory automatically. You can keep these settings or choose preset options under the PREFERENCES menu. (See "Selecting the color temperature" and "Adjusting the picture preferences," below.)

Selection	◀ Pressing ▶
contrast	lower higher
brightness	darker lighter
color	paler deeper
tint	reddish greenish
sharpness	softer sharper

Selecting the color temperature

You can change the quality of the picture by selecting from three preset color temperatures: cool, medium, and warm.

To select the color temperature:

1. Press MENU, then press ◀ or ▶ to highlight the PREFERENCES menu.
2. Press ▲ or ▼ to highlight COLOR TEMPERATURE.
3. Press ◀ or ▶ to highlight the mode you want.

Mode	Picture Quality
cool	blueish
medium	neutral
warm	reddish

Adjusting the picture preferences

You can select your desired picture type from three preset picture modes: Normal, Theater, and Memory.

To select the picture preferences:

1. Press MENU, then press ◀ or ▶ to highlight the PREFERENCES menu.

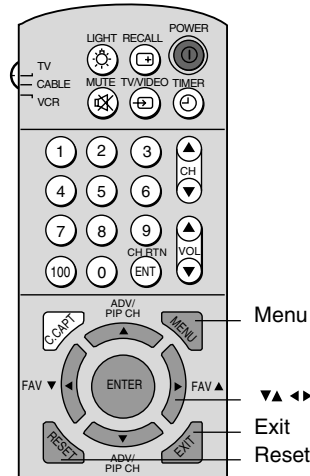
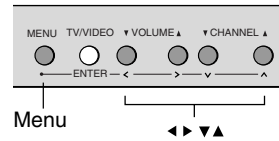

Note:

To reset the picture adjustments to the factory settings, press RESET.

2. Press ▲ or ▼ to highlight PICTURE PREFERENCES.
3. Press ◀ or ▶ to highlight the mode you want.

The table below describes the effects of the different preferences.

Mode	Picture Quality
normal	picture quality set at factory
theater	movie-like picture setting
memory	your personal preference*

*See “Adjusting the picture quality” on page 24.

Watching video input

You can use the TV/VIDEO button on the remote control or the TV to view a signal coming from other devices, such as VCRs or video disc players that may be connected to your TV. (See “Connecting your TV” on page 2.)

Displaying on-screen information

Press RECALL to display the following on-screen information:

- Antenna mode (when in TV mode)
- Channel number or VIDEO mode selected
- Channel label (if preset)
- Stereo or SAP (second audio program) audio status
- V-Chip rating

Setting the off-timer

You can set the TV so it turns off automatically.

To set the off-timer:

1. Press TIMER once to select the OFF TIMER.
2. Press two Channel Number buttons to enter how long you want the TV to remain on (up to three hours, in 10 minute increments). Enter the numbers after the number position starts to blink.
3. Press TIMER to start the timer. The display color will change from purple to blue, then turn off.

To cancel the off-timer:

Press POWER twice, once to turn the TV off, and once to turn it on again.

Auto power off

The TV will automatically turn itself off after approximately 15 minutes if it is tuned to a vacant channel or if a station completes its broadcast for the day and stops broadcasting on that channel. This feature, however, does not work in the VIDEO mode.

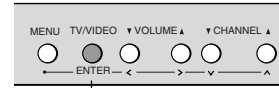

TV/Video

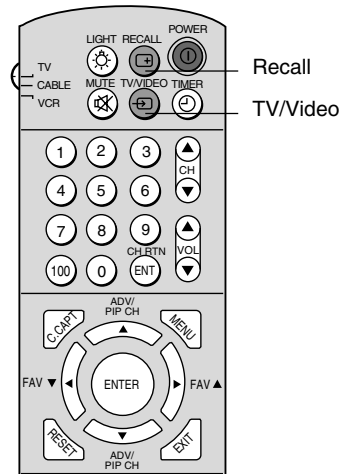

Recall

TV/Video

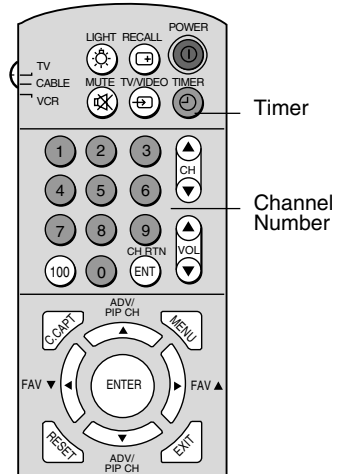

Timer

Channel Number

Note:

The timer can also be set through the SETUP menu.

If you want to see how much time remains before the shut-off time, press TIMER once.

The remaining time will be displayed. To erase the display, press TIMER again.

Using the closed caption feature

You have two options with the closed caption feature: captions or text. A caption is a printed version of the dialogue, narration and/or sound effects of a TV program. Text is information not related to the program that appears on half or full screen of the TV.

To view captions or text:

1. Select the desired program. The captioned programs are usually marked in your local TV listing by “CC.”
2. Press MENU, then press ◀ or ▶ until the C.CAPT menu appears.

Note: You can also press the Closed Caption button to directly access the C.CAPT menu and the TV will cycle through the caption choices.

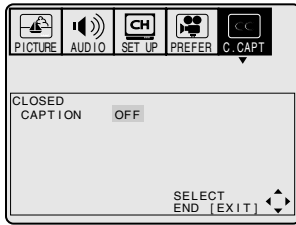

3. Press ▲ or ▼ to highlight CLOSED CAPTION.

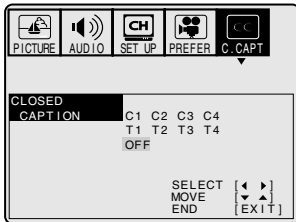

4. Press ◀ or ▶ to select the closed caption mode.
 - Select C1, C2, C3, or C4 to view captions. Select C1 for translation of the primary language in your area.



- Select T1, T2, T3, or T4 to view Text.

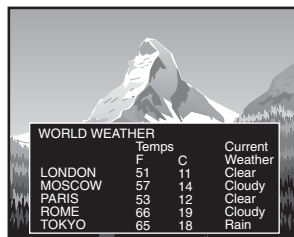

5. To turn off the closed-captioned feature, select OFF in step 4.

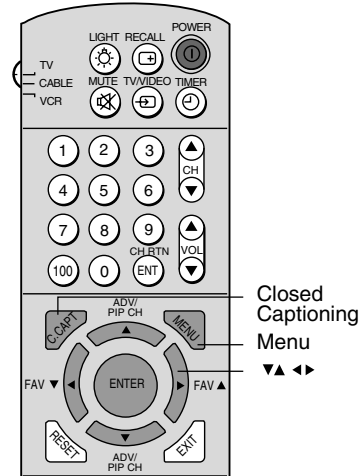

Note:

A closed caption signal may not be decoded in the following situations:

- when a video tape has been dubbed
- when the signal reception is weak
- when the signal reception is non-standard

When you choose a closed captioned channel and the text mode, the text screen always appears. When there is no signal, however, the text screen will not display text characters.

Adjusting the sound

Muting the sound

Press MUTE to temporarily turn off the sound. While the sound is off, the screen will display the word MUTE in the lower right-hand corner. To restore the sound, press MUTE again.

When you press the MUTE button, you automatically activate the closed caption feature. To deactivate this feature, press the MUTE button again. This feature only works when the closed caption mode is set to off. See “Using the closed captioned feature” on page 26 for more information.

Selecting stereo/SAP broadcasts

You can enjoy watching TV while you listen to high-fidelity stereo sound with the Multi-channel TV Sound (MTS) feature. MTS can also transmit a second audio program (SAP) containing a second language or other audio information.

When the TV receives a stereo or SAP broadcast, the word STEREO or SAP appears on the screen when the TV is on, you change the channel, or press the RECALL button.

The MTS feature is not available while in the VIDEO mode.

To listen to stereo sound:

1. Press MENU, then press ◀ or ▶ until the AUDIO menu appears.



2. Press ▲ or ▼ to highlight MTS.
3. Press ◀ or ▶ to highlight STEREO.

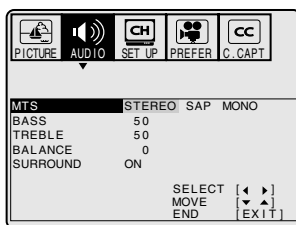

When you are watching a stereo broadcast, the word STEREO is displayed in yellow. You should leave your TV set to STEREO so you can automatically receive stereo or monaural sound, depending on the broadcast type. If the stereo sound is noisy, select MONO to reduce the noise. The word STEREO or SAP is displayed in yellow when the TV receives the signal, and in purple when you have selected the feature.

To listen to a second audio program:

1. Press MENU, then press ◀ or ▶ until the AUDIO menu appears.
2. Press ▲ or ▼ to highlight MTS.
3. Press ◀ or ▶ to highlight SAP. You will hear only the second audio program from the left and right speakers.

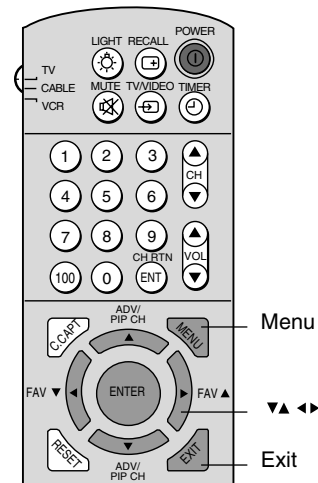
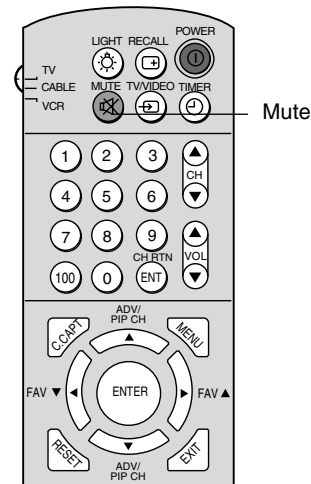

Note:

To reset the audio adjustments to the factory settings, press RESET.

Adjusting the sound quality

You can change the sound quality of your TV by adjusting the bass, treble, and balance.

To adjust the sound quality:

1. Press MENU, then press ◀ or ▶ until the AUDIO menu appears.

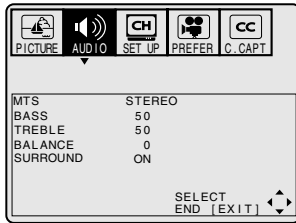

2. Press ▲ or ▼ to highlight the item you want to adjust.
3. Press ◀ or ▶ to adjust the level.

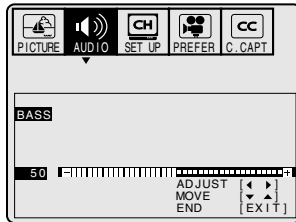

- ◀ makes the sound quality weaker or decreases the balance in the right channel, depending on the item selected.
- ▶ makes the sound quality stronger or decreases the balance in the left channel, depending on the item selected.

Using the surround sound feature

The surround sound feature expands the audio listening field wider and deeper to create exceptional sound quality from the TV's speakers. The feature uses stereo signals from a TV broadcast or video input.

To turn on the surround sound feature:

1. Select the STEREO mode following the steps under “Selecting stereo/SAP broadcasts” on page 27.
2. Press MENU, then press ◀ or ▶ until the AUDIO menu appears.
3. Press ▲ or ▼ to highlight SURROUND.
4. Press ◀ or ▶ to highlight ON.

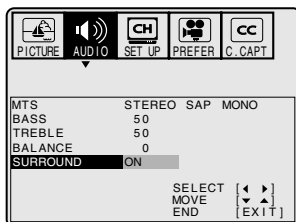

To turn off the surround sound feature:

Choose OFF in step 4 above.

In general, you should leave your TV set to SURROUND so it can automatically produce surround stereo or monaural sound, depending on the broadcast type.

Viewing the demonstration mode

The demonstration mode (DEMO) is an option available on the SETUP menu. If you select this mode, the TV will demonstrate several of the TV's features.

To stop the demonstration mode:

Select DEMO STOP in the SETUP menu, or press the RECALL, EXIT, or POWER buttons.

Understanding the last mode memory feature

If the power is cut off while you are viewing the TV and the power is resupplied, the last mode memory feature will turn the TV on automatically.

If the power is going to be off for a long time or you are going to be away from home for a long time, remove the power plug from the wall outlet to prevent the TV from turning on in your absence.

Appendix

Cleaning and care

WARNING:

TV sets use high voltage. Do not try to remove the cabinet back. Refer servicing to qualified service technicians.

To clean the TV screen:

1. Unplug the TV to avoid possible shock hazard.
2. Use a clean cellulose sponge or chamois cloth dampened with a solution of mild detergent and warm water to clean the TV screen and trim. Do not use too much water because water spills into the cabinet can cause damage to the TV.
3. Wipe off any excess moisture with a clean dry cloth.
4. Polish the cabinet with a quality furniture polish to maintain the finish and appearance of the cabinet.

Caution:

Never use strong solvents such as thinner, benzene, or other chemicals on or near the cabinet. These chemicals can damage the finish of the cabinet.

Troubleshooting

Before calling a service technician, please check the following table for a possible cause of the problem and some solutions.

Problem	Solution
TV will not turn on	<ul style="list-style-type: none">• Make sure the power cord is plugged in, then press POWER.• The remote control batteries may be dead. Replace the batteries.
No picture, no sound	<ul style="list-style-type: none">• Check the antenna/cable connections.
No sound, picture OK	<ul style="list-style-type: none">• The sound may be muted. Press VOLUME.• The station may have broadcast difficulties. Try another channel.
Poor sound, picture OK	<ul style="list-style-type: none">• The station may have broadcast difficulties. Try another channel.
Poor picture, sound OK	<ul style="list-style-type: none">• Check the antenna connections.• The station may have broadcast difficulties. Try another channel.• Adjust the PICTURE menu.
Poor reception of broadcast channels	<ul style="list-style-type: none">• The station may have broadcast difficulties. Try another channel.• Check the antenna connections.• If you are using a VCR, make sure the TV/VCR button is set correctly.
Cannot receive above channel 13	<ul style="list-style-type: none">• Make sure TV/CABLE is set to TV mode.
Unable to select a certain channel	<ul style="list-style-type: none">• The channel may be locked out with the V-Chip feature, or erased with the add/erase feature.
Multiple images	<ul style="list-style-type: none">• The station may have broadcast difficulties. Try another channel.• Use a highly directional outdoor antenna.

- | | |
|---|--|
| Poor color or no color | <ul style="list-style-type: none"> • The station may have broadcast difficulties. Try another channel. • Adjust the TINT and/or COLOR in the PICTURE menu. • If you change the direction of the TV while it is turned on, the picture could suffer from color shading. If so, turn off the TV and allow it to cool down for several hours before turning it on again. |
| No stereo or SAP sound from a known MTS broadcast | <ul style="list-style-type: none"> • Make sure the MTS feature is set properly. |
| The remote control does not operate | <ul style="list-style-type: none"> • Check if the TV/CABLE/VCR switch is properly set. • There may be an obstruction between the remote control and the remote control sensor. • The remote control batteries may be dead. Replace the batteries. |
| V-Chip PIN code does not work | <ul style="list-style-type: none"> • Change or reset your PIN code. (See “Selecting a PIN code,” page 16.) |

Specifications

Television system	NTSC standard
Channel coverage	VHF: 2 through 13 UHF: 14 through 69 Cable TV: mid band (A-8 through A-1, A through 1) super band (J through W) hyper band (AA through ZZ, AAA, BBB) ultra band (65 through 94, 100 through 125)
Power source	120 AC, 60 Hz
Power consumption	100 W (average)
Audio power	5W + 5W
Speaker type	2-3/8 x 4-3/4 inches (60 x 120 mm)
Video/Audio terminals	S-VIDEO INPUT Y-INPUT: 1V (p-p), 75 ohm, negative sync. C-INPUT: 0.286V (p-p) (burst signal), 75 ohm VIDEO/AUDIO INPUT VIDEO: 1V (p-p), 75 ohm, negative sync. AUDIO: 150 mV (rms) (30% modulation equivalent, 47k ohm) VIDEO/AUDIO OUTPUT VIDEO: 1V (p-p), 75 ohm, negative sync. AUDIO: 150 mV (rms) (30% modulation equivalent, 47k ohm)
Dimensions	Width: 34-9/16 inches (878 mm) Height: 30-1/2 inches (775 mm) Depth: 25-3/4 inches (654 mm)
Weight	158 lbs. (71.7 kg)
Supplied accessories	Remote control with two size “AA” alkaline batteries
Optional TV stand	ST-3615

Design and specifications are subject to change without notice.

Limited United States warranty

Toshiba America Consumer Products, Inc. (“TACP”) and Toshiba Hawaii Inc. (“THI”) make the following limited warranties. These limited warranties extend to the original consumer purchaser or any person receiving this set as a gift from the original consumer purchaser and to no other purchaser or transferee.

Limited one-year warranty

TACP and THI warrant this product and its parts against defects in materials or workmanship for a period of one (1) year after the date of original retail purchase. During this period, TACP and THI will repair a defective product or part, at their option, with a new or refurbished part, without charge to you. “Authorized TACP/THI service station personnel will come to your home when warranty service is required. Depending on the type of repair required, the service will either be performed in your home or the set will be taken to the authorized TACP/THI service station for repair and returned to your home at no cost to you.”

Limited two-year warranty of picture tube

TACP and THI further warrant the picture tube in this product against defects in materials or workmanship for a period of two (2) years after the date of original retail purchase. During this period, TACP and THI will replace a defective picture tube, at their option, with a new or refurbished picture tube without charge to you, except that if a defective picture tube is replaced after one (1) year from the date of the original retail purchase, you pay labor charges involved in the replacement.

Rental units

The warranty for rental units begins with the first rental of thirty (30) days from the date of shipment to the rental firm, whichever comes first.

Commercial units

Products sold and used for commercial use have a limited ninety (90) day warranty for all parts, labor and picture tube.

Owner’s manual and registration card

You should read this owner’s manual thoroughly before operating this product. You should complete and mail the enclosed registration card within ten days after you, or the person who has given you this product as a gift, purchased this product. This is one way to enable TACP/THI to provide you with better customer service and improved products. Failure to return the registration card will not affect your rights under this warranty.

Your responsibility

The above warranties are subject to the following conditions:

- You must retain your bill of sale or provide other proof of purchase.
- All warranty servicing of this product must be made by an Authorized TACP/THI Service Station.
- **These warranties are effective only if the product is purchased and operated in the U.S.A. or Puerto Rico.**
- Labor service charges for set installation, set up, adjustment of customer controls and installation or repair of antenna systems are not covered by this warranty. Reception problems caused by inadequate antenna systems are your responsibility.
- Warranties extend only to defects in materials or workmanship as limited above and do not extend to any product or parts which have been lost or discarded by you or to damage to products or parts caused by misuse, accident, damage caused by Acts of God, such as lightning or fluctuations in electric power, improper installation, improper maintenance or use in violation of instructions furnished by us; or to units which have had the serial number removed, altered, defaced or rendered illegible.

How to obtain warranty service

If after following all of the operating instructions in this manual and checking the section “Troubleshooting,” you find that service is needed;

- Call the TACP toll free number **1-800-631-3811** after you find a defective product or part to find the nearest Toshiba Authorized Service Station.
- Please present your bill of sale or other proof to the Authorized Service Station.

Authorized TACP/THI service station personnel will come to your home when warranty service is required. Depending on the type of repair required, the service will either be performed in your home or the set will be taken to the TACP/THI Authorized service station for repair and returned to your home at no cost to you.

In the Continental U.S.

If your TV requires service, call toll free:
1-800-631-3811



In Hawaii

If your TV requires service, call:
(808) 521-5377
327 Kamakee Street, Honolulu, HI 96814

Limitations

All warranties implied by state law, including the implied warranties of merchantability and fitness for a particular purpose, are expressly limited to the duration of the limited warranties set forth above. With the exception of any warranties implied by state law as hereby limited, the foregoing warranty is exclusive and in lieu of all other warranties, guarantees, agreements and similar obligations of manufacturer or seller with respect to the repair or replacement of any parts. In no event shall TACP or THI be liable for consequential or incidental damages.

No person, agent, distributor, dealer or company is authorized to change, modify or extend the terms of these warranties in any manner whatsoever. The time within which action must be commenced to enforce any obligation of TACP or THI arising under this warranty or under any statute, or law of the United States or any state thereof, is hereby limited to 90 days from the date you discover or should have discovered, the defect. This limitation does not apply to implied warranties arising under state law.

This warranty gives you specific legal rights and you may also have other rights which may vary from state to state. Some states do not allow limitation on how long an implied warranty lasts, when an action may be brought, or the exclusion or limitation of incidental or consequential damages, so the above provisions may not apply to you.

Attention Canadian customers



Canadian consumers are requested to complete the special Canadian "Warranty Registration Form" enclosed, and forward this completed form with a copy of bill of sale to TOSHIBA OF CANADA to "Register and Validate" their warranty.

Products purchased in the U.S.A. and used in Canada are not covered by these warranties.
Products purchased in Canada and used in the U.S.A. are not covered by these warranties.

Index

A

adding and erasing channels manually	13
adding channels to the TV's memory	13
adjusting	
channel settings	15
picture preferences	24
picture quality	24
sound	27
audio amplifier, connecting	6
auto power off	25

B

batteries, installing into the remote control	7
blocking	
channels	20
programs by ratings	17
unrated movies or programs	20

C

cable converter box and a VCR, connecting	3
cable converter box, connecting	3
camcorder, connecting	6
care and cleaning of your TV	30
changing	
channels	14
on-screen display language	12
position of the small picture (PIP)	23
channel settings, adjusting	15
channels	
adding or erasing manually	13
adding to the TV's memory	13
blocking with V-Chip	20
changing	14
favorite, programming	15
labeling	21
programming automatically	13
switching between two	15
cleaning and care of your TV	30
closed caption feature, using	26
code table	
cable TV converter	9
VCR	9
color temperature, adjusting	24

connecting	
audio amplifier	6
cable converter box	3
cable converter box and a VCR	3
camcorder	6
DVD with ColorStream and a VCR	4
DVD/satellite receiver and a VCR	4
TV	2
VCR	2
VCRs, two	5

D

demonstration mode, viewing	29
displaying on-screen information	25
DVD with ColorStream and a VCR, connecting	4
DVD/satellite receiver and a VCR, connecting	4

F

favorite channels, programming	15
freezing the small picture (PIP)	23

L

labeling channels	21
language, changing the on-screen display	12
last mode memory feature, understanding	29
location for TV, selecting	1

M

muting the sound	27
------------------------	----

O

off-timer, setting	25
on-screen display language, changing	12
on-screen information, displaying	25

P

picture	
adjusting	24
color temperature, selecting	24
preferences, adjusting	24
quality, adjusting	24
picture-in-picture (PIP)	
changing the position of the small picture	23
freezing the small picture	23
main and small pictures, switching	23
watching	22

PIN code, selecting	16
power, auto off	25
programming	
channels automatically	13
favorite channels	15
remote control for use with	
a VCR or cable TV converter	8
programs, blocking with V-Chip	17

R

ratings	
blocking programs by	17
MPAA	18
TV	18
unrated movies or programs	20
youth TV	18
remote control	
batteries, installing	7
learning about	11
preparing for use	7
programming for a VCR or cable TV converter	8
using	7
using with a VCR or cable TV converter	7

S

SAP, selecting	27
satellite receiver/DVD and a VCR, connecting	4
sound	
adjusting	27
muting	27
stereo/SAP broadcasts, selecting	27
surround, using	28
specifications	31
stereo sound, selecting	27
surround sound, using	28
switching between two channels	15
switching the main and small pictures (PIP)	23

T

troubleshooting	30
TV	
connecting	2
location, selecting	1
TV/VIDEO button, using	12

V

V-Chip	
blocking channels	20
blocking programs by ratings	17
selecting a PIN code	16
using	16
VCR and a cable converter box, connecting	3
VCR and a DVD with ColorStream, connecting	4
VCR and a DVD/satellite receiver, connecting	4
VCR, connecting	2
VCRs, connecting two	5
video input, watching	25

W

warranty	32
watching	
picture-in-picture (PIP)	22
video input	25

**Toshiba America
Consumer Products, Inc.**

Head Office
82 Totowa Road
Wayne, NJ 07470

Factory Service Center
1420B Toshiba Drive
Lebanon, TN 37087

Toshiba Hawaii, Inc.

Head Office
327 Kamakee Street
Honolulu, HI 96814

Toshiba of Canada, Ltd.

Head Office
191 McNabb Street
Markham, Ontario L3R 8H2
Canada

Service Centers

Toronto
191 McNabb Street
Markham, Ontario L3R 8H2
Canada
Tel: (905) 470-5400

Montreal
1643 North Service Road
Trans-Canada Highway
Dorval, Quebec H9P 1J1
Canada
Tel: (514) 856-4100

Vancouver
22171 Fraserwood Way
Richmond, British Columbia V6W 1J5
Canada
Tel: (604) 303-2500

Manufactured by:

TOSHIBA

**Toshiba America
Consumer Products, Inc.**

PRINTED IN USA
(99-06)B

23563695

Free Manuals Download Website

<http://myh66.com>

<http://usermanuals.us>

<http://www.somanuals.com>

<http://www.4manuals.cc>

<http://www.manual-lib.com>

<http://www.404manual.com>

<http://www.luxmanual.com>

<http://aubethermostatmanual.com>

Golf course search by state

<http://golfingnear.com>

Email search by domain

<http://emailbydomain.com>

Auto manuals search

<http://auto.somanuals.com>

TV manuals search

<http://tv.somanuals.com>