

# GENERAL PRECAUTIONS REGARDING THE INSTALLATION AND SERVICE FOR THE COPIER FC-210/310

The installation and service should be done by a qualified service technician.

## 1. Transportation/Installation

- When transporting/installing the copier, move it by the casters while lifting the stoppers. The copier is quite heavy and weighs approximately 187 kg (413 lb), therefore pay full attention when handling it.
- Be sure to use a dedicated outlet with AC 115V or 120V/20A (220V, 230V, 240V/10A) or more for its power source.
- The copier must be grounded for safety. Never ground it to a gas pipe or a water pipe.
- Select a suitable place for installation. Avoid excessive heat, high humidity, dust, vibration and direct sunlight.
- Also provide proper ventilation as the copier emits a slight amount of ozone.
- To insure adequate working space for the copying operation, keep a minimum clearance of 80 cm (32") on the left, 80 cm (32") on the right and 10 cm (4") in the rear.
- The socket-outlet shall be installed near the copier and shall be easily accessible.

## 2. Service of Machines

- Basically, be sure to turn the main switch off and unplug the power cord during service.
- Be sure not to touch high-temperature sections such as the exposure lamp, the fuser unit, the damp heater and their periphery.
- Be sure not to touch high-voltage sections such as the chargers, high-voltage transformer, exposure lamp control inverter, inverter for the LCD backlight and power supply unit. Especially, the board of these components should not be touched since the electric charge may remain in the condensers, etc. on them even after the power is turned OFF.
- Be sure not to touch rotating/operating sections such as gears, belts, pulleys, fan, etc.
- Be careful when removing the covers since there might be the parts with very sharp edges underneath.
- When servicing the machines with the main switch turned on, be sure not to touch live sections and rotating/operating sections. Avoid exposure to laser radiation.
- Use suitable measuring instruments and tools.
- Avoid exposure to laser radiation during servicing.
  - Avoid direct exposure to the beam.
  - Do not insert tools, parts, etc. that are reflective into the path of the laser beam.
  - Remove all watches, rings, bracelets, etc. that are reflective.

### 3. Main Service Parts for Safety

- The breaker, door switch, fuse, thermostat, thermofuse, thermistor, etc. are particularly important for safety. Be sure to handle/install them properly.

If these parts are shorted circuit and/or made their functions out, they may burn down, for instance, and may result in fatal accidents.

Do not allow a short circuit to occur.

Do not use the parts not recommended by Toshiba TEC Corporation.

### 4. Cautionary Labels

- During servicing, be sure to check the rating plate and the cautionary labels such as “Unplug the power cord during service”, “Hot area”, “Laser warning label” etc. to see if there is any dirt on their surface and whether they are properly stuck to the copier.

### 5. Disposition of Consumable Parts/Packing Materials

- Regarding the recovery and disposal of the copier, supplies, consumable parts and packing materials, it is recommended to follow the relevant local regulations or rules.

### 6. When parts are disassembled, reassembly is basically the reverse of disassembly unless otherwise noted in this manual or other related documents. Be careful not to reassemble small parts such as screws, washers, pins, E-rings, star washers in the wrong places.

### 7. Basically, the machine should not be operated with any parts removed or disassembled.

### 8. Precautions Against Static Electricity

- The PC board must be stored in an anti-electrostatic bag and handled carefully using a wristband, because the ICs on it may become damaged due to static electricity.

**Caution: Before using the wristband, pull out the power cord plug of the copier and make sure that there are no uninsulated charged objects in the vicinity.**

**Caution :** Dispose of used batteries and RAM-ICs including lithium batteries according to the manufacturer's instructions.

**Attention :** Se débarrasser de batteries et RAM-ICs usés y compris les batteries en lithium selon les instructions du fabricant.

**Vorsicht :** Entsorgung des gebrauchten Batterien und RAM-ICs (inklusive der Lithium-Batterie) nach Angaben des Herstellers.

**1. ERROR CODE AND SELF-  
DIAGNOSIS**

**2. ADJUSTMENT**

**3. PREVENTIVE MAINTENANCE  
(PM)**

**4. TROUBLESHOOTING**

**5. UPDATING THE FIRMWARE**

**6. POWER SUPPLY UNIT**

**7. WIRE HARNESS  
CONNECTION DIAGRAMS**

## CONTENTS

<b>1. ERROR CODE AND SELF-DIAGNOSIS .....</b>	<b>1-1</b>
1.1 Error Code List .....	1-1
1.2 Self-Diagnosis Mode .....	1-6
1.2.1 Input check (Test mode 03) .....	1-8
1.2.2 Output check (Test mode 03) .....	1-15
1.2.3 Test print mode (04) .....	1-19
1.2.4 Adjustment mode (05) .....	1-20
1.2.5 Setting mode (08) .....	1-33
<b>2. ADJUSTMENT .....</b>	<b>2-1</b>
2.1 Adjustment Order (Image Related Adjustment) .....	2-1
2.2 Adjustment of the Auto-Toner Sensor .....	2-2
2.2.1 Automatic removing of developer material .....	2-2
2.2.2 Initialization of auto-toner sensor .....	2-3
2.3 Adjustment of Image Quality Control .....	2-7
2.4 Adjustment of Color Registration Control .....	2-8
2.5 Image Dimensional Adjustment .....	2-9
2.5.1 Paper alignment (paper buckle) at the registration roller .....	2-11
2.5.2 Registration motor speed adjustment .....	2-12
2.5.3 Printer section related adjustment .....	2-13
2.5.4 Scanner related adjustment .....	2-16
2.6 Image Quality Adjustment .....	2-24
2.6.1 Automatic gamma adjustment .....	2-24
2.6.2 Density adjustment .....	2-25
2.6.3 Color balance adjustment .....	2-26
2.6.4 Offset adjustment for background processing .....	2-27
2.6.5 Judgment threshold for ACS .....	2-27
2.6.6 AI mode setting .....	2-28
2.6.7 Sharpness adjustment .....	2-39
2.7 High-Voltage Transformer Settings .....	2-30
2.7.1 Overview .....	2-30
2.7.2 Settings after replacing main high-voltage transformers .....	2-30
2.7.3 Settings after replacing transfer transformer .....	2-31
2.8 Adjustment of the Developer Unit .....	2-32
2.8.1 Doctor-to-Sleeve Gap .....	2-32
2.9 Adjustment of the Scanner Section .....	2-33
2.9.1 Carriages .....	2-33
2.9.2 Lens unit .....	2-37
2.10 Adjustment of the Paper Feeding System .....	2-39
2.10.1 Cassette sidewise deviation .....	2-39
2.11 Key Copy Counter (MU-8, MU-10) .....	2-40

<b>3. PREVENTIVE MAINTENANCE (PM)</b> .....	<b>3-1</b>
3.1 Types of Preventive Maintenance .....	3-1
3.2 Outline of the Maintenance Order .....	3-2
3.3 Preventive Maintenance Checklist .....	3-2
3.4 PM Kit .....	3-11
3.5 List of Adjustment Tools .....	3-12
3.6 Precautions for Storing/Handling Supplies and Parts .....	3-13
3.6.1 Precautions for storing TOSHIBA supplies .....	3-13
3.6.2 Checking and cleaning of the photoconductive drum .....	3-13
3.6.3 Checking and cleaning of the drum cleaning blade and transfer belt cleaning blade ....	3-15
3.6.4 Checking and replacing the transfer belt .....	3-15
3.6.5 Checking and replacing the transfer roller and fuser roller .....	3-15
3.6.6 Checking and cleaning of the fuser belt and lower heat roller .....	3-15
3.6.7 Checking and replacing the oil roller and cleaning roller .....	3-16
<b>4. TROUBLESHOOTING</b> .....	<b>4-1</b>
4.1 Diagnosis and Prescription for Each Error Code .....	4-1
4.1.1 Paper transport jam inside the copier .....	4-1
4.1.2 Paper feeding jam .....	4-4
4.1.3 Paper transport jam (Paper not reaching the registration sensor after feeding) .....	4-6
4.1.4 Cover open jam .....	4-7
4.1.5 Paper jam in ADU and reversing area .....	4-9
4.1.6 Original jam in the RADF .....	4-10
4.1.7 Paper jam in the finisher .....	4-12
4.1.8 Special sheet jam .....	4-20
4.1.9 Drive system related service call .....	4-21
4.1.10 Paper feeding system related service call .....	4-23
4.1.11 Scanner related service call .....	4-25
4.1.12 Copy process related service call .....	4-26
4.1.13 Fuser unit related service call .....	4-29
4.1.14 Communications related service call .....	4-31
4.1.15 ADF related service call .....	4-32
4.1.16 Other service call (1) .....	4-33
4.1.17 Laser optical unit related service call .....	4-34
4.1.18 Finisher related service call .....	4-36
4.1.19 Image quality related service call .....	4-54
4.1.20 Other service call (2) .....	4-62
4.1.21 Image processing related service call .....	4-63
4.2 Troubleshooting of Image .....	4-64

<b>5. UPDATING THE FIRMWARE .....</b>	<b>5-1</b>
5.1 Installing Software for Firmware Update .....	5-2
5.1.1 Outline .....	5-2
5.1.2 Requirements .....	5-2
5.1.3 Dial-up networking function .....	5-4
5.1.4 Installing dial-up networking .....	5-8
5.1.5 Setting dial-up networking .....	5-10
5.1.6 Installing software for FTP server .....	5-14
5.2 Operation Procedure in [3][9] Mode .....	5-18
5.2.1 Outline .....	5-18
5.2.2 Preparation .....	5-18
5.2.3 Updating firmware .....	5-20
5.2.4 Display .....	5-28
5.3 Updating the Firmware Using the Downloading Jig .....	5-32
5.3.1 System firmware .....	5-33
5.3.2 Engine firmware .....	5-39
<b>6. POWER SUPPLY UNIT .....</b>	<b>6-1</b>
6.1 Output Channel .....	6-1
<b>7. WIRE HARNESS CONNECTION DIAGRAMS .....</b>	<b>7-1</b>
7.1 AC Wire Harness .....	7-2
7.2 DC Wire Harness .....	Appendix
<b>&lt;Appendix&gt; SPECIFICATIONS · ACCESSORIES · OPTIONS · SUPPLIES .....</b>	<b>A-1</b>
1. Specifications .....	A-1
2. Accessories .....	A-5
3. Options .....	A-6
4. Replacement Units/Supplies .....	A-6
5. System List .....	A-7

In this manual, colors are sometimes described using abbreviations as listed below:

Yellow : Y      Magenta : M      Cyan : C      Black : K

## 1. ERROR CODES AND SELF-DIAGNOSIS

### 1.1 Error Code List

While the “CLEAR PAPER” or “CALL SERVICE” symbol is flashing, pressing the [CLEAR] key and the digital key [8] at the same time shows one of the following error codes on the copy-quantity indicator as long as those keys are pressed.

Classification	Error code	Contents
Paper transport jam inside the copier	E01	Paper leading edge not reaching the exit sensor
	E02	Paper trailing edge not passing the exit sensor
	E03	Paper remaining inside the copier at power ON
	EB7	Restart time-out error
Paper feeding jam	E11	Paper misfeed from the ADU
	E12	Paper misfeed from the bypass tray
	E13	Paper misfeed from the 1st cassette
	E14	Paper misfeed from the 2nd cassette
	E15	Paper misfeed from the 3rd cassette
	E16	Paper misfeed from the 4th cassette
	E19	Paper misfeed from the LCF
Paper transport jam (Paper not reaching the registration sensor after feeding)	E21	Paper transport jam from the LCF
	E22	Paper transport jam from the 1st cassette
	E23	Paper transport jam from the 2nd cassette
	E24	Paper transport jam from the 3rd cassette
	E25	Paper transport jam from the 4th cassette
	E26	Paper transport jam from the bypass tray
Cover open jam	E41	Front cover opened during printing
	E42	Side door opened during printing
	E43	ADU pulled out during printing
	E45	LCF jam access cover opened during printing
	E46	Bypass unit opened during printing
Paper transport jam in the ADU and reversing area	E50	Paper not reaching the ADU
	E51	Paper not reaching the ADU stack
	E52	Paper not reaching the ADU path sensor
	E54	ADU paper transport jam

Classification	Error code	Contents
Original jam in the ADF	E71	Original not reaching the aligning sensor
	E72	Original not reaching the exit sensor
	E73	Original not passing the exit sensor
Paper jam in the finisher	E9F	Punching jam
	EA1	Paper transport delay jam
	EA2	Paper transport stop jam
	EA3	Paper remaining inside the finisher at power ON
	EA4	Finisher front door opened during printing
	EA5	Finisher stapling jam
	EA6	Finisher early arrival jam
	EA8	Saddle stitcher stapling jam
	EA9	Saddle stitcher front door opened during printing
	EAA	Paper remaining in the saddle stitcher at power ON
	EAB	Saddle stitcher transport stop jam
	EAC	Saddle stitcher transport delay jam
	EAE	Finisher receive time-out jam
Special sheet jam	EC2	OHP film jams when not fed from bypass tray or 2nd cassette
	EC3	OHP film used in non-OHP mode
Drive system related service call	C05	ADU motor rotation abnormal
	C06	Feed motor rotation abnormal
	C0A	Developer motor rotation abnormal
Paper feeding system related service call	C11	ADU paper side guide operation abnormal
	C12	ADU paper end guide operation abnormal
	C13	1st cassette tray operation abnormal
	C14	2nd cassette tray operation abnormal
	C15	3rd cassette tray operation abnormal
	C16	4th cassette tray operation abnormal
	C18	LCF tray operation abnormal
Scanner related service call	C27	Carriage home position sensor not turning OFF within a fixed time
	C28	Carriage home position sensor not turning ON within a fixed time
	C29	Exposure lamp disconnection detected



Classification	Error code	Contents
Copy process related service call	C31	Used toner transport motor rotation abnormal
	C33	Developer removal shutter abnormal
	C35	Transfer belt unit contact/release operation abnormal
	C38	Auto-toner error (K)
	C39	Auto-toner error (C)
	C3A	Auto-toner error (M)
	C3B	Auto-toner error (Y)
	C3C	Main charger wire cleaning abnormal (K)
	C3D	Main charger wire cleaning abnormal (C)
	C3E	Main charger wire cleaning abnormal (M)
C3F	Main charger wire cleaning abnormal (Y)	
Fuser unit related service call	C41	Thermistor or heater abnormal when warming-up is started
	C42	Thermistor abnormal after the copier has become ready
	C43	Thermistor abnormal during warming-up after abnormality judgment
	C44	Heater abnormal during warming-up after abnormality judgment
	C46	Heater abnormal (low temperature) after the copier has become ready
	C47	Rear thermistor abnormal after the copier has become ready
	C48	Heater abnormal (high temperature)
	C7	Error C7
Communications related service call	C57	Communications error between LGC-CPU and IPC board
	C5A	Communications error between LGC-CPU and printer controller
	C5B	LGC-CPU signal transmission error to IMC-CPU
	C5C	LGC-CPU signal reception error from IMC-CPU
ADF related service call	C72	Aligning sensor automatic adjustment error
	C73	EEPROM initializing error
	C74	Paper exit sensor automatic adjustment error
Other service call (1)	C94	LGC-CPU abnormal
	C9A	Main memory abnormal
	C9B	LGC-CPU protocol abnormal
	C9D	IMC-CPU protocol abnormal
	C9E	IMC board connection abnormal

Classification	Error code	Contents
Laser optical unit related service call	CA1	Polygonal motor rotation abnormal
	CA2	H-SYNC abnormal
	CD1	Laser calibration error (K)
	CD2	Laser calibration error (C)
	CD3	Laser calibration error (M)
	CD4	Laser calibration error (Y)
Finisher related service call	CB1	Feed motor abnormal
	CB2	Delivery motor abnormal
	CB3	Tray lift motor abnormal
	CB4	Alignment motor abnormal
	CB5	Staple motor abnormal
	CB6	Stapler shift motor abnormal
	CB7	Height sensor abnormal
	CB8	Backup RAM data abnormal
	CB9	Saddle stitcher/paper pushing plate motor abnormal
	CBA	Saddle stitcher/stitcher motor (front) abnormal
	CBB	Saddle stitcher/stitcher motor (rear) abnormal
	CBC	Saddle stitcher/alignment motor abnormal
	CBD	Saddle stitcher/guide motor abnormal
	CBE	Saddle stitcher/paper folding motor abnormal
	CBF	Saddle stitcher/paper positioning plate motor abnormal
	CD5	Saddle stitcher/sensor connector connection error
	CD6	Saddle stitcher/microswitch abnormal
	CD7	Communication error between finisher and saddle stitcher
	CD9	Swing motor abnormal
	CDA	Horizontal registration motor abnormal
CDB	Punch motor abnormal	
Image quality related service call	CE1	Image quality sensor abnormal (OFF level)
	CE2	Image quality sensor abnormal (no pattern level)
	CE4	Image quality control test pattern abnormal
	CE5	Temperature/humidity sensor upper-limit abnormal
	CE6	Drum thermistor abnormal (Y)
	CE9	Drum thermistor abnormal (K)
	CF1	Color registration control abnormal
Other service call (2)	F07	Communications error between system-CPU and LGC-CPU
	F09	Communications error between system-CPU and scanner-CPU
	F10	HDD formatting error
	F11	Communications error between system-CPU and scanner-CPU
	F12	Communications error between system-CPU and scanner-CPU
Image processing related service call	F51	Communications error between system-CPU and AI board during pre-scanning

<<Error history>>

In the setting mode (08-253), the latest twenty groups of error data will be displayed.

Display example

<u>EA1</u>	<u>01 08 26 17 57 32</u>	<u>64</u>	<u>64</u>	<u>236210000000</u>
Error code	YY MM DD HH MM SS	MMM	NNN	ABCDEFGHIJLOP
3 digits	12 digits (Year is indicated with its last two digits.)	3 digits	3 digits	12 digits

A	Paper source 0: Not selected 1: Bypass feed 2: LCF 3: 1st 4: 2nd 5: 3rd 6: 4th 7: ADU feed
B	Paper size code 0: A5/ST 1: A5-R 2: ST-R 3: LT 4: A4 5: B5-R 6: LT-R 7: A4-R 8: OTHER/UNIV 9: B5 A: FOLIO/COMP B: LG C: B4 D: LD E: A3 F: 13"LG H: A6-R I: Card Z: Not selected
C	Sort mode / staple mode 0: Non-sort/Non-staple 1: Group 2: Sort 7: Front staple 8: Double staple 9: Rear staple A: Saddle stitch
D	ADF mode 0: Unused 1: AUTO FEED (SADF) 2: STACK FEED
E	APS / AMS mode 0: Not selected 1: APS 2: AMS
F	Duplex mode 0: Not selected 1: Book 2: Two-sided / Single-sided 4: Two-sided / Duplexed 8: Single-sided / Duplexed
G	Unused
H	Image shift 0: Unused 1: Book 2: Left 4: Right
I	Editing 0: Unused 1: Masking 2: Trimming 3: Mirror image 4: Negative / Positive
J	Edge erase / Dual-page 0: Unused 1: Edge erase 2: Dual-page 3: Edge erase & Dual-page
K	Unused
L	Function 0: Copying 1: Unused 2: Unused 3: Unused 4: Printing 5: Unused
MMM	Primary scanning reproduction ratio (Display in hexadecimal) (Mx256)+(Mx16)+M
NNN	Secondary scanning reproduction ratio (Display in hexadecimal) (Nx256)+(Nx16)+N
O	Color mode 0: Auto color 1: Full color 2: Black 3: Monocolor
P	AI board 0: Unused 1: Used

## 1.2 Self-Diagnosis Mode

Mode	Starting	Contents	Exit
Control panel check mode	[0]+[1]+[POWER]	All control panel LEDs are lit, and all LCD pixels are turned ON/OFF repeatedly.	[CLEAR] or [POWER]OFF/ON
Test mode	[0]+[3]+[POWER]	Input/output signals are checked.	[POWER]OFF/ON
Test print mode	[0]+[4]+[POWER]	A test pattern print is made.	[POWER]OFF/ON
Adjustment mode	[0]+[5]+[POWER]	Adjustment of various items	[POWER]OFF/ON
Setting mode	[0]+[8]+[POWER]	Setting of various items	[POWER]OFF/ON
List printing mode	[9]+[START]+[POWER]	Printing of list of 05 and 08 code data	[POWER]OFF/ON

**Note:** Starting for various modes:

While pressing simultaneously the two digital keys corresponding to the mode you want to set (for example, [0] and [5]), turn ON the main switch [POWER].

<Operation procedure>

- Control panel check mode (01) :

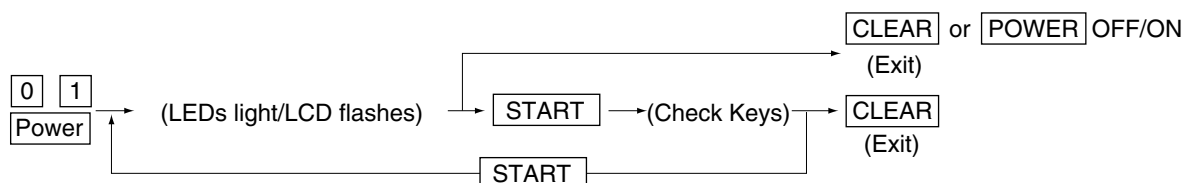

**Notes:** 1. During the "Check keys" state, [CLEAR] alone can exit.  
During the "LEDs light/LCD flashes" state, [CLEAR] can clear the mode.

2. Check keys :

Any key with LED (when it is pressed, the LED goes out.)

Any key without LED (when it is pressed, an indication is displayed in the message area.)

- Test mode (03) : Refer to "1.2.1 Input check (Test mode 03)" and "1.2.2 Output check (Test mode 03)".

- Test print mode (04) : Refer to "1.2.3 Test print mode (04)".

- Adjustment mode (05) : Refer to "1.2.4 Adjustment mode (05)".

- Setting mode (08) : Refer to "1.2.5 Setting mode (08)".

• List printing mode

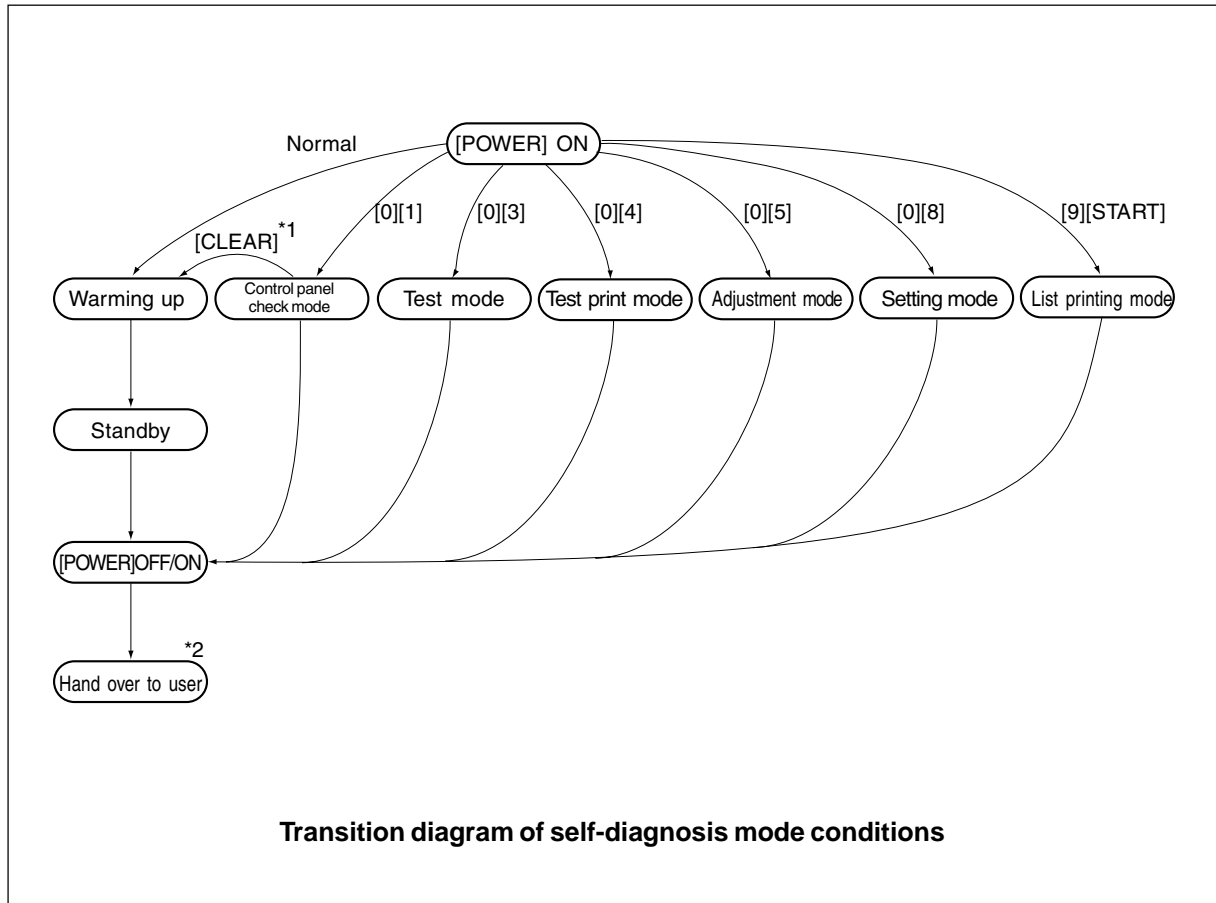
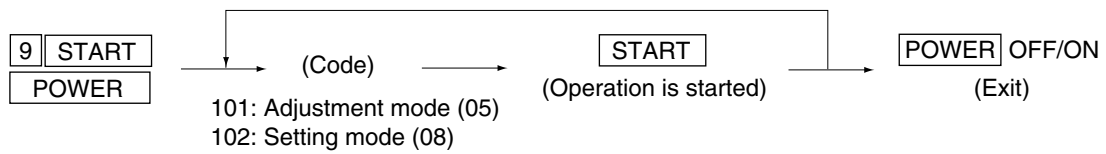

\*1 : During the activation of the “Control panel check mode”, copying is not possible. But after pressing [CLEAR] to make the copier ready, you can make copies.

\*2 : After having used the self-diagnosis mode, be sure to turn OFF and then ON the power before returning the copier to the customer.

## 1. 2. 1 Input check (Test mode 03)

The status of each item can be checked by setting ON/OFF of each [FULL COLOR], [AUTO COLOR], [ENERGY SAVER], and then pressing each of the corresponding digital key in this test mode 03.

**Note:** When icon is displayed with black letter on white background, it indicates the value is 0, while in reverse black and white, it indicates the value is 1.

[FULL COLOR]key: OFF, [AUTO COLOR]key: OFF, [ENERGY SAVER]key: OFF

Digital key	Icon	Item	Condition
[1]	A	—	
	B	—	
	C	—	
	D	—	
	E	1st cassette paper-empty sensor	1: No paper
	F	1st cassette tray-up limit sensor	1: Tray is upper limit.
	G	1st cassette feed-jam sensor	1: Paper present
	H	1st cassette detection switch	1: No cassette
[2]	A	—	
	B	—	
	C	—	
	D	—	
	E	2nd cassette paper-empty sensor	1: No paper
	F	2nd cassette tray-up limit sensor	1: Tray is upper limit.
	G	2nd cassette feed-jam sensor	1: Paper present
	H	2nd cassette detection switch	1: No cassette
[3]	A	—	
	B	—	
	C	—	
	D	—	
	E	3rd cassette paper-empty sensor	1: No paper
	F	3rd cassette tray-up limit sensor	1: Tray is upper limit.
	G	3rd cassette feed-jam sensor	1: Paper present
	H	3rd cassette detection switch	1: No cassette
[4]	A	—	
	B	—	
	C	—	
	D	—	
	E	4th cassette paper-empty sensor	1: No paper
	F	4th cassette tray-up limit sensor	1: Tray is upper limit.
	G	4th cassette feed-jam sensor	1: Paper present
	H	4th cassette detection switch	1: No cassette

Digital key	Icon	Item	Condition
[5]	A	Bypass paper-width sensor 0	Refer to Table 1.
	B	Bypass paper-width sensor 1	Refer to Table 1.
	C	Bypass paper-width sensor 2	Refer to Table 1.
	D	—	
	E	Bypass paper sensor	1: No paper
	F	Bypass unit open/close switch	1: Unit is opened.
	G	Side door open/close switch	1: Side door is opened.
	H	Bypass unit is installed or not	0: Unit is installed.
[6]	A	LCF paper-empty sensor	1: No paper
	B	LCF lower-limit sensor	1: Tray limit (lower)
	C	LCF tray-up sensor	1: Tray limit (upper)
	D	LCF tray-down switch	0: Switch is ON.
	E	LCF paper supply door sensor	1: Door is opened.
	F	LCF is installed or not	0: LCF is installed.
	G	ADU motor rotation status (Motor is rotating by output check 03)	0: Normal rotation
	H	ADU is installed or not	0: ADU is installed.
[7]	A	ADU paper-jam sensor	1: Paper present
	B	ADU paper-empty sensor	0: No paper
	C	ADU end switch	1: End guide is at home position.
	D	ADU side switch	1: Side guide is at home position.
	E	—	
	F	—	
	G	Key copy counter is installed or not	0: Key copy counter is installed.
	H	—	
[8]	A	Developer removal shutter home position sensor	0: Shutter is at closed position.
	B	—	
	C	Transfer belt unit is installed or not	0: Unit is installed.
	D	—	
	E	—	
	F	Developer motor rotation status (Motor is rotating by output check 03)	0: Normal rotation
	G	Transfer belt limit switch	0: Transfer belt is in black mode position.
	H	Transfer belt home position switch	0: Transfer belt is in color mode position.

Digital key	Icon	Item	Condition
[9]	A	External printer controller power ON/OFF	0: Controller power ON
	B	—	
	C	—	
	D	Front cover switch	1: Front cover is opened.
	E	OHP sensor	0: Opaque paper is installed.
	F	—	
	G	Registration sensor	1 : Paper present
	H	IPC board (Finisher installation kit) is installed or not	0: Board is installed.
[0]	A	ADU path sensor	1: Paper present
	B	—	
	C	Exit sensor	1: Paper present
	D	Paper-exit unit open/close switch	1: Paper-exit unit is opened.
	E	Toner bag limit sensor	1: Used toner full
	F	—	
	G	—	
	H	—	

Table 1. Relation between bypass paper-width sensor status and paper-width size.

Bypass paper-width sensor			Paper-width size
2	1	0	
1	0	0	A3/LD
0	1	0	A4-R/LT-R
1	0	1	A5-R/ST-R
0	1	1	Card size
0	0	0	B4/LG
1	1	0	B5-R



[FULL COLOR]key: OFF, [AUTO COLOR]key: OFF, [ENERGY SAVER]key: ON

Digital key	Icon	Item	Condition
[1]	A	—	
	B	—	
	C	—	
	D	—	
	E	—	
	F	—	
	G	—	
	H	—	
[2]	A	Developer cartridge Y is installed or not	0: Cartiridge is installed.
	B	Developer cartridge M is installed or not	0: Cartiridge is installed.
	C	Developer cartridge C is installed or not	0: Cartiridge is installed.
	D	Developer cartridge K is installed or not	0: Cartiridge is installed.
	E	Processing unit is installed or not	0: Unit is installed.
	F	Fuser unit is installed or not	0: Unit is installed.
	G	—	
	H	—	
[3]	A	Wire cleaner home position switch Y	0: Cleaning pad is at home position.
	B	Wire cleaner home position switch M	0: Cleaning pad is at home position.
	C	Wire cleaner home position switch C	0: Cleaning pad is at home position.
	D	Wire cleaner home position switch K	0: Cleaning pad is at home position.
	E	Wire cleaner limit switch Y	0: Cleaning pad is at limit position.
	F	Wire cleaner limit switch M	0: Cleaning pad is at limit position.
	G	Wire cleaner limit switch C	0: Cleaning pad is at limit position.
	H	Wire cleaner limit switch K	0: Cleaning pad is at limit position.
[4]	A	—	
	B	—	
	C	—	
	D	—	
	E	—	
	F	—	
	G	—	
	H	—	

Digital key	Icon	Item	Condition
[5]	A	—	
	B	—	
	C	—	
	D	—	
	E	—	
	F	—	
	G	—	
	H	—	
[6]	A	—	
	B	—	
	C	—	
	D	—	
	E	—	
	F	—	
	G	Front cover, paper-exit unit open/close check	1: Cover/unit is opened.
	H	Polygonal motor rotation status (Motor is rotating by output check 03)	0: Normal rotation
[7]	—	—	
[8]	—	Upper heat roller thermistor (center) check	Thermistor output value is displayed with 8 bits.
[9]	—	Upper heat roller thermistor (rear) check	Thermistor output value is displayed with 8 bits.
[0]	—	Lower heat roller thermistor (center) check	Thermistor output value is displayed with 8 bits.

[FULL COLOR]key: OFF, [AUTO COLOR]key: ON, [ENERGY SAVER]key: OFF

Digital key	Icon	Item	Condition
[1]	—	Lower heat roller thermistor (rear) check	Thermistor output value is displayed with 8 bits.
[2]	—	Temperature sensor check	Sensor output value is displayed with 8 bits.
[3]	—	Humidity sensor check	Sensor output value is displayed with 8 bits.
[4]	—	Drum thermistor Y check	Thermistor output value is displayed with 8 bits.
[5]	—	—	
[6]	—	—	
[7]	—	Drum thermistor K check	Thermistor output value is displayed with 8 bits.
[8]	—	—	
[9]	—	—	
[0]	—	—	

[FULL COLOR]key: OFF, [AUTO COLOR]key: ON, [ENERGY SAVER]key: ON

Digital key	Icon	Item	Condition
[1]	—	—	
[2]	—	Color registration sensor (front) (Sensor LED is turned ON by output check 03.)	"0" is displayed with reflection at transfer belt.
[3]	—	Color registration sensor (rear) (Sensor LED is turned ON by output check 03.)	"0" is displayed with reflection at transfer belt.
[4]	—	Image quality sensor	Sensor output value is displayed with 10 bits.
[5]	—	—	
[6]	A	ADF aligning sensor	1: Original present
	B	ADF exit sensor	1: Original present
	C	ADF open/close sensor	1: ADF is opened.
	D	ADF empty sensor	1: Original present
	E	ADF size sensor 1	
	F	—	
	G	ADF size sensor 2	
	H	ADF unit is installed or not	1: ADF unit is installed.
[7]	A	—	
	B	—	
	C	—	
	D	—	
	E	—	
	F	Carriage home position sensor	1: Carriages are at home position.
	G	—	
	H	Platen sensor	1: Platen cover is closed.
[8]	A	—	
	B	—	
	C	—	
	D	APS sensor (APS-R)	1: Original present
	E	APS sensor (APS-C)	1: Original present
	F	APS sensor (APS-3)	1: Original present
	G	APS sensor (APS-2) (for A4 series)	1: Original present
	H	APS sensor (APS-1)	1: Original present
[9]	—	SCM board input 24V check	Output value is displayed with 8 bits.
[0]	—	—	

[FULL COLOR]key: ON, [AUTO COLOR]key: OFF, [ENERGY SAVER]key: OFF

Digital key	Icon	Item	Condition
[1]	—	Auto-toner sensor Y	Sensor output value is displayed with 8 bits.
[2]	—	Auto-toner sensor M	Sensor output value is displayed with 8 bits.
[3]	—	Auto-toner sensor C	Sensor output value is displayed with 8 bits.
[4]	—	Auto-toner sensor K	Sensor output value is displayed with 8 bits.
[5]	—	—	
[6]	—	—	
[7]	—	—	
[8]	—	—	
[9]	—	—	
[0]	—	—	

<Operation procedure>

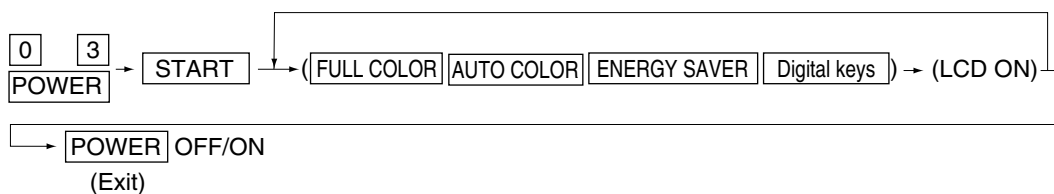

**Note:** After initialization, the copier goes into the test mode.

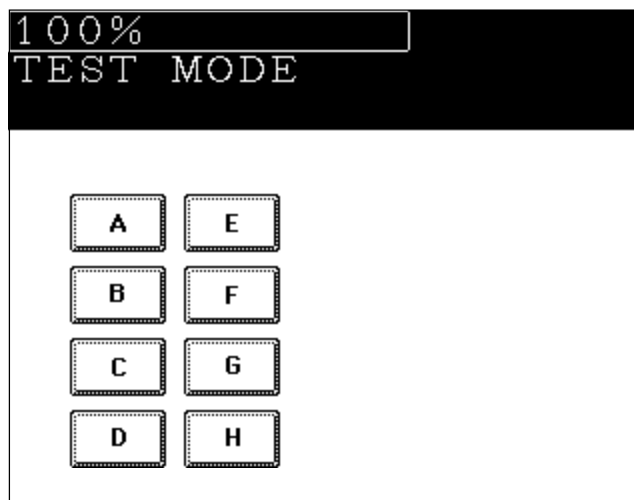

**Note:** When icon is displayed with white letter on black background on the control panel, it indicates the value is 1.

## 1. 2. 2 Output check (Test mode 03)

Output signal status can be checked by entering the following code in the test mode 03.

Code	Function	Code	Function	Procedure
		150	All output OFF	1
101	Drum motor and transfer belt motor rotation with normal printing speed ON	151	Code No. 101 function OFF	1
102	Drum motor and transfer belt motor rotation with OHP printing speed (low) ON	152	Code No. 102 function OFF	1
103	Paper feed motor ON	153	Code No. 103 function OFF	1
104	Fuser motor ON	154	Code No. 104 function OFF	1
105	Developer motor (color mode) ON	155	Code No. 105 function OFF	1
106	Developer motor (black mode) ON	156	Code No. 106 function OFF	1
107	Registration motor ON	157	Code No. 107 function OFF	1
108	Used toner transport motor ON	158	Code No. 108 function OFF	1
109	ADU motor ON	159	Code No. 109 function OFF	1
110	Toner motor Y ON	160	Code No. 110 function OFF	1
111	Toner motor M ON	161	Code No. 111 function OFF	1
112	Toner motor C ON	162	Code No. 112 function OFF	1
113	Toner motor K ON	163	Code No. 113 function OFF	1
114	Image quality sensor shutter solenoid ON	164	Code No. 114 function OFF	1
130	Polygonal motor standby speed ON	180	Code No. 130 function OFF	1
131	Polygonal motor normal speed ON	181	Code No. 131 function OFF	1
132	Image quality sensor LED ON	182	Code No. 132 function OFF	1
133	Color registration sensor LED (front) ON	183	Code No. 133 function OFF	1
134	Color registration sensor LED (rear) ON	184	Code No. 134 function OFF	1
135	Image quality sensor mode switching ON (Black mode)	185	Code No. 135 function OFF (Color mode)	1
201	1st cassette feed clutch ON/OFF			3
202	2nd cassette feed clutch ON/OFF			3
203	3rd cassette feed clutch ON/OFF			3
204	4th cassette feed clutch ON/OFF			3
205	Feed path clutch ON/OFF			2
206	Bypass feed clutch ON/OFF			3
207	1st cassette tray-up motor ON (tray goes up)			2
208	2nd cassette tray-up motor ON (tray goes up)			2
209	3rd cassette tray-up motor ON (tray goes up)			2
210	4th cassette tray-up motor ON (tray goes up)			2
211	Paper-exit gate solenoid ON/OFF			3
213	Ozone exhaust fan motor ON/OFF			3

Code	Function	Procedure
214	Fuser exhaust fan motor Low/High speed	3
215	PC board cooling fan motor ON/OFF	3
216	Wire cleaner drive motor Y CW/CCW (continuous reciprocating)	2
217	Wire cleaner drive motor M CW/CCW (continuous reciprocating)	2
218	Wire cleaner drive motor C CW/CCW (continuous reciprocating)	2
219	Wire cleaner drive motor K CW/CCW (continuous reciprocating)	2
220	Transfer belt contact/release motor CW/CCW (continuous reciprocating)	2
223	LCF paper feed motor ON/OFF	3
224	LCF tray motor ON/OFF	2
225	ADU feed clutch ON/OFF	3
226	ADU gate solenoid ON/OFF	3
227	ADU side motor ON/OFF	3
228	ADU end motor ON/OFF	3
229	Pre-feed clutch (front) ON/OFF	3
230	Pre-feed clutch (rear) ON/OFF	3
235	Main charger Y ON/OFF	3
236	Main charger M ON/OFF	3
237	Main charger C ON/OFF	3
238	Main charger K ON/OFF	3
243	Developer bias (Y) DC(-) ON/OFF	3
244	Developer bias (M) DC(-) ON/OFF	3
245	Developer bias (C) DC(-) ON/OFF	3
246	Developer bias (K) DC(-) ON/OFF	3
247	Developer bias (Y) AC ON/OFF	3
248	Developer bias (M) AC ON/OFF	3
249	Developer bias (C) AC ON/OFF	3
250	Developer bias (K) AC ON/OFF	3
251	Cleaning blade bias (Y) DC ON/OFF	3
252	Cleaning blade bias (M) DC ON/OFF	3
253	Cleaning blade bias (C) DC ON/OFF	3
254	Cleaning blade bias (K) DC ON/OFF	3
255	Transfer roller bias (Y) ON/OFF	3
256	Transfer roller bias (M) ON/OFF	3
257	Transfer roller bias (C) ON/OFF	3
258	Transfer roller bias (K) ON/OFF	3
259	Suction charger ON/OFF	3
260	Discharge lamp Y ON/OFF	3
261	Discharge lamp M ON/OFF	3
262	Discharge lamp C ON/OFF	3

Code	Function	Procedure
263	Discharge lamp K ON/OFF	3
280	Laser (Y) ON/OFF	3
281	Laser (M) ON/OFF	3
282	Laser (C) ON/OFF	3
283	Laser (K) ON/OFF	3
300	Carriage fan motor rotation at standby speed (high speed) ON/OFF	3
301	Carriage fan motor rotation at normal speed (low speed) ON/OFF	3
302	SCM fan motor Low/High speed	3
304	Scanner exposure lamp ON/OFF	4
331	ADF pick-up roller rotation ON/OFF	3
332	ADF aligning roller rotation ON/OFF	3
333	ADF transport belt CW rotation ON/OFF	3
334	ADF transport belt CCW rotation ON/OFF	3
351	Scan motor (carriages reciprocating once)	2
352	Document motor (indicator reciprocating once)	2

<Operation procedure>

Procedure 1

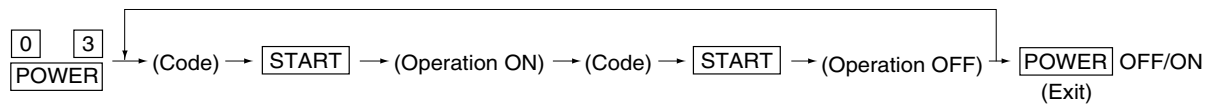

Procedure 2

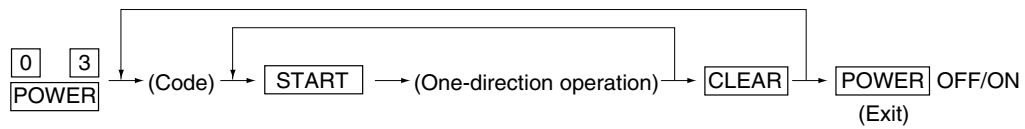

Procedure 3

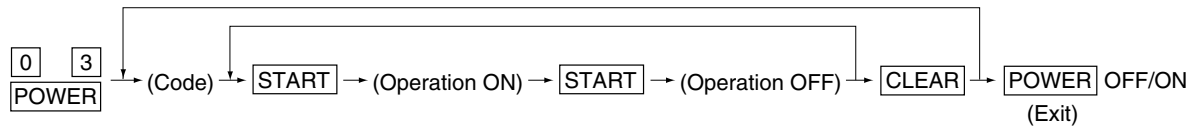

Procedure 4

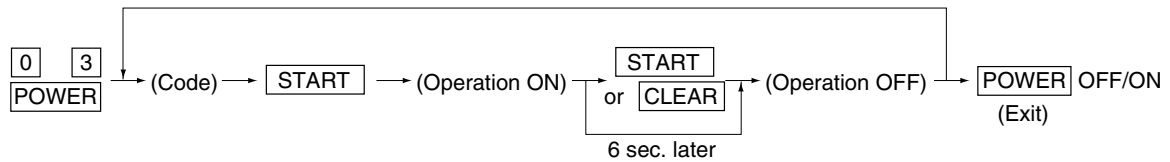



### 1. 2. 3 Test print mode (04)

In the test print mode (04), you can print each test pattern by entering its corresponding code as follows.

Code	Types of test pattern	Remarks	Papersize
14	Gamma table check pattern	To check gradation	A3/LD
204	Grid pattern (Printer reproduction ratio/Registration adjustment pattern)	Pattern width: 1 dot, Pitch: 5mm (same as the grid pattern printed by adjustment mode → [1] → [PRINTER/NETWORK])	A3/LD
219	6% test pattern		A4/LT
220	8% test pattern		A4/LT
230	Gradation check pattern (2 pixels standard)	Pattern width: 10mm, 32 gradation steps	A3/LD
231	Gradation check pattern (3 pixels standard)	Pattern width: 10mm, 32 gradation steps	A3/LD
234	Halftone		A3/LD
270	Image quality control test patten	To check image quality control	A3/LD

**Note:** Full color (YMCK) mode is not available in 230, 231 and 234.

<Operation procedure>

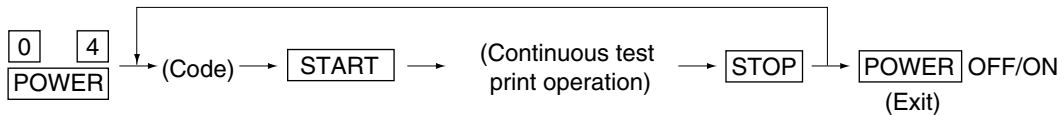

- Notes:**
1. When an error has occurred, it is indicated, but the recovery operation is not performed. So, turn the power OFF and then back ON to clear the error.
  2. During test printing, when "Wait adding toner" is displayed, the [STOP] key is disabled.

## 1. 2. 4 Adjustment mode (05)

In the adjustment mode (05), the following adjustment items can be corrected, changed or checked.

\*The numbers after hyphens under the code columns stand for sub-codes.

Adjustment mode (05)						
Code	Description/Mode		Default	Acceptable Value	Contents	Procedure
104	Reproduction ratio adjustment of secondary-scanning direction (scanner section)		128	1~255	When the value increases by 1, the reproduction ratio in the secondary-scanning direction (vertical paper feeding direction) increases by approx. 0.1522%.	1
105	Image location adjustment of secondary-scanning direction (scanner section)		128	85~171	When the value increases by 1, the image shifts by approx. 0.1213mm toward the trailing edge of the paper.	1
106	Image location adjustment of primary-scanning direction (scanner section)	For regular copy mode	180	5~251	When the value increases by 1, the image shifts by approx. 0.042mm toward the front side of the paper (machine).	1
108		For full image copy mode	133	5~251	When you enter a value, which is 47 steps (equivalent to 2mm) smaller than the set value of [106], the rear original edge and the front copy edge match (0.042mm/step).	1
135	RADF original stop position	single-sided	8	0~15	Changes the position where the original stops. When the value increases by 1, the original stop position shifts by 1mm away from the original scale.	1
136		two-sided	8	0~15		1
137	RADF sensor automatic adjustment and EEPROM initialization		–	–	By pressing the START key, WAIT is displayed while the automatic adjustment is performed. This adjustment should be carried out when EEPROM, RADF PC board or sensors are replaced.	6
200	Automatic filling of developer material and automatic adjustment of the auto-toner sensor	All (Y, M, C, K)	–	0~255	Fills the developer from the developer cartridge (about 3 min.) and then adjusts the auto-toner sensor output to set in the range of 3.50~4.50V (about 2 min.). (As the value increases, the sensor output increases correspondingly.)	5
201		Y	–	0~255		5
202		M	–	0~255		5
203		C	–	0~255		5
204		K	–	0~255		5
213	Display of auto-toner sensor output		0	0~1023	Displays the auto-toner sensor output value.	10

Adjustment mode (05)						
Code	Description/Mode		Default	Acceptable Value	Contents	Procedure
221	Automatic filling of developer material and automatic adjustment of the auto-toner sensor	Color (Y, M, C)	–	0~255	Fills the developer from the developer cartridge (about 3 min.) and then adjusts the auto-toner sensor output to set in the range of 3.50~4.50V (about 2 min.). (As the value increases, the sensor output increases correspondingly.)	5
223	Developer bias DC (–) output adjustment	Y	136	0~255	As the value increases, the transformer output increases. The adjustment value becomes effective only when the setting mode (08-400,401,409) is 0 (disabled).	1
224		M	136	0~255		1
225		C	136	0~255		1
226		K	136	0~255		1
241	Main charger grid bias output adjustment	Y	120	0~255	As the value increases, the transformer output increases. The adjustment value becomes effective only when the setting mode (08-400,401,409) is 0 (disabled).	1
242		M	120	0~255		1
243		C	120	0~255		1
244		K	120	0~255		1
245	Automatic adjustment of the auto-toner sensor	All (Y,M,C,K)	–	0~255	Auto-toner sensor output is adjusted to set the output range within 3.50~4.50V automatically (about 2 min.). As the value increases, the sensor output increases correspondingly.) (No developer filling is carried out.)	5
246		Y	–	0~255		5
247		M	–	0~255		5
248		C	–	0~255		5
249		K	–	0~255		5
250		Color (Y,M,C)	–	0~255		5
252-0	Main charger bias output voltage 1 (lower)	Y	250	0~999	Actual output voltage of main charger grid bias. After replacing the main high-voltage transformer, enter the value according to the supplementary data sheet.	4
252-1		M	250	0~999		4
252-2		C	250	0~999		4
252-3		K	250	0~999		4
253-0	Main charger bias output voltage 2 (upper)	Y	900	0~999		4
253-1		M	900	0~999		4
253-2		C	900	0~999		4
253-3		K	900	0~999		4
257-0	Developer bias DC(–) output voltage 1 (lower)	Y	100	0~999	Actual output voltage of the developer bias. After replacing the main high-voltage transformer, enter the value according to the supplementary data sheet.	4
257-1		M	100	0~999		4
257-2		C	100	0~999		4
257-3		K	100	0~999		4
258-0	Developer bias DC(–) output voltage 2 (upper)	Y	700	0~999		4
258-1		M	700	0~999		4
258-2		C	700	0~999		4
258-3		K	700	0~999		4

Adjustment mode (05)							
Code	Description/Mode		Default	Acceptable Value	Contents	Procedure	
318	Transfer bias output adjustment (Full color)	Normal paper mode / Thin paper mode	Y	59	The bias value of the transfer roller is set. The higher the value, the larger the transformer output becomes. The adjustment value becomes effective only when the setting mode (08-400,401,409) is 0 (disabled).	1	
319			M	59		1	
320			C	59		1	
321			K	59		1	
326		Thick paper 1 mode	Y	59		1	
327			M	59		1	
328			C	59		1	
329		K	59	1			
330		OHP mode	Y	59		1	
331			M	99		1	
332			C	109		1	
333			K	139		1	
334		Thick paper 2 mode	Y	69		1	
335			M	69		1	
336			C	69		1	
337			K	69		1	
356-0	Transfer bias offset adjustment	Normal paper mode / Thin paper mode	Y	4	The offset value of the transfer bias is set. 0: -400V 1: -300V 2: -200V 3: -100V 4: 0V 5: +100V 6: +200V 7: +300V 8: +400V	4	
356-1			M	4		4	
356-2			C	4		4	
356-3			K	4		4	
357-0		Thick paper 1 mode	Y	4		4	
357-1			M	4		4	
357-2			C	4		4	
357-3			K	4		4	
358-0		Thick paper 2 mode	Y	4		4	
358-1			M	4		4	
358-2			C	4		4	
358-3			K	4		4	
359-0		Thick paper 3 mode	Y	4		4	
359-1			M	4		4	
359-2			C	4		4	
359-3			K	4		4	
360-0		OHP mode	Y	4		4	
360-1			M	4		4	
360-2			C	4		4	
360-3			K	4		4	

Adjustment mode (05)							
Code	Description/Mode			Default	Acceptable Value	Contents	Procedure
361	Transfer bias output adjustment (Black)	Normal paper mode / Thin paper mode	K	49	0~255	The bias value of the transfer roller is set. The higher the value, the larger the transformer output becomes. This adjustment value becomes effective only when the setting mode (08-400, 401, 409) is 0 (disabled).	1
363		Thick paper 1 mode	K	49	0~255		1
364		OHP mode	K	69	0~255		1
365		Thick paper 2 mode	K	59	0~255		1
367-0	Transfer bias output voltage 1 (lower)		Y	589	0~5000	Actual output voltage of the transfer roller bias. After replacing the transfer transformer, enter the value according to the supplementary data sheet.	4
367-1			M	589	0~5000		4
367-2			C	589	0~5000		4
367-3			K	589	0~5000		4
368-0	Transfer bias output voltage 2 (upper)		Y	3929	0~5000		4
368-1			M	3929	0~5000		4
368-2			C	3929	0~5000		4
368-3			K	4715	0~5000		4
381	Transfer bias output adjustment (Full color)	Thick paper 3 mode	Y	89	0~255	The bias value of the transfer roller is set. The higher the value, the larger the transformer output becomes. The adjustment value becomes effective only when the setting mode(08-400, 401, 409) is 0 (disabled).	1
382			M	89	0~255		1
383			C	89	0~255		1
384			K	89	0~255		1
385	Transfer bias output adjustment (Black)	Thick paper 3 mode	K	79	0~255		1
391	Automatic removing of developer material	Color (Y, M, C)		–	–	The developer material in the developer unit is removed into the toner bag.	6
392		K		–	–		6
400	Reproduction ratio adjustment of primary-scanning direction (Fine adjustment of polygonal motor rotation speed)			1222	1209~1235	When the value increases by 1, the reproduction ratio in the primary-scanning direction (horizontal paper feeding direction) decreases by approx. 0.082%. (If the values of this code 400 is changed, the values of code 05-401,402,403, 404,410 and 474 are optimized.)	1
401	Reproduction ratio adjustment of secondary-scanning direction (Fine adjustment of drum motor/ transfer belt motor rotation speed)			1787	1608~1965	When the value increases by 1, the reproduction ratio in the secondary-scanning direction (vertical paper feeding direction) decreases by approx. 0.074%. (If the values of this code 401 is changed, the values of code 05-402,403,404, 410 and 474 are optimized.)	1

Adjustment mode (05)							
Code	Description/Mode		Default	Acceptable Value	Contents	Procedure	
402	Fine adjustment of fuser motor rotation speed		3767	0~65535	When the value increases by 1, the rotation speed of fuser motor decreases by 0.026%.	1	
404	Fine adjustment of feed motor rotation speed		9832	0~65535	When the value increases by 1, the rotation speed of the paper feed motor decreases by 0.023%.	1	
406	Registration motor speed adjustment		–	–	The paper transport speed of registration roller in relation to the image printing speed is set at the optimum value. (If the value of this code 406 is performed, the values of the code 05-404 and 410 are optimized.)	15	
407	Forced performing of color registration control		–	–	Performs the color registration control.	6	
408	Correction of fuser motor speed (For the Thick paper 3 mode )		0	0~20	In the thick paper 3 mode, when the value increases by 1, the fuser motor rotation speed decreases by 0.026%.	1	
410	Fine adjustment of registration motor rotation speed		2853	2567~3138	When the value increases by 1, the registration motor rotation speed decreases by 0.035%. (If the value of this code 410 is performed, the value of the code 05-404 is optimized.)	1	
428	Adjustment of image trailing edge margin		160	0~255	When the value increases by 1, the margin at the trailing edge along the paper feeding direction becomes narrower by approx. 0.042mm.	1	
439	Paper aligning amount adjustment	1st cassette	Long	20	0~40	When the value increases by 1, the aligning amount increases by about 0.8mm.  <b>Notes:</b> Long (= Long size paper) : Paper length 330mm or longer (A3/LD/A3 wide/FULL BLEED) Short (= Short size paper) : Paper length 220mm ~ 329mm	1
440			Short	25			
441		2nd cassette	Long	20	0~40		
442			Short	25	0~40		
443		3rd cassette	Long	20	0~40		
444			Short	25	0~40		
445		4th cassette	Long	20	0~40		
446			Short	25	0~40		
447		ADU	Long	20	0~40		
448			Short	25	0~40		
449		LCF		25	0~40		
450		Bypass feed		35	0~40		
451		Thick paper 2		40	0~50		
452		Thick paper 3		40	0~50		

Adjustment mode (05)						
Code	Description/Mode		Default	Acceptable Value	Contents	Procedure
461	Color registration status display		0	0~255	The value of Y(0) shows the error status of the color registration sensor. 0 / 16 or above: Normal 1~14: Data abnormal (sensor normal) 15: Color registration pattern reading error	10
470	Adjustment of primary-scanning laser writing start position	K	100	0~255	When the value increases by 1, the image shifts by approx. 0.042mm toward the right side of paper feed direction.	1
474	Adjustment of secondary-scanning laser writing start position		8	1~15	When the value increases by 1, the image shifts by approx. 0.6mm toward the leading edge of paper feed direction.	1
482	Reproduction ratio adjustment of the primary-scanning direction (scanner section)		127	112~142	When the value increases by 1, the reproduction ratio of the primary-scanning direction (paper feeding in horizontal direction) decreases by 0.082%.	1
491	Adjustment of the pushing amount from behind	Thick paper 3 bypass feeding	9	0~14	When the value increases by 1, the time period the bypass feed roller is driven when the paper has started to be transported from the registration section increases by 7ms.	1
492	Paper aligning amount adjustment (OHP bypass feeding)		40	0~50	When the value increases by 1, the aligning amount increases by about 0.8mm.	1
493	Adjustment of the pushing amount from behind	OHP bypass feeding	9	0~14	When the value increases by 1, the time period the bypass feed roller is driven when the paper has started to be transported from the registration section increases by 7ms.	1
494		LCF	0	0~12	When the value increases by 1, the time period the LCF feed roller is driven when the paper has started to be transported from the pre-feed roller section increases by 50ms.	1
495		Thin paper bypass feeding	0	0~14	When the value increases by 1, the time period the bypass feed roller is driven when the paper has started to be transported from the registration section increases by 7ms.	1
496		Normal paper bypass feeding	9	0~14		1
497		Thick paper 1 bypass feeding	9	0~14		1
498		Thick paper 2 bypass feeding	9	0~14		1

Adjustment mode (05)							
Code	Description/Mode		Default	Acceptable Value	Contents	Procedure	
550	Density adjustment "Manual density" fine adjustment (center setting)	Full color	Text/Photo	128	0~255	When the value increases, images made at center density become darker.	1
551			Text	128	0~255		1
552			Printed image	128	0~255		1
553			Photo	128	0~255		1
554			Map	128	0~255		1
555		Black	Text/Photo	128	0~255		1
556			Text	128	0~255		1
557			Printed image	128	0~255		1
558			Photo	128	0~255		1
559			Map	128	0~255		1
560		Density adjustment "Manual density" fine adjustment (darker setting)	Full color	Text/Photo	20		0~255
561	Text			20	0~255	1	
562	Printed image			20	0~255	1	
563	Photo			20	0~255	1	
564	Map			20	0~255	1	
565	Black		Text/Photo	20	0~255	1	
566			Text	20	0~255	1	
567			Printed image	20	0~255	1	
568			Photo	20	0~255	1	
569			Map	20	0~255	1	
570	Density adjustment "Manual density" fine adjustment (lighter setting)		Full color	Text/Photo	20	0~255	When the value increases, images made at the "light" side become lighter.
571		Text		20	0~255	1	
572		Printed image		20	0~255	1	
573		Photo		20	0~255	1	
574		Map		20	0~255	1	
575		Black	Text/Photo	20	0~255	1	
576			Text	20	0~255	1	
577			Printed image	20	0~255	1	
578			Photo	20	0~255	1	
579			Map	20	0~255	1	
580		Density adjustment "Automatic density" fine adjustment	Full color	Text/Photo	128	0~255	
581	Text			128	0~255	1	
582	Printed image			128	0~255	1	
583	Photo			128	0~255	1	
584	Map			128	0~255	1	
585	Black		Text/Photo	128	0~255	1	
586			Text	128	0~255	1	
587			Printed image	128	0~255	1	
588			Photo	128	0~255	1	
589			Map	128	0~255	1	



Adjustment mode (05)							
Code	Description/Mode		Default	Acceptable Value	Contents	Procedure	
612	Adjustment of maximum toner amount	Normal paper	255	0~255	When the value decreases, images become lighter. <b>Note:</b> When the value increases, image offset may occur.	1	
613		Thick paper 1	249	0~255		1	
614		Thick paper 2	237	0~255		1	
615		Thick paper 3	237	0~255		1	
616		OHP	230	0~255		1	
617		Thin paper	255	0~255		1	
643	Automatic gamma adjustment		–	–	Adjusts the gradation reproduction for each color Y, M, C, K.	13	
675	Judgment threshold for ACS		104	0~255	When the value increases, originals tend to be judged as monochrome, and when the value decreases, they tend to be judged as color in Auto color mode.	1	
678	AI mode setting	Discrimination setting	0	0~4	Sets the operation mode of discrimination processing in AI mode. 0: Standard (for regular) 1: Photograph priority 2: Only judgment of original type 3: Only judgment of original type with photograph priority 4: Discrimination is not performed in AI mode.	1	
682		Time-out setting	63	11~99	Sets the maximum amount of processing time for image discrimination. Two digits are designated: the 1st digit is for setting A3/LD original and the 2nd digit is for setting A4/LT original. (unit: second)	1	
698	Offset adjustment for background processing (Adjustment of background density)	Full color	Text/Photo	128	0~255	When the value increases, the background becomes darker.	1
699			Text	128	0~255		1
700			Printed image	128	0~255		1
701			Photo	128	0~255		1
702			Map	128	0~255		1
703		Black	Text/Photo	128	0~255		1
704			Text	128	0~255		1
705			Printed image	128	0~255		1
706			Photo	128	0~255		1
707			Map	128	0~255		1

Adjustment mode (05)							
Code	Description/Mode			Default	Acceptable Value	Contents	Procedure
708	Offset adjustment for background processing (Adjustment of text density)	Full color	Text/Photo	128	0~255	When the value increases, the text becomes darker.	1
709			Text	128	0~255		1
710			Printed image	128	0~255		1
711			Photo	128	0~255		1
712			Map	128	0~255		1
713		Black	Text/Photo	128	0~255		1
714			Text	128	0~255		1
715			Printed image	128	0~255		1
716			Photo	128	0~255		1
717			Map	128	0~255		1
737			Sharpness adjustment	Full color	Text/Photo		0
738	Text	0			0~31	1	
739	Printed image	0			0~31	1	
740	Photo	0			0~31	1	
741	Map	0			0~31	1	
742	Black	Text/Photo		0	0~31	1	
743		Text		0	0~31	1	
744		Printed image		0	0~31	1	
745		Photo		0	0~31	1	
746		Map		0	0~31	1	
779-0	Color balance adjustment (Y)	Text/Photo	L	128	0~255	When the value increases, the target color, the original mode and the density area become darker.  <b>Notes:</b> L: Low density area M: Medium density area H: High density area	4
779-1			M	128	0~255		4
779-2			H	128	0~255		4
780-0		Text	L	128	0~255		4
780-1			M	128	0~255		4
780-2			H	128	0~255		4
781-0		Printed image	L	128	0~255		4
781-1			M	128	0~255		4
781-2			H	128	0~255		4
782-0		Photo	L	128	0~255		4
782-1			M	128	0~255		4
782-2			H	128	0~255		4
783-0		Map	L	128	0~255		4
783-1			M	128	0~255		4
783-2	H		128	0~255	4		

Adjustment mode (05)							
Code	Description/Mode		Default	Acceptable Value	Contents	Procedure	
784-0	Color balance adjustment (M)	Text/Photo	L	128	0~255	When the value increases, the target color, the original mode and the density area become darker.  <b>Notes:</b> L: Low density area M: Medium density area H: High density area	4
784-1			M	128	0~255		4
784-2			H	128	0~255		4
785-0		Text	L	128	0~255		4
785-1			M	128	0~255		4
785-2			H	128	0~255		4
786-0		Printed image	L	128	0~255		4
786-1			M	128	0~255		4
786-2			H	128	0~255		4
787-0		Photo	L	128	0~255		4
787-1			M	128	0~255		4
787-2			H	128	0~255		4
788-0		Map	L	128	0~255		4
788-1			M	128	0~255		4
788-2			H	128	0~255		4
789-0	Color balance adjustment (C)	Text/Photo	L	128	0~255	When the value increases, the target color, the original mode and the density area become darker.  <b>Notes:</b> L: Low density area M: Medium density area H: High density area	4
789-1			M	128	0~255		4
789-2			H	128	0~255		4
790-0		Text	L	128	0~255		4
790-1			M	128	0~255		4
790-2			H	128	0~255		4
791-0		Printed image	L	128	0~255		4
791-1			M	128	0~255		4
791-2			H	128	0~255		4
792-0		Photo	L	128	0~255		4
792-1			M	128	0~255		4
792-2			H	128	0~255		4
793-0		Map	L	128	0~255		4
793-1			M	128	0~255		4
793-2			H	128	0~255		4

Adjustment mode (05)							
Code	Description/Mode		Default	Acceptable Value	Contents	Procedure	
794-0	Color balance adjustment (K)	Text/Photo	L	128	0~255	When the value increases, the target color, the original mode and the density area become darker.  <b>Notes:</b> L: Low density area M: Medium density area H: High density area	4
794-1			M	128	0~255		4
794-2			H	128	0~255		4
795-0		Text	L	128	0~255		4
795-1			M	128	0~255		4
795-2			H	128	0~255		4
796-0		Printed image	L	128	0~255		4
796-1			M	128	0~255		4
796-2			H	128	0~255		4
797-0		Photo	L	128	0~255		4
797-1			M	128	0~255		4
797-2			H	128	0~255		4
798-0		Map	L	128	0~255		4
798-1			M	128	0~255		4
798-2			H	128	0~255		4
817	Output value display of image quality sensor	When the light source is OFF	–	0~1023	Displays the output value of image quality sensor when the sensor light source is OFF.	2	
818		Transfer belt surface	–	0~1023	Displays the output value of image quality sensor (when there is no test pattern) on the transfer belt.	2	
819		Low-density pattern	–	0~1023	Displays the output value of image quality sensor when a low-density test pattern is written.	10	
820		High-density pattern	–	0~1023	Displays the output value of image quality sensor when a high-density test pattern is written.	10	
821	Light amount adjustment results of image quality sensor		–	0~255	This sensor's LED light amount adjustment value is the reference value for setting the reflected light amount from the belt surface.	2	
822	Output value display of image quality sensor	Medium-density pattern	–	0~1023	Displays the output value of image quality sensor when a medium-density test pattern is written.	10	
878	Forced performing of image quality control		–	–	Performs the image quality control.	6	
879	Automatic initialization of image quality control		–	–	Performs the image quality control and restore the initial value.	6	
912-0	Magazine sort/ fine adjustment of folding and stapling position	A4-R/LT-R	0	-14~14	When the value increases by 1, the folding and stapling position shift by approx. 0.25mm toward the right page.	4	
912-1		B4	0	-14~14		4	
912-2		A3/LD	0	-14~14		4	

<Operation procedure>

Procedure 1

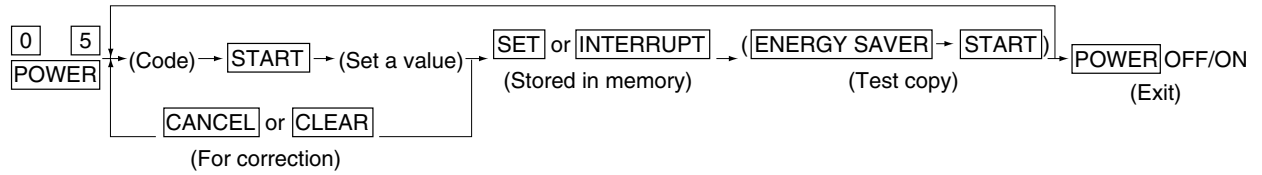

Procedure 2

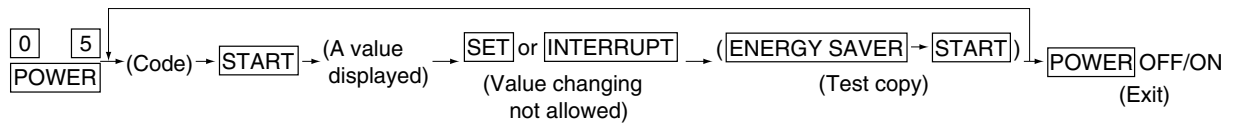

Procedure 4

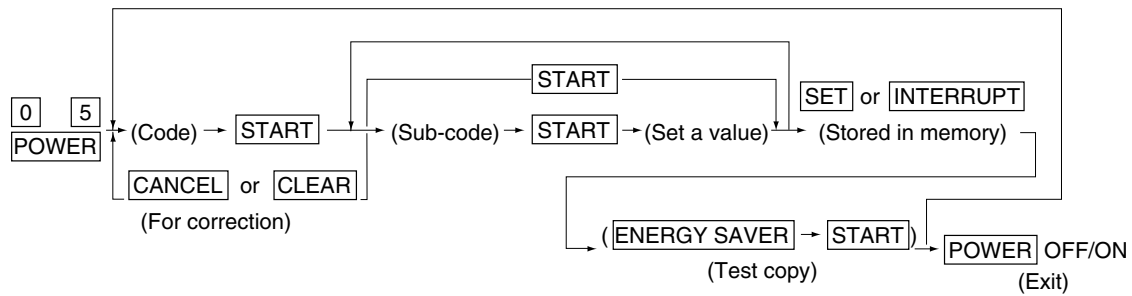

Procedure 5

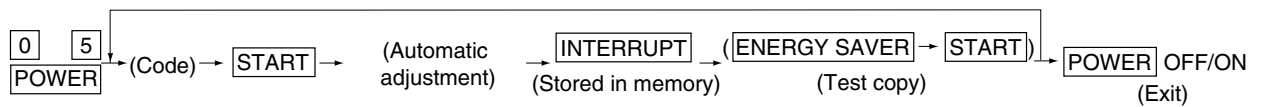

Procedure 6

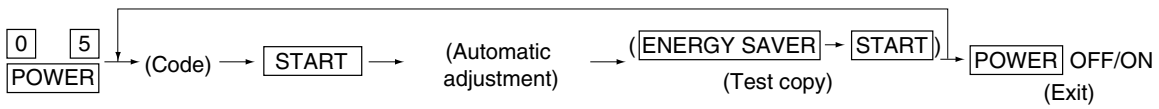

Procedure 10

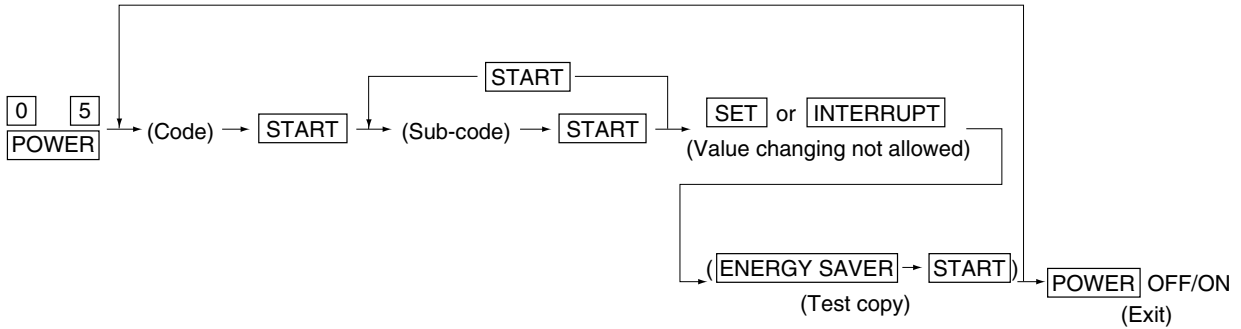

Procedure 13

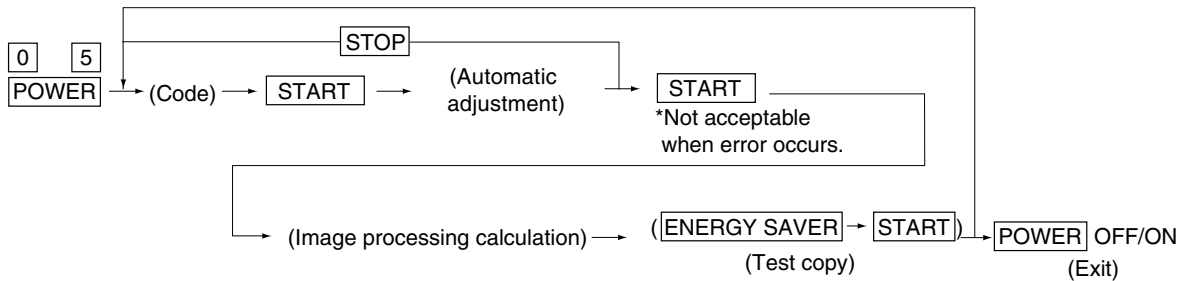

Procedure 15

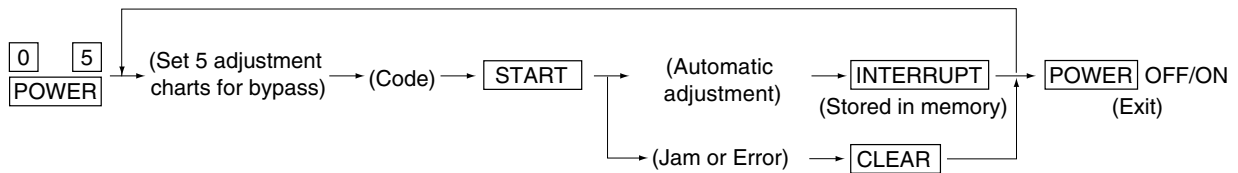

## 1. 2. 5 Setting mode (08)

The following items can be set or changed in this mode (08).

Setting mode (08)					
Code	Name	Default	Acceptable value	Contents	Procedure
200	Date and time setting	–	13 digits	Year/month/date/day/hour/minute/second Example: 99:08:07:5:11:30:48	1
201	Destination selection	EUR:0 UC:1 JPN:2	0 ~ 2	0: Europe (A4/A3/Folio) 1: USA/Canada (Letter/Ledger) 2: Japan (A4/B4)	1
202	Externally installed copy counter/controller device	0	0 ~ 3	0: No external copy counter/controller device 1: Coin controller 2: Copy key card 3: Key copy counter	1
204	Auto-clear timer setting	3	0 ~ 10	When the [START] key is not pressed, the time lag before automatic clearing works to clear settings to defaults. 0: Disabled 1 to 10: Set number x 15 seconds	1
205	Energy saver timer setting	0	0 ~ 15	Timer for switching to Energy Saver mode selected in 08-618 when the copier is not used. 0: Disabled 1: 30sec. 2: 60sec. 3: 90sec. 4: 120sec. 5: 150sec. 6: 3min 7: 4min 8: 5min 9: 7min 10: 10min 11: 15min 12: 20min 13: 30min 14: 45min 15: 60min	1
206	Automatic shutoff timer setting	20	0 ~ 20	Timer for switching to automatic shutoff state when the copier is not used. US Energy Star Compliance 0: 3min 1: 5min 2: 10min 3: 15min 4: 20min 5: 25min 6: 30min 7: 40min 8: 50min 9: 60min 10: 70min 11: 80min 12: 90min 13: 100min 14: 110min 15: 120min 16: 150min 17: 180min 18: 210min 19: 240min 20: Disabled	1
209	Timer for print job start-up time from copy mode when auto-clear is disabled	1	1 ~ 10	Sets the period the control panel is not operated when the data of the printer function is sent before the print job starts. This function is enabled when the auto-clear timer setting (08-204) is set as "0" (disabled). (Set number x 15 seconds)	1

Setting mode (08)					
Code	Name	Default	Acceptable value	Contents	Procedure
217	Information of cassettes installation	15	0 ~ 15	0: 4 cassettes 1: 2 cassettes 2: 3 cassettes 3: 4 cassettes 4: 1 cassette(Forcibly installing OFF) 15: Automatic	1
220	Selection of language (UI) on the display panel	EUR:0 UC:6 JPN:5	0 ~6	0: Language 1 1: Language 2 2: Language 3 3: Language 4 4: Language 5 5: Language 6 6: Language 7 <b>Note:</b> On the control panel, EUR, JPN: language 1 to 6 are selectable. UC: language 2 to 7 are selectable.	1
229	Paper size setting/ bypass feed	–	0~255	Paper size is selected with the icons on the LCD.	1
230	Paper size setting/ 1st cassette	EUR:A4 UC:LT JPN:A4	0~255	Paper size is selected with the icons on the LCD.	1
231	Paper size setting/ 2nd cassette	EUR:A3 UC:LD JPN:A3	0~255	Paper size is selected with the icons on the LCD.	1
232	Paper size setting/ 3rd cassette	EUR:A4-R UC:LT-R JPN:A4-R	0~255	Paper size is selected with the icons on the LCD.	1
233	Paper size setting/ 4th cassette	EUR:A4 UC:LG JPN:B4	0~255	Paper size is selected with the icons on the LCD.	1
250	Telephone number for “Call for service”	0	14 digits	A telephone number up to 14 digits can be entered. Use the [HELP] key to enter hyphens (-).	1
253	Error history display	–	–	The last twenty error records are displayed.	2
256	Paper size setting/ LCF	EUR:A4 UC:LT JPN:A4	0 ~ 255	Paper size is selected with the icons on the LCD.	1
257	Counter copy	–	1 ~ 2	1: Copies the original counter value to the backup counter. 2: Copies the backup counter value to the original counter. (▶ Page 1-48)	–
267	C9B/C9D Error history display	–	–	Displays the error status of [C9B] and [C9D].	2
300	Maximum number of copies allowed	0	0 ~ 2	0: 999 1: 99 2: 9	1



Setting mode (08)					
Code	Name	Default	Acceptable value	Contents	Procedure
302	Resettable/original counter display	EUR: 3 UC: 0 JPN:0	0 ~ 3	Sets if the resettable and original counters are displayed. 0: Off                    1: Resettable counter 2: Original counter 3: Resettable/original counter	1
318	Paper size (non-standard) feeding/widthwise direction	432/ 279	148~457/ 100~305		4
360	RADF switch back	0	0 ~ 1	Reversing the RADF transport belt during original transporting to align originals against the original scale. 0: Disabled   1: Enabled	1
361	RADF non-standard size original detection	0	0 ~ 1	When non-standard originals are used; 0: Non-standard - Copier will stop and prompt operator to select copy size. 1: Standard - Copier continues the current job without stopping	1
390	HDD error frequency counter	0	0~32767	Resets when formatting the HDD	2
400	Image quality control 1	1	0 ~ 1	Auto-performing of image quality control 0: Disabled 1: Enabled (Performing 08-410,413)	1
401	Image quality control 2	1	0 ~ 1	Auto-performing of image quality control 0: Disabled   1: Enabled * If Image quality control 1(08-400) is 0 (Disabled), this value must be set to 0 (Disabled).	1
402	Image quality control 5	1	0 ~ 1	Auto-performing of image quality control 0: Disabled   1: Enabled * If both image quality control 2 (08-401) and 4 (08-411) are 0 (Disabled), this value must be set to 0 (Disabled).	1
404	Image quality control auto-start (relative humidity changes)	1	0 ~ 1	After the last image quality control, if the variation of the relative humidity inside the copier becomes larger than the set value in 08-405, image quality control will be started when the printing begins.	1
405	Relative humidity difference setting at image quality control auto-start	1	0 ~ 1	Sets the difference of the relative humidity for image quality control auto-start (relative humidity changes). 0: 5%R.H.      1: 10%R.H.      2: 15%R.H. 3: 20%R.H.    4: 25%R.H.      5: 30%R.H. 6: 35%R.H.	1

Setting mode (08)					
Code	Name	Default	Acceptable value	Contents	Procedure
406	Image quality control auto-start (standby time)	1	0 ~ 1	After printing is finished and the time set in 08-452 has passed, image quality control will start when printing is started or the energy saver key is pressed. 0: Disabled 1: Enabled	1
407	Image quality control auto-start (continuous printing)	0	0 ~ 1	During continuous printing, image quality control is started for every print volume set in 08-453. 0: Disabled 1: Enabled	1
408	Image quality control auto-start (accumulated print volume)	1	0 ~ 1	When the accumulated print volume since the last image quality control has attained the amount set in 08-455, image quality control automatically starts after the current printing job. 0: Disabled 1: Enabled	1
409	Image quality control 3	1	0 ~ 1	Auto-performing of image quality control 0: Disabled 1: Enabled (Performing 08-410,413)	1
410	Drum surface potential correction control by drum temperature	1	0 ~ 1	Performing drum surface potential correction by drum thermistor detection temperature for image quality control. 0: Disabled 1: Enabled * This selection is reflected if 'Image quality controls 1 and 3 (08-400,409)' have been set to 1 (Enabled).	1
411	Image quality control 4	1	0 ~ 1	Auto-performing of image quality control 0: Disabled 1: Enabled * If image quality control 2 (08-401) is 0 (Disabled), this value must be set to 0 (Disabled).	1
413	Transfer roller bias correction control by temperature and humidity	1	0 ~ 1	Performing transfer roller bias correction by the temperature and humidity sensor for image quality control. 0: Disabled 1: Enabled * This selection is reflected if 'Image quality controls 1 and 3 (08-400,409)' have been set to 1 (Enabled).	1
415	Image quality control abnormal detection counter (Y) display/0 clearing	0	0 ~ 16	Accumulated total of CE1, CE2, CE4 (Max.16 times) * Enabled when 'Image quality control 3 (08-401)' is 1(Enabled).	1

Setting mode (08)					
Code	Name	Default	Acceptable value	Contents	Procedure
416	Image quality control abnormal detection counter (M) display/0 clearing	0	0 ~ 16	Accumulated total of CE1, CE2, CE4 (Max.16 times) * Enabled when 'Image quality control 3 (08-401)' is 1 (Enabled).	1
417	Image quality control abnormal detection counter (C) display/0 clearing	0	0 ~ 16	Accumulated total of CE1, CE2, CE4 (Max.16 times) * Enabled when 'Image quality control 3 (08-401)' is 1 (Enabled).	1
418	Image quality control abnormal detection counter (K) display/0 clearing	0	0 ~ 16	Accumulated total of CE1, CE2, CE4 (Max.16 times) * Enabled when 'Image quality control 3 (08-401)' is 1 (Enabled).	1
452	Image quality control auto-start time setting (standby time)	4	0 ~ 24	Setting time (hour) of Image quality control auto-start (standby time)	1
453	Image quality control auto-start print volume setting (continuous printing)	300	0 ~ 999	Setting print volume (number of sheets) to automatically start Image quality control (continuous printing)	1
455	Image quality control auto-start print volume setting (accumulated print volume)	10	0 ~ 30	Setting print volume (set value x 100 sheets) to automatically start Image quality control (accumulated print volume)	1
480	Paper source priority	0	0 ~ 5	0: A4/LT 1: LCF 2: 1st cassette 3: 2nd cassette 4: 3rd cassette 5: 4th cassette	1
481	Automatic paper source change	1	0 ~ 2	Sets if the cassette is automatically switched to the other cassette which has the paper of the same size when paper in the selected one has run out. 0: Not switch 1: Switch if paper of the same size and same direction presents (ex.A4 to A4). 2: Switch if paper of the same size presents (different direction is acceptable) (ex. A4 to A4-R).	1
485	Polygonal motor rotation at standby	0	0 ~ 1	Setting of polygonal motor rotation at standby 0: Low speed rotation (standby rotation) 1: Stop	1
501	Original mode priority	0	0 ~ 5	0: Text/photo 1: Text 2: Printed image 3: Photo 4: Map 5:AI	1
502	Original mode priority (Black)	0	0 ~ 5	0: Text/photo 1: Text 2: Printed image 3: Photo 4: Map 5:AI	1

Setting mode (08)					
Code	Name	Default	Acceptable value	Contents	Procedure
503	Density mode priority	1	0 ~ 1	0: Automatic 1: Manual (Center)	1
504	Color mode priority	2	0 ~ 2	0: Auto color 1: Black 2: Full color	1
600	Access code mode	0	0 ~ 2	0: Disabled 1: Enabled 2: Department management	1
602	Display setting for Automatic energy saver / Automatic shutoff	EUR:1 UC:1 JPN:0	0 ~ 1	0: Display OFF 1: Display ON	1
603	Automatic duplexing mode priority (when using RADF)	0	0 ~ 3	0: Disabled 1: Single-sided to duplexed 2: Two-sided to duplexed 3: User selection	1
604	APS (Automatic Paper Selection) / AMS (Automatic Magnification Selection) mode priority	0	0 ~ 2	0: APS mode 1: AMS mode 2: None	1
607	RADF feeding mode priority	0	0 ~ 1	0: Continuous feeding by START key 1: SADF (Automatic feeding by setting original)	1
609	Original mode priority (scanning)	2	2 ~ 3	The initial value of the original mode in the scan function is set. 2: Printed image 3: Photo	1
610	Color mode priority (scanning)	2	1 ~ 2	The initial value of the color mode in the scan function is set. 1: Gray scale 2: Full color	1
611	Book duplexed copy original priority	0	0 ~ 1	0: Left page to right page 1: Right page to left page	1
612	Image repeat gap	5	0~10	Set value x 1mm	1
613	[OTHER KEY] paper size setting	EUR:13 UC:12 JPN:3	0 ~ 13	0: A3 1: A4 2: A4-R 3: A5-R 4: B4 5: B5 6: B5-R 7: LT 8: LT-R 9: LD 10: LG 11: ST 12: COMPUTER 13: FOLIO 14: A6-R 15: Postcard	1
617	RADF image shifting	0	0 ~ 1	Sets the datum position of image when the RADF is used. 0: Without shift (center) 1: With shift (corner)	1
618	Energy saver mode	0	0 ~ 1	0: Energy saver mode with priority aim of energy saving (Refer to 08-712) 1: Energy saver mode with priority aim of returning to standby (Refer to 08-713)	1
619	Initial value setting of book center erase margin	10	0 ~ 50	Set value x 1mm	1
620	APS forced start setting / selection	0	0 ~ 2	0: Single press of key 1: Double press of key 2: Disabled	1

Setting mode (08)					
Code	Name	Default	Acceptable value	Contents	Procedure
622	Reading resolution initial value setting (scanning)	2	0 ~ 2	The initial value of the read resolution in the scan function is set. 0: 600dpi 1: 300dpi 2: 150dpi	1
623	Permanent file format initial value setting (scanning)	1	0 ~ 1	When the data read by the scan function is saved into the mail box, the initial value of the file format is set. 0: PDF 1: JPEG 2: TIFF	1
630	Automatic paper source change from bypass tray	0	0 ~ 1	Sets if the paper source is switched to the other cassette which has the paper of the same size when the paper on the bypass tray has run out. 0: Disabled 1: Enabled	1
631	Transfer belt release control in the auto color mode	0	0 ~ 1	Sets if the transfer belt is released when the original is judged as black-and-white. 0: Disabled 1: Enabled	1
632	Automatic calibration disclosure level	1	0 ~ 2	Sets the disclosing level of automatic calibration. 0: Service technician 1: Administrator 2: User	1
634	Initial value setting of repeat frequency in the image repeat mode	2	2 ~ 8	Set value = Repeat frequency	1
635	RADF mixed originals mode setting priority	0	0 ~ 1	0: Same original size 1: Mixed original size	1
640	Date printing format	EUR:1 UC:2 JPN:0	0~2	Sets the date printing format at the list printing. 0: YYYY.MM.DD 1: DD.MM.YYYY 2: MM.DD.YYYY	1
641	Automatic sorting mode priority (when using RADF)	2	0 ~ 3	0: OFF 1: STAPLE 2: SORT 3: GROUP	1
642	Sorter mode setting priority	0	0 ~ 3	0: NON SORT 1: STAPLE 2: SORT 3: GROUP	1
643	E-mail transmission file format default setting	1	0 ~ 2	Sets the default file format when the image data read by the scan function is send by E-mail. 0: PDF 1: JPEG 2: TIFF	1
644	E-mail transmission file attachment format default setting	0	0 ~ 1	Sets the default attachment format when the image data read by the scan function is send by E-mail. 0: Attachment 1: URL	1

Setting mode (08)					
Code	Name	Default	Acceptable value	Contents	Procedure
645	Correction of reproduction ratio in the editing copy mode	10	0 ~ 10	Sets the reproduction ratio for X in 1 copy (including magazine sort) to "Reproduction ratio x Correction ratio (followings)". 0: 90% 1: 91% 2: 92% 3: 93% 4: 94% 5: 95% 6: 96% 7: 97% 8: 98% 9: 99% 10: 100%	1
646	Image position in the editing copy mode	0	0 ~ 1	Sets the image pasting datum for each page in the X in 1 copy (including magazine sort). 0: Corner (upper left) 1: Center	1
648	Initializing of the finisher tray at Auto-clear	0	0 ~ 1	Sets whether the finisher tray moves to the 1-bin or not at Auto-clear 0: Not move 1: Move	1
650	2 in 1 / 4 in 1 setting	0	0 ~ 1	0: Horizontal writing original 1: Vertical writing original	1
653	Copier administrator's password	00000	00000 ~ 99999	Sets the password for administrator in the department management.	1
681	Cascade operation setting (printer)	0	0 ~ 1	0: OFF 1: ON	1
682	Magazine sort setting	0	0 ~ 1	0: Left page to right page 1: Right page to left page	1
683	Cascade operation setting (copier)	0	0 ~ 1	0: OFF 1: ON	1
684	Summer time function	0	0 ~ 1	0: Not summer time 1: Summer time	2
690	HDD formatting	–	2	2: Normal format	1
691	HDD status display	–	0 ~ 2	0: Not formatted 2: Normal formatted	2
693	HDD standby mode	1	0 ~ 10	Sets the time lag before entering the HDD standby status. * This value may need to be changed when the HDD is replaced since the characteristics of HDDs are different among makers.	1
700	Fuser error status counter	0	0 ~ 9	0: Normal 1:[C41] error 2: Continuous [C41] error 3: – 4: [C43] error 5: [C44] error 6: [C42] error 7: [C46] error 8: [C47] error 9: [C48] error	1

Setting mode (08)					
Code	Name	Default	Acceptable value	Contents	Procedure
712	Fuser roller temperature for energy saver mode with priority aim of energy saving	3	0 ~ 17	0: OFF 1: 60°C 2: 65°C 3: 70°C 4: 75°C 5: 80°C 6: 85°C 7: 90°C 8: 95°C 9: 100°C 10: 105°C 11: 110°C 12: 115°C 13: 120°C 14: 125°C 15: 130°C 16: 135°C 17: 140°C	1
713	Fuser roller temperature for energy saver mode with priority aim of returning to standby	13	0 ~ 17	0: OFF 1: 60°C 2: 65°C 3: 70°C 4: 75°C 5: 80°C 6: 85°C 7: 90°C 8: 95°C 9: 100°C 10: 105°C 11: 110°C 12: 115°C 13: 120°C 14: 125°C 15: 130°C 16: 135°C 17: 140°C	1
742	Color registration control	0	0 ~ 1	0: Automatic 1: Manual	1
743	Color registration control during the warming-up	1	0 ~ 1	0: Disabled 1: Enabled	1
801	Electronic total counter display	0	0 ~ 9999999	Electronic counter counts the number of all printouts in the copier/printer function. (Code 08-802 is reflected.)	1
802	Large-size double count setting	EUR:0 UC:1 JPN:0	0 ~ 2	0: Single count 1: Double count 2: Single count (Double count for key copy counter) *Double-counted paper size is set in code 08-888. Code 08-801, 813 and key copy counter reflect this setting.	1
803	Short-size counter display (card~A4-R/LT-R)	0	0 ~ 9999999	Counts the number of short-sized printouts.	1
804	Long-size counter display (B4/LG~A3 wide/FULL BLEED)	0	0 ~ 9999999	Counts the number of long-sized printouts.	1
808	Bypass counter display	0	0 ~ 9999999	Counts the number of printouts in the bypass feed. (Single count for every paper size)	1
809	LCF counter display	0	0 ~ 9999999	Counts the number of printouts fed from the LCF. (Single count for every paper size)	1
813	Test print counter	0	0 ~ 9999999	Counts the number of printouts in the test print mode. (In the test print mode, only this counter is counted. Code 08-802 is reflected.)	1
814	Single-sided print counter display	0	0 ~ 9999999	Counts the number of single-sided printouts. (Single count for every paper size)	1
815	Duplexed print counter display	0	0 ~ 9999999	Counts the number of duplexd printouts. (Single count for every paper size)	1
817	Bypass jam counter display	0	0 ~ 9999999	Counts the frequency of paper jam in bypass feeding. (Accumulated total of E12)	1

Setting mode (08)					
Code	Name	Default	Acceptable value	Contents	Procedure
818	Registration jam counter display	0	0 ~ 9999999	Jam on paper trailing edge at the registration roller (Accumulated total of E01)	1
820	Paper exit jam counter display	0	0 ~ 9999999	Frequency of paper exit jam (Accumulated total of E01, E02)	1
822	ADU counter display	0	0 ~ 9999999	Counts the number of printouts fed from the ADU stack. (Single count for every paper size)	1
824	RADF original counter display	0	0 ~ 9999999	Counts the number of originals fed from the RADF. (Single count for every paper size)	1
825	LCF jam counter display	0	0 ~ 9999999	Frequency of paper jam when paper fed from the LCF (Accumulated total of E19, E21)	1
826	ADU paper-feed jam counter display	0	0 ~ 9999999	Frequency of paper jam after paper fed from the ADU stack (Accumulated total of E11, E54)	1
827	ADU stack jam counter	0	0 ~ 9999999	Frequency of paper jam before paper reach the ADU stack (Accumulated total of E50, E51, E52)	1
831	Setting the target for the key copy counter	1	0 ~ 3	1: Copier 2: Printer 3: Copier/Printer	1
832	1st cassette counter display	0	0 ~ 9999999	Counts the number of printouts fed from the 1st cassette. (Single count for every paper size)	1
833	2nd cassette counter display	0	0 ~ 9999999	Counts the number of printouts fed from the 2nd cassette. (Single count for every paper size)	1
834	3rd cassette counter display	0	0 ~ 9999999	Counts the number of printouts fed from the 3rd cassette. (Single count for every paper size)	1
835	4th cassette counter display	0	0 ~ 9999999	Counts the number of printouts fed from the 4th cassette. (Single count for every paper size)	1
836	1st cassette jam counter display	0	0 ~ 9999999	Frequency of paper jam when paper fed from the 1st cassette. (Accumulated total of E13, E22)	1
837	2nd cassette jam counter display	0	0 ~ 9999999	Frequency of paper jam when paper fed from the 2nd cassette. (Accumulated total of E14, E23)	1
838	3rd cassette jam counter display	0	0 ~ 9999999	Frequency of paper jam when paper fed from the 3rd cassette. (Accumulated total of E15, E24)	1
839	4th cassette jam counter display	0	0 ~ 9999999	Frequency of paper jam when paper fed from the 4th cassette. (Accumulated total of E16, E25)	1
840	Drum Y life counter (display/0 clearing)	0	0 ~ 999999	Counts the number of sheets printed at drum Y. (Code 08-858 and 875 are reflected.)	1



Setting mode (08)					
Code	Name	Default	Acceptable value	Contents	Procedure
841	Drum M life counter (display/0 clearing)	0	0 ~ 999999	Counts the number of sheets printed at drum M. (Code 08-858 and 875 are reflected.)	1
842	Drum C life counter (display/0 clearing)	0	0 ~ 999999	Counts the number of sheets printed at drum C. (Code 08-858 and 875 are reflected.)	1
843	Drum K life counter (display/0 clearing)	0	0 ~ 999999	Counts the number of sheets printed at drum K. (Code 08-858 and 875 are reflected.)	1
844	Developer Y counter (display/0 clearing)	0	0 ~ 9999999	Counts the number of sheets printed by developer Y. (Code 08-858 and 875 are reflected.)	1
845	Developer M counter (display/0 clearing)	0	0 ~ 9999999	Counts the number of sheets printed by developer M. (Code 08-858 and 875 are reflected.)	1
846	Developer C counter (display/0 clearing)	0	0 ~ 9999999	Counts the number of sheets printed by developer C. (Code 08-858 and 875 are reflected.)	1
847	Developer K counter (display/0 clearing)	0	0 ~ 9999999	Counts the number of sheets printed by developer K. (Code 08-858 and 875 are reflected.)	1
853	Transfer belt unit counter (display/0 clearing)	0	0 ~ 9999999	Counts the number of printed sheets of the transfer belt unit. (Code 08-858 and 875 are reflected.)	1
854	Fuser unit counter (display/0 clearing)	0	0 ~ 9999999	Counts the number of printed sheets of the fuser unit. (Code 08-858 and 875 are reflected.)	1
855	Fuser oil roller counter (display/0 clearing)	0	0 ~ 9999999	Counts the number of printed sheets of the fuser oil roller. (Code 08-858 and 875 are reflected.)	1
857	Counter setting for general PM	Refer to Contents column	0 ~ 999999	General maintenance counter value (number of printouts) <Default value> FC-210 EUR: 40000 UC: 40000 JPN: 0 FC-310 EUR: 60000 UC: 60000 JPN: 0	1
858	OHP/Thick paper double count	1	0 ~ 1	The counter for life management at the OHP/Thick paper mode; 0: Disabled - Counts up normally. 1: Enabled - Counts up doubly.	1
867	Drum Y drive counter (display/0 clearing)	0	0 ~ 999999	Rotation time (sec.) of color drum motor	1
868	Drum M drive counter (display/0 clearing)	0	0 ~ 999999	Rotation time (sec.) of color drum motor	1
869	Drum C drive counter (display/0 clearing)	0	0 ~ 999999	Rotation time (sec.) of color drum motor	1
870	Drum K drive counter (display/0 clearing)	0	0 ~ 999999	Rotation time (sec.) of black drum motor	1
871	Developer Y time counter (display/0 clearing)	0	0 ~ 999999	Rotation time (sec.) of developer motor	1
872	Developer M time counter (display/0 clearing)	0	0 ~ 999999	Rotation time (sec.) of developer motor	1

Setting mode (08)					
Code	Name	Default	Acceptable value	Contents	Procedure
873	Developer C time counter (display/0 clearing)	0	0 ~ 999999	Rotation time (sec.) of developer motor	1
874	Developer K time counter (display/0 clearing)	0	0 ~ 999999	Rotation time (sec.) of developer motor	1
875	Life counter large-size double count setting	2	0 ~ 2	0: Disabled 1: A3, LD, A3 wide, FULL BLEED 2: A3, LD, A3 wide, FULL BLEED, B4, LG, FOLIO, COMP	1
876	Large-size counter display (Copier/Full color)	0	0~ 9999999	Counts the number of printouts of large-size paper in the full color mode/copier function. (Code 08-802 and 888 are reflected.)	1
877	Small-size counter display (Copier/Full color)	0	0~ 9999999	Counts the number of printouts of small-size paper in the full color mode/copier function. (Code 08-888 is reflected.)	1
878	Large-size counter display (Copier/Black)	0	0~ 9999999	Counts the number of printouts of large-size paper in the black mode/copier function. (Code 08-802 and 888 are reflected.)	1
879	Small-size counter display (Copier/Black)	0	0~ 9999999	Counts the number of printouts of small-size paper in the black mode/copier function. (Code 08-888 is reflected.)	1
880	Large-size counter display (Copier/Monocolor)	0	0~ 9999999	Counts the number of printouts of large-size paper in the monochrome mode/copier function. (Code 08-802 and 888 are reflected.)	1
881	Small-size counter display (Copier/Monocolor)	0	0~ 9999999	Counts the number of printouts of small-size paper in the monochrome mode/copier function. (Code 08-888 is reflected.)	1
882	Large-size counter display (Printer/Full color)	0	0~ 9999999	Counts the number of printouts of large-size paper in the full color mode/printer function. (Code 08-802 and 888 are reflected.)	1
883	Small-size counter display (Printer/Full color)	0	0~ 9999999	Counts the number of printouts of small-size paper in the full color mode/printer function. (Code 08-888 is reflected.)	1
884	Large-size counter display (Printer/Black)	0	0~ 9999999	Counts the number of printouts of large-size paper in the black mode/printer function. (Code 08-802 and 888 are reflected.)	1
885	Small-size counter display (Printer/Black)	0	0~ 9999999	Counts the number of printouts of small-size paper in the black mode/printer function. (Code 08-888 is reflected.)	1
888	Large-size setting	2	1 ~ 2	1: A3/LD/A3 wide/FULL BLEED 2: A3/LD/A3 wide/FULL BLEED/B4/LG/FOLIO /COMP	1

Setting mode (08)					
Code	Name	Default	Acceptable value	Contents	Procedure
892	Current value of general PM counter (display/0 clearing)	0	0 ~ 999999	Total number of printouts (copier + printer) for life related (double count) (Code 08-858 and 875 are reflected.)	1
894	Drum drive total counter for color PM life-time counter (display/0 clearing)	0	0 ~ 999999999	Rotation time (sec.) of color drum motor	1
896	Current value of color PM counter (display/0 clearing)	0	0 ~ 999999	Total number of full color and monochrome printouts for life related (double count) (Code 08-858 and 875 are reflected.)	1
897	Counter setting for color PM	Refer to Contents column	0 ~ 999999	Color maintenance counter value (number of printouts) <Default value> FC-210 EUR: 40000 UC: 40000 JPN: 0 FC-310 EUR: 60000 UC: 60000 JPN: 0	1
898	Drum drive total counter for general PM life-time counter (display/0 clearing)	0	0 ~ 999999999	Rotation time (sec.) of black drum motor	1
900	Firmware version (Basic section ROM)	–	–	EUR: T314SEXXX UC: T314SUXXX JPN: T314SJXXX Other: T314SXXXX	2
902	Engine ROM version (LGC)	–	–	T314M-XX	2
903	Printer ROM version (IMC)	–	–	T314IMC-XX	2
904	Scanner ROM version (SCM)	–	–	T314SCM-XX	2
905	Macro-discrimination/discrimination version (AI ROM)	–	–	T511MAC-XX	2
920	FROM basic section software version	–	–	VX.X/Y.Y	2
921	FROM program internal version	–	–	VXXX.YYY	2
922	UI data fixed section version	–	–	VXXX.YYY Z (Z: Language code, ► Page. 5-22)	2
923	UI data common section version	–	–	VXXX.YYY Z (Z: Language code, ► Page. 5-22)	2
924	UI data 1st language version in HDD	–	–	VXXX.YYY Z (Z: Language code, ► Page. 5-22)	2
925	UI data 2nd language version in HDD	–	–	VXXX.YYY Z (Z: Language code, ► Page. 5-22)	2

Setting mode (08)					
Code	Name	Default	Acceptable value	Contents	Procedure
926	UI data 3rd language version in HDD	–	–	VXXX.YYY Z (Z: Language code, ► Page. 5-22)	2
927	UI data 4th language version in HDD	–	–	VXXX.YYY Z (Z: Language code, ► Page. 5-22)	2
928	UI data 5th language version in HDD	–	–	VXXX.YYY Z (Z: Language code, ► Page. 5-22)	2
929	UI data 6th language version in HDD	–	–	VXXX.YYY Z (Z: Language code, ► Page. 5-22)	2
930	UI data version in FROM displayed at power ON	–	–	VXXX.YYY Z (Z: Language code, ► Page. 5-22)	2
931	UI data 7th language version in HDD	–	–	VXXX.YYY Z (Z: Language code, ► Page. 5-22)	2
956	[FUNCTION CLEAR] key setting when the default paper cassette is not set	0	0 ~ 1	0: Enabled    1: Disabled	1
957	Icon for performing color registration control display	0	0 ~ 1	Displays the icon for performing the color registration control manually in the control panel display. 0: Enabled    1: Disabled	1
962	Finisher maximum number of sheets for stapling (short size)	0	0~2	0: 50 sheets    1: 30 sheets    2: 20 sheets	1
963	Finisher maximum number of sheets for stapling (long size)	0	0~2	0: 30 sheets    1: 15 sheets    2: 10 sheets	1
964	Saddle stitcher maximum number of sheets for stapling	0	0~1	0: 15 sheets    1: 8 sheets <b>Note:</b> The maximum number of the originals in the magazine sort mode is quadruple of the set number of the sheets.	1
997	Fee charging system counter display	–		Displays the fee charging related counter.	2

<Operation procedure>

Procedure 1

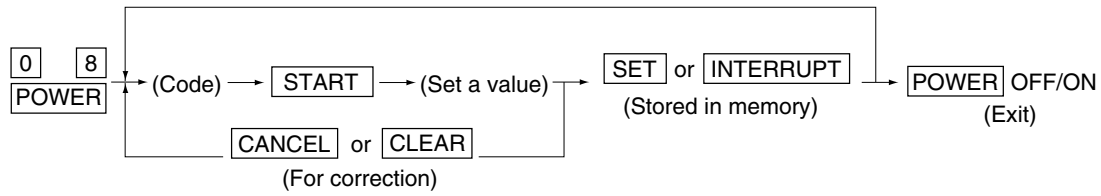

Procedure 2

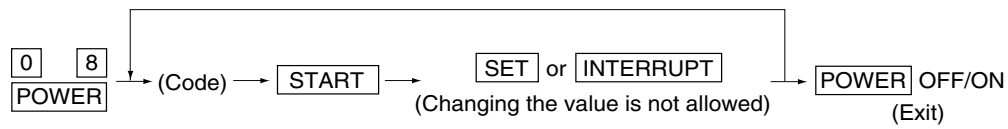

Procedure 4

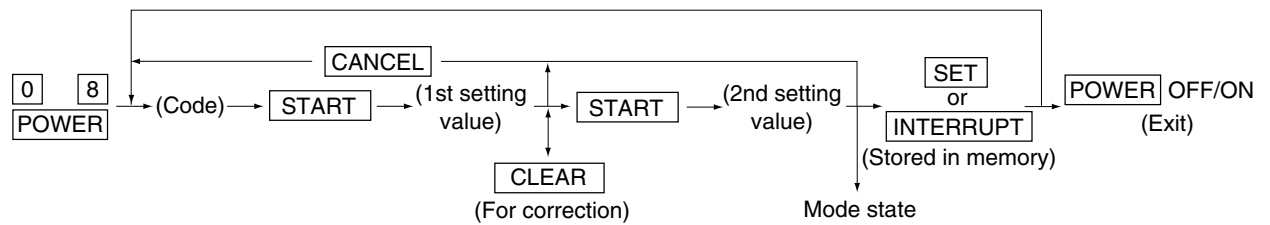

<<Procedure to copy the counter value (08-257)>>

1. Turn ON the power while [0] and [8] are pressed simultaneously.
2. Enter the code [257] with the digital keys and press the [START] key (the following is displayed).

**Note:** Before performing the following operations, note the current counter values.

0 %	257		
SYSTEM MODE			
ORIGINAL		BACKUP	
801	99999999	99999999	
876	99999999	99999999	
877	99999999	99999999	
878	99999999	99999999	
879	99999999	99999999	
880	99999999	99999999	
881	99999999	99999999	
882	99999999	99999999	
-----			
[CANCEL]		1/2	[←] [→]

[<][>]  
key  
←→

0 %	257		
SYSTEM MODE			
ORIGINAL		BACKUP	
883	99999999	99999999	
884	99999999	99999999	
885	99999999	99999999	
-----			
[CANCEL]		2/2	[←] [→]

3. Enter the value "1" or "2" with the digital key and press the [START] key.

The value entered is displayed on the left of the "%", and the [SET] key is displayed.

**Note:** The value can be erased by pressing the [CLEAR] key to change as long as the [START] key is not pressed. (The value on the left of the "%" is reset to "0" by pressing the [CLEAR] key.)

- Enter "1" to copy the value of the original counter (LGC board) onto the value of the backup counter (SYS board).

1 %	257		
SYSTEM MODE			
ORIGINAL	>	BACKUP	
801	99999999	99999999	
876	99999999	99999999	
877	99999999	99999999	
878	99999999	99999999	
879	99999999	99999999	
880	99999999	99999999	
881	99999999	99999999	
882	99999999	99999999	
-----			
[CANCEL]		[SET]	1/2 [←] [→]

- Enter "2" to copy the value of the backup counter (SYS board) onto the value of the original counter (LGC board).

2 %	257		
SYSTEM MODE			
ORIGINAL	<	BACKUP	
801	99999999	99999999	
876	99999999	99999999	
877	99999999	99999999	
878	99999999	99999999	
879	99999999	99999999	
880	99999999	99999999	
881	99999999	99999999	
882	99999999	99999999	
-----			
[CANCEL]		[SET]	1/2 [←] [→]

4. Press the [SET] key to complete overwriting of the counter value.

**Note:** The screen returns to the code entry screen without copying (overwriting) the value when the [CANCEL] key is pressed.

## 2. ADJUSTMENT

### 2.1 Adjustment Order (Image Related Adjustment)

The diagram below explains the main procedures for image related adjustment. When replacing components which have other specified instructions for adjustment, those specified instructions are to be obeyed in priority.

In the following diagram, the solid lines with arrow lead to essential adjustments, while the dotted lines lead to adjustments to be performed if necessary.

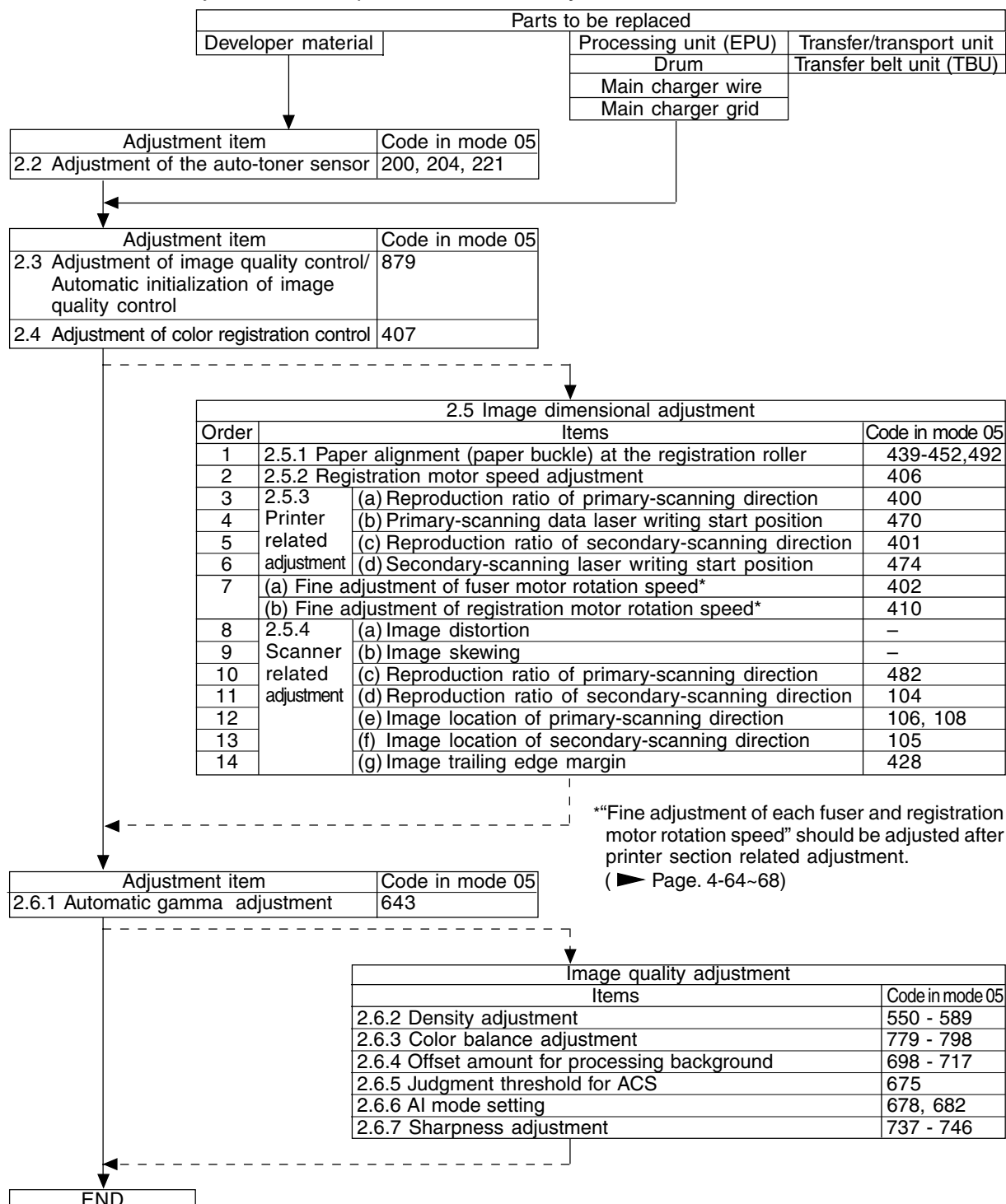

## 2.2 Adjustment of the Auto-Toner Sensor

### 2.2.1 Automatic removing of developer material

- Notes:** 1. This procedure is not necessary if developer material is not filled at the time of unpacking.  
2. After the developer material has been removed, perform the maintenance of the processing unit (EPU) according to "3. PREVENTIVE MAINTENANCE (PM)"

- (1) Remove the toner cartridges.
- (2) Remove the processing unit (EPU) from the copier. Turn the knob of the developer removal shutter, corresponding to the developer color to be removed, on the rear side of the unit (see the illustration below).

**Note:** If the knob cannot be turned normally, this message will be displayed during the developer removing: "[C33] Developer removal shutter abnormal".

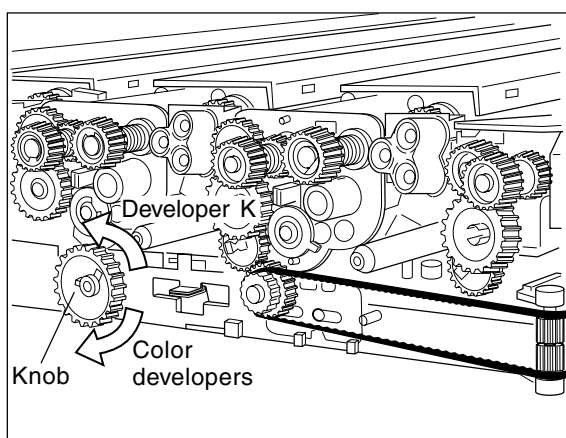

- (3) Return the processing unit (EPU) to the copier (be sure to fix it with screws) and then close the front cover.
- (4) Turn ON the power while digital keys [0] and [5] are pressed simultaneously to display the following screen.

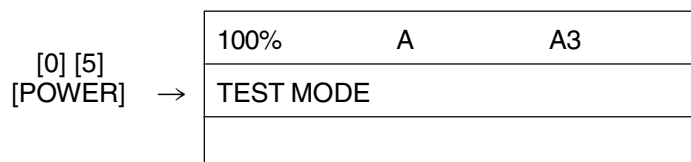

- (5) Enter a code with digital keys and press the [START] key.→The developer material is removed.

Code 391 : All color developer materials (Y,M and C) are removed.  
392 : Only the developer material K is removed.

- Notes:** 1. Fully confirm that the developer material to be removed corresponds to the code entered.  
2. If you receive an error message upon completing step (5), the removal shutter of 1 or more developer unit(s) is closed. Open the appropriate shutter(s) and repeat step(5).





(5) Approx. 2 minutes after the developer material filling is finished, the following display appears:

Ⓑ →	Y:6.30V M:6.38V C:6.38V K:6.38V
Ⓒ →	58%
Ⓐ →	Y:4.00V M:4.00V C:4.00V K:4.00V

Upper line Ⓑ : Current sensor voltages (V)

Middle line Ⓒ : Humidity (%)

Lower line Ⓐ : Target values (V) for adjustment reference voltages

**Notes:**

- The current sensor voltages (V) shown in Ⓑ automatically change, gradually approaching the target values for adjustment reference voltages shown in Ⓐ.
- Values are displayed only for the developer materials being filled.

(6) In 30 to 60 seconds, the current sensor voltages (V) in Ⓑ are converged to those in Ⓐ. The humidity shown in Ⓒ disappears, and the sensor output control values (bit values) are shown instead.

Ⓑ →	Y:4.00V M:4.00V C:4.00V K:4.00V
Ⓒ →	Y: 140 M: 140 C: 140 K: 140
Ⓐ →	Y:4.00V M:4.00V C:4.00V K:4.00V

**Note:** Be careful that the values in Ⓐ, Ⓑ and Ⓒ vary with humidity.

Ⓐ : Target value (V) for adjustment reference voltage

Humidity (%)	Y	M	C	K
~29.9	3.60	3.60	3.50	3.50
30.0~44.9	3.84	3.84	3.74	3.74
45.0~59.9	4.00	4.00	4.00	4.00
60.0~74.9	4.27	4.27	4.27	4.27
75.0~	4.50	4.50	4.50	4.50

Ⓑ : Current sensor voltage (V)

Humidity (%)	Y	M	C	K
~29.9	3.55~3.65	3.55~3.65	3.45~3.55	3.45~3.55
30.0~44.9	3.79~3.89	3.79~3.89	3.69~3.79	3.69~3.79
45.0~59.9	3.95~4.05	3.95~4.05	3.95~4.05	3.95~4.05
60.0~74.9	4.22~4.32	4.22~4.32	4.22~4.32	4.22~4.32
75.0~	4.45~4.55	4.45~4.55	4.45~4.55	4.45~4.55

- (7) If an adjustment error occurs, values of the color in problem displayed in Ⓐ, Ⓑ or Ⓒ are replaced with “ \* \* \* ”.

As for properly adjusted colors, press the [INTERRUPT] key to store their adjustment results in memory.

- (8) Press the [INTERRUPT] key to store the adjustment results in memory. The screen returns to the initial display.

[INTERRUPT] →

100%	A	A3
TEST MODE		

- (9) Remove the developer cartridge(s).

- (10) Install the toner cartridge(s).

<Troubleshooting in auto-toner sensor adjustment> (measures against adjustment error)

Check which color is in adjustment error.

Is the developer unit filled with developer material? (Is the developer cartridge empty?)

NO

- (1) Check if the shutter seal is removed from the developer cartridge.
- (2) Check the toner motor performance, using the following test modes.

Y: 03-110 ON, 03-160 OFF

M: 03-111 ON, 03-161 OFF

C: 03-112 ON, 03-162 OFF

K: 03-113 ON, 03-163 OFF

- (3) Check if the developer cartridge gears rotate properly.

YES

As for the colors completely adjusted, press the [INTERRUPT] key to store their adjustment results in the memory. Perform again the adjustment procedure to the color in adjustment error.

05-245: All developers

05-246: Developer Y

05-247: Developer M

05-248: Developer C

05-249: Developer K

05-250: Color developers

Is the adjustment completed?

NO

- (1) Check if the unit is filled with developer material.
- (2) Check if any toner or carrier is stuck on the transfer belt or the drum surface at the bottom of the processing unit (EPU).

NO

Check the high-voltage contacts.

- Main charger wire
- Main charger grid
- Developer bias

Replace disabled parts.

Replace the processing unit (EPU).

YES

YES

Perform the adjustment procedure again.

Press the [INTERRUPT] key to store the adjustment results in the memory.

## 2.3 Adjustment of Image Quality Control

(1) At the time of unpacking

Prior to image dimensional adjustment, perform the “Automatic initialization of image quality control (05-879)” procedure.

(2) When any of the following parts is replaced, be sure to perform the “Automatic initialization of image quality control (05-879)” procedure.

- Processing unit (EPU)
- Transfer belt unit (TBU)
- Photoconductive drum
- Developer material
- Laser optical unit
- Image quality sensor

**Note:** When performing "Automatic gamma adjustment" in addition, “Automatic initialization of image quality control” should be done first.

(3) When performing "Automatic gamma adjustment" in cases other than the above ones, do the “Forced performing of image quality control (05-878)” procedure before "Automatic gamma adjustment".

Code	Adjustment item	Contents
878	Forced performing of image quality control	<p>&lt;Procedure&gt;</p> <p>(1) While pressing [0] and [5] simultaneously, turn the power ON. → Adjustment mode</p> <p>(2) Enter [878] with digital keys and press the [START] key.</p> <p>(3) When the adjustment finishes normally, the copier will return to the adjustment mode's initial state.</p> <p>If an error has occurred, take appropriate action by referring to “4.TROUBLESHOOTING”.</p>
879	Automatic initialization of image quality control	<p>&lt;Procedure&gt;</p> <p>(1) While pressing [0] and [5] simultaneously, turn the power ON. → Adjustment mode</p> <p>(2) Enter [879] with digital keys and press the [START] key.</p> <p>(3) When the adjustment finishes normally, the copier will return to the adjustment mode's initial state.</p> <p>If an error has occurred, take appropriate action by referring to “4.TROUBLESHOOTING”.</p>

## 2.4 Adjustment of Color Registration Control

After having finished the "Automatic initialization of image quality control (05-879)" procedure, perform the "Forced performing of color registration control adjustment (05-407)" procedure.

Code	Adjustment item	Contents
407	Forced performing of color registration control	<p data-bbox="657 378 804 406">&lt;Procedure&gt;</p> <ol data-bbox="657 417 1390 604" style="list-style-type: none"><li data-bbox="657 417 1390 485">(1) While pressing [0] and [5] simultaneously, turn the power ON. → Adjustment mode</li><li data-bbox="657 495 1299 523">(2) Enter [407] with digital keys and press the [START] key.</li><li data-bbox="657 534 1390 604">(3) When the adjustment finishes normally, the copier will return to the adjustment mode's initial state.</li></ol> <p data-bbox="703 619 1390 687">If an error has occurred, take appropriate action by referring to "4. TROUBLESHOOTING".</p>

## 2.5 Image Dimensional Adjustment

There are several adjustment items in the image dimensional adjustment, as listed below. Prior to this image dimensional adjustment, perform the "Automatic initialization of image quality control (05-879)". When adjusting these items, the following adjustment order should strictly be observed.

Adjustment item		Code in mode 05
① Paper alignment (paper buckle) at the registration roller		439 – 452, 492
② Registration motor speed adjustment		406
③ Printer section related adjustment	(a) Reproduction ratio adjustment of primary-scanning direction (Fine adjustment of polygonal motor rotation speed)	400
	(b) Adjustment of primary-scanning laser writing start position	470
	(c) Reproduction ratio adjustment of secondary-scanning direction (Fine adjustment of drum motor/transfer belt motor rotation speed)	401
	(d) Adjustment of secondary-scanning laser writing start position	474
④	(a) Fine adjustment of fuser motor rotation speed*	402
	(b) Fine adjustment of registration motor rotation speed*	410
⑤ Scanner section related adjustment	(a) Image distortion adjustment	–
	(b) Image skewing adjustment	–
	(c) Reproduction ratio adjustment of primary-scanning direction	482
	(d) Reproduction ratio adjustment of secondary-scanning direction	104
	(e) Image location adjustment of primary-scanning direction	106, 108
	(f) Image location adjustment of secondary-scanning direction	105
	(g) Adjustment of image trailing edge margin	428

\* "Fine adjustment of each fuser and registration motor rotation speed" should be adjusted after printer section related adjustment. (▶ Page. 4-64~68)

[Procedure for entering adjustment values]

In accordance with the procedure described below, make adjustment of each adjustment item so that the measured values obtained from test copies satisfy the specification. By pressing the [ENERGY SAVER] key, immediately after starting the adjustment mode (05), single-sided test copying can be performed (normal copy mode).

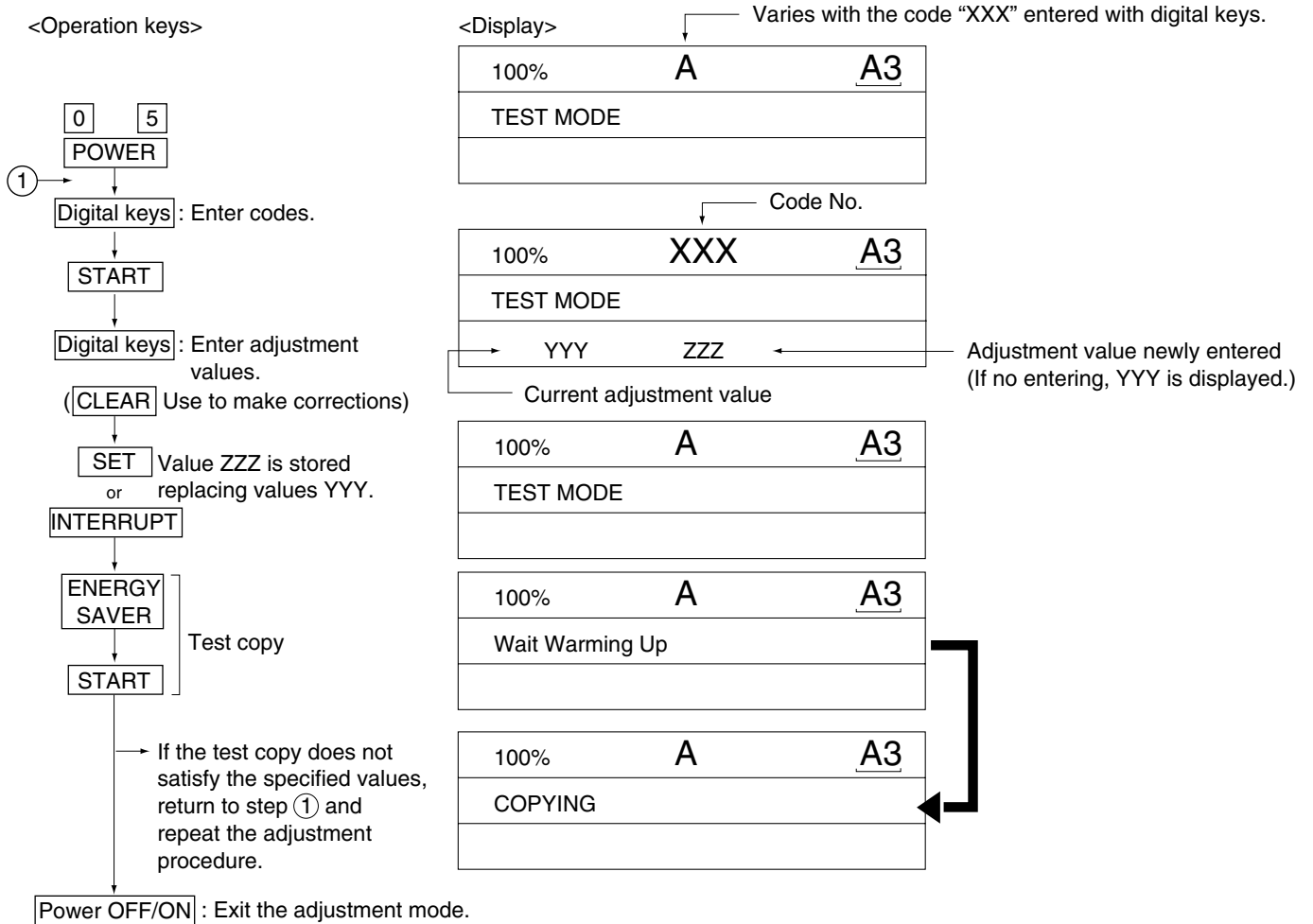



## 2.5.1 Paper alignment (paper buckle) at the registration roller

<Operation procedure> (Use codes 439 to 452 and 492 in adjustment mode (05).)

	Copier cassettes				ADU	LCF	Bypass feeding	Thick paper2	Thick paper3	OHP bypass feeding
	1st cassette	2nd cassette	3rd cassette	4th cassette						
Long size	439	441	443	445	447					
Short size	440	442	444	446	448					

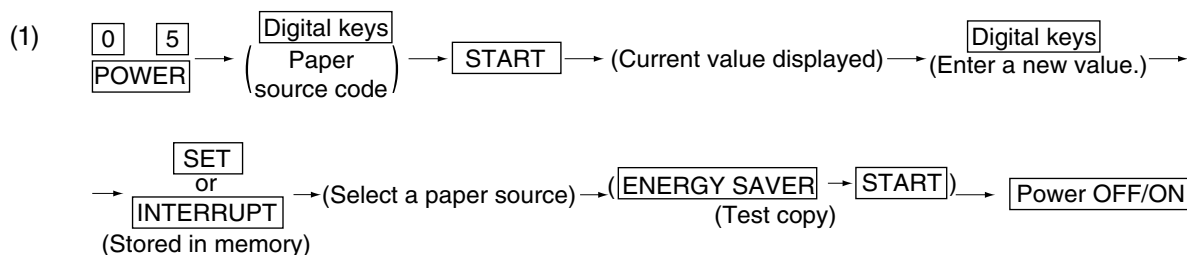

- (2) Check for any transfer void or “Z” fold. If a transfer problem is present, try the values in descending order as “31”→“30”→“29”... until the transfer void disappears. At the same time, confirm that any paper jam has not occurred. Also, when the aligning amount has been increased, this may increase the scraping sound which occurs when the paper scrapes on the mylar sheet as it is transferred by the registration roller. If this scraping sound is irritating, try reducing the aligning amount.
- (3) Do the same for ADU, LCF, bypass feeding, thick paper 2, thick paper 3 and OHP bypass feeding.

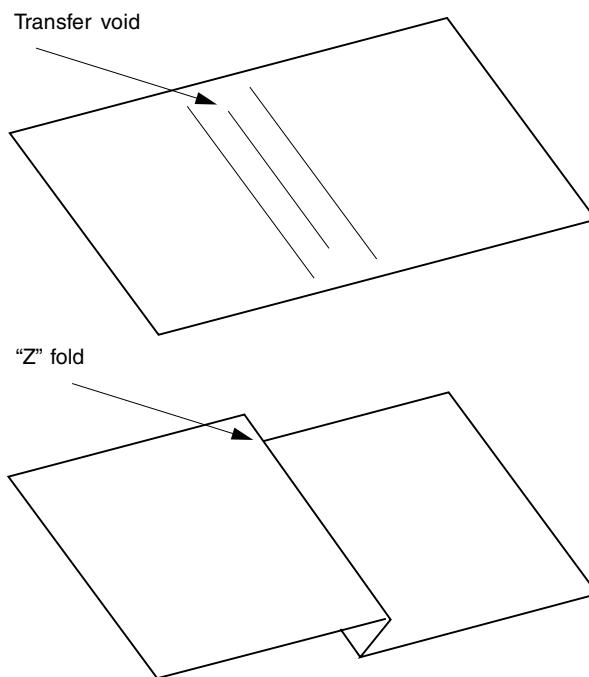

### Note:

When paper thinner than specified is used, paper jams may occur frequently at the registration section. In this case, it is advisable to change (or reduce) the aligning amount.

However, if the aligning amount is reduced too much, this could cause the leading edge margin to vary adversely. So, when adjusting the aligning amount, try to choose the appropriate amount while checking the leading edge margin at the same time.

If the paper feed roller has prematurely become defective, it is possible to extend its service life, if necessary, by increasing the aligning amount, as a temporary measure until a replacement becomes available.

## 2.5.2 Registration motor speed adjustment

The paper transport speed of the registration roller vis-a-vis the image print speed can be set to the optimum value.

<Procedure>

- (1) While pressing the digital keys [0] and [5] simultaneously, turn the power ON. → (Adjustment mode)
- (2) Set five sheets of A4-R /LT-R paper into the bypass tray.
- (3) Enter [10] and press the [PRINTER/NETWORK] key to perform the continuous printing of five “adjustment charts” from the bypass tray.
- (4) Since the printed sheets of “adjustment charts” are slightly shrunk after being fused, it is required to wait one to two minutes to cool them for precise adjustment. Then, set those five sheets again into the bypass tray in the same print direction, with the chart face upward.
- (5) Without changing the adjustment mode, enter [406] and press the [START] key.  
While the “adjustment chart” sheets are fed and transported, the pitches in the black belt zone are read.
- (6) Step (5) is to be repeated five times automatically.  
The displayed set value does not change until the fourth round and at the fifth round, a newly set value is displayed.
- (7) When a newly set value for aligning is displayed at the fifth round, press the [INTERRUPT] key to update the set value.  
If error or jam occurs when feeding the adjustment charts, press the [CLEAR] key and perform step (2) to step (7) again.

### 2.5.3 Printer section related adjustment

(a) Reproduction ratio adjustment of primary-scanning direction (Fine adjustment of polygonal motor rotation speed)

1. While pressing the digital keys [0] and [5] simultaneously, turn ON the power. → (Adjustment mode)
2. Press [1]→[PRINTER/NETWORK]. (A grid pattern with 10 mm squares is printed out. Use A3/LD from the 2nd cassette.)
3. Measure the distance A from the first grid line at the rear to the 21st of the grid pattern.
4. Check if the distance A is within  $200\pm 0.5$  mm or not.
5. If it is not, use the following procedure to change values and repeat step 2. to 4. above.

<Procedure> (Adjustment mode) → (Enter code [400] with digital keys) → [START]  
→ (Enter a value (acceptable values: 1209 to 1235) with digital keys)  
→ [SET] or [INTERRUPT] (Stored in memory)  
→ (Enter code [407] with digital keys) → [START]  
→ Forced performing of color registration control

\*The larger the adjustment value, the shorter the distance A becomes ( $0.082\%/\text{step} = 0.164\text{ mm}/\text{step}$ ).

(b) Adjustment of primary-scanning laser writing start position

1. While pressing the digital keys [0] and [5] simultaneously, turn ON the power. → (Adjustment mode)
2. Press [1]→[PRINTER/NETWORK]. (A grid pattern with 10 mm squares is printed out. Use A3/LD from the 2nd cassette.)
3. Measure the distance B from the front edge of the paper to the 1st grid line from the front of the grid pattern.
4. Check if the distance B is within  $5\pm 0.5$  mm or not.
5. If it is not, use the following procedure to change values and repeat step 2. to 4. above.

<Procedure> (Adjustment mode) → (Enter code [470] with digital keys) → [START]  
→ (Enter a value (acceptable values: 0 to 255) with digital keys)  
→ [SET] or [INTERRUPT] (Stored in memory).  
→ (Enter code [407] with digital keys) → [START]  
→ Forced performing of color registration control

\*The larger the adjustment value, the longer the distance B becomes ( $0.0423\text{ mm}/\text{step}$ ).

(c) Reproduction ratio adjustment of secondary-scanning direction (Fine adjustment of drum motor/transfer belt motor rotation speed)

1. While pressing the digital keys [0] and [5] simultaneously, turn ON the power. → (Adjustment mode)
2. Press [1]→[PRINTER/NETWORK]. (A grid pattern with 10mm squares is printed out. Use A3/LD from the 2nd cassette.)
3. Measure the distance C between the 6th (down from the leading edge of the paper) and the 26th grid lines of the grid pattern.
4. Check if the distance C is within  $200\pm 0.5$  mm or not.
5. If it is not, use the following procedure to change values and repeat step 2. to 4. above.

<Procedure> (Adjustment mode) → (Enter code [401] with digital keys) → [START]  
→ (Enter a value (acceptable values: 1608 to 1965) with digital keys)  
→ [SET] or [INTERRUPT] (Stored in memory)  
→ (Enter code [407] with digital keys) → [START]  
→ Forced performing of color registration control

\*The larger the adjustment value, the shorter the distance C becomes ( $0.074 \text{ \%/step} = 0.15 \text{ mm/step}$ ).

(d) Secondary-scanning laser writing start position adjustment

1. While pressing the digital keys [0] and [5] simultaneously, turn ON the power. → (Adjustment mode)
2. Press [1]→[PRINTER/NETWORK]. (A grid pattern with 10mm squares is printed out. Use A3/LD from the 2nd cassette.)
3. Measure the distance D from the leading edge of the paper to the 6th grid line of the grid pattern.
4. Check if the distance D is within  $55\pm 0.5$  mm or not.
5. If it is not, use the following procedure to change values and repeat step 2. to 4. above.

<Procedure> (Adjustment mode) → (Enter code [474] with digital keys) → [START]  
→ (Enter a value (acceptable values: 1 to 15) with digital keys)  
→ [SET] or [INTERRUPT] (Stored in memory)  
→ (Enter code [407] with digital keys) → [START]  
→ Forced performing of color registration control

\*The larger the adjustment value, the shorter the distance D becomes ( $0.6 \text{ mm/step}$ ).

**Note:** The reproduction ratio adjustment and the laser writing start position adjustment in the primary- and secondary-scanning directions have a connection as shown below.

1. When 05-400 is adjusted, 05-401, 402, 403, 404, 410 and 474 are automatically adjusted.
2. When 05-401 is adjusted, 05-402, 403, 404, 410 and 474 are automatically adjusted.
3. When 05-406 is adjusted, 05-404 and 410 are automatically adjusted.
4. When 05-410 is adjusted, 05-404 is automatically adjusted.

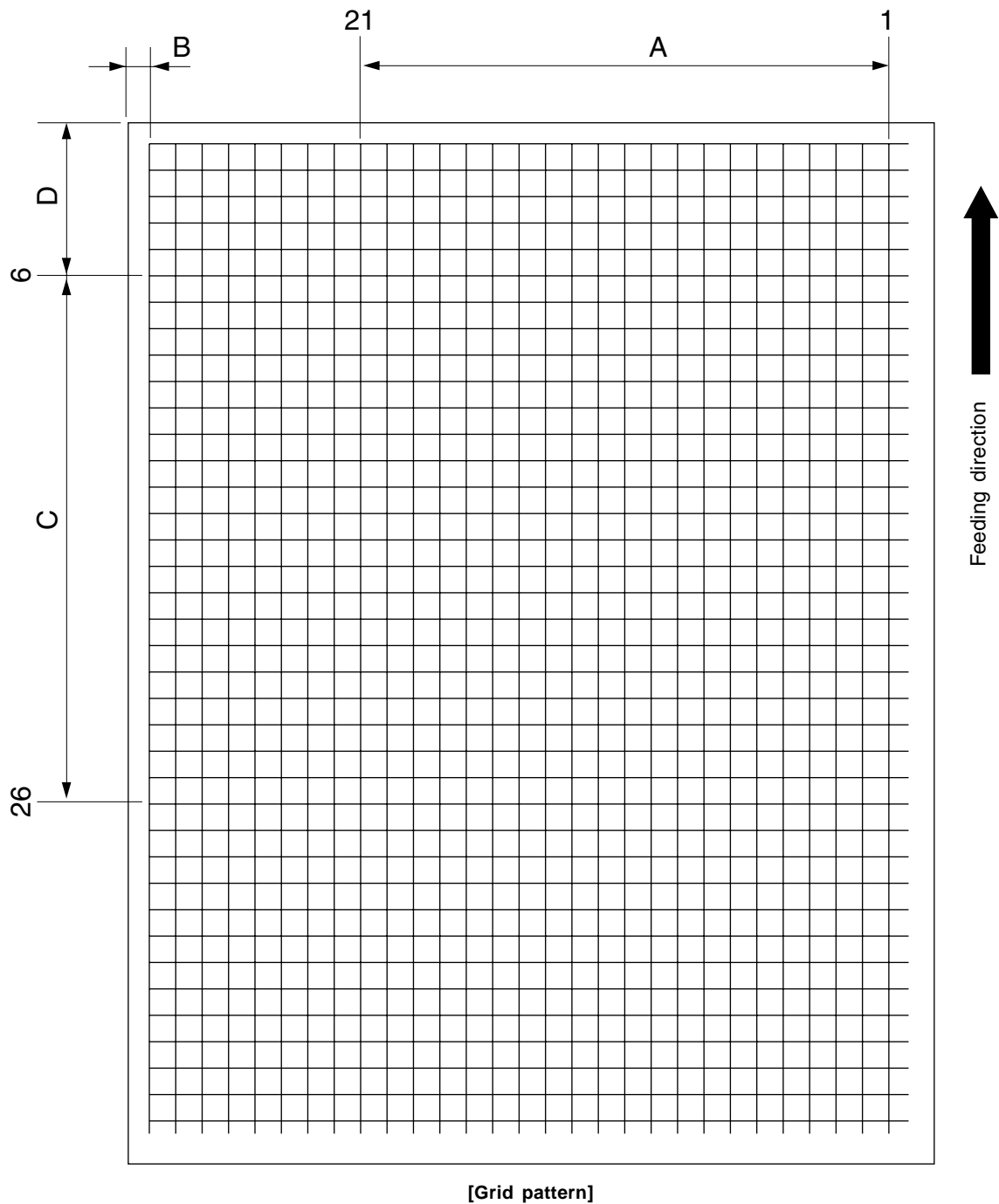

<Adjustment order>

[0] [5] [power ON] → [1] → [PRINTER/NETWORK] (2nd cassette, A3/LD)

A: 05-400 → 200±0.5 mm (0.164 mm/step) → 05-407

B: 05-470 → 5±0.5 mm (0.042 mm/step) → 05-407

C: 05-401 → 200±0.5 mm (0.15 mm/step) → 05-407

D: 05-474 → 55±0.5 mm (0.6 mm/step) → 05-407

## 2.5.4 Scanner related adjustment

### (a) Image distortion adjustment

**Note:** The screws on the rear side of mirror-1 and -3 must not be adjusted.

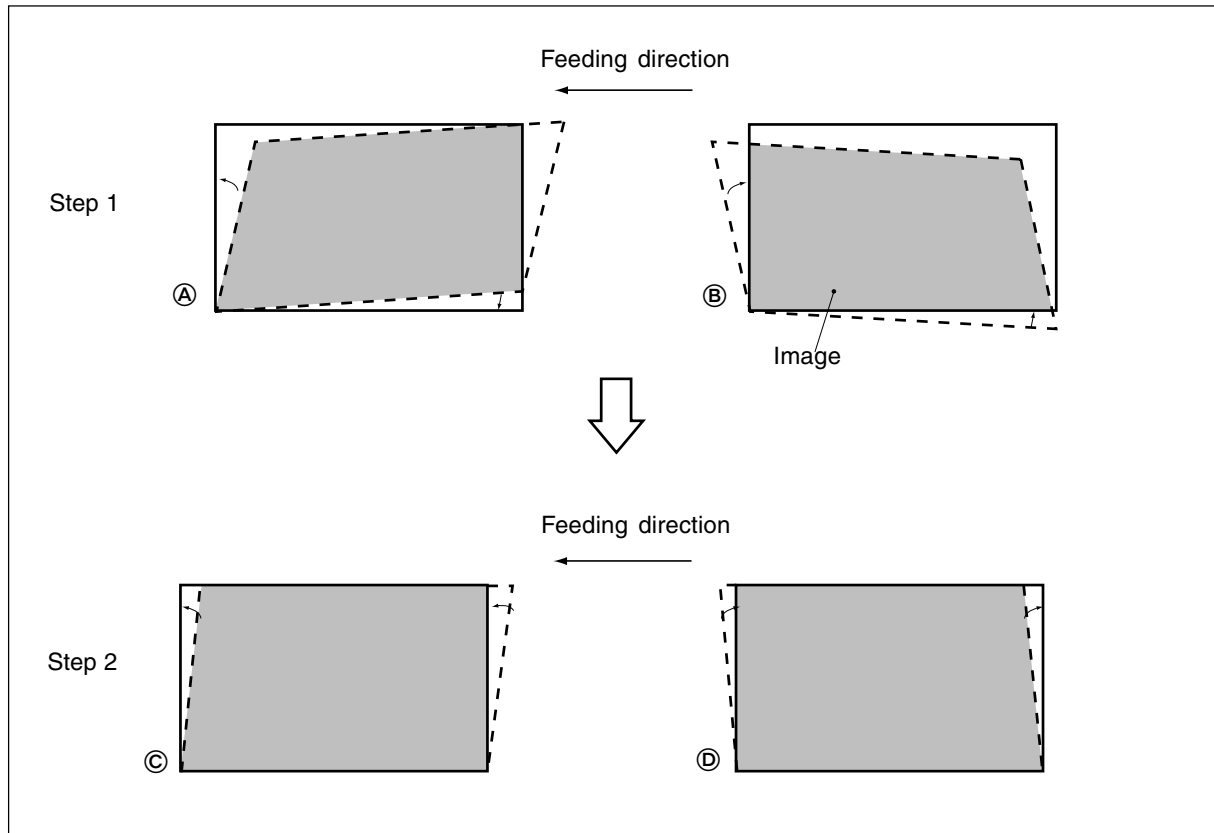

#### <Procedure>

Remove the original glass and the left top cover, and then move carriage-1 toward the paper exit side until it stops. Insert a plus type screwdriver through the hole of the indicator unit to adjust the screws as per step 1 to step 2 below.

#### Step 1

In case of (A):

Tighten the mirror-2 adjustment screw (CW).

→ Go to (C)

In case of (B):

Loosen the mirror-2 adjustment screw (CCW).

→ Go to (D)

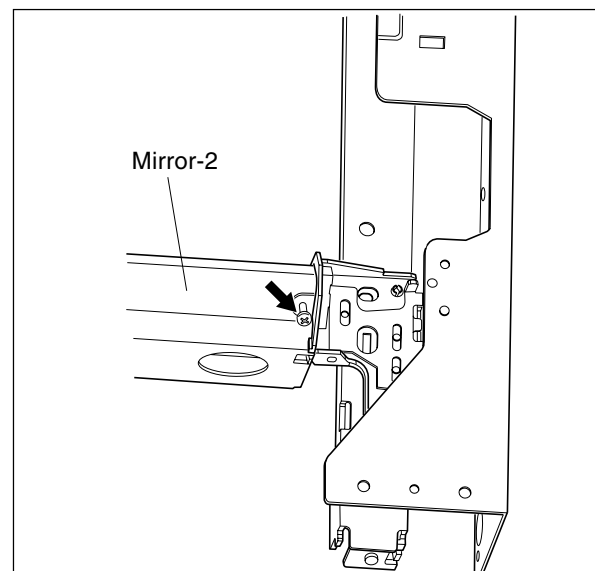

## Step 2

In case of ©:

Tighten the mirror-1 adjustment screw (CW).

→ Normal image

In case of ⊕:

Loosen the mirror-1 adjustment screw (CCW).

→ Normal image

**Note:** After the image distortion adjustment, when the adjustment screws of mirror-1 and -2 are turned, lock the adjustment screws using the adhesive "BOND-1324" for screw locking .

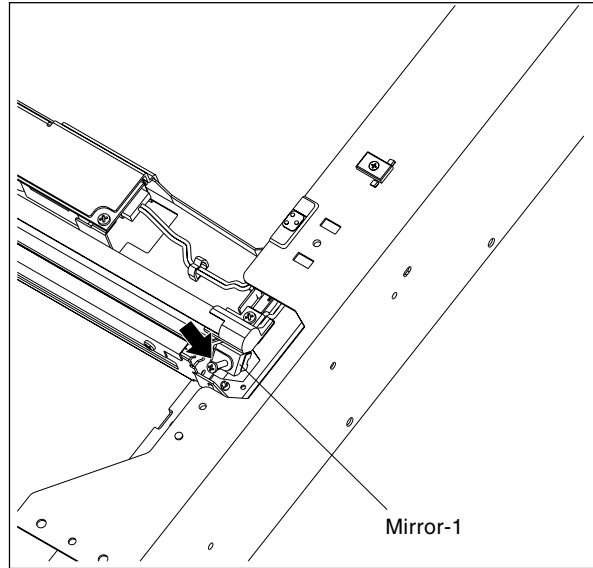

[Application Method of the Adhesive for the Screw Locking]

- (1) Adjust the image distortion.
- (2) Remove the original glass and the indicator unit.
- (3) Move carriage-1 toward the paper exit side.
- (4) Apply the adhesive (BOND-1324) to the adjustment screws of carriage-1 and -2.

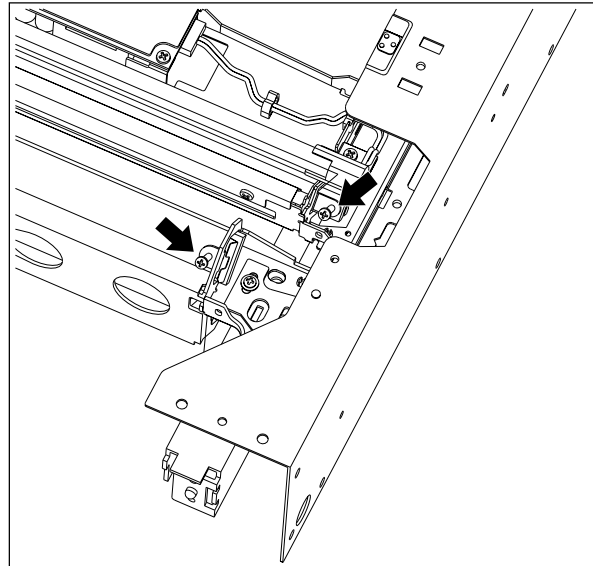

**Note:** Application Method

\*Apply good quantity of the adhesive to the "Application area".

\*The adhesive needs 12 hours to harden completely.

- (5) Confirm that there is no dust or stain on mirror-1, -2 or -3 or the shading correction plate.
- (6) Install the indicator unit and the original glass.

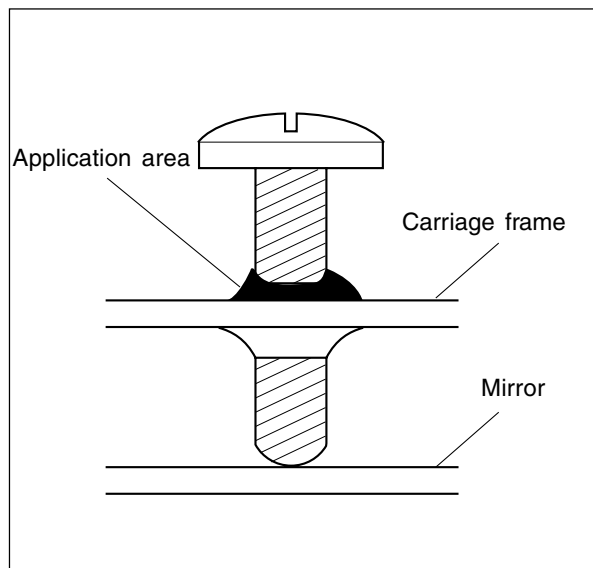

(b) Image skewing adjustment

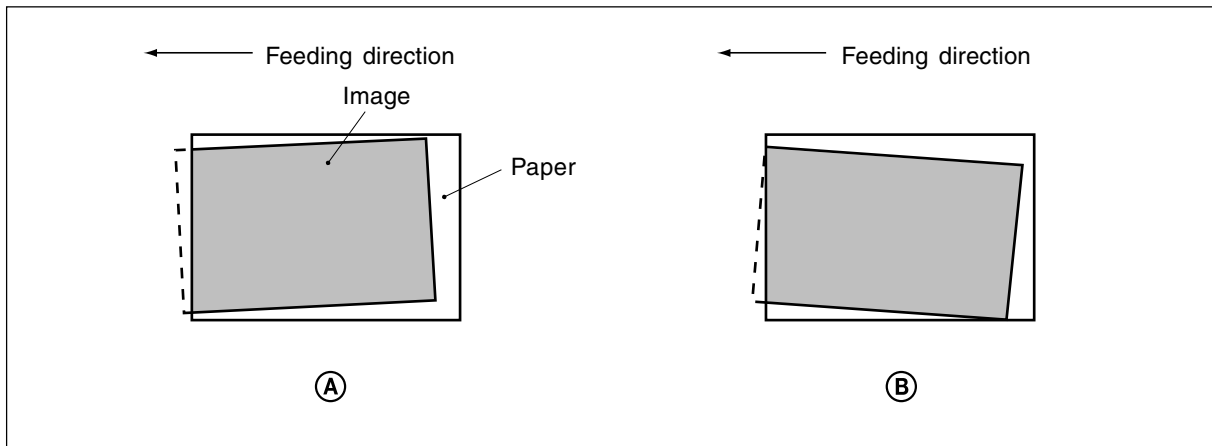

If the copy image is tilted even when the original is placed precisely against the original scale, adjust the original scale to correct this problem.

When the image is tilted as in (A) :

- Move the original scale in the direction of the arrow A →.

When the image is tilted as in (B) :

- Move the original scale in the direction of the arrow B ←.

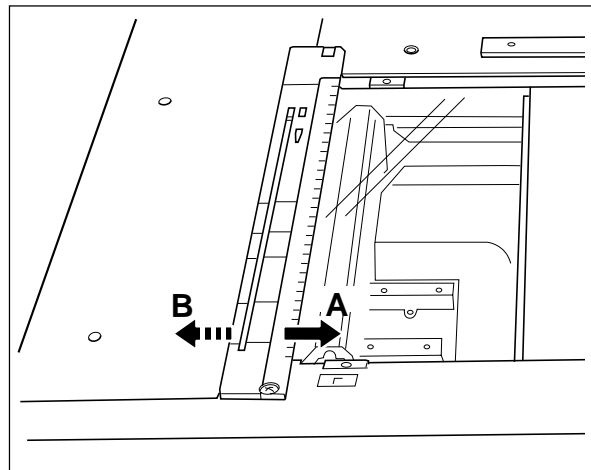



The following adjustments (c) to (g) should be conducted using Test Chart No. TCC-1. (Refer to page 2-22.)

(c) Reproduction ratio adjustment of primary-scanning (Scanner section)

1. While pressing the digital keys [0] and [5] simultaneously, turn the power ON. → (Adjustment mode)
2. Place Test Chart No. TCC-1 on the original glass (with the arrow positioned at the left rear side).
3. Press [ENERGY SAVER] → [START] to make a copy in the mode of A4/LT, 100%, full color and text/photo.
4. Measure the distance A between M1 and M2 on the copy with a ruler.
5. Check if the distance A is within a range of  $200 \pm 0.5$  mm or not.
6. If it is not, change values using the following procedure, and repeat step 3. to 5. above.

<Procedure> (Adjustment mode) → (Enter code [482] with digital keys) → [START]  
→ (Enter a value (acceptable values : 112 to 142) with digital keys)  
→ [SET] or [INTERRUPT] (Stored in memory)  
→ (Enter code [407] with digital keys) → [START]  
→ Forced performing of color registration control

\* The larger the adjustment value, the shorter the distance A becomes (0.2 mm/step).

(d) Reproduction ratio adjustment of secondary-scanning (Scanner section)

1. While pressing the digital keys [0] and [5] simultaneously, turn the power ON. → (Adjustment mode)
2. Place Test Chart No. TCC-1 on the original glass (with the arrow positioned at the left rear side).
3. Press [ENERGY SAVER] → [START] to make a copy in the mode of A4/LT, 100%, full color and text/photo.
4. Measure the distance B between M3 and M4 on the copy with a ruler.
5. Check if the distance B is within a range of  $150 \pm 0.5$  mm or not.
6. If it is not, change values using the following procedure, and repeat step 3. to 5. above.

<Procedure> (Adjustment mode) → (Enter code [104] with digital keys) → [START]  
→ (Enter a value (acceptable values : 1 to 255) with digital keys)  
→ [SET] or [INTERRUPT] (Stored in memory)  
→ (Enter code [407] with digital keys) → [START]  
→ Forced performing of color registration control

\* The larger the adjustment value, the longer the distance B becomes (0.23 mm/step).

(e) Image location adjustment of primary-scanning direction (Scanner section)

1. While pressing the digital keys [0] and [5] simultaneously, turn the power ON. → (Adjustment mode)
2. Place Test Chart No. TCC-1 on the original glass (with the arrow positioned at the left rear side).
3. Press [ENERGY SAVER] → [START] to make a copy in the mode of A4/LT, 100%, full color and text/photo.
4. Measure the distance C from the left paper edge to the 5 mm line of left grid pattern on the copy with a ruler.
5. Check if the distance C is within a range of  $5 \pm 0.5$  mm or not.
6. If it is not, change values using the following procedure, and repeat step 3. to 5. above.

<Procedure> (Adjustment mode) → (Enter code [106] with digital keys) → [START]  
→ (Enter a value (acceptable values : 5 to 251) with digital keys)  
→ [SET] or [INTERRUPT] (Stored in memory)

\*The larger the adjustment value, the shorter the distance C becomes (0.042 mm/step).

7. When the distance C is within the acceptable range, perform the following procedure.

<Procedure> (Adjustment mode) → (Enter code [108] with digital keys) → [START]  
→ (Enter a value with digital keys, deducting 47 from the value set in the 05-106 )  
→ [SET] or [INTERRUPT] (Stored in memory)

(f) Image location adjustment of secondary-scanning direction (Scanner section)

1. While pressing the digital keys [0] and [5] simultaneously, turn the power ON. → (Adjustment mode)
2. Place Test Chart No. TCC-1 on the original glass (with the arrow positioned at the left rear side).
3. Press [ENERGY SAVER] → [START] to make a copy in the mode of A4/LT, 100%, full color and text/photo.
4. Measure the distance D from the top paper edge to the 10 mm line of top grid pattern on the copy with a ruler.
5. Check if the distance D is within a range of  $10 \pm 0.5$  mm or not.
6. If it is not, change values using the following procedure, and repeat step 3. to 5. above.

<Procedure> (Adjustment mode) → (Enter code [105] with digital keys) → [START]  
→ (Enter a value (acceptable values : 85 to 171) with digital keys)  
→ [SET] or [INTERRUPT] (Stored in memory)

\*The larger the adjustment value, the longer the distance D becomes (0.12 mm/step).

(g) Adjustment of image trailing edge margin

1. While pressing the digital keys [0] and [5] simultaneously, turn the power ON. → (Adjustment mode)
2. Place Test Chart No. TCC-1 on the original glass (with the arrow positioned at the left rear side).
3. Press [ENERGY SAVER] → [START] to make a copy in the mode of A4/LT, 100%, full color and text/photo.
4. Measure the margin width E on the bottom edge of the copy image with a ruler.
5. Check if the margin width E is within a range of  $2.5 \pm 0.5$  mm or not.
6. If it is not, change values using the following procedure, and repeat step 3. to 5. above.

<Procedure> (Adjustment mode) → (Enter code [428] with digital keys) → [START]  
→ (Enter a value (acceptable values : 0 to 255) with digital keys)  
→ [SET] or [INTERRUPT] (Stored in memory)

\* The larger the adjustment value, the smaller the margin width on the bottom edge becomes (0.042 mm/step).



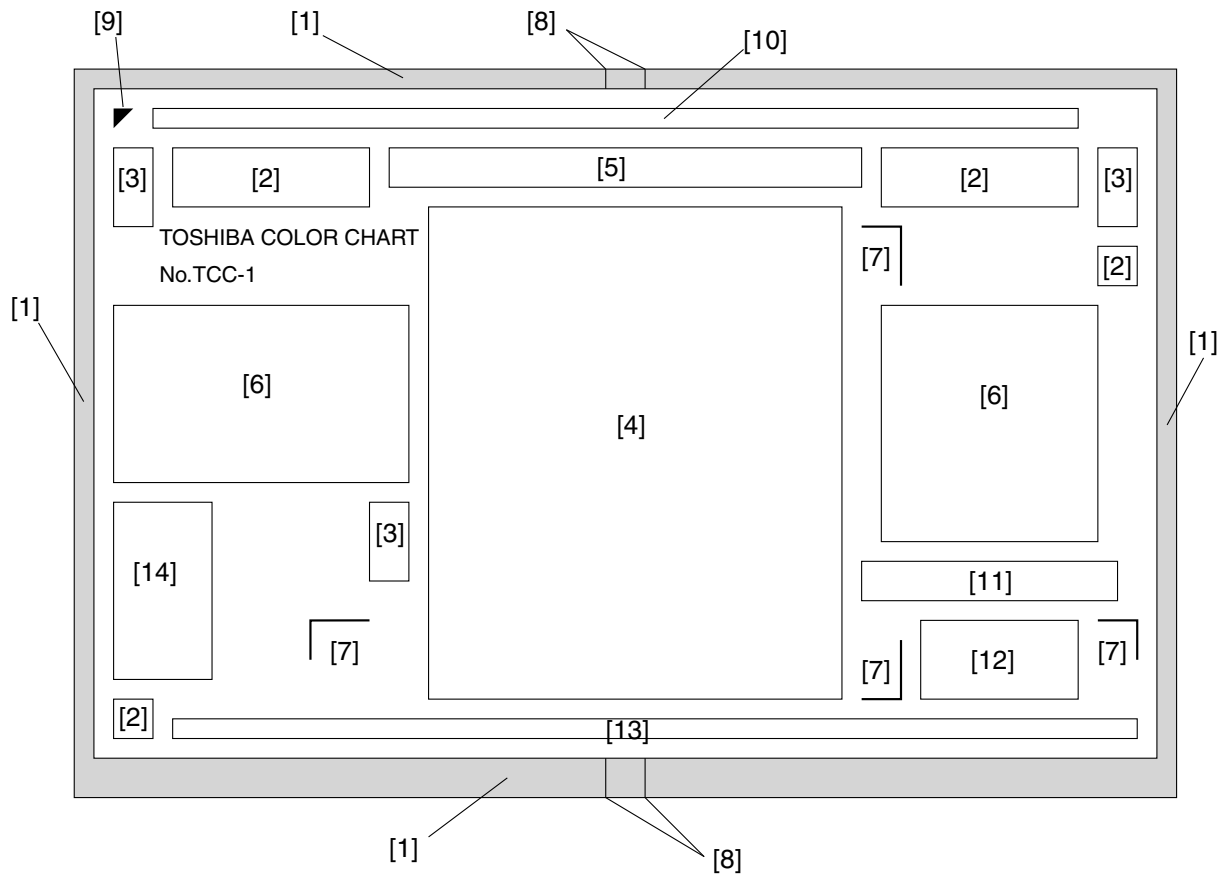

- [1] Grid patterns : For adjusting margin (void) and scanner section
- [2] YMCK patches : For checking uniformity
- [3] Resolution patterns : For checking resolution
- [4] Gradation pattern : Gradation pattern of seven colors (Y, M, C, R, G, B and K)  
Coverage: 10 - 100%  
For adjusting the halftone reproduction and gray balance
- [5] Color registration pattern : For checking color registration
- [6] Pictures : For checking color reproduction and moire
- [7] Magnification lines : For checking the magnification error of primary- and secondary-scanning directions
- [8] Center lines : Center lines for A4/LT sizes
- [9] Arrow : A mark for placing the chart properly onto the original glass (place it to the left rear corner of the original glass.)
- [10] Halftone band : For checking uniformity
- [11] White text on the black solid : For checking the reproduction of white text on black solid
- [12] Text : For checking reproduction of text
- [13] Thin lines : For checking reproduction of the thin lines (line width: 100µm)
- [14] Note area : For recording the date, conditions, etc.

## 2.6 Image Quality Adjustment

### 2.6.1 Automatic gamma adjustment

(1) At the time of unpacking:

When the reproduction of gradation is not appropriate, the gradation reproducibility of all colors Y, M, C and K can be corrected by performing this automatic gamma adjustment. Check the image, and if the gradation reproduction is not satisfactory, make this adjustment as described below.

(2) When any of the following parts has been replaced, be sure to make this adjustment:

- Laser optical unit
- Photoconductive Drum
- Developer material

(3) When any of the following parts are replaced or adjusted, make a copy and check the image to determine if adjustment is necessary:

- Main charger
- Transfer belt

**Note:** Be sure that this adjustment be made after performing the image adjustment in "2.3 Adjustment of Image Quality Control", "2.4 Adjustment of Color Registration Control" and "2.5 Image Dimensional Adjustment".

Code	Adjustment item	Contents
643	Automatic gamma adjustment	<p>&lt;Procedure&gt;</p> <p>(1) While pressing [0] and [5] simultaneously, turn the power ON. → Adjustment mode</p> <p>(2) Select the A3 cassette. Press [4] → [PRINTER/NETWORK] key and output a "Patch chart for gamma adjustment".</p> <p>(3) Place the patch chart for adjustment produced in step (2) face down on the original glass, with its side, on which a black band is present, aligned against the original scale.</p> <p>(4) Enter code [643] with digital keys and press the [START] key. → The scanner reads the chart automatically and performs automatic gamma adjustment calculation (approx. 30 sec.).</p> <p>(5) When the adjustment has finished normally, "SCAN COMPLETE" is shown. Press the [START] key to have the adjustment results reflected. (To cancel the reflection of adjustment results, press the [STOP] key.)</p> <p><b>Note:</b> After the [START] key is pressed, the printer section will operate for about 15 seconds and the density of the standard pattern for image quality control will be measured.</p> <p>In the case of an abnormal ending, "ADJUSTMENT ERROR" is shown. Press the [STOP] key to clear the error display. When it is cleared, the control panel display will return to the standby state. Then, check if the patch chart on the original glass is placed in the wrong direction or if it is placed inclined on the original glass, and then repeat step (3) and afterward.</p>

## 2.6.2 Density adjustment

The center density and the density variation controlled by density adjustment keys can be adjusted as follows.

Color mode	Original mode					Items to be adjusted	Remarks
	Text/photo	Text	Printed image	Photo	Map		
Full color	550	551	552	553	554	Manual density center value	The larger the value, the darker the image becomes.
	560	561	562	563	564	Manual density "dark" step value	The larger the value, the darker the "dark" side becomes.
	570	571	572	573	574	Manual density "light" step value	The larger the value, the lighter the "light" side becomes.
	580	581	582	583	584	Automatic density	The larger the value, the darker the image becomes.
Black	555	556	557	558	559	Manual density center value	The larger the value, the darker the image becomes.
	565	566	567	568	569	Manual density "dark" step value	The larger the value, the darker the "dark" side becomes.
	575	576	577	578	579	Manual density "light" step value	The larger the value, the lighter the "light" side becomes.
	585	586	587	588	589	Automatic density	The larger the value, the darker the image becomes.

Make a test copy and compare the image obtained with the current settings; if necessary, make adjustment using the following procedure.

### <Procedure>

- (1) While pressing [0] and [5] simultaneously, turn the power ON.
- (2) Enter the code of required mode (color mode, original mode, item to be adjusted) with digital keys and press the [START] key.
- (3) Enter an adjustment value with digital keys (acceptable values: 0 to 255).  
(To correct an entered value, press the [CLEAR] key.)
- (4) Press the [SET] or [INTERRUPT] key to store the value. → The copier goes back to the standby state.
- (5) Press the [ENERGY SAVER] key and then press the [START] key to make a test copy.
- (6) If the desired image density has not been attained, repeat step (2) to (5).

## 2.6.3 Color balance adjustment

	Original mode					Item to be adjusted	Remarks
	Text/ photo	Text	Printed image	Photo	Map		
Adjustment code	779	780	781	782	783	Yellow	The larger the value, the darker the color to be adjusted becomes. Acceptable values: 0 to 255.
Sub-code	0	0	0	0	0	Low density	
	1	1	1	1	1	Medium density	
	2	2	2	2	2	High density	
Adjustment code	784	785	786	787	788	Magenta	
Sub-code	0	0	0	0	0	Low density	
	1	1	1	1	1	Medium density	
	2	2	2	2	2	High density	
Adjustment code	789	790	791	792	793	Cyan	
Sub-code	0	0	0	0	0	Low density	
	1	1	1	1	1	Medium density	
	2	2	2	2	2	High density	
Adjustment code	794	795	796	797	798	Black	
Sub-code	0	0	0	0	0	Low density	
	1	1	1	1	1	Medium density	
	2	2	2	2	2	High density	

Make a test copy and compare the image obtained with the current settings; if necessary, make adjustment using the following procedure.

**Note:** Be sure that this adjustment be made after performing "2.6.1 Automatic gamma adjustment".

<Procedure>

- (1) While pressing [0] and [5] simultaneously, turn the power ON.
- (2) Enter the code of required mode (color mode, original mode, item to be adjusted) with digital keys and press the [START] key.
- (3) Select the density area to be adjusted with digital keys (0, 1 or 2), and press the [START] key.  
0 : Low density (L)   1 : Medium density (M)   2 : High density (H)
- (4) Enter an adjustment value with digital keys.  
(To correct an entered value, press the [CLEAR] key.)
- (5) Press the [SET] key to have the value memorized. → Returns to the display in step (3).
- (6) For resetting the value, repeat step (3) to (5).
- (7) Press the [SET] or [INTERRUPT] key to store the value in memory. → The copier goes back to the standby state.
- (8) Press the [ENERGY SAVER] key and then press the [START] key to make a test copy.
- (9) If the desired image density has not been attained, repeat step (2) to (8).



## 2.6.4 Offset adjustment for background processing

The density of background and text can be adjusted as follows.

Color mode	Original mode					Item to be adjusted	Remarks
	Text/photo	Text	Printed image	Photo	Map		
Full color	698	699	700	701	702	Density adjustment for background	The larger the value, the darker the background becomes.
	708	709	710	711	712	Density adjustment for text	The larger the value, the darker the text becomes.
Black	703	704	705	706	707	Density adjustment for background	The larger the value, the darker the background becomes.
	713	714	715	716	717	Density adjustment for text	The larger the value, the darker the text becomes.

Make a test copy and compare the image obtained with the current settings; if necessary, make adjustment using the following procedure.

<Procedure>

- (1) While pressing [0] and [5] simultaneously, turn the power ON.
- (2) Enter the code of required mode (color mode, original mode, item to be adjusted) with digital keys and press the [START] key.
- (3) Enter an adjustment value with digital keys.  
(To correct an entered value, press the [CLEAR] key.)
- (4) Press the [SET] or [INTERRUPT] key to store the value in memory. → The copier goes back to the standby screen.
- (5) Press the [ENERGY SAVER] key and then press the [START] key to make a test copy.
- (6) If the desired image density has not been attained, repeat step (2) to (5).

## 2.6.5 Judgment threshold for ACS

The judgment level is adjusted for the automatic identification of whether the original set on the glass is black-and-white or color. Namely, this is to adjust the judgment level used when “Auto color” is selected in the color mode.

Code	Adjustment item	Contents
675	Judgment threshold for ACS	The larger the value, the more an original tends to be judged to be black-and-white, and the smaller the value, the more it tends to be judged to be color.

## 2.6.6 AI mode setting

### (a) AI mode discrimination setting

Select the discrimination level in the AI mode as follows:

Code	Adjustment item	Contents
678	AI mode discrimination setting	<p>&lt;Procedure&gt;</p> <ol style="list-style-type: none"><li>(1) While pressing [0] and [5] simultaneously, turn ON the power.</li><li>(2) Enter code [678] with digital keys.</li><li>(3) Enter a setting value:<ul style="list-style-type: none"><li>0: Standard (for regular)</li><li>1: Photograph priority</li><li>2: Only judgment of original type</li><li>3: Only judgment of original type with photograph priority</li><li>4: No AI discrimination</li></ul></li><li>(4) Press the [SET] or [INTERRUPT] key to store the setting value.</li></ol>

### (b) AI mode time-out setting

Set the maximum processing time allowable in the AI mode.

**Note:** In case discrimination does not finish within specified time, AI mode discrimination stops and copy operation is performed in the selected copy mode.

Two kinds of setting are made; one for originals of A4/LT or smaller sizes, and the other for originals larger than A4/LT.

Code	Adjustment item	Contents
682	AI mode time-out setting	<p>&lt;Procedure&gt;</p> <ol style="list-style-type: none"><li>(1) While pressing [0] and [5] simultaneously, turn ON the power.</li><li>(2) Enter code [682] with digital keys.</li><li>(3) Enter a setting value:<p>The setting value should be in two digits; the first digit is the time-out period for A3/LD original size while the second digit is the time-out period (seconds) for A4/LT original size. Both digits should be in the range of 1 to 9. However, time is set in proportion to original sizes for originals larger than A4/LT, based on A4/LT and A3/LD setting value.</p></li><li>(4) Press the [SET] or [INTERRUPT] key to store the setting value.</li></ol>

## 2.6.7 Sharpness adjustment

If you want to make copy images look softer or sharper, perform the following adjustment. The adjustment can be made for each of the color modes and original modes independently.

Code	Color mode	Original mode	Contents
737	Full color	Text/photo	<ul style="list-style-type: none"><li>• The larger the value, the sharper the image becomes; while the smaller the value, the softer the image becomes.</li><li>• The smaller the value, the less moire tends to appear.</li><li>• The acceptable values are 0 to 31. The center value is 16. However, 0 is equivalent to the center value.</li></ul> <b>Note:</b> You have to make adjustment by compromising between moire and sharpness.
738		Text	
739		Printed image	
740		Photo	
741		Map	
742	Black	Text/photo	
743		Text	
744		Printed image	
745		Photo	
746		Map	

Make a test copy and compare the image obtained with the current settings; if necessary, make adjustment using the following procedure.

<Procedure>

- (1) While pressing [0] and [5] simultaneously, turn the power ON.
- (2) Enter the code of required mode (color mode or original mode) with digital keys and press the [START] key.
- (3) Enter an adjustment value with digital keys.  
(To correct an entered value, press the [CLEAR] key.)
- (4) Press the [SET] or [INTERRUPT] key to store the value in memory. → The copier goes back to the standby state.
- (5) Press the [ENERGY SAVER] key and then press the [START] key to make a test copy.
- (6) If the desired image sharpness has not been attained, repeat step (2) to (5).

## 2.7 High-Voltage Transformer Settings

### 2.7.1 Overview

This machine uses four main high-voltage transformers for charging/development/discharging and one transfer transformer for transfer/suction.

The main high-voltage transformers (PS-HVT-M-314) are used each for one of the colors Y, M, C and K, giving a total of four units.

The transfer transformer (PS-HVT-TB-310) supplies high-voltage for the transfer rollers Y, M, C and K and the suction charger to be used in black mode.

The main high-voltage transformers have the following high-voltage outputs.

- CH1: main charger wire
- CH2: main charger grid bias
- CH3: developer bias
- CH4: cleaning blade bias

The transfer transformer has the following high-voltage outputs.

- CH1: transfer roller bias (Y)
  - CH2: transfer roller bias (M)
  - CH3: transfer roller bias (C)
  - CH4: transfer roller bias (K)
  - CH5: suction charger
- \* CH5 is used in black mode only.

**Note:** The main high-voltage transformer and transfer transformer for service parts are supplied with the data sheets to be used for the following setup. Be careful not to lose them.

Output adjustment is performed when the devices are shipped, so under any circumstances, do not move the fixed volumes of resistors.

### 2.7.2 Settings after replacing main high-voltage transformers

After replacing a main high-voltage transformer, be sure to enter the data shown on the supplementary data sheet (main charger grid bias and developer bias) according to the procedure below.

<Settings for main charger grid bias>

- (1) Turn the power ON while pressing [0] and [5] simultaneously.
- (2) Enter code 252 and press the [START] key.
  - The lower limit value for main charger grid bias is displayed for each Y, M, C and K.
- (3) Enter the sub-code (0: Y, 1: M, 2: C, 3: K) and press the [START] key.
- (4) Enter a value according to the supplementary data sheet and press the [SET] or [INTERRUPT] key.

- (5) Enter code [253] and press the [START] key.  
→ The upper limit value for main charger grid bias is displayed for each Y, M, C and K.
- (6) Enter the sub-code (0: Y, 1: M, 2: C, 3: K) and press the [START] key.
- (7) Enter a value according to the supplementary data sheet and press the [SET] or [INTERRUPT] key.
- (8) Turn the power OFF.

< Settings for developer bias >

- (1) Turn the power ON while pressing [0] and [5] simultaneously.
- (2) Enter code [257] and press the [START] key.  
→ The lower limit value for developer bias is displayed for each Y, M, C and K.
- (3) Enter sub-code (0: Y, 1: M, 2: C, 3: K) and press the [START] key.
- (4) Enter a value according to the supplementary data sheet and press the [SET] or [INTERRUPT] key.
- (5) Enter code [258] and press the [START] key.  
→ The upper limit value for developer bias is displayed for each Y, M, C and K.
- (6) Enter the sub-code (0: Y, 1: M, 2: C, 3: K) and press the [START] key.
- (7) Enter a value according to the supplementary data sheet and press the [SET] or [INTERRUPT] key.
- (8) Turn the power OFF.

### 2.7.3 Settings after replacing transfer transformer

After replacing a transfer transformer, be sure to enter the data shown on the supplementary data sheet (transfer bias) according to the procedure below.

<Settings for transfer bias>

- (1) Turn the power ON while pressing [0] and [5] simultaneously.
- (2) Enter code [367] and press the [START] key.  
→ The lower limit value for transfer bias is displayed for each Y, M, C and K.
- (3) Enter the sub-code (0: Y, 1: M, 2: C, 3: K) and press the [START] key.
- (4) Enter a value according to the supplementary data sheet, and press [SET] or [INTERRUPT].  
\* Perform the operation in steps (3) and (4) for each of Y, M, C and K.
- (5) Enter code [368] and press the [START] key.  
→ The upper limit value for transfer bias is displayed for each Y, M, C and K.
- (6) Enter the sub-code (0: Y, 1: M, 2: C, 3: K) and press the [START] key.
- (7) Enter a value according to the supplementary data sheet, and press [SET] or [INTERRUPT].  
\* Perform the operation in steps (6) and (7) for each of Y, M, C and K.
- (8) Turn the power OFF.

## 2.8 Adjustment of the Developer Unit

### 2.8.1 Doctor-to-Sleeve Gap

Adjustment tool to use : Doctor-sleeve jig

#### Adjusting procedure :

- (1) Remove the developer unit from the processing unit (EPU), and then remove the developer unit cover and toner-scattering prevention seal holder from the developer unit.

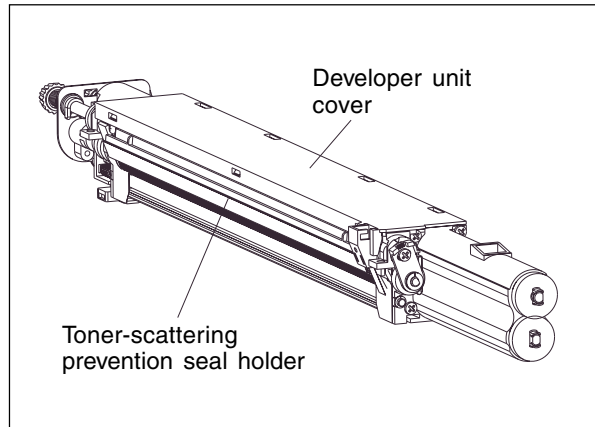

- (2) Loosen the 2 screws for fixing the doctor blade (M3), and insert the gauge "0.65" of the jig into the gap between the developer sleeve and the doctor blade to adjust the gap. Fasten the screws for fixing the doctor blade after adjusting.

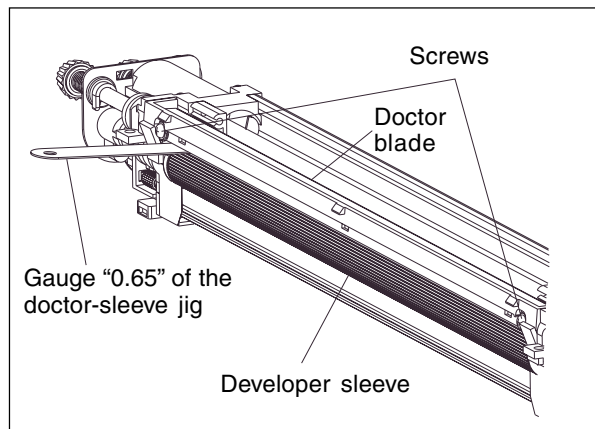

- (3) Insert the gauge "0.60" of the jig into the gap between the sleeve and the doctor, and make sure that the gauge can move smoothly in the front↔rear direction. In addition, confirm that the gauge "0.70" cannot be inserted into the gap.

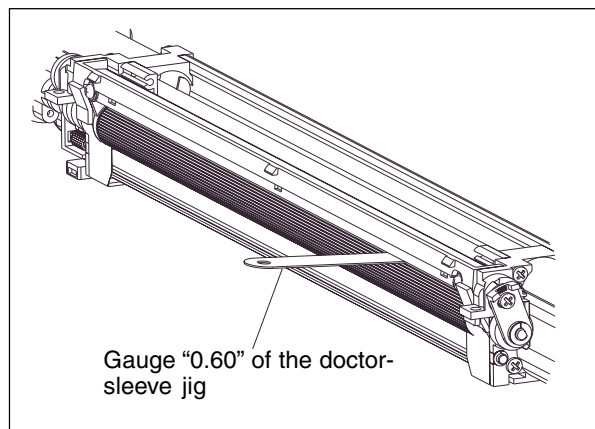

#### **Notes :**

1. When confirming and adjusting the gap between the developer sleeve and the doctor blade, insert the gauges into the gap after rotating the developer sleeve so that its marking faces the doctor blade.
2. While reinstalling the toner-scattering prevention seal holder, insert the slide hooks securely.
3. After reinstalling the toner-scattering prevention seal holder, make sure that each of the side mylar sheets (on the front and rear) is between the 2 urethane rubber sheets.
4. While reinstalling the developer unit cover, fit the latches securely.

## 2.9 Adjustment of the Scanner Section

### 2.9.1 Carriages

#### (a) Installing carriage drive wires

When replacing the carriage drive wires with new wires, proceed as illustrated below:

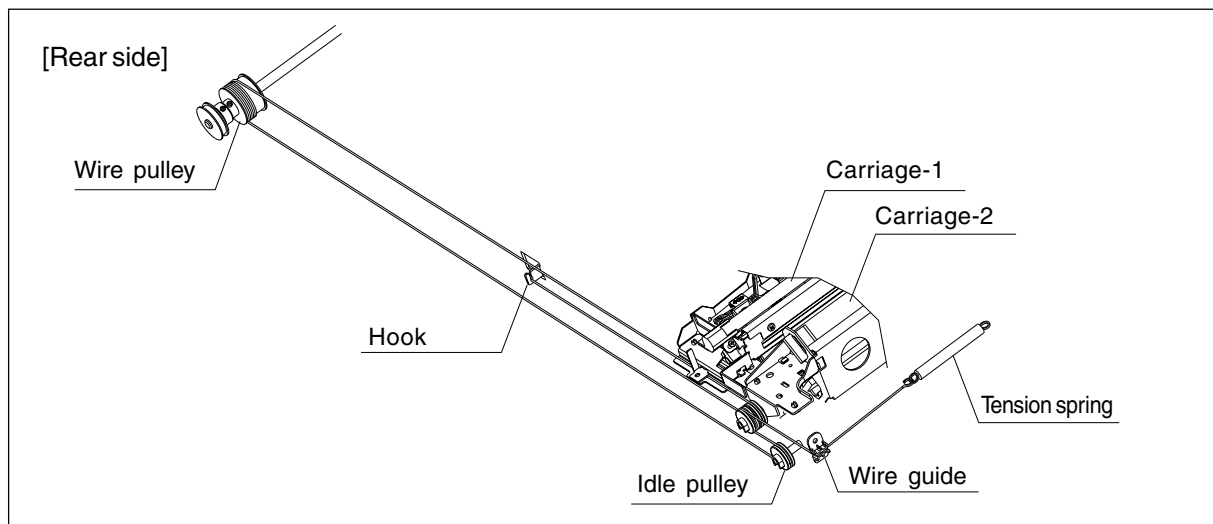
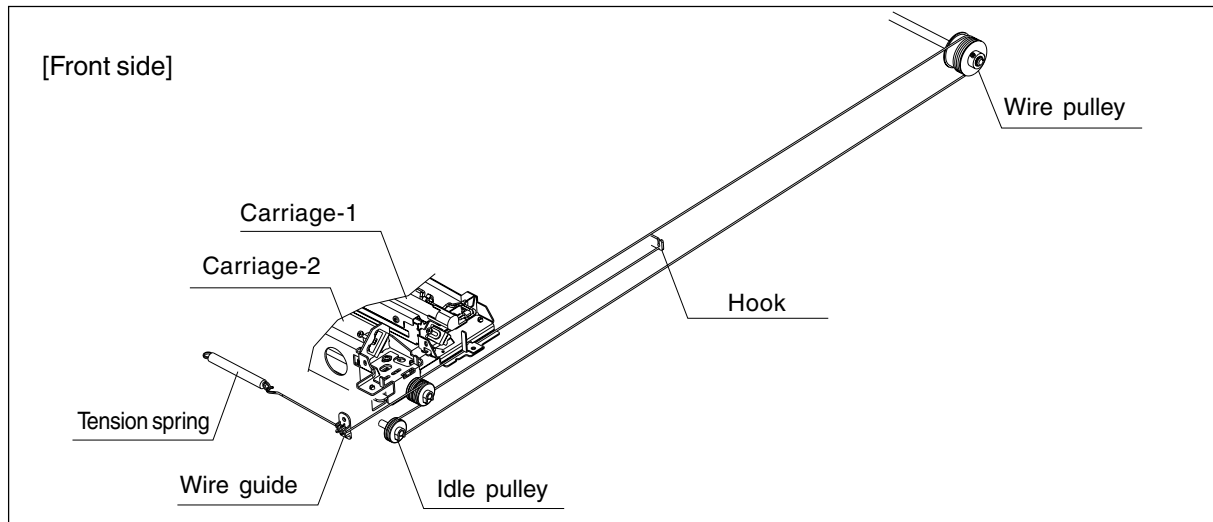

- Notes:**
1. Since the carriage drive wires are applied with proper tension by tension springs, there is no need for tension adjustment.
  2. Check that the wire tension is identical for both front and rear wires and is properly applied.

(b) Adjusting the positions of carriage-1 and -2

1. Loosen 2 screws (on the front and rear) which are fixing carriage-1 to the wires, and another 1 screw (on the front) which is fixing carriage-2 to the wires.
2. Move carriage-2 to the exit side. Insert the carriage jigs into the jig-insertion holes, one on each side (front and rear) of carriage-2, and fasten the screw on the front side of carriage-2.
3. While placing the protruding parts of carriage-1 against the carriage jigs, fasten 2 screws on front and rear sides to fix the carriage-1 to the wire on both front and rear sides.
4. Pull out the carriage jigs.

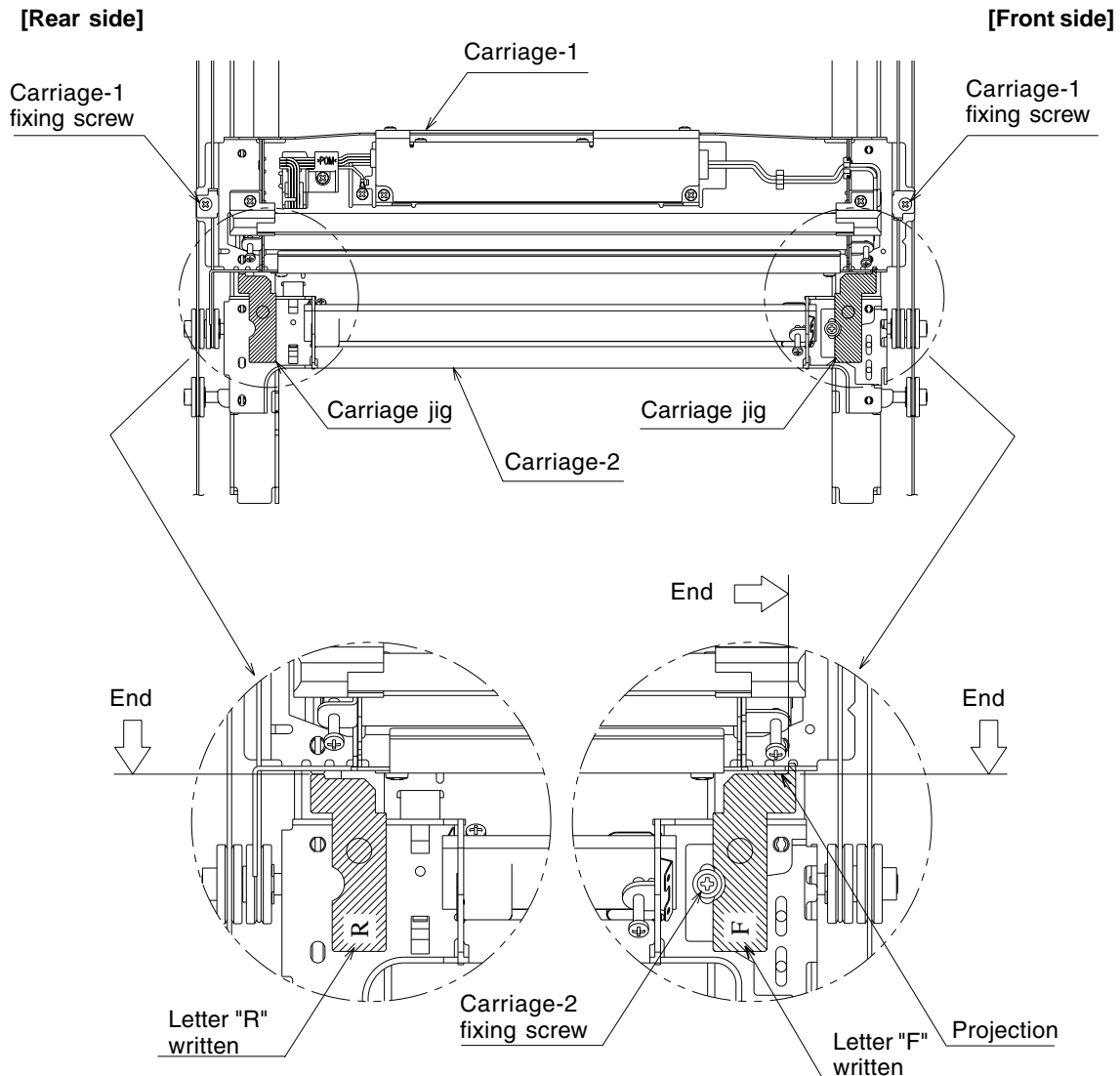
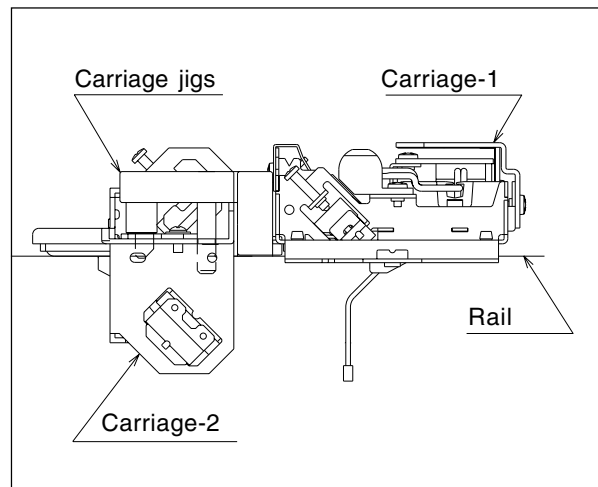



(c) Installing the carriage drive wires to the wire pulleys

Winding the wire to the wire pulleys:

1. Fit the 3-mm ball terminal in the center of the wire into the hole of the wire pulley. The wire should be positioned so that the hook at its end faces upward with its crimped side.
2. Wind the wires onto the wire pulleys on the front and rear. The number of turns to be wound are as follows (see the illustrations below):
  - One turn on the inside of the boss.
  - Six turns on the outside of the boss.

After winding the wires on the pulleys, fix the wires with wire holder jigs to prevent them from unwinding.

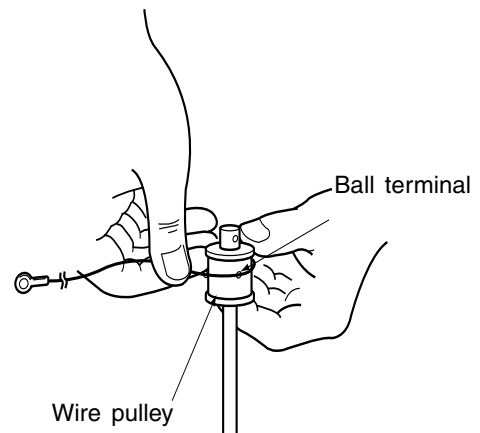

[Rear side]

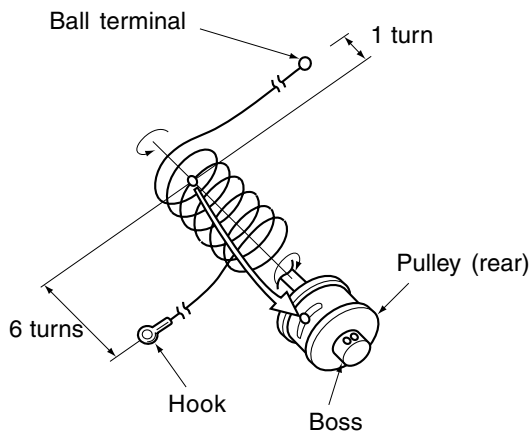

[Front side]

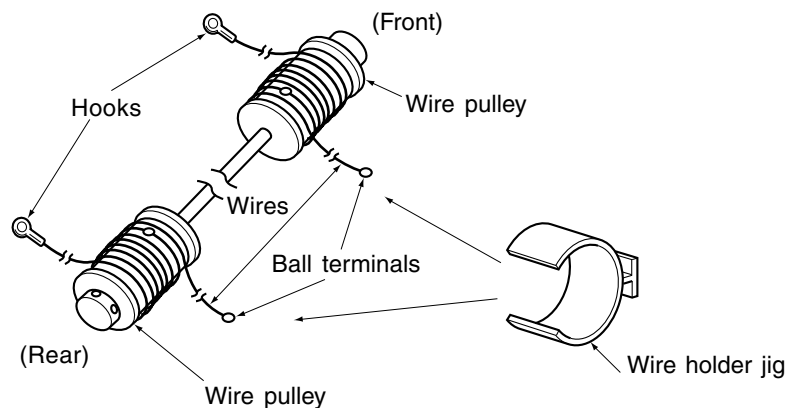
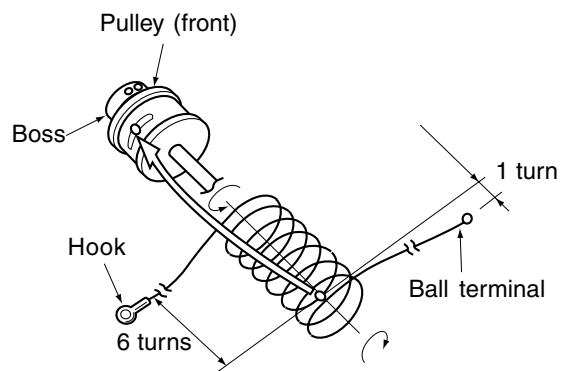

**Notes :**

1. When winding the wires on the pulleys, take the following precautions:
  - Do not wind the wire on the pulley with the wire twisted.
  - Wind the wire strongly so that all the turns of the wire are in firm contact with the surface of the pulley.
  - Each time you wind a turn on the pulley, push it to the preceding turn so that all the turns are closely wound.
2. When fitting wire holder jigs, take care so that the turns wound on the pulleys do not move or unwind.

No gap should exist.

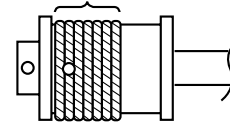

e.g. Front side

<Relationship between wound turns and wire holder jigs>

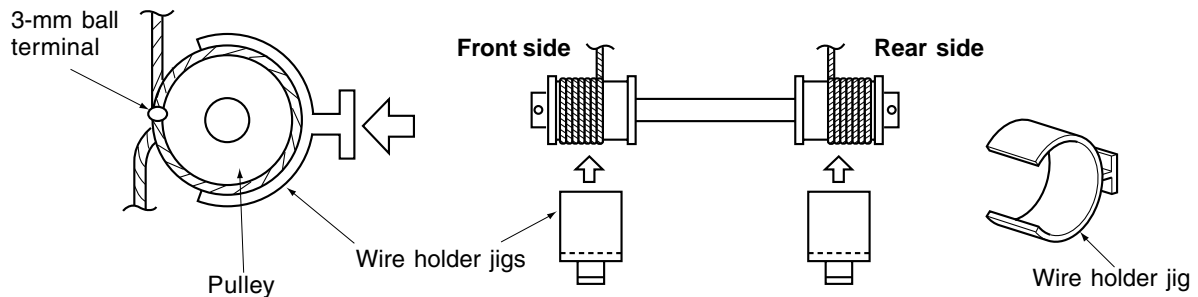

## 2.9.2 Lens unit

### (a) Replacing the lens unit

- Since the lens unit was precisely adjusted at the factory, it must not be readjusted in the field or some of its components must not be replaced. If necessary, the lens unit should be replaced as a unit.
- While replacing with a new lens unit, never loosen or remove the six screws indicated with arrows below. They are locked with adhesive.

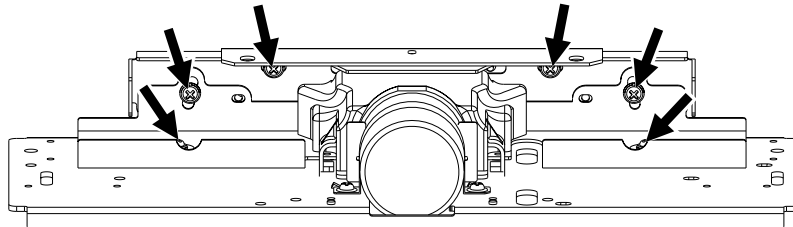

- Use sufficient care when handling the lens unit. Never hold the precision-adjusted area of the lens unit.

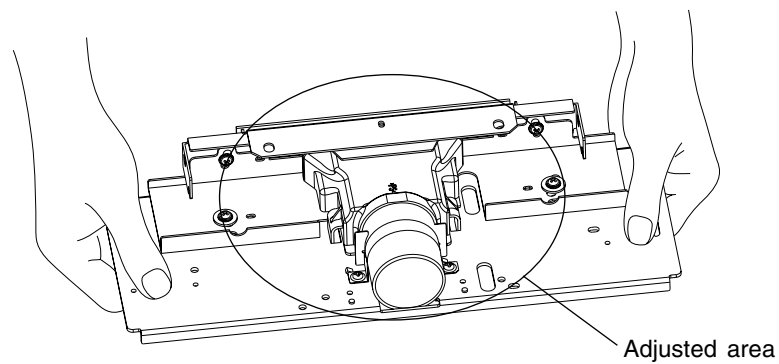

(b) Installing the lens unit

Use the positioning pins to install the lens unit. By that the installing position of the lens unit is fixed, and therefore there is no need to adjust the magnification ratio of the lens.

<Procedure>

1. Insert the positioning pins (front and rear) into the holes of the lens unit (as A in the illustration below), and install the unit to the base of the scanner unit (note that the shapes of the front positioning pins are different from that of the rear ones).
2. Fix the 2 long holes (as B in the illustration below) with the screws.

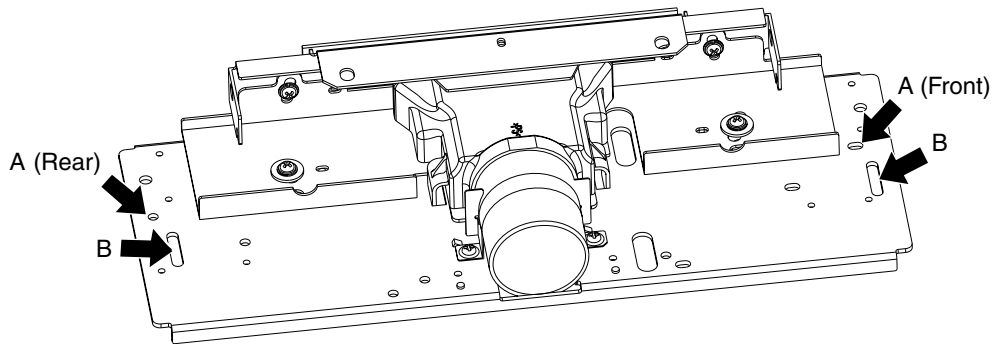

## 2.10 Adjustment of the Paper Feeding System

### 2.10.1 Cassette sidewise deviation

- (1) Loosen 5 screws for fixing the cassette front cover, and the sidewise deviation can be adjusted toward the front or the rear by a maximum of 3 mm.
- (2) If the image is shifted toward the rear of paper, adjust the cassette front cover toward the front by the amount of the shift, and fasten the screws.
- (3) If the image is shifted toward the front of paper, adjust the cassette front cover toward the rear by the amount of the shift, and fasten the screws.

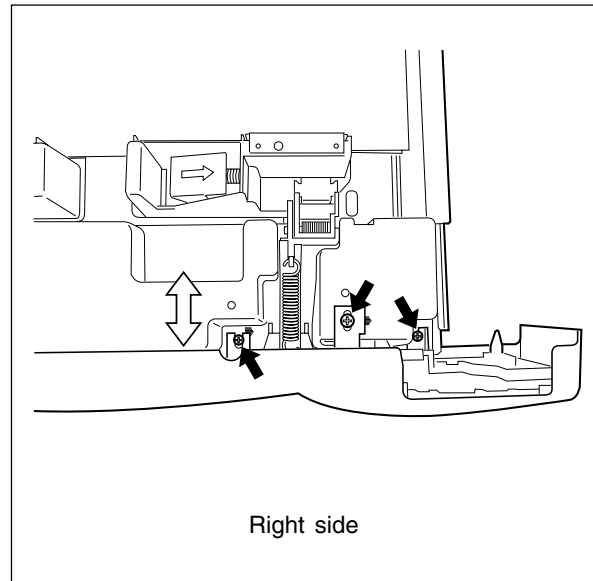
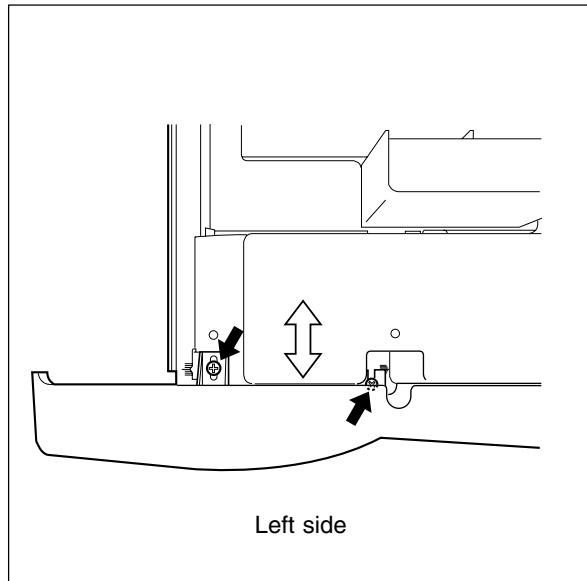

## 2.11 Key Copy Counter (MU-8, MU-10)

To make a key copy counter available, the following 2 components must be installed to the copier.

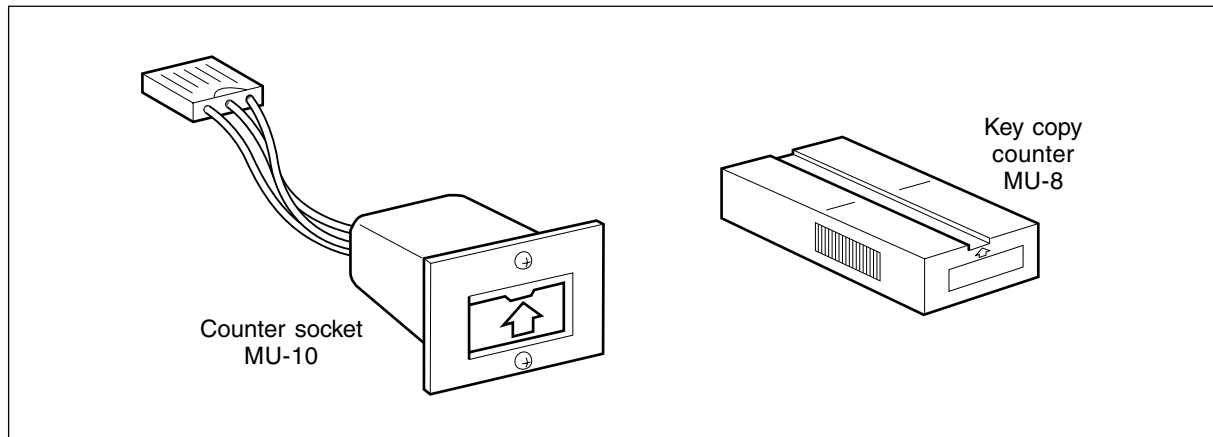

### <Installation procedure>

- (1) Remove the rear cover.
- (2) Remove the feed side upper cover, and cut open the window for the key copy counter.
- (3) Pull out the harness connector from the hole of the machine frame, and cut the short harness of the connector. (Treat the cut harness properly to avoid it causing a short-circuit with the machine frame.) Then, disconnect the dummy connector.

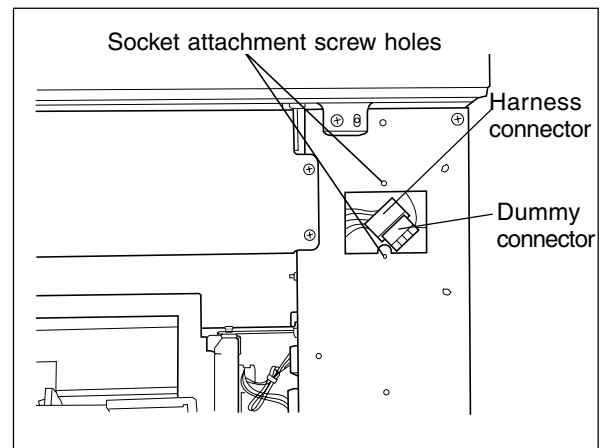

- (4) Connect the connector of the counter socket to the harness connector of the copier side.
- (5) Install the counter socket to the machine frame with two M3 screws.
- (6) Reinstall the feed side upper cover and the rear cover.

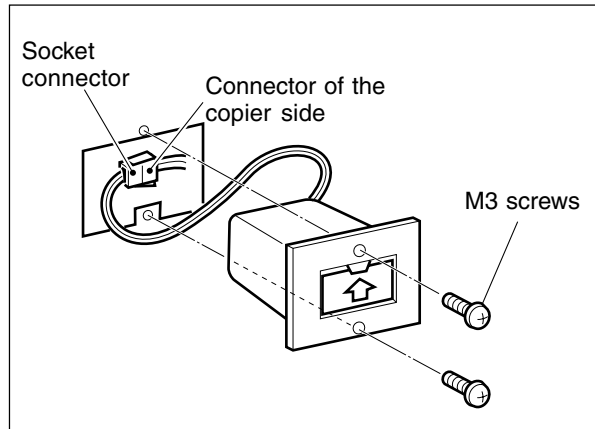

- (7) Insert the key copy counter with its arrow mark facing up and pointing toward the copier.

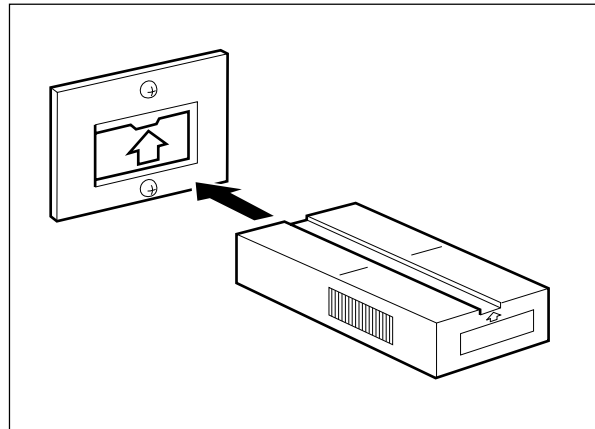

- (8) Enter the value "3" in the setting mode (08-202).

### 3. PREVENTIVE MAINTENANCE (PM)

#### 3.1 Types of Preventive Maintenance

The following two types of preventive maintenance should be performed:

**Note:** Values of the sheets correspond to the FC-210/FC-310.

(1) General maintenance (General PM)

General maintenance should be performed based on the value of the general PM counter (08-857). This maintenance, which covers the black developer unit as well as the entire machine, should be conducted in conjunction with the replacement cycle (every 40/60K sheets) of the black developer material.

(2) Color maintenance (Color PM)

Color maintenance should be performed based on the value of the color PM counter (08-897). This maintenance, which is performed with a focus on the color developer units, should be conducted in conjunction with the replacement cycle (every 40/60K sheets) of the color developer materials. The cycle (counter value) of color maintenance is determined by the ratio of color printouts to black printouts, as shown by the following table, "Variation in PM cycles due to color/black printout ratios".

Variation in PM cycles due to color/black printout ratios

Color	Black	General PM (sheets)	Color PM (sheets)
100%	0%	40.0 / 60.0K	40.0 / 60.0K
90%	10%	40.0 / 60.0K	44.4 / 66.7K
80%	20%	40.0 / 60.0K	50.0 / 75.0K
70%	30%	40.0 / 60.0K	57.1 / 85.7K
60%	40%	40.0 / 60.0K	66.7 / 100.0K
50%	50%	40.0 / 60.0K	80.0 / 120.0K

\* Therefore, parts replacing, cleaning and lubrication for the paper feeding system, scanner section, transfer/transport unit, fuser unit, etc. should all be performed in conjunction with the replacement cycle of the black developer material.

e.g.) Replacing the lower heat roller : At the 1st cycle of replacing black developer material  
(40/60K copies)

Replacing the transfer belt : At the 3rd cycle (FC-210) / 2nd cycle (FC-310) of replacing black developer material  
(120/120K copies)

\* For the details of maintenance items, refer to the checklist described later.

\* Yields are based on factory defaults.



### 3.2 Outline of the Maintenance Order

- (1) Preparation
  - a. Discuss current machine conditions with the key operator and note them down.
  - b. Before starting maintenance, make a few sample copies by TCC-1 chart and keep them for later reference purposes.
  - c. Turn OFF the power switch, and be sure to unplug the copier.
- (2) Perform preventive maintenance following the checklist shown below. During maintenance, refer to the illustrations attached and the Service Manual as required.
- (3) After having finished the maintenance, plug in the copier, turn ON the power switch, and make a few copies to confirm that the copier is working normally.

### 3.3 Preventive Maintenance Checklist

Symbols used in the checklist

Cleaning		Lubrication		Replacement	Operation check	Date
A	Cleaning with alcohol	W	White grease	Values indicate the replacement cycle. (Value x 1000 sheets)	○ After cleaning or replacing, check for no abnormality.	User's name
○	Cleaning with soft pad, cloth or vacuum cleaner		(Molykoat)			Serial No.
		AV	Alvania No.2	△ Replace if deformed or damaged		Inspector's name
						Remarks

- Notes:**
1. Values under "Cleaning" and "Replacement" indicate the cleaning and replacement cycles for the FC-210/310.
  2. Lubricate every 40,000 sheets for FC-210 and 60,000 sheets for FC-310. Lubricate to the replacement parts according to the replacement cycle.
  3. Do not stain any oil on the rollers, belts and belt pulleys.
  4. The replacement cycle of the parts in the feeding section depends on the number of sheets fed from each paper source.
  5. <P-I> under "Remarks" indicates page and item number in the Parts List.

## General Maintenance Checklist

Section	Item to inspect	Cleaning (X 1000)	Lubri- cation	Replace- ment (X 1000)	Opera- tion check	Remarks <P-I>	Reference counter
Processing unit (EPU)  (Only Black related parts)	1. Developer material			40/60		*8	Developer K counter (08-847)
	2. Doctor blade	○ (40/60)		△		*1	
	3. Developer unit drum seal	○ (40/60)		△		*9	
	4. Front/rear sides of developer unit	○ (40/60)				*2	
	5. Oil seal portion		AV				
	6. Drum cleaning blade			40/60		*3 <P23-113>	Drum K life counter (08-843)  <b>Note:</b> Clear "Drum K drive cou- nter(08-870)" when drum has been replaced.
	7. Recovery blade	○ (40/60)		△		*4	
	8. Felt seals on both ends of the cleaning blade	○ (40/60)		△			
	9. Entire developer/cleaner unit	○ (40/60)				*7	
	10. Main charger case	○ (40/60)				*6	
	11. Discharge LED	○ (40/60)					
	12. Wire cleaning pad			40/60	○	<P22-116>	
	13. Main charger wire			40/60		*6 <P22-115>	
	14. Main charger grid			40/60		<P22-124>	
	15. Main charger contact	○ (40/60)					
	16. Drum			40/60		▶ ch.3.6.2 <P22-138>	
	17. Drum shaft	○ (40/60)					
	18. Drum thermistor	○ (40/60)					
	19. Toner recovery auger drive	○ (40/60)	W				
Around EPU area	20. Toner cartridge drive gear		W				
	21. Ozone filter			40/60		*5 <P6-137>	
	22. Toner bag			40/60		Key-operator's item <P33-133>	
Fuser unit	23. Fuser belt			40/60		▶ ch.3.6.6 <P28-124>	Fuser unit counter (08-854)
	24. Upper heat roller	A (40/60)		△			
	25. Fuser roller			40/60		▶ ch.3.6.5 <P28-117>	
	26. Lower heat roller			40/60		▶ ch.3.6.6 <P27-114>	
	27. Belt guide			40/60		<P28-116>	
	28. Separation guide	A (40/60)		△			
	29. Separation fingers			40/60		*10 <P28-128>	
30. Oil roller			40/60		▶ ch.3.6.7 <P28-144>		

Section	Item to inspect	Cleaning (X 1000)	Lubri- cation	Replace- ment (X 1000)	Opera- tion check	Remarks <P-l>	Reference counter
Fuser unit	31. Cleaning roller			40/60		▶ ch.3.6.7 <P28-145>	Fuser unit counter (08-854)
	32. Upper thermistors	A (40/60)		△			
	33. Lower thermistors	A (40/60)		△			
	34. Fuser inlet guide	A (40/60)					
	35. Fuser exit guide	A (40/60)					
	36. Paper exit roller	A					
Image quality control	37. Image quality sensor's area	○ (40/60)				*11	Drum K life counter (08-843)
Color registration	38. Color registration sensor	○ (40/60)					
Laser unit	39. Slit glass	○ (40/60)					
Paper feeding system	40. Pick-up roller	A (40/60)		90		<P14-113>	—
	41. Feed roller	A (40/60)		△			
	42. Separation roller	A (40/60)		△			
	43. Bypass pick-up roller	A (40/60)		90		<P17-152>	
	44. Bypass feed roller	A (40/60)		△			
	45. Bypass separation roller	A (40/60)		△			
	46. Registration roller	A (40/60)		△			
	47. Paper guide	○ (40/60)		△			
	48. Paper dust removal brush	○ (40/60)		△			
	49. Drive gears (tooth face)			W			
50. Registration unit support bushings			W				
Scanner	51. Original glass	○ or A (40/60)					—
	52. Platen cover	○ or A (40/60)					
	53. Mirror-1	○ (40/60)					
	54. Mirror-2	○ (40/60)					
	55. Mirror-3	○ (40/60)					
	56. Reflector	○ (40/60)					
	57. Lens	○ (40/60)					
	58. Exposure lamp			△	○		
	59. Original-width indicator				○		
	60. Automatic original detection unit				○		
	61. Slide sheet			△			
	62. Air filter	○ (40/60)		△			
Transfer/ transport unit (TBU)	63. Transfer belt			120/120		<P30-12>	Transfer belt unit counter (08-853)
	64. Transfer roller (Y, M, C, K)			120/120		<P30-122>	
	65. Drive roller cleaning felt			120/120		<P30-127>	
	66. Transfer belt cleaning blade			120/120		<P30-146>	
	67. Transfer belt recovery blade	○(120/120)		△			
	68. Transfer belt drive roller	○(120/120)		△			
	69. Transfer belt driven roller	○(120/120)		△			

## Color Maintenance Checklist

Section	Item to inspect	Cleaning (X 1000)	Lubri- cation	Replac- ment (X 1000)	Opera- tion check	Remarks <P-l>	Reference counter
Processing unit (EPU) (Color(Y,M,C) related parts)	1. Developer material (Y,M,C)			40/60		*8	Developer Y, M,C counter (08-844,845, 846)
	2. Doctor blade	○ (40/60)		△		*1	
	3. Developer unit drum seal	○ (40/60)		△		*9	
	4. Front/rear sides of developer unit	○ (40/60)				*2	
	5. Oil seal portion		AV				
	6. Drum cleaning blade			40/60		*3 <P23-113>	Drum Y,M,C life counter (08-840,841, 842)  <b>Note:</b> Clear "Drum Y,M,C drive counter (08- 867,868, 869)" when drums have been re- placed.
	7. Recovery blade	○ (40/60)		△		*4	
	8. Felt seals on both ends of the cleaning blade	○ (40/60)		△			
	9. Entire developer/cleaner unit	○ (40/60)				*7	
	10. Main charger case	○ (40/60)				*6	
	11. Discharge lamp	○ (40/60)					
	12. Wire cleaning pad			40/60	○	<P22-116>	
	13. Main charger wire			40/60		*6 <P22-115>	
	14. Main charger grid			40/60		<P22-124>	
	15. Main charger contact	○ (40/60)					
	16. Drum			40/60		▶ ch.3.6.2 <P22-138>	
	17. Drum shaft	○ (40/60)					
	18. Drum thermistor (Y)	○ (40/60)					
	19. Toner recovery auger drive	○ (40/60)		W			
Image quality control	37. Image quality sensor's area	○ (40/60)				*11	
Color registration	38. Color registration sensor	○ (40/60)					
Laser unit	39. Slit glass	○ (40/60)					

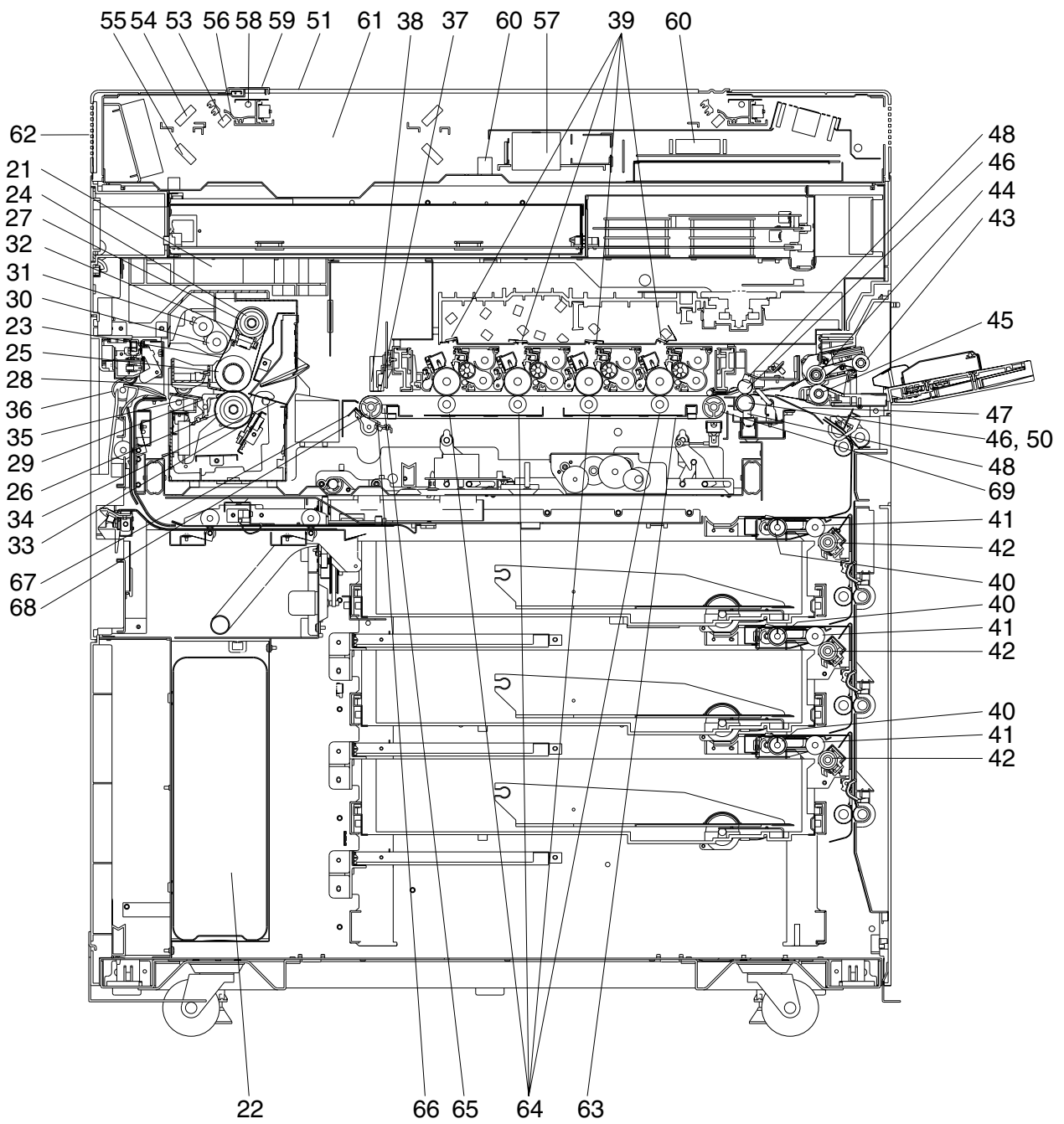

[Front sectional view]

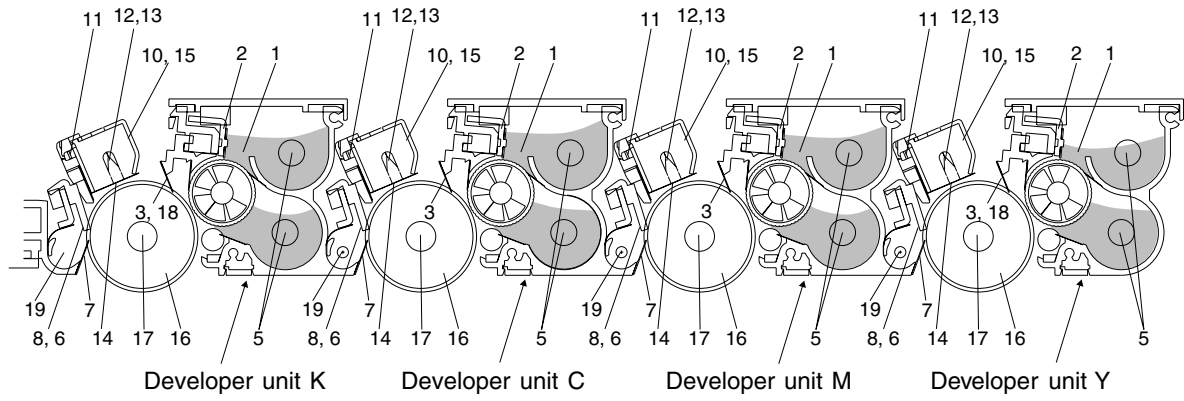

[Processing unit (EPU)]

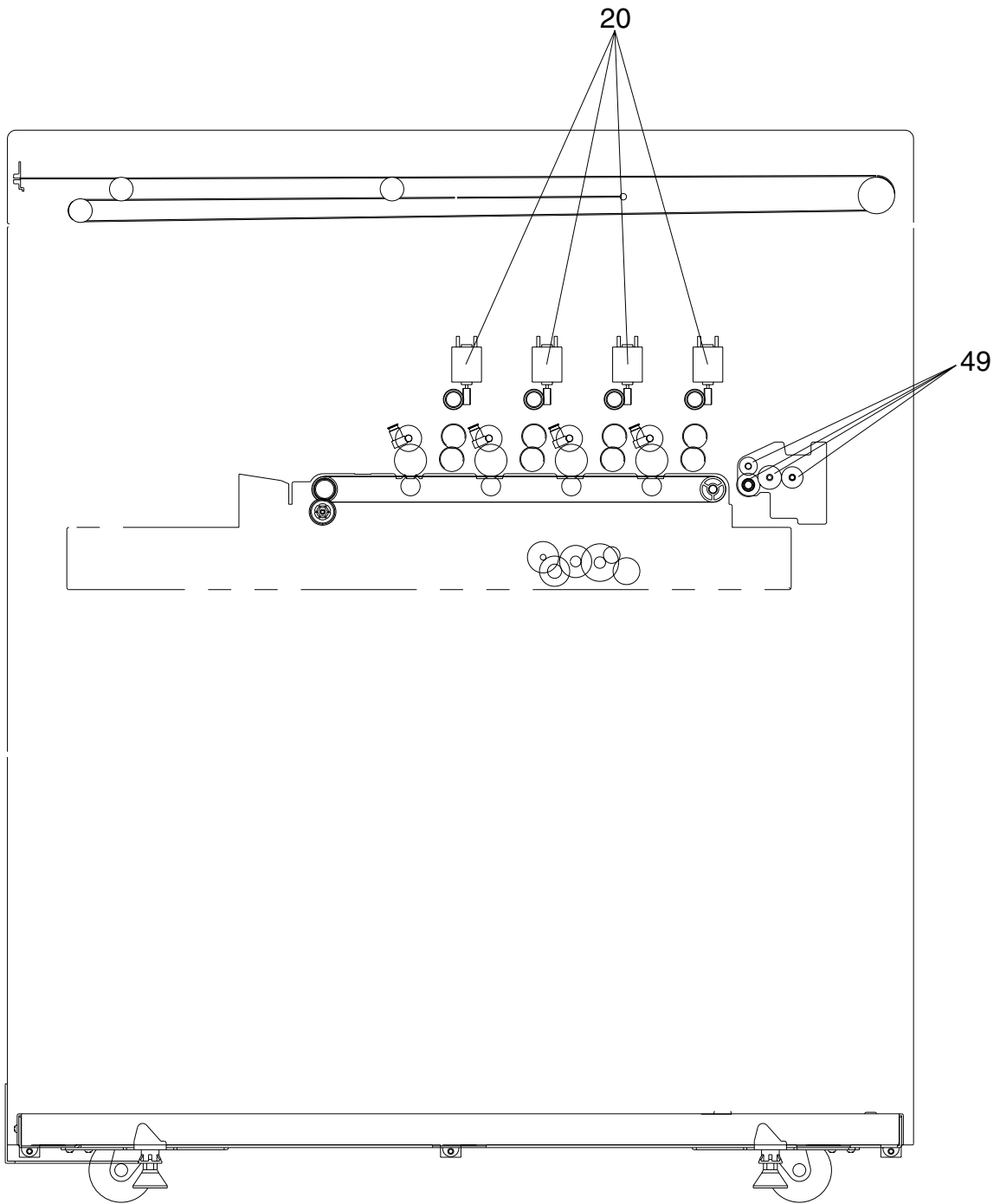

[Front side drive system]

## \* Notes on the Preventive Maintenance Checklist

### \* 1. Doctor blade cleaning

**Note:** This cleaning should be done subsequent to “Automatic removing of developer material”.

- (1) Move the developer removal shutter lever in the direction of the arrow shown to close the developer removal opening.
- (2) Remove the developer unit from the EPU.

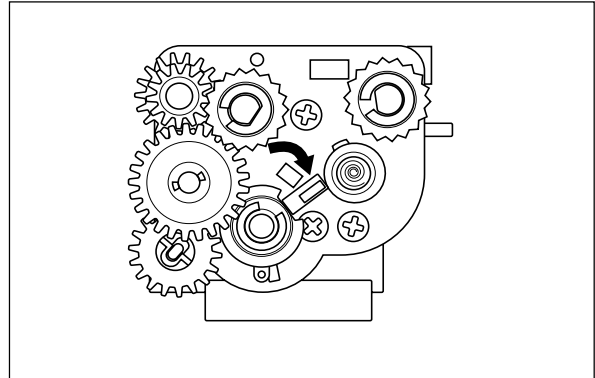

- (3) Remove the developer unit cover. Insert the doctor blade cleaning jig between the doctor blade and the sleeve and move the jig back and forth along the edge 3 times to clean the doctor blade.
- (4) After the cleaning, return the developer removal shutter lever to open the developer removal opening (move the lever in a direction reverse to (1)).

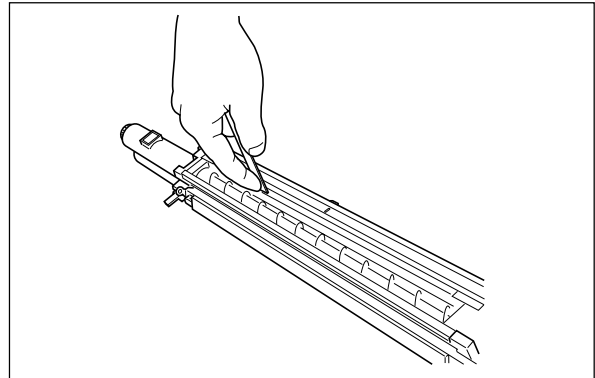

- (5) Making the developer removal opening point downward, remove the developer material remaining in the developer unit. (Shake the developer unit to the right and left, and rotate the mixer and the sleeve alternately.)

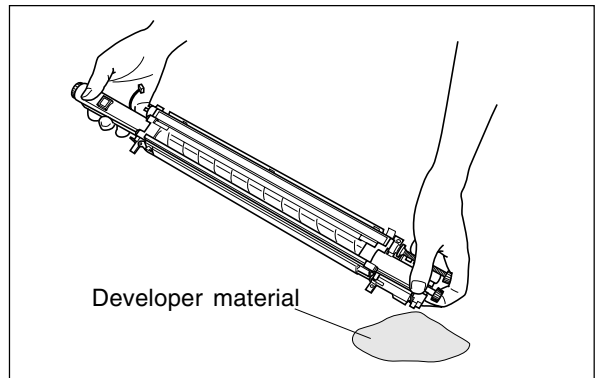



\*2 Front/rear sides of developer unit

Clean off any toner accumulating on the developer sleeve ends indicated with arrows and in the area beneath the scattered toner recovery roller.

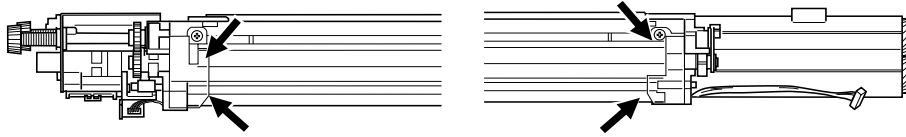

\*3 Cleaning blade

If poor cleaning has occurred due to such causes as adhesion of paper dust, etc. prior to the specified number of printouts for replacement, replace the cleaning blade as required because the blade edge may have been damaged.

\*4 Recovery blade

If the blade edge has been marred, replace the blade regardless of the number of printouts that have been made so far.

\*5 Ozone filter

If the ozone filter is heavily dirty, replace it.

\*6 Main charger case and charger wire

To clean the inside of the main charger case and the charger wire, use a cloth which should be soaked in water and then wrung lightly.

\*7 Developer unit and cleaner unit

Check if the outside surfaces including the bottom surfaces are dirty, and clean if necessary.

\*8 Developer material

When the developer material is replaced, be sure to perform "automatic adjustment of the auto-toner sensor" (adjustment mode 05-200, 204, 221).

\*9 Drum seal

Use a cloth which should be soaked in water and then wrung strongly to clean the front seal.

\*10 Separation fingers

Replace the finger if its tip is damaged, regardless of the specified number of printouts for replacement. If toner is fused tightly on the tip, the tip may be damaged if you try to scrape the toner off forcefully. So, replace it that is heavily dirty with toner.

\*11 Image quality sensor's area

Clean the shutter of the image quality sensor and around it. Don't touch the sensor head inside the shutter.

### 3.4 PM Kit

Kit name	Breakdown of kits	Part name	Q'ty	No. of printouts for replacement cycle
DEV-KIT-FC31 (40/60K kit)	1. Developer material Y	PS-ZDFC31Y	1	40/60K
	1. Developer material M	PS-ZDFC31M	1	
	1. Developer material C	PS-ZDFC31C	1	
	1. Developer material K	PS-ZDFC31K	1	
	– Doctor blade cleaning jig	JIG-CLEAN-DOC	1	
EPU-KIT-FC31 (40/60K kit)	6. Drum cleaning blade	BL-FC22D	4	40/60K
	12. Charger wire cleaning pad	K-WIRE-CLN-ARM	4	
	13. Main charger wire	WIRE-CH-310	4	
	14. Main charger grid	GRID-CH-314	4	
	21. Ozone filter	K-FILTER-OZN	1	
FU-KIT-FC31 (40/60K kit)	23. Fuser belt	BT-FC31FU	1	40/60K
	25. Fuser roller	FR-FC31FU	1	
	26. Lower heat roller	HR-FC31-L	1	
	27. Belt guide	STOP-FU-BELT-HR	2	
	28. Separation finger	SCRAPER-PRS-213	6	
	29. Oil roller	SR-FC31U	1	
	30. Cleaning roller	B-FC31U	1	
TBU-KIT-FC31 (120/120K kit)	62. Transfer belt	BT-FC22TR	1	120/120K
	63. Transfer roller	CR-FC31TR	4	
	64. Drive roller cleaning felt	FP-FC22TR	1	
	65. Transfer belt cleaning blade	BL-FC22TR	1	

\* The numbers in the “Breakdown of kits” column above correspond with the numbers in the Preventive Maintenance Checklist.

### 3.5 List of Adjustment Tools

Name	Parts List	
	Page	Item
Door switch keep-ON jig	100	1
Wire holder jig	100	2
Doctor - sleeve gap adjustment jig	100	3
Cleaning brush	100	6
Doctor blade cleaning jig	100	7
Test chart (No. TCC-1)	100	9
Scanner carriage jig (front)	100	10A
Scanner carriage jig (rear)	100	10B
Lens unit positioning pin (front)	100	15
Lens unit positioning pin (rear)	100	16
Fuser belt replacing jig	100	17
Downloading jig (DLM board)	100	18
Downloading jig (DLS board)	100	19

## **3.6 Precautions for Storing/Handling Supplies and Parts**

### **3.6.1 Precautions for storing TOSHIBA supplies**

#### A. Toner and developer

Toner and developer should be stored in a shaded place where the ambient temperature is between 10 to 35°C (no condensation), and should also be protected against direct sunlight during transportation.

#### B. Photoconductive drum

Like toner and developer, Photoconductive drums should be stored in a dark place where the ambient temperature is between 10 to 35°C (no condensation). Be sure to avoid places where drums may be subjected to high humidity, chemicals and/or chemical gas.

#### C. Drum cleaning blade, transfer belt cleaning blade

Blades should be stored “horizontally” on a flat surface where the ambient temperature is between 10 to 35°C, and should also be protected against high humidity, chemicals and/or chemical gas.

#### D. Transfer belt, transfer roller, fuser belt, fuser roller, lower heat roller

Avoid places where the belts and rollers may be subjected to high humidity, chemicals and/or chemical gas.

#### E. Oil roller, cleaning roller

Avoid places where the rollers may be subjected to high humidity, chemicals and/or chemical gas. They should also be stored “horizontally” on a flat surface.

#### F. Copy paper

Avoid storing copy paper in places where it may be subjected to high humidity.

After a package is opened, be sure to place and store it in a storage bag.

### **3.6.2 Checking and cleaning of the photoconductive drum**

#### (1) Use of gloves

If fingerprints or oil stain the OPC drum surface, the characteristics of the photoconductor may degrade, affecting the quality of the image. So, do not touch the drum surface with your bare hands.

#### (2) Handling precautions

As the OPC drum surface is very delicate, be sure to handle the drum carefully when installing and removing it so as not to damage its surface.

When the drum is replaced with a new one, be sure to apply “patting powder” (lubricant) to the entire surface of the new drum before installing. After installing, the drum counter corresponding to the replaced drum must be cleared to 0 (zero) by operating the setting mode (08 - 867~870).

**Notes:**

1. Application of the patting powder is for reducing the friction between the drum and the cleaning blade. If the application of patting powder is neglected, the drum and the cleaning blade may be damaged.
2. When some fibers adhere to the cleaning blade edge, they may reduce the cleaning efficiency and, in addition, may damage the blade and the drum. Be sure to remove any fibers found adhering to the blade.

**(3) Handling at installing of the copier and replacing of the drum**

At installing the copier and replacing the drum, do not leave the drum in a brightly lit place for a long time. Otherwise, the drum will be fatigued, producing some background fogging on the image after being installed in the copier. However, this effect will decrease as time elapses.

**(4) Cleaning of the drum**

At preventive maintenance, wipe softly the entire surface of the drum using the designated cleaning cotton (dry soft pad). Use sufficiently thick cleaning cotton so as not to touch the drum surface inadvertently with your fingertips or nails. Also, remove your rings and wristwatch before starting cleaning work to prevent accidental damage to the drum.

Do not use organic solvents such as alcohol or silicone oil as they will have an adverse effect on the drum. Never use selenium refresher, either.

**(5) Scratches on photoconductive drum surface**

If the surface is scratched to such a degree that the aluminum base is exposed, black spots or streaks will be produced on images and can also damage the cleaning blade. So, replace the drum with a new one.

**(6) Recovery of used photoconductive drums**

Regarding the recovery and disposal of used drums, you should follow your relevant local regulations and rules.

### **3.6.3 Checking and cleaning of the drum cleaning blade and transfer belt cleaning blade**

#### (1) Handling precautions

Since the edge of the cleaning blade performs the cleaning operation, pay special attention when handling it:

- Do not allow any hard object to hit or rub against the blade edge. Do not rub the edge with a cloth or soft pad.
- Do not stain the edge with any oil or fingerprints, etc.
- Do not allow solvents such as paint thinner to touch the blade.
- Do not leave any lint or dirt on the blade edge.
- Do not place the blade near a heat source.

#### (2) Cleaning procedure

Clean the blade edge lightly with a cloth moistened with water.

### **3.6.4 Checking and replacing the transfer belt**

#### (1) Handling precautions

- Do not touch the belt surface with your bare hands.
- Prevent oil or other foreign matter from staining the belt surface.
- Do not allow alcohol or any other organic solvent to come into contact with the transfer belt.
- Do not apply external pressure that might scratch the transfer belt.

### **3.6.5 Checking and replacing the transfer roller and fuser roller**

#### (1) Handling precautions

- Do not touch the roller surface with your bare hands.
- Be careful not to leave any scratch or dent on the roller surface.

### **3.6.6 Checking and cleaning of the fuser belt and lower heat roller**

#### (1) Handling precautions

Fuser belt

- Take great care not to let the belt surface be folded.
- Do not touch the belt surface with your bare hands.
- Prevent oil or other foreign matter from staining the belt surface.
- Do not allow alcohol or any other organic solvent to come into contact with the fuser belt.
- Do not apply external pressure that might scratch the fuser belt.

Lower heat roller

- Do not leave any oil (fingerprints, etc.) on the lower heat roller.
- Be careful not to allow any hard object to hit or rub against the lower heat roller, or it may be damaged, possibly resulting in poor cleaning.

#### (2) Checking

- Check for stain and damage on the fuser belt and lower heat roller and clean if necessary.
- Clean the separation guide and fingers and check for chipped tips.
- Check the cleaning effect of the cleaning roller.
- Check the thermistors for proper contact with the upper and lower heat rollers.
- Check the fused and fixed condition of the toner.
- Check the gap between the inlet guide and lower heat roller.
- Check the fuser belt for proper transportation.
- Check the lower heat roller for proper rotation.

#### (3) Cleaning procedure for fuser belt and lower heat roller

When fuser belt and lower heat roller become dirty, they will cause jamming. If this happens, wipe the surface clean with a suitable cloth. For easier cleaning, clean the belt and roller while they are still warm.

#### **Note:**

Be careful not to rub the fuser belt and lower heat roller surface with your nails or hard objects because it can be easily damaged. Do not use silicone oil on the fuser belt and lower heat roller.

#### (4) Checking after the assembly of the fuser belt unit

After the assembly, rotate the fuser belt for a round to confirm that the belt is neither folded nor damaged. A folded or damaged belt may be broken when it is in use.

### **3.6.7 Checking and replacing the oil roller and cleaning roller**

#### (1) Handling precautions

Never allow solvents such as paint thinner to touch to the oil/cleaning rollers.

#### (2) Poor cleaning and corrective treatment

Judgment should be made depending on how much toner has been deposited on the fuser belt surface. When its surface is stained with toner, examine the oil roller and cleaning roller. If toner is heavily adhered on the oil/cleaning rollers, it means the cleaning performance is declined and the oil/cleaning rollers should be replaced with new ones.

The oil/cleaning rollers are gradually degraded due to subjection to the heat from the fuser belt over a long period of time. Replace them after the specified number of printouts have been made.

## 4. TROUBLESHOOTING

### <CAUTION IN REPLACING PC BOARDS>

The ID for each machine is registered on the LGC board, the IMC board, the IMG board and the SYS board. So, if their replacement is required, be sure to replace only one board at a time.

If more than one of the LGC board, the IMC board, the IMG board and the SYS board require replacement, replace them in the following procedure.

1. First, replace one of the boards to be replaced.
2. Turn the power ON and confirm that "READY" is displayed.
3. Turn the power OFF.
4. Replace another board that requires replacement.
5. Repeat step 2. to 4.

### 4.1 Diagnosis and Prescription for Each Error Code

#### 4.1.1 Paper transport jam inside the copier

[E01] Paper leading edge not reaching the exit sensor

[E02] Paper trailing edge not passing the exit sensor

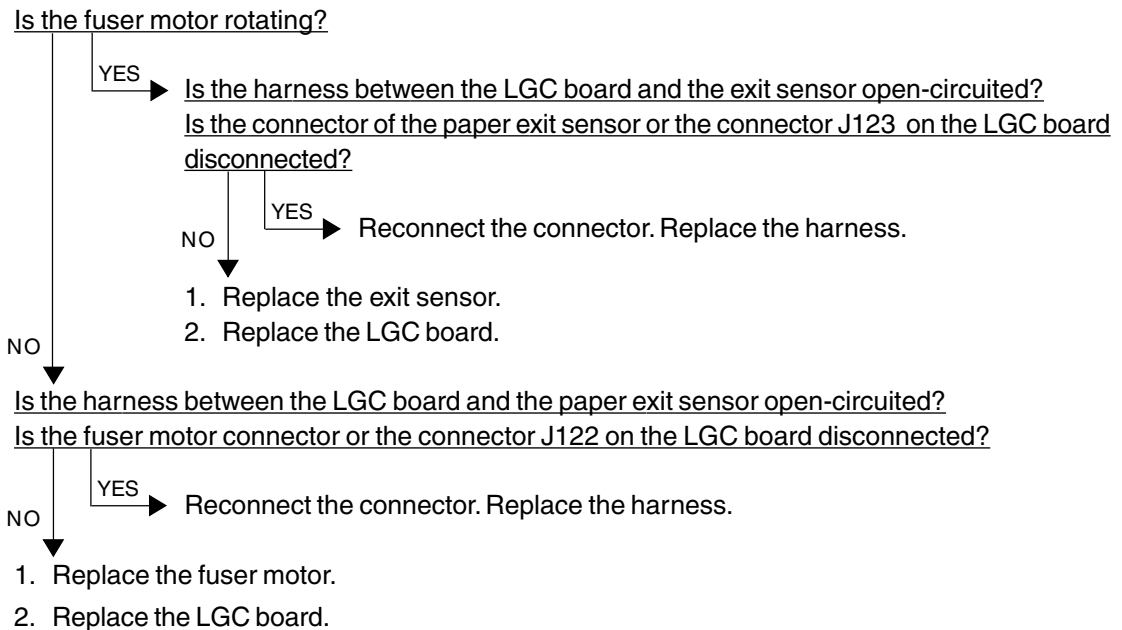



Where was the paper stopped?

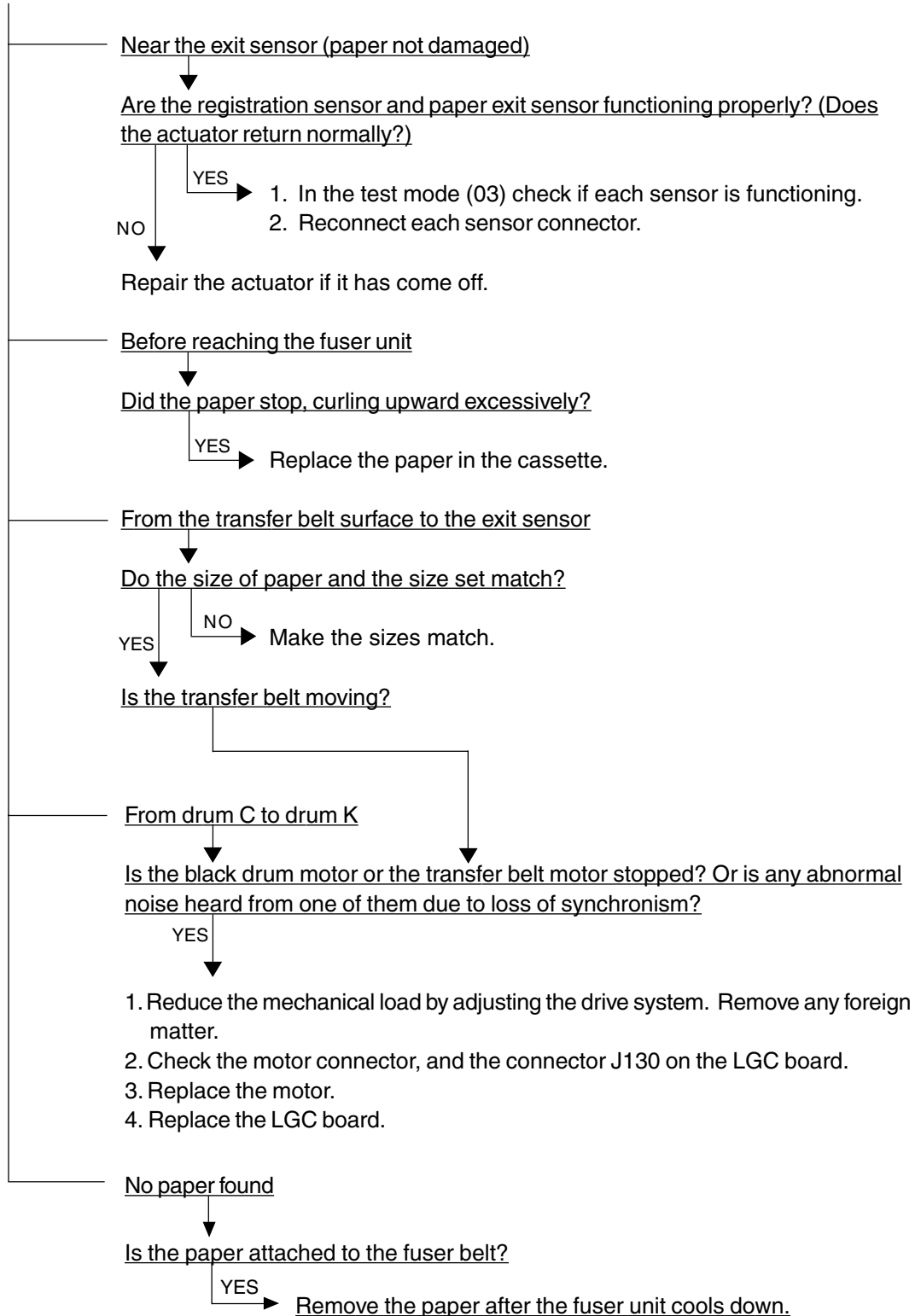

### [E03] Paper remaining inside the copier at power ON

Is any paper remaining inside the copier?



Refer to [E01], [E02] and [E11] to [E26].

### [EB7] Restart time-out error

Turn the power OFF and back ON.

In case that this error occurs frequently, confirm the contents of the following items in the setting mode and report them.

08-900 Firmware version (Basic section ROM)

08-902 Engine ROM version (LGC)

08-903 Printer ROM version (IMC)

Condition at error occurred (original size, paper size, copy mode, etc.)

## 4.1.2 Paper feeding jam

### [E11] Paper misfeed from the ADU

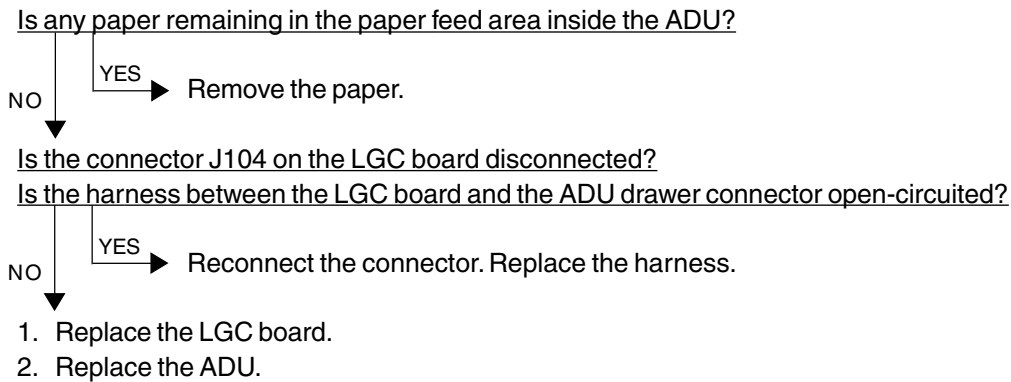

### [E12] Paper misfeed from the bypass

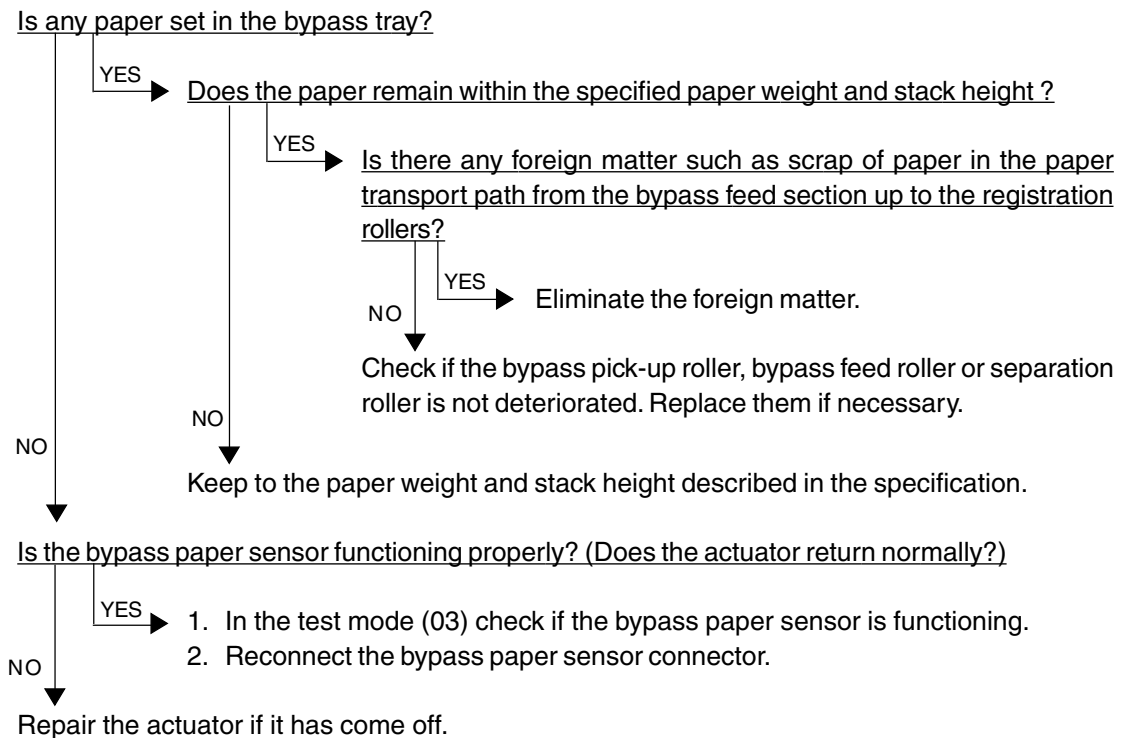

- [E13] Paper misfeed from the 1st cassette**
- [E14] Paper misfeed from the 2nd cassette**
- [E15] Paper misfeed from the 3rd cassette**
- [E16] Paper misfeed from the 4th cassette**

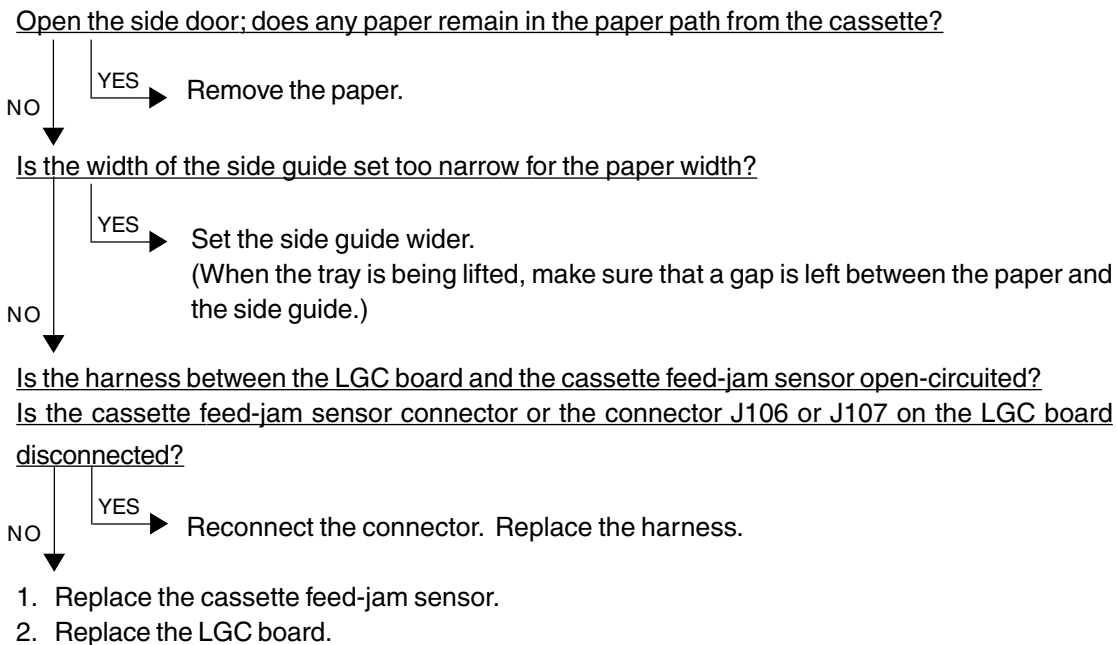

**[E19] Paper misfeed from the LCF**

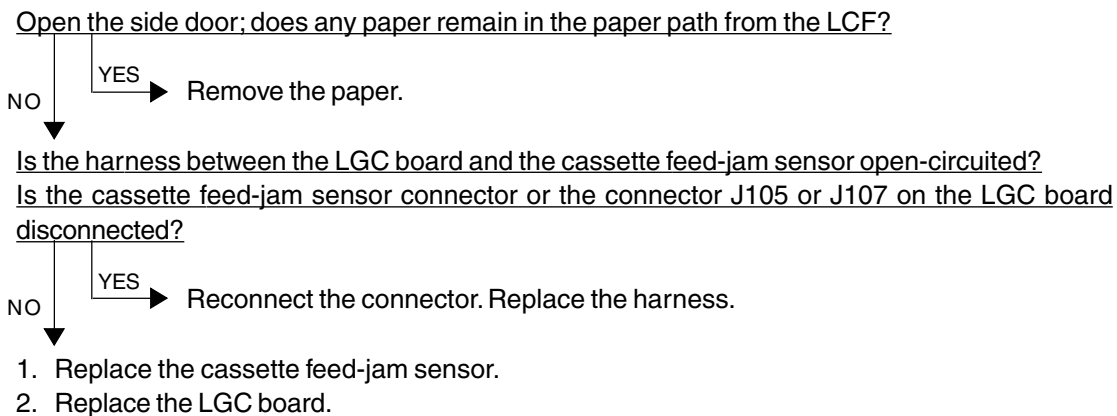

### 4.1.3 Paper transport jam (Paper not reaching the registration sensor after feeding)

- [E21] Paper transport jam from the LCF
- [E22] Paper transport jam from the 1st cassette
- [E23] Paper transport jam from the 2nd cassette
- [E24] Paper transport jam from the 3rd cassette
- [E25] Paper transport jam from the 4th cassette
- [E26] Paper transport jam from the bypass feed unit

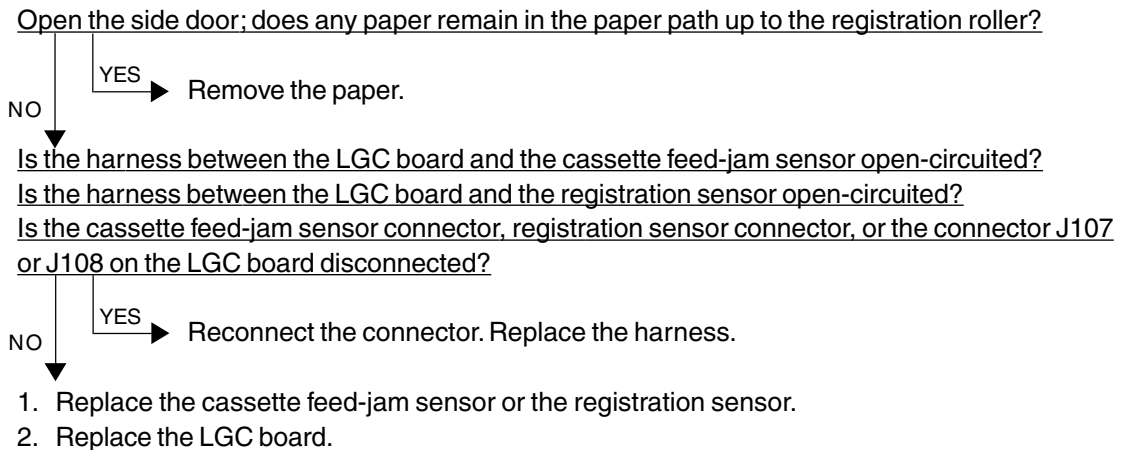

#### 4.1.4 Cover open jam

##### [E41] Front cover opened during printing

\* To avoid electrical hazards, the following checks must be made after unplugging the power cord.

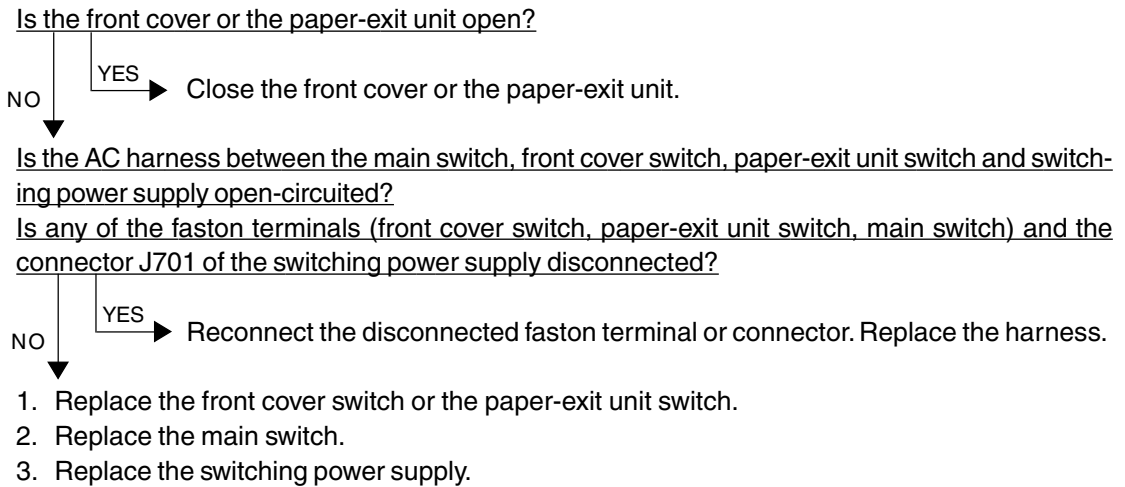

##### [E42] Side door opened during printing

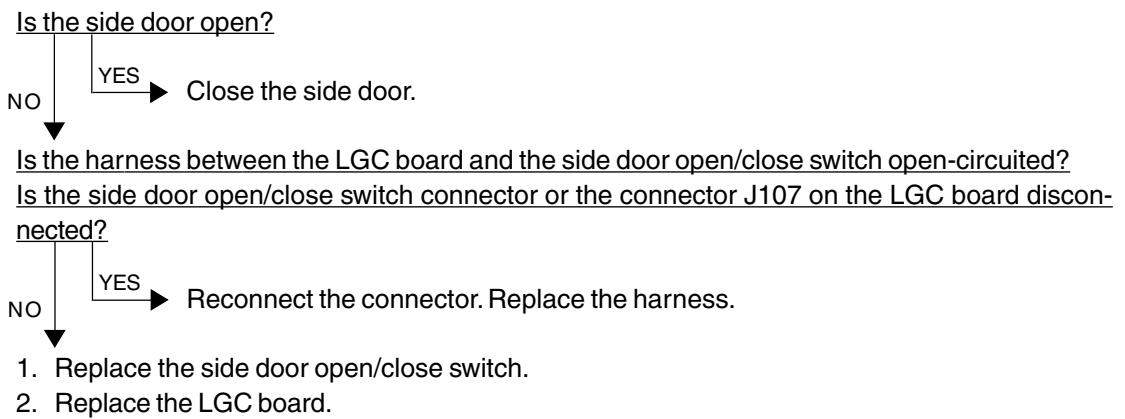

### [E43] ADU pulled out during printing

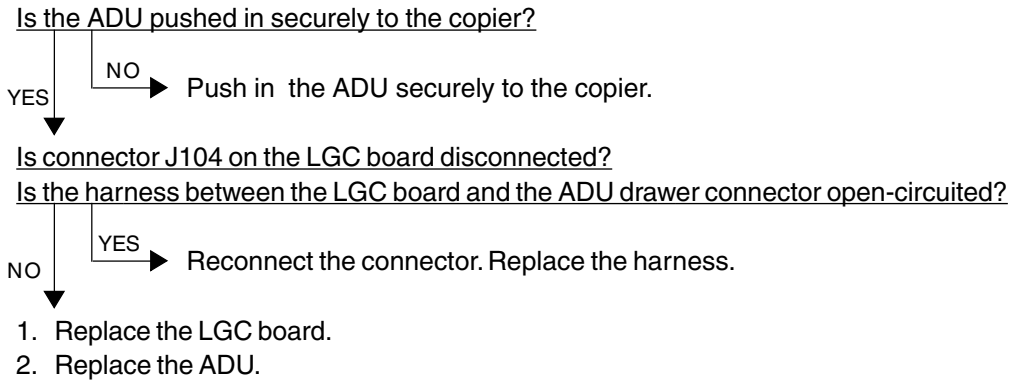

### [E45] LCF jam access cover opened during printing

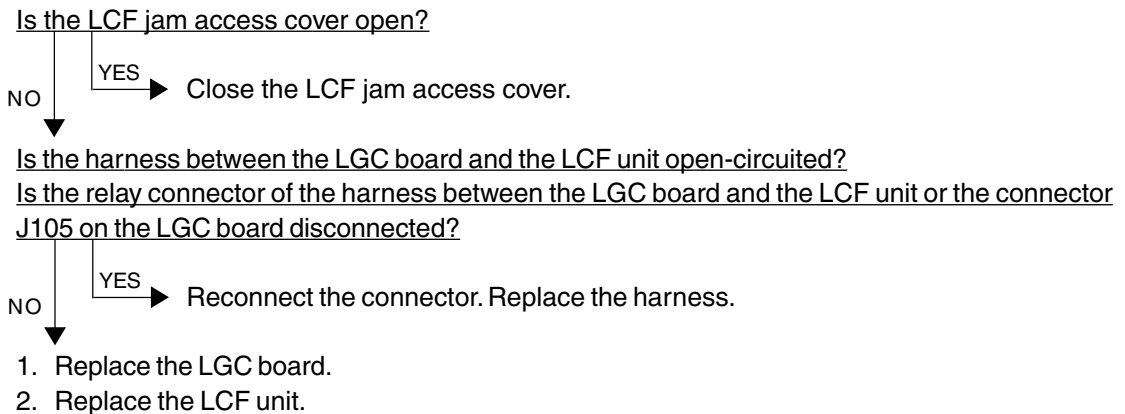

### [E46] Bypass unit opened during printing

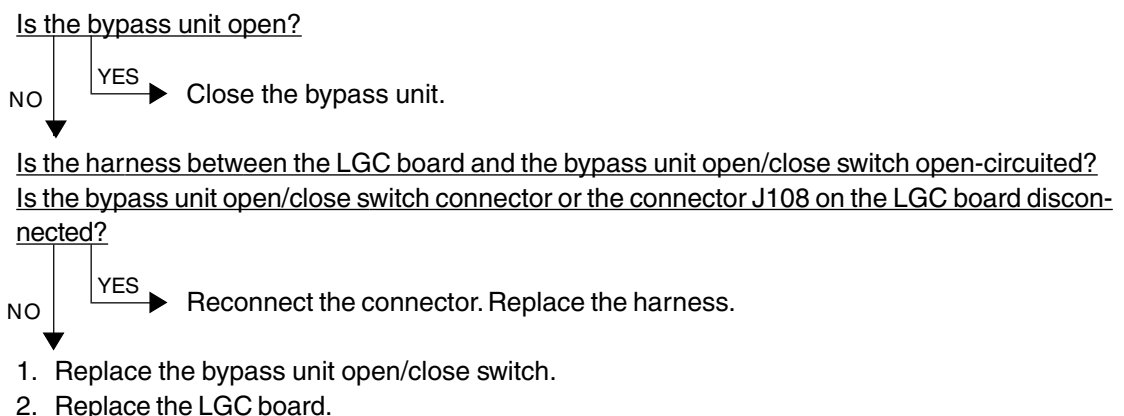

#### 4.1.5 Paper jam in ADU and reversing area

**[E50] Paper not reaching the ADU**

**[E51] Paper not restarting from the ADU stack**

**[E54] ADU paper transport jam**

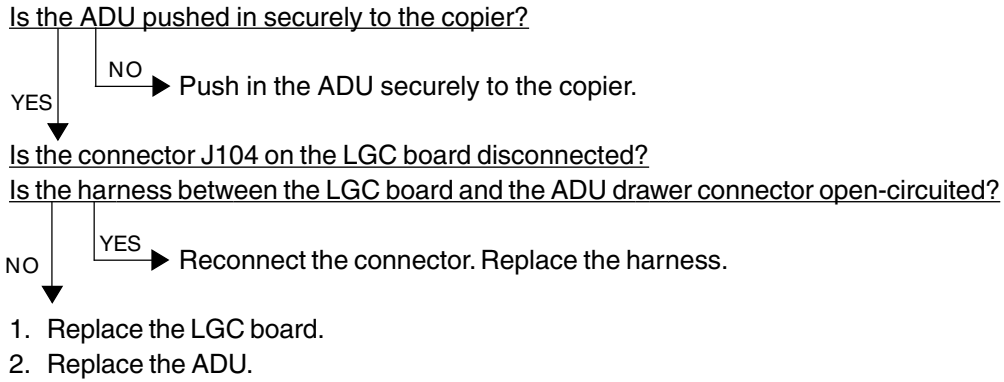

**[E52] Paper not reaching the ADU path sensor**

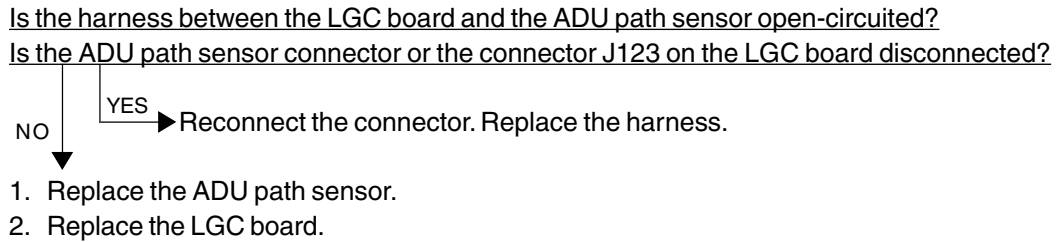



#### 4.1.6 Original jam in the RADF

[E71] Original not reaching the aligning sensor

[E72] Original not reaching the exit sensor

[E73] Original not passing the exit sensor

[Two or more originals are fed simultaneously.]

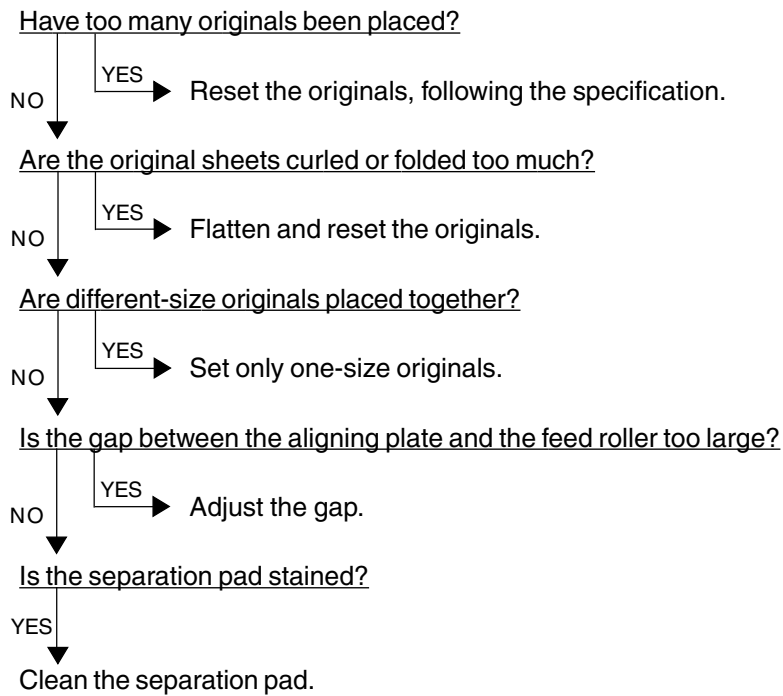

**[The original does not reach the aligning roller.]**

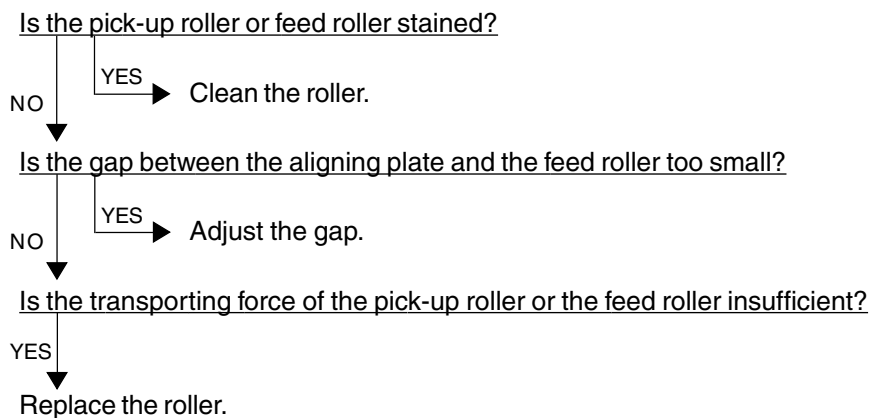

**[The original stops, skewed on the original glass.]**

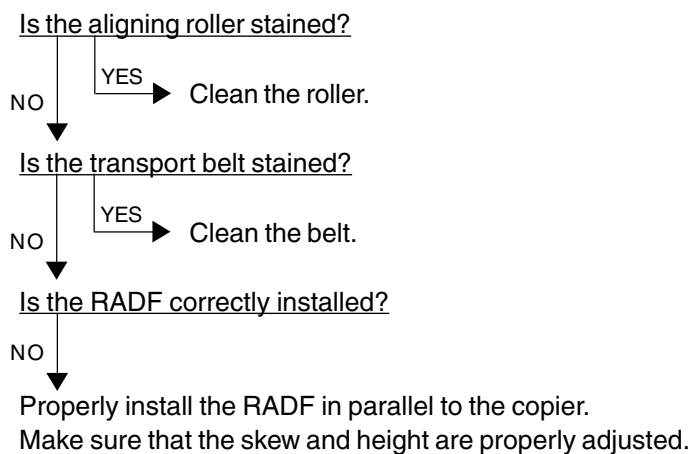

**[The side edges of the original are out of alignment with the side edges of the copy.]**

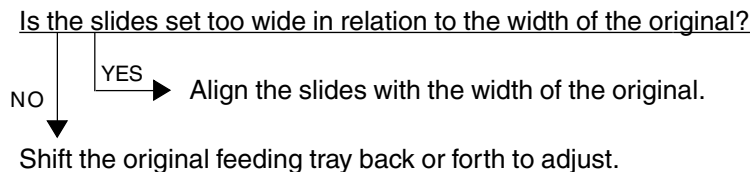

## 4.1.7 Paper jam in the finisher

### [E9F] Punching jam

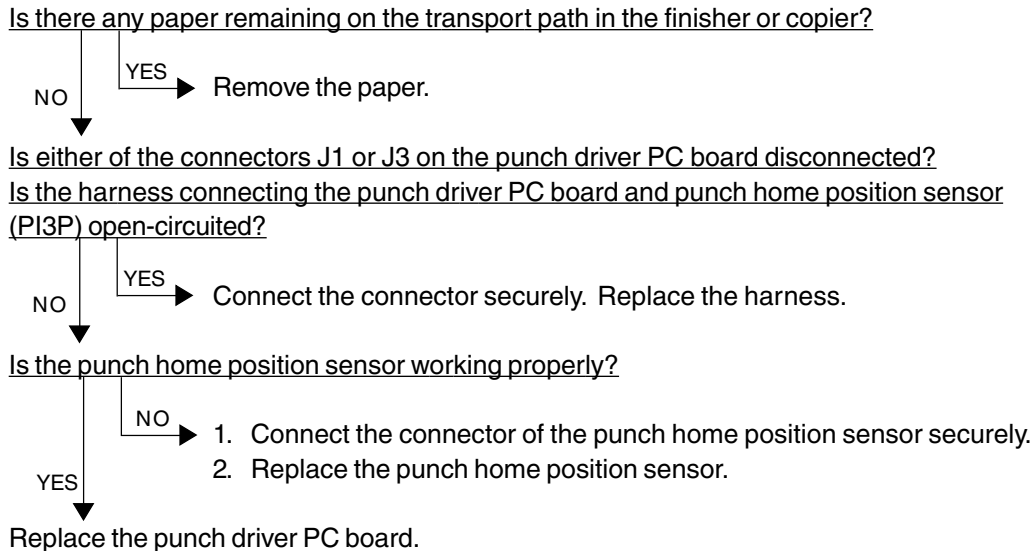

### [EA1] Finisher paper transport delay jam

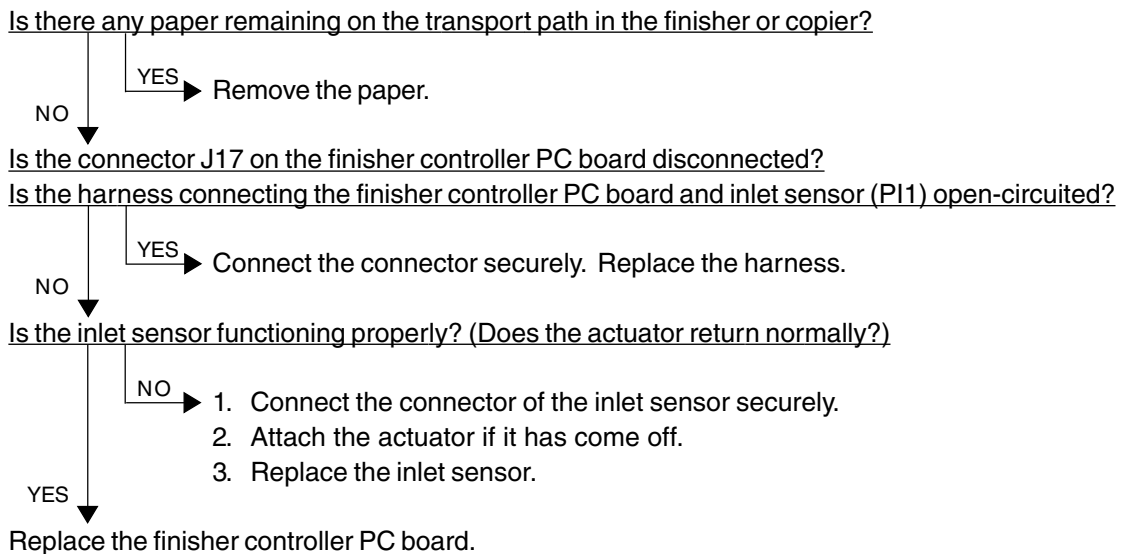

## [EA2] Finisher paper transport stop jam

Is there any paper remaining on the transport path in the finisher or copier?

NO  
YES → Remove the paper.

Is any of the connectors J17, J24, J9 and J11 on the finisher controller PC board disconnected?

Is any of the harnesses connecting between the finisher controller PC board and sensors (inlet sensor (PI1), buffer path inlet paper sensor (PI17), buffer path paper sensor (PI14), stapling tray sensor (PI4) and delivery sensor (PI3)) open-circuited?

NO  
YES → Connect the connector securely. Replace the harness.

Are the inlet sensor, buffer path inlet paper sensor, buffer path paper sensor, stapling tray sensor and delivery sensor functioning properly? (Do the actuators return normally?)

NO →  
1. Connect the connectors of the sensors securely.  
2. Attach the actuators if they have come off.  
3. Replace the sensors.

YES  
Replace the finisher controller PC board.

## [EA3] Paper remaining inside the finisher at power ON

Is there any paper remaining on the transport path in the finisher?

NO  
YES → Remove the paper.

Is any of the connectors J17, J24 and J11 on the finisher controller PC board disconnected?

Is any of the harnesses connecting between the finisher controller PC board and sensors (inlet sensor (PI1), buffer path inlet paper sensor (PI17), buffer path paper sensor (PI14) and delivery sensor (PI3)) open-circuited?

NO  
YES → Connect the connector securely. Replace the harness.

Are the inlet sensor, buffer path inlet paper sensor, buffer path paper sensor and delivery sensor functioning properly? (Do the actuators return normally?)

NO →  
1. Connect the connectors of the sensors securely.  
2. Attach the actuators if they have come off.  
3. Replace the sensors.

YES  
Replace the finisher controller PC board.

## [EA4] Finisher front door opened during printing

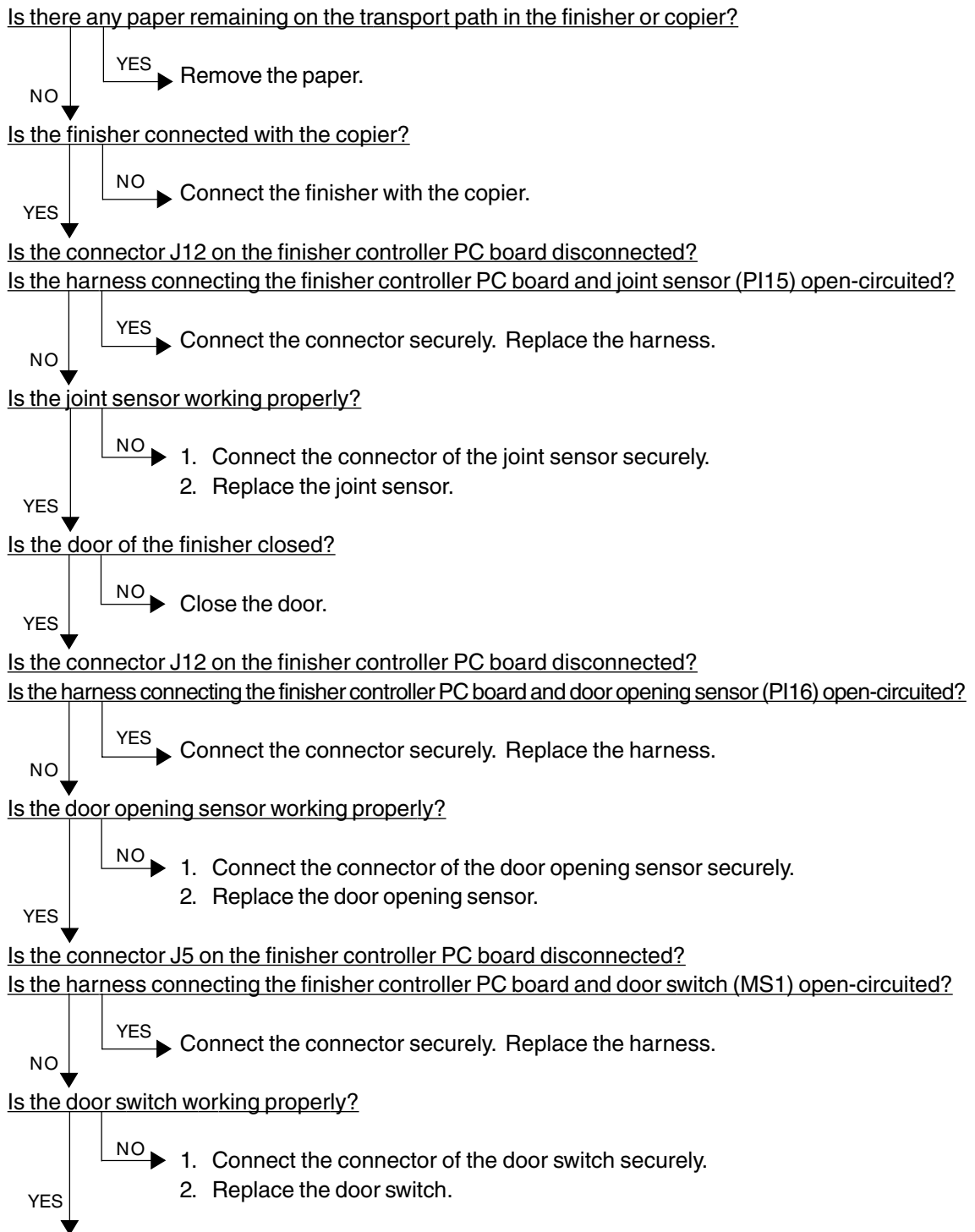

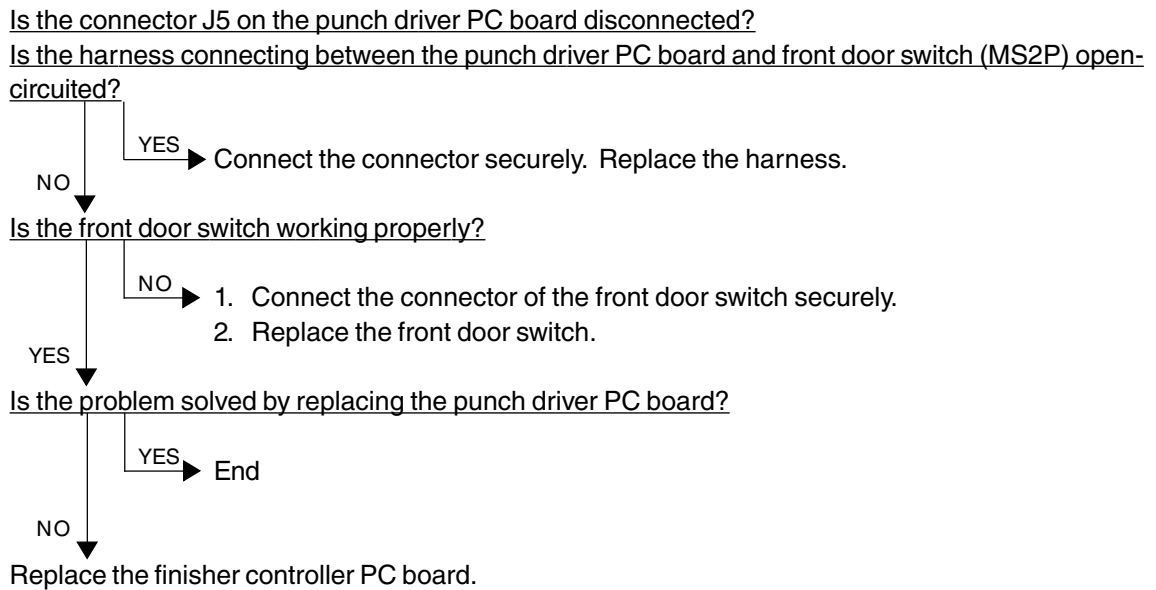

**[EA5] Finisher stapling jam**

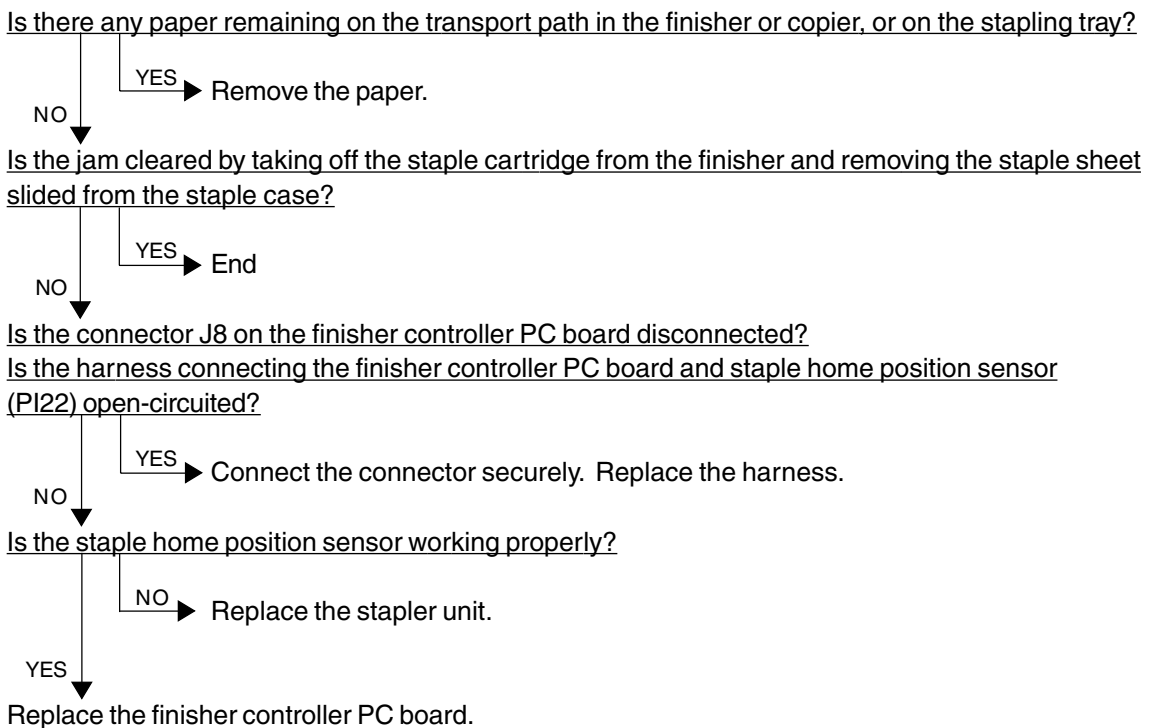

### [EA6] Finisher early arrival jam

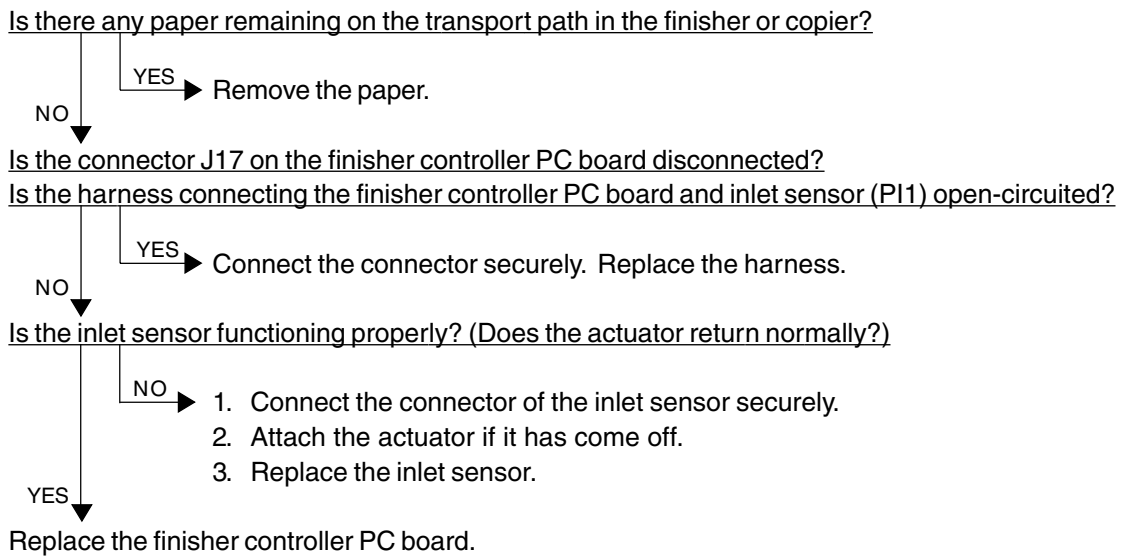

### [EA8] Saddle stitcher stapling jam

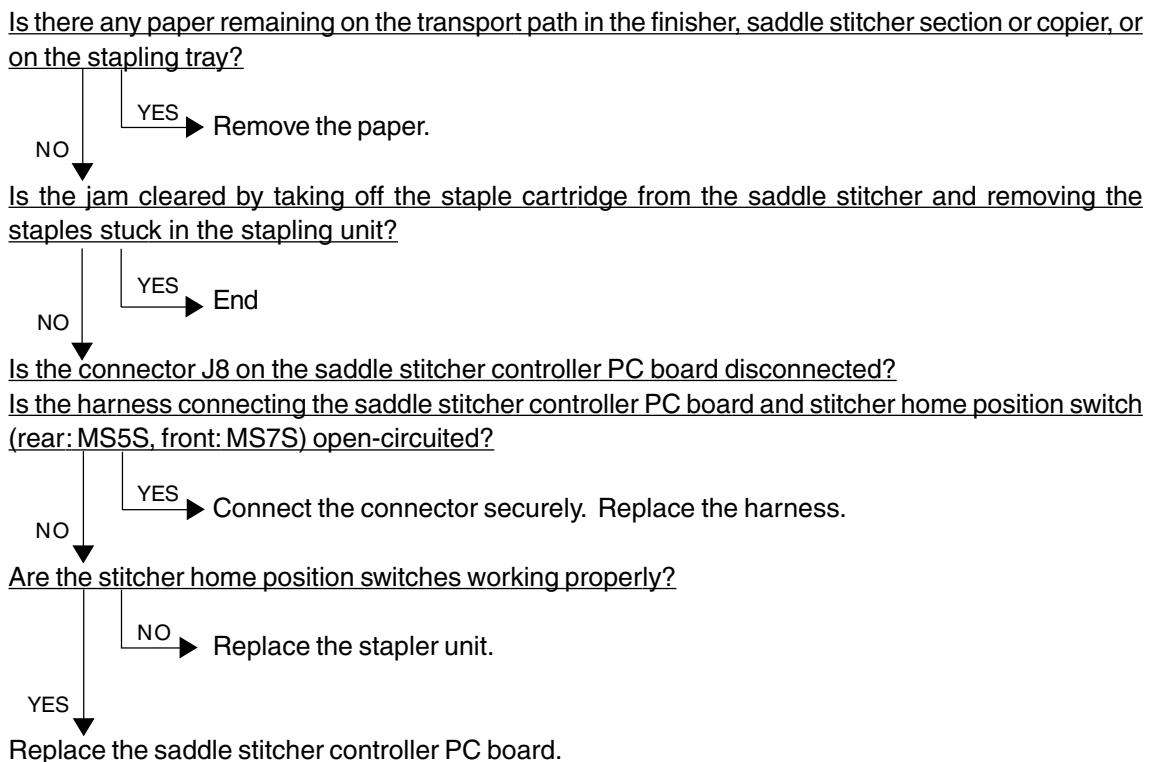

### [EA9] Saddle stitcher door opened during printing

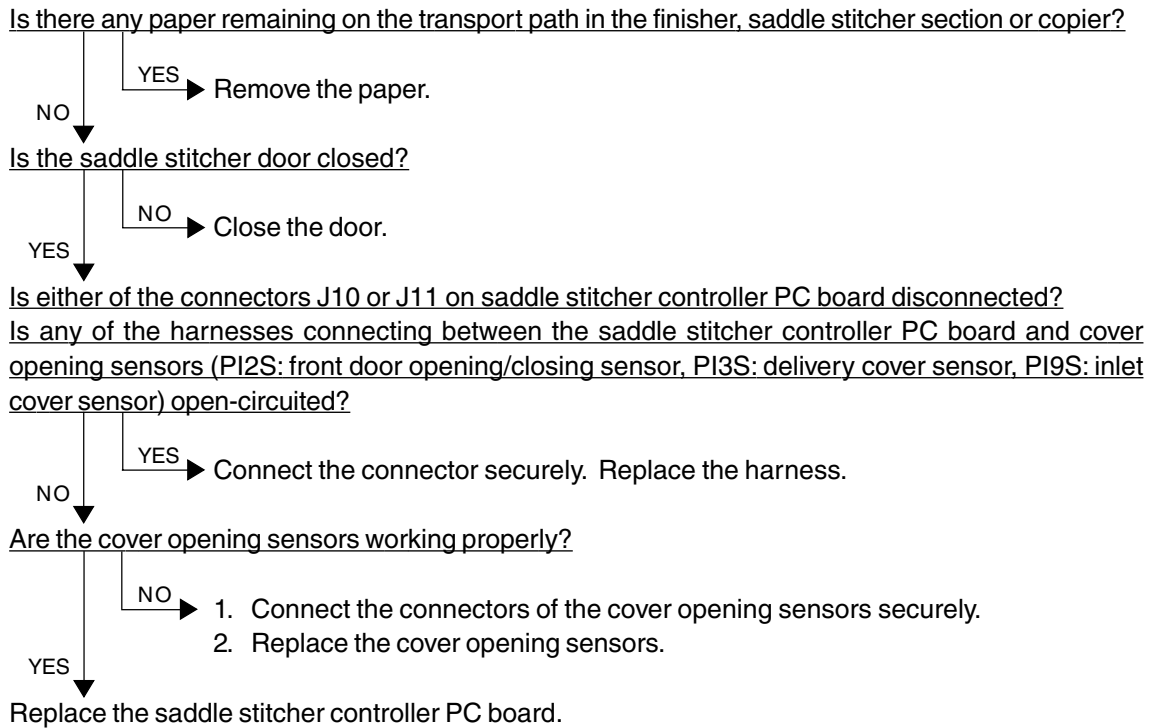

### [EAA] Paper remaining at the saddle stitcher at power ON

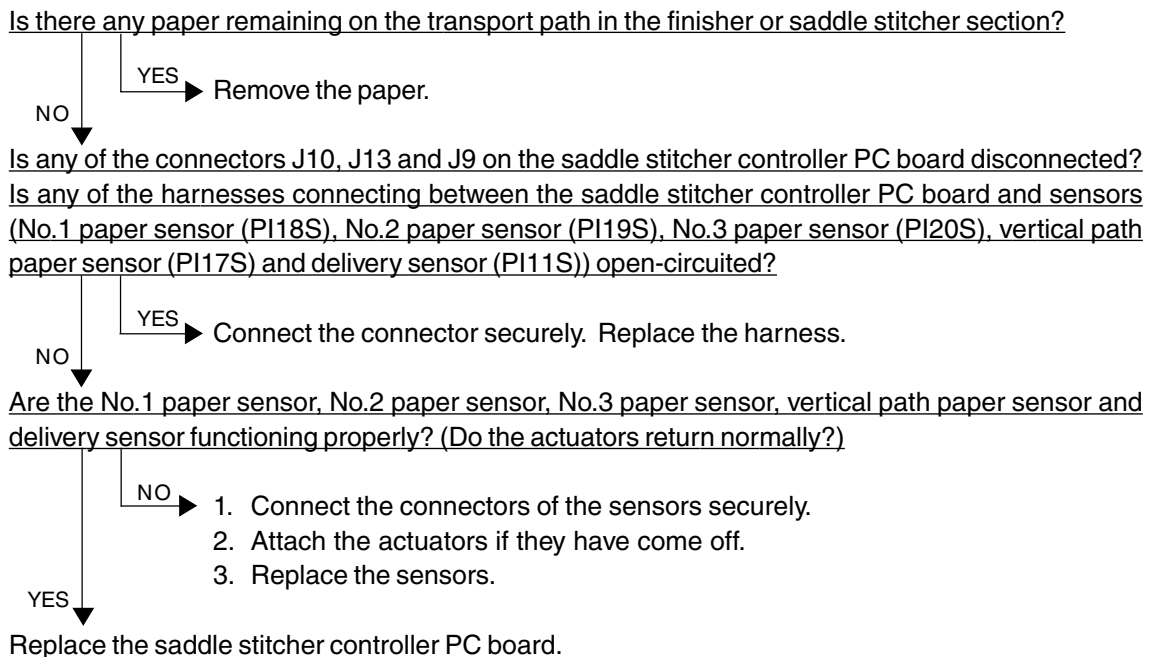



### [EAB] Saddle stitcher transport stop jam

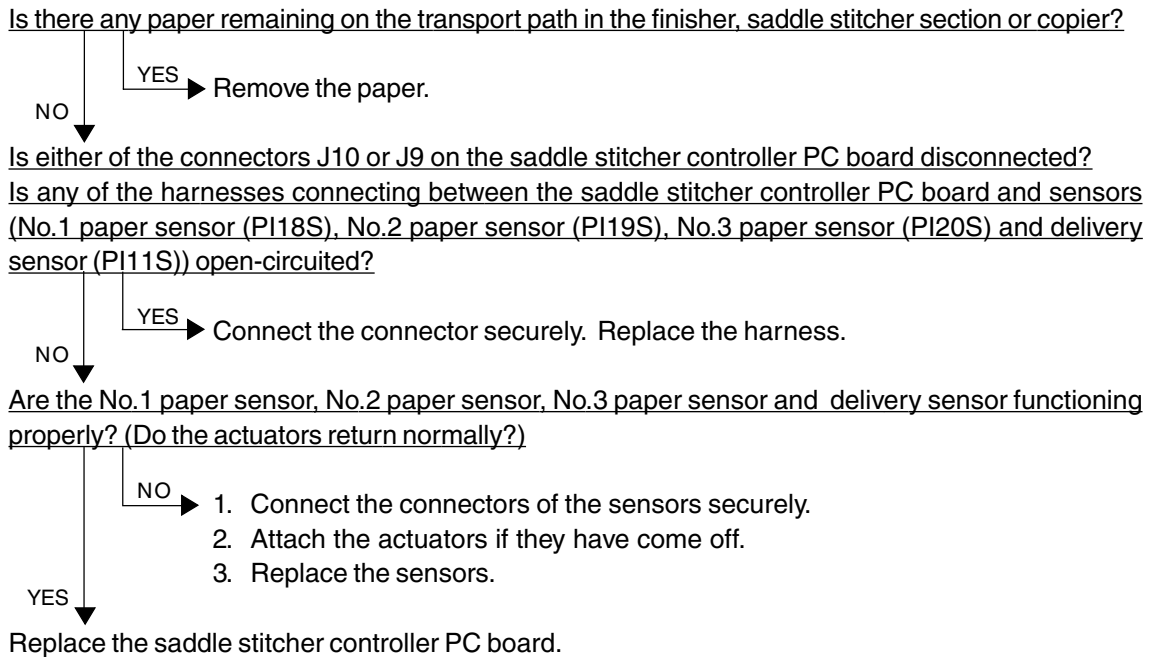

### [EAC] Saddle stitcher transport delay jam

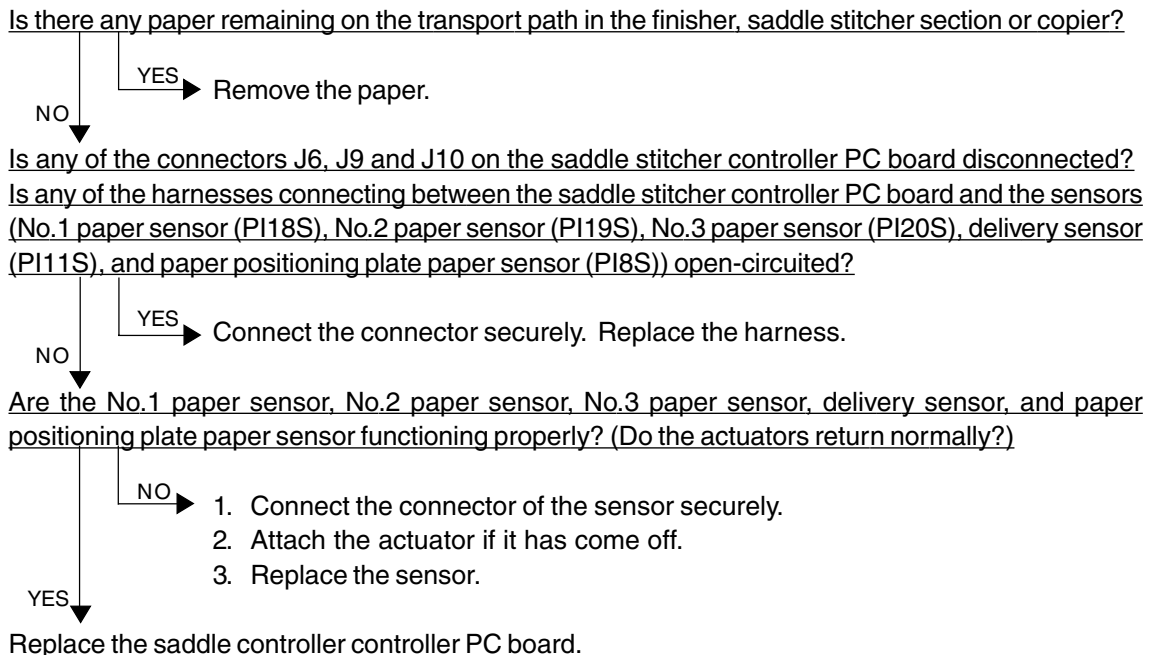

**[EAE] Finisher receiving time time-out jam**

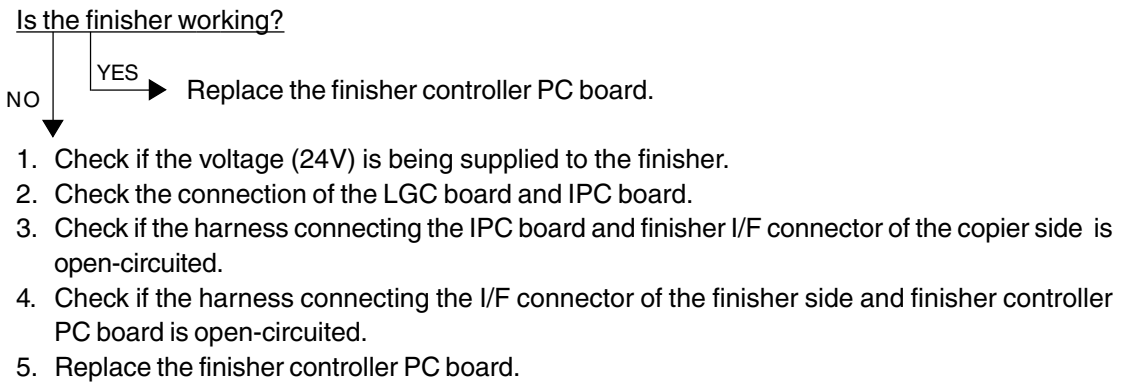

#### **4.1.8 Special sheet jam**

##### **[EC2] OHP film used except from bypass tray and 2nd cassette**

Use the 2nd cassette or the bypass tray as the feeding source of OHP film.

##### **[EC3] OHP film used in non-OHP mode**

Set the specified type of paper as selected on the control panel in the paper source.

## 4.1.9 Drive system related service call

### [C05] ADU motor rotation abnormal

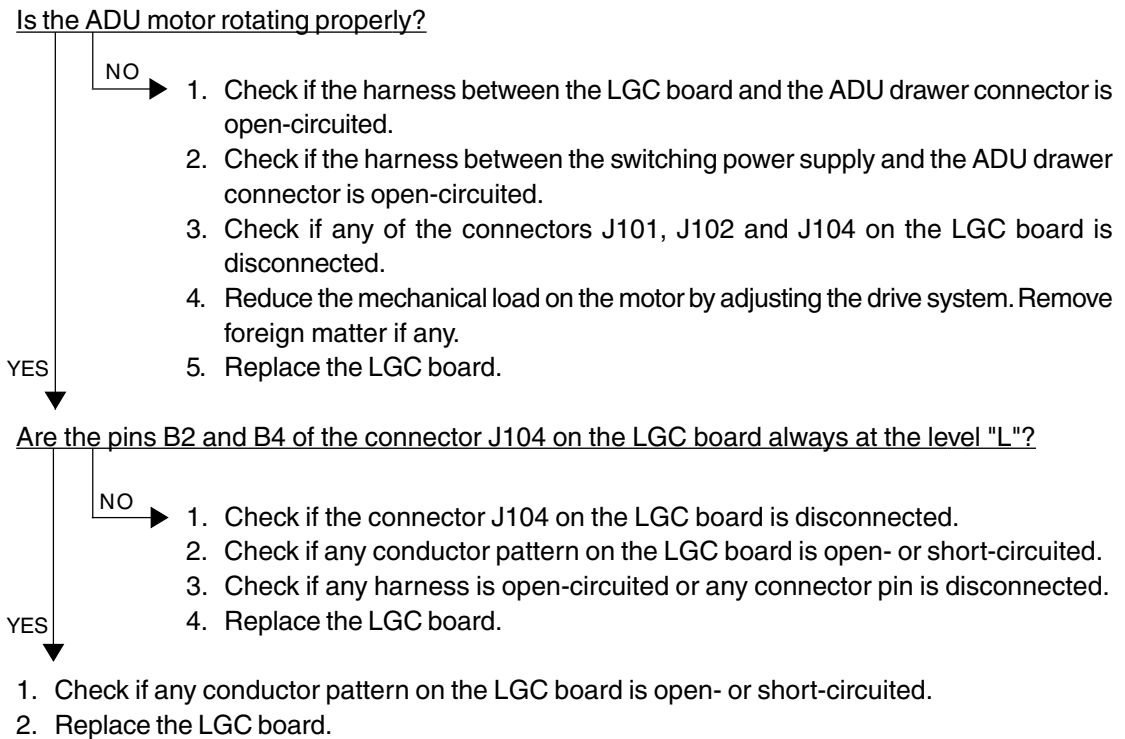

### [C06] Paper feed motor rotation abnormal

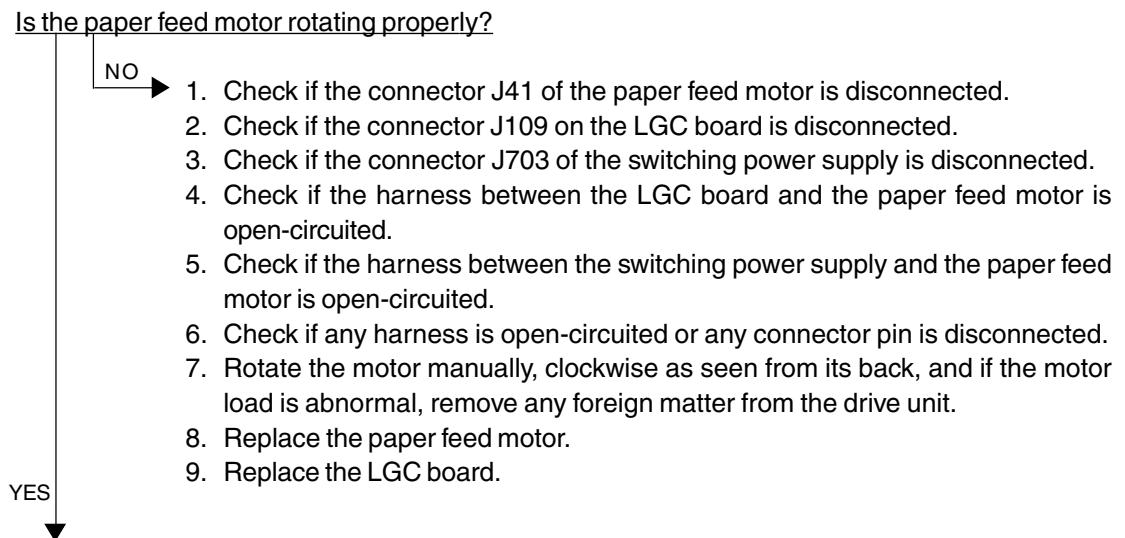

Are the pins A6 and A10 of the connector J109 on the LGC board always at the level "L"?

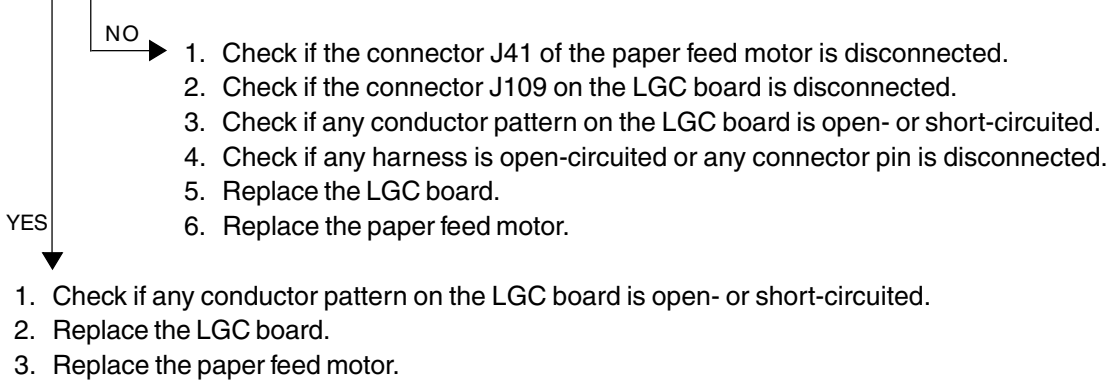

### [C0A] Developer motor rotation abnormal

Is the developer motor rotating properly?

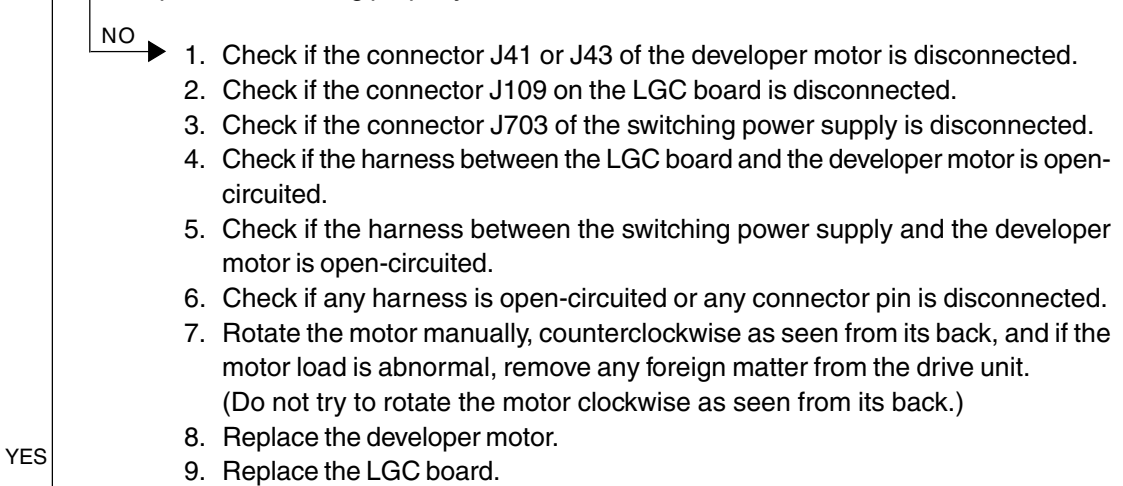

Are the pins B12 and B16 of the connector J109 on the LGC board always at the level "L"?

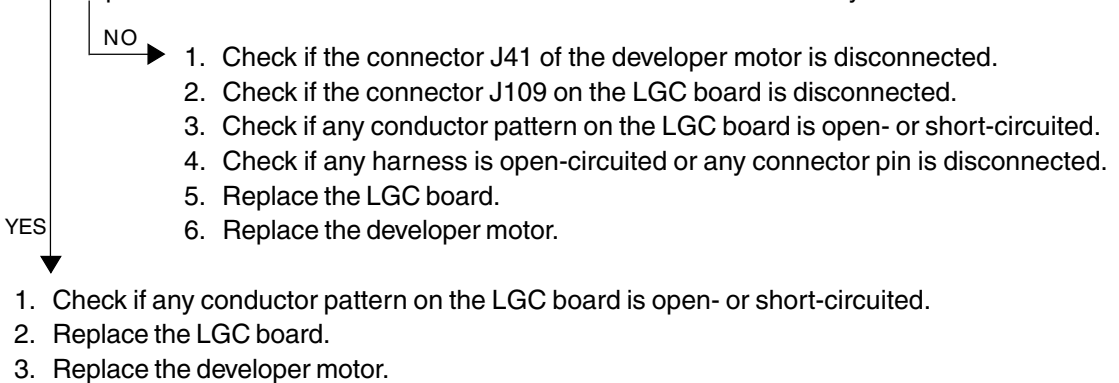

#### 4.1.10 Paper feeding system related service call

##### [C11] ADU paper side guide operation abnormal

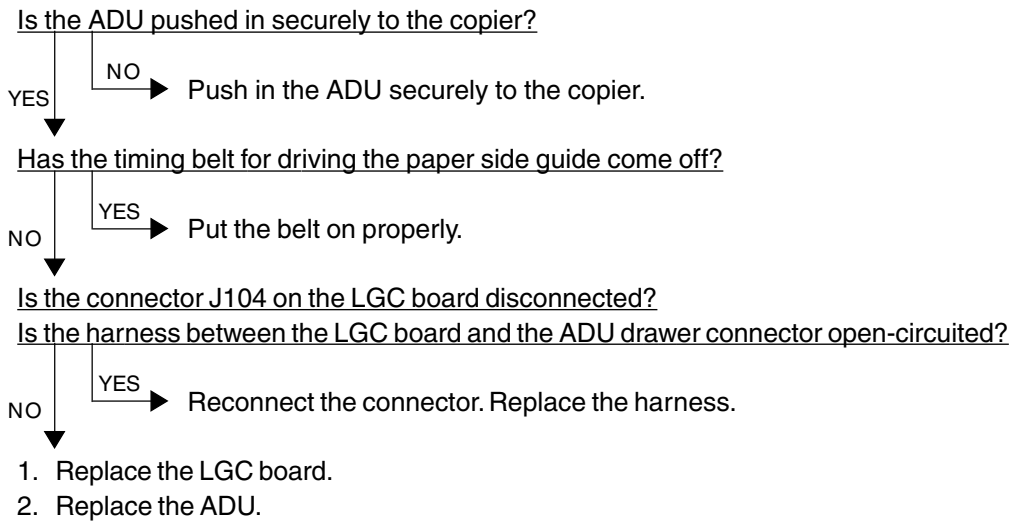

##### [C12] ADU paper end guide operation abnormal

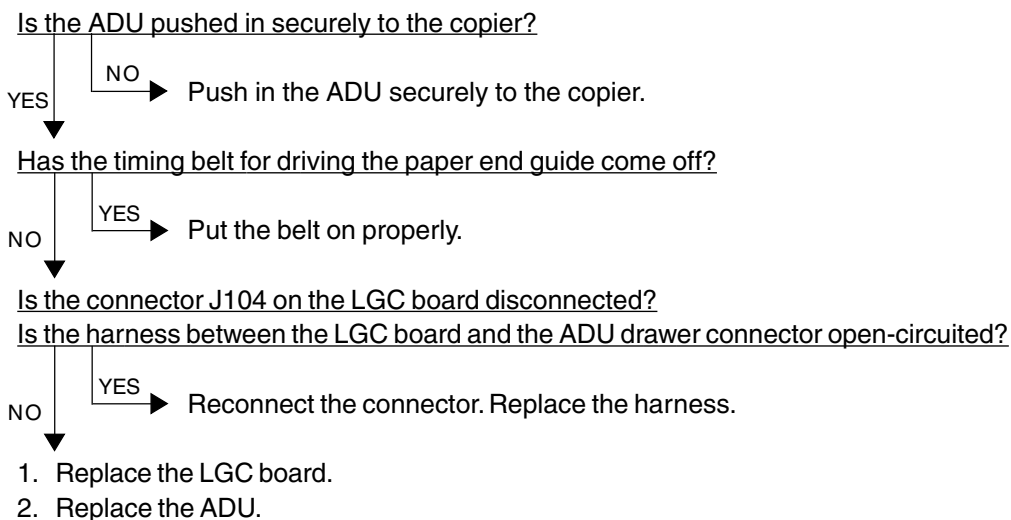

**[C13] 1st cassette tray operation abnormal**

**[C14] 2nd cassette tray operation abnormal**

**[C15] 3rd cassette tray operation abnormal**

**[C16] 4th cassette tray operation abnormal**

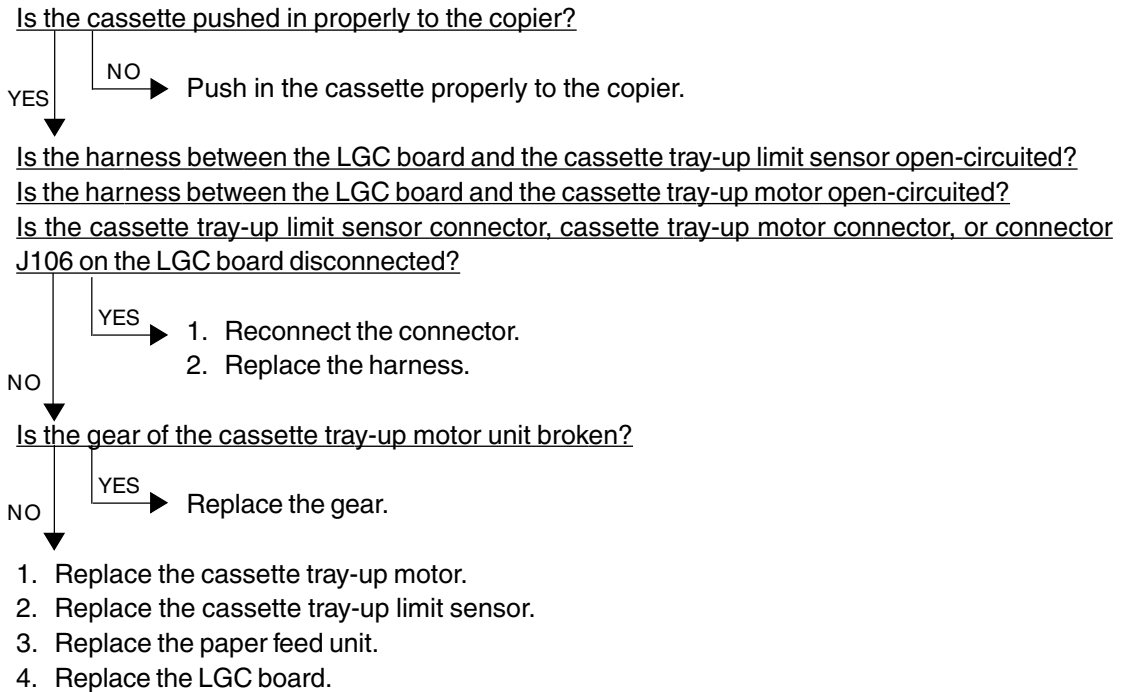

**[C18] LCF tray operation abnormal**

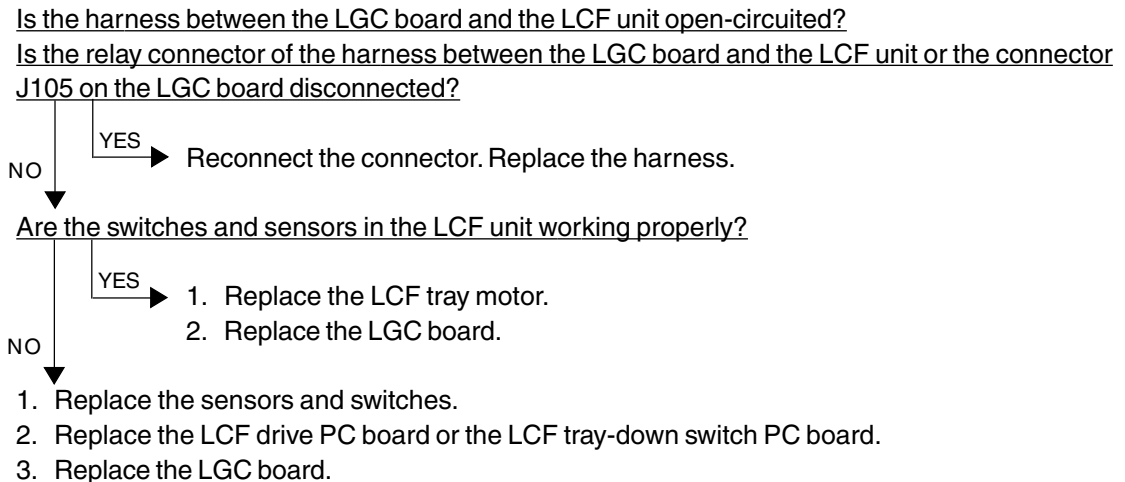

#### 4.1.11 Scanner related service call

##### [C27] Carriage home position sensor not turning OFF within a fixed time

##### [C28] Carriage home position sensor not turning ON within a fixed time

Remove the original glass, move the carriages to the paper feed side, turn ON the power switch, and then proceed to check the following items.

##### [C27] Are the carriages stuck at a point other than the home position?

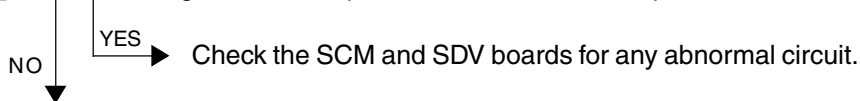

1. Check if any connector pin is disconnected, or any harness is open- or short-circuited.
2. Check the scan motor drive pulley if its screws are loose.
3. Check if any conductor pattern on the SDV board is open- or short-circuited.
4. Check if any conductor pattern on the SCM board is open- or short-circuited.
5. Replace the SDV board.
6. Replace the SCM board.

##### [C28] Do the carriages, after arriving at its home position, make a big noise?

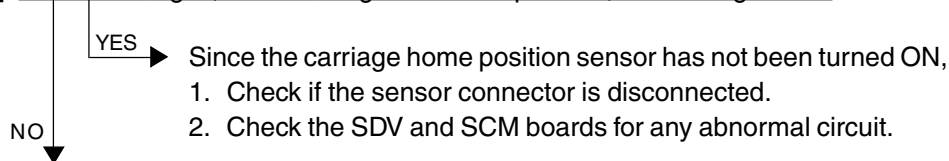

Since the carriages do not move,

1. Check if any connector pin is disconnected, or any harness is open- or short-circuited.
2. Check if any conductor pattern on the SDV board is open- or short-circuited.
3. Check if any conductor pattern on the SCM board is open- or short-circuited.
4. Replace the SDV board.
5. Replace the SCM board.

##### [C29] Exposure lamp disconnection detected

##### Does the exposure lamp light?

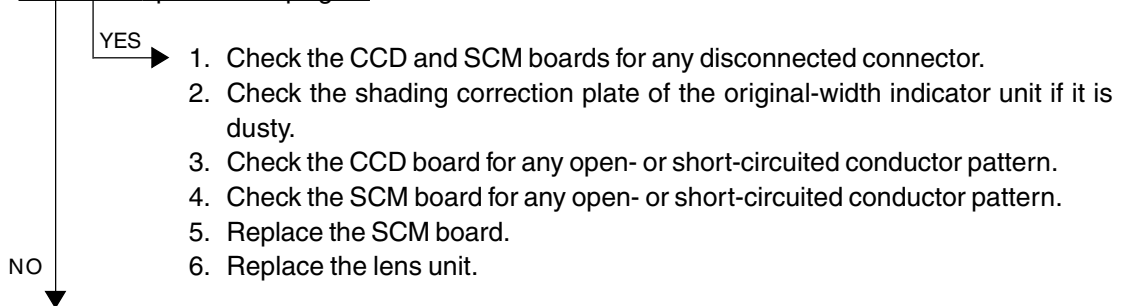

1. Check if the lamp connector is disconnected.
2. Check the SCM board if any pin of connectors J7-1, -2 and -3 is disconnected or any harness is open- or short-circuited.
3. Check the SCM board for any open- or short-circuited conductor pattern.
4. Replace the SCM board.
5. Replace the inverter.
6. Replace the exposure lamp.



#### 4.1.12 Copy process related service call

##### [C31] Used toner transport motor rotation abnormal

Is the harness between the LGC board and the used toner transport motor open-circuited?  
Is the connector J123 or J102 on the LGC board, the relay connector or the used toner transport motor connector disconnected?

NO ↓  
YES → Replace the harness. Reconnect the connector.

Is used toner jammed? Is any abnormal mechanical load found?

NO ↓  
YES →  
1. Remove the jammed used toner.  
2. Check for any foreign matter in the drive system.  
3. Check the bearing of the used toner transport auger for any abnormality.  
4. Check if the toner bag is covered with used toner.

1. Replace the used toner transport motor.
2. Replace the LGC board.

\* Since the used toner jamming can cause a serious damage to EPU, be sure to check that the EPU functions normally.

##### [C33] Developer removal shutter function abnormal

Reduce the mechanical load by adjusting the drive system. Remove any foreign matter.

Is the connector J115 on the LGC board disconnected?

NO ↓  
YES → Reconnect the connector.

Replace the LGC board.

**[C35] Transfer belt unit contact/release function abnormal**

Reduce the mechanical load by adjusting the drive system. Remove any foreign matter.

↓  
Is the harness between the LGC board and the transfer/transport unit drawer connector, or the harness inside the transfer/transport unit open-circuited?

Is the transfer belt contact/release drive motor connector, LGC board connector J115 or J102, transfer belt home position switch connector, or transfer belt limit switch connector disconnected?

Is the transfer belt home position switch or the transfer belt limit switch defectively installed?

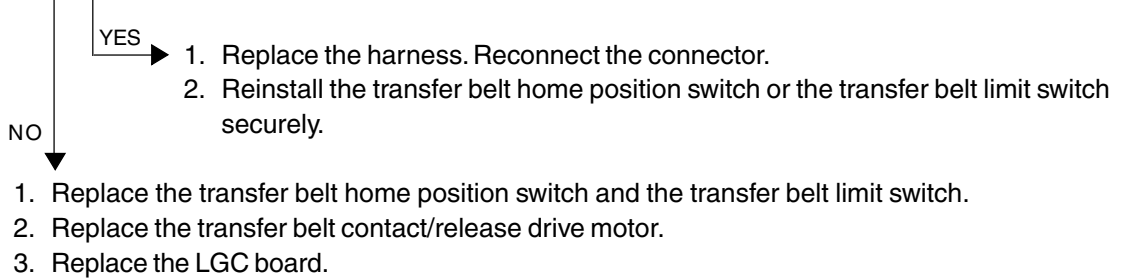

**[C38] Auto-toner error (K)**

**[C39] Auto-toner error (C)**

**[C3A] Auto-toner error (M)**

**[C3B] Auto-toner error (Y)**

Is the harness between the LGC board and the EPU drawer connector open-circuited?

Is any harness inside the EPU or the auto-toner sensor harness open-circuited?

Is the auto-toner sensor connector or the connector J120 on the LGC board disconnected?

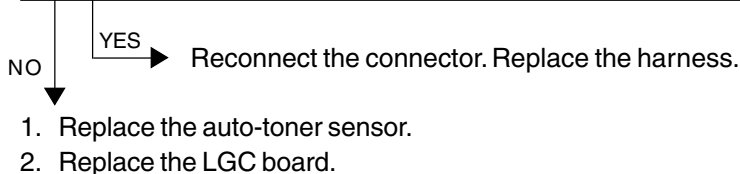

- [C3C] Main charger wire cleaning abnormal (K)**
- [C3D] Main charger wire cleaning abnormal (C)**
- [C3E] Main charger wire cleaning abnormal (M)**
- [C3F] Main charger wire cleaning abnormal (Y)**

Is the harness between the LGC board and the EPU drawer connector or any harness inside the EPU open-circuited?

Is the wire cleaner drive motor connector, the connector J120 on the LGC board, the connector of the wire cleaner home position switch, or the connector of the wire cleaner limit switch disconnected?

Has the wire cleaner home position switch or the wire cleaner limit switch defectively installed or come off?

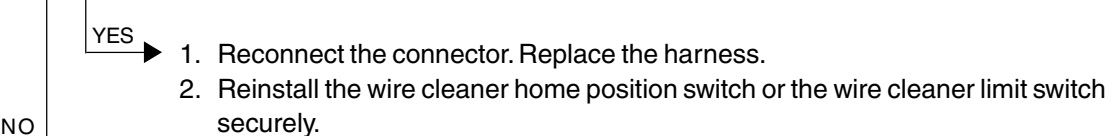

Is the main charger securely installed?

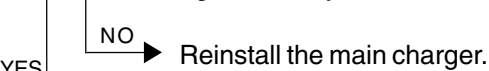

Is the mechanical load too heavy?

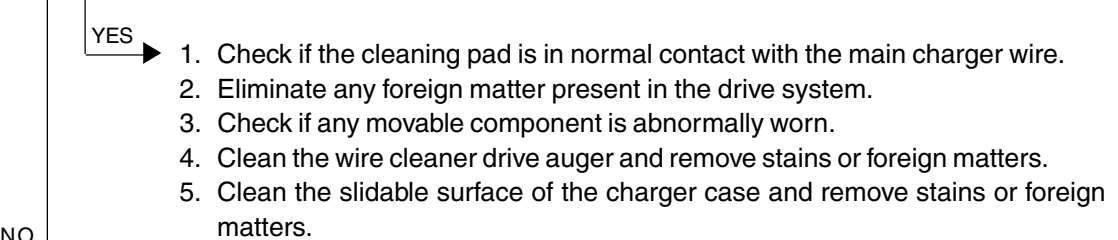

1. Replace the wire cleaner home position switch or the wire cleaner limit switch.
2. Replace the wire cleaner drive motor.
3. Replace the LGC board.

#### 4.1.13 Fuser unit related service call

- [C41] Thermistor or heater abnormal when warming-up is started
- [C42] Thermistor abnormal after the copier has become ready
- [C43] Thermistor abnormal during warming-up after abnormality judgment
- [C44] Heater abnormal during warming-up after abnormality judgment
- [C46] Heater abnormal (low temperature) after the copier has become ready
- [C47] Rear thermistor abnormal after the copier has become ready
- [C48] Heater abnormal (high temperature)

\* To avoid any hazards, be sure to unplug the power cable before proceeding to check the items in 1. and 2. below.

\* Be sure that the fuser unit is set in place securely.

##### 1. Checking the thermistors

- (1) Is any thermistor connector disconnected?
- (2) Are the thermistors (upper/lower, center/rear) in proper contact with the upper and lower heat rollers?
- (3) Are the harnesses for the thermistors (upper/lower, center/rear) open-circuited?

##### 2. Checking the heater lamps and SSRs

- (1) Check if the upper or lower heater lamp is open-circuited.
- (2) Check if the upper or lower heater lamp connector is disconnected.
- (3) Check if the thermostat is blown out.
- (4) Check if the upper heat roller or lower heat roller SSR connector is disconnected.
- (5) Check if the AC harness is open-circuited.
- (6) Check if SSR or the switching power supply is broken.

##### 3. Checking the LGC board

- (1) Check the LGC board if the connector J123 is disconnected.
- (2) Check if the conductor pattern on the LGC board is open- or short-circuited.
- (3) Replace the LGC board.

##### 4. Clearing the status counter

After completing the repair of what caused the error, proceed to do the following:

- (1) While pressing [0] and [8] simultaneously, turn ON the power.
- (2) Enter [700] with digital keys, then press the [START] key.
- (3) Rewrite the status counter to "0", then press the [SET] or [INTERRUPT] key.

The status counter is displayed as follows:

[C41]: "1" or "2"	[C42]: "6"	[C43]: "4"	[C44]: "5"
[C46]: "7"	[C47]: "8"	[C48]: "9"	

- (4) Turn OFF the power and then back it ON again, and make sure that the copier gets ready normally.

## **[C7] Error C7**

\* To avoid any hazards, be sure to unplug the power cord before proceeding to check the items in 1. and 2. below.

\* Be sure that the fuser unit is set in place securely.

1. Check if any thermistor connector is disconnected.
2. Check if any harness of the thermistors (center/rear, upper/lower) is open-circuited.
3. Check the LGC board if the connector J122 is disconnected.
4. After completing the repair of what caused the [C7] problem, proceed to rewrite the status counter (08-700) to "0", following the same procedure as for [C41] to [C48] .

#### 4.1.14 Communications related service call

##### **[C57] Communication error between LGC-CPU and IPC board**

- (1) Check if any conductor pattern on the LGC board, mainly around IC23, IC72, IC74 and J125, is short- or open-circuited.
- (2) Check if the conductor pattern on the IPC board is short- or open-circuited.
- (3) Replace the IPC board.
- (4) Replace the LGC board.

##### **[C5A] Communications error between LGC-CPU and printer controller**

###### **<<For a built-in type printer controller>>**

1. Check if the printer controller unit is securely mounted on the copier.
2. Check if the harness between the LGC and IMC boards is open-circuited, and if the connector J113 on the LGC board and the connector J182 on the IMC board are disconnected.
3. Check if the harness between the switching power supply and the printer controller is open-circuited.
4. Check if the connector J710 of the switching power supply is disconnected.
5. Check if any conductor pattern on the IMC, IMG, MTH2 and LGC boards is open- or short-circuited .
6. Replace the LGC board.
7. Replace the IMG board.
8. Replace the IMC board.
9. Replace the MTH2 board.

###### **<<For an external type printer controller>>**

1. Check if the printer controller power is turned ON.
2. Check if the harness between the PIF board and the printer controller is open-circuited.
3. Check if the PIF board is firmly connected to the MTH2 board.
4. Check if the harness between the LGC and IMC boards is open-circuited, and if the connector J113 on the LGC board and the connector J182 on the IMC board are disconnected.
5. Check if any conductor pattern on the PIF, IMG, MTH2, IMC and LGC boards is open- or short-circuited.
6. Replace the PIF board.
7. Replace the LGC board.
8. Replace the IMG board.
9. Replace the IMC board.
10. Replace the MTH2 board.

##### **[C5B] LGC-CPU signal transmission error to IMC-CPU**

##### **[C5C] LGC-CPU signal reception error from IMC-CPU**

1. Check if the harness between the LGC and IMC boards is open-circuited, and if the connector J113 on the LGC board and the connector J182 on the IMC board are disconnected.
2. Replace the LGC board.
3. Replace the IMC board.

#### **4.1.15 ADF related service call**

##### **[C72] Aligning sensor automatic adjustment error**

1. Check if any foreign matter is present between the aligning sensor and the reflecting mirror, and if the reflecting mirror is stained.
2. Check if the harness between the aligning sensor and the RADF PC board is open-circuited.
3. Check if any conductor pattern on the RADF PC board is open- or short-circuited mainly around IC1, IC14 and CN14.
4. Replace the aligning sensor.
5. Replace the RADF PC board.
6. Initialize the RADF's EEPROM and perform the sensor automatic adjustment.

##### **[C73] EEPROM initializing error**

1. Check if any conductor pattern on the RADF PC board is open- or short-circuited mainly around IC7.
2. Replace the RADF PC board.
3. Initialize the RADF's EEPROM and perform the sensor automatic adjustment.

##### **[C74] Paper exit sensor automatic adjustment error**

1. Check if any foreign matter is present between the exit sensor and the reflecting mirror, and if the reflecting mirror is stained.
2. Check if the harness between the exit sensor and the RADF PC board is open-circuited.
3. Check if any conductor pattern on the RADF PC board is open- or short-circuited mainly around IC1, IC14 and CN8.
4. Replace the exit sensor.
5. Replace the RADF PC board.
6. Initialize the RADF's EEPROM and perform the sensor automatic adjustment.

#### 4.1.16 Other service call (1)

##### [C94] LGC-CPU abnormal

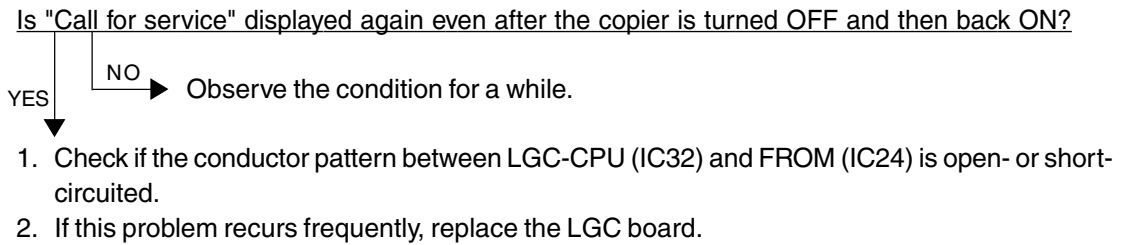

##### [C9A] Main memory abnormal

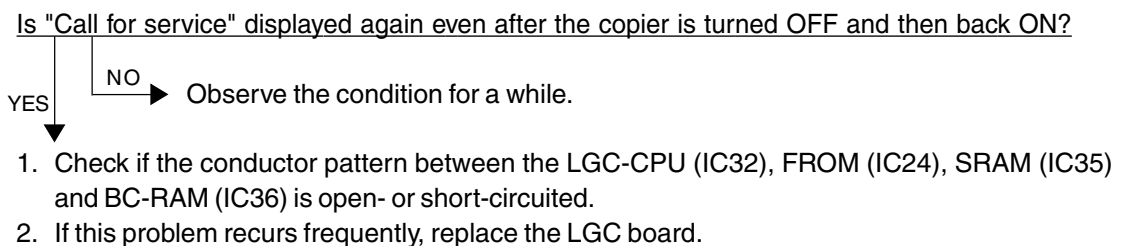

##### [C9B] LGC-CPU protocol error

##### [C9D] IMC-CPU protocol error

Turn the power OFF, and back ON.

In case that these errors occur frequently, confirm the contents of the following items in the setting mode and report them.

- 08-267 C9B/C9D error history display
- 08-900 Firmware version (Basic section ROM)
- 08-902 Engine ROM version (LGC)
- 08-903 Printer ROM version (IMC)

##### [C9E] IMC board connection abnormal

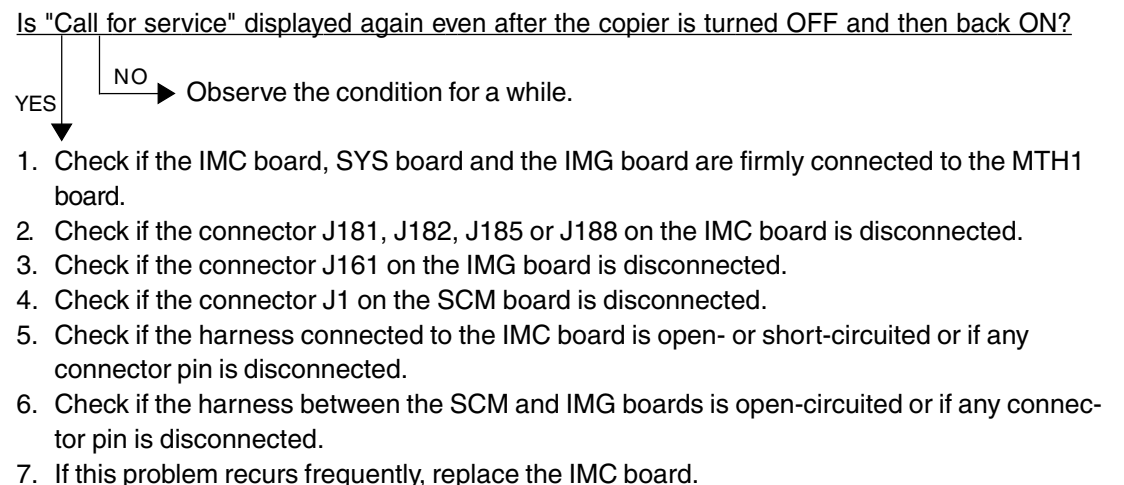



#### 4.1.17 Laser optical unit related service call

##### [CA1] Polygonal motor rotation abnormal

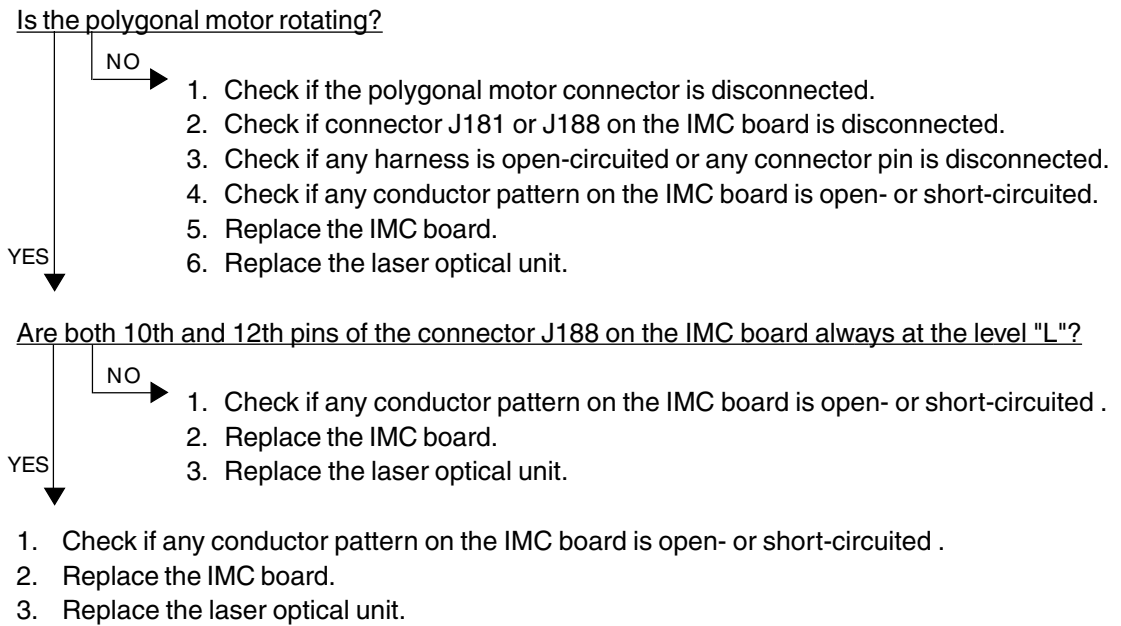

**[CA2] H-SYNC abnormal**

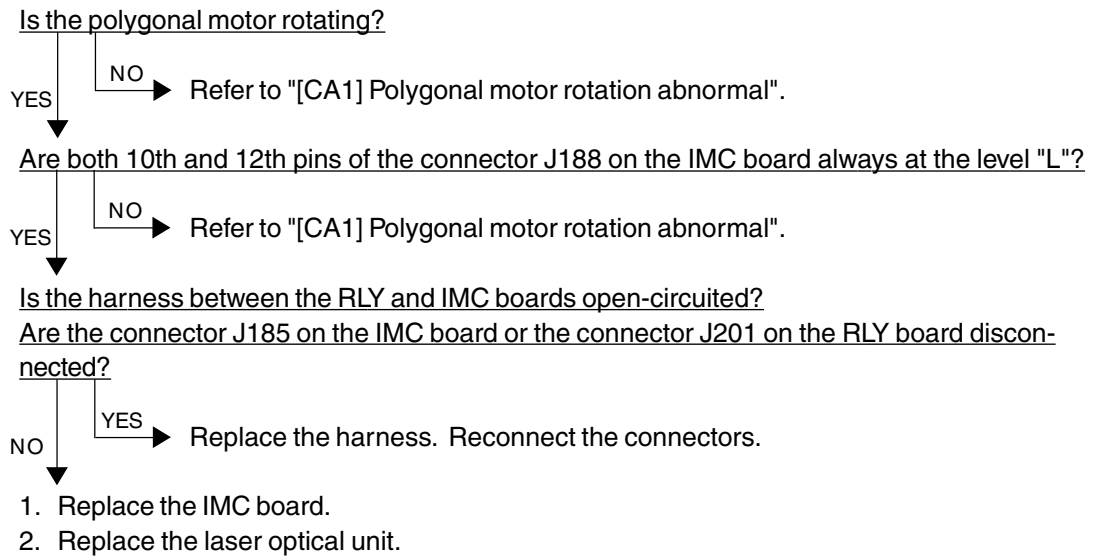

**[CD1] Laser calibration error (K)**

**[CD2] Laser calibration error (C)**

**[CD3] Laser calibration error (M)**

**[CD4] Laser calibration error (Y)**

Replace the IMC board.

#### 4.1.18 Finisher related service call

##### [CB1] Feed motor abnormal

[Procedure 1]

Is the second feed motor (M8) rotating in reverse at the specified timing?

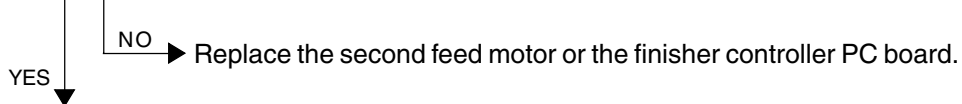

Is the shutter securely attached to the shutter upper/lower bars?

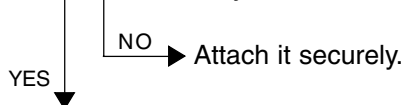

Turn the feed roller-2 in reverse by hand. Do the shutter upper/lower bars move up and down?

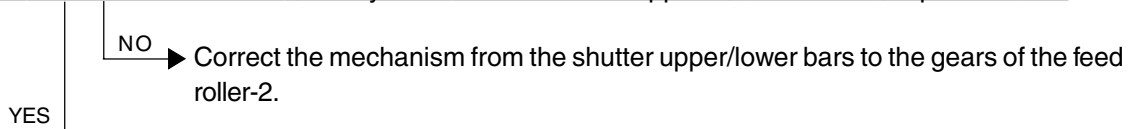

Is the shutter closed detecting switch (MS4) working normally?



Replace the finisher controller PC board.

[Procedure 2]

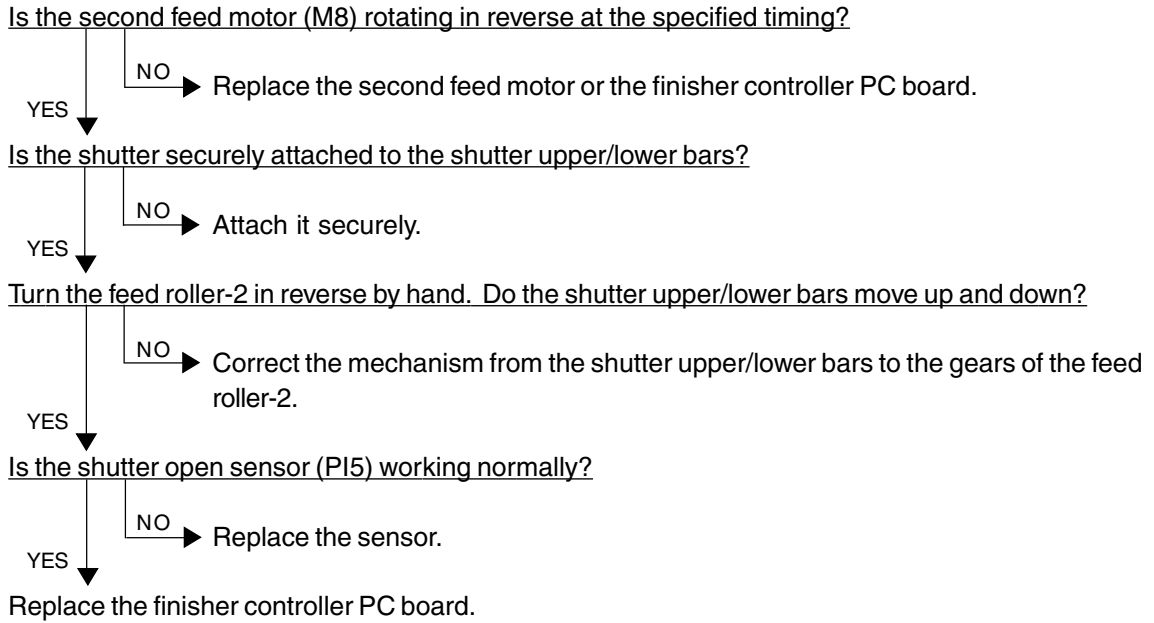

[Procedure 3]

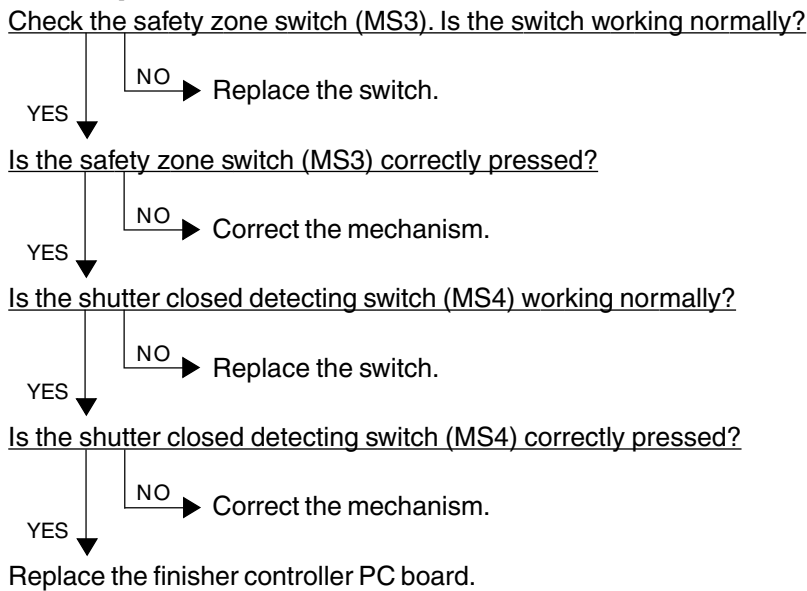

### [CB2] Delivery motor abnormal

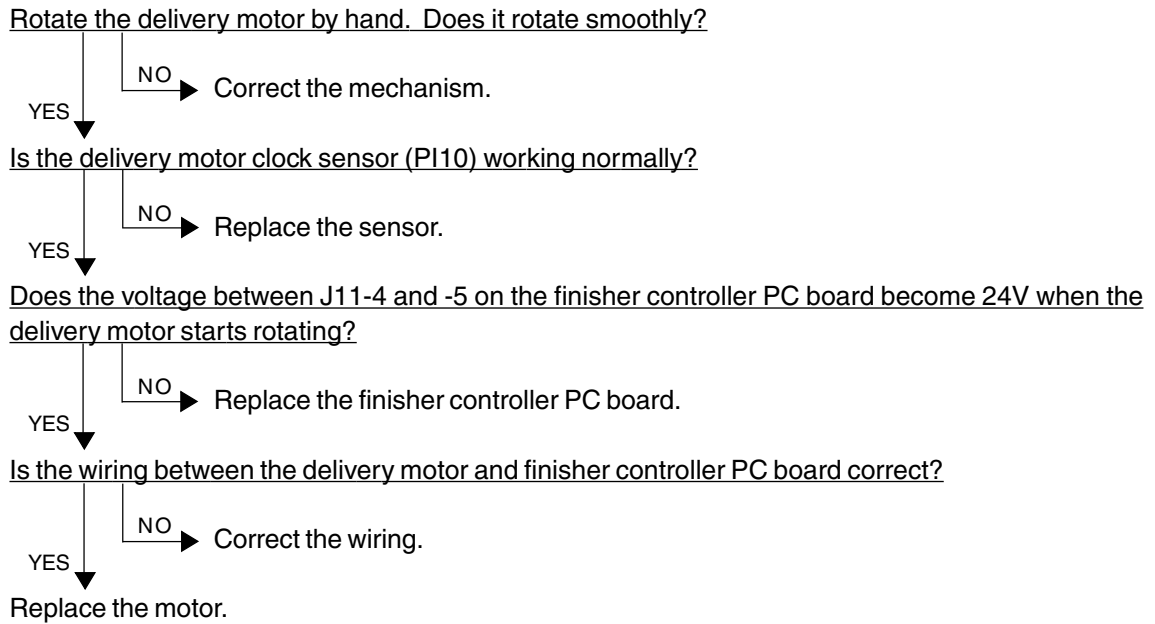

### [CB3] Tray lift motor abnormal

[Procedure 1]

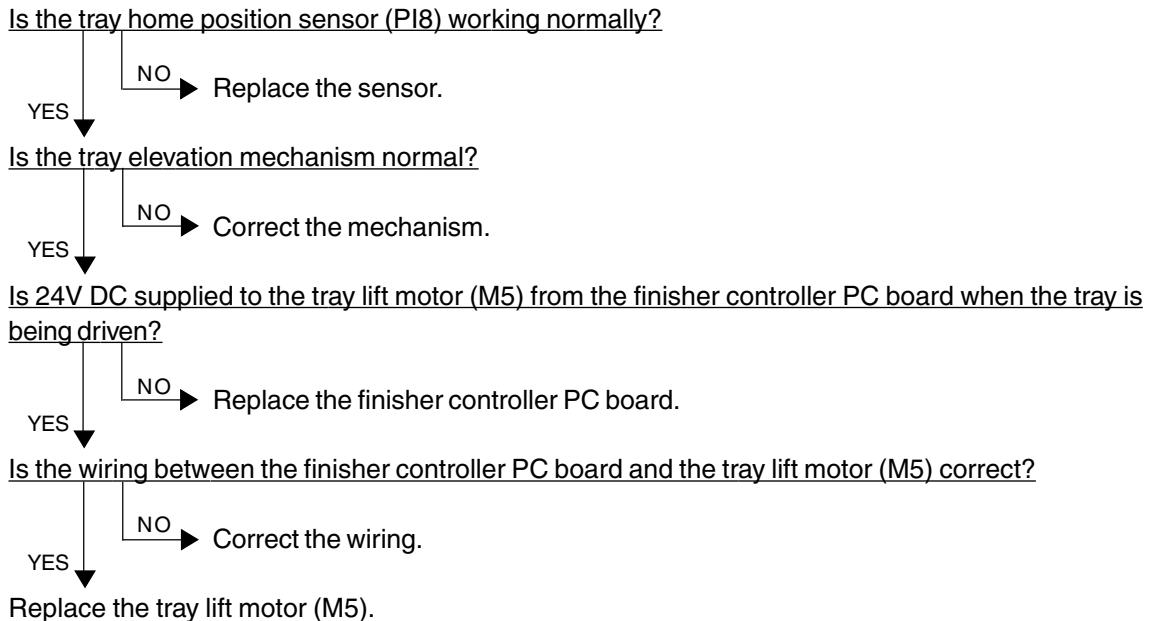

[Procedure 2]

Does the tray reach the tray upper limit detecting switch (MS5)?

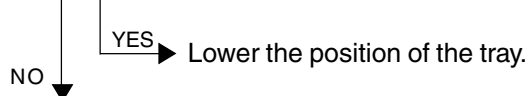

Is the tray upper limit detecting switch (MS5) working normally?



Is the wiring between the finisher controller PC board and the tray upper limit detecting switch correct?

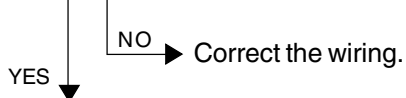

Replace the finisher controller PC board.

[Procedure 3]

Does the tray move up/down?

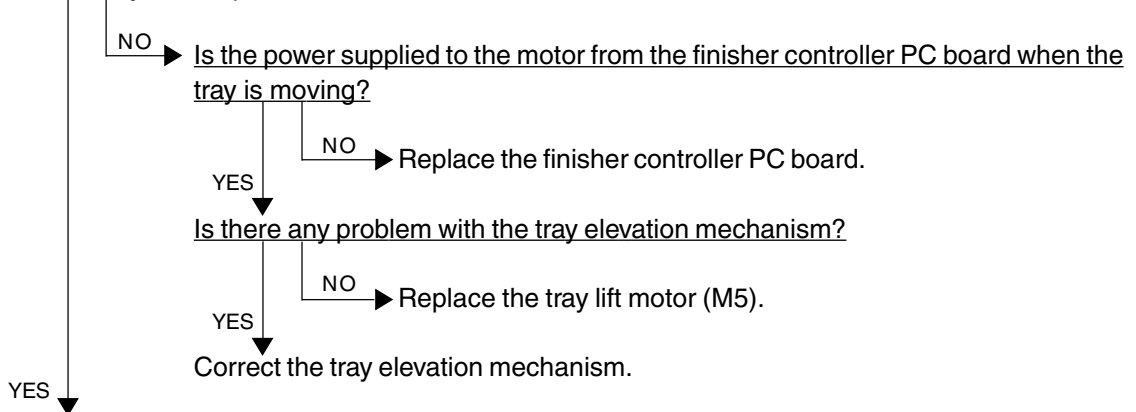

Are the tray lift motor clock sensor-1/-2 (PI9/PI19) working normally?



Replace the finisher controller PC board.

#### [CB4] Alignment motor abnormal

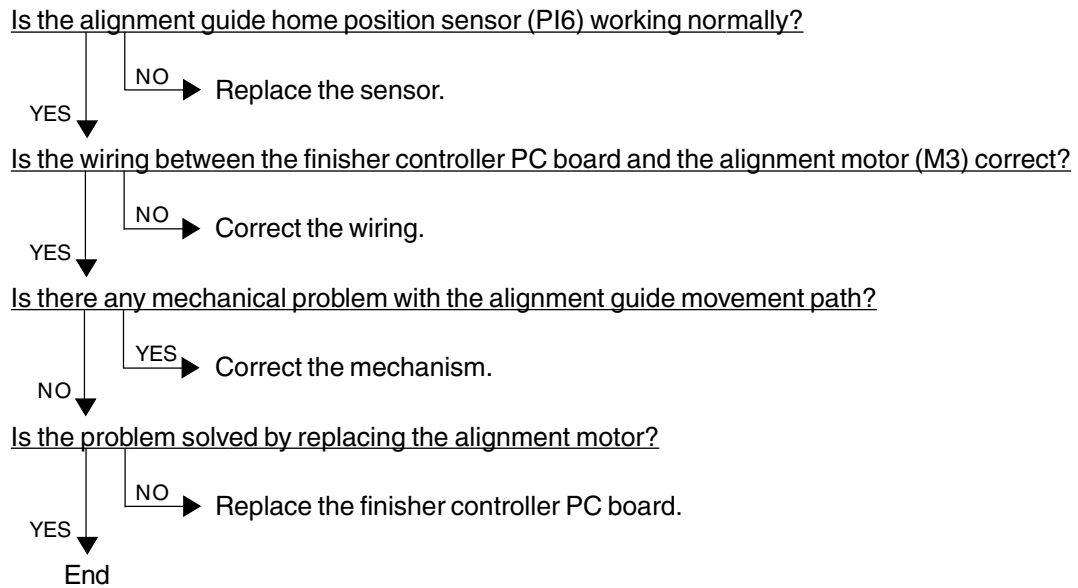

#### [CB5] Staple motor abnormal

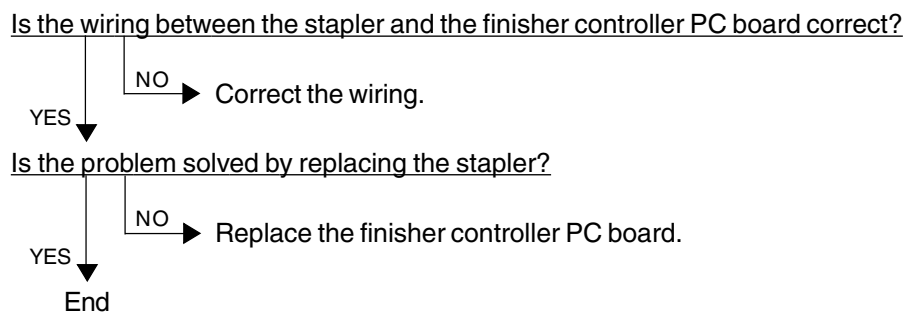

### [CB6] Stapler shift motor abnormal

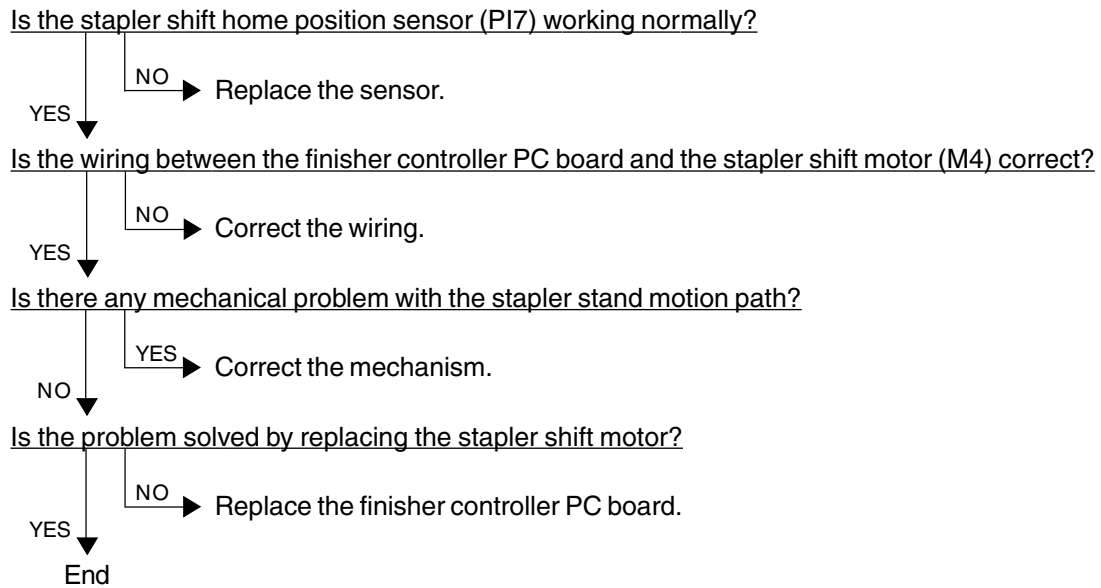

### [CB7] Height sensor abnormal

[Procedure 1]

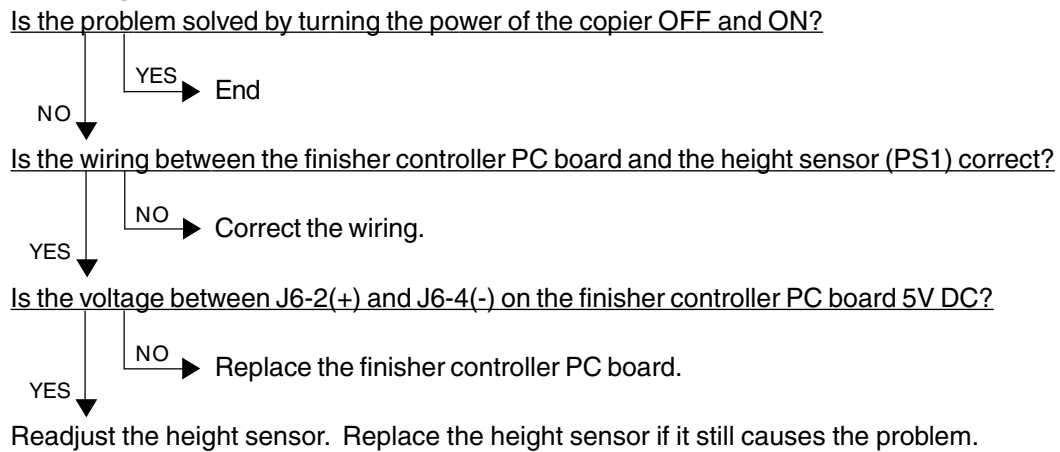



[Procedure 2]

Is the connector J6 on the finisher controller PC board, J114 of the height sensor (PS1) or relay connector J212 disconnected?

NO  
YES → Connect the connector.

Is the voltage between J6-2(+) and J6-4(-) on the finisher controller PC board 5V DC?

YES  
NO → Replace the finisher controller PC board.

Is the wiring between the finisher controller PC board and height sensor correct?

YES  
NO → Correct the wiring.

Replace the height sensor.

[Procedure 3]

Is the problem solved by readjusting the DIP switch?

NO  
YES → End

Is the wiring between the finisher controller PC board and height sensor (PS1) correct?

YES  
NO → Correct the wiring.

Is the voltage between J6-2(+) and J6-4(-) on the finisher controller PC board 5V DC?

YES  
NO → Replace the finisher controller PC board.

Replace the height sensor.

**[CB8] Backup RAM data abnormal**

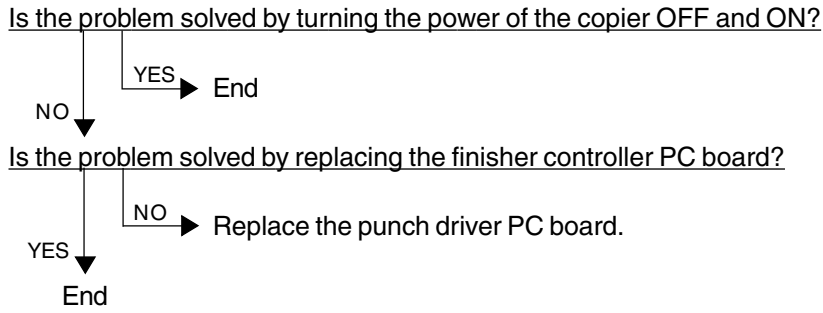

**[CB9] Saddle stitcher/paper pushing plate motor abnormal**

[Procedure 1]

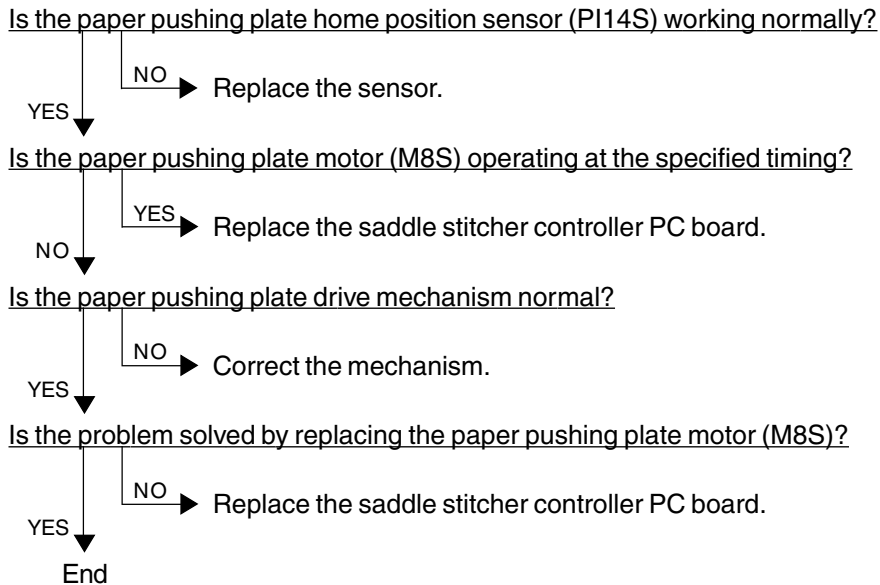

[Procedure 2]

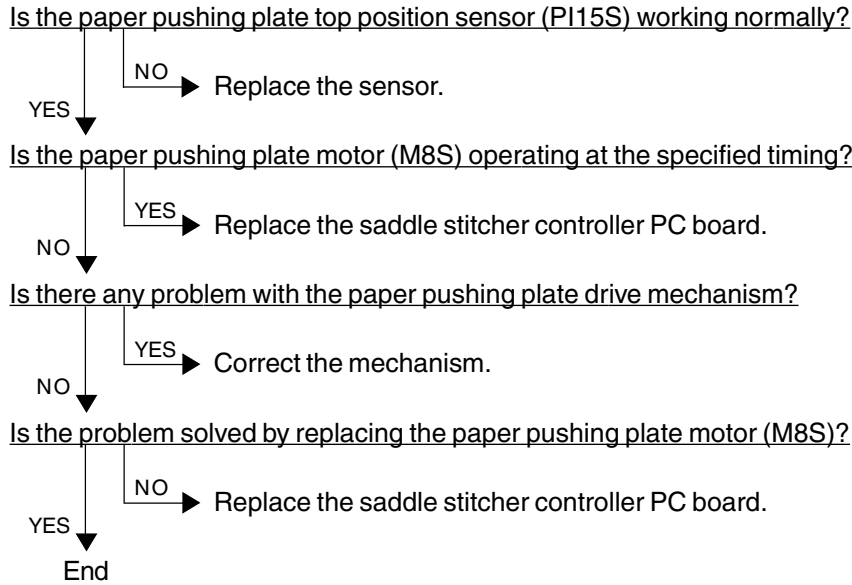

[Procedure 3]

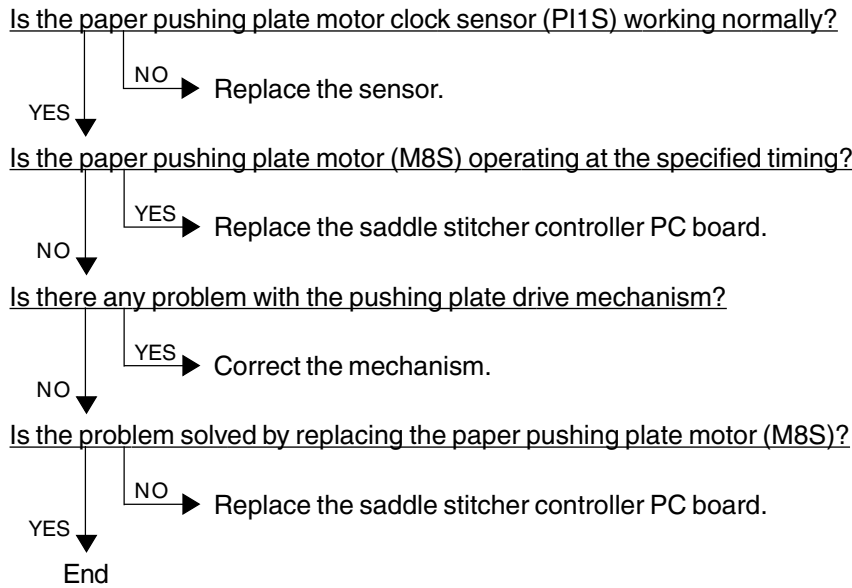

**[CBA] Saddle stitcher/stitcher motor (front) abnormal**

**[CBB] Saddle stitcher/stitcher motor (rear) abnormal**

Are the front or rear stitcher and its stand installed properly?



Is the stitcher home position switch on the front or rear stitcher (MS7S/MS5S) working normally?

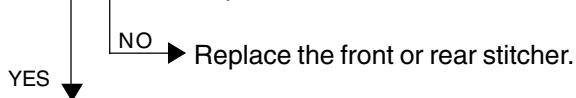

Is the front or rear stitcher operating at the specified timing?

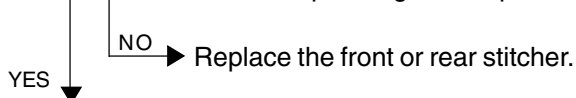

Check the wiring between the stitcher and saddle stitcher controller PC board. If there is no problem, replace the controller PC board.

**[CBC] Saddle stitcher/alignment motor abnormal**

Is the alignment plate home position sensor (PI5S) working normally?



Is the alignment motor (M5S) operating at the specified timing?

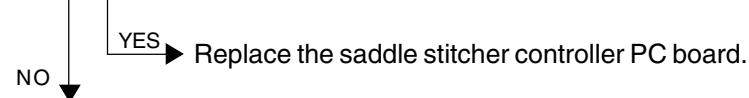

Is the alignment plate drive mechanism normal?

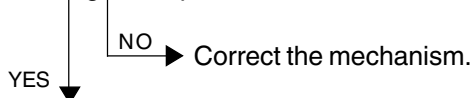

Is the problem solved by replacing the alignment motor (M5S)?

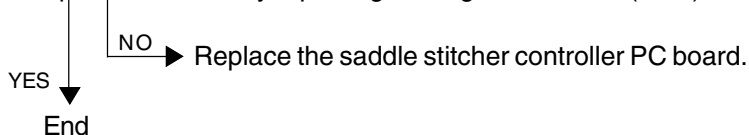

### [CBD] Saddle stitcher/guide motor abnormal

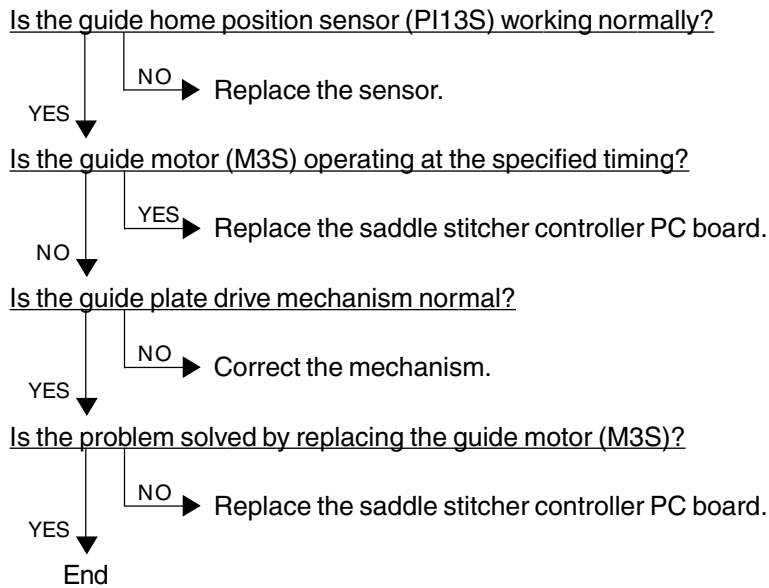

### [CBE] Saddle stitcher/paper folding motor abnormal

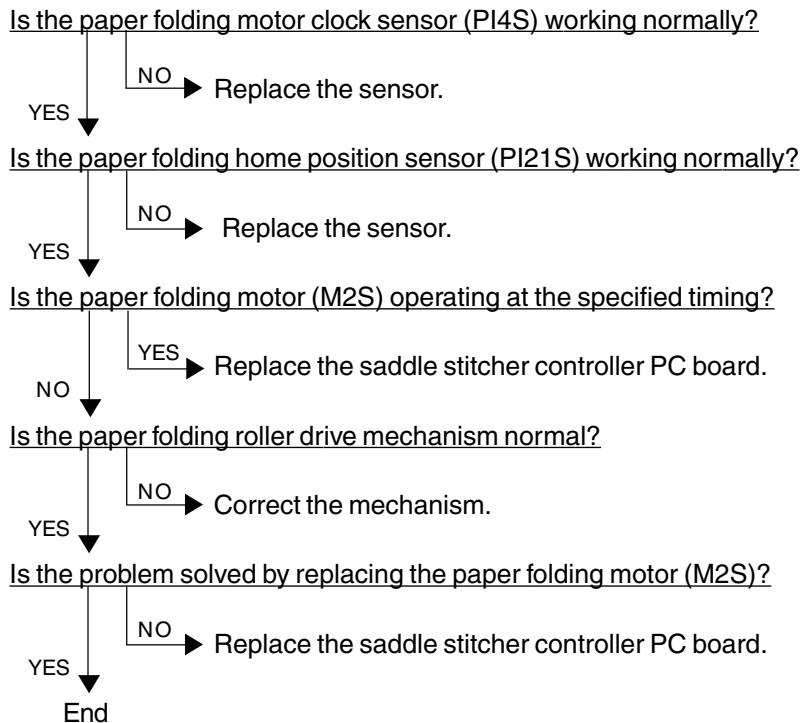

**[CBF] Saddle stitcher/paper positioning plate motor abnormal**

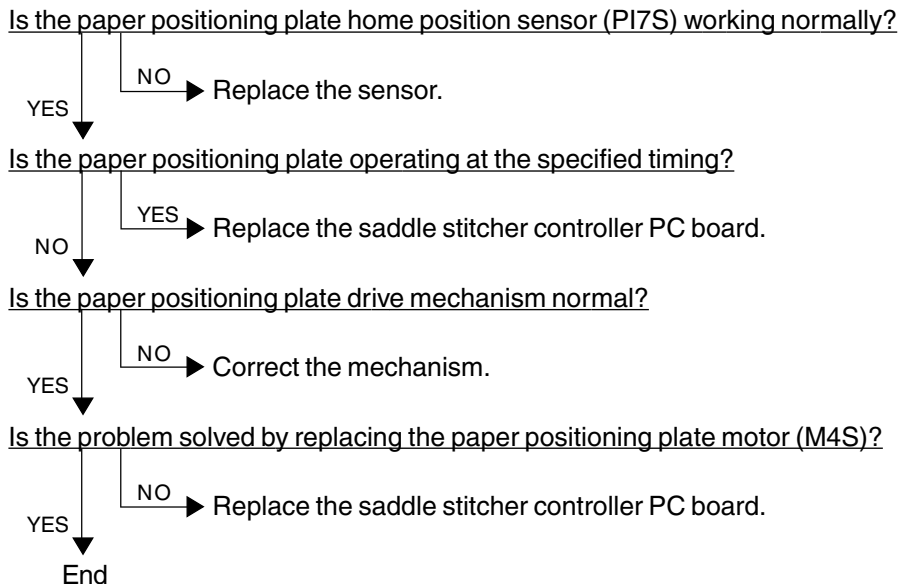

**[CD5] Saddle stitcher/sensor connector connection error**

[Procedure 1]

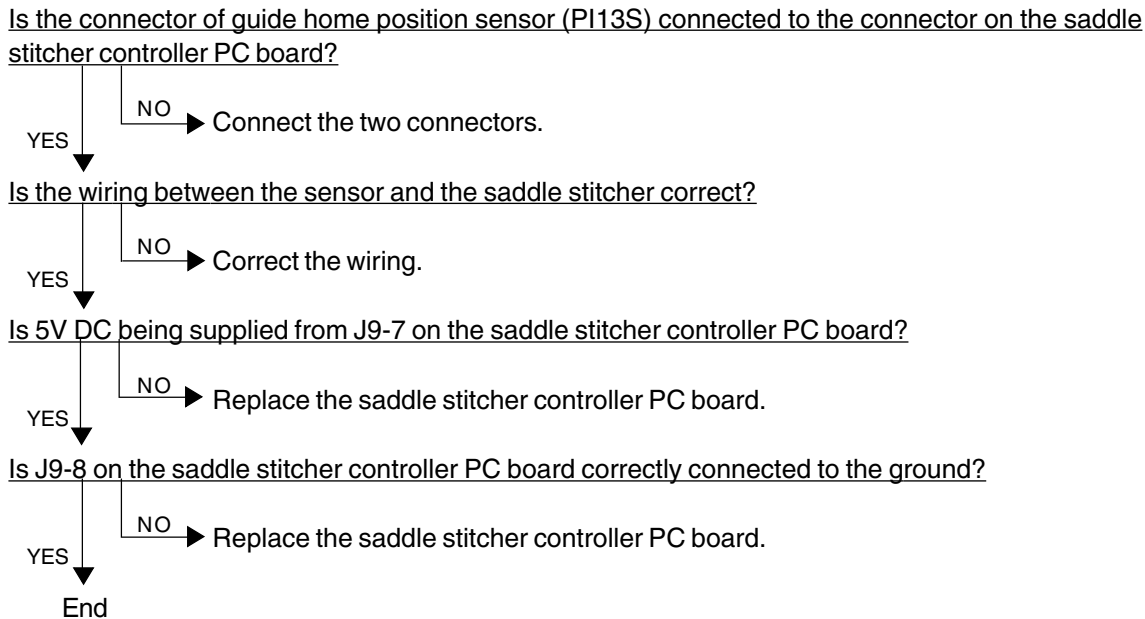

[Procedure 2]

Is the connector of paper pushing plate home position sensor (PI14S) connected to the connector on the saddle stitcher controller PC board?

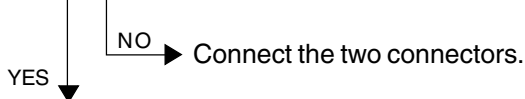

Is the wiring between the sensor and the saddle stitcher correct?

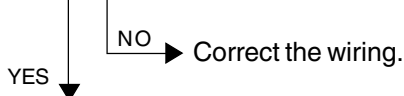

Is 5V DC being supplied from J9-10 on the saddle stitcher controller PC board?

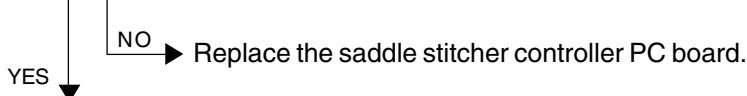

Is J9-11 on the saddle stitcher controller PC board properly connected to the ground?

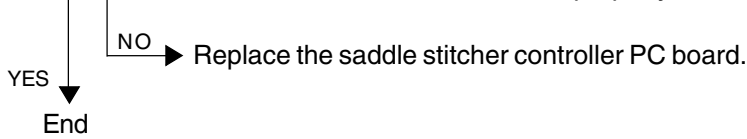

[Procedure 3]

Is the connector of paper pushing plate top position sensor (PI15S) connected to the connector on the saddle stitcher controller PC board?

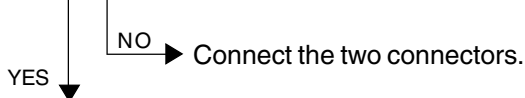

Is the wiring between the sensor and the saddle stitcher correct?

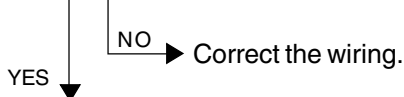

Is 5V DC being supplied from J9-13 on the saddle stitcher controller PC board?

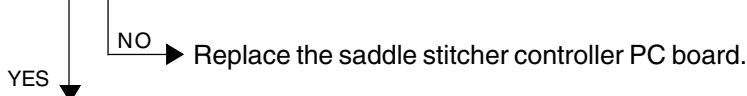

Is J9-14 on the saddle stitcher controller PC board properly connected to the ground?

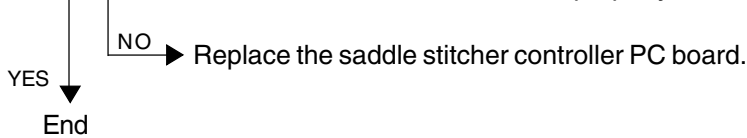

## [CD6] Saddle stitcher/microswitch abnormal

[Procedure 1]

Is the switch actuator for the inlet door working properly?

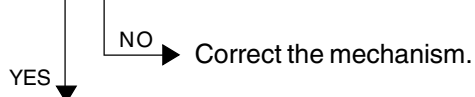

Is the inlet cover switch (MS1S) working normally?



Is the voltage of J10-8 on the saddle stitcher controller PC board 5V when the inlet door is open?

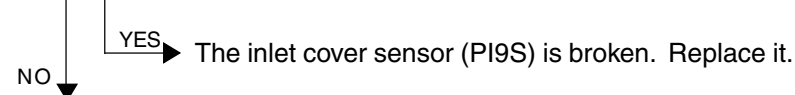

Is the voltage between J19-2 (+) and J19-1 (-) on the finisher controller PC board 24 V?

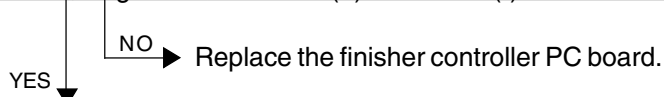

Check and correct the wiring between J19 on the finisher controller PC board and J1 on the saddle stitcher controller PC board. If there is no problem, replace the saddle stitcher controller PC board.



[Procedure 2]

Is the switch actuator for the front door working properly?

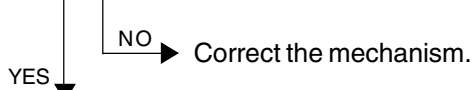

Is the front cover switch (MS2S) working normally?



Is the voltage of J11-12 on the saddle stitcher controller PC board 5V when the front door is opened?

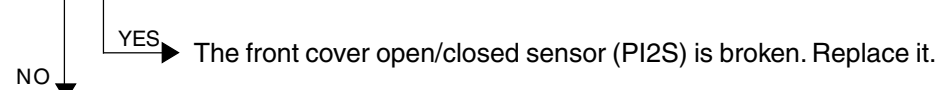

Replace the saddle stitcher controller PC board.

[Procedure 3]

Is the switch actuator for the delivery door working properly?

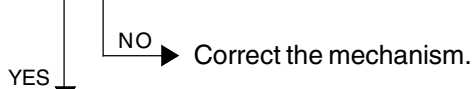

Is the delivery cover switch (MS3S) working normally?



Is the voltage of J11-9 on the saddle stitcher controller PC board 5V when the delivery door is opened?

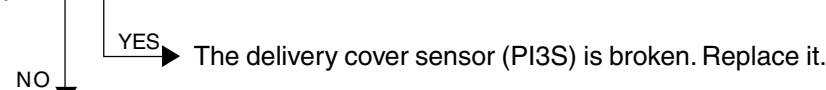

Replace the saddle stitcher controller PC board.

**[CD7] Communication error between finisher and saddle stitcher**

Is the problem solved by turning OFF and ON the power switch of the copier?

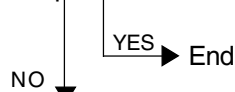

Is the wiring between the finisher controller PC board and the saddle stitcher controller PC board correct?

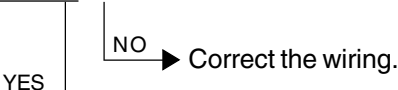

Is the voltage between J3-2 (+) and J3-1 (-) on the finisher controller PC board 24V DC?

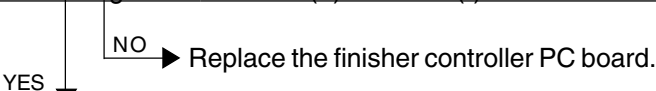

Replace the saddle stitcher controller PC board.

## [CD9] Swing motor abnormal

### [Procedure 1]

Rotate the swing motor in reverse by hand. Does the swing guide move up and down?

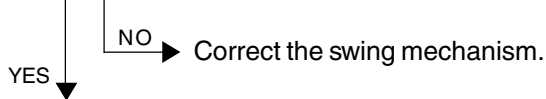

Is the swing guide closed detection switch-2 (MS6) working normally?



Is the swing guide open sensor (PI18) working normally?



Is the swing motor (M7) rotating in reverse at the specified timing?

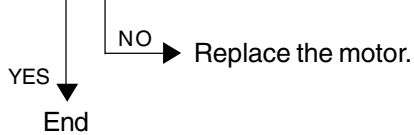

### [Procedure 2]

Is the safety zone switch (MS3) working normally?



Is the safety zone switch (MS3) correctly pressed?

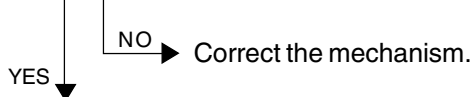

Is the swing guide closed detection switch-2 (MS6) working normally?



Is the swing guide closed detection switch-2 (MS6) correctly pressed?

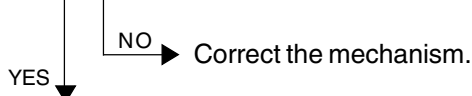

Replace the finisher controller PC board.

[Procedure 3]

Is the swing motor clock sensor (PI20) working normally?



Does the voltage between J11-6 and -7 on the finisher controller PC board become 24V when the swing motor starts rotating?

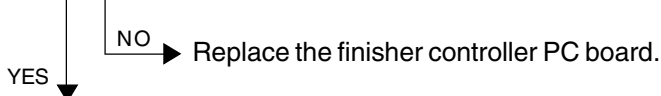

Is the wiring between the swing motor and finisher controller PC board correct?

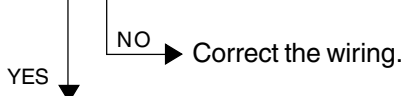

Replace the swing motor.

**[CDA] Horizontal registration motor abnormal**

Is the horizontal registration home position sensor (PI1P) working normally?



Is the wiring between the horizontal registration home position sensor (PI1P) and finisher controller PC board correct?

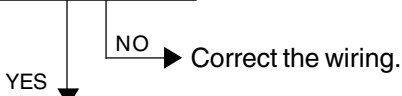

Is the horizontal registration mechanism normal?

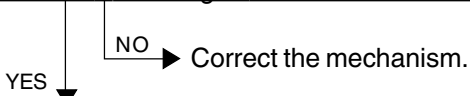

Is the problem solved by replacing the horizontal registration motor (M2P)?

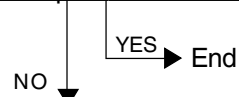

Is the problem solved by replacing the punch driver PC board?

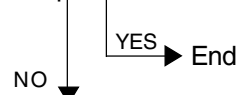

Replace the finisher controller PC board.

## [CDB] Punch motor abnormal

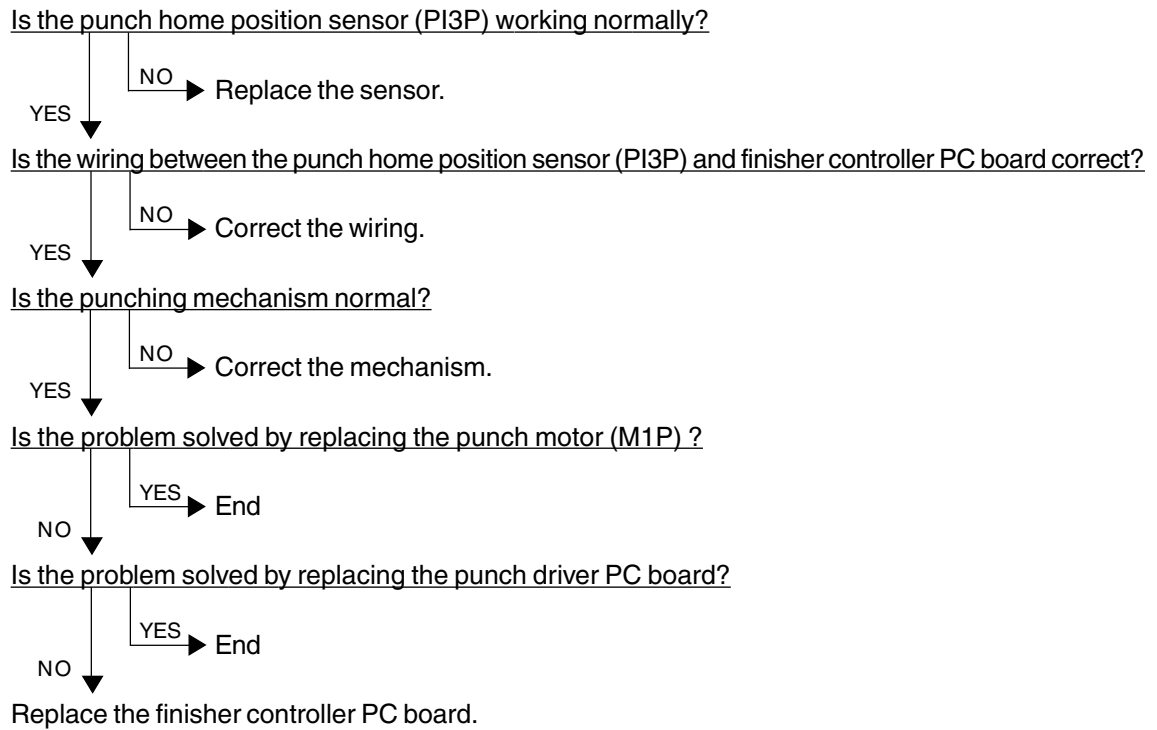

#### 4.1.19 Image quality related service call

- (1) After checking [CE1], [CE2] and [CE4], and taking appropriate action, perform the forced performing of image quality control.
  1. While pressing [0] and [5] simultaneously, turn ON the power.
  2. Enter [878] with digital keys, and then press the [START] key.
  3. Turn OFF and then back ON the power, and check that the copier becomes ready normally.
  
- (2) After confirming the items in (1), clear the abnormal detection counter of image quality control.
  1. While pressing [0] and [8] simultaneously, turn ON the power.
  2. Enter [415] with digital keys, and then press the [START] key.
  3. Rewrite the displayed status counter from "1" ~ "16" to "0", and then press the [SET] or [INTERRUPT] key.
  4. Enter [416] with digital keys, and then press the [START] key.
  5. Rewrite the displayed status counter from "1" ~ "16" to "0", and then press the [SET] or [INTERRUPT] key.
  6. Enter [417] with digital keys, and then press the [START] key.
  7. Rewrite the displayed status counter from "1" ~ "16" to "0", and then press the [SET] or [INTERRUPT] key.
  8. Enter [418] with digital keys, and then press the [START] key.
  9. Rewrite the displayed status counter from "1" ~ "16" to "0", and then press the [SET] or [INTERRUPT] key.
  10. Turn OFF and then back ON the power, and check that the copier becomes ready normally.

#### [CE1] Image quality sensor abnormal (OFF level)

Is the connector of the image quality sensor, or the connector J113, J114, J115 or J119 on the LGC board, or the connector J182 on the IMC board disconnected?

Is the harness between the LGC board and the image quality sensor, or the harness between the LGC board and the IMC board, or the harness between the LGC board and the switching power supply open-circuited?

NO  
YES → Reconnect the connector. Replace the harness.

Is LED (D17) on the LGC board lit? Is the output voltage from the 12V-power supply normal?

NO  
YES → Check the power supply system and replace the switching power supply.

1. Replace the image quality sensor.
2. Replace the LGC board.
3. Replace the IMC board.

**[CE2] Image quality sensor abnormal (no pattern level abnormal)**

1. Check that the transfer belt unit is fully raised.
2. Check that the transfer/transport unit is securely inserted.
3. Check for any abnormal stain, large flaw or break on the transfer belt surface.
4. Check that the drum and transfer belt are operating. If abnormal, correct any mechanical problem.

Is any of the connectors J113, J114, J115, J119 or J123 on the LGC board disconnected?

Is the connector J182 on the IMC board disconnected?

Is the harness between the LGC board and the IMC board open-circuited?

Is the connector of the image quality sensor disconnected or stained?

Is the harness between the LGC board and the image quality sensor open-circuited?

Is the main high-voltage transformer connector disconnected?

Is the harness between the LGC board and the main high-voltage transformer open-circuited?

Is the transfer transformer connector disconnected?

Is the harness between the LGC board and the transfer transformer open-circuited?

Is any of the high-voltage contact points of the transfer belt unit in faulty contact? Is any contact points stained?

Is the harness of the main high-voltage transformer or the transfer transformer disconnected or open-circuited?

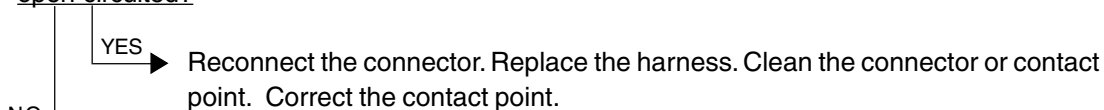

Is LED (D17) on the LGC board lit? Is the output voltage from the 12V-power supply normal?

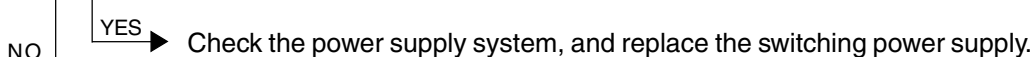

1. Replace the image quality sensor.
2. Replace the LGC board.
3. Replace the IMC board.

**[CE4] Image quality control test pattern abnormal**

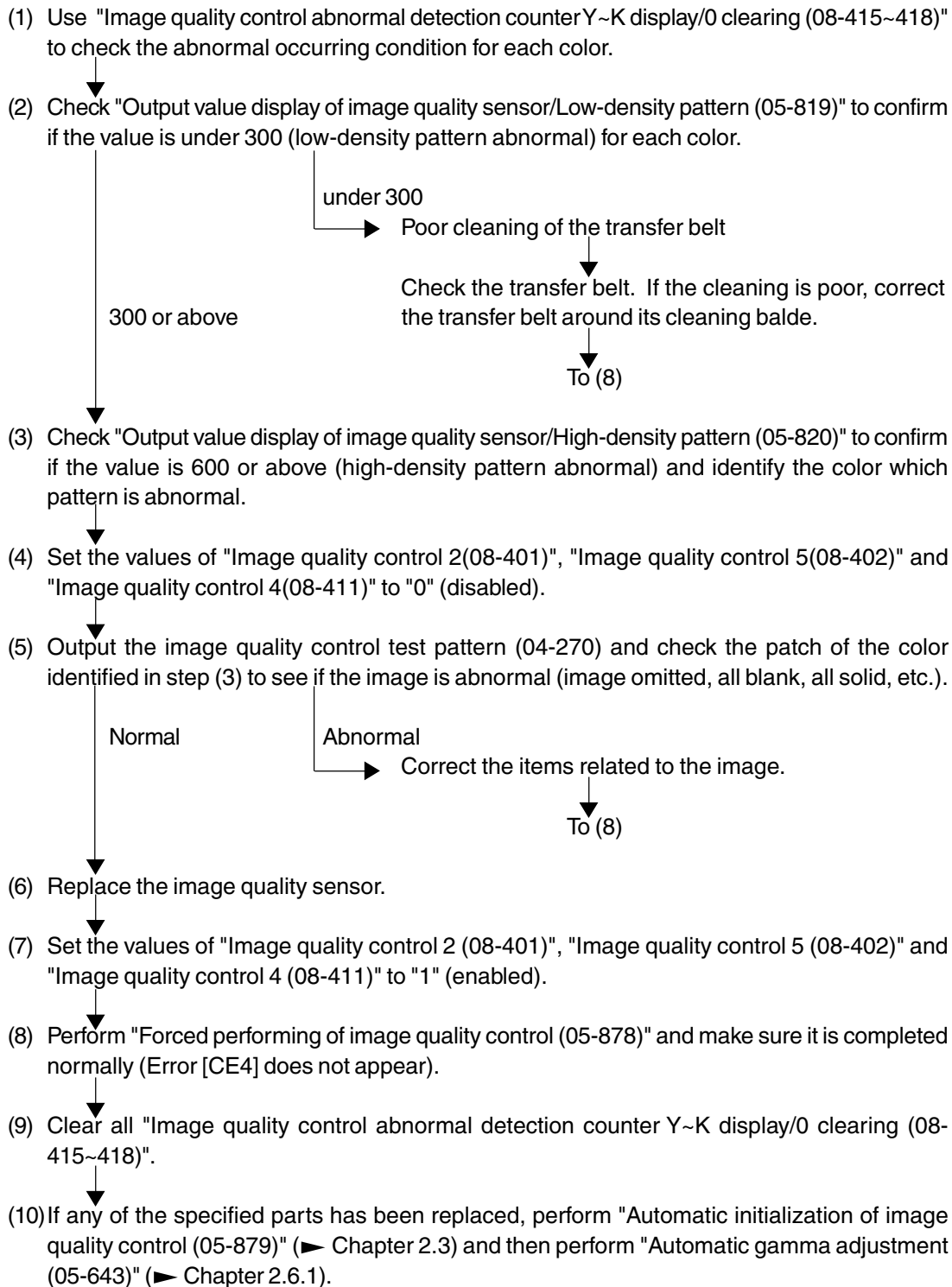

**[CE5] Temperature/humidity sensor upper-limit abnormal**

Is the harness between the LGC board and the temperature/humidity sensor disconnected ?  
Is the connector J108 on the LGC board or the connector of the temperature/humidity sensor disconnected ?

NO ↓  
YES → Reconnect the connector. Replace the harness.

1. Replace the temperature/humidity sensor.
2. Replace the LGC board.

**[CE6] Drum thermistor Y abnormal**

**[CE9] Drum thermistor K abnormal**

Is the harness between the LGC board and the drawer connector for EPU disconnected ?  
Is the harness inside of the EPU and the harness of the drum thermistor Y or K disconnected ?  
Is the connector J120 on the LGC board, or the connector of the drum thermistor Y or K disconnected ?

NO ↓  
YES → Reconnect the connector. Replace the harness.

1. Replace the drum thermistor Y or K.
2. Replace the LGC board.



## [CF1] Color registration control abnormal

<Check of the status of color registration sensor error>

1. While pressing [0] and [5] simultaneously, turn the power ON.
2. Enter [461] with digital keys and press the [START] key.
3. The color registration control result is displayed in four values (Y(0), M(1), C(2), K(3)).
4. Check the value for Y(0) displayed in 3..

When [CF1] has occurred, a value from 1 to 15 is displayed (normal if 0 or 16 or above).

1-14: Data error (color registration sensor is normal)

15: Reading error of color registration test pattern

<Disabling the color registration control>

5. While pressing [0] and [8] simultaneously, turn the power ON.
6. Enter [742] with digital keys and press the [START] key.
7. Set the color registration control setting to "1" (manual).
8. Enter [743] with digital keys and press the [START] key.
9. Set the color registration control during the warming-up to "0" (disabled).
10. Turn the power OFF.

<Check by the forced performing of color registration control >

11. While pressing [0] and [5] simultaneously, turn the power ON.
12. Enter [407] with digital keys and press the [START] key. → (Forced performing of color registration control)

\* At this time, use a digital tester to monitor the test point TP91 (front color registration sensor output) and TP93 (rear color registration sensor output) on the LGC board.

– If the outputs are normal –

Before starting the forced performing of color registration control, a voltage of approximately 0.7V DC is displayed.

After starting it, the voltage changes to approximately 4.4V DC, and this may drop instantaneously down to 0.7V DC. (There may be no fluctuations in voltage, depending on the reaction speed of the digital tester.)

When the forced performing of color registration control is finished, the voltage returns to approximately 0.7V DC.

Voltage before forced performing of color registration control

DC 0.7V	Normal
DC 0V	Check if the harness between the LGC board and the color registration sensor or the harness between the LGC board and the IMC board is open- or short-circuited. Check if any of the connectors (J182 on the IMC board, J113 and J114 on the LGC board) or the color registration sensor connector is disconnected. If there is no abnormality, check the color registration sensor.
DC 5V	Check if the harness between the LGC board and the color registration sensor is open- or short-circuited. Check if any of the the connectors (J113 and J114 on the LGC board) or the color registration sensor connector is disconnected.
DC 4.4V	Check if the harness between the LGC board and the color registration sensor or the harness between the LGC board and the IMC board is open- or short-circuited. Check if any of the connectors (J182 on the IMC board, J113 and J114 on the LGC board) or the color registration sensor connector is disconnected. If there is no abnormality, check the color registration sensor.

Voltage during forced performing of color registration control

Normally DC 4.4V. Instantaneously may drop down to 0.7V DC	
Normally DC 0.7V	Check if there is any charge abnormality or exposure errors onto the photoconductive drum (errors in the laser optical unit). Follow the next check item 13. and after.
Normally DC 4.4V	Reading error of color registration test pattern. Follow the next check item 13. and after.

<Check by the grid pattern>

13. While pressing [0] and [5] simultaneously, turn the power ON.

14. Enter "1" with digital key and press the [PRINTER/NETWORK] key.

15. Check the output grid patterns of yellow, magenta, cyan and black if there is image density difference among the front/center/rear areas or abnormality in the overall image.

\* At this time, there is no problem even if the Y, M, C and K grid patterns are out of alignment.

– If there is difference in tonal balance between the front and rear areas –

- Check the state of contact of the photoconductive drum and the transfer belt.
- Check the quantity of developer (check whether developer material is properly supplied onto the surface of the developer sleeve).

– If there is any streak of yellow, magenta, cyan or black streak in the secondary-scanning direction –

- Check if there is any stain or dust on the main charger wire that corresponds to the color of the streak.

– If there is any white streak in the secondary-scanning direction –

- Check if there is any stain or dust on the slit glass of the laser optical unit.

– If the entire page is solid in a specific color –

- Abnormality of the main high-voltage transformer corresponding to that color or abnormality of the laser optical unit.

Of the four main high-voltage transformers, exchange the main high-voltage transformer considered to be abnormal for other main high-voltage transformer considered to be normal, and then output the chart again.

If the solid color over the entire page changes as the result of exchanging the main high-voltage transformer, that main high-voltage transformer is abnormal.

If the solid color over the entire page does not change, check whether there is any disconnection of the harness between the LGC board and the main high-voltage transformer or whether the power supplies to the main charger (disconnection of high-voltage harness or contact defects). If there is no problem, check the laser optical unit.

If the density is low on both front and rear sides and any of the above abnormalities are not found, make the following check.

<Check by the gradation pattern>

16. While pressing [0] and [5] simultaneously, turn the power ON.

17. Enter "4" with digital key and press the [PRINTER/NETWORK] key.

18. Check the output gradation images for gamma adjustment if there is any abnormality in the gradation of yellow, magenta, cyan and black.

– If there are any abnormalities –

(1) Check if the photoconductive drum and transfer belt are operating. If not, correct any mechanical problems.

(2) Check if the transfer belt unit is raised fully upward.

(3) Check if the transfer/transport unit is inserted securely.

(4) Check the surface of the transfer belt for any abnormal stain, large flaw or break.

(5) Check if the connector of the transfer transformer is disconnected.

(6) Check if any of the high-voltage harnesses of the main high-voltage transformer/transfer transformer is disconnected.

(7) Check the harness between the LGC board and the transfer transformer if it is open-circuited.

(8) Check the high-voltage contacts of the transfer belt unit if they are contacting properly or if they are not dirty.

(9) Check if any of the high-voltage harnesses is disconnected.

(10) Check if the connector J113, J114 or J119 on the LGC board is disconnected.

(11) Check if the connector J181, J182, J185 or J188 on the IMC board is disconnected.

(12) Check if the harness between the LGC board and the color registration sensor is open-circuited.

(13) Check if the color registration sensor connector is disconnected.

(14) Check if any of the main high-voltage transformer connectors is disconnected.

(15) Check if any of the harnesses between the LGC board and the main high-voltage transformers is open-circuited.

(16) Replace the transfer transformer.

(17) Replace the main high-voltage transformer.

19. Check the sensor detection area of the transfer belt for any damage, and if damaged, replace the transfer belt.

20. Check the emitting/receiving area of the color registration sensor if it is not dirty.

\* Be sure to do the following after having made checks and corrections:

1. While pressing [0] and [8] simultaneously, turn ON the power.

2. Enter [742] with digital keys and press the [START] key.

3. Set the color registration control setting to "0" (automatic).

4. Enter [743] with digital keys and press the [START] key.

5. Set the color registration control during warming-up setting to "1" (enabled).

6. Turn OFF the power.

## 4.1.20 Other service call (2)

### [F07] Communications error between system-CPU and LGC-CPU

1. Check if the SYC board is securely connected to the MTH1 board.
2. Check if the IMC board is securely connected to the MTH1 board.
3. Check if the IMC board connector J182 is disconnected.
4. Check if the LGC board connector J113 is disconnected.
5. Check if the harness between the IMC and LGC boards is open-circuited.
6. Check the version of FROM on the SYS board.
7. Check the version of MROM on the LGC board.
8. Check the version of IMC-ROM on the IMC board.
9. Replace the SYS board.
10. Replace the IMC board.
11. Replace the LGC board.

### [F10] HDD formatting error

- (1) Format the HDD. (Enter "2" into 08-690)
- (2) Check if the HDD is mounted.
- (3) Check if the specified HDD is mounted.
- (4) Check if the connector pins of the HDD are bent.
- (5) Check if the power supply connector is disconnected.
- (6) Check if the connector J144 on the SYS board is disconnected.
- (7) Replace the HDD.
- (8) Replace the SYS board.
- (9) Replace the harness.

\* When changing a HDD, do the following operations after replacing a new one.

#### 1. Formatting of the HDD

<Procedure>

- (1) Turn ON the power while the digital keys [0] and [8] are pressed simultaneously.
- (2) Confirm that "Test Mode" is displayed on the control panel. Enter the code "690" and press the [START] key. The display changes to "System Mode".
- (3) Enter "2" and press the [SET] or [INTERRRUPT] key.
- (4) [WAIT] is displayed.
- (5) Turn OFF the power after the message [REBOOT THE MACHINE] is displayed.

#### 2. Downloading of the UI data

(▶ Chapter. 5)

#### **[F09] [F11] [F12] Communications error between system-CPU and scanner-CPU**

1. Check if the IMG board connector J161 is disconnected.
2. Check if the SCM board connector J1 is disconnected.
3. Check if the harness between the IMG and SCM boards is open-circuited.
4. Check if the IMG board is securely connected to the MTH1 board.
5. Check if the SYS board is securely connected to the MTH1 board.
6. Check the version of FROM on the SYS board.
7. Check the version of FROM on the SCM board.
8. Replace the SYS board.
9. Replace the IMG board.
10. Replace the SCM board.

#### **4.1.21 Image processing related service call**

##### **[F51] Communications error between system-CPU and AI board during pre-scanning**

1. Check if the AI board is securely connected to the connector on the IMG board.
2. Check if the IMG board is securely connected to the MTH1 board.
3. Check if the SYS board is securely connected to the MTH1 board.
4. Check if FROM is mounted on the IC8 on the AI board.
5. Check if FROM is mounted in the proper direction on the AI board.
6. Replace the AI board.
7. Replace the IMG board.
8. Replace the SYS board.
9. Replace the MTH1 board.

\* Service call [F51] occurs only when copying with the original mode "AI" selected. The other original modes are operable.

## 4.2 Troubleshooting of Image

(1) Color deviation

<Symptoms>

Original mode	Location	Phenomena
All modes	Color blurred in outline of white text or illustration on a colored background	Color deviation
Text mode Text/Photo mode	Outline in black text on a colored background	White void
Photo mode Map mode	Color blurred in outline of line or text	Color deviation

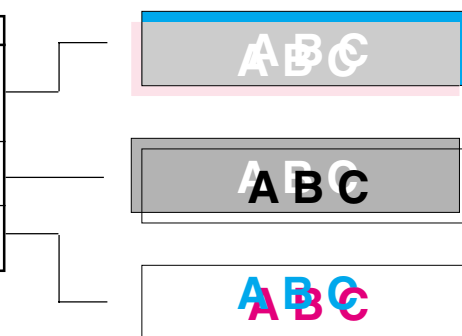

Section	Step	Cause			Check Item	Criteria	Measures
		Main-Classification	Sub-Classification	Specific-Classification			
	1				Output the built-in grid pattern on A3/LD.	Perform following procedures from 2 and after.	
Color registration control	2	Control error or poor optimization			Check the grid pattern.	Are the grid lines out of alignment?	Forced performing of color registration control
Paper transport system	3	Paper transport speed in registration section	Low speed	Adjustment error	Check the grid pattern.	Are the lines of the primary-scanning direction out of alignment and parallel in order of Y-M-C-K from the exit side in the whole image?	Readjust registration motor speed. * See P. 4-68.
			Low speed	Registration roller aging change			Readjust registration motor speed. * See P. 4-68.
			Low speed	Registration roller life (worn out)	Check the condition of registration rubber roller surface.	Does the roller surface lack in friction and is it slippery?	Replace the registration roller.
			High speed	Adjustment error	Check the grid pattern		Readjust registration motor speed. * See P. 4-68.
	4	Paper transport speed in fuser unit	High speed	Adjustment error	Check the grid pattern.	Are the lines of the primary-scanning direction out of alignment and parallel in order of Y-M-C-K from the exit side in the latter half of the image?	By fine adjustment (a few steps at a time), slacken paper slightly, not tighten it (to a straight line in side view) between the transfer belt and fuser unit.
					Feed paper with the front door open and check the paper transport between the transfer belt and fuser unit. No problem is in normal paper mode, but in the thick paper 3 mode, deviation occurs in (Y)MCK order, at the trailing edge of A3/LD sheet.	Is paper tightened?	
Drum drive system	5	Drum rotation	Unstable	Motor abnormal	Check drum motor operation in the test mode (03).		Troubleshoot the drum drive system.
				Control circuit abnormal	Check drum motor operation in the test mode (03).		Troubleshoot the drum drive system.
		Drum motor rotation speed	Inadequate	Adjustment error	Re-check values set for drum motor rotation speed.	Is the value significantly different from the default value 1787? (The value shifts one step each in connection with transfer belt speed.)	Reset drum motor speed to 1787.
					Drum coupling	Loose coupling	Check the grid pattern.
			Damage			Replace the couplings.	
			Deformation			Replace the couplings.	
Transfer belt system	6	Transfer belt	Deformation or damage		Check the grid pattern.	Is the misalignment of the secondary-scanning direction varied?	Replace the belt (troubleshoot the transfer belt).
					Check the condition of transfer belt edge.	Is the belt edge damaged or folded?	
		Drive roller	Slipping	Stain	Check the grid pattern.	Is the misalignment of the primary-scanning direction varied?	Clean it.
					Check the condition of roller surface.	Is there any stain?	
Large driving load	Used toner	Over capacity	Check the grid pattern.	Is the misalignment of the primary-scanning direction varied?	Troubleshoot the used toner system.		
			Cleaning blade	Peeling		Replace the cleaning blade (troubleshoot the transfer belt).	
Laser optical unit	7	Tilt adjustment mechanism	Adjustment mechanism defect		Check the grid pattern.	Are the lines of the primary-scanning direction out of alignment at front or rear?	Replace the unit.
		Reflection mirror warp			Check the grid pattern.	Are the lines of the primary-scanning direction warped?	Replace the unit.
		f) lens characteristic defect			Check the grid pattern.	Are the lines of the primary-scanning direction warped?	Replace the unit.

(2) Uneven pitch and jitter image

<Symptoms>

Original mode	Location	Phenomenon
All modes	Occurs cyclically at right angles to paper feeding direction	Uneven pitch

Feeding direction

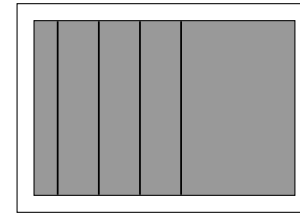

Section	Step	Cause			Check item	Criteria	Measures
		Main-Classification	Sub-Classification	Specific-Classification			
	1				Output the built-in halftone and grid patterns on A3/LD.	Perform following procedures from 2 and after.	
Paper transport syetem	2	Paper transport speed in registration section	Low speed	Adjustment error	Check the grid pattern.	Is there uneven pitch extending 2.5 mm to 3 mm within an area about 130 mm wide from the leading edge of the image?	Readjust registration motor rotation speed. * See P. 4-68.
			Low speed	Registration roller aging change			Readjust registration motor rotation speed. * See P. 4-68.
			Low speed	Registration roller life (worn out)	Check the condition of registration rubber roller surface.	Does the roller surface lack in friction and is it slippery?	Replace the registration roller.
			High speed	Adjustment error	Check the grid pattern.		Readjust registration motor rotation speed. * See P. 4-68.
	3	Paper transport speed in fuser unit	High speed	Adjustment error	Check the grid pattern. Feed paper with the front door open and check the paper transport between the transfer belt and fuser unit.	Is there uneven pitch extending approx. 2.9 mm within an area about 150 mm wide from the trailing edge of the image? Is paper tightened?	By fine adjustment (a few steps at a time), slacken paper slightly, not tighten it (to a straight line in side view) between the transfer belt and fuser unit.
Drum drive system	4	Drum	Surface condition		Check the halftone pattern.	Are there uneven pitches approx. 94 mm in the whole image?	Replace the drum.
				Damage	Check the drum surface.	Is there any damage?	Replace the drum.
				Attached foreign matter	Check the drum surface.	Is there any attached foreign matter?	Clean or replace the drum.
	5	Drum rotation	Unstable	Motor abnormal Control circuit abnormal	Check drum motor operation in test mode (03). Check drum motor operation in test mode (03).		Troubleshoot the drum drive system. Troubleshoot the drum drive system.
		Drum motor rotation speed	Inadequate	Adjustment error	Re-check values set for drum motor rotaion speed.	Is the value significantly different from the default value 1787? (The value shifts one step each in connection with transfer belt speed)	Reset drum motor rotation speed to 1787.
		Drum coupling	Loose coupling		Check the halftone pattern.		Re-fasten the screws.
	Damage					Replace the couplings.	
	Deformation					Replace the couplings.	
Transfer belt system	6	Drive unit	Timing belt	Tension looseness	Check the halftone pattern.	Are there uneven pitches approx. 2.5 mm in the whole image?	Re-fasten the screws to fix the tension arm.
	7	Transfer belt	Deformation or damage		Check the halftone pattern. Condition of transfer belt edge.	Are there uneven pitches approx. 75 mm in the whole image? Is the belt edge damaged or folded?	Replace the transfer belt (troubleshoot the transfer belt).
				Drive roller	Slipping	Stain	Check the halftone pattern. Check the condition of roller surface.
		Large driving load	Cleaning blade	Used toner Peeling	Over capacity	Check the halftone pattern.	Are there uneven pitches approx. 75 mm in the whole image?
Laser optical unit	8	Polygonal mirror	Surface inclined	Deformation	Check the halftone pattern.	Are there uneven pitches approx. 0.3 mm in the whole image?	Replace the unit.



\* Fine adjustment of registration roller paper transport speed

The optimized value against jitter and color misalignment is not always obtained because fine error is generated in automatic adjustment.

If uneven color is generated in the secondary-scanning direction of the image and further adjustment is necessary, perform the following procedure from 1. to 7..

1. Start up with the test print mode (04).

2. Select the A3/LD size paper.

3. Enter the code [234] (select the halftone pattern).

4. Select [M] on the control panel and press the [START] key. Since the halftone image is to be continuously printed out, press the [STOP] key when the first sheet starts being fed, to make only one print.

5. Repeat procedures 3. and 4. above to print out the halftone image of cyan (C) and black (K).

6. Judge the paper transport speed status by image.

Uneven color of 2.5mm pitch in halftone image is generated. → Paper transport speed is low.

Uneven color is partially generated at 120mm with magenta, 195mm with cyan and 270mm with black from the trailing edge. → Paper transport speed is high.

7. Adjust "Fine adjustment of registration motor rotation speed (05-410)" by one step, assuming the speed status from the grid pattern image and the image criteria in procedure 6. above. After adjusting, repeat procedures 1. to 6. above. When the step value decreases, the paper transport speed becomes higher. When the step value increases, the paper transport speed becomes lower.

The speed should not be too low or too high because either case has harmful effect. (The step value should be approx. within  $2853 \pm 30$ .)

**Note:** First perform the adjustments "Fine adjustment of drum motor/transfer belt motor and fuser motor (05-401 to 402)", before proceeding to "Fine adjustment of registration motor rotation speed (05-410)".

If the adjustment "Registration motor speed adjustment (05-406)" is performed, the values of "Fine adjustment of registration motor rotation speed (05-410)" and "Fine adjustment of feed motor rotation speed (05-404)" are changed. Therefore, perform the settings of 05-404 again.

(3) Poor image density, color reproduction and gray balance

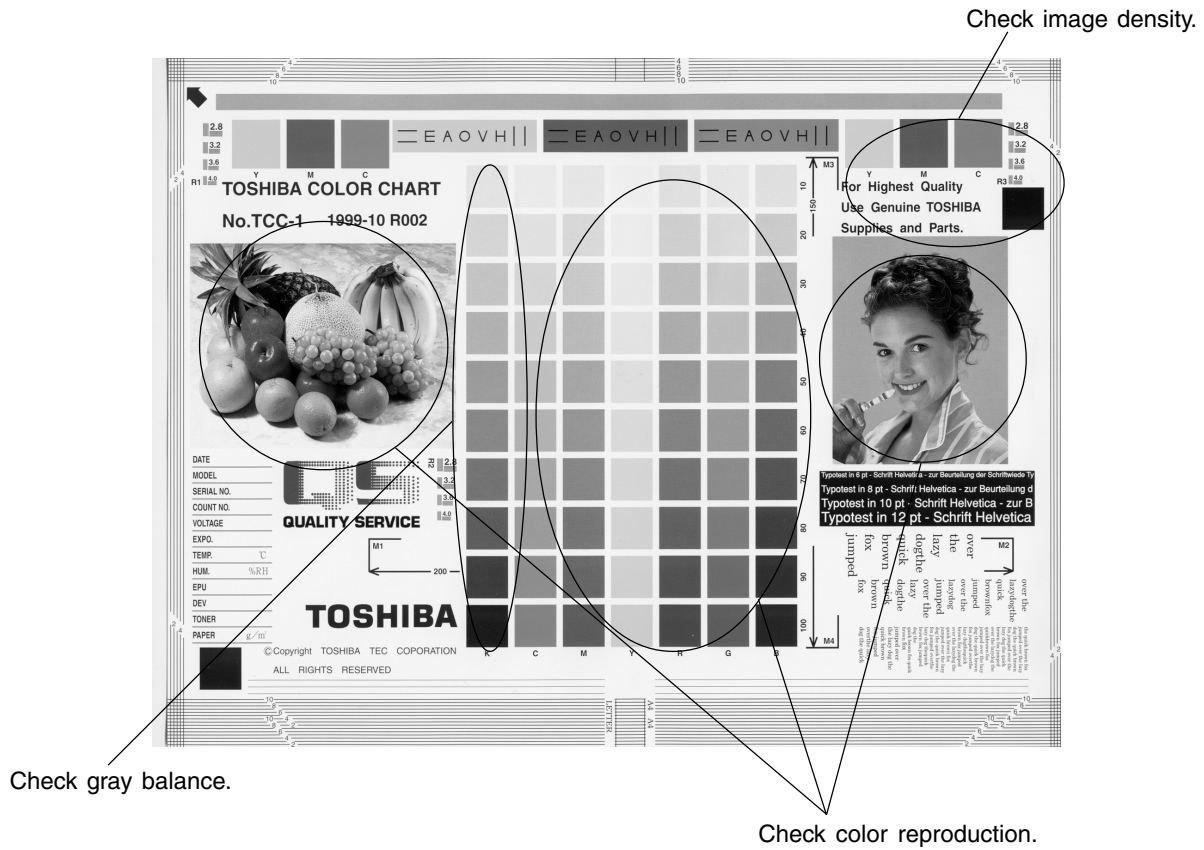

Cause/Section	Step	Check items	Measures	Remarks
Density/Color reproduction/Gray balance	1	Check the image density/color reproduction/gray balance.	Perform the automatic gamma adjustment.	
Printer section *1	2	Check the printer output image.	Output the test print pattern for each color (04-231) and check it.	See step 6 if defect occurs.
Parameter adjustment value *2	3	Check the image processing parameters.	Adjust the color balance. Adjust the image density.	
Scanner	4	Is the original glass or mirrors or lens dirty?	Clean it.	
Printer density abnormal *1	5	Check the density of printer output image.	Perform the forced performing image quality control (05-878). Output the test print pattern in each color (04-231) and check it.	
Printer output image abnormal *2	6	Is there any faded image (low density)?	Perform troubleshooting procedures against the faded image.	
		Is there any fog in the background?	Perform troubleshooting procedures against the background fogging.	
		Is there any blotch image?	Perform troubleshooting procedures against the blotch image.	
		Is there any poor transfer?	Perform troubleshooting procedures against the poor transfer.	
		Is there any poor cleaning of the transfer belt?	Correct the transfer belt area. (Refer to Service Manual)	
		(Check inside the copier.)		

\*1 When adjusting printer section, perform "Forced performing of image quality control " and then "automatic gamma adjustment".

\*2 When adjusting parameters, perform "Automatic gamma adjustment".

#### (4) Background fogging

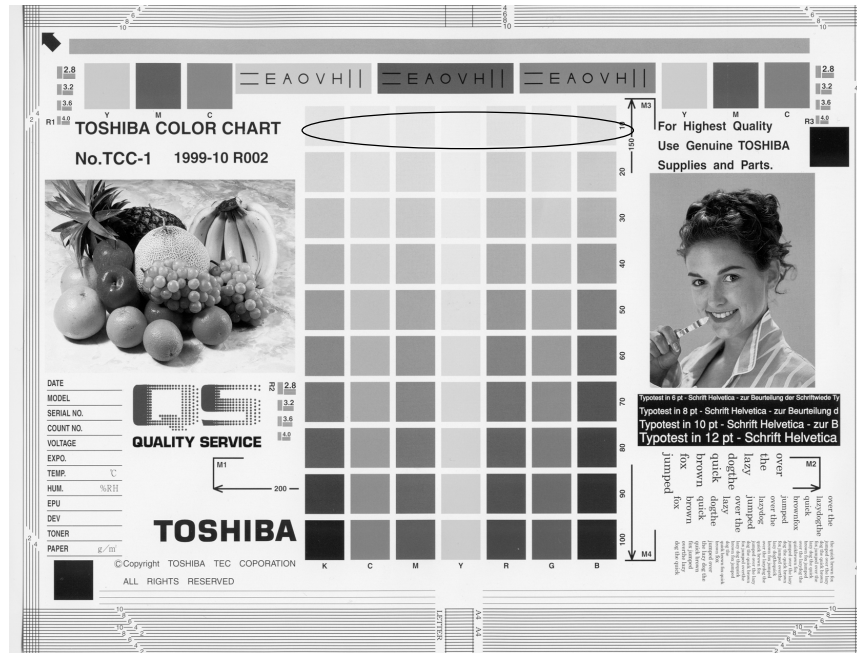

Cause/Section	Step	Check items	Measures	Remarks
Density reproduction	1	Check the gradation reproduction.	Perform the automatic gamma adjustment.	
Printer section	2	Check the printer output image.	Output the test print pattern for each color (04-231) and check it.	See step 5 if defects occur.
Parameter adjustment value	3	Check the image processing parameters.	Check the value of offset amount of processing background.	
	4	Adjust the image processing parameters.	While checking the above encircled image, adjust the reproduction level by the offset amount adjustment of processing background.	
Scanner	5	Is the original glass or mirrors or lens dirty?	Clean it.	
Auto-toner	6	Is the auto-toner sensor normal?	Check the operation of auto-toner sensor and readjust.	
	7	Is the toner supply operating constantly?	Check the motor and circuits.	
Main charger output	8	Is the main charger output normal?	Check the circuits. *	
Developer bias	9	Is the developer bias proper?	Check the circuits. *	
Developer unit	10	Is the contact between the drum and developer material proper?	Check the doctor-to-sleeve gap and pole position.	
Developer material	11	Is the developer's life finished?	Replace developer material.	
Drum cleaning blade	12	Is it cleaned properly?	Check drum cleaning blade pressure.	
Toner dusting	13	Is toner accumulated on the seals of the developer unit?	Remove toner and clean.	

\* If the main charger and developer bias outputs seem to be abnormal, exchange the main high-voltage transformer of the color likely to be abnormal for another transformer of another color likely to be normal, and then, output the chart again.

If the same color remains abnormal, check if there is any disconnection of harness between the LGC board and the main high-voltage transformer, disconnection of high-voltage harness, the power supply abnormal, or stain on the main charger wire.

If the color changes as the result of exchanging the main high-voltage transformer, this fogging trouble is caused by the main high-voltage transformer defect. Therefore, replace the main high-voltage transformer of the abnormal color with new one.

After this checking, return the other main high-voltage transformer back to the original color position.

(5) Moire/lack of sharpness

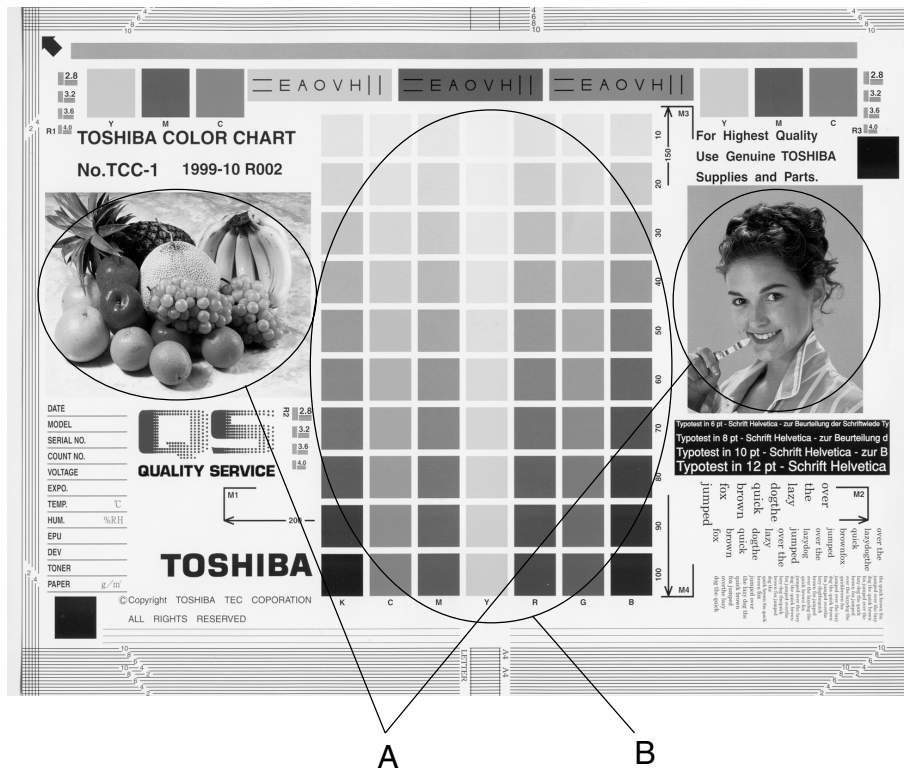

Moire

Cause/Section	Step	Check items	Measures	Remarks
Density reproduction	1	Check the gradation reproduction.	Perform the automatic gamma adjustment.	
Parameter adjustment value	2	Check the image processing parameters.	Check the sharpness adjustment value.	
	3	Adjust the image processing parameters.	While checking the above encircled images A and B, decrease moire by sharpness adjustment.	
Printer section	4	Check the printer output image.	Output the test print pattern (04-231) for each color and check it.	When defects occur, perform the corresponding troubleshooting procedures.

Lack of sharpness

Cause/Section	Step	Check items	Measures	Remarks
Density reproduction	1	Check the gradation reproduction.	Perform the automatic gamma adjustment.	
Parameter adjustment value	2	Check the image processing parameters.	Check the sharpness adjustment value.	
	3	Adjust the image processing parameters.	While checking the above encircled image A, increase sharpness by sharpness adjustment.	
Printer section	4	Check the printer output image.	Output the test print pattern (04-231) for each color and check it.	When defects occur, perform the corresponding troubleshooting procedures.

## (6) Toner offset



Toner offset (Shadow image appears approx. 220 mm behind the high density image.)

Cause/Section	Step	Check items	Measures	Remarks
Density	1	Is the density too high?	Perform the automatic gamma adjustment.	
Fuser unit	2	Is the pressure between the fuser roller and lower heat roller proper?	Check the pressure removal parts and pressure mechanism.	
	3	Is the thermostat in contact?	Establish its contact.	
	4	Is there scratch on the fuser belt or lower heat roller surface?	Replace the fuser belt or the lower heat roller.	
	5	Is the fuser belt or lower heat roller life ended?	Replace the fuser belt or the lower heat roller.	
	6	Are the upper/lower heat rollers temperature proper?	Check and correct the control circuit.	
	Paper	7	Check the paper type and mode.	Select proper paper type and mode.
8		Is non-recommended paper used?	Use recommended paper.	
Developer material	9	Is the specified developer used?	Use the specified developer and toner.	
Scanner	10	Are mirrors or original glass or lens dirty?	Clean them.	
Printer section	11	Check the printer output image.	Output the test print pattern (04-231) and check it.	See steps 12 and 13 if defect occurs.
Printer density abnormal*	12	Is the density of printer output image too high?	Perform the image quality control forcibly (05-878). Output and check the test print pattern (04-231).	Repeat 2-3 times if necessary.
Image quality control	13	Is the control activated?	Check the image quality control related codes.	

\* When adjusting printer section, perform "image quality control forced performing" and then "automatic gamma adjustment".

(7) Blurred image

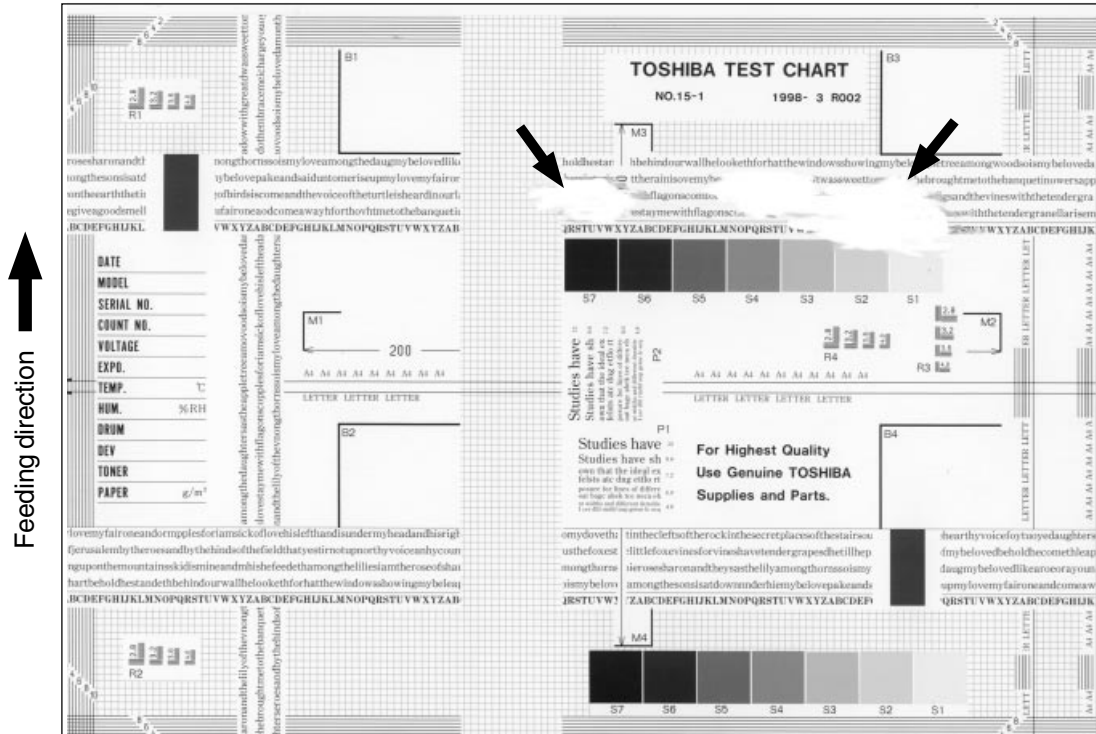

Cause/Section	Step	Check items	Measures
Scanner	1	Is the scanner bedewed?	Clean it.
Drum	2	Is the drum bedewed or dirty?	Wipe the drum with dry cloth. * Be sure never use alcohol or other organic solvents because they have bad effect on the drum.

(8) Poor fusing

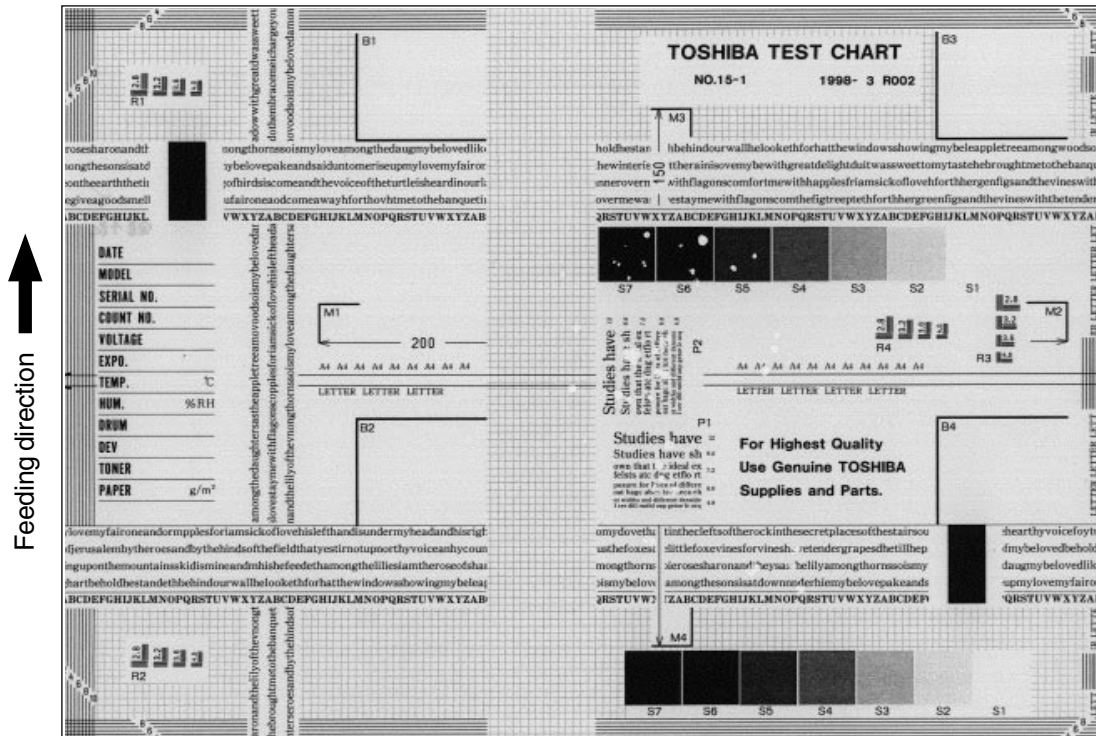

Cause/Section	Step	Check items	Measures
Heater lamp unlighted	1	Is poor contact at the terminal point?	Correct it.
	2	Is the heater lamp open-circuited?	Replace it.
Pressure between fuser roller and lower heat roller improper	3	Are the pressure springs working properly?	Check/adjust the pressure springs.
Thermistor, LGC board	4	Is the temperature of upper/lower heat rollers too low?	Check/correct the related circuit.
Paper	5	Is paper damp?	Change paper.

(9) Blank copy

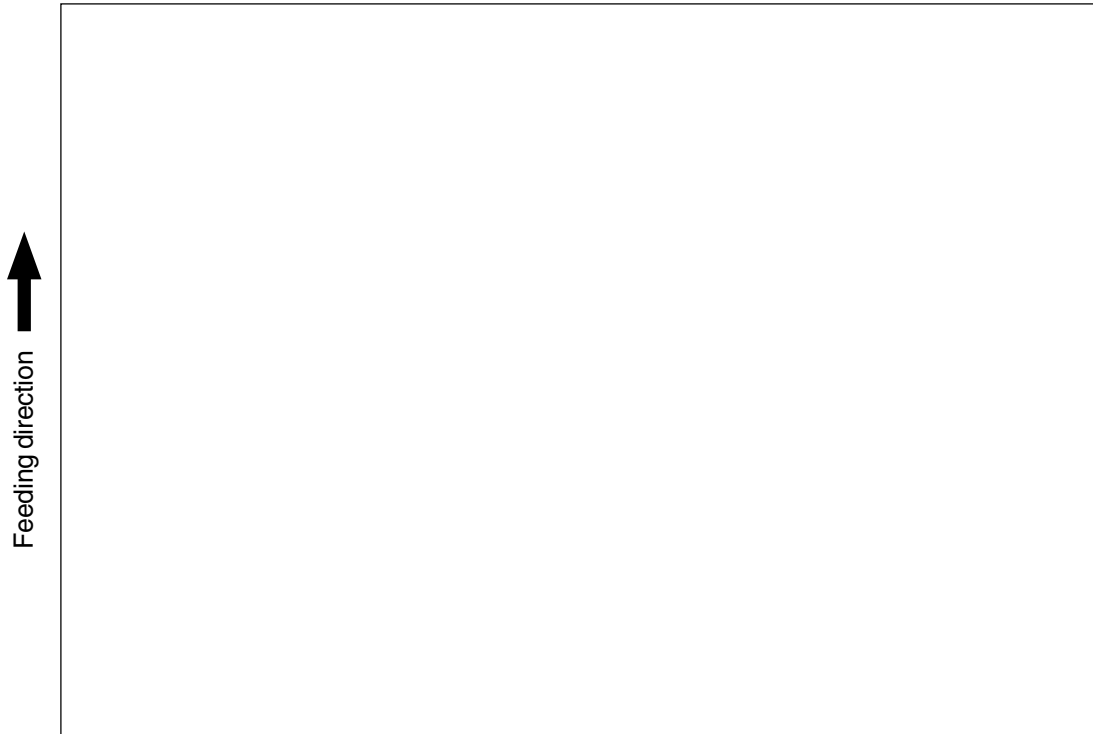

Cause/Section	Step	Check items	Measures
High-voltage transformer (transfer roller/ developer bias)	1	Is the high-voltage transformer output defective?	Adjust the output and correct the circuit, or replace the transformer.
Processing unit (EPU)/ developer unit set position	2	Is the processing unit (EPU) or the developer unit installed securely?	Check/correct the developer sleeve coupling engaging. Check the EPU sliding mechanism.
Developer drive system	3	Do the developer sleeve and mixer rotate?	Check/correct the developer drive system.
Developer material	4	Is developer material properly transported?	Remove foreign matter from developer material, if any.
Developer pole position	5	Is there any magnetic brush phase error?	Check the developer pole position.
Doctor blade position	6	Is the doctor sleeve gap incorrect?	Adjust the gap with the doctor-sleeve jig.
Drum	7	Is the drum rotating?	Check that the drum shaft is inserted. Check the drum drive system.
Harnesses for SCM, SYS, IMG, IMC and LGC boards	8	Are the connectors securely connected? Is any harness between the boards open-circuited?	Re-connect the connectors securely. Replace the harness.



(10) Solid copy

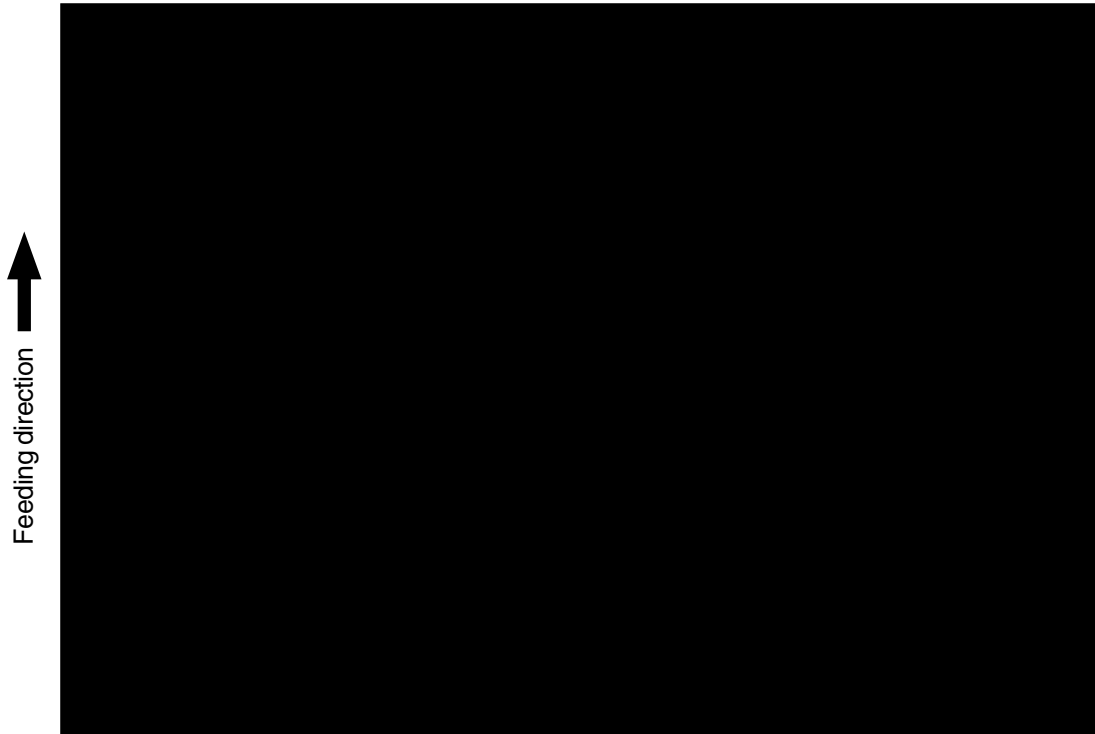

Cause/Section	Step	Check items	Measures
Exposure lamp Inverter	1	Does the exposure lamp light?	Check the contact of the inverter connector. If the inverter does not work, replace it. If the lamp does not work, replace it.
Main charger	2	Is the main charger securely installed?	Reinstall it securely.
	3	Is the main charger wire open-circuited?	Replace it.
High-voltage transformer (Main charger)	4	Is the high-voltage transformer output defective?	Adjust the output and correct the circuit, or replace the high-voltage transformer.
Harnesses for SCM, SYS, IMG, IMC and LGC boards	5	Are the connectors securely connected? Is any harness between the boards open-circuited ?	Re-connect the connectors securely. Replace the harness.
Scanner	6	Is there foreign matter in the optical path?	Remove it.
Bedewing of scanner and drum	7	Is the scanner or the drum bedewed?	Clean the mirrors, lens and drum. Keep the power cord plugged so that the damp heater can work.

(11) White banding (in feeding direction)

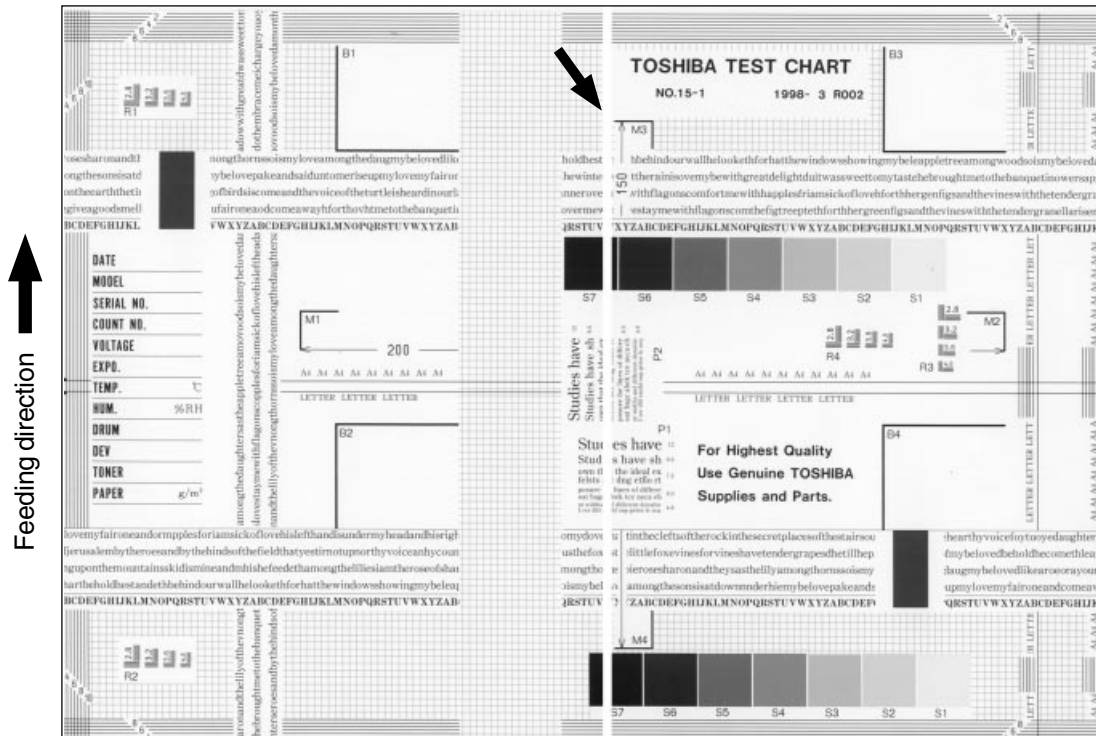

Cause/Section	Step	Check items	Measures
Laser optical unit	1	Is there foreign matter or dust on the slit glass?	Clean the slit glass.
Main charger grid	2	Is there foreign matter on the charger grid?	Remove foreign matter.
Developer unit	3	Is there foreign matter inside the doctor blade?	Remove foreign matter.
	4	Is there foreign matter on the drum seal?	Remove foreign matter.
	5	Is the drum seal of developer unit in proper contact with the drum?	Modify the position of drum seal or replace it.
Drum	6	Is there any abnormalities on the drum surface?	Replace the drum.
Transport path	7	Does the toner image touch foreign matter after transfer, before entering the fuser unit?	Remove foreign matter.
Discharge lamp	8	Has any LED of discharge lamp gone out?	Replace the discharge lamp.
Scanner	9	Is there foreign matter or dust in the optical path	Clean the lens and mirrors.

(12) White banding (at right angles to feeding direction)

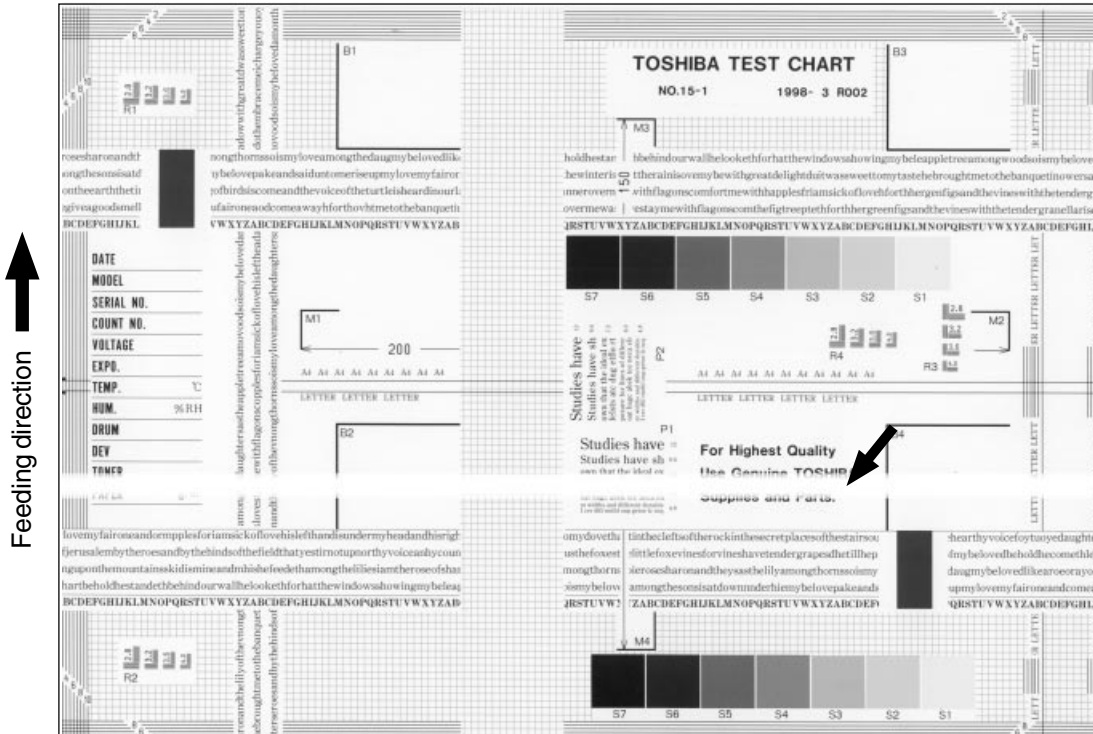

Cause/Section	Step	Check items	Measures
Main charger	1	Is there foreign matter on the charger?	Remove foreign matter.
	2	Is terminal contact poor?	Clean or adjust terminals.
Drum	3	Is there any abnormalities on the drum surface?	Replace the drum.
Discharge lamp	4	Is the discharge lamp lighting properly?	Replace the discharge lamp or clean terminals.
Developer unit	5	Is the developer sleeve rotating correctly? Is there any abnormalities on the sleeve surface?	Check the developer drive system, or clean the sleeve surface.
Drum and scanner drive systems	6	Is the drum or scanner jittery?	Check each drive system.
High-voltage transformer (main charger and transfer roller)	7	Is the high-voltage transformer output defective?	Check/correct any electric leakage and related circuits. If the high-voltage transformer does not work, replace it.

(13) Skew (slantwise copying)

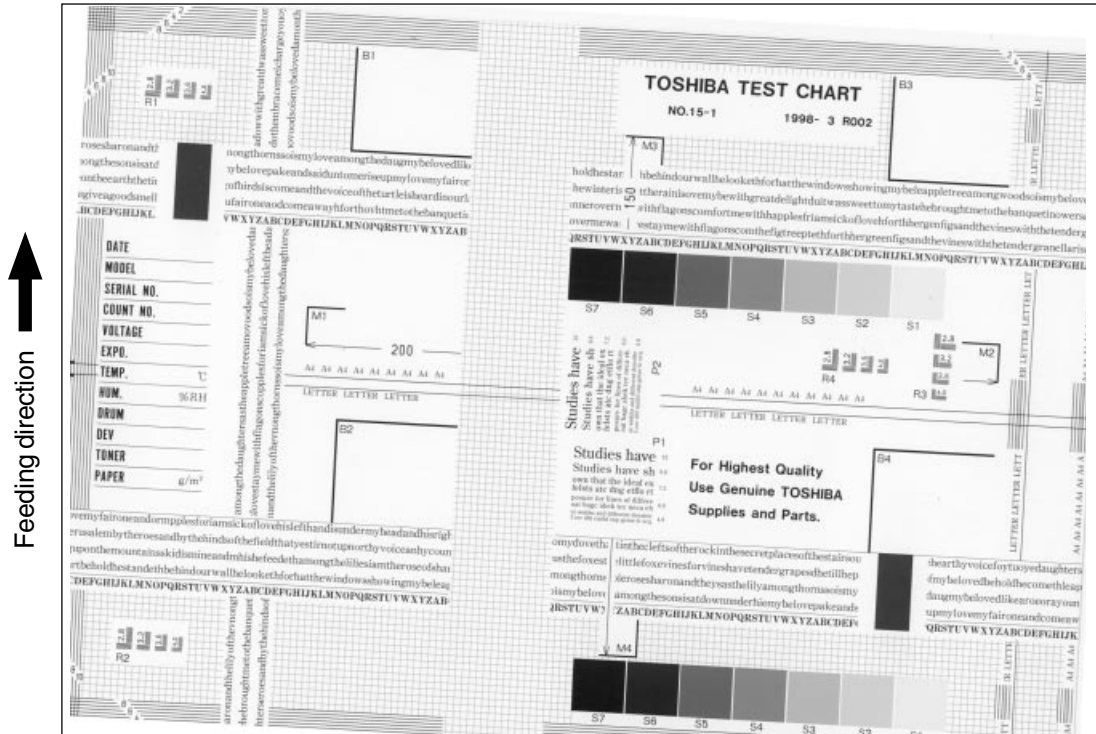

Cause/Section	Step	Check items	Measures
Cassette LCF	1	Is the cassette or LCF properly installed?	Reinstall the cassette or LCF properly.
	2	Is too much paper loaded in the cassette or LCF?	Reduce paper to 600 sheets or less. (1500 sheets or less for LCF)
	3	Is the paper corner folded?	Change the paper direction and reinsert it.
	4	Are cassette or LCF side guides properly set?	Adjust side guides.
Paper feed roller	5	Is the surface of paper feed roller dirty?	Clean the roller surface with alcohol, or replace the roller.
Rollers	6	Is each roller improperly fixed to the shaft?	Check and fasten E-rings, pins, clips and setscrews.
Registration roller	7	Is the registration roller spring out of place?	Mount the spring correctly. Clean the roller if it is dirty.
Pre-registration guide	8	Is the pre-registration guide improperly installed?	Correct it.
Original scale	9	Is the original scale slanted?	Adjust it.

(14) Color banding (in feeding direction)

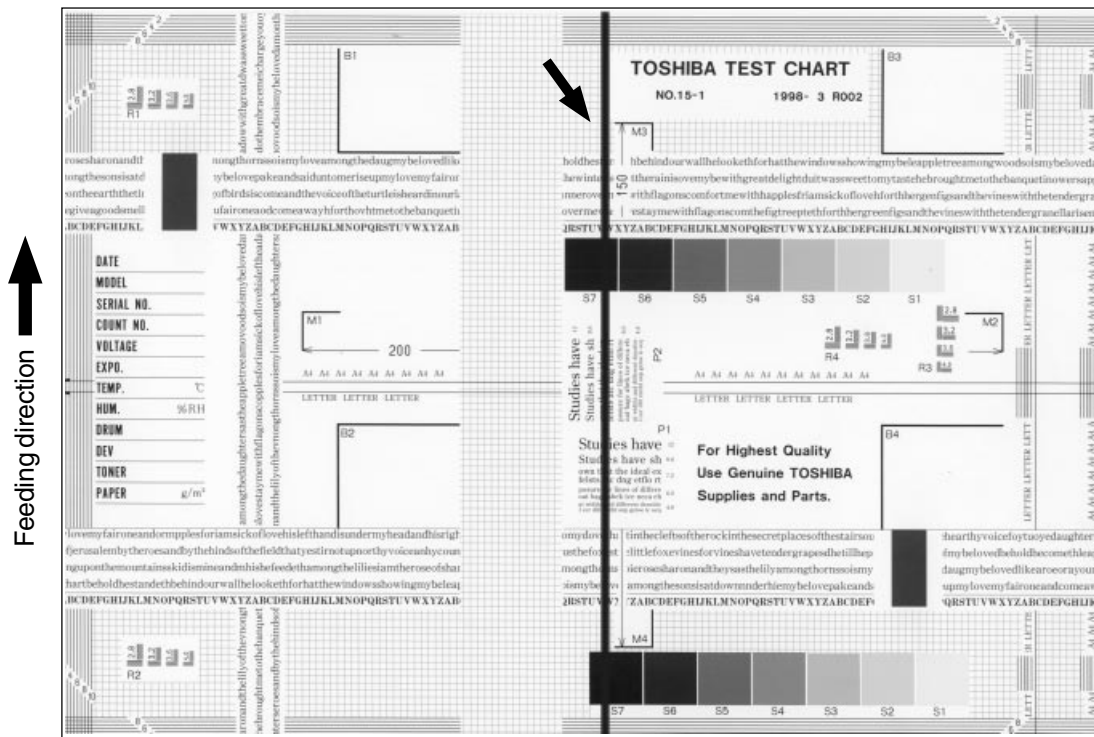

Cause/Section	Step	Check items	Measures
Scanner	1	Is there foreign matter in the optical path?	Clean the slit, lens and mirrors.
	2	Is there dust or stain on the shading correction plate?	Clean the plate.
Main charger	3	Is there foreign matter on the charger grid?	Remove foreign matter.
	4	Is the charger grid dirty or deformed?	Clean or replace the charger grid.
	5	Is there foreign matter on the main charger?	Remove foreign matter.
	6	Is the charger wire dirty or deformed?	Clean or replace the charger wire.
	7	Is there foreign matter inside the charger case?	Remove foreign matter.
	8	Is the inner surface of charger case dirty?	Clean inside.
Cleaner	9	Is there paper dust on the cleaning blade edge?	Clean or replace the paper dust removal brush for the registration roller. Clean or replace the cleaning blade.
	10	Is the cleaning blade contact improper?	Correct it.
	11	Is toner recovery defective?	Clean the toner recovery auger section.
Fuser unit	12	a. Is there dirt or scratches on the fuser belt and lower heat roller surface? b. Is the thermistor dirty?	a. Clean or replace them. b. Clean the thermistor.
Drum	13	Are there scratches on the drum surface?	Replace the drum.
Laser optical unit	14	Is there foreign matter or dust on the slit glass?	Remove foreign matter or dust.

(15) Color banding (at right angles to feeding direction)

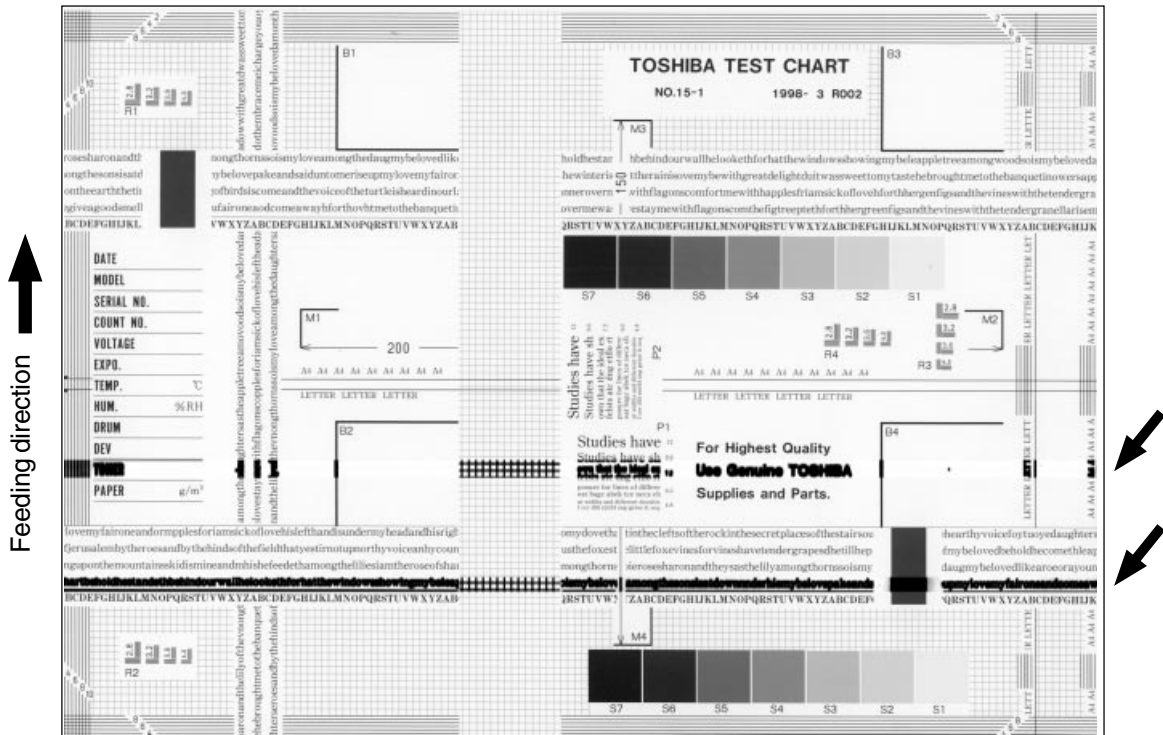

Cause/Section	Step	Check items	Measures
Main charger	1	Is the charger wire dirty or deformed?	Clean or replace the charger wire.
Fuser unit	2	Is the fuser belt, lower heat roller or oil roller dirty?	Clean them.
High-voltage transformer (main charger/transfer roller)	3	Is the high-voltage transformer output defective?	Check the circuit and replace the high-voltage transformer if not working.
Drum	4	Is there deep scratch on the drum surface?	Replace the drum, especially if the scratch has reached the aluminum base.
	5	Are there fine scratches on the drum surface (drum pitting)?	Check and correct the contact of cleaning blade and recovery blade.
Scattered toner recovery roller of developer unit	6	Is electrical continuity secured between the developer bias supply spring and the recovery roller?	If not, replace the developer bias supply spring.
Scanner carriage section	7	Is there foreign matter on the carriage rail?	Remove foreign matter.

(16) White spots



Cause/Section	Step	Check items	Measures
Developer unit/ Toner cartridge	1	Is the toner density of developer material proper?	Check and correct the auto-toner sensor and toner supply operation. Check whether the amount of toner is sufficient in the toner cartridge.
	2	Is the doctor-sleeve gap proper?	Adjust the gap.
Main charger	3	Is there foreign matter on the charger?	Remove it.
	4	Is the charger wire dirty or deformed?	Clean or replace the charger wire.
High-voltage transformer (main charger/ developer bias/transfer roller)	5	Is the high-voltage transformer output defective?	Adjust the output.
Developer material	6	Is the developer material life ended?	Replace developer material.

(17) Poor transfer

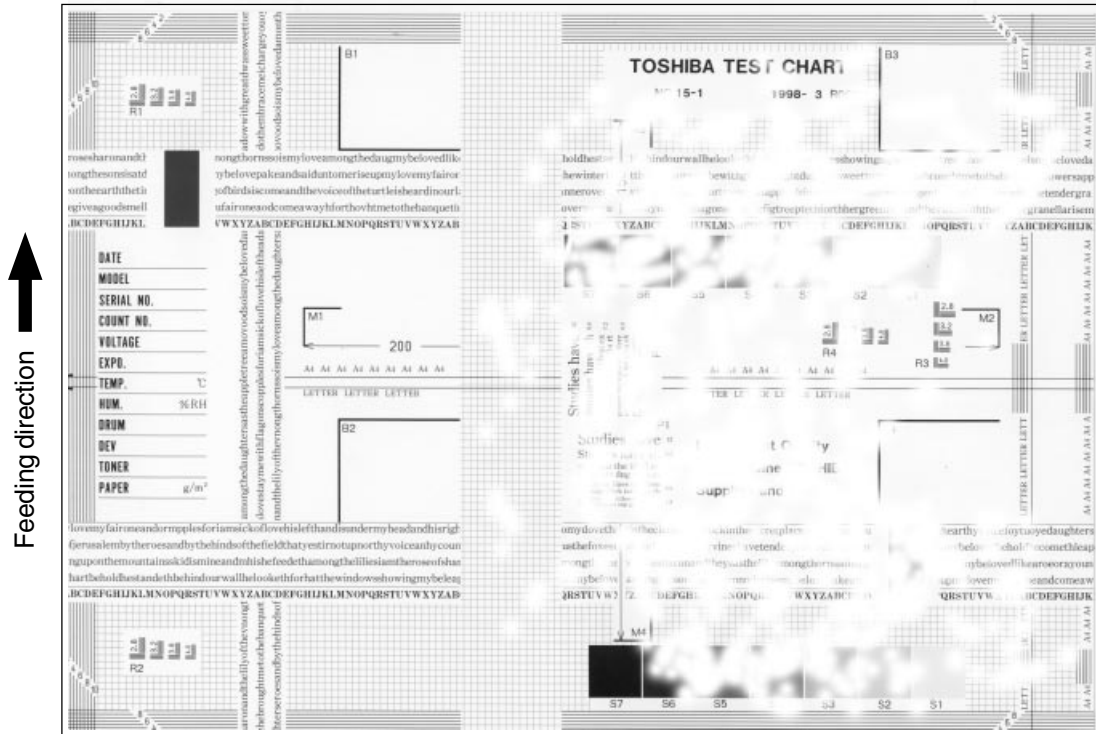

Cause/Section	Step	Check items	Measures
Transfer belt	1	Is the transfer belt dirty?	Clean it.
	2	Is the transfer belt in proper contact with the drum ?	Correct it.
	3	Is there any deformation or abnormalities on the transfer belt?	Replace the belt.
Paper	4	Is paper in the cassette or LCF curled?	Reinsert paper with reverse side up or change paper.
	5	Is paper in the cassette or LCF damp?	Change paper. * Avoid storing paper in damp place.
Registration roller	6	Is the registration roller malfunctioning?	Clean the roller, re-mount the spring, or replace defective clutch-related parts. Readjust the roller speed.
High-voltage transformer (transfer roller)	7	Is the high-voltage transformer output defective?	Check the circuit and adjust the transformer output.



(18) Uneven image density

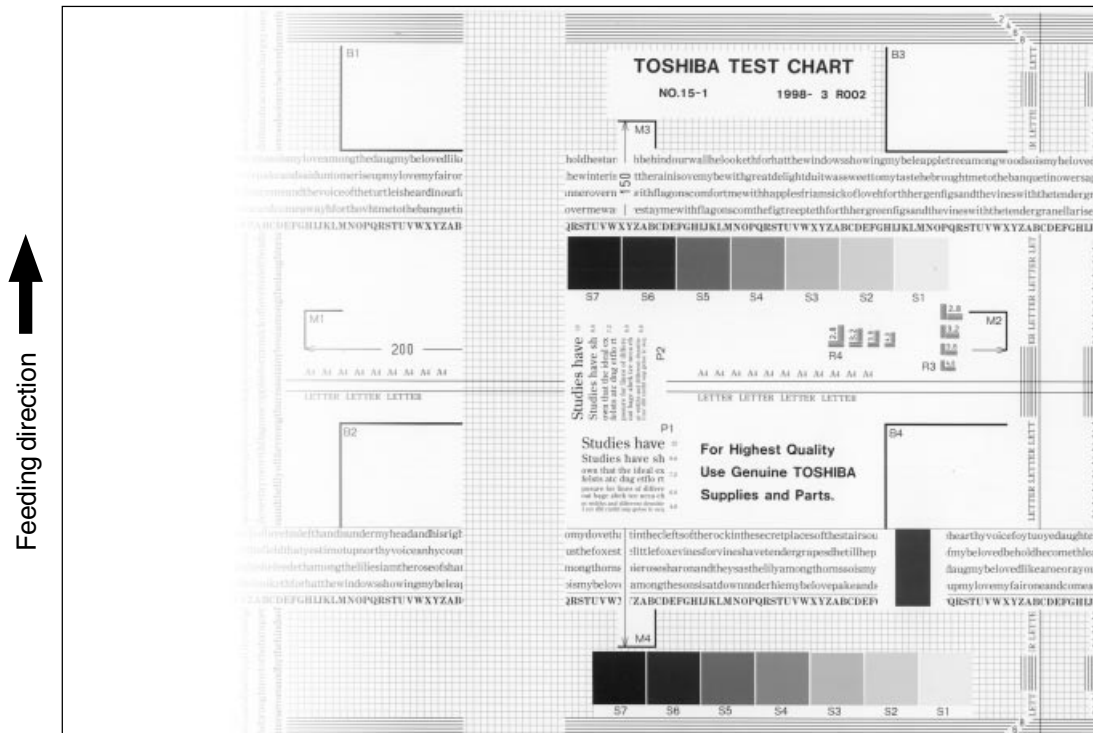

Cause/Section	Step	Check items	Measures
Main charger	1	Is the main charger dirty?	Clean it or replace the charger wire.
Transfer belt	2	Is the transfer belt dirty?	Clean the belt.
	3	Is the transfer belt in proper contact with the drum?	Correct it.
	4	Is there any abnormalities or deformation on the belt?	Replace the belt.
Laser optical unit	5	Is there foreign matter or dust on the slit glass?	Clean the slit glass.
Discharge lamp	6	Is the discharge lamp dirty?	Clean it.
	7	Has any LED of discharge lamp gone out?	Replace it.
Developer unit	8	Is the magnetic brush in proper contact with the drum?	Adjust the doctor-sleeve gap.
	9	Is the developer unit pressure mechanism malfunctioning?	Check the mechanism.
	10	Is the transport of developer material poor?	Remove foreign matter if any.
Scanner section	11	a. Is the platen cover open?	a. Close the platen cover.
		b. Are original glass, mirrors, or lens dirty?	b. Clean them.

(19) Faded image (low density, poor color reproduction and poor gray balance)

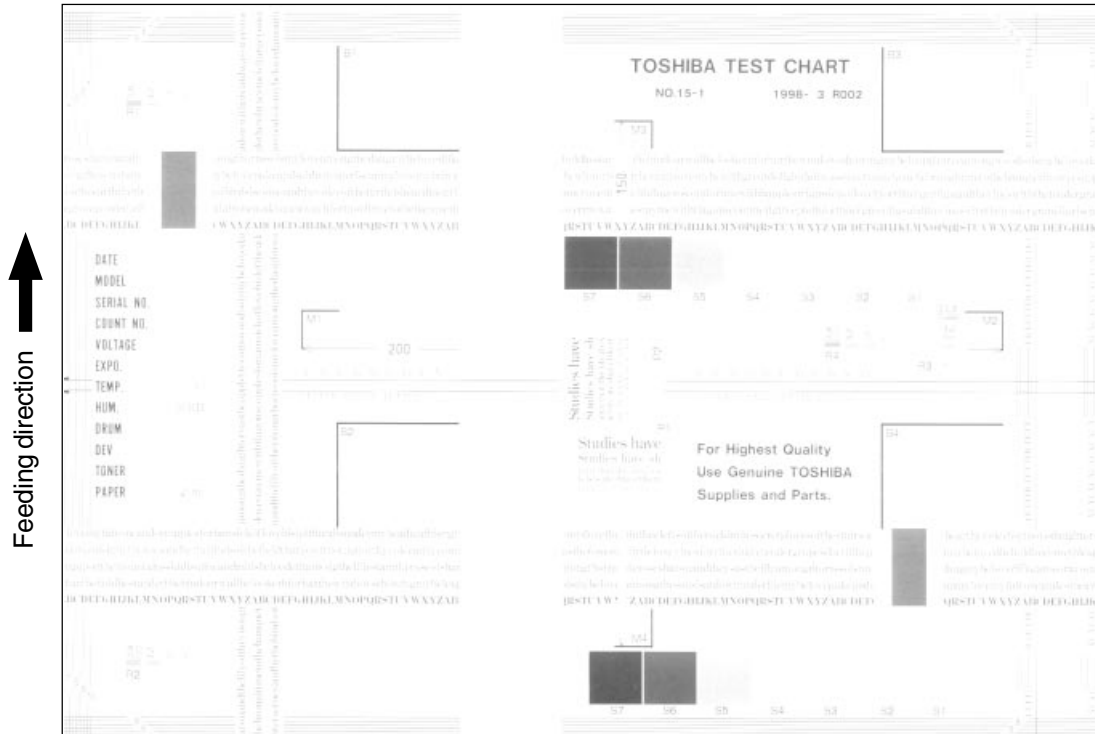

Cause/Section	Step	Check items	Measures
Toner empty	1	Is the "ADD TONER" symbol flashing?	Replace the toner cartridge.
Auto-toner circuit	2	Is there enough toner in the cartridge?	Check the auto-toner circuit function.
	3	Is the toner density of developer material too low?	
Toner motor	4	Is the toner motor malfunctioning?	Check the motor drive circuit.
Toner cartridge	5	Are there any abnormalities in the toner cartridge?	Replace the toner cartridge.
Developer material	6	Is the developer material life ended?	Replace developer material.
Developer unit	7	Is the magnetic brush in proper contact with the drum?	Check the developer unit installation. Check the doctor-sleeve gap and pole position.
Main charger	8	Is the main charger dirty?	Clean it or replace the charger wire.
Drum	9	Is there film forming on the drum surface?	Clean or replace the drum.
High-voltage transformer (developer bias)	10	Is the high-voltage transformer output settings improper?	Adjust the high-voltage transformer output.

(20) Image dislocation in feeding direction

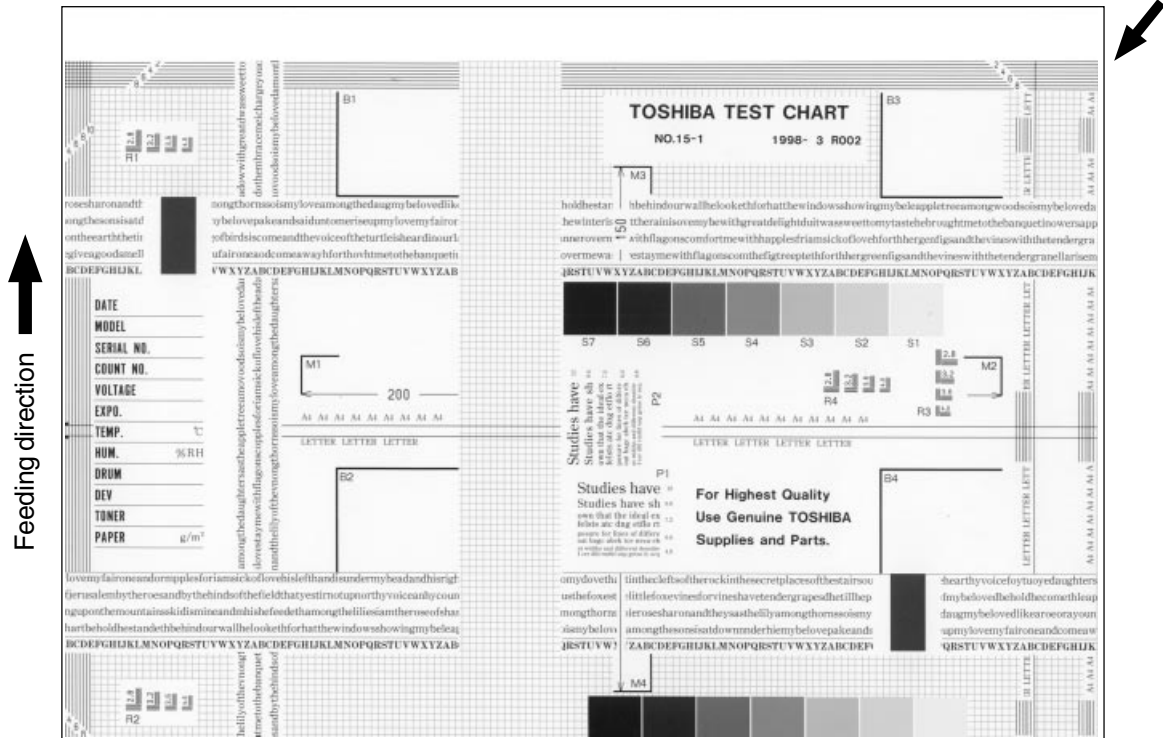

Cause/Section	Step	Check items	Measures
Adjustment error of scanner or printer section	1	Is same dislocation on every copy?	Adjust the scanner/printer using the adjustment mode.
Registration roller	2	Is the registration roller dirty, or the spring out of place?	Clean the roller with alcohol. Reinstall the spring.
	3	Is the registration motor malfunctioning?	Adjust or replace the gears, etc. if they are not engaged properly.
Paper feed motor	4	Is the paper feed motor malfunctioning?	Check the circuit or the motor and replace them if necessary.
Pre-registration guide	5	Is the pre-registration guide improperly installed?	Reinstall the guide.

(21) Image jittering

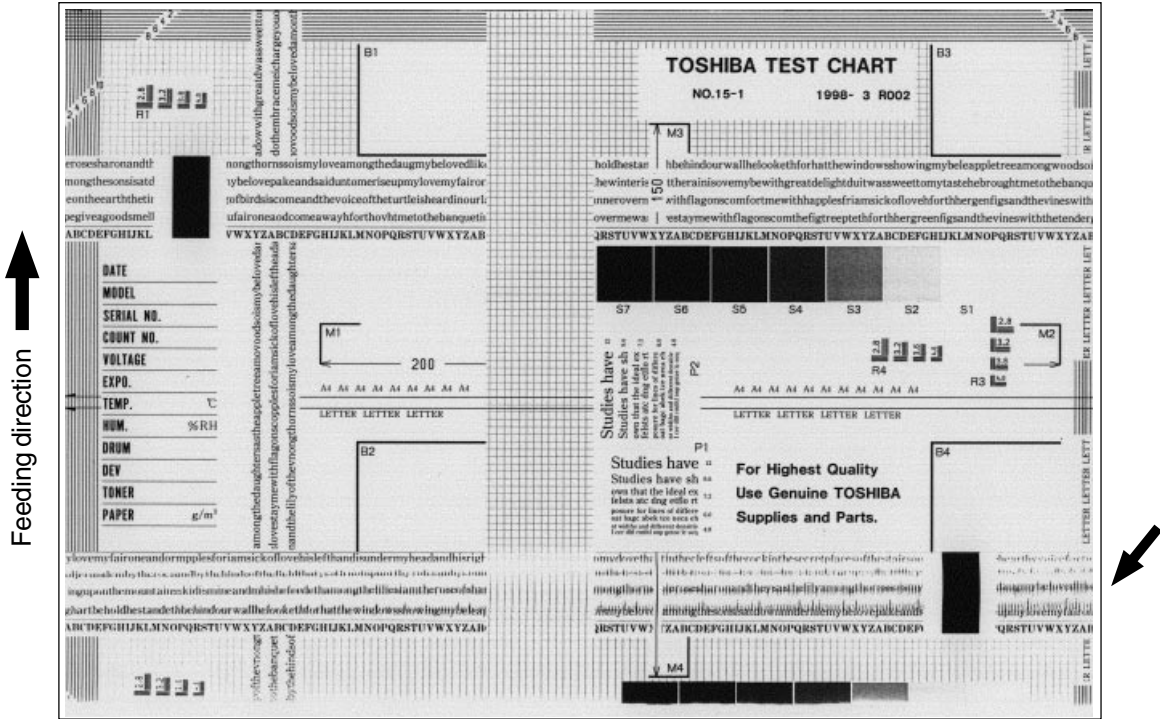

Cause/Section	Step	Check items	Measures
—	0	Is the toner image on the drum proper?	If proper, perform step 1 to 3; otherwise perform step 4 and after.
Registration roller	1	Is the registration roller rotating normally?	Check the registration roller section and its springs.
Transfer belt	2	Is the transfer belt operating normally?	Check the drive system and replace the transfer belt if necessary.
Fuser unit	3	Are the upper/lower heat rollers and fuser roller rotation proper? Is the fuser belt transportation proper?	Check the drive system. Replace the fuser belt, upper/lower heat rollers and fuser roller if necessary.
Drum	4	Is there large scratch on the drum?	Replace the drum.
Carriage operation	5	Is the slider sheet defective?	Replace it.
	6	Are there any abnormalities on the carriage feet?	Replace the feet.
	7	Is the tension of timing belt inappropriate?	Adjust the tension.
	8	Is the carriage drive system malfunctioning?	Check the carriage drive system.
Scanner	9	Are any mirrors loosely installed?	Install them properly.
Drum drive system	10	Is the drum drive system malfunctioning?	Check the drum drive system. Clean or replace the belts, pulleys, bushings if they have dirt or scratches.
Processing unit (EPU)	11	Is the EPU load too high?	Check the EPU.

(22) Poor cleaning

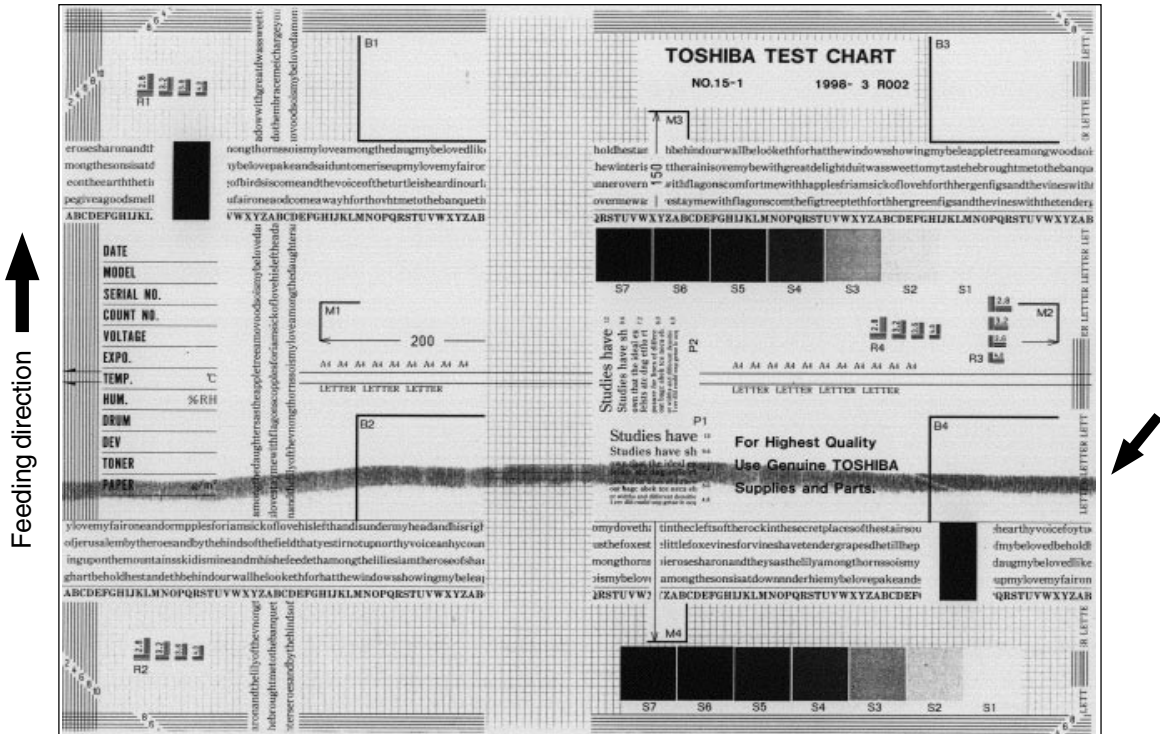

Cause/Section	Step	Check items	Measures
Developer material	1	Is the specified developer material used?	Use the specified developer material and toner.
Cleaning blade	2	Is there paper dust on the cleaning blade edge?	Clean it.
	3	Is the cleaning blade peeled?	Replace the blade. Check and replace the drum.
Toner recovery auger	4	Is toner recovery defective?	Clean toner recovery auger. Check the cleaning blade pressure.
Fuser unit	5	Is the cleaning roller or the oil roller damaged or their life ended?	Replace the defective rollers.
	6	Is there any bubble-like defect on the fuser belt (220mm pitch on the copy)?	Replace the fuser belt. Check and modify the heater control circuit.
	7	Are the fuser belt and the lower heat roller life ended?	Replace them.
	8	Is the pressure between the fuser roller and the lower heat roller proper?	Check and adjust the pressure mechanism.
	9	Is the temperature of upper/lower heat rollers proper?	Check and correct the circuit.

(23) Uneven light distribution

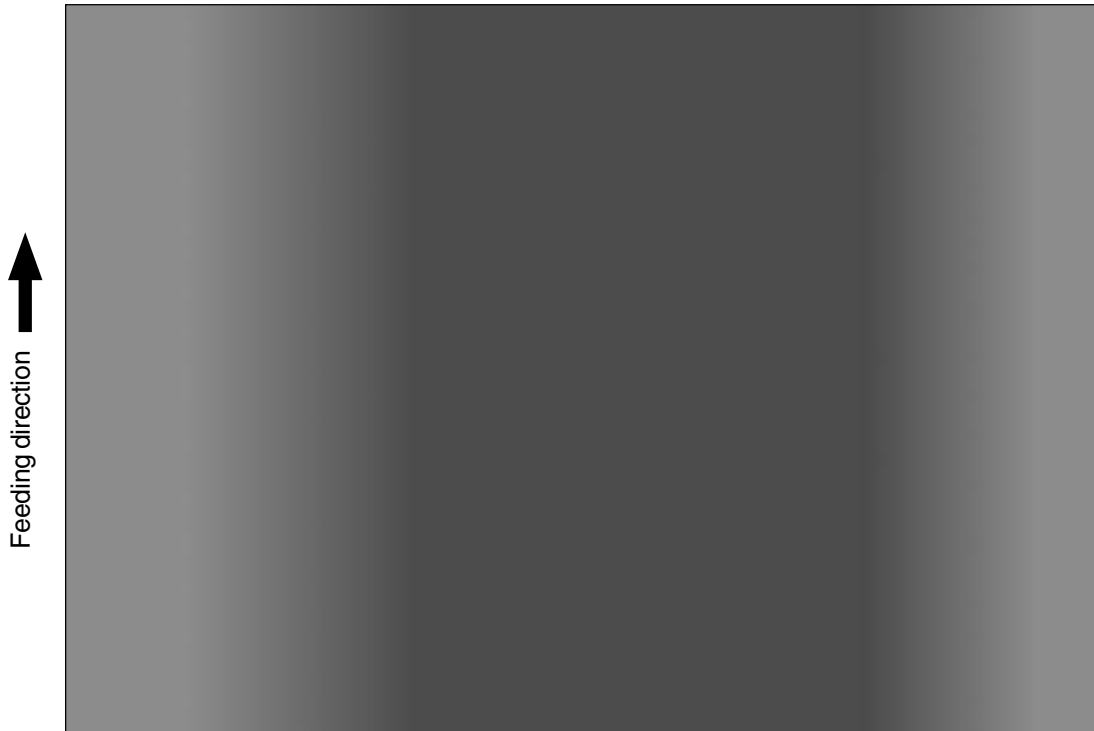

Cause/Section	Step	Check items	Measures
Original glass	1	Is the original glass dirty?	Clean the glass.
Main charger wire	2	Is the main charger wire dirty?	Clean or replace the wire.
Discharge lamp	3	Is the discharge lamp dirty?	Clean it.
Scanner	4	Are the reflector, exposure lamp, mirrors, lens, etc. dirty?	Clean them.
Exposure lamp	5	Is the exposure lamp tilted?	Adjust the installed position of the lamp.
	6	Is the lamp discolored or degraded?	Replace it.

(24) Blotched image

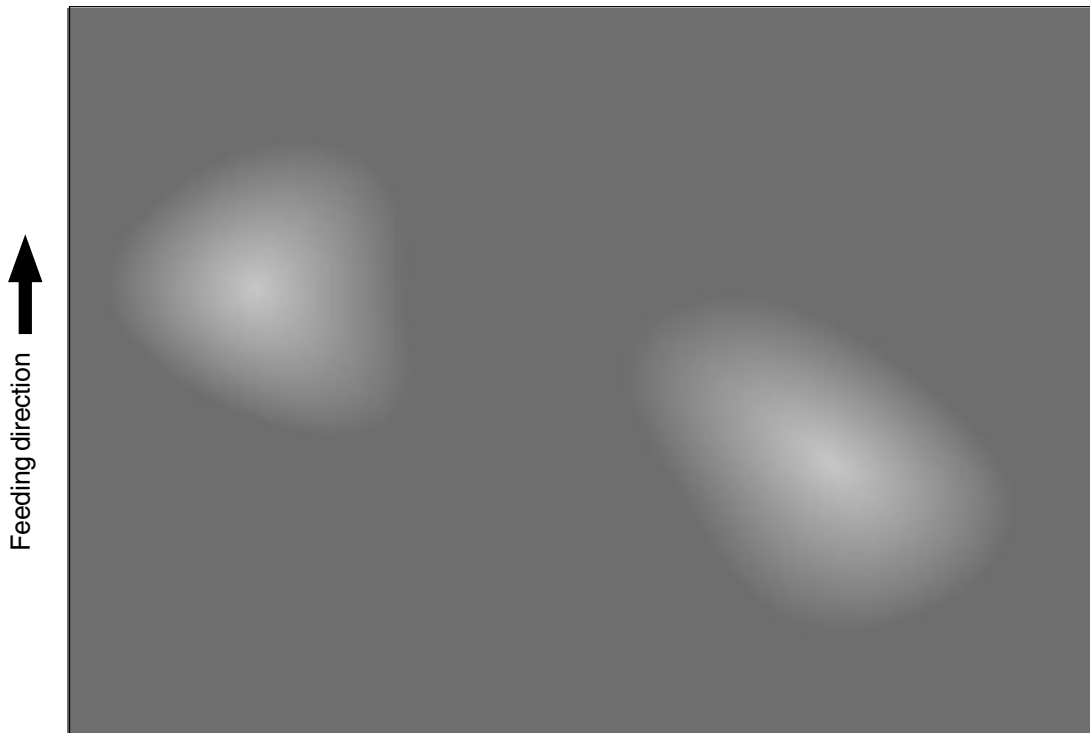

Cause/Section	Step	Check items	Measures
Paper	1	Does the paper mode correspond to the paper type?	Check the paper type and mode.
	2	Is paper too dry?	Change paper.
Transfer belt	3	Is the transfer belt in proper contact with the drums?	Correct it.
	4	Are there any abnormalities on the belt?	Clean or replace the belt.
High-voltage transformer (transfer roller)	5	Is the high-voltage transformer output abnormal?	Adjust the output. Replace the transformer, if necessary.

## 5. UPDATING THE FIRMWARE

<<Caution>>

Only the minimum firmware required for updating by the PC is installed in the system control PC board (SYS board), printer control PC board (IMC board), logic PC board (LGC board) and scanner control PC board (SCM board) provided as service parts.

When any of the above PC boards is replaced with a new one in the field, confirm the other firmware version to ensure the most suitable firmware is installed.

\* Never use an unsuitable combination of firmware since it can cause abnormalities.

- 
- The official name of Windows 95 is Microsoft Windows 95 Operating System.
  - The official name of Windows 98 is Microsoft Windows 98 Operating System.
  - Microsoft, Windows and the brand names and product names of other Microsoft products are trademarks or registered trademarks of US Microsoft Corporation in the US and other countries.
  - Copyright on the software of Windows 95/98 are held by US Microsoft Corporation.
  - Some of the screens used in this manual to describe operations are of Windows 95/98.



## 5.1 Installing Software for Firmware Update

### 5.1.1 Outline

The procedure to update the software of the SYS, IMC, LGC and SCM board using the PPP (Point-to-Point Protocol) and FTP (File Transfer Protocol) is described in this section.

\* This procedure is described based on the Windows 95/98. Information and necessary files corresponding to other OSs are supplied by the other service information.

### 5.1.2 Requirements

The following environment is necessary to update the firmware.

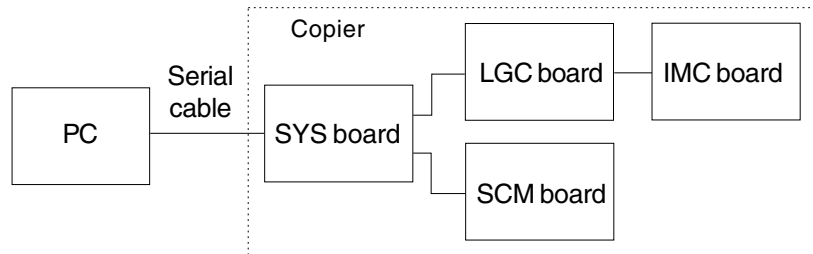

Software Requirements for PC

- Microsoft Windows95/98
- Virtual modem
- FTP Server / tools (ex. War FTP Daemon)

Use a serial cable for the DTE-DTE connection to connect the PC and SYS board.

(Update cannot be performed with the cable for the DCE-DCE connection)

See below for the connection lines.

DTE-DTE connection

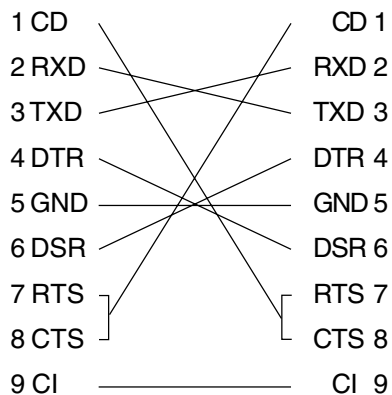

Pin No.	Signal	Meaning	I/O
1	CD	Reception carrier detection	I
2	RXD	Reception data	I
3	TXD	Transmission data	O
4	DTR	Data terminal ready	O
5	GND	Signal ground	
6	DSR	Data setting ready	I
7	RTS	Transmission request	O
8	CTS	Transmission enabled	I
9	CI	Called indication	I

RS232C DTE-DTE Cross Cable Lines (D-SUB 9pin)

Protocol specifications between the PC and SYS board

BAUD RATE	115200bps
DATA BIT	8 BITS
PARITY	NONE
STOP BIT	1 BIT
FLOW CONTROL	NONE
ECHO	OFF

### 5.1.3 Dial-up networking function

The settings necessary for the PPP are described in this section. The dial-up networking function is used to perform the PPP connection on the Windows 95/98.

(1) Virtual modem

Since a modem is supposed to be used for the Windows 95/98 dial-up networking, download a virtual modem to enable the connection performed directly with a serial cable.

(2) Installation of virtual modem

Download the following file from the web.

**URL:**<http://www.kevin-wells.com/net/mdmcbx4.inf>

After the above file was downloaded, install the modem as follows.

Click the “Modems” button on the Control Panel to display the following window, then click [Add].



The Modem Wizard is opened.

Check "Don't detect my modem; I will select it from a list", and click [Next].

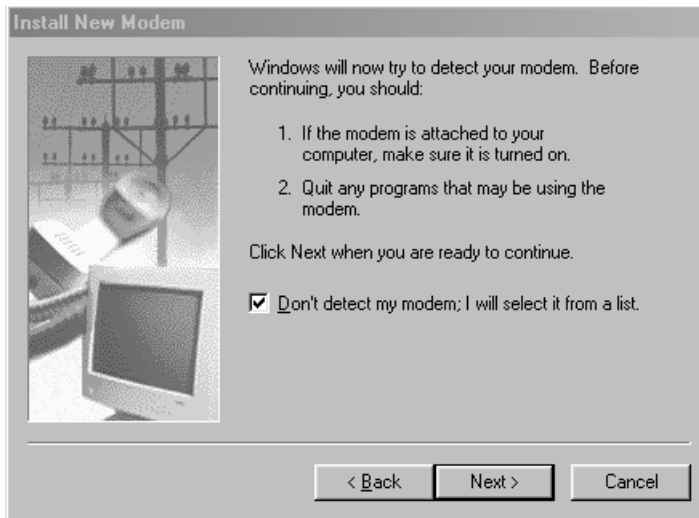

Click [Have Disk], then select a folder in which the downloaded file has been stored.

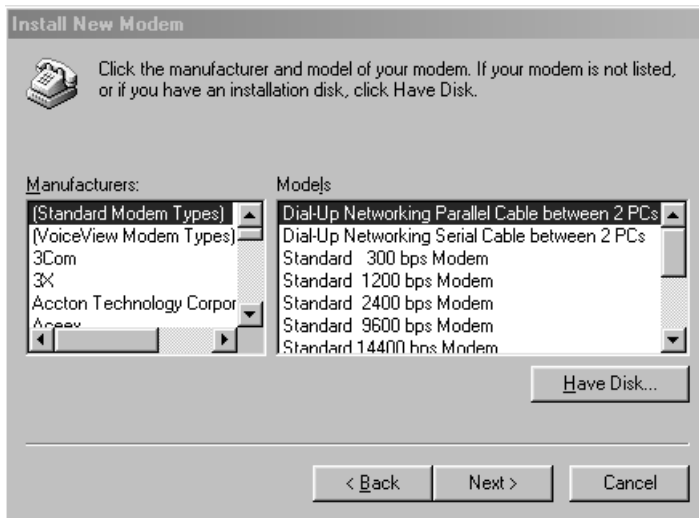

Select "Direct Connection", then click [Next].

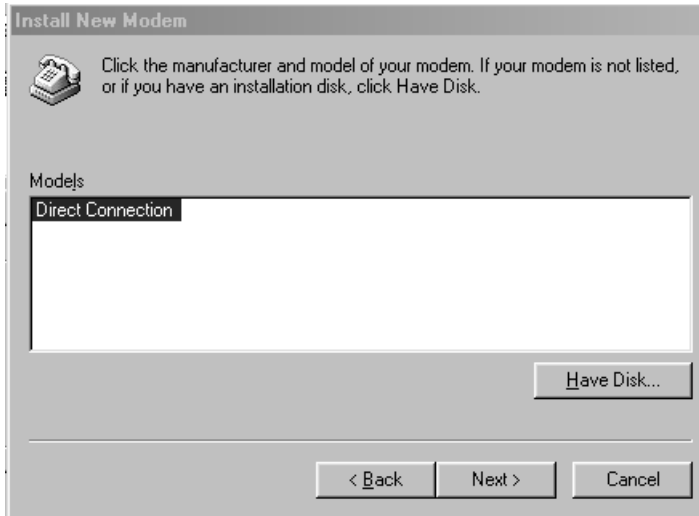

Select "Communications Port (COM1)", then click [Next].

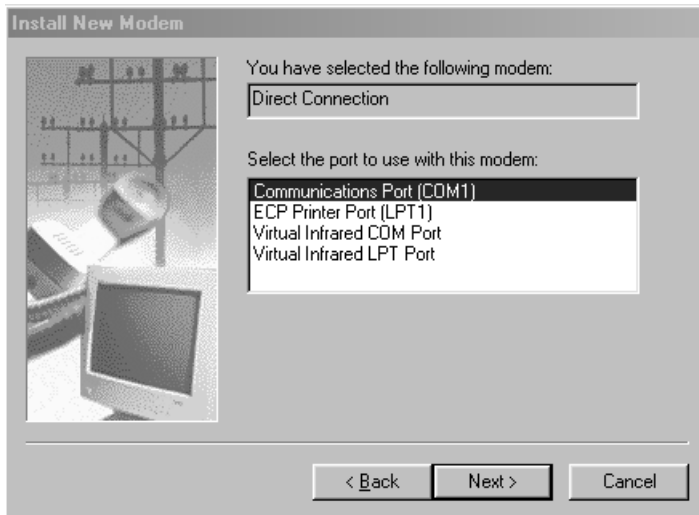

Click the [Finish] button to complete the virtual modem installation.



### 5.1.4 Installing dial-up networking

Your computer might be already set up to use a network. If the Windows prompts you for a network password at the startup and if the Network Neighborhood icon appears on the Windows desktop, the network function is already set up. In this case, you can skip this section.

In the "Network" dialog box, click the "Configuration" tab.  
Confirm that "Dial-Up Adapter" and "TCP/IP" are displayed.

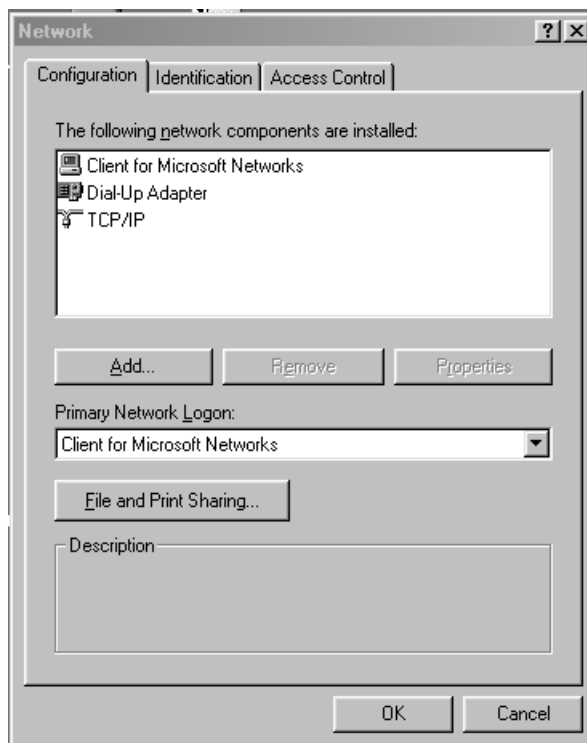

If your PC does not have "Dial-Up Adapter", click [Add].

Select "Microsoft" from the "Manufacturers" list and "Dial-Up Adapter" from the "Network Adapters" list, then click [OK].

TCP/IP Protocol components are automatically installed together with "Dial-Up Adapter".

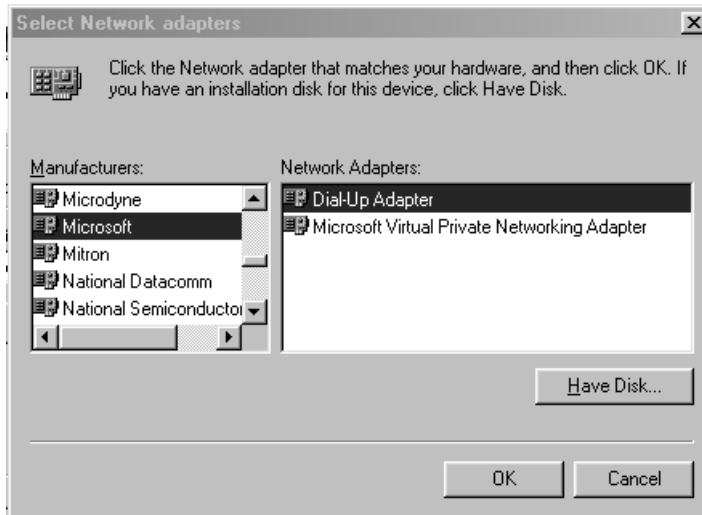



### 5.1.5 Setting dial-up networking

Double-click "My Computer". If the "Dial-Up Networking" icon is not in the window, open [Add/Remove Programs] in the Control Panel to install it.

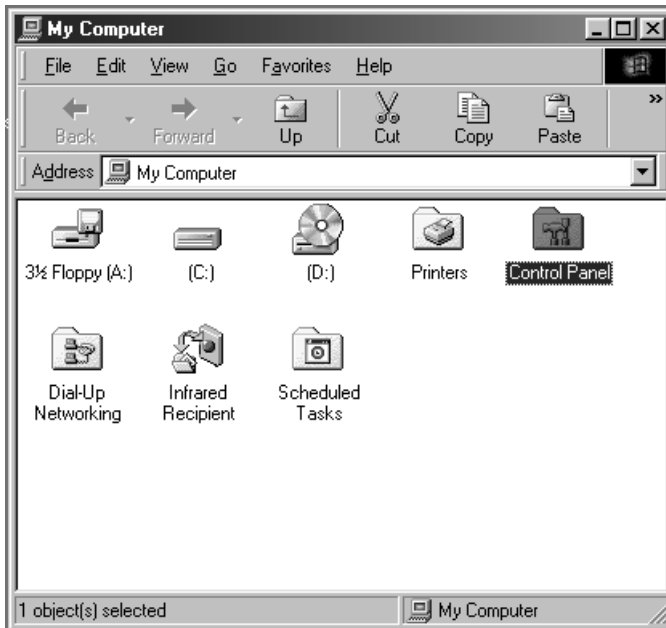

Double-click "Dial-up Networking" and then "Make New Connection".

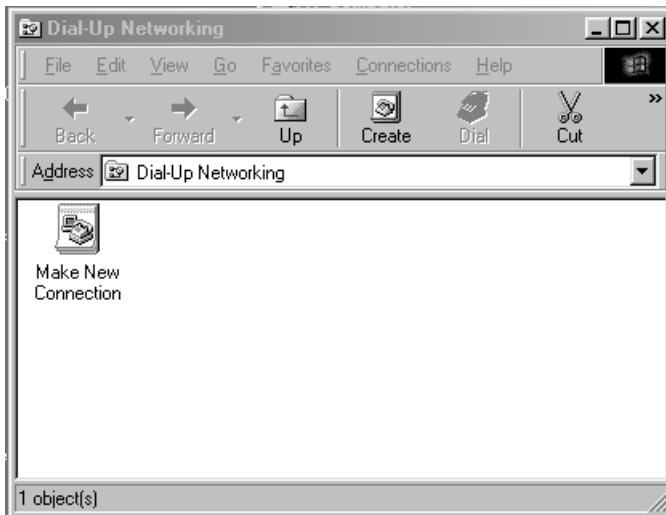

Enter a name in the box "Type a name for the computer you are dialing", and then select "Direct Connection" for "Select a device". Then, click [Configure].

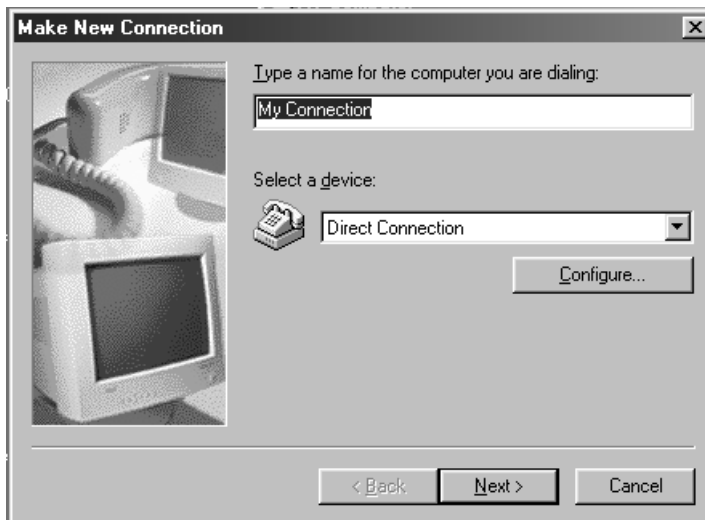

Click the "General" tab in the "Direct Connection Properties" dialog box. Select "115200" for "Maximum speed", and check "Only connect at this speed".

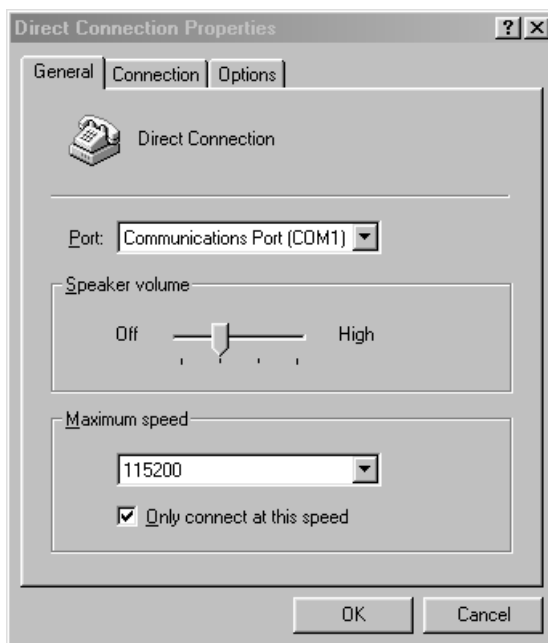

Click the "Connection" tab, confirm that no item in "Call preferences" is selected, and then click [Advanced].

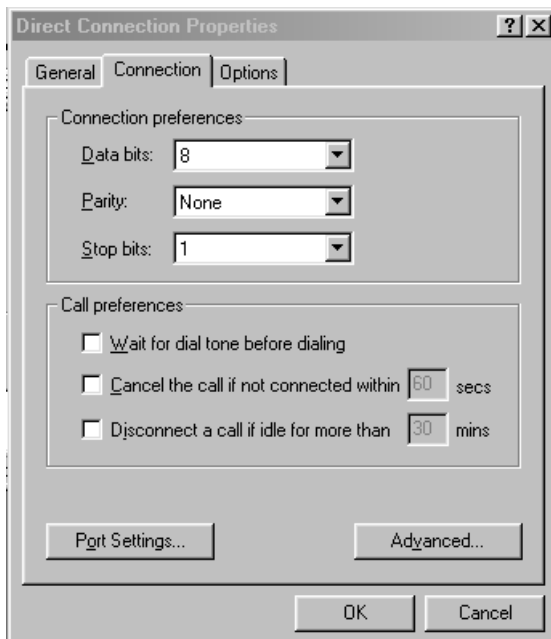

Confirm that no item in the "Advanced Connection Settings" dialog box is selected. Click the [OK] button to return to the "Make New Connection" dialog box and click [Next].

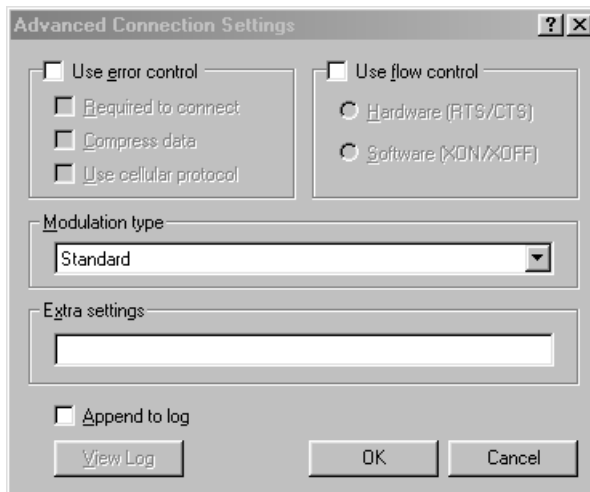

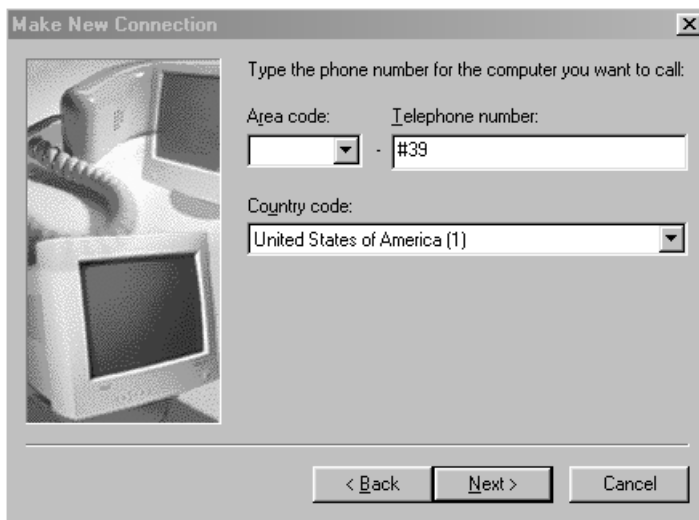

Enter "#39" in the "Telephone number" box.  
Select an appropriate country code, then click [Next].

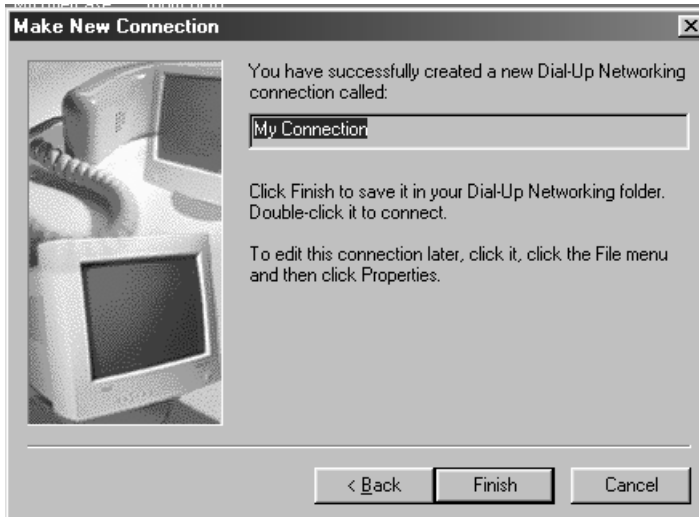

Click [Finish] to complete the setting for the "Dial-up Networking".

## 5.1.6 Installing software for FTP server

Install free software [War FTP Daemon Version 1.65] to use it as an FTP server.

War FTP Daemon can be downloaded from the following website.

**FTP:** [ftp://ftp.jgaa.com/pub/products/Windows/WarFtpDaemon/1.6\\_Series/ward165.exe](ftp://ftp.jgaa.com/pub/products/Windows/WarFtpDaemon/1.6_Series/ward165.exe)

**HTTP:** [http://download.jgaa.com/ftp/pub/products/Windows/WarFtpDaemon/1.6\\_Series/ward165.exe](http://download.jgaa.com/ftp/pub/products/Windows/WarFtpDaemon/1.6_Series/ward165.exe)

Some files are extracted by double-clicking the [ward165.exe] icon. Double-click [Setup.exe] to start installation.

Create a new folder "C:\WEBSHARE\FTPROOT".

Double-click [war-ftpd.exe] in the [war-ftpd] folder.

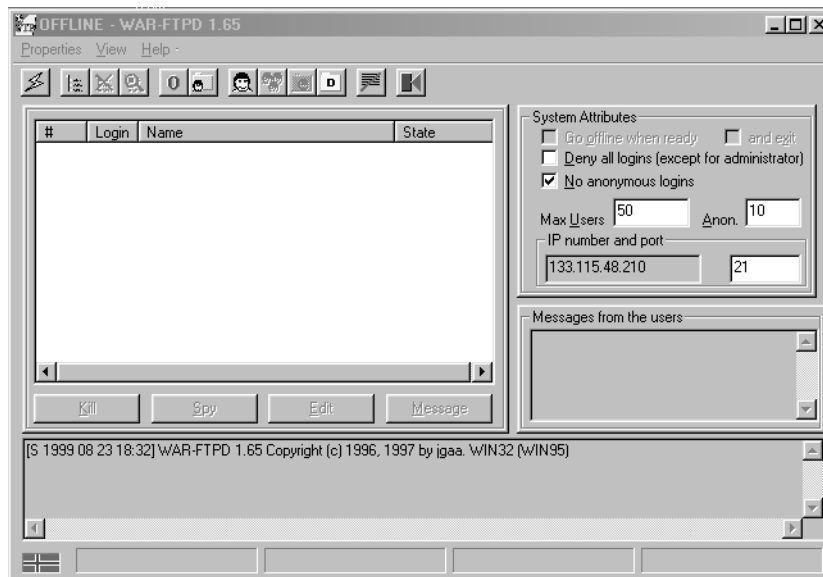

Select [Properties]-[Security]-[Edit User].

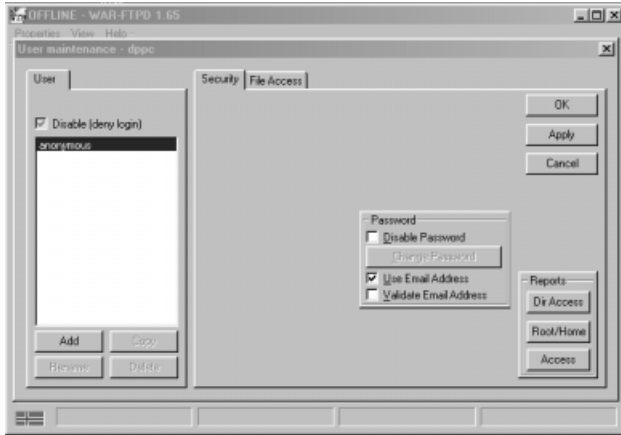

Click [Add] and type in "dppc" in the "New name" box.

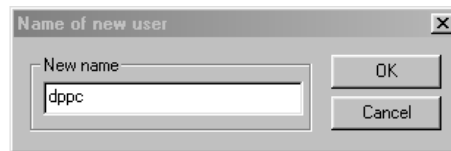

Type in "dppc" in the "New Password" and "Verify Password" boxes, then click [OK].

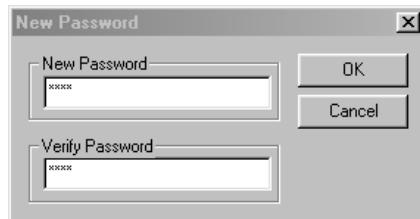
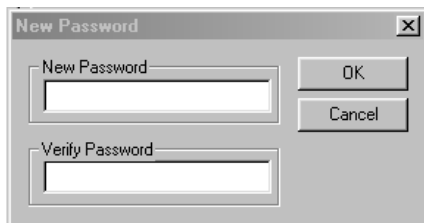

Select "dppc" and click the "File Access" tab. Then, click [Add].

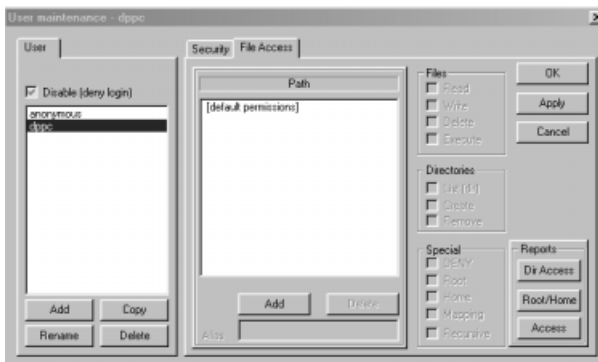

Double-click "Webshare".

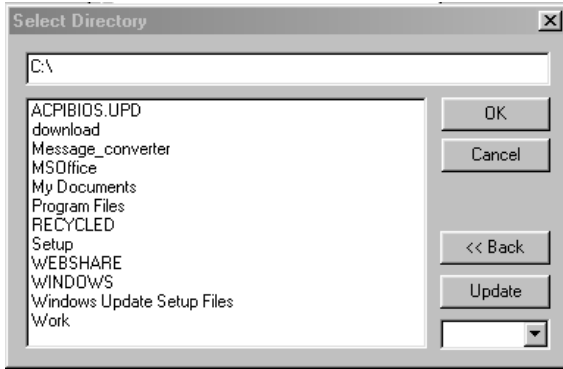

Double-click "Ftproot" and click [OK].

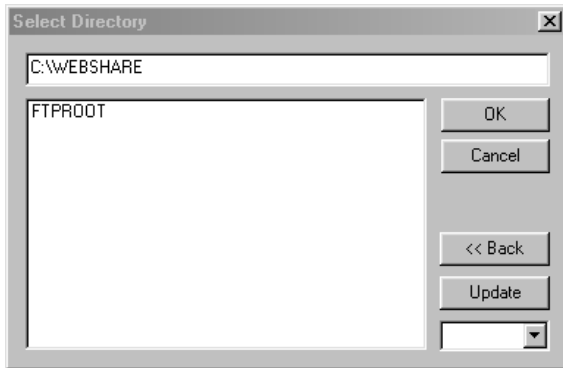

Check the "Read", "Write", "Delete", "Execute", "List", "Create" and "Remove" boxes. Confirm that the check marks are not gray but black.

Check "Root", "Home" and "Recursive" in the "Special" box as well.

Click [Apply] and then [OK].

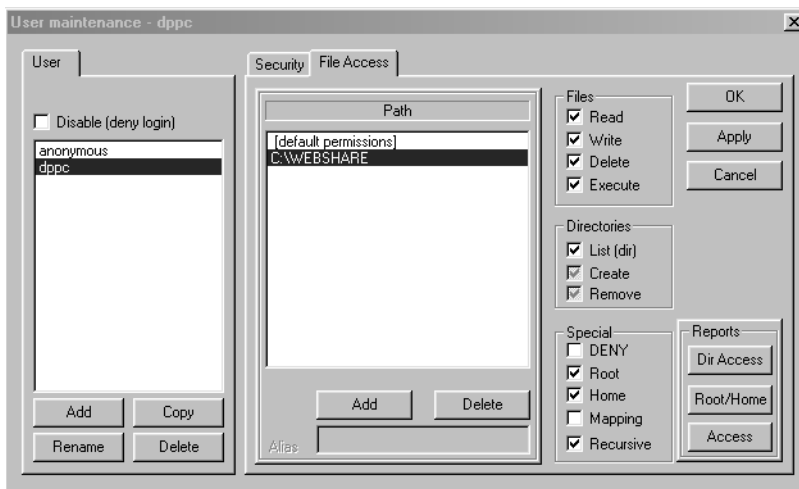

Enter the "ONLINE" mode by clicking the  button before starting the firmware update.

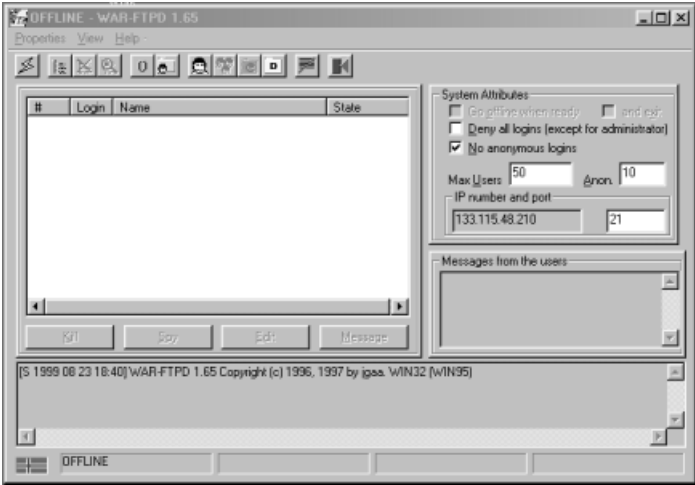



## 5.2 Operation Procedure in [3][9] Mode

### 5.2.1 Outline

Connect the copier and PC with a serial cable and turn ON the power while pressing the digital keys [3] and [9] simultaneously to start the "Firmware Update Mode". The system firmware, UI data and engine firmware (printer ROM, engine ROM and scanner ROM) can be updated in this mode.

**Note:** In the [3] [9] mode, the version of system firmware and UI data can be displayed, but the version of engine firmware cannot be displayed. Therefore, confirm the version of engine firmware in the setting mode (08).

### 5.2.2 Preparation

The following need to be prepared or performed in advance to update the firmware.

(1) Software installation

"Virtual modem" and "War FTP Daemon" have to be installed in the PC.

Refer to "5.1 Installing Software for Firmware Update"

"War FTP Daemon" has to be in the "ONLINE" mode when updating the firmware.

(2) New file

Prepare files for updating in the PC.

New files with the preset directory and names are provided in the following folder.

C:\WEBSHARE\FTPROOT

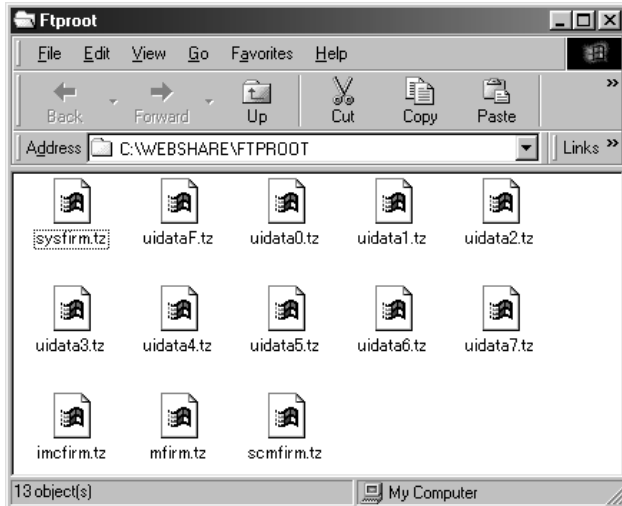

New files:

- System firmware sysfirm.tz
- UI data fixed section uidataF.tz
- UI data common section uidata0.tz
- 1st language UI data uidata1.tz
- 2nd language UI data uidata2.tz
- 3rd language UI data uidata3.tz
- 4th language UI data uidata4.tz
- 5th language UI data uidata5.tz
- 6th language UI data uidata6.tz
- 7th language UI data (American English) uidata7.tz
- Engine firmware (Engine ROM) mfirm.tz
- Engine firmware (Printer ROM) imcfirm.tz
- Engine firmware (Scanner ROM) scmfirm.tz

(3) Connection between the SYS board and PC

The SYS board and PC are connected with a cross cable.

For the PC, connect the cable to the connector corresponding to the serial communication port (eg. COM1) which is specified when the virtual modem is set up.

For the SYS board, connect the cable to the MMF(FSMS) port.

**Note:** Do not connect serial cable with machine power turned ON.

### 5.2.3 Updating firmware

Update the firmware in the [3][9] mode as follows:

1. Turn ON the power of the copier while the digital keys [3] and [9] are pressed simultaneously.
2. The following is displayed on the control panel of the copier.

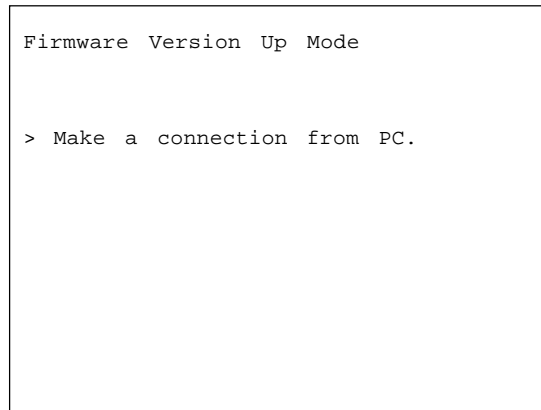

3. Make a serial connection using the dial-up networking function of the PC.  
Refer to "5.1 Installing Software for Firmware Update" for the dial-up network connection.  
Double-click the defined icon for connection in the "Dial-up Networking" dialog box to perform the connection processing.

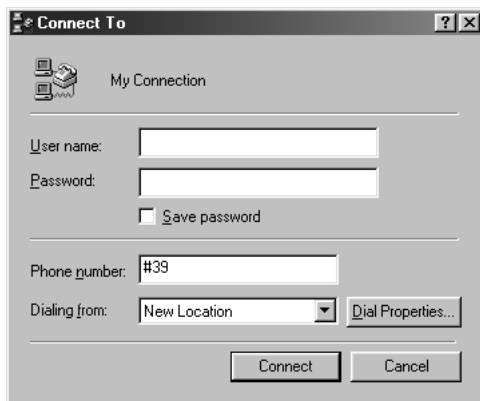
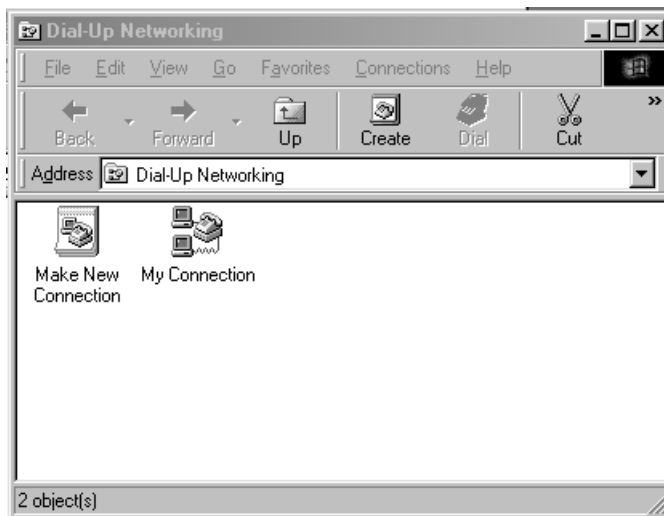

Enter "#39" in the "Phone number" box.

4. The following is displayed if the serial connection was completed successfully.

```

Firmware Version Up Mode
                                Target: 1
Established serial connection with PC.

> Press START key to install new
firmwares.

> Please select a target with DIGITAL
keys.
  
```

Number of the target area for updating

You can press [HELP] to confirm the current version (the version before the copier is updated).

\*The engine firmware version cannot be displayed in this screen. Use the setting mode to confirm them.

08-902: Engine ROM version (LGC)

08-903: Printer ROM version (IMC)

08-904: Scanner ROM version (SCM)

Press [HELP] again to return to the above screen.

```

Firmware Version Up Mode
                                Target: 1
Established serial connection with PC.

target  version  code
  1      005.101  U
  2      004.001  0
  3      005.002  0
  4      006.001  6
  5      006.001  7
  6      006.003  11

Press START key to next.
  
```

One of the following is displayed: U, E or X

[START] key

```

Firmware Version Up Mode
                                Target: 1
Established serial connection with PC.

target  version  code
  7      006.001  8
  8      006.001  10
  9      006.002  13
  10     006.001  3

Press START key to previous.
  
```

The "target" number indicates the following.

- 1: System firmware
- 2: UI data fixed section
- 3: UI data common section
- 4: 1st language UI data
- 5: 2nd language UI data
- 6: 3rd language UI data
- 7: 4th language UI data
- 8: 5th language UI data
- 9: 6th language UI data
- 10: 7th language UI data

The version number is displayed as "XXX.YYY".

"XXX" indicates the major version and "YYY" is the minor version.

The "code" indicates the following.

A. The "code" for the System firmware ("target": 1) denotes the destination.

U: USA and Canada

E: European countries

X: Australia and Asian countries

B. The "code" for the UI data ("target": 2-10) denotes the language.

Code	Language	Code	Language
2	Japanese	13	Finnish
3	American English	14	Norwegian
4	English	15	Australian English
5	—	16	Polish
6	French	17	Czech
7	German	18	Greek
8	Swedish	19	Romanian
9	Dutch	20	Bulgarian
10	Italian	21	Portuguese
11	Spanish	22	Hungarian
12	Danish	23	—

5. Select the area to be updated using the digital keys and [INTERRUPT] key.

(Press the [INTERRUPT] key to enter "#".)

The selected number is displayed at upper right of the screen, next to "Target:".

The relation between the selected number and area to be updated is as follows.

- 1 : System firmware
- 2 : UI data fixed section
- 3 : UI data common section
- 4 : 1st language UI data
- 5 : 2nd language UI data
- 6 : 3rd language UI data
- 7 : 4th language UI data
- 8 : 5th language UI data
- 9 : 6th language UI data
- 10 : 7th language UI data
- 11 : Engine firmware (Engine ROM)
- 12 : Engine firmware (Printer ROM)
- 13 : Engine firmware (Scanner ROM)
- #1 : System firmware and all UI data (1 to 10)
- #2 : All UI data (2 to 10)
- #3 : All language UI data (4 to 10)
- #4 : All data (1 to 13)
- #5 : Engine firmware (Engine ROM and printer ROM) (11 and 12)

6. The copier starts updating when the [START] key is pressed.

**Do not turn OFF the power of the copier or PC, or disconnect the cable after the [START] key has been pressed.**

**Interruption during the file transmission to the copier will destroy the file in the FROM of the copier. The data must be reinstalled after checking and performing the following items.**

- Connect the serial cable correctly.
- Restart the copier and PC.
- Change the "War FTP Daemon" to "ONLINE" mode.
- Copy the new files to the PC again.

In case of target 1 - 13 :

```
Firmware Version Up Mode
                                Target: 1
Installing new firmware.
< reading a file.
```

Displays the status of updating process.

- reading file.
- erasing the device.
- writing to the device.

In case of target #1 - #5

```
Firmware Version Up Mode
                                Target:#1
Installing a new firmware.
< reading a file.
Target Version      code
  ① installing
```

Displays the area being processed.

\* During writing the data corresponding to the target 11 - 13, the transmission rate is displayed.

- writing to the device.

xxxxx/XXXXX ————— transmitted / total (byte)

7. The following will be displayed when the firmware update is completed successfully.  
 In case of target 1 - 13:  
 If you continue to update the other areas, press the [START] key and perform the step 5 and the followings for each area.  
 Turn OFF the power or press the [CLEAR] key to exit the update screen.

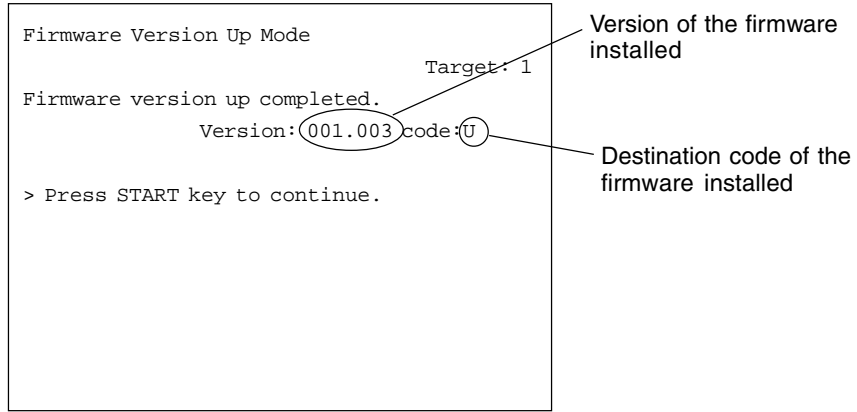

- In case of target #1 - #5:  
 The following is displayed when the updating is finished.

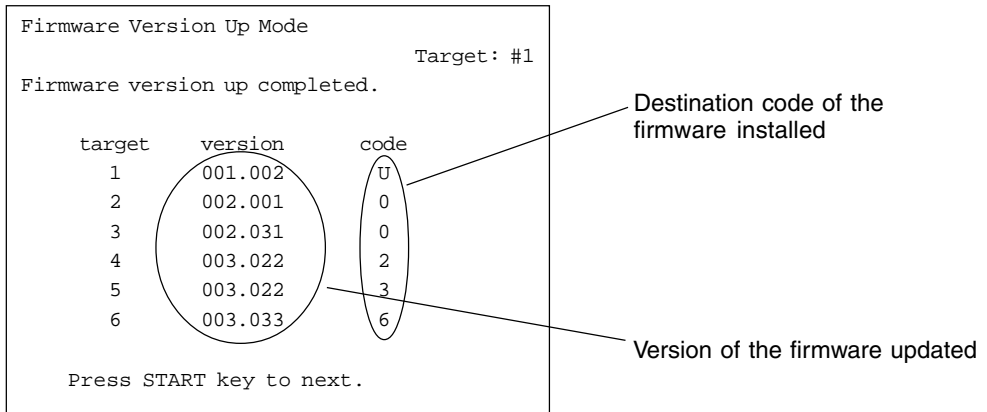

8. Press the [CLEAR] key to cancel the updating process.  
 However, it cannot be canceled once the data elimination process on the flash ROM is started.

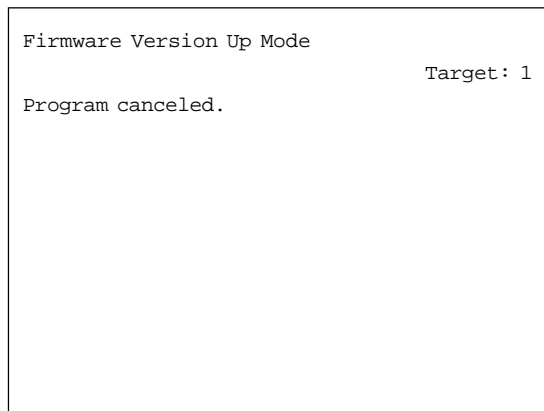



9. The following error message is displayed when the firmware was not updated successfully.  
(If "- device erase error", "- device write error" or "- verify error" occurs, the "Recovery mode" is automatically activated when the power is turned ON next time. See 10.: Recovery mode)

```
Firmware Version Up Mode
Target: 1
Failed to install a new firmware.
file read error.
```

- Error messages
- file read error.
  - file information error.
  - unfit device.
  - device erase error.
  - device write error.
  - verify error.
  - cannot set NvRAM flags.
  - Communication error LGC
  - Communication error IMC
  - Communication error SCM

#### 10. Recovery mode

The following is displayed when the power is turned OFF and then back ON after an error has occurred during the updating process.

```
Firmware Version Up Mode
Recovery mode : target 3-10 failed.
> make a connection from PC
```

The display changes as follows if the dial-up network connection (see procedure 3) was made successfully.

```
Firmware Version Up Mode
Target: #3
Recovery mode : target 3-10 failed.
> Press START key to install new firmwares.
```

Further operations and displays are the same as those of the normal sequence.

\* If an error occurs while the processing of automatically sequenced writing of #4, do the following operations after completing the update in a recovery mode.

Target	Area of error	Operation
#4	1~10	After completing the update to the target 10 in a recovery mode, update the target 11 to 13 in a writing processing with the area definition.
#4	11~12	After completing the update to the target 12 in a recovery mode, update the target 13 in a writing processing with the area definition.

## 5.2.4 Display

The following screens are displayed in the mode [3][9].

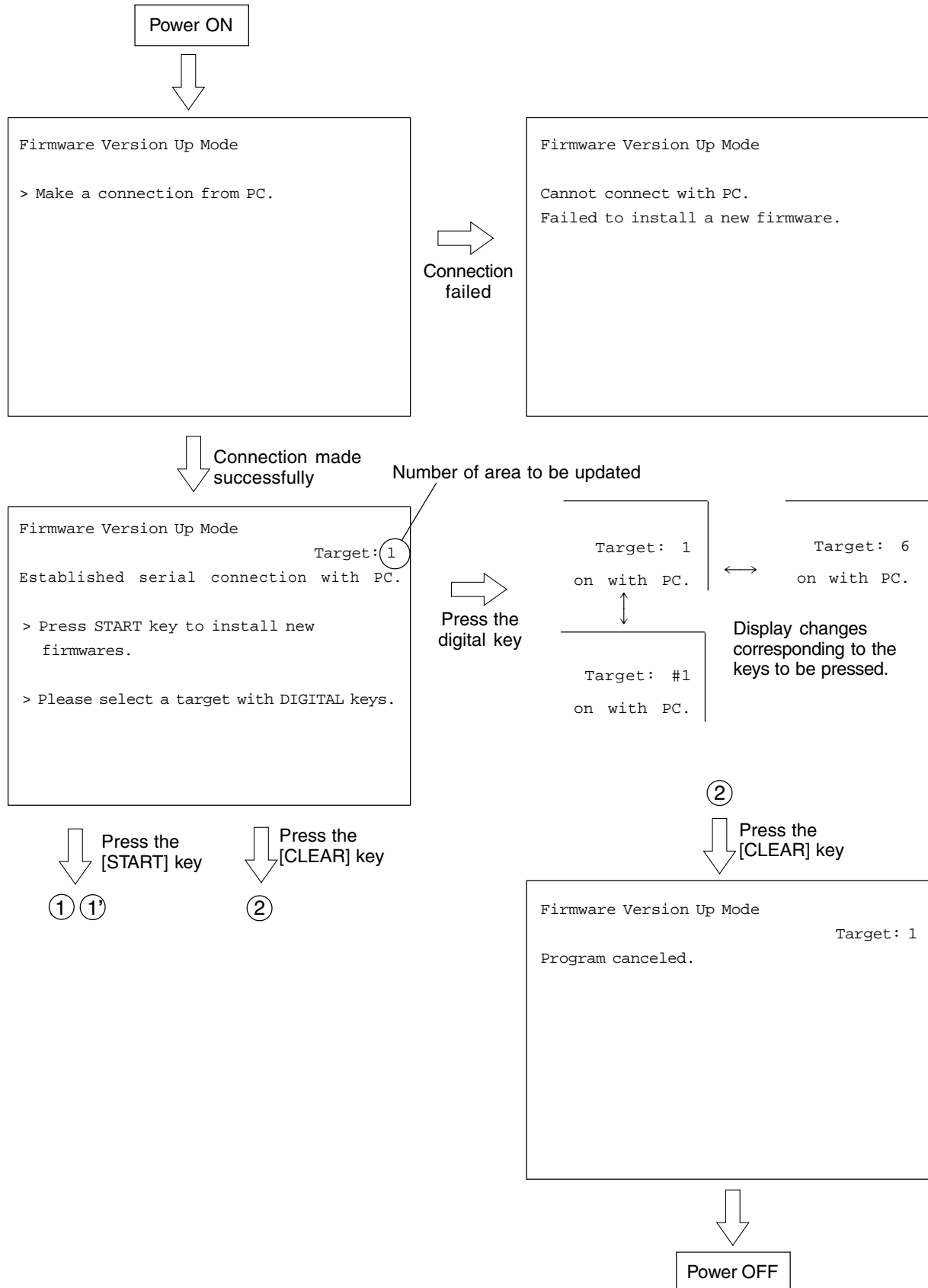

In case of target 1 - 13 :

① Press the [START] key



```

Firmware Version Up Mode
Target: 1
Installing a new firmware.
- reading a file.
    
```

- Status of updating process (Target 1 - 10)
- reading a file.
  - checking a read file.
  - checking the device.
  - setting NvRAM flags.
  - erasing the device.
  - writing to the device.
  - verifying the device.
  - clearing NvRAM flags.
- Status of updating process (Target 11 - 13)
- reading a file.
  - writing to the device.

Installed successfully

Installation failed

Press the [CLEAR] key

③

②

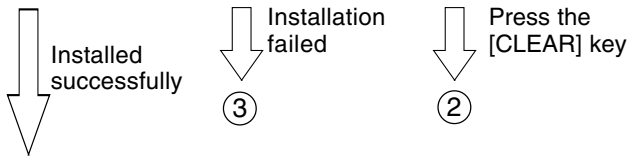

```

Firmware Version Up Mode
Target: 1
Firmware version up completed.
Version: 001.003 code: U
> Press START key to continue.
    
```

Version of the firmware installed  
(Not displayed in case of Target 11 - 13)

Destination code of the firmware installed  
(Not displayed in case of Target 11 - 13)

②

Press the [CLEAR] key

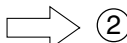

Press the [START] key



```

Firmware Version Up Mode
Target: 1
> Press START key to install new firmwares.
> Please select a target with DIGITAL keys.
    
```

Press the digital key



```

Target: 1 on with PC.
Target: 6 on with PC.
Target: #1 on with PC.
    
```

Display changes corresponding to the keys pressed

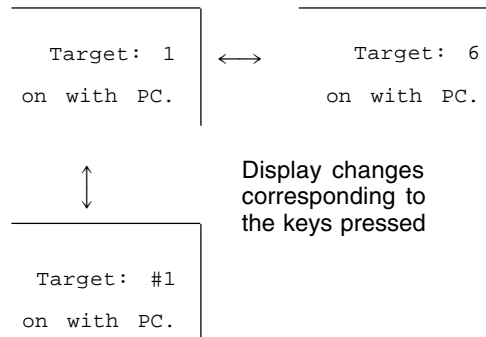

Press the [START] key

Press the [CLEAR] key

① ①'

②

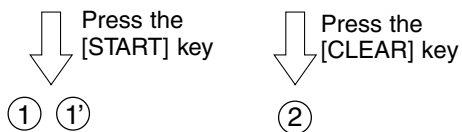

In case target of #1- #5:

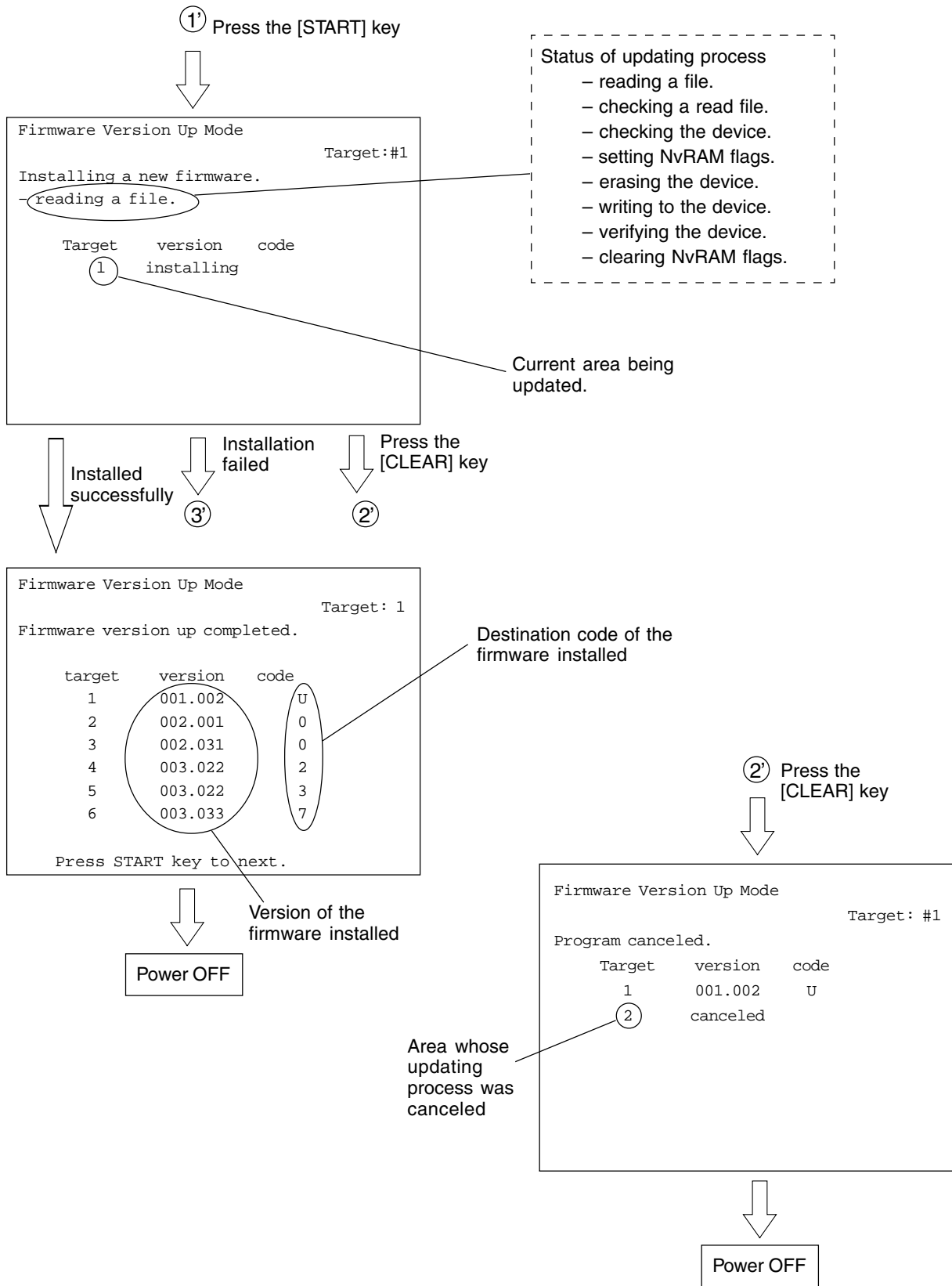

In case of target of 1 - 13:

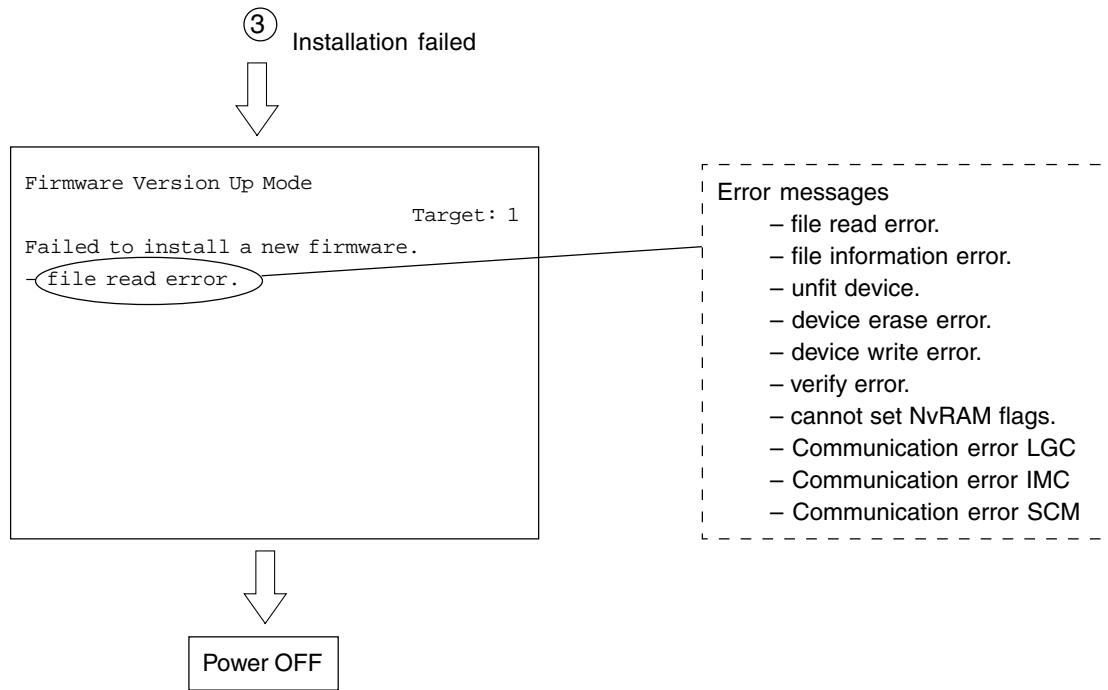

In case of target #1 - #5:

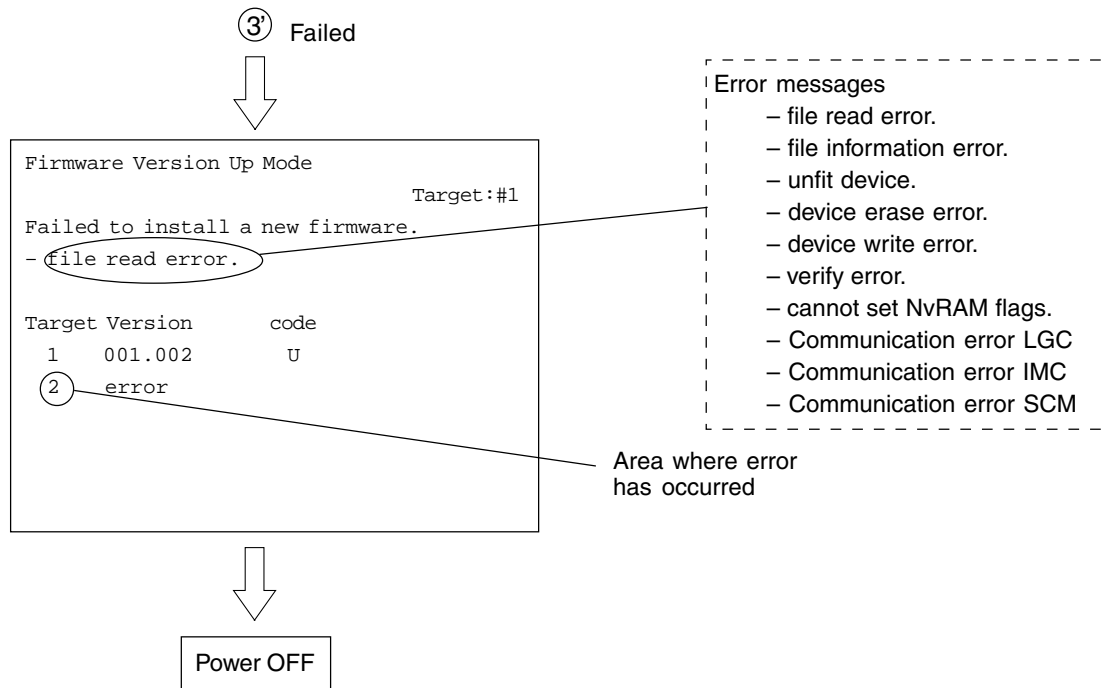

### 5.3 Updating the Firmware Using the Downloading Jig

In this model, it is possible to update the firmware automatically by connecting the downloading jig using the dedicated connector and turning the power of the copier ON.

The downloading jig consists of the programmed ROM and jig board. Two types of the jig board are available as follows.

Firmware	PC board	Jig board to be used
System firmware	System control PC board (SYS board)	K-PWA-DLS-320
Engine firmware	Logic PC board (LGC board)	
(engine ROM, scanner ROM and printer ROM)	Scanner control PC board (SCM board)	K-PWA-DLM-320
	Printer control PC board (IMC board)	

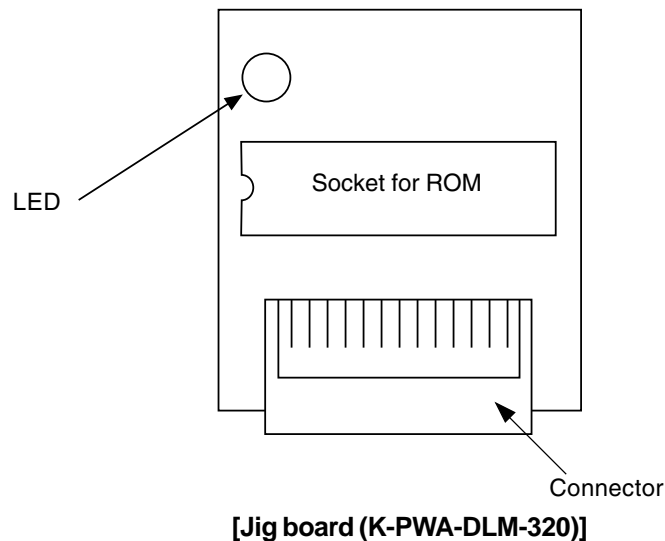
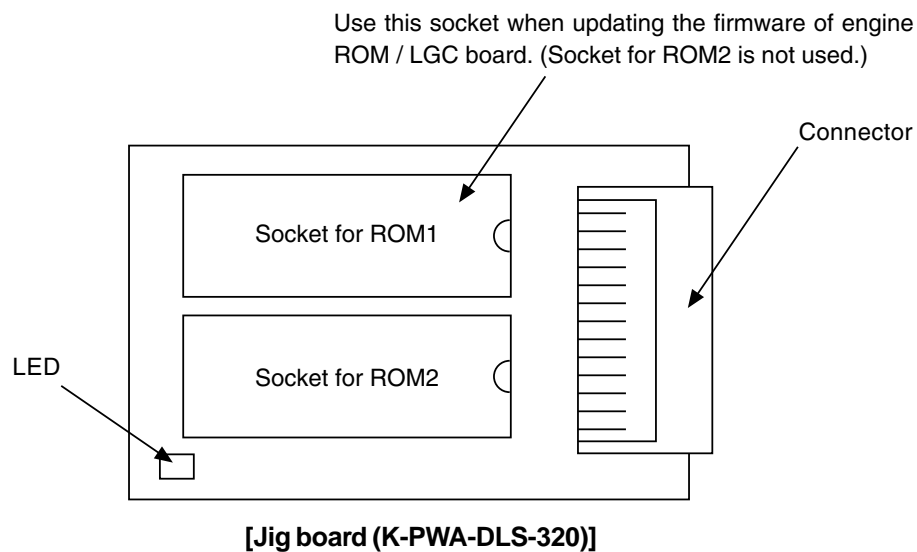

### 5.3.1 System firmware

#### (1) ROM type

There are two types of ROM to be downloaded.

##### (a) ROM for application downloading

The area in the FROM on the SYS board is updated. This ROM is used for the normal update.

The data to be overwritten by this ROM are as follows.

- System software basic section
  - \* This area cannot be downloaded using PC.
- Program internal application
- UI data fixed section
- UI data common section
- Language(UI) on the display panel

##### (b) ROM for UI data downloading

The language data in the HDD are updated.

The data to be updated by this ROM are as follows.

- UI data: The 1st to 7th languages

When downloading is performed using the ROM for UI data downloading, only UI data in the HDD are updated.

To make the result of updating effective, it is necessary to copy the updated data into the FROM by selecting a desired language in the setting mode "Selection of language(UI) on the display panel (08-220)".

#### (2) Jig board

Two types of the ROM mentioned above use the jig board K-PWA-DLS-320.

(▶ Page. 5-32)

**Note:** Pay attention to the position and direction of the ROM when it is attached to the jig board.



### (3) Procedure of downloading

#### (a) Connect the jig and perform downloading

Attach the ROMs on the jig board and connect the board with the connector of the copier.

1. Take off the feed side upper and upper inner cover as well as the metal shield cover.  
(▶ Service Manual ch. 2.5.2)
2. Connect the downloading jig with the jig connector on the SYS board (ROM attached side downward).

**Note:** Turn OFF the power before connecting or disconnecting the jig.

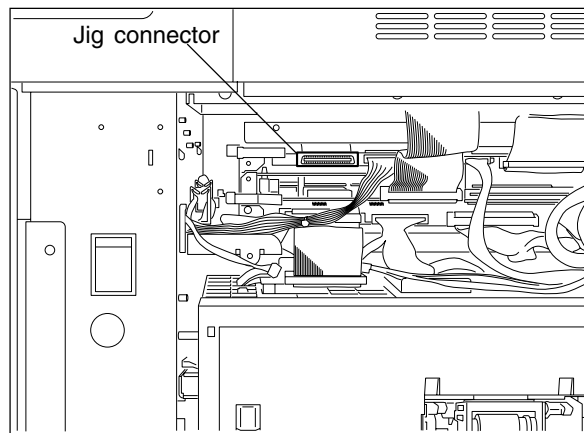

Turn ON the power (downloading is automatically started).

**Note:** Do not turn OFF the power during the downloading.

The processing status is displayed on the control panel during the downloading.

```
Download Board Firmware Update Mode

Download Board -> FROM Update Start.

Check Devices      - Completed
Update FROM        - Installing
Data Check         -
```

“Update Completed!!” is displayed on the control panel when the downloading is completed.  
Turn OFF the power of the copier and disconnect the downloading jig.

```
Download Board Firmware Update Mode

Download Board -> FROM Update Start.

Check Devices      -   Completed
Update FROM        -   Completed
Data Check         -   Completed

Update Completed!!
```

“Update Failed.” is displayed on the control panel when the downloading was not completed successfully. Turn OFF the power, check the downloading jig and copier and attempt the downloading again.

```
Download Board Firmware Update Mode

Download Board -> FROM Update Start.

Check Devices      -   Completed
Update FROM        -   Failed
Data Check         -

Update Failed.
```

**Note:** Check the following in case that the downloading was not performed successfully.

- Check if the ROM is attached properly.
- Check if the ROM data were written correctly.
- Check if the downloading jig is connected properly.
- Check if the HDD is connected properly. (for UI data downloading)

When the UI data and the applications are updated at the same time, perform the downloading successively.

When UI data downloading is performed, the UI data in the HDD are updated but the display UI at power ON in the FROM is not changed. To make the result of updating effective for the display UI at power ON, it is necessary to copy the updated data into the FROM by selecting a language in the setting mode (08-220).

(b) Confirmation of the downloaded data

Check each data version when the downloading is completed to confirm that the downloading was performed correctly. Check the version in the setting mode (08). Confirm that the version numbers shown by entering the following codes match the specified version numbers.

Confirmation for application downloading:

08-900 : System firmware version

08-920 : Basic section software version

08-921 : Program internal (application) version

08-922 : UI data fixed section version

08-923 : UI data common section version

08-930 : Version of language(UI) on the display at power ON in FROM

Confirmation for UI data downloading:

08-924 : Version of UI data 1st language in HDD

08-925 : Version of UI data 2nd language in HDD

08-926 : Version of UI data 3rd language in HDD

08-927 : Version of UI data 4th language in HDD

08-928 : Version of UI data 5th language in HDD

08-929 : Version of UI data 6th language in HDD

08-931 : Version of UI data 7th language in HDD

(4) Screens displayed during the download

(a) Application downloading

The screens change as follows during the application downloading.

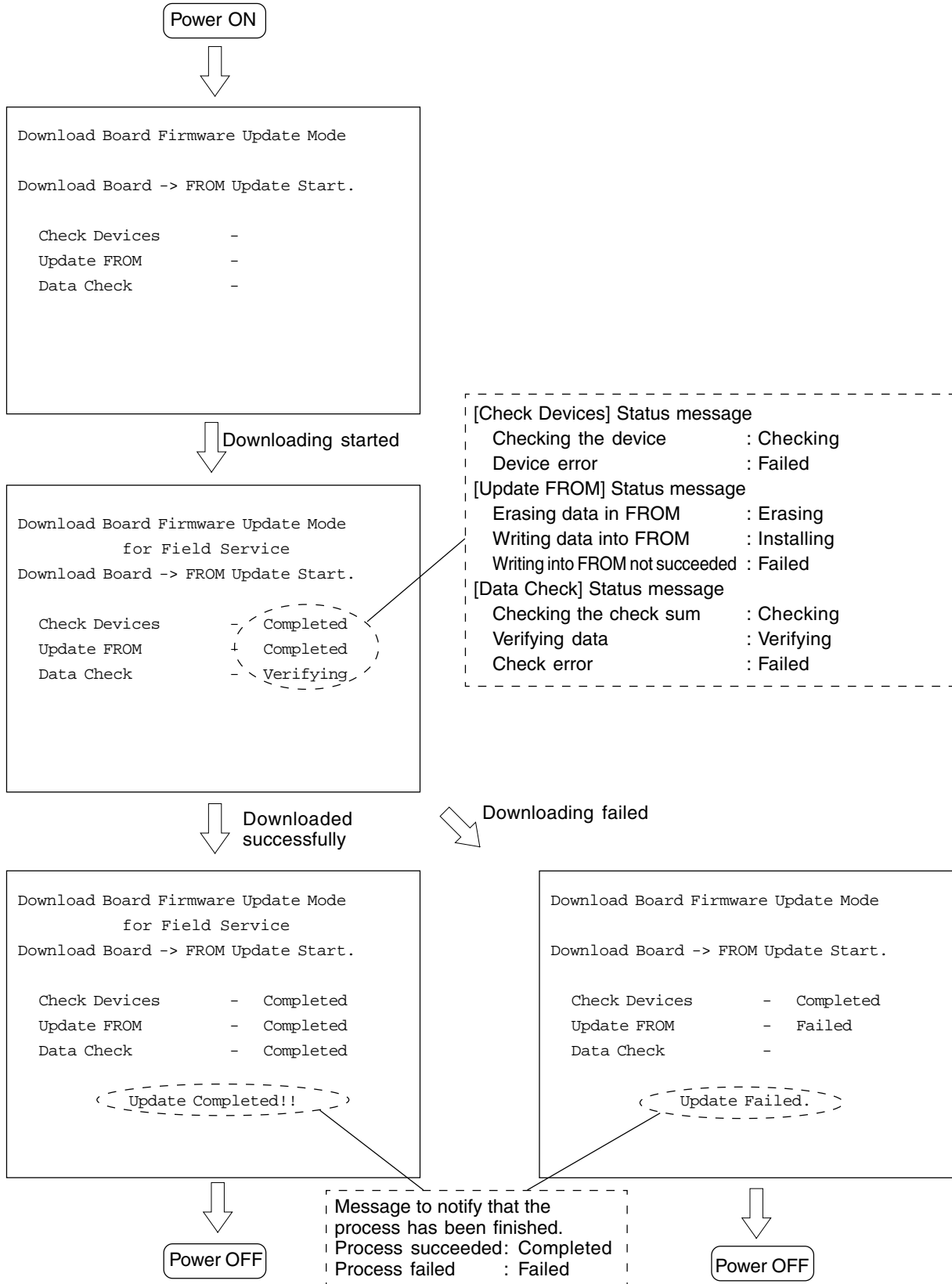

**(b) UI data downloading**

The screens change as follows during the UI data downloading.

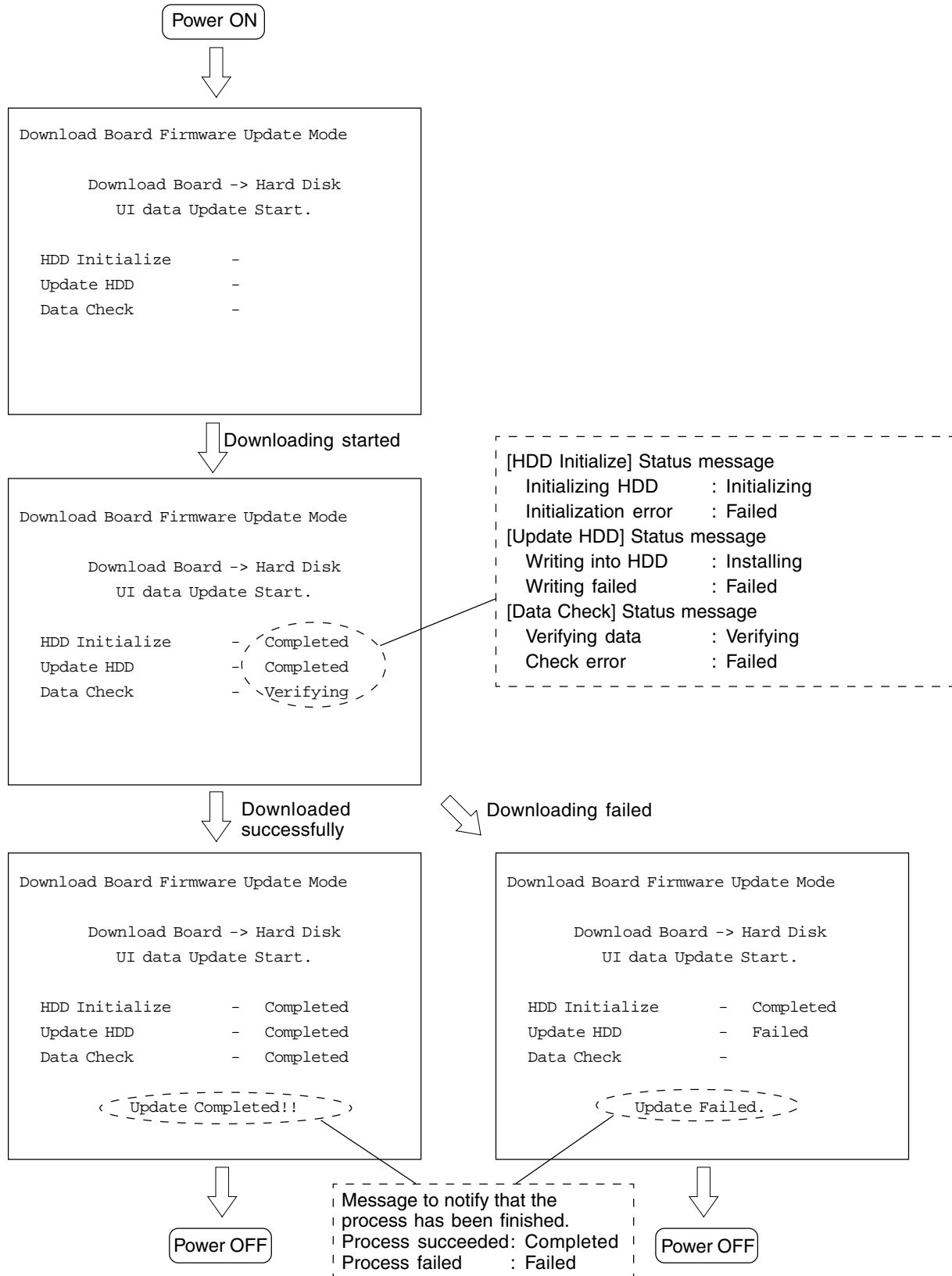

### 5.3.2 Engine firmware

The procedure to update the engine firmware (engine ROM/LGC board, scanner ROM/SCM board and printer ROM/IMC board) is described in this section.

#### (1) Jig board

The engine ROM/LGC board uses K-PWA-DLS-320, the scanner ROM/SCM board and the printer ROM/IMC board use K-PWA-DLM-320 as a jig board to update the engine firmware.

When updating the engine ROM/LGC board, use only the socket for ROM1 of K-PWA-DLS-320. (The socket for ROM2 is not used.) (▶ Page. 5-32)

**Note:** Pay attention to the position and direction of the ROM when it is attached to the jig board.

(2) Downloading

- (a) Attach the ROM to the jig board and connect the board with the jig connector of the copier.

<<Engine ROM/LGC board>>

1. Take off the rear cover. (▶ Service Manual ch. 2.5.1)
2. Connect the downloading jig with the jig connector on the LGC board (ROM attached side leftward).

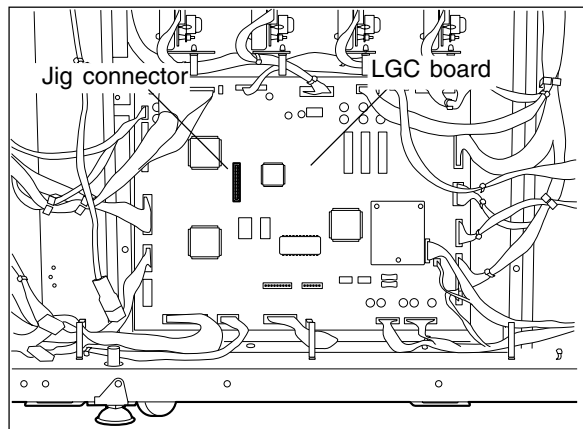

<<Scanner ROM/SCM board>>

**Note:** Remember that the damp heater, lens cover, etc. are hot.

1. Take off the right top cover and feed side upper cover. (▶ Service Manual ch. 2.5.2)  
Then, remove 2 screws to take off the connector cover (plate cover).
2. Connect the downloading jig with the jig connector on the SCM board (ROM attached side upward).

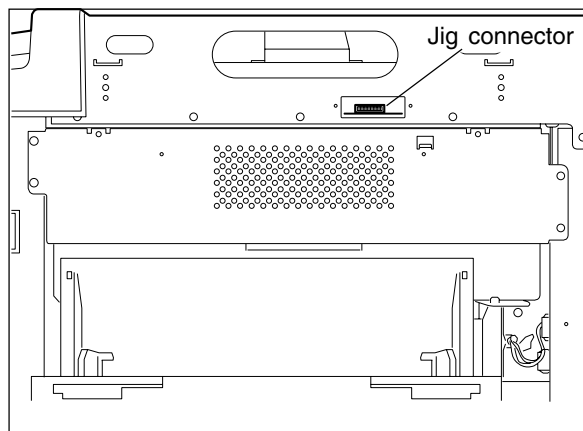

<<Printer ROM/IMC board>>

1. Take off the feed side upper and upper inner cover as well as the metal shield cover.  
(▶ Service Manual ch. 2.5.2)
2. Connect the downloading jig with the jig connector on the IMC board (ROM attached side upward).

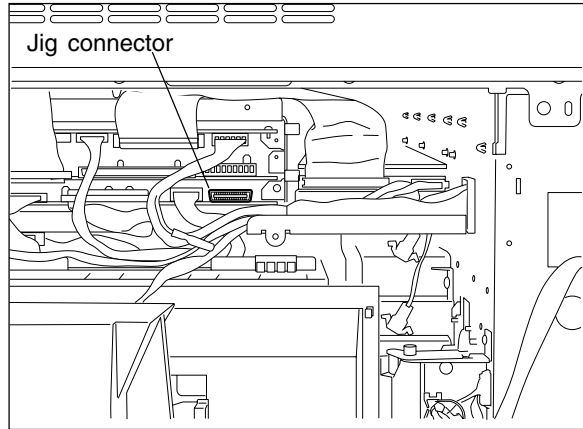

- (b) Turn ON the power while [0] and [8] are pressed simultaneously (downloading is automatically started).
- (c) Turn OFF the power when the LED on the jig board starts flashing. Remove the downloading jig.
- (d) Check the version of the ROM in the setting mode (08) (engine ROM: 08-902, scanner ROM: 08-904, printer ROM: 08-903).

**Notes:**

- It is assumed that the downloading was failed if the LED on the jig board does not start flashing even though 30 seconds have elapsed since the downloading was started. Check if the ROM is attached properly, if the ROM data were written correctly and if the downloading jig is connected properly.
- After the downloading, clean the mirror-1, -2 and -3, the underside of shading correction plate and the original glass if any dust or oil stains on them.



## 6. POWER SUPPLY UNIT

### 6.1 Output Channel

There are four output channels which are not linked with the door switches, as shown below.

(1) 3.3V(M) — For MPU on the SYS board, the image processing circuit, etc.

3.3VA : Pins 4 and 5, J707

Output to: IMC board, SYS board, AI board (via the IMG board), IMG board

3.3VB : Pin 1, J708

Output to: SCM board

(2) 5.1V(M) — For mechanical control circuits on the LGC board, IMC board, SCM board, etc.

5.1VA : Pins 3, 4 and 5, J706

Output to: LGC board

5.1VB : Pins 6 and 7, J707

Output to: IMC board, SYS board, RLY board (via the IMC board),  
AI board (via the IMG board), IMG board

5.1VC : Pins 1, 2, 3 and 4, J710

Output to: built-in printer controller (optional)

5.1VD : Pins 3 and 4, J708

Output to: SCM board

(3) 12V(M) — Mainly for analog circuits and the HDD (e.g. image quality sensor, color registration sensor)

12VA : Pin 10, J706

Output to: LGC board, IMC board (via the LGC board),  
image quality sensor (via the LGC board),  
registration sensor (via the LGC board)

12VB : Pin 7, J708

Output to: SCM board, SDV board (via the SCM board), HDD

12VC : Pins 9, 10, 11 and 12, J710

Output to: built-in printer controller (optional)

(4) 24V(M) — For RADF, the finisher, fans, etc.

24VH : Pin 1, J706

Output to: LGC board

24VI : Pin 9, J708

Output to: SCM board

24VJ : Pins 1 and 3, J709

Output to: finisher

There are two output channels which are linked with the door switches.

(1) 5.1V(D) — For the laser diodes and the laser drivers

5.1VA : Pin 7, J702

Output to: LGC board

5.1VB : Pin 3, J705

Output to: IMC board, RLY board (via the IMC board), LDR board (via the IMC board)

(2) 24V(D) — For the motors, clutches, solenoids, fans, etc.

24VA~C : Pins 1, 2 and 3, J702

Output to: LGC board, paper feed motor (via the LGC board),  
fuser motor (via the LGC board),  
main high-voltage transformer (via the LGC board),  
transfer transformer (via the LGC board)

24VD : Pins 1, 2 and 3, J703

Output to: developer motor

24VE : Pins 6 and 7, J703

Output to: paper feed motor

24VF : Pins 1 and 2, J704

Output to: SCM board

24VG : Pin 1, J705

Output to: IMC board, polygonal motor (via the IMC board), tilt motors (via the IMC board)

24VK : Pins 1, 3, 5, 7, 9, 11, 13, 15, 17 and 19, J711

Output to: LGC board

<Output connector>

Not linked with the door switch:

J706 for the LGC board

J707 for the IMC board, SYS board, RLY board and IMG board

J708 for the scanner and RADF

J709 for the finisher

J710 for the built-in printer controller (optional)

Linked with the door switch:

J702 for the LGC board

J703 for the developer motor and the paper feed motor

J704 for the scanner

J705 for the IMC board, RLY board, LDR board and the polygonal motor

J711 for the drum motors, the transfer belt motor and the LGC board

<Fuse rating>

F 1	12A/125V	Primary side
F 2	12A/125V	
F 3	12A/125V	Secondary side
F 5	4A/125V	
F 6	4A/125V	
F 7	5A/125V	
F 8	4A/125V	
F 9	5A/125V	
F10	4A/125V	
ICP3	12A/125V	
ICP4	3A/125V	
ICP5	3A/125V	
ICP6	3A/125V	

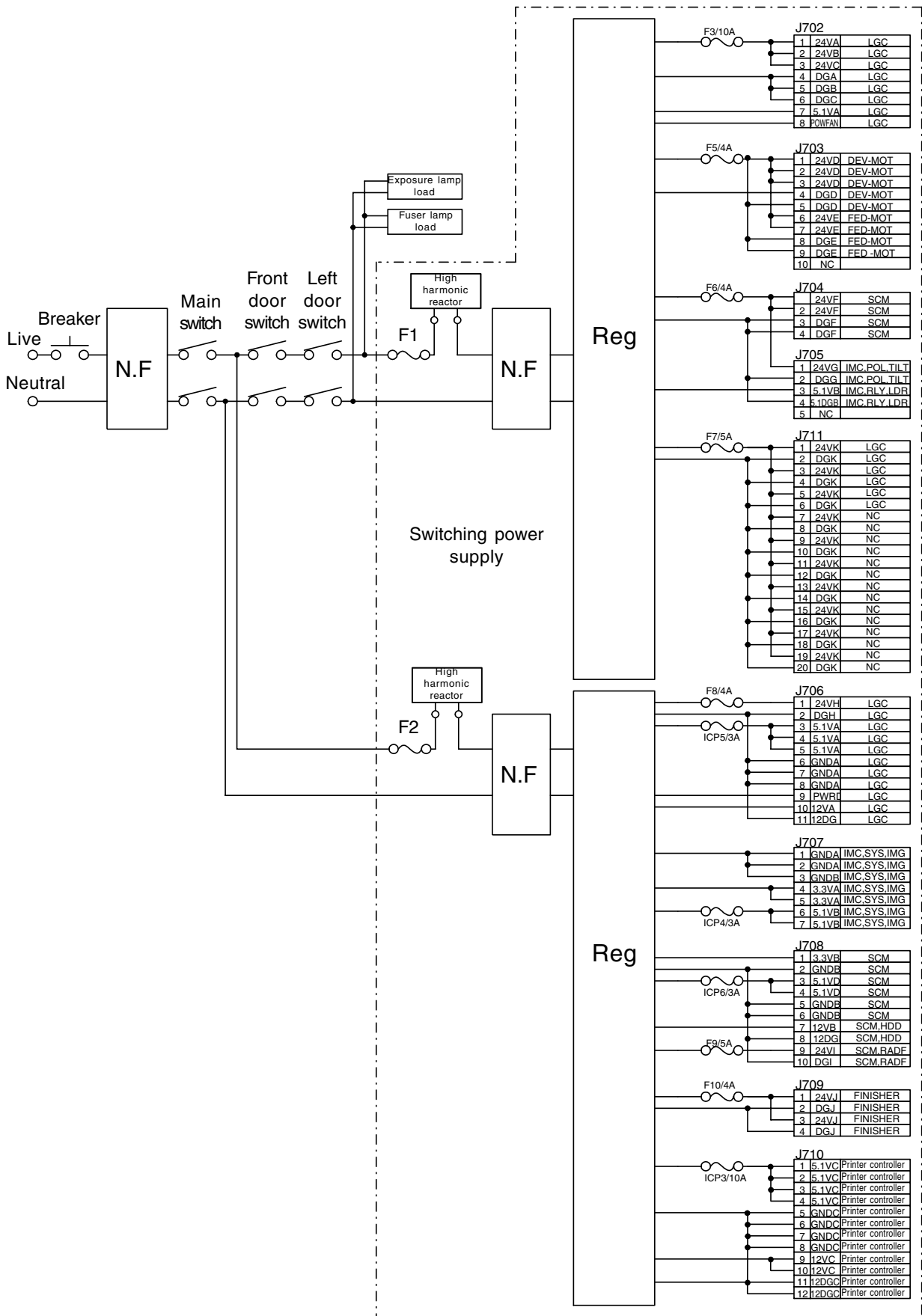

## 7. WIRE HARNESS CONNECTION DIAGRAMS

# 7.1 AC Wire Harness

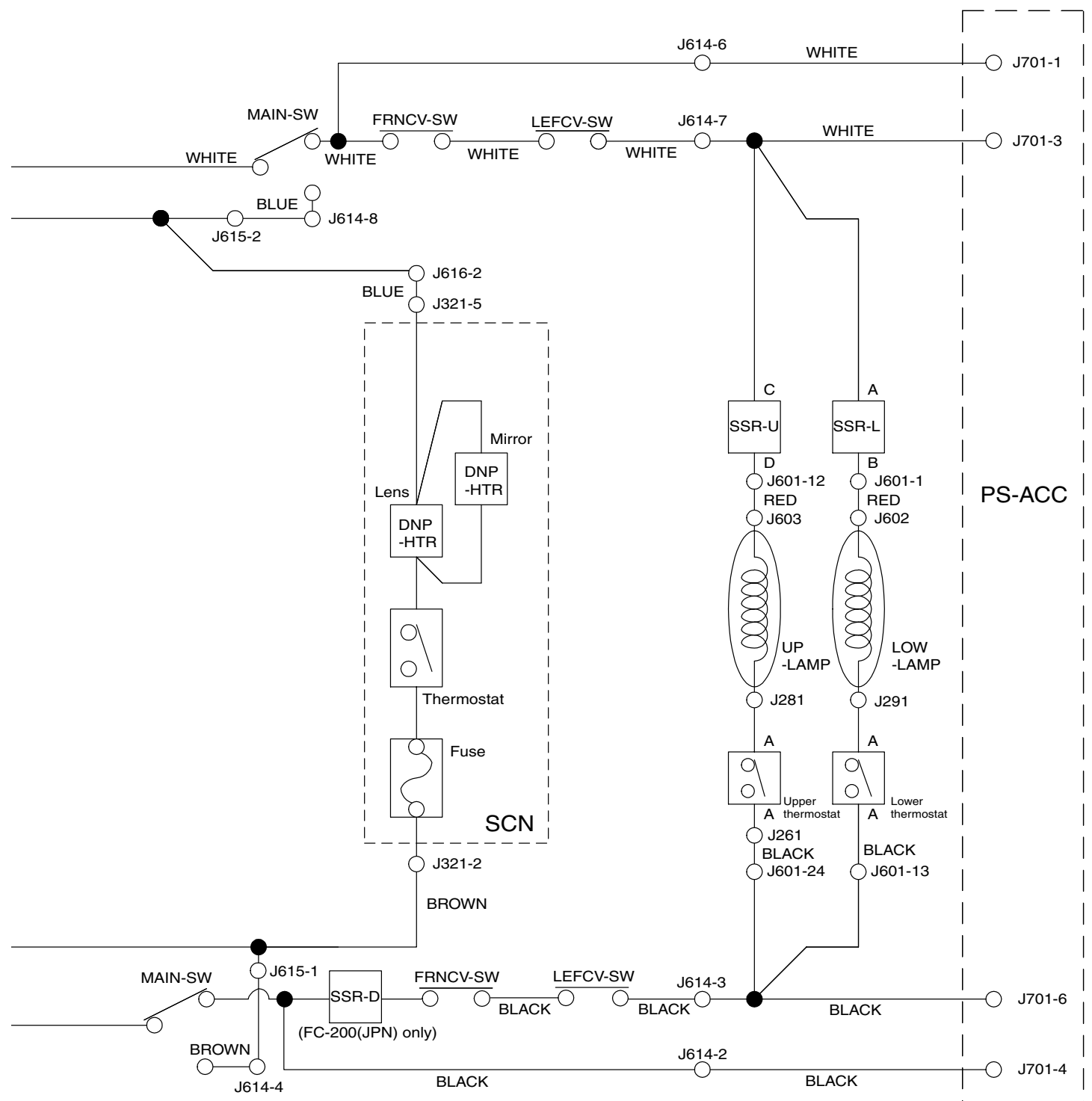
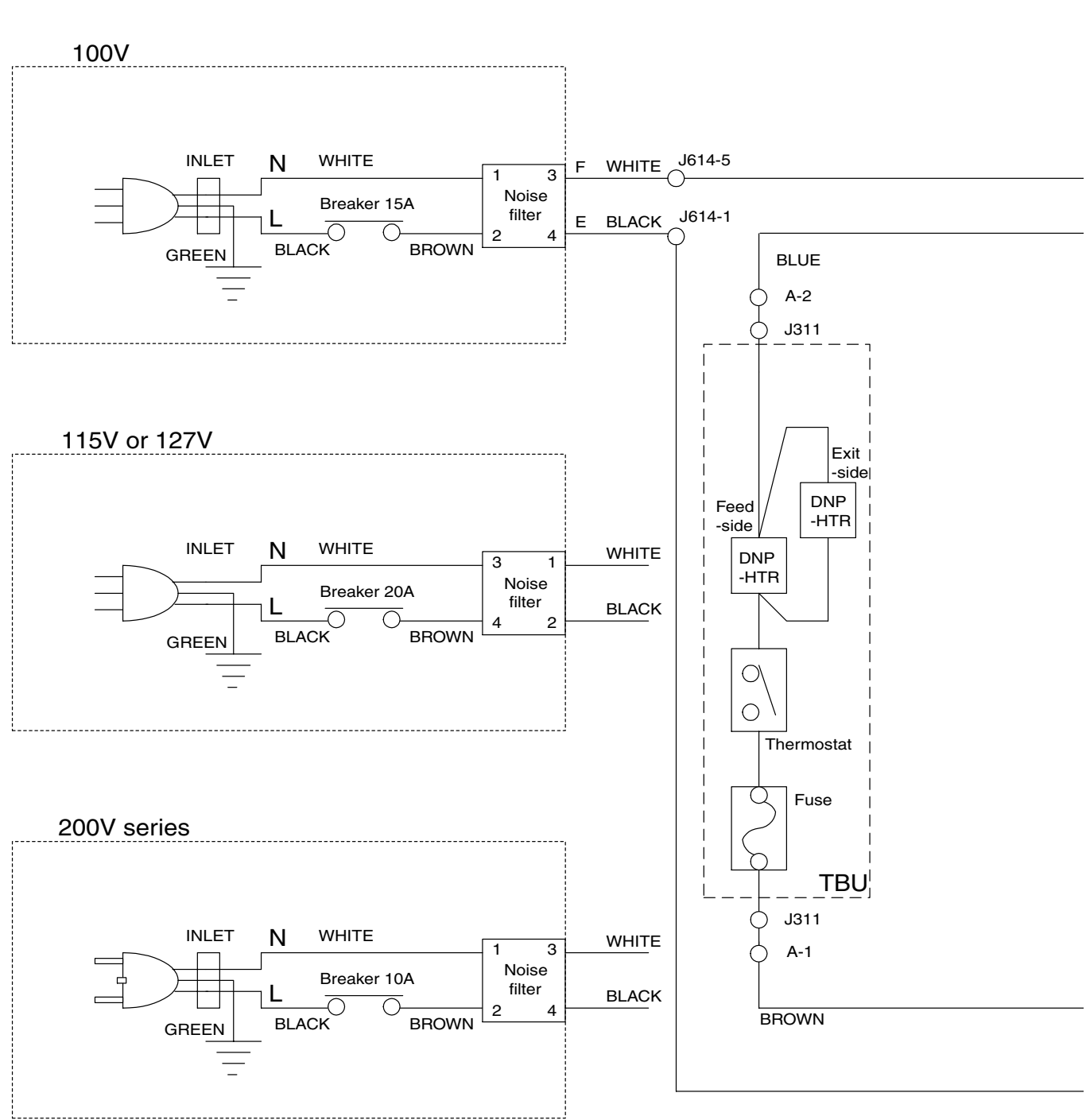







FC-310

Paper supply Paper size		Cassette	Bypass feeding		LCF
			Size specification YES	Size specification NO	
Thin Paper/Normal Paper	A4, LT	31(31)	24(24)	14(14)	31(31)
	B5	31(31)	24(24)	16(16)	–
	A5-R, ST-R	31(31)	24(24)	24(24)	–
	A4-R, B5-R, LT-R	23(23)	19(19)	19(19)	–
	B4, LG	19(19)	16(16)	16(16)	–
	A3, LD	16(16)	14(14)	14(14)	–
	Full bleed (12" x 18")	–	12(12)	12(12)	–
Thick Paper 1	A6-R	–	24(24)	24(24)	–
	A4, LT	10.3(10.3)	10.3(10.3)	10.3(10.3)	10.3(10.3)
	B5, A5-R, ST-R	10.3(10.3)	10.3(10.3)	10.3(10.3)	–
	A4-R, B5-R, LT-R	9.3(9.3)	9.3(9.3)	9.3(9.3)	–
	B4, LG	8.5(8.5)	8.5(8.5)	8.5(8.5)	–
	A3, LD	7.9(7.9)	7.9(7.9)	7.9(7.9)	–
	Full bleed (12" x 18")	–	7.7(7.7)	7.7(7.7)	–
Other	A6-R	–	10.3(10.3)	10.3(10.3)	–
	Thick Paper 2(All size)	–	2~6 (2~6)	2~6 (2~6)	–
	Thick Paper 3(All size)	–	2~6 (2~6)	2~6 (2~6)	–
	OHP films (A4, LT)	3.3(3.3)	3.3(3.3)	–	–

\*Thin paper:64~79 g/m<sup>2</sup>, or 17~20 lb.

\*Normal paper:80~105 g/m<sup>2</sup>, or 21~28 lb.

\*Thick paper 1:106~163 g/m<sup>2</sup>, or 29lbs.~60 lb. cover/90lb. index

\*Thick paper 2: 164g/m<sup>2</sup> ~209 g/m<sup>2</sup>, or 91~110 lb. index

\*Thick paper 3: 210~256 g/m<sup>2</sup>, or 111~140 lb. index

\* Values in parentheses ( ) are the copy speed in the black mode copying.

\* “–” means “not available”.

\* The copy speeds listed are available when originals are manually placed for single-side, multiple copying.

\* When the document feeder is used, the copy speed of 21 sheets per minute (FC-210) or 31 sheets per minute (FC-310) is only available under the following conditions:

- Original/Mode: Single-side originals of A4/LT size, not selecting auto color, APS, automatic density and advance image enhancement mode
- Number of sheets set: 21 or over (FC-210) , 31 or over (FC- 310)
- Paper feeding: 2nd cassette
- Reproduction ratio: Actual ratio

\* Reverse side copying speed of the automatic duplexing unit

(When specific paper size is selected)

A4, B5, A5-R, LT, ST-R:	21 sheets/min. (FC-210),	31 sheets/min. (FC-310)
A4-R, B5-R, LT-R:	17 sheets/min. (FC-210),	23 sheets/min. (FC-310)
B4, LG:	14 sheets/min. (FC-210),	19 sheets/min. (FC-310)
A3, LD:	12 sheets/min. (FC-210),	16 sheets/min. (FC-310)

\* System copy speed

Copy mode		Copies/min.
Single-sided originals	1 set	16 [18]
↓	3 sets	19 [25]
Single-sided copies	5 sets	19 [27]
Single-sided originals	1 set	8 [9]
↓	3 sets	14 [17]
Two-sided copies	5 sets	16 [21]
Two-sided originals	1 set	7 [7]
↓	3 sets	12 [15]
Two-sided copies	5 sets	14 [18]
Two-sided originals	1 set	11 [11]
↓	3 sets	16 [19]
Single-sided copies	5 sets	18 [23]

- \* Values in square brackets [ ] are for FC-310.
- \* The copy speeds are applicable when 10 A4-sized originals are set in the automatic document feeder and are copied with any of the modes listed on the left. The first copy time is included.
- \* These values are attained in full color mode copying.

• Copy paper

	Cassette	Duplex copy	LCF	Bypass copy	Remarks
Size	A3~A5R LD~ST-R		A4, LT	A3~A5-R LD~ST-R	In the bypass mode, either irregular sizes or arbitrary sizes can be set.
Weight	64~163g/m <sup>2</sup> 17lb~60lb.cover ~90lb.index	64~105g/m <sup>2</sup> 17~28 lb.	64~163g/m <sup>2</sup> 17lb~60lb.cover ~90lb.index	64~256g/m <sup>2</sup> 17lb~140lb.index	
Special paper	–	–	–	Recommended OHP films and sticker labels	

- First copy time ..... Approx. 9.5 seconds (A4/LT, the first cassette, 100%)
- Warming-up time ..... Approx. 4 minutes
- Multiple copying ..... Up to 999 copies; entry by digital keys
- Reproduction ratio ..... Actual ratio: 100±0.5%  
Zooming: 25~400% in increments of 1%
- Resolution/Gradation ..... Read: 600 dpi (10 bit)  
Write: Corresponding to 600 dpi x 600 dpi  
(primary scanning only : 256 division smoothing)
- Excluded image width ..... Leading edge: 5.0±2.0 mm, Trailing edge: 2.5±2.0 mm  
Side edge: 2.0±2.0 mm
- Paper feeding ..... Automatic feeding: Cassettes – 2 pieces standard (expandable up to 4 pieces by installing optional cassettes)  
LCF – Optional (Stack height 165 mm : equivalent to 1500 sheets of 80 g/m<sup>2</sup>, 20 lb.)  
Bypass feeding: (Stack height 21 mm : equivalent to 130 sheets of 80 g/m<sup>2</sup>, 20 lb.)

- Capacity for originals ..... A4, A4-R, B5, B5-R, A5-R, LT, LT-R, ST-R: 50 sheets (64~90g/m<sup>2</sup>) (17~24 lb.)  
 (Optional automatic document feeder) 40 sheets (91~105g/m<sup>2</sup>) (25~28 lb.)  
 B4, Folio, LG, Comp: 35 sheets (64~90g/m<sup>2</sup>) (17~24 lb.)  
 25 sheets (91~105g/m<sup>2</sup>) (25~28 lb.)  
 A3, LD: 25 sheets (64~90g/m<sup>2</sup>) (17~24 lb.)  
 20 sheets (91~105g/m<sup>2</sup>)(25~28 lb.)
- Stacking capacity of sheets Paper weight 64~105 g/m<sup>2</sup>, 17~28 lb.: 30 sheets  
 (Optional automatic duplexing unit)
- Toner supplying ..... Automatic toner-density detection and supply  
 Toner cartridge replacing method
- Density control ..... Automatic density mode and manual density mode selectable in 11 steps
- Weight ..... Approx. 187 kg/413lb.
- Power requirements ..... AC 115V/16A, AC 220 – 240V/9A
- Power consumption ..... 2.0 kW or less (115V series, 200V series)
  - \* The automatic document feeder, automatic duplexing unit and LCF are supplied with electric power through the copier.
- Power consumption and warm-up time at energy saving mode

	Mode		Power Consumption	Warm-up time	Efficiency
115V series	Energy saving mode	Level 1	Approx. 100W (Approx. 135W)	Approx. 2 min 30 sec.	Approx. 56% (Approx. 48%)
		Level 2	Approx. 160W (Approx. 195W)	Approx. 1 min 15 sec.	Approx. 29% (Approx. 25%)
	Normal standby		Approx. 225W (Approx. 260W)	0	0% (0%)
200V series	Energy saving mode	Level 1	Approx. 100W (Approx. 135W)	Approx. 2 min 15 sec.	Approx. 57% (Approx. 49%)
		Level 2	Approx. 160W (Approx. 195W)	Approx. 1 min 15 sec.	Approx. 30% (Approx. 26%)
	Normal standby		Approx. 230W (Approx. 265W)	0	0% (0%)

\* Values in parentheses ( ) are when the copier is with full options: The automatic document feeder, automatic duplexing unit, large-capacity feeder, finisher, hole punch unit, cassette modules and AI board

\* Level 1: Energy saver mode with priority aim of energy saving

Level 2: Energy saver mode with priority aim of returning to standby

- Dimensions..... See the figure below (W868 x D750 x H997mm)

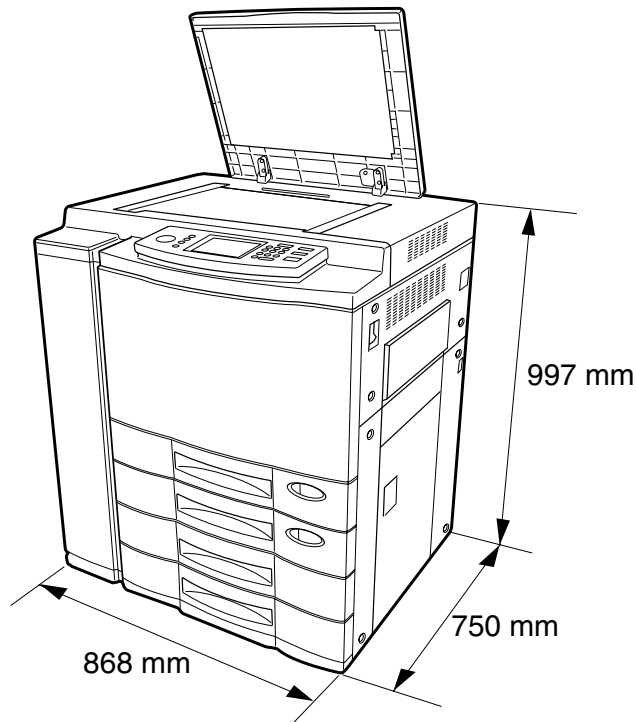

## 2. Accessories

Setup instructions	1 pc.
Operator's manual	1 pc. (not available for MJD)
Color copy guide	1 pc. (not available for MJD)
PM sticker	1 pc. (for MJD)
Setup report	1 set. (for NAD and MJD)
CS card	1 pc. (for MJD)
Drum	4 pcs.
Operator's manual pocket	1 pc.
Detachable code	1 pc. (for ASD, AUD and MJD)
Copy receiving tray	1 pc.
Preventive maintenance check list	1 pc. (for MJD)
Toner bag symbol sticker	1 pc. (for MJD)
Warrantee sheet	1 pc. (for NAD)
DF level up kit	1 pc.

### \* Machine version

- NAD: North America
- MJD: Europe
- AUD: Australia
- ASD: Asia

### 3. Options

Platen cover	KA-2060PC
Automatic document feeder (RADF)	MR-3006A, MR-3006E
Automatic duplexing unit (ADU)	MD-5007
Cassette module	MY-1020
Slot cover	KE-FC22
Large capacity feeder (LCF)	MP-1503LT,MP1503A4
Finisher	MJ-1019, MJ-1020 (with saddle stitching function)
Hole punch unit	MJ-6002N,MJ-6002E,MJ-6002F,MJ-6002S
Staple cartridge	STAPLE-700 STAPLE-600 (for saddle stitching)
External printer controller (Fiery Z5)	GA-1130
Built-in printer controller (Fiery New X3e)	GA-1120
Video I/F kit for external controller connection	KR-8005
Control panel kit for built-in controller	KR-8006
Key copy counter, Key copy counter socket	MU-8, MU-10
Work table	KK-2460
Work table kit	KN-FC22W01
AI board	KR-2030
Damp heater kit	MF-FC22U, MF-FC22E
Operator's manual (English, French, German, Spanish, Italian)	MANUAL FC31
Color copy guide (English, French, German, Spanish, Italian)	GUIDE FC31

### 4. Replacement Units/Supplies

#### (1) Replacement units

Electrophotographic processing unit (EPU)	EPU-FC31
Transfer belt unit (TBU)	TR-BLT-FC31
Fuser unit	FUSER-FC31-115/127/200

#### (2) Supplies

Toner Y (Yellow)	PS-ZTFC31Y, PS-ZTFC31EY
Toner M (Magenta)	PS-ZTFC31M, PS-ZTFC31EM
Toner C (Cyan)	PS-ZTFC31C, PS-ZTFC31EC
Toner K (Black)	PS-ZTFC31K, PS-ZTFC31EK
Toner bag	PS-TBFC22, PS-TBFC22E

## 5. System List

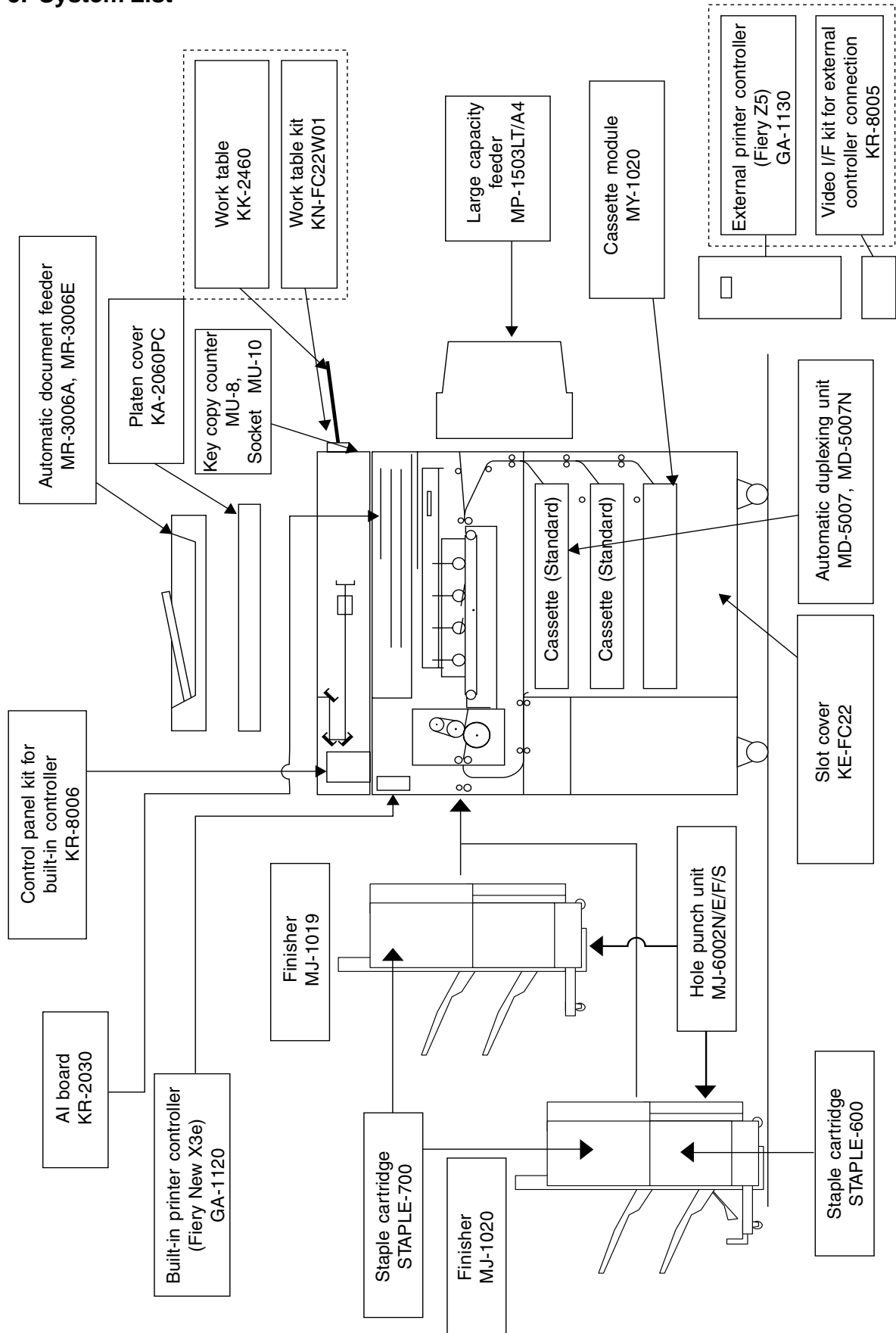

## Free Manuals Download Website

<http://myh66.com>

<http://usermanuals.us>

<http://www.somanuals.com>

<http://www.4manuals.cc>

<http://www.manual-lib.com>

<http://www.404manual.com>

<http://www.luxmanual.com>

<http://aubethermostatmanual.com>

Golf course search by state

<http://golfingnear.com>

Email search by domain

<http://emailbydomain.com>

Auto manuals search

<http://auto.somanuals.com>

TV manuals search

<http://tv.somanuals.com>