

surveillix

EVR - DVR - HVR Digital Video Recorder

User Manual

model no. DVR8-X
EVR8-X
HVR8-X
DVR16-X
EVR16-X
HVR16-X
EVR32-X
HVR32-X

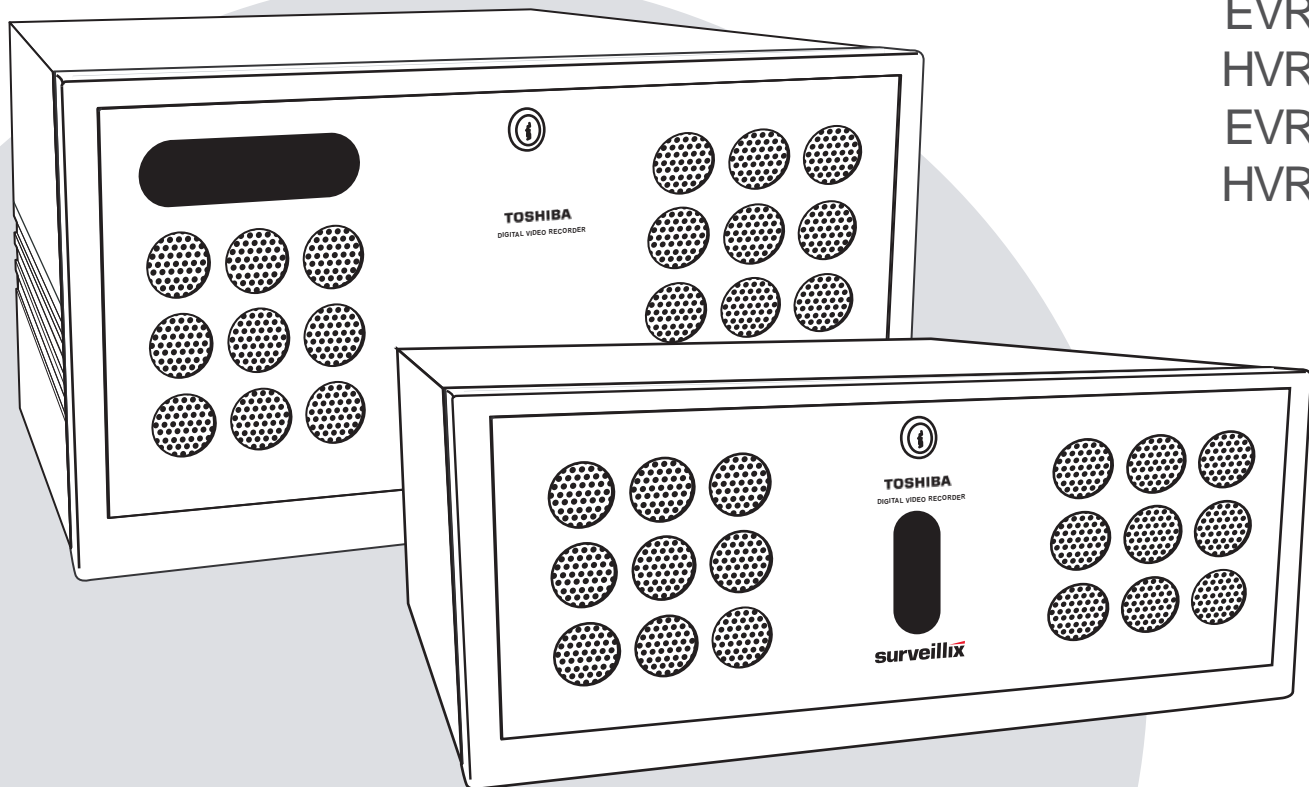

Please carefully read these instructions before using this product.
Save this manual for future use.

TOSHIBA

Surveillix™ EVR/DVR/HVR

User Manual

Manual Edition 28099AD – NOVEMBER 2008

Printed in USA

No part of this documentation may be reproduced in any means, electronic or mechanical, for any purpose, except as expressed in the Software License Agreement. Toshiba shall not be liable for technical or editorial errors or omissions contained herein. The information in this document is subject to change without notice.

THE INFORMATION IN THIS PUBLICATION IS PROVIDED "AS IS" WITHOUT WARRANTY OF ANY KIND. THE ENTIRE RISK ARISING OUT OF THE USE OF THIS INFORMATION REMAINS WITH RECIPIENT. IN NO EVENT SHALL TOSHIBA BE LIABLE FOR ANY DIRECT, CONSEQUENTIAL, INCIDENTAL, SPECIAL, PUNITIVE, OR OTHER DAMAGES WHATSOEVER (INCLUDING WITHOUT LIMITATION, DAMAGES FOR LOSS OF BUSINESS PROFITS, BUSINESS INTERRUPTION OR LOSS OF BUSINESS INFORMATION), EVEN IF TOSHIBA HAS BEEN ADVISED OF THE POSSIBILITY OF SUCH DAMAGES AND WHETHER IN AN ACTION OR CONTRACT OR TORT, INCLUDING NEGLIGENCE.

This software and documentation are copyrighted. All other rights, including ownership of the software, are reserved to DVR Support Center. TOSHIBA, and Surveillix are registered trademarks of TOSHIBA CORPORATION in the United States and elsewhere; Windows, and Windows XP are registered trademarks of Microsoft Corporation. All other brand and product names are trademarks or registered trademarks of the respective owners.

The following words and symbols mark special messages throughout this guide:



WARNING: Text set off in this manner indicates that failure to follow directions could result in bodily harm or loss of life.



CAUTION: Text set off in this manner indicates that failure to follow directions could result in damage to equipment or loss of information.

LIMITED WARRANTY DIGITAL VIDEO RECORDER

The Imaging Systems Division of Toshiba America Information Systems, Inc. ("ISD") makes the following limited warranties. These limited warranties extend to the Original End-User ("You[r]").

Limited Two (2) Year Warranty of Labor and Parts

The Imaging Systems Division of Toshiba America Information Systems warrants this product and parts against defects in material or workmanship for a period of two years from the date of original retail purchase by the end-user. During this period, ISD will repair or replace a defective product or part with a new or refurbished item. The user must deliver the entire product to the Surveillix DVR Repair Facility. The user is responsible for all transportation and insurance charges for the product to the DVR Repair Facility. ISD reserves the right to substitute Factory Refurbished Parts and / or Factory Refurbished Product in place of those in need of repair.

Step-by-step Procedures – How to Obtain Warranty Service

[1] Verify operation of the unit by checking the instruction manual and web site for the latest updates at

www.toshiba.com/taisisd

[2] If there is a defect in material or workmanship, contact the Surveillix DVR Support Center at (877) 855-1349 [877-1-FIX] to speak to a technical support representative and schedule service.

[3] Arrange for delivery of the product to the Surveillix DVR Repair Facility. Products must be insured and securely packed, preferably in the original shipping carton. A letter explaining the defect and a copy of the bill of sale or other proof of purchase must be enclosed with a complete return street address and daytime telephone number. The Tracking Number should also be indicated on your documents. Charges for transportation and insurance must be prepaid by the end-user.

Critical Use Disclaimer

The product is not designed for any "critical applications." "Critical applications" means life support systems, exhaust or smoke extraction applications, medical applications, commercial aviation, mass transit applications, military applications, homeland security applications, nuclear facilities or systems or any other applications where product failure could lead to injury to persons or loss of life or catastrophic property damage. Accordingly, Toshiba disclaims any and all liability arising out of the use of the product in any critical applications.

Your Responsibilities

The above warranty is subject to the following conditions:

[1] You must retain the bill of sale or provide other proof of purchase.

[2] You must schedule service within thirty days after you discover a defective product or part.

[3] All warranty servicing of this product must be made by the Surveillix DVR Repair Facility.

[4] The warranty extends to defects in material or workmanship as limited above, and not to any products or parts that have been lost or discarded by user. The warranty does not cover damage caused by misuse, accident, improper installation, improper maintenance, or use in violation of instructions furnished by ISD. The warranty does not extend to units which have been altered or modified without authorization of ISD, or to damage to products or parts thereof which have had the serial number removed, altered defaced or rendered illegible.

ALL WARRANTIES IMPLIED BY STATE LAW, INCLUDING THE IMPLIED WARRANTIES OF MERCHANTABILITY AND FITNESS FOR A PARTICULAR PURPOSE, ARE EXPRESSLY LIMITED TO THE DURATION OF THE LIMITED WARRANTIES SET FORTH ABOVE. Some states do not allow limitations on how long an implied warranty lasts, so the above limitation may not apply. WITH THE EXCEPTION OF ANY WARRANTIES IMPLIED BY STATE LAW AS HEREBY LIMITED, THE FOREGOING EXPRESS WARRANTY IS EXCLUSIVE AND IN LIEU OF ALL OTHER WITH RESPECT TO THE REPAIR OR REPLACEMENT OF ANY PRODUCTS OR PARTS. IN NO EVENT SHALL ISD BE LIABLE FOR CONSEQUENTIAL OR INCIDENTAL DAMAGES. Some states do not allow the exclusion or limitation of incidental or consequential damages so the above limitation may not apply.

No person, agent, distributor, dealer, service station or company is authorized to change, modify or extend the terms of these warranties in any manner whatsoever. The time within which an action must be commenced to enforce any obligation of ISD arising under this warranty or under any statute, or law of the United States or any state thereof, is hereby limited to one year from the date you discover or should have discovered, the defect. This limitation does not apply to implied warranties arising under state law. Some states do not permit limitation of the time within which you may bring an action beyond the limits provided by state law so the above provision may not apply to user. This warranty gives the user specific legal rights, and user may also have other rights, which may vary from state to state.

TOSHIBA AMERICA INFORMATION SYSTEMS, INC.
Imaging Systems Division

Copyright © 2007 Toshiba America Information Systems, Inc. All rights reserved.

TOSHIBA

IMPORTANT SAFEGUARDS

1. **Read Owner's Manual** – After unpacking this product, read the owner's manual carefully, and follow all the operating and other instruction
2. **Power Sources** – This product should be operated only from the type of power source indicated on the label. If not sure of the type of power supply to your home or business, consult product dealer or local power company
3. **Ventilation** – Slots and openings in the cabinet are provided for ventilation and to ensure reliable operation of the product and to protect it from overheating, and these openings must not be blocked or covered. The product should not be placed in a built-in installation such as a bookcase or rack unless proper ventilation is provided or the manufacturer's instructions have been adhered to.
4. **Heat** – The product should be situated away from heat sources such as radiators, heat registers, stoves, or other products that produce heat.
5. **Water and Moisture** – Do not use this product near water. Do not exceed the humidity specifications for the product as detailed in the Appendix section in this manual
6. **Cleaning** – Unplug this product from the wall outlet before cleaning. Do not use liquid cleaners or aerosol cleaners. Use a damp cloth for cleaning.
7. **Power Cord Protection** – Power-supply cords should be routed so that they are not likely to be walked on or pinched by items placed against them, paying particular attention to cords at plugs, convenience receptacles, and the point where they exit from the product.
8. **Overloading** – Do not overload wall outlets, extension cords, or integral convenience receptacles as this can result in a risk of fire or electrical shock.
9. **Lightning** – For added protection for this product during storm, or when it is left unattended and unused for long periods, unplug it from the wall outlet. This will prevent damage to the product due to lightning and power line surges.
10. **Object and Liquid Entry Points** – Never insert foreign objects into the DVR unit, other than the media types approved by Toshiba, as they may touch dangerous voltage points or short-out parts that could result in a fire or electrical shock. Never spill liquid of any kind on the product.
11. **Accessories** – Do not place this product on an unstable cart, stand, tripod, bracket, or table. The product may fall, causing serious personal injury and serious damage to the product.
12. **Disc Tray** – Keep fingers well clear of the disc tray as it is closing. Neglecting to do so may cause serious personal injury.
13. **Burden** – Do not place a heavy object on or step on the product. The object may fall, causing serious personal injury and serious damage to the product.
14. **Disc** – Do not use a cracked, deformed, or repaired disc. These discs are easily broken and may cause serious personal injury and product malfunction.

IMPORTANT SAFEGUARDS, continued

15. **Damage Requiring Service** – Unplug the unit from the outlet and refer servicing to qualified service personnel under the following conditions:
 - When the power-supply cord or plug is damaged.
 - If liquid has been spilled, or objects have fallen into the unit.
 - If the unit has been exposed to rain or water.
 - If the unit does not operate normally by following the operating instructions. Adjust only those controls that are covered by the operating instructions as an improper adjustment of other controls may result in damage and will often require extensive work by a qualified technician to restore the unit to its normal operation.
 - If the unit has been dropped or the enclosure has been damaged.
 - When the unit exhibits a distinct change in performance – this indicates a need for service.
16. **Servicing** – Do not attempt to service this product as opening or removing covers may expose the user to dangerous voltage or other hazards. Refer all servicing to qualified personnel.
17. **Replacement Parts** – When replacement parts are required, be sure the service technician has used replacement parts specified by the manufacturer or have the same characteristics as the original part. Unauthorized substitutions may result in fire, electric shock or other hazards.
18. **Safety Check** – Upon completion of any service or repairs to this unit, ask the service technician to perform safety checks to determine that the unit is in proper operating condition.

NOTES ON HANDLING

Please retain the original shipping carton and/or packing materials supplied with this product. To ensure the integrity of this product when shipping or moving, repackage the unit as it was originally received from the manufacturer.

Do not use volatile liquids, such as aerosol spray, near this product. Do not leave rubber or plastic objects in contact with this product for extended periods of time. Rubber or plastic objects left in contact with this product for extended periods of time will leave marks on the finish.

The top and rear panels of the unit may become warm after long periods of use. This is not a malfunction.

NOTES ON LOCATING

Place this unit on a level surface. Do not use it on a shaky or unstable surface such as a wobbling table or inclined stand.

If this unit is placed next to a TV, radio, or VCR, the playback picture may become poor and the sound may be distorted. If this happens, place the DVR unit away from the TV, radio, or VCR.

NOTES ON CLEANING

Use a soft dry cloth for cleaning.

For stubborn dirt, soak the cloth in a weak detergent solution, wring well and wipe. Use a dry cloth to wipe it dry. Do not use any type of solvent, such as thinner and benzene, as they may damage the surface of the DVR unit.

If using a chemical saturated cloth to clean the unit, follow that product's instructions.

NOTES ON MAINTENANCE

This DVR unit is designed to last for long periods of time. To keep the DVR unit always operational we recommend regular inspection maintenance (cleaning parts or replacement). For details, contact the nearest dealer.

NOTES ON MOISTURE CONDENSATION

Moisture condensation damages the DVR unit. Read the following information carefully.

Moisture condensation occurs during the following cases:

When this product is brought directly from a cool location to a warm location.

When this product is moved to a hot and humid location from a cool location.

When this product is moved to a cool and humid location from a warm location.

When this product is used in a room where the temperature fluctuates.

When this product is used near an air-conditioning unit vent

When this product is used in a humid location.

Do not use the DVR unit when moisture condensation may occur.

If the DVR unit is used in such a situation, it may damage discs and internal parts. Remove any CD discs, connect the power cord of the DVR unit to the wall outlet, turn on the DVR unit, and leave it for two to three hours. After two to three hours, the DVR unit will warm up and evaporate any moisture. Keep the DVR unit connected to the wall and moisture will seldom occur.

WARNING

TO REDUCE THE RISK OF ELECTRICAL SHOCK, DO NOT EXPOSE THIS APPLIANCE TO RAIN OR MOISTURE.
DANGEROUS HIGH VOLTAGES ARE PRESENT INSIDE THE ENCLOSURE.
DO NOT OPEN THE CABINET.
REFER SERVICING TO QUALIFIED PERSONNEL ONLY.

CAUTION

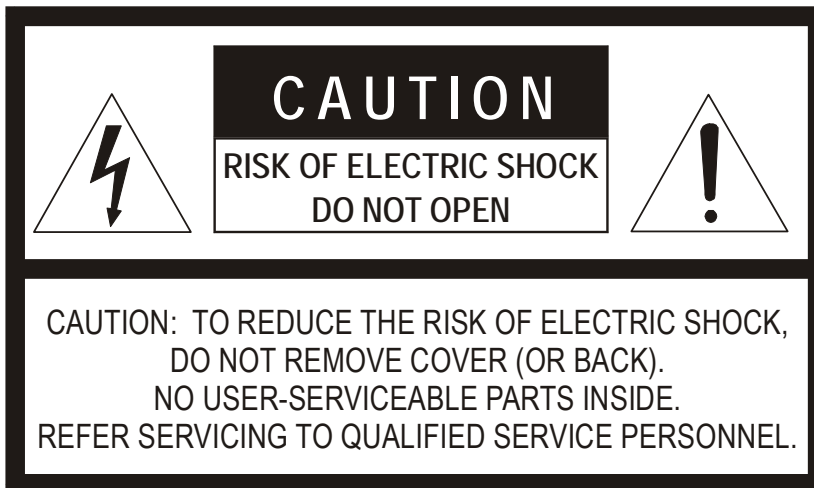

EXPLANATION OF GRAPHICAL SYMBOLS



The lightning flash with arrowhead symbol, within an equilateral triangle, is intended to alert the user to the presence of un-insulated "dangerous voltage" within the product's enclosure that may be of sufficient magnitude to constitute a risk of electric shock to persons.



The exclamation point within an equilateral triangle is intended to alert the user to the presence of important operating and maintenance (servicing) instruction in the literature accompanying the product.

RACK MOUNT INSTRUCTIONS

Elevated Operating Ambient – If installed in a closed or multi-unit rack assembly, the operating ambient temperature of the rack environment may be greater than room ambient. Therefore, consideration should be given to installing the equipment in an environment compatible with the maximum ambient temperature (T_{ma}) specified by the manufacturer.

Reduced Air Flow – Installation of the equipment in a rack should be such that the amount of airflow required for safe operation of the equipment is not compromised.

Mechanical Loading – Mounting of the equipment in the rack should be such that a hazardous condition is not achieved due to uneven mechanical loading.

Circuit Overloading – Consideration should be given to the connection of the equipment to the supply circuit and the effect that overloading of the circuits might have on over current protection and supply wiring. Appropriate consideration of equipment nameplate ratings should be used when addressing this concern.

Grounding – Grounding of rack-mounted equipment should be maintained. Particular attention should be given to supply connections other than direct connections to the branch circuit (e.g. use of power strips).

FCC STATEMENT

This equipment has been tested and found to comply with the limits for a Class A digital device, pursuant to Part 15 of the FCC Rules. These limits are designed to provide reasonable protection against harmful interference when the equipment is operated in a commercial environment. This equipment generates, uses, and can radiate radio frequency energy and, if not installed and used in accordance with the instruction manual, may cause harmful interference to radio communications. Operation of this equipment in a residential area is likely to cause harmful interference in which case the user will be required to correct the interference at his own expense.

UL NOTICE

Underwriters Laboratories Inc. has not tested the performance or reliability of the security or signaling aspects of this product. UL has only tested for fire, shock and casualty hazards as outlined in UL's Standard for Safety UL 60950-1. UL Certification does not cover the performance or reliability of the security or signaling aspects of this product. UL MAKES NO REPRESENTATIONS, WARRANTIES OR CERTIFICATIONS WHATSOEVER REGARDING THE PERFORMANCE OR RELIABILITY OF ANY SECURITY OR SIGNALING RELATED FUNCTIONS OF THIS PRODUCT.

CE NOTICE

This product is in conformity with the following European Directives:

ELECTROMAGNETIC COMPATIBILITY DIRECTIVE, 89/336/EEC
(as amended by 92/31/EEC and by Article 5 of 93/68/EEC)

per the provisions of:

EN 55022:1994

EN 55024:1998

EN 61000-4-4:1995

EN 61000-3-2:1995

CISPR 24:1997

EN 61000-4-5:1995

EN 61000-3-3:1995

EN 61000-4-2:1995

EN 61000-4-6:1995

CISPR 22:1997

EN 61000-4-3:2002

EN 61000-4-11:1994

LOW VOLTAGE DIRECTIVE, 73/23/EEC
(as amended by Article 13 of 93/68/EEC)

per the provisions of:

EN 60950-1: 2001

Table of Contents

PREFACE	1
ABOUT THIS GUIDE	1
TECHNICIAN NOTES.....	1
INTRODUCTION	3
PRODUCT DESCRIPTION	3
FEATURES	4
CONTROLS AND CONNECTIONS	5
SYSTEM SPECIFICATIONS.....	6
FRONT PANEL CONTROLS AND LEDS	6
DVR/HVR	6
EVR/HVR.....	7
REAR PANEL CONNECTORS	8
DVR/HVR	8
EVR/HVR.....	9
PCI Card Configuration	10
x120 x60 PCI Configuration	10
x120R PCI Configuration	10
x240 8 and 16 Channel PCI Configuration.....	10
x240 32 Channel PCI Configuration	11
X480 16 Channel PCI Configuration.....	11
x480 32 Channel PCI Configuration	11
GETTING STARTED	13
IDENTIFYING INCLUDED COMPONENTS.....	14
OPTIONAL COMPONENTS	15
KEYBOARD SETUP	16
MOUSE SETUP	16
MONITOR SETUP	17
POWER SETUP.....	17
CONNECTING A VIDEO SOURCE TO THE DVR.....	18
CONNECTING SENSORS TO THE DVR	19
CONNECTING CONTROL OUTPUTS TO THE DVR	19
LOOPING OUTPUTS.....	20
LOOPING OUTPUT TERMINATION.....	20
CONNECTING A 16 CHANNEL AUDIO INPUT CABLE	20
CONNECTING A PTZ CAMERA.....	21
Attaching the RS-422 Adapter (x120 and x60 models).....	21
Attaching the RS-485 Adapter (x120R, x240 and x480 models)	21
HARD DRIVE ARRAY.....	22
Swapping a Hard Drive.....	22
DVR BASICS	23
TURNING ON THE DVR.....	24
TURNING OFF THE DVR	24
USING THE DVR UTILITY	25
Exporting DVR Settings.....	25

Importing DVR Settings	25
Changing Video Format.....	26
DISPLAY SCREEN	26
Live Camera Options	26
CAMERA VIEW.....	27
Recording Status Indicator	27
Special Recording	27
SCREEN DIVISION BUTTONS	28
TV OUT CONTROLS	28
SETUP OPTIONS	29
SETUP OVERVIEW	30
CAMERA SETUP.....	31
Setup a New Camera	31
HVR Registration (DVR/EVR Upgrade Option)	32
Obtaining the Unlock Code	32
Unlocking a New Network Camera.....	34
Connecting a Network Camera.....	34
MOTION SETUP	35
Creating a Motion Area.....	35
Removing a Motion Area	36
Activating an Alarm on a Motion Event.....	36
Regular Interval Recording.....	36
FRAME SETUP OVERVIEW	37
Frame Setup (4 CH x120 model).....	37
Frame Setup (x120R, x240, x480 models)	38
Frame Setup (x60, x120 models)	39
Enable Video Out to Spot Monitor	39
Maximum PPS Table	40
SCHEDULE SETUP.....	41
Recording Schedule	41
Sensor Schedule	42
Create a Recording Schedule.....	43
Create a Sensor Schedule.....	43
Scheduling Alarm Events.....	43
Emergency Agent Schedule	43
Special Day Schedule	44
Creating/Editing a 'Special Day' Schedule.....	44
Deleting a 'Special Day' Schedule	44
System Restart Setup.....	45
Create System Restart Schedule.....	45
ALARM SETUP.....	46
Configure Sensor Response.....	46
Activate PTZ Preset on Sensor	47
GENERAL SETUP	48
Voice Warning	48
Intensive Recording Overview	49
How to Use Intensive Recording.....	49
Audio	50

Enabling Audio Recording	50
Enabling Live Audio	50
TV-Out Setup (Analog)	51
Volume	51
Auto Sequencing Setting	52
Create Custom Auto Sequence	52
NETWORK SETUP	53
PTZ SETUP	54
INFORMATION	54
ADMINISTRATIVE SETUP	55
Disk Management.....	55
User Management	56
Add a New User.....	56
User Rank.....	57
Changing the Administrator Password	57
Default Administrator Password.....	57
Log Management.....	57
Setup Log Management Options	57
Status Check / Email	58
General.....	58
Users	58
Storage Check	59
Recording Data Check.....	59
SMART Information	60
SMART Alert.....	60
Alarm Event	60
INSTANT RECORDING	61
Activate Instant Recording.....	61
Searching 'Instant Recorded' Video	61
SEARCH	63
SEARCH OVERVIEW	64
Play Controls	64
Adjust the Brightness of an Image.....	65
Zooming In on an Image.....	65
Zooming In on a Portion of an Image	65
Open Video from Saved Location.....	65
Time Sync.....	65
Clean Image	65
DAYLIGHT SAVING TIME	66
SAVE TO JPG OR AVI.....	66
SINGLE CLIP BACKUP	67
PRINTING AN IMAGE.....	67
PERFORMING A BASIC SEARCH	68
INDEX SEARCH	68
Performing an Index Search	68
Index Search Results Display.....	68
PREVIEW SEARCH.....	69
Performing a Preview Search	70

GRAPHIC SEARCH	70
Performing a Graphic Search	70
OBJECT SEARCH	71
Performing an Object Search	71
SEARCH IN LIVE	72
AUDIO PLAYBACK	72
PAN / TILT / ZOOM	73
PAN / TILT / ZOOM OVERVIEW	74
SETTING UP A PTZ CAMERA	74
Attaching the PTZ Adapter	74
Enable the PTZ Settings	74
ADVANCED PTZ SETUP	75
Creating and Viewing Preset Positions	75
Creating a Preset	75
Viewing a Preset	75
PTZ Address Settings	76
ACCESSING PTZ MENUS	76
CONTROLLING A PTZ CAMERA	77
Using the Graphical PTZ Controller	77
Using the On-Screen Compass	77
UNDERSTANDING TOURS	78
PTZ Tour Schedule	79
Create PTZ Tour Schedule	79
Supported Protocols	80
BACKING UP VIDEO DATA	81
BACKUP OVERVIEW	82
NERO® EXPRESS	82
BACKUP CENTER OVERVIEW	82
General Backup Screen	83
Performing a General Backup	83
Clip Backup Screen	84
Performing a Clip Backup	84
Scheduled Backup Screen	85
Performing a Scheduled Backup	85
Specifying Scheduled Backup Drives	85
LAN / ISDN / PSTN CONNECTIONS	87
LAN OVERVIEW	88
CONNECTING TO A LAN USING TCP/IP	88
Configuring TCP/IP Settings	88
EVENT SENTRY	89
OVERVIEW	90
SETUP EVENT SENTRY	90
Add Email Notification Filters	90
WEB VIEWER	93
WEB VIEWER OVERVIEW	94
Configuring the Server for Remote Connection	95
Connecting to a DVR Using Web Viewer	95
Closing the Web Viewer	95

INCLUDED SOFTWARE SETUP	97
EMERGENCY AGENT OVERVIEW.....	98
Configuring the DVR.....	98
Configuring the Client PC	98
Emergency Agent Window	99
Setup Window.....	99
Filter Event List.....	99
Add Items to Alarm Confirm List	100
Search Alarm Window	101
View Recorded Video	101
Export Video	101
REMOTE SOFTWARE OVERVIEW	102
Remote Client Minimum Requirements	103
Remote Client Recommended Requirements	103
Remote Software Setup.....	103
Installing Remote Software	103
Create a New Remote Connection	104
Configuring the DVR.....	105
Configuring the Server for Remote Connection	105
Access Remote Connection.....	105
DIGITAL VERIFIER OVERVIEW	106
Installing the Digital Verifier	106
Using the Digital Verifier	106
BACKUP VIEWER OVERVIEW	107
Installing Backup Viewer.....	107
Loading Video from DVD or Hard Drive.....	108
SCS OVERVIEW	109
Configuring the Server for Remote Connection	109
Connecting to an DVR.....	109
APPENDIX: SPECIFICATIONS.....	111
DVR SPECIFICATIONS.....	113
EVR SPECIFICATIONS	115
HVR SPECIFICATIONS.....	117

PREFACE

ABOUT THIS GUIDE

This manual is a setup and maintenance guide that can be used for reference when setting up the DVR unit and for troubleshooting when a problem occurs. Only authorized personnel should attempt to repair this unit.

Toshiba reserves the right to make changes to the DVR units represented by this manual without notice.

The following text and symbols mark special messages throughout this guide:

NOTE: Text set off in this manner indicates topics of interests that can help the user understand the product better.

TIP: Text set off in this manner indicates topics and points of interests that can be helpful when using or settings up the DVR unit.

TECHNICIAN NOTES



WARNING: Only authorized technicians trained by Toshiba should attempt to repair this DVR unit. All troubleshooting and repair procedures that may be shown are for reference and minor repair only. Because of the complexity of the individual components and subassemblies, no one should attempt to make repairs at the component level or to make modifications to any printed wiring board. Improper repairs can create a safety hazard. And any indications of component replacement or printed wiring board modifications may void any warranty



WARNING: To reduce the risk of electrical shock or damage to the equipment:

- Do not disable the power grounding plug. The grounding plug is an important safety feature.
- Plug the power cord into a grounded (earthed) electrical outlet that is easily accessible at all times.
- Disconnect the power from the computer by unplugging the power cord either from the electrical outlet or the computer.



CAUTION: To properly ventilate your system, you must provide at least 3 inches (7.6 cm) of clearance at the front and back of the DVR unit.

NOTES:

INTRODUCTION

PRODUCT DESCRIPTION

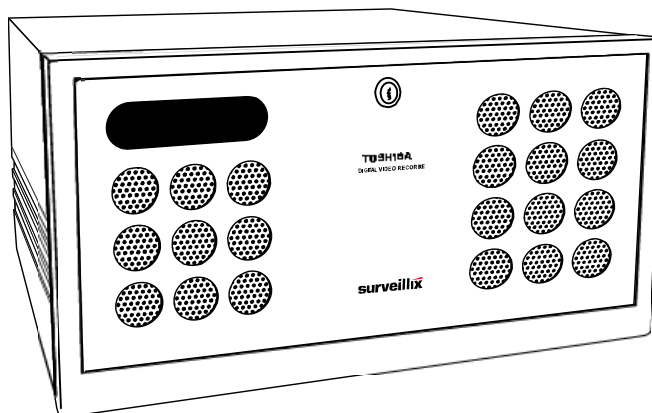

A Surveillix DVR is simply a server that performs as a High Definition Digital Recorder. By utilizing the many features of a computer, including processing power, storage capacity, graphics compression, and security features, the DVR unit is more powerful than the analog recorders of the past.

The Surveillix DVR server software comes pre-configured for fast and seamless integration within your existing IT infrastructure. Designed around Microsoft® Windows® XP, the server software offers unparalleled stability, security, and ease of use. Accordingly, your security investment has never been easier to maintain. Multiple users may simultaneously connect through any network connection for instantaneous live viewing, digital search, and off site video storage. Users can also connect remotely through DSL, Cable Modems, ISDN, or 56K dial-up. This powerful software enables users to establish recording schedules, create motion detection zones, use PTZ controls, and configure alarm inputs and outputs for each of the system's cameras. With the latest advancements in the DVR Server Software, searching and indexing your video archive has never been easier. Video can now be found, viewed, and exported in a number of file formats with just a few clicks.

The Surveillix DVR is a high performance security product ready to meet today's security demands.

FEATURES

Toshiba's Surveillix DVRs include the following new features:

Optimized and Designed for Microsoft® Windows XP Embedded®

Supports up to 16 Relay Outputs on Alarm Activation

Supports up to 16 Sensor Inputs for Alarm Control

Remote System Operation & Configuration

Supports Multiple Simultaneous Remote Connections

PAN / TILT / ZOOM Controls

Simultaneous Video Search, Playback and Backup

Video Indexes for Easy Searching

Multiple Levels of Security Access

Up to 32 Looping Outputs

1 Composite Output

S Video Output

Up to 32 Camera Inputs

Up to 16 Network Recording Channels (HVR standard, upgrade option for EVR or DVR)

Up to 8 Audio Inputs

High Performance, Durable, Rack mount Case

Output the Video to a NTSC/PAL Display

Virtually Unlimited Storage Potential

Digital Signature Support

Continuous, Motion Detection, Alarm, Pre-Alarm, and Scheduled Recording Modes

Hardware Watchdog

Recording Resolution (X60, X120) - 640x480 / 640x240 / 320x240 NTSC
640x576 / 640x288 / 320x288 PAL

Recording Resolution (X240, X480) - 720x480 / 720x240 / 360x240 NTSC
720x576 / 720x288 / 360x288 PAL

CONTROLS AND CONNECTIONS

This chapter includes the following information:

- Input / Output Connector Locations
- Front Panel Controls and LEDs
- Rear Panel Connectors

SYSTEM SPECIFICATIONS

Surveillix™ state-of-the-art High Definition Digital Recorders are housed in a high performance and versatile 4U or 5U rack-mount case allowing easy storage of multiple DVRs for enterprise applications. Every Surveillix DVR unit comes equipped with the latest technology:

EVR/DVR

Intel® Celeron D Processor
 10/100 Network Interface
 512 MB of System Memory
 128 MB VGA Card
 DVD±RW Recorder
 Full Duplex High-Fi Sound Functionality
 250 GB Video Storage Drive (minimum)

HVR

Intel® Dual Core 3.4Ghz CPU (HVR)
 10/100/1000 Gigabit Ethernet
 1GB of System Memory
 128 MB VGA Card
 DVD±RW Recorder
 Full Duplex High-Fi Sound Functionality
 250 GB Video Storage Drive (minimum)

FRONT PANEL CONTROLS AND LEDS

The front panel of the DVR unit contains the devices that will be commonly used for data removal, retrieval, and backup replacement. The most common components and buttons are shown below:

DVR/HVR

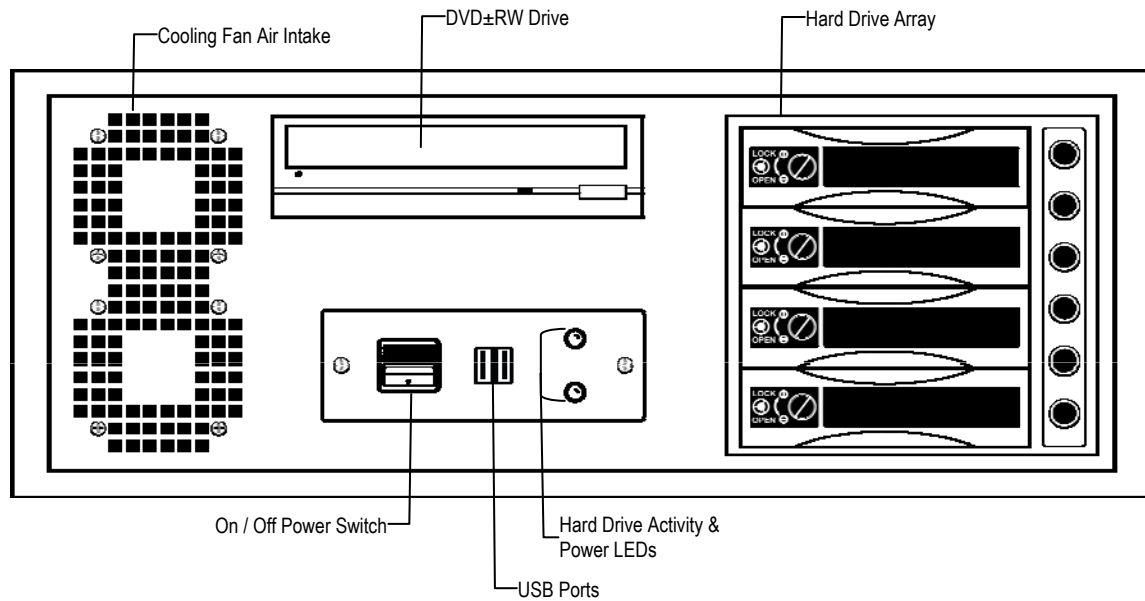

EVR/HVR

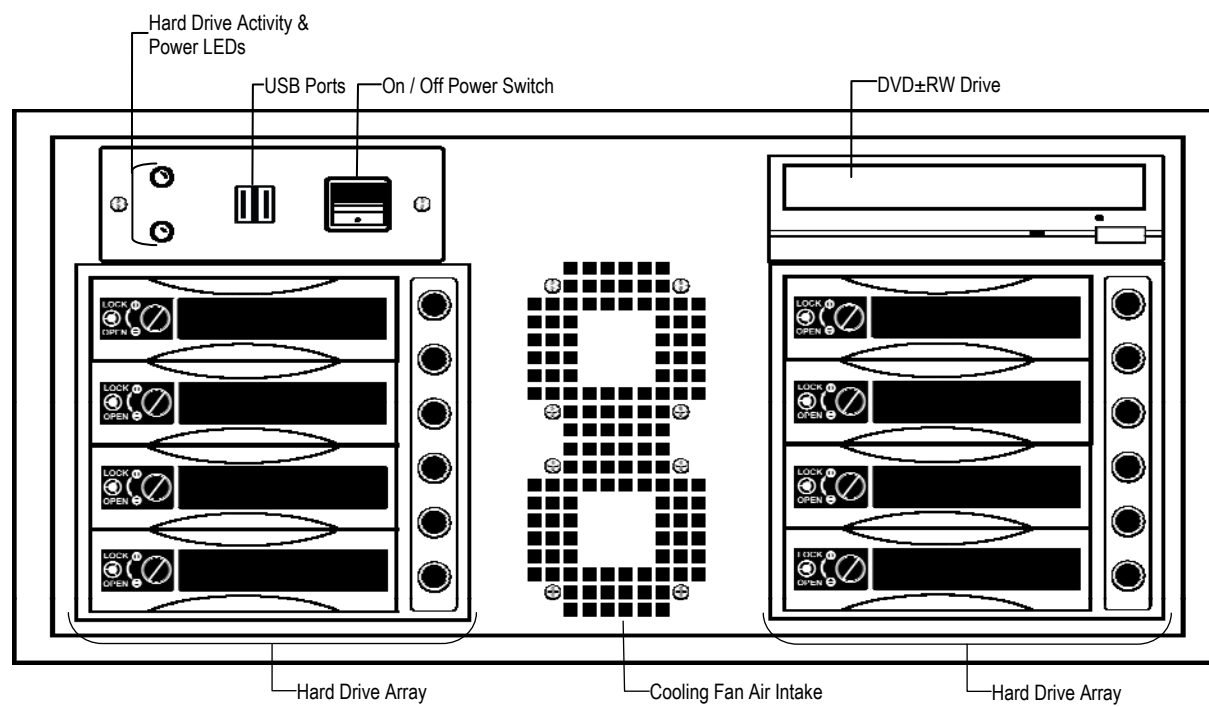

REAR PANEL CONNECTORS

The rear panel of the DVR unit contains the connectors used to attach cameras, sensors, and relays to the DVR. Below are diagrams that outline the location and description of each connector:

DVR/HVR

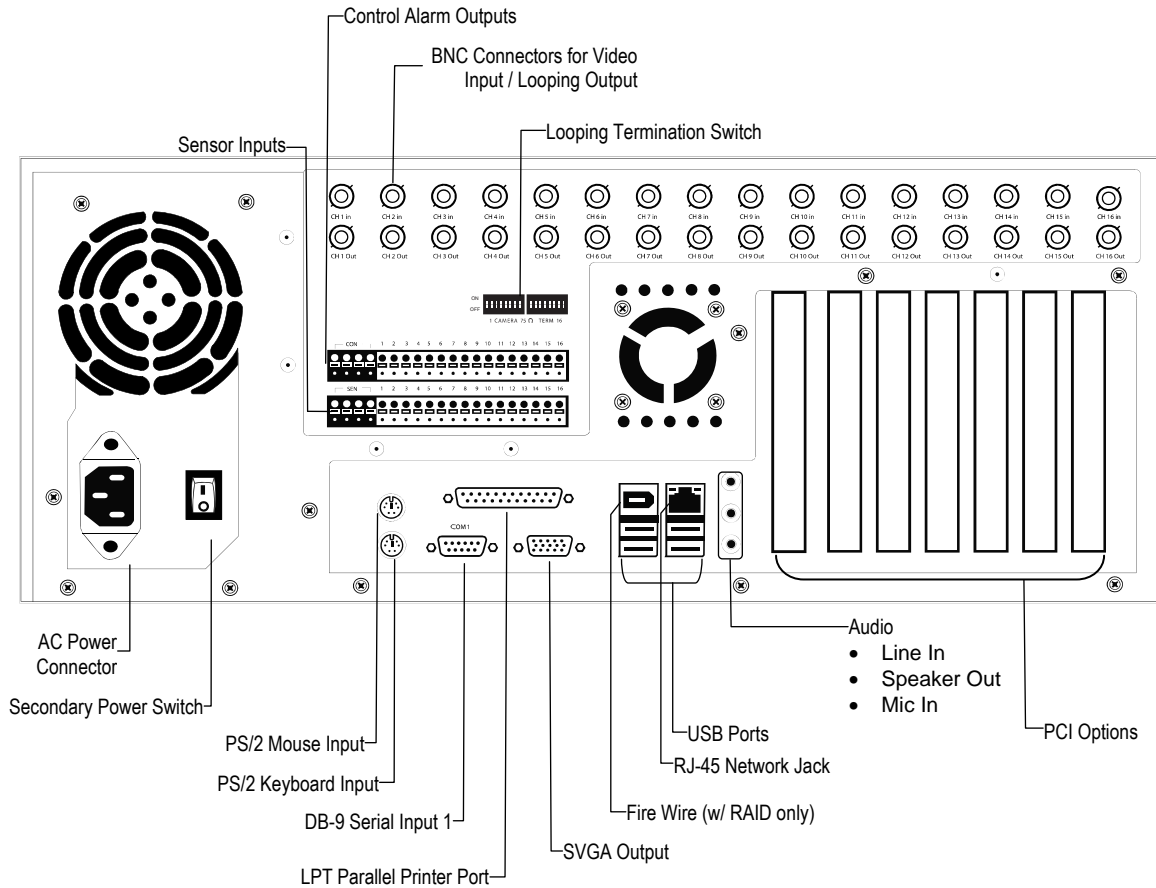

EVR/HVR

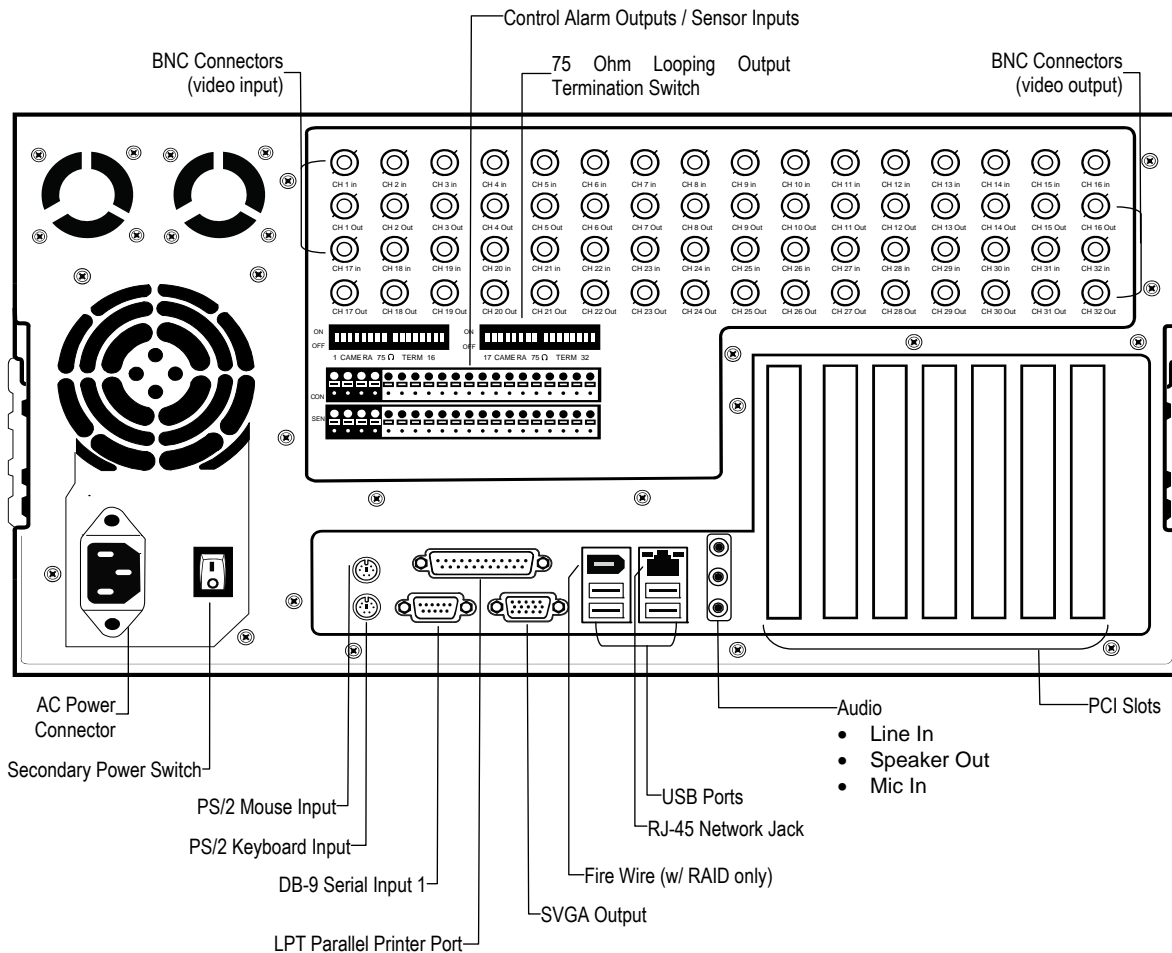

PCI Card Configuration

x120 x60 PCI Configuration

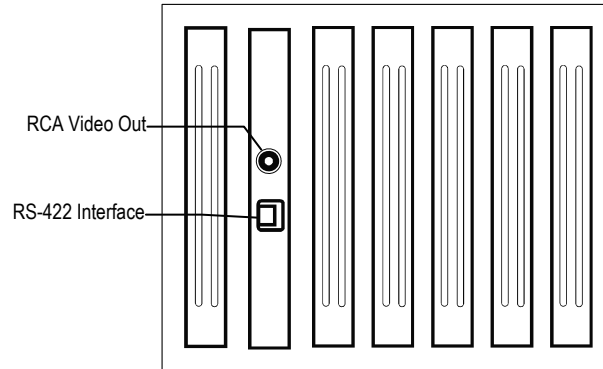

x120R PCI Configuration

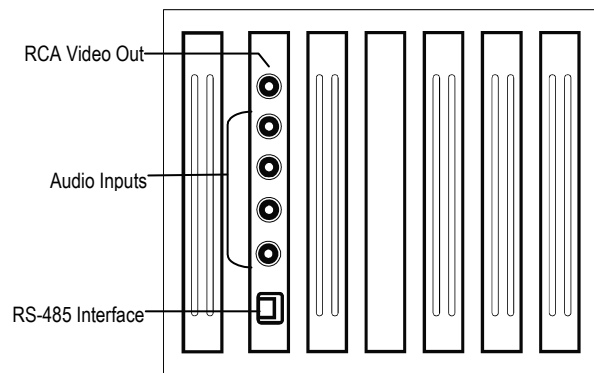

x240 8 and 16 Channel PCI Configuration

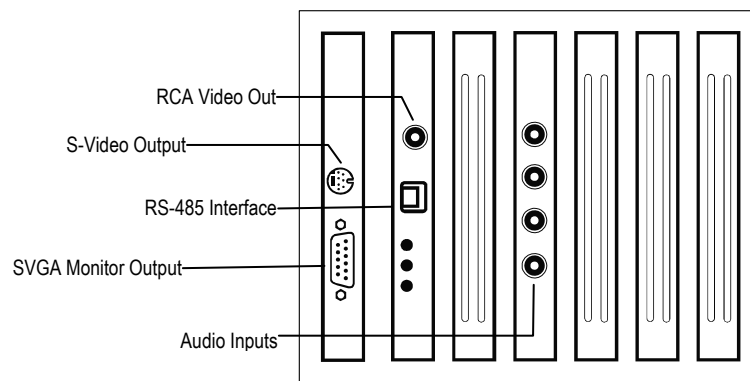

x240 32 Channel PCI Configuration

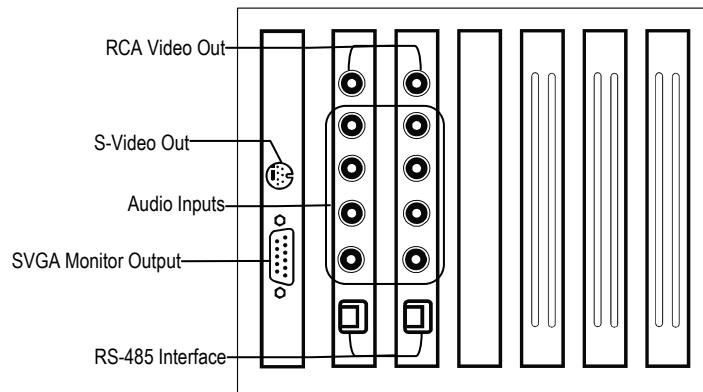

X480 16 Channel PCI Configuration

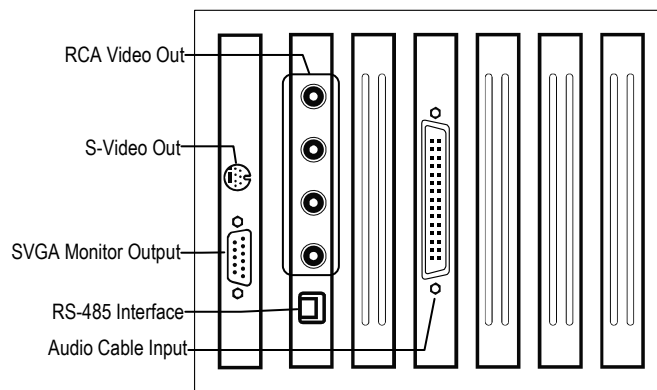

x480 32 Channel PCI Configuration

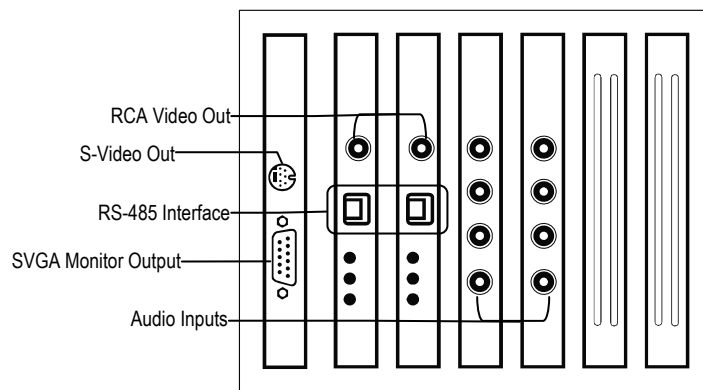

NOTES:







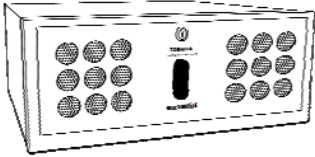

GETTING STARTED

This chapter includes the following information:

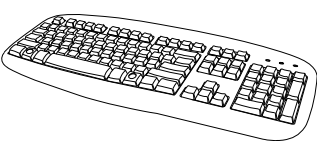
- Included Components
- Setting up the DVR Hardware
- Optional Components

IDENTIFYING INCLUDED COMPONENTS

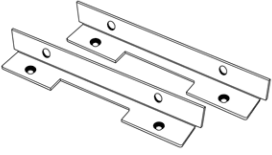
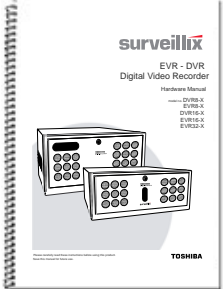
Surveillix™ DVRs come with a mouse, keyboard and selected software and cables. Identify the following components to make sure everything has been properly included with the new DVR unit. If any of the following items are missing, contact the dealer to arrange a replacement.

 <p>DVR Unit</p>	 <p>Mouse</p>	 <p>Keyboard</p>
 <p>Repair Disc/ Software Disc</p>	 <p>Power Adapter</p>	 <p>PTZ Adapter</p>
 <p>DVR Key</p>	 <p>Rack Mount Attachments with Screws</p>	 <p>DVR Manual</p>
 <p>RCA to BNC Adapter</p>	 <p>16 Channel Audio Input Cable*</p>	

* 16 Channel Audio Input cable included standard with the 16Ch. 480 PPS models (optional with 16ch audio card upgrade).

OPTIONAL COMPONENTS

To fully utilize the DVR unit's potential; several optional Surveillix components are listed below. Contact the dealer for more information.

1 Extra Video Storage Hard Drive

Each DVR unit has a virtually unlimited storage potential. Add additional Video Data Hard Drives to extend the amount of Video Data the DVR system can store before overwriting older data.

2 NP-FM56USB 56K External Modem

This 56K modem allows the user to connect the DVR to a standard phone line. Using this modem, either connect the unit to the Internet or allow a direct DVR to computer connection.

3 UPS UPS Power Backup

UPS Power Backups allow your DVR unit to remain fully functional even in the event of a power failure. UPS Power Backups also even the fluctuating power current out to provide a consistent, reliable power flow. This creates a stable environment for the DVR unit and reduces failure.

4 NP-4PKVM 4 Channel KVM Switch

The 4 Channel KVM switch allows you to have multiple boxes (up to 4) using only one keyboard, mouse and monitor. You can simply switch between the DVR units using the keyboard.

5 Hot Swappable Redundant Power Supplies

Every DVR and EVR has the option of a dual redundant hot swappable power supply. In the event of a component failure the inoperable power supply may be removed leaving the DVR running so no break in recording occurs. Simply replace the power supply with a new one and you are finished.

6 Raid Controller

A raid controller is available for increased performance or data reliability.

KEYBOARD SETUP

To attach the keyboard to the DVR unit, plug the end of the Keyboard into the keyboard PS/2 Port located on the back of the machine. The keyboard PS/2 Port can be identified by the purple color. Refer to the Rear Panel Connectors diagram for more information.

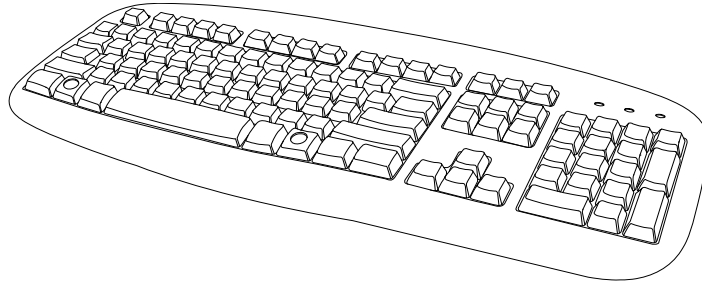

MOUSE SETUP

To attach the mouse to the DVR unit, plug the end of the mouse into the mouse PS/2 Port located on the back of the machine. The mouse PS/2 Port can be identified by the green color.

The mouse uses a cursor called a pointer. Pointers come in many different shapes but are most commonly shaped like an arrow.

The mouse has two buttons: a left button and a right button. Quickly pressing and releasing one of these buttons is called clicking. Sometimes you will need to double-click – or click the same button twice quickly.

In this manual:

Click means to position the mouse cursor over an item and to single click the left button.

Right click means to position the mouse cursor over an item and to single click the right button.

Double-click means to position the mouse cursor over an item and to click the left button twice.

Select means to position the mouse cursor over a radio button, checkbox, or list item and click on it.

The scroll wheel in between the two buttons is used for added navigation functionality. By moving the wheel with index finger (scrolling), quickly move through multiple pages, lines, or windows. The wheel may also function as a third button allowing the user to quickly click or double-click an icon or a selected item

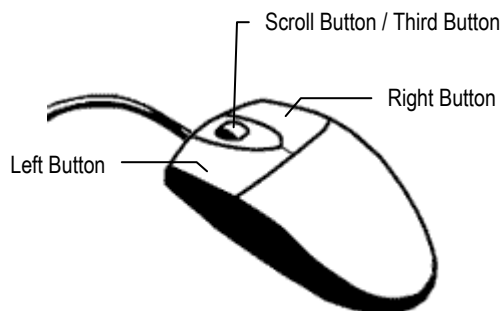

MONITOR SETUP

The DVR may have one or both of the following connections available for monitors which can be used individually or in tandem.

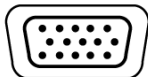

SVGA Output

To VGA Monitor.



S-Video Output

To TV/VCR.

Attach the monitor or monitors to the rear of the DVR unit using the cable supplied by the monitor manufacturer. Refer to the monitor manual for detailed information on how to setup and use it.

NOTE: The monitor must be capable of having a screen resolution of 1024 x 768 and display colors of at least 32 Bit

POWER SETUP



WARNING:

To reduce the risk of electrical shock or damage to the equipment:

Do not disable the power grounding plug.
The grounding plug is an important safety feature.

If the electrical plug you are using does not have a ground plug receptacle contact a licensed electrician to have it replaced with a grounded electrical outlet.

Plug the power cord into a grounded (earthed) electrical outlet that is easily accessible at all times.

Disconnect the power from the computer by unplugging the power cord either from the electrical outlet or the computer.

CONNECTING A VIDEO SOURCE TO THE DVR

There are different types of Video Sources that can be plugged into the DVR unit including DVD players, VHS players, and CCTV Cameras. The back of the DVR unit contains up to 16 video inputs depending on the DVR model. The connectors use the BNC standard. The inputs are highlighted below.

8-Channel

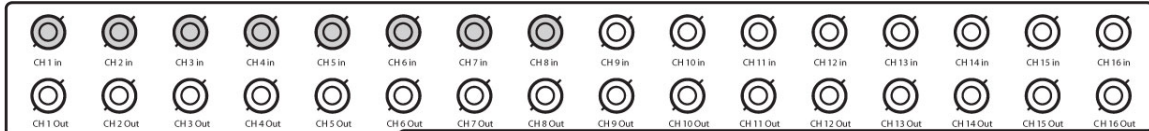

16 Channel

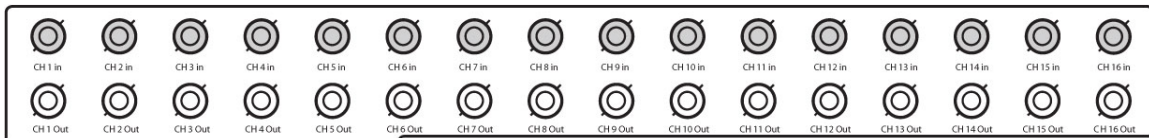

32 Channel

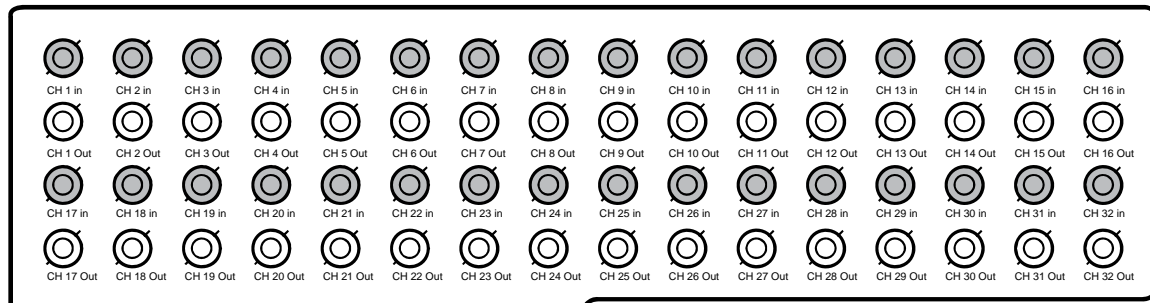

The video inputs are RG-59 BNC connectors. Plug one end into the video source (DVD, Camera, etc.) and plug the other end into the desired BNC input on the DVR unit.

CONNECTING SENSORS TO THE DVR

Each DVR unit may have up to 16 Sensor inputs. These inputs can be used with devices such as infrared devices, motion device, glass breakage alarms, door and window trips, and many more. The Sensors can be set to Normally Open or Normally Closed inside the software.

There are 4 Common Grounds (-) and 16 sensor inputs (+). There is no power supplied to the ports so an external power supply must be used if power is necessary.

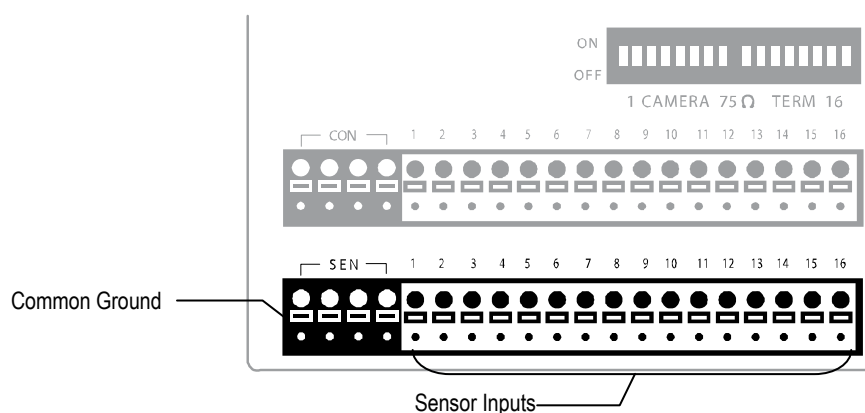

CONNECTING CONTROL OUTPUTS TO THE DVR

Each DVR unit may have up to 16 Control Outputs. These outputs can be used to trigger devices such as Sirens, Phone Dialers, Lights, and any other relay activated device. There is no power supplied to the ports. Use an external power supply if necessary.

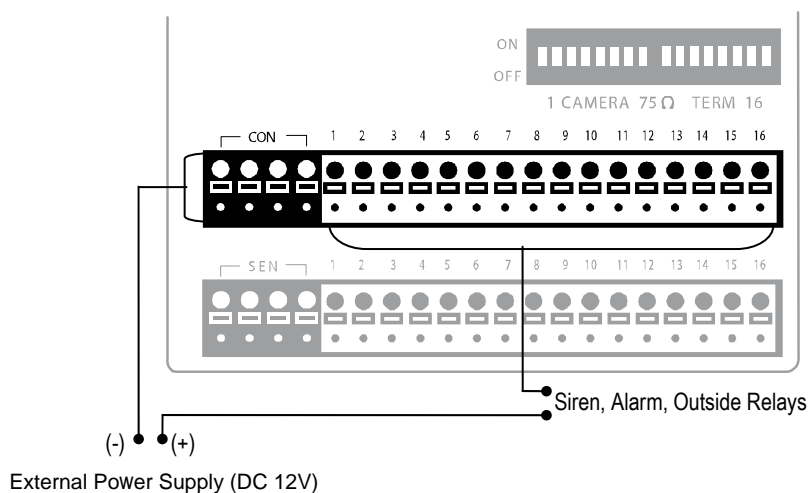

Use 12V, below 300mA. For controlling lights or other devices, use another external relay.

Maximum voltage is 24V AC @ 1 amp

Output uses a Form C Relay

LOOPING OUTPUTS

The 8 and 16 Channel DVR units may have up to 16 Looping outputs. Depending on the destination of the outputs, each output may have to be terminated. Looping outputs for a 16 Channel DVR looping are highlighted below.

32 Channel EVR units may have up to 32 looping outputs.

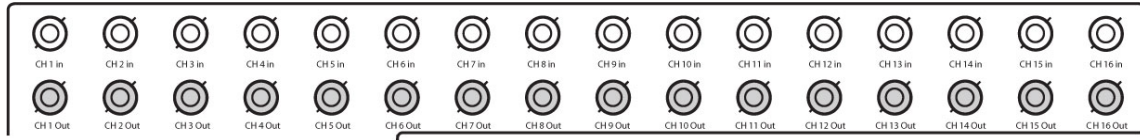

The Video inputs are RJ-59 BNC connectors. Make sure there is a video source connected to the input and then connect a cable to the Channel Out. The looping outs can be connected to video monitors or combined with adapters to connect to VCR's.

LOOPING OUTPUT TERMINATION

When terminating the outputs becomes necessary, the DVR unit has built in termination that allows you to select individual outputs to terminate individually. It is not always necessary to terminate the output when using it. It is dependent on the device with which you are connecting it to. As a rule, if the image appears distorted or virtually unviewable, it most likely needs to be terminated.

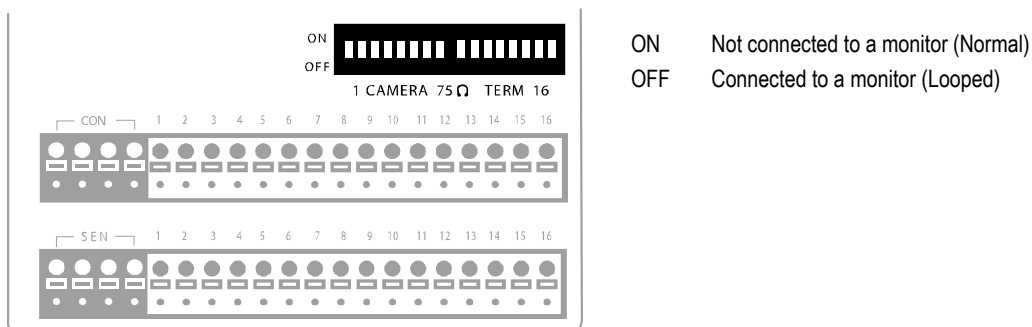

Always leave the dipswitch set to the ON position when the Looping Outputs are not used.

CONNECTING A 16 CHANNEL AUDIO INPUT CABLE

The 16 channel audio input cable (standard with the 16Ch 480 PPS Surveillix DVR) connects to a single serial port in the back of the unit.

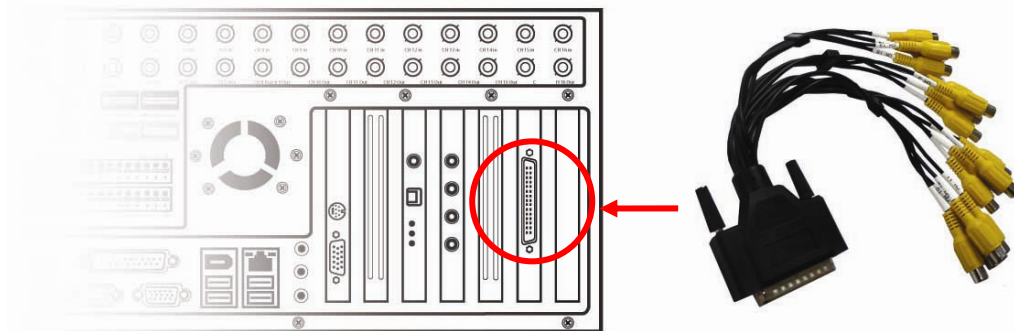

When connecting the 16 Channel Audio Input Cable, make sure to properly secure the cable to insure there is no loss of audio quality.

CONNECTING A PTZ CAMERA

Setting up a PTZ Camera is simple. The DVR unit comes preassembled with an internal PTZ adapter. The cabling may be run up to 4,000 ft using 22 Gauge Twisted Pair.

It is important to understand how the PTZ connects to the DVR. The DVR outputs an RS-232 signal and converts it to an RS-422/485 signal which is then sent to the PTZ camera.

Attaching the RS-422 Adapter (x120 and x60 models)

1. Locate the PTZ adapter cable
2. Connect the wires of the PTZ adapter to the PTZ camera. The red wire should connect to the RX+ on the camera and the brown wire should connect to the RX-.

NOTE: The PTZ adapter has four wires but only two are necessary for this application; the yellow and orange wires are not used currently.

3. Connect the other end of the adapter to the XVR unit as shown.
4. Assign the PTZ camera an ID number that coincides with the number assigned to it by the XVR unit

Example: If the camera is plugged into input number 5, set the PTZ unit to ID number 5.

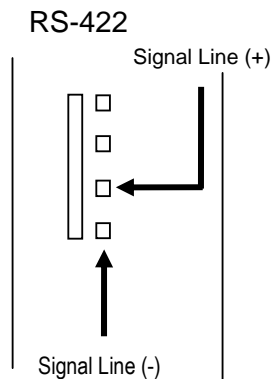

Attaching the RS-485 Adapter (x120R, x240 and x480 models)

1. Locate the PTZ adapter cable.
2. Connect the two wires of the PTZ adapter to the PTZ camera. The red wire on the adapter should connect to the RX+ on the PTZ and the brown wire should connect to the RX-.
3. Connect the other end of the adapter to the DVR unit as shown
4. Assign the PTZ camera an ID number that coincides with the number assigned to it by the DVR unit.

Example: If the camera is plugged into input number 5, set the PTZ unit to ID number 5.

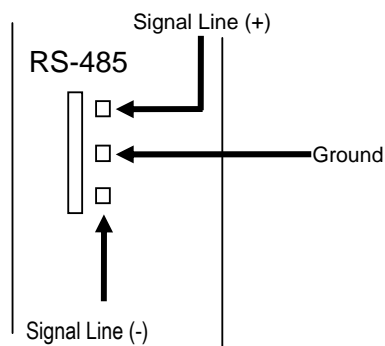

HARD DRIVE ARRAY

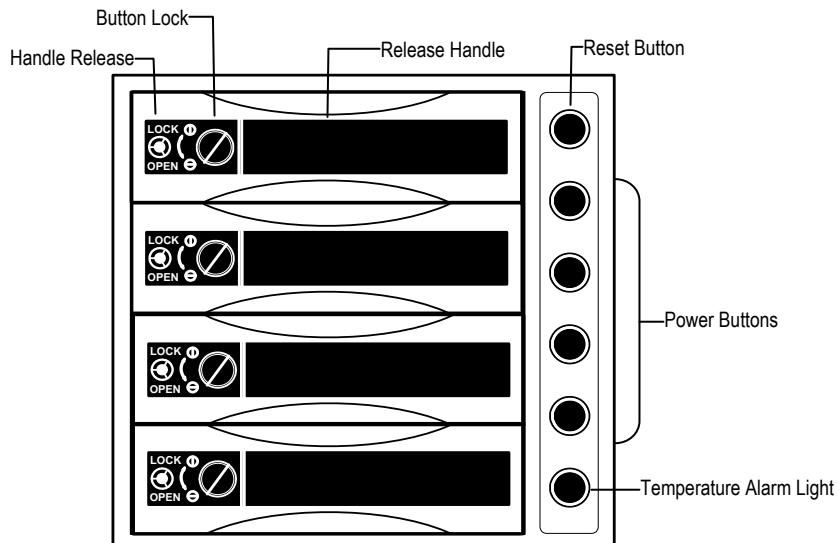

Swapping a Hard Drive

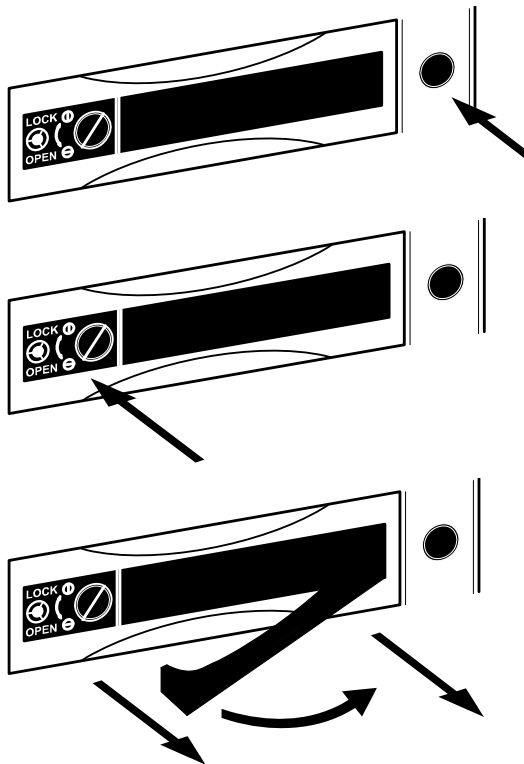

1. Press the Hard Drive Power Button to turn off power to the hard drive being removed.
2. Turn the Button Lock to the open position and push the Handle Release Button
3. Pull the Release Handle outward while removing the hard drive. Reverse steps to install.

DVR BASICS

This chapter includes the following information:

- Turning the DVR on and off
- Becoming familiar with the Display screen
- Defining Screen Divisions

TURNING ON THE DVR

Once the cables and adapters have been properly connected it is time to turn on the power. To turn on the power follow these steps:

4. Turn on the monitor and any external peripherals (ex. Printers, External Storage Devices, etc.) connected to the DVR.
5. Turn on the Secondary Power Switch located in the rear of the DVR.
6. Turn on the main power switch located on the front of the DVR.

The DVR will run a series of self-tests. After two or three minutes a series of messages may be displayed as the various hardware and software subsystems are activated. Under normal circumstances you should not be asked to respond to these messages. If you are asked to respond to the messages (adding a Printer, Monitor, etc for the first time) follow the instructions carefully.

After this finishes, the Surveillix DVR software should load automatically and bring you to the main screen.

TURNING OFF THE DVR

To turn off the DVR unit, select the Exit button on the main screen and select Power Off. The DVR will safely shutdown, it may take several minutes to shut down completely.



CAUTION: Always be sure to follow the proper procedures when turning off the power to the DVR. NEVER disconnect the power to the DVR while it is still running or in the process of shutting down. Doing so can cause data loss, file corruption, system instability and hardware failure

USING THE DVR UTILITY

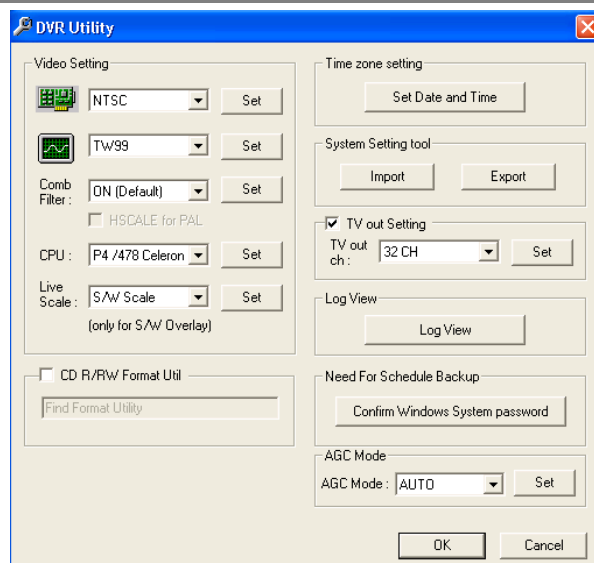

Exporting DVR Settings

Exporting DVR settings can help configure multiple DVRs quickly or reconfigure a DVR that has failed. Some things must be kept in mind when using this feature.

You cannot use this function on:

- DVRs that are different models.
 - When upgrading from certain software versions. You cannot use this feature when upgrading from v1.x to v2.x
1. Exit to Windows by clicking the Exit button on the Main Display Screen and selecting Restart in Windows Mode. (See the Display Screen section later in this chapter).
 2. Click Start > Programs > Surveillix > VFormat.
 3. Click the Export button in the System Settings tool section.
 4. Select a location to save the settings file and click Save. The DVR Utility will export the DVR settings and automatically close.
 5. Click the OK button to close the VFormat Utility.

Importing DVR Settings

1. Exit to Windows by clicking the Exit button on the Main Display Screen and selecting Restart in Windows Mode. (See the Display Screen section later in this chapter).
2. Click Start > Programs > Surveillix > VFormat.
3. Click the Import button in the System Settings Tool section.
4. Select the location of the settings file to import and click Open.
5. Click Yes to import the data file.
6. Click the OK button to close the VFormat Utility.

Changing Video Format

1. Exit to Windows by clicking the Exit button on the Main Display Screen and selecting Restart in Windows Mode. (See the Display Screen section later in this chapter).
2. Click Start > Programs > Surveillix > VFormat.
3. Select the appropriate video setting from the list in the Video Setting Section – NTSC or PAL.
4. Click Set.
5. Click the OK button to close the VFormat Utility.

DISPLAY SCREEN

Each time the DVR is started, the program defaults to the Display screen. The following diagram outlines the buttons and features used on the Display screen. You should become familiar with these options as this is the screen that will be displayed the majority of the time.

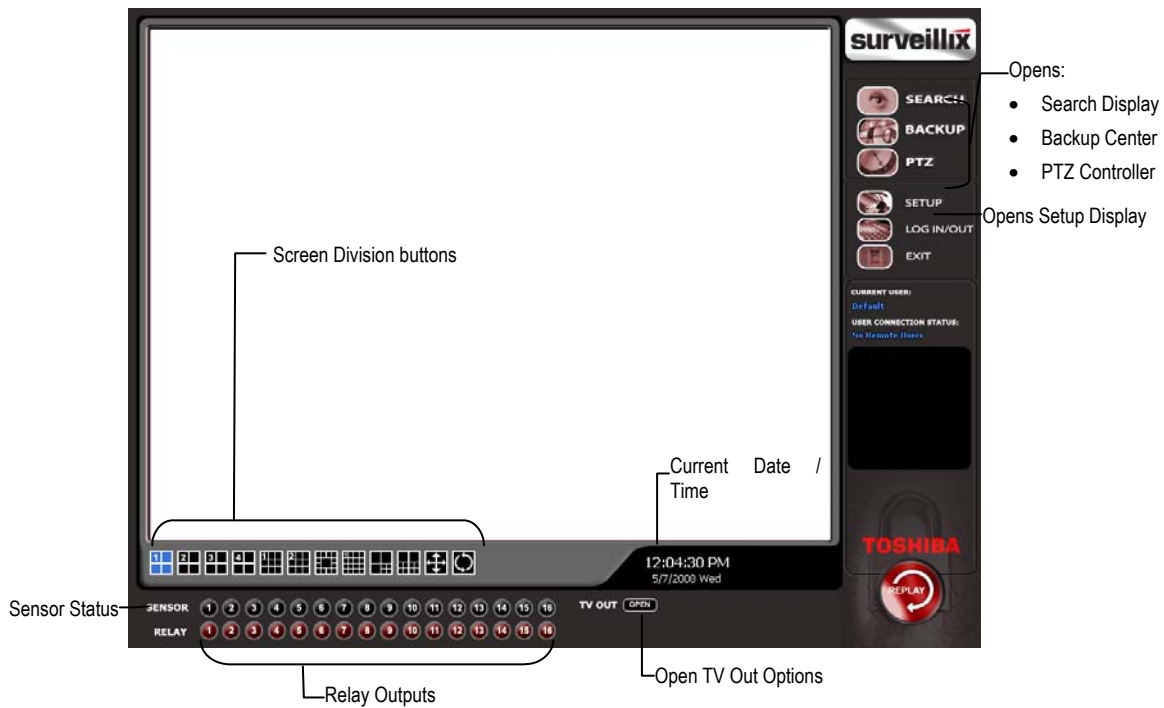

Live Camera Options

Right-click a live camera to display these options:

- Full Screen
- Instant Recording
- Search In Live





CAMERA VIEW



Recording Status Indicator

The camera status for each camera is displayed in the upper right corner on the Video Display Area. The following are the different states for each camera:

	Recording	Displayed when the camera is currently being recorded to the DVR.
	Motion Detection	Displayed when a camera (set up for motion detection) detects motion.
	Display	Displayed when the camera is currently not being recorded to the DVR.

Special Recording

There are two types of DVR Special Recording. Text is displayed on the camera indicating what type of Special Recording is activated.

SENSOR	Sensor is displayed when a sensor, associated with a given camera, is activated.
INSTANT	Instant Recording is a manual activation of the recording for the selected camera. Regardless of the recording method, Instant Recording will start the camera recording and also flag the video for future searches using the Index Search feature. INSTANT is displayed when a user activates the instant recording option. Double Right-Click the video display to activate and deactivate the Instant Recording option.

SCREEN DIVISION BUTTONS

The Screen Division buttons allow you to view cameras in groups such as two by two, three by three and four by four. The button options are shown below.



1st Four Cameras View – Displays cameras 1-4 in the Video Display Area. To return to a different Multi-Camera View, select a different Screen Division option from the Screen Division Menu.



2nd Four Cameras View – Displays cameras 5-8 in the Video Display Area. To return to a different Multi-Camera View, select a different Screen Division option from the Screen Division Menu.



3rd Four Cameras View – Displays cameras 9-12 in the Video Display Area. To return to a different Multi-Camera View, select a different Screen Division option from the Screen Division Menu.



4th Four Cameras View – Displays cameras 13-16 in the Video Display Area. To return to a different Multi-Camera View, select a different Screen Division option from the Screen Division Menu.



1st Nine Cameras View – Displays cameras 1-9 in the Video Display Area. To return to a different Multi-Camera View, select a different Screen Division option from the Screen Division Menu.



2nd Nine Camera View – Displays cameras 8-16 in the Video Display Area. To return to a different Multi-Camera View, select a different Screen Division option from the Screen Division Menu.



Multi-Camera View – Displays a group of cameras within the Video Display Area.



All Camera View – Displays all 16 cameras within the Video Display Area.



Multi-Camera View – Displays a group of cameras within the Video Display Area.



Multi-Camera View – Displays a group of cameras within the Video Display Area.



Full Screen – The Full Screen Option allows you to view the Video Display Area using the entire viewable area on the monitor. When this is selected, no menu options are visible. You can activate the Full Screen Option by clicking on the Full Screen button within the Screen Division Menu. You can deactivate Full Screen mode by right-clicking on the screen.



Auto Sequence – Sequences through the Screen Divisions sets. For example, selecting the 1A and then the Loop button will sequence through 1A, 2A, 3A, 4A and then repeat. This option is not available for the 7, 10 and 13 screen divisions.

TV OUT CONTROLS

The DVR features an optional TV-Out functionality which allows users to output video from any number of cameras, in sequence, to a television or monitor display.



SETUP OPTIONS

This chapter includes the following information:

- Setup Overview
- Camera Setup
- Motion
- Frame Setup
- Schedule
- Sensor
- Network
- Information
- Administrative

SETUP OVERVIEW

The Setup options allow you to optimize your DVR by adjusting things like camera names, reboot schedules, recording schedules and more. It is extremely important that you setup your DVR correctly for several reasons.

- **Recording Schedules** – By optimizing the recording schedule you can increase the amount of pertinent recorded video that is saved on the DVR and keep it longer. You can optimize the type of recording done by adding motion detection to this as well, again increasing the amount of useful video.
- **DVR Access** – By setting up the access passwords you can tightly control the types of access an individual may have. This ensures the security and integrity of the DVR.
- **Camera Naming** – By naming each camera you can easily identify the location and any other pertinent information that may be helpful simply by viewing it on the Video Display Area.
- **Adjusting Camera Color** – By adjusting each camera's color settings you can optimize the clarity and detail that is recorded.



CAMERA SETUP

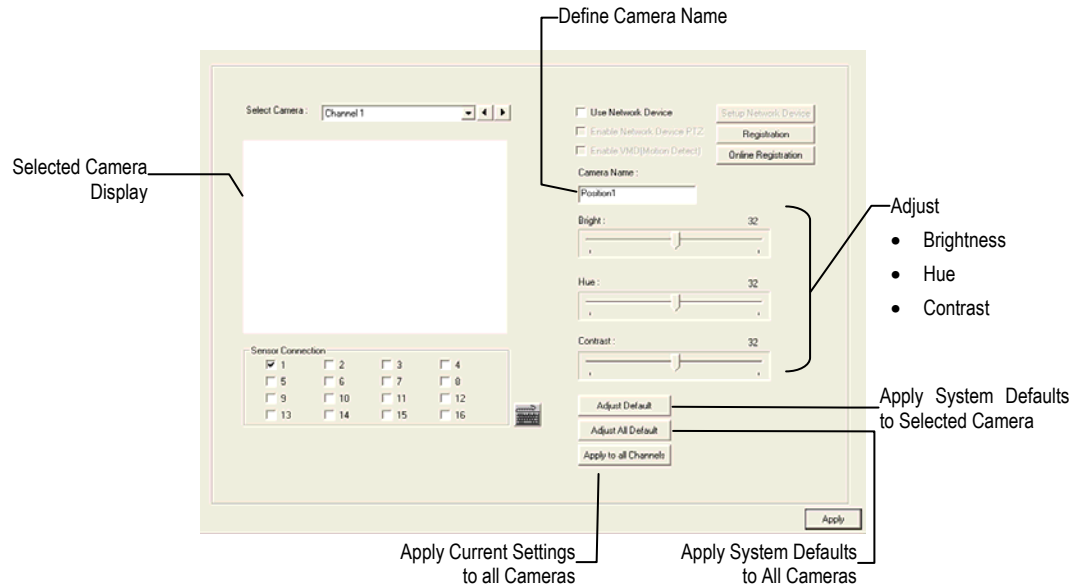

Enable VMD (Motion Based) Network camera motion detection. (Only available on select network video devices.)

Setup a New Camera

1. Attach camera to the rear of the DVR chassis.
2. Click the Setup button on the Main Display Screen.
3. Click the Camera Setup button to open the Camera Setup Display.
4. Select the channel that corresponds with the new camera from the Select Camera List.
5. Enter a name for the camera in the Camera Name box.
6. Adjust the Brightness, Hue and Contrast if necessary.
7. Select the appropriate sensors to associate with the camera.
8. Click the Apply button when finished.

HVR Registration (DVR/EVR Upgrade Option)

Use the following instructions to register the network recording functionality of an HVR or upgraded DVR/EVR. Contact your sales representative to purchase the HVR upgrade for a DVR or EVR.

Have the following information available before registering the HVR upgrade.

HVR Software Serial Number: The product Serial Number is the unique number that Toshiba provided with the software purchase.

System ID: The System ID is a number generated by the Surveillix. This is a unique code generated using the MAC address of the computer running the software. The following steps illustrate how to locate the System ID.

1. Enter Setup.
2. Click Camera Setup.
3. Click the Registration button.
4. In the Network Device Authentication, the System ID can be located under the "Add a new Serial Key" section (shown below).

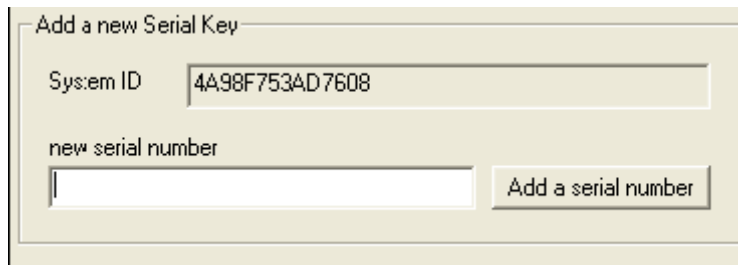

Add a new Serial Key

System ID 4A98F753AD7608

new serial number

Add a serial number

Obtaining the Unlock Code

1. Open an Internet browser and go to: <http://register.surveillixdvr.support.com>
2. Enter the Product Serial Number provided by Toshiba.
3. Enter the System ID generated by the DVR.
4. Click Submit.

Product Serial Number

System ID

Submit

5. Verify the information.
6. Click Next if the information provided is correct.

Software Registration

Product Name	01 Channel IP Camera Unlock
Product Serial Number	880000000000
System ID	4e0000000000
DVR Serial Number:	880000000000

Please verify the information and press NEXT to proceed.

7. Once validated, the browser displays the Unlock Code.
8. Print the page and save for later reference.

Software Registration

The following is your unlock code. Keep this number in a safe place as you will need it if you ever reinstall the software.

Unlock Code	00000000-11111111
Product	01 Channel IP Camera Unlock
Product SN	880000000000
DVR SN	880000000000

NOTE: This unlock code cannot be transferred to a different computer.

Unlocking a New Network Camera

1. Start the Surveillix DVR.
2. Enter Setup.
3. Enter Camera Setup.
4. Click the Registration button.
5. Enter the Unlock Code generated by the Toshiba Registration Site into the "new serial number" box.
6. Click Add a serial number.
7. Once the new serial number has been added to the list, click OK.

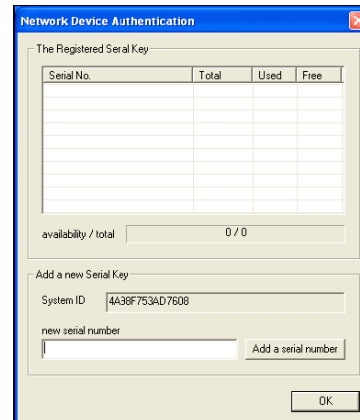

Connecting a Network Camera

1. Open Camera Setup. Setup > Camera Setup.
2. Select the camera channel to add a Network Device to.
3. Check the Use Network Device Box.
4. If the Network Device supports PTZ check the Enable Network Device PTZ Box.
5. Click Setup Network Device and the Network Device Properties window will appear.
6. Click Setup to add a Network Device.
7. Select the Manufacturer (Class) and Model of camera being added then click Next.
8. Enter the IP Address, Port, ID, and Password of the Network Device and click Finish.
9. Click OK when returned to the main Network Device Properties window.
10. Click Apply and then click OK to exit the main setup window.
11. The Network Device has been added.

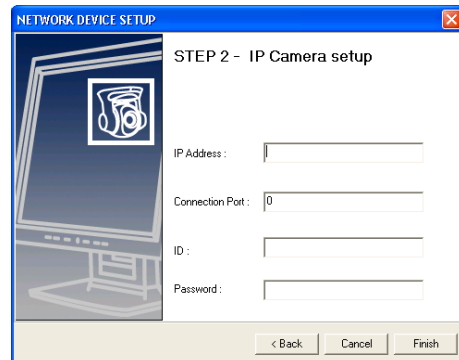
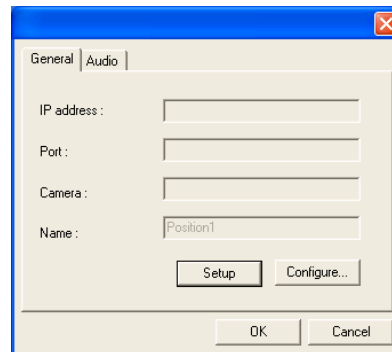

MOTION SETUP

The DVR allows the user to adjust several different Motion Settings and create motion detection regions.

NOTE: Motion grids configured using the SCS software will be advanced motion grids.

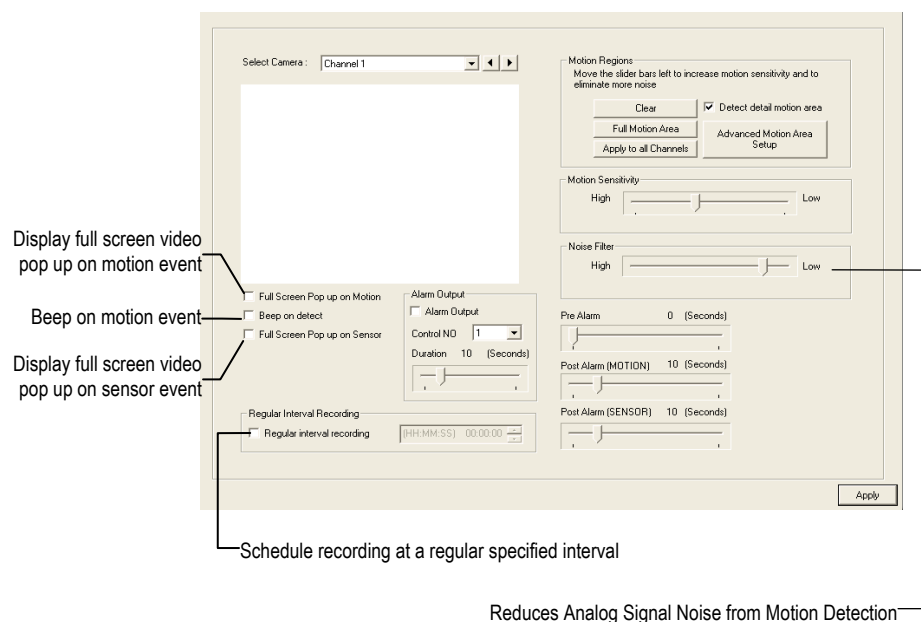

Creating a Motion Area

1. Click the Motion button in Setup.
 2. Select a camera from the Select Camera list.
 3. Select the Detect Detail Motion Area check box.
 4. Click Clear.
 5. Click Advanced Motion Area Setup.
 6. Click a Motion Detection Area shape button.
 7. Drag the mouse over the camera image.
- TIP:** To create a polygon shape, click the mouse at each point and double-click to close the shape.
8. Click OK.
 9. Move the sliders to adjust motion sensitivity and the noise filter.
 10. Define the pre-alarm and post-alarm recording time for a motion event.

Pre Alarm – 0 > 50 Seconds [The number of seconds the DVR records before motion is detected]

Post Alarm (MOTION) – 0 > 50 Seconds [The number of seconds the DVR records after motion is detected]

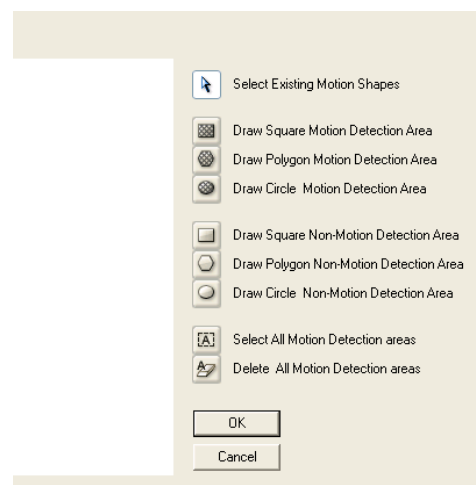

Removing a Motion Area

To remove the motion areas, in the Motion Regions area, click Clear.

Activating an Alarm on a Motion Event

1. In the Motion Setup window, select a camera to edit from the list.
2. Create a motion area.
3. Select the Alarm Output check box.
4. Select a Control Output to activate for the selected camera.
5. Select the duration to activate the Alarm when a motion event occurs.

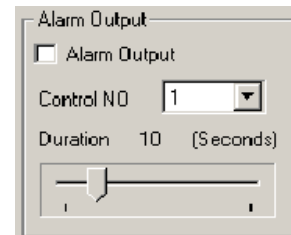

Regular Interval Recording

Regular Interval Recording allows users to record a single frame every few minutes or hours when there is no motion. This option is only available when Motion recording or Sensor recording is setup.

To enable Regular Interval Recording:

1. Select the Regular Interval Recording check box.
2. Specify how often to take an image when no motion is occurring. Users can go as little as one image per second.

FRAME SETUP OVERVIEW

The Frame Setup Menu allows configuration of the PPS, resolution, quality, and sensitivity of camera channels. When configuring the PPS sliders the BLUE slider represents the PPS the DVR will record during intensive recording and have available for transmitting to remotely connected systems. The RED slider represents the PPS that will be recorded by the DVR under normal recording conditions.

The total PPS of all blue sliders may not exceed the recording PPS of the DVR. The PPS of a red slider may not exceed that of the blue slider for the same channel. The dual sliders allow configuration of the DVR to record at a lower PPS while still being able to transmit at a higher PPS to remote connections.

Ex. If a camera channel is set to 25 PPS (blue) and 7 PPS (red), the DVR will record at 7 PPS and users viewing live video remotely can receive up to 25 PPS.

NOTE: The 4 Channel XVR only allows the user to select one frame rate for both recording and remote viewing.

Frame Setup (4 CH x120 model)

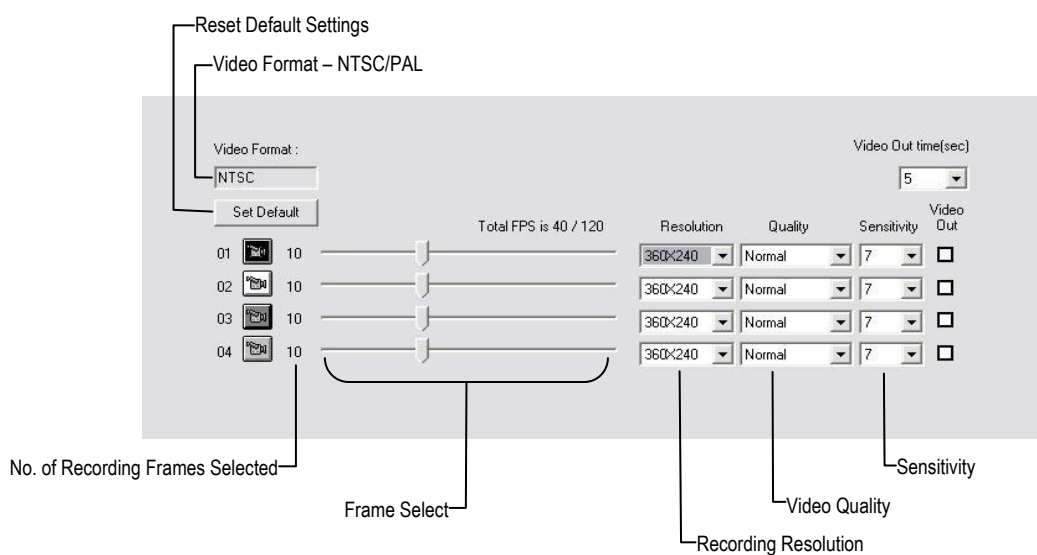

Frame Select	Sets the PPS recorded by the XVR and available for viewing on a remote client PC
Video Quality	Lower quality video has a smaller file size but appears more pixilated
Sensitivity	Sets the Key frame refresh rate. Adjusting this setting can have negative effects on video quality NOTE: Do not change from default setting unless instructed by a system administrator.

Frame Setup (x120R, x240, x480 models)

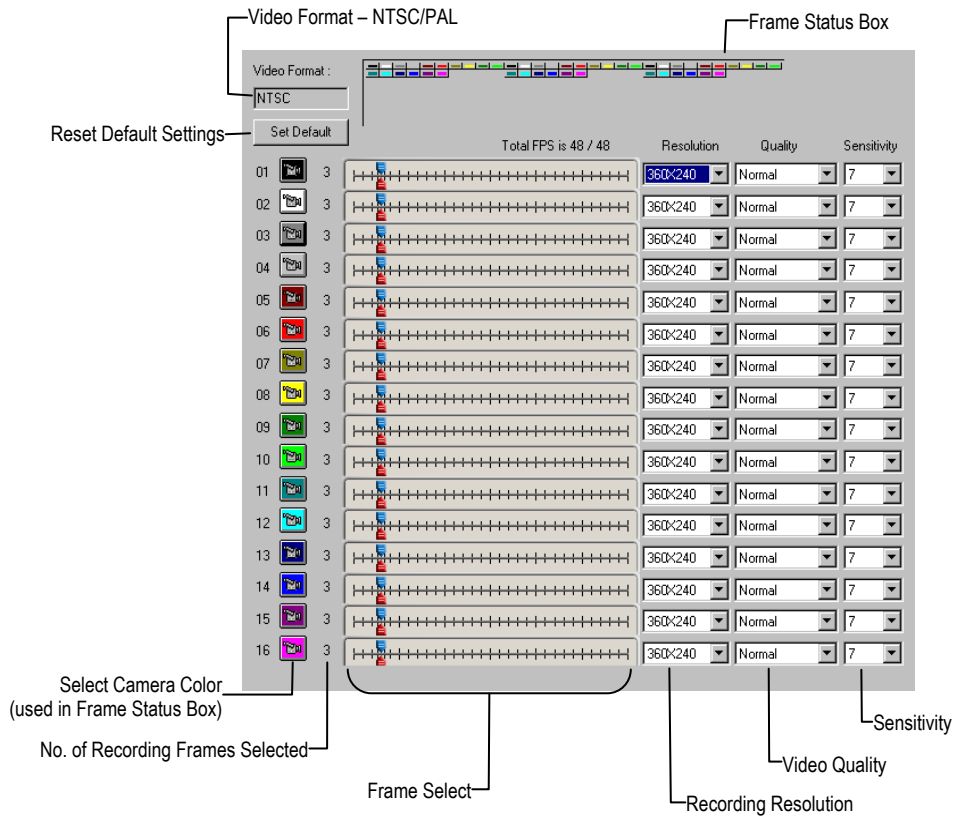

Frame Select	Blue Slider: Sets the PPS recorded during intensive recording and available for viewing on a remote client PC. Red Slider: Sets the PPS recorded by the DVR during normal recording.
Video Quality	Lower quality video has a smaller file size but appears more pixilated.
Sensitivity	Sets the Key frame refresh rate. Adjusting this setting can have negative effects on video quality. NOTE: Do not change from default setting unless instructed by a system administrator.

Frame Setup (x60, x120 models)

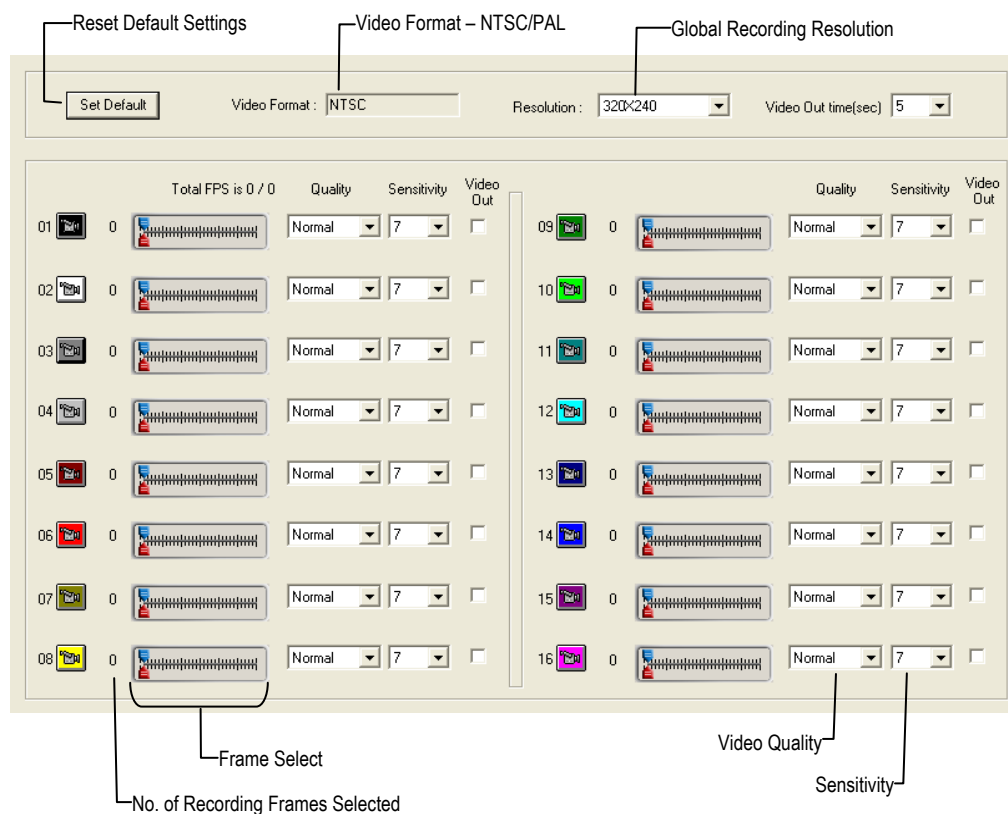

Frame Select	Blue Slider: Sets the PPS recorded during intensive recording and available for viewing on a remote client PC. Red Slider: Sets the PPS recorded by the DVR during normal recording.
Video Quality	Lower quality video has a smaller file size but appears more pixilated.
Sensitivity	Sets the Key frame refresh rate. Adjusting this setting can have negative effects on video quality. NOTE: Do not change from default setting unless instructed by a system administrator.

Enable Video Out to Spot Monitor

1. Click the Setup button on the Main Display.
2. Click the Frame Setup button.
3. Select the Video Out Box to enable the appropriate channels.
4. Define the Video Out Time (seconds to display each channel on spot monitor).
5. Click Apply.

Maximum PPS Table

PPS Breakdown for Each Resolution

Resolution	CCTV	x480 model	x240 model
360x240	1CIF	480 PPS	240 PPS
720x240 *	2CIF	240 PPS	120 PPS
720x480 **	4CIF	120 PPS	60 PPS

* Frames recorded in 720x240 are twice the size of the standard 360x240. When recording at 720x240, each frame assigned to the channel will use 2 of the total frames available.

** Frames recorded in 720x480 are four times the size of the standard 360x240. When recording at 720x480, each frame assigned to the channel will use 4 of the total frames available.

Resolution	CCTV	x120 model	x60 model
320x240	1CIF	120 PPS	60 PPS
640x240	2CIF	120 PPS	60 PPS
640x480	4CIF	60 PPS	30 PPS

32 Channel Frame Allocation

32 Channel models utilize two capture cards. When configuring cameras and allocating frames, the total frame rate for the DVR is split between each capture card. Please reference the chart below for available frames for each grouping of channels.

Resolution	Channels	x240 model	x480 model
360x240	1 to 16	120 frames	240 frames
	17 to 32	120 frames	240 frames
720x240	1 to 16	60 frames	120 frames
	17 to 32	60 frames	120 frames
720x480	1 to 16	30 frames	60 frames
	17 to 32	30 frames	60 frames

SCHEDULE SETUP

Recording Schedule

The Recording Schedule window allows the user to create different recording schedules based on the day, time, and type of recording desired. In addition, this window contains the System Restart options that allow the user to perform basic system maintenance by automatically scheduling the DVR to restart periodically.

The screenshot shows the Recording Schedule window with several callouts:

- Recording Schedule Window:** Points to the main interface area.
- Single Day Selection / Multi Day Selection:** Points to the 'Day of week' section with radio buttons for SUN, MON, TUE, WED, THU, FRI, SAT and a 'Single Day Selection' button.
- Open Restart Setup Window:** Points to the 'Restart setup' button.
- Create Special Day Recording Schedules:** Points to the 'Special day' section, including 'Normal Day Mode', a date dropdown (6/28/2005), and 'Save special day'/'Delete special day' buttons.
- Recording Mode Options:** Points to the 'No recording', 'Continuous', and 'Motion' buttons.
- Emergency IP Setup:** Points to the 'Emergency IP' section with fields for IP 1, IP 2, and 'Emergency Time (sec.): 5'.

Day of week: SUN, MON, TUE (checked), WED, THU, FRI, SAT

Recording schedule:

ALL	0	1	2	3	4	5	6	7	8	9	10	11	12
CAM01	Blue	Yellow	Yellow	Yellow	Yellow	Yellow	Yellow	Yellow	Yellow	Yellow	Yellow	Yellow	Yellow
CAM02	Yellow	Yellow	Yellow	Yellow	Yellow	Yellow	Yellow	Yellow	Yellow	Yellow	Yellow	Yellow	Yellow
CAM03	Yellow	Yellow	Yellow	Yellow	Yellow	Yellow	Yellow	Yellow	Yellow	Yellow	Yellow	Yellow	Yellow
CAM04	Yellow	Yellow	Yellow	Yellow	Yellow	Yellow	Yellow	Yellow	Yellow	Yellow	Yellow	Yellow	Yellow
CAM05	Yellow	Yellow	Yellow	Yellow	Yellow	Yellow	Yellow	Yellow	Yellow	Yellow	Yellow	Yellow	Yellow
CAM06	Yellow	Yellow	Yellow	Yellow	Yellow	Yellow	Yellow	Yellow	Yellow	Yellow	Yellow	Yellow	Yellow
CAM07	Yellow	Yellow	Yellow	Yellow	Yellow	Yellow	Yellow	Yellow	Yellow	Yellow	Yellow	Yellow	Yellow
CAM08	Yellow	Yellow	Yellow	Yellow	Yellow	Yellow	Yellow	Yellow	Yellow	Yellow	Yellow	Yellow	Yellow
CAM09	Yellow	Yellow	Yellow	Yellow	Yellow	Yellow	Yellow	Yellow	Yellow	Yellow	Yellow	Yellow	Yellow
CAM10	Yellow	Yellow	Yellow	Yellow	Yellow	Yellow	Yellow	Yellow	Yellow	Yellow	Yellow	Yellow	Yellow
CAM11	Yellow	Yellow	Yellow	Yellow	Yellow	Yellow	Yellow	Yellow	Yellow	Yellow	Yellow	Yellow	Yellow
CAM12	Yellow	Yellow	Yellow	Yellow	Yellow	Yellow	Yellow	Yellow	Yellow	Yellow	Yellow	Yellow	Yellow
CAM13	Yellow	Yellow	Yellow	Yellow	Yellow	Yellow	Yellow	Yellow	Yellow	Yellow	Yellow	Yellow	Yellow
CAM14	Yellow	Yellow	Yellow	Yellow	Yellow	Yellow	Yellow	Yellow	Yellow	Yellow	Yellow	Yellow	Yellow
CAM15	Yellow	Yellow	Yellow	Yellow	Yellow	Yellow	Yellow	Yellow	Yellow	Yellow	Yellow	Yellow	Yellow
CAM16	Yellow	Yellow	Yellow	Yellow	Yellow	Yellow	Yellow	Yellow	Yellow	Yellow	Yellow	Yellow	Yellow

Event: (A) Alarm Event, (R) Central Station, (E) Emergency Agent, Delete Alarm

Emergency IP:

IP	Use	IP
IP 1	<input type="checkbox"/>	0.0.0.0
IP 2	<input type="checkbox"/>	n.n.n.n

Emergency Time (sec.): 5

Create a Recording Schedule

1. Select a day to begin creating the schedule for -or- Select the Day Selection Mode button, enabling Multi Day Selection, to create the same schedule for multiple days.
2. Highlight the Time-Blocks within the Recording Schedule window for the camera(s) selected to schedule. Once the desired Time-Blocks are highlighted, click a Recording Mode button. The Time-Blocks should now appear Blue for Motion, Yellow for Continuous and White for No Recording

NOTE: Leave cameras recording with Sensor Detection set to No Recording for the specified time block(s).

Create a Sensor Schedule

1. Select the Schedule Menu option and select the Sensor Radio button. Select a single day or click the Day Selection Mode button to include multiple days in the schedule.
2. Highlight the Time-Blocks within the Recording Schedule window for the sensor(s) to enable and schedule. Once the time blocks are highlighted click the Enable button. The time block will now appear red.

Scheduling Alarm Events

There are three types of Alarm Events:

ALARM EVENT: This option logs the Alarm Events on the local server.

CENTRAL STATION: This option sends the Alarm Events to Central Station software.

EMERGENCY AGENT: This option sends the Alarm Event to the Emergency Agent software.

Motion can be designated as an Alarm event. Often motion does not need to be treated as an Alarm event. Ex: During work hours motion that occurs is expected and should not be treated as an Alarm. However, after business hours are over, any motion that occurs should be treated as an Alarm.

1. Select the Schedule Menu – Select either Recording or Sensor
2. Highlight time blocks in the schedule that have been set to Motion (or Sensor) and click the desired Event buttons (Alarm Event, Central Station, Emergency Agent). A corresponding letter will display in the selected time blocks

Emergency Agent Schedule

Video recording triggered by motion or sensor events can be sent to the Emergency Agent software.

1. Enable the Emergency Agent Event (see Scheduling Alarm Events above)
2. Enter the IP Address of a PC running the Emergency Agent software in the IP Address
3. Select the box next to the IP Address to enable it. Only one IP Address is supported at a time.
4. Enter the recording duration (in seconds) in the Emergency Time box.
5. See the Emergency Agent chapter for detailed information on setting up the Emergency Agent software.

Special Day Schedule

The user can create days that have a unique recording schedule. If necessary create these on days that are 'not typical' such as Holidays, Special Events, etc.

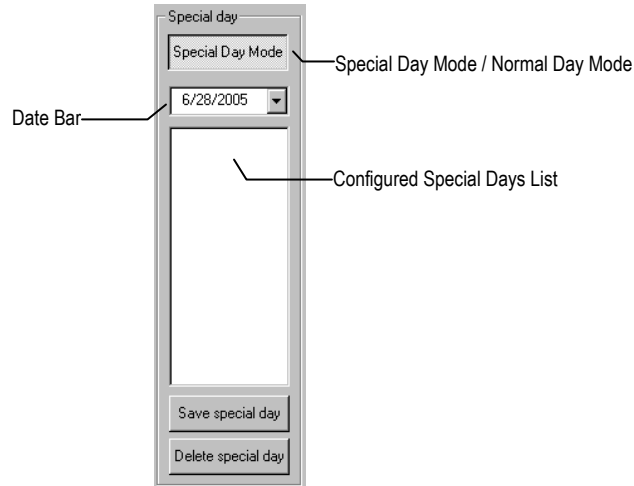

Creating/Editing a 'Special Day' Schedule

1. Click the Normal Day Mode button to enable the Special Day Mode.
2. Select a day by typing the date or clicking the arrow to the right of the Date Bar.
3. Highlight the time-blocks within the Recording Schedule window for the camera(s) selected to schedule. Once the desired Time-Blocks are highlighted, click a Recording Mode button.
4. When finished creating the schedule click the Save Special Day button. The special day should now appear as a date in the Special Day Schedule.

Deleting a 'Special Day' Schedule

1. Select a Special Day from the Special Day Schedules
2. Click the Delete Special Day button.

System Restart Setup

System Restart Setup allows the user to define a schedule wherein the DVR automatically restarts according to specified parameters.

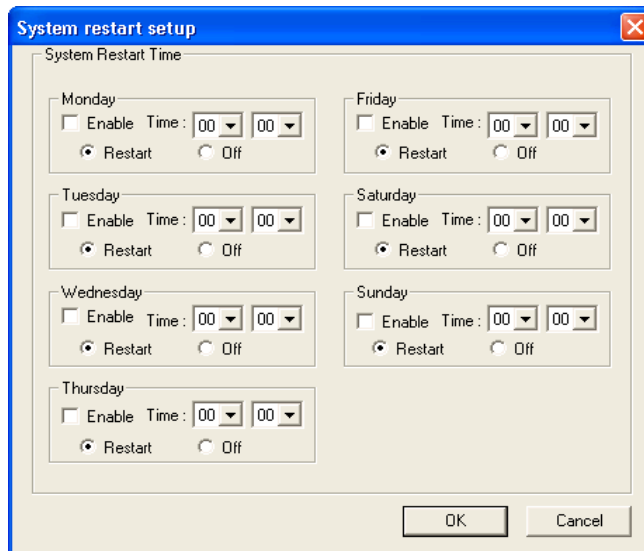

Create System Restart Schedule

1. Open the Schedule Setup Display
2. Click the System Restart button
3. Select the day(s) of the week to schedule an automatic system restart and select the box to enable shut down

NOTE: This step alone does not trigger the DVR to restart, only to shut down.

4. Specify the time of day to schedule the system restart
5. Select the Restart Radio button

NOTE: If the Off Radio button is selected the DVR will shut down at the specified time but not restart.

ALARM SETUP

The Alarm window allows you to enable, disable and configure Sensors and Control Outputs.

Callouts in the image:

- Create & Name Sensor Presets
- Open On-Screen Keyboard
- Configure Hybrid (IP) Sensors*
- Normally Open (NO) / Normally Closed (NC)
- Delay Triggering Relay Output
- Assign Relays comma delineated

*Requires the HVR Software Upgrade

Configure Sensor Response

1. Click the Setup button on the Main Display Screen.
2. Click the Alarm Setup button to open the Alarm display.
3. Click the NO or NC check box to select Normally Open or Normally Closed for the desired sensor.
4. Enter the Delay Time to define the number of seconds after the sensor is tripped until the relay is activated.
5. Enter the relay(s) to associate with the sensor. Two or more relays can be associated with a single sensor – separate with commas.
6. Click Apply.

Activate PTZ Preset on Sensor

1. Create PTZ Preset Position. See instructions in the PTZ Setup Chapter.
2. Click the Setup button on the Main Display Screen.
3. Click the Alarm Setup button to open the Sensor and Output Display.
4. Click the Sensor Preset button.
5. Select the desired camera from the Channel List.
6. Select the appropriate sensor from the list.
7. Select the preconfigured PTZ Preset from the list.
8. Click the Set button. A list of configured Sensor Presets will display in the box below.
9. Repeat for additional sensors.
10. Click the OK button to close the Sensor Preset window.

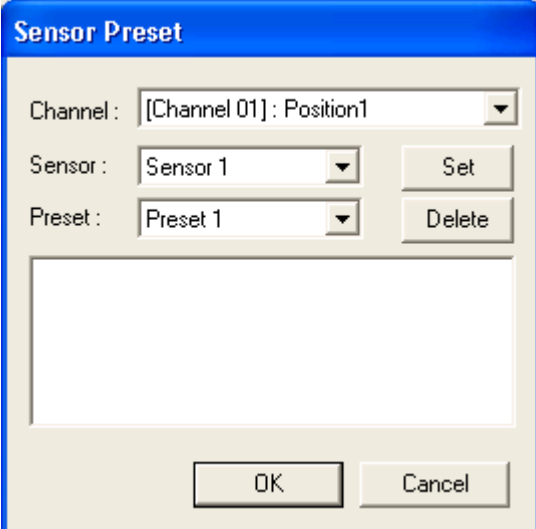

The image shows a software dialog box titled "Sensor Preset". It features three dropdown menus: "Channel" (set to "[Channel 01] : Position1"), "Sensor" (set to "Sensor 1"), and "Preset" (set to "Preset 1"). To the right of the "Sensor" dropdown is a "Set" button, and to the right of the "Preset" dropdown is a "Delete" button. Below these controls is a large, empty rectangular box. At the bottom of the dialog are "OK" and "Cancel" buttons.

GENERAL SETUP

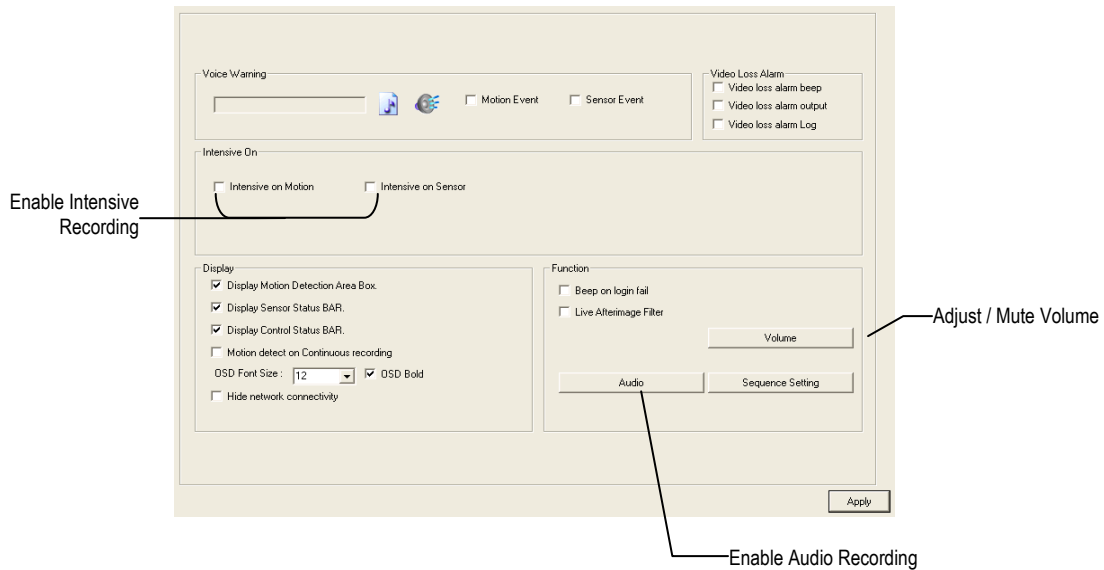

Beep on Login Fail	Enables the DVR to beep continuously in response to a failed login attempt. Only an authorized login will stop the beeping.
Sequence Setting	Allows the video out picture to automatically cycle through channels at a set speed. Ex: .Cycle through channels 1-6 at 4 second intervals.

Voice Warning

The DVR allows users to play a sound file when either a Motion event or Sensor event occur. This file can be a custom created sound file that is unique to the application. The selected WAV file is played through speakers attached to the DVR.

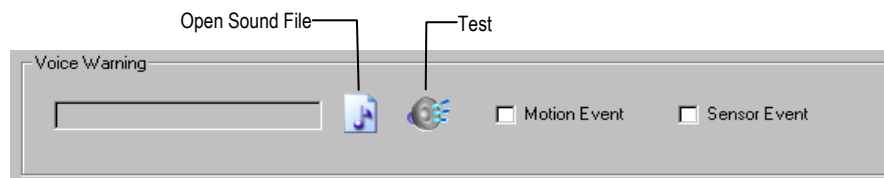

1. Click the Open Sound File icon to browse for a WAV file. The selected file will display in the box on the left.
2. Click the Test icon to verify the audio file.
3. Select Motion Event and/or Sensor Event to trigger the audio file.

Intensive Recording Overview

The Intensive Recording Option allows you to increase the Pictures Per Second and the resolution of any camera recording using sensor activation. When the intensive recording is activated, the resolution of the remaining cameras is immediately reduced to 360x240 and the Pictures Per Second to a user-specified level. This guarantees that the Pictures Per Second and Resolution will be set correctly and not exceed the DVR limitation.

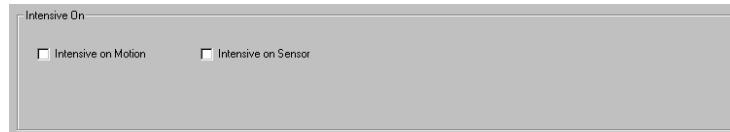

How to Use Intensive Recording

The Intensive Recording option is set up as 'All or Nothing'. This means that once enabled (associated with sensors); all cameras associated with sensors will activate the Intensive Recording.

To activate the Intensive Recording option, follow these steps.

1. Inside Camera Setup, select the camera to use and enable the sensor to associate with it.
2. Click General Setup. Enable the Intensive on Sensor and/or Intensive on Motion option.
3. Click Schedule Setup. Select the Sensor Radio button.
4. Enable the sensor by creating a schedule for it
5. Click the Apply button and exit out of setup.

Audio

The Surveillix DVR is capable of recording up to eight channels of audio.

AUDIO FEATURES:

- 8000 Hz playback in Live Mode
- Up to 48000 Hz playback in search mode
- Mono Sampling

DATA SIZE (Per channel)

- 1 Second: 1625 bytes
- 1 Minute: 97,500 bytes
- 10 Minute: 975,000 bytes
- 1 Hour: 5,850,000 bytes
- 1 Day: 140,400,000 bytes (Approx 140MB)

Click the Audio Capture Channel Boxes to enable recording and adjust the Gain to the desired level.

Capture	Select each channel to enable audio recording.
Gain	Adjust the gain for individual audio channels.
Live	Select each channel to enable for live audio selection.
Audio Live	Select a live audio channel to hear. Only enabled channels are available.
Volume	Adjust the volume sliders for each live audio channel.

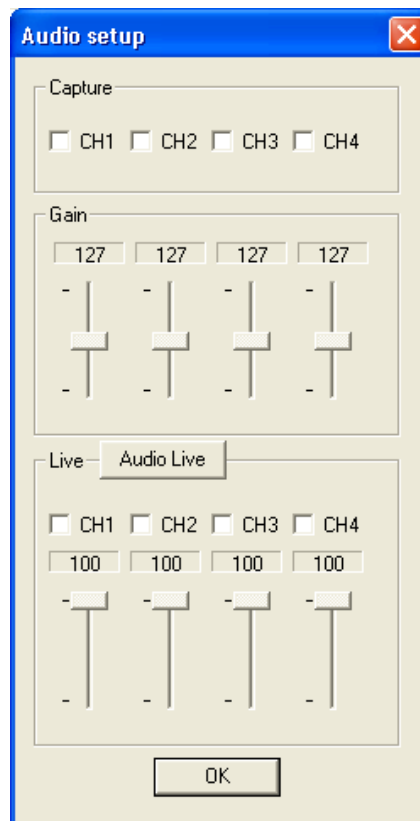

Enabling Audio Recording

1. Click the Audio button on the General setup display.
2. Select an audio channel under Capture.
3. Click OK.

Enabling Live Audio

1. Click the Audio button on the General setup display.
2. Select an audio channel under Live.
3. Click OK.

TIP: Select the audio channel you want to listen to by clicking the Audio Live button and selecting it in Audio Setup. Live audio channels can also be selected from the Main Screen; only audio channels enabled under Live will be available.

TV-Out Setup (Analog)

The DVR features an optional TV-Out functionality which allows users to output video from any number of cameras, in sequence, to a television or monitor display.

1. Under Setup click General, and then click TV Out Setup.
2. Select the TV Out Port to use

Note Each Port must be configured individually, i.e. one after the other.

3. Select the Use check box to enable TV-Out functionality for the selected port.
4. Select each camera to display through the TV-Out port.
5. Select an Event Popup check box if desired.
6. Define the Event Holding Time (the number of seconds the camera displays after an event) for selected event types.
7. Define the Auto Switching Time (the number of seconds between switching of camera) for the selected TV-Out Port.

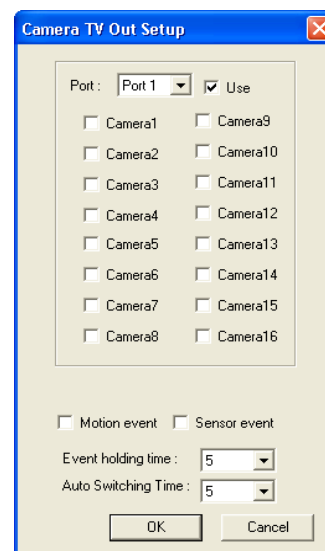

Volume

The volume control allows fine tuning of the volume settings on the DVR.

Volume Options:

- **Slider Controls** – Used to adjust the literal volume for the respective devices listed.
- **Mute Check box** – Check the mute box to mute volume on any of the device columns or check the Mute All checkbox to mute all volume on the DVR.

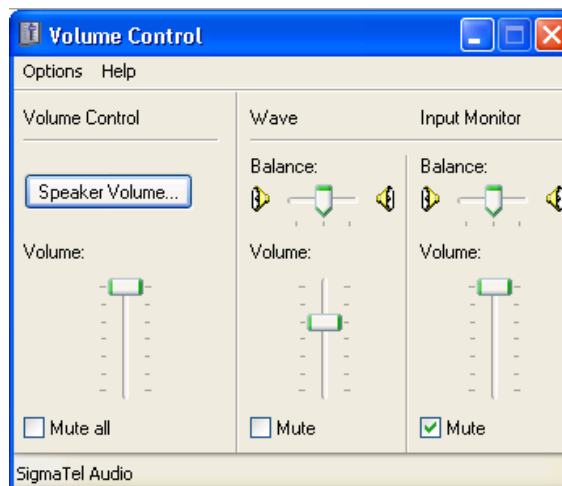

Auto Sequencing Setting

Auto Sequencing is used either in the main screen when Auto Sequencing has been enabled or when a Spot-Monitor Out signal is used to display video on a spot monitor. Auto Sequencing conveniently displays video channels and at specified intervals, sequences through each selected channel.

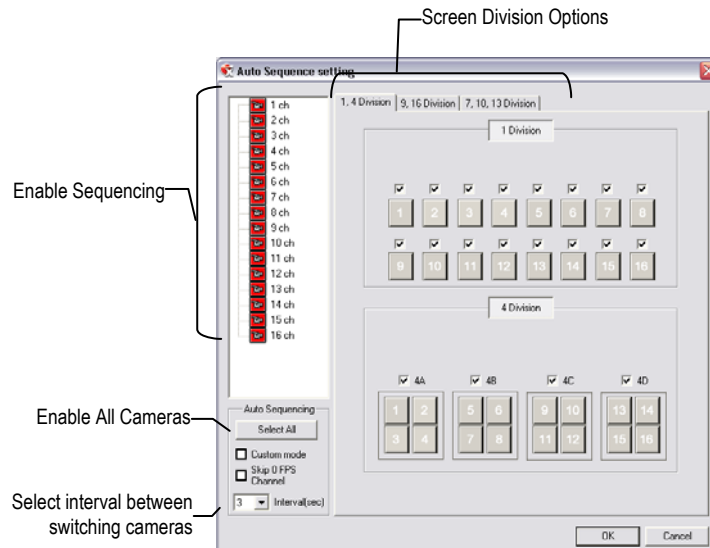

Channel Selection	Click each channel to include in Auto Sequencing.
Custom Mode	Enable to create non-standard screen divisions
Skip 0 FPS Channel	Sequence skips cameras with no video signal.

Create Custom Auto Sequence

1. Open General Setup and click the Sequence Setting button.
2. Click individual cameras in the left pane or click the Select All button to include all cameras in the sequence.
3. Select an interval time (in seconds) to display each screen in the sequence.
4. Select Screen Division options for appropriate cameras.
5. Click the OK button.

NETWORK SETUP

Network Setup allows the user to adjust settings such as Ports, setup emergency PPP information for use with the Emergency Agent and enable Remote Access.

The screenshot shows the Network Setup configuration page. At the top, there is a checkbox for "Disable Remote Control" and a "View IP address" button. Below this is the "Transport Setup" section with "Quality" set to "NORMAL", "Resolution" set to "360*240", and "Transport Rate" set to "100". A callout points to these settings, stating "Settings for Video Sent to Remote Client".

The "Network Setup" section contains fields for "TimeOut Value" (set to 60), "Emergency Port" (2001), "Center Port" (2000), "Image Port" (2002), and "Search Port" (2003). A callout points to these fields, stating "Use with Remote Connections".

The "PPP Setup(Emergency)" section has a "Use PPP" checkbox, "Password" and "Confirm" fields, a "Phone Number" field, and a "Modem Select" dropdown menu set to "N/A". A callout points to these fields, stating "Use with Emergency Agent".

The "Web Function" section has a "Web Viewer(iDVR)" checkbox and an "iDVR Port" field set to 3001. The "Two-way Audio Communication" section has an "Enable Audio Communication" checkbox and an "Audio Port" field set to 3002. A callout points to these sections, stating "Between DVR and Remote Client".

At the bottom, there is a "Keyboard Control" section with a "Use Keyboard Control" checkbox and a "Setup Keyboard Control" button. A callout points to this section, stating "Enable RS-232 Keyboards (PTZ)".

Transport Rate	A bandwidth throttle based on percentage of free network.
Web Viewer (iDVR)	Enables/Disables access to the DVR using the Web Viewer interface.

PTZ SETUP

The PTZ Setup window allows enabling of PTZ cameras, creation of Presets, creation of Tours, and adjustment of camera speed settings. Many options listed here are features only available on selected cameras. Refer to the PTZ chapter in this manual for further information on setting up PTZ cameras and setting PTZ options.

INFORMATION

The Information Display allows users to define the site code necessary for connecting to remote software, save comments relative to the DVR and store tech support and contact number information.

The screenshot displays the PTZ Setup window with the following sections and fields:

- Total HDD /Available HDD Space**: A label pointing to the Drive Information section.
- Current Server Software Version**: A label pointing to the text "DVR Version 3.5.0" in the top right corner.
- Site Information**:
 - Site Code:
 - Board Serial #:
 - System Serial #:
 - Decoder:
 - Video Format:
 - Notes:
- Drive Information**:
 - C: Drive
 - Total Space : 20196 MB
 - Free Space : 17806 MB
 - D: Drive
 - Total Space : 219160 MB
 - Free Space : 219014 MB
 - E: Drive
 - CD Drive
- Telephone Number**:
 - Contact Number:
 - Tech. Support:
- User-Defined Contact Numbers**: A label pointing to the Contact Number and Tech. Support fields.
- Enter comments**: A label pointing to the Notes text area.
- Apply**: A button located at the bottom right of the window.

Site Code	A user-specified unique identification name used by other DVR software to identify the DVR. (Remote, Emergency Agent, SCS, Digital Signature Verifier)
-----------	--

ADMINISTRATIVE SETUP

The screenshot shows the Storage Management interface with the following components:

- Storage Management:** Includes buttons for Disk Management, Status Check/Email, Program Management(ETC), User Management, and File Information.
- Select Date:** A calendar for June 2007 with the 19th highlighted.
- Log Select:** Radio buttons for System Log (selected), Event Log, Alarm Log, and Drive Check Log.
- Export:** A section to choose a 1-week period to export, with Start Date and End Date both set to 6/19/2007. Buttons for Log Export and Log Management are present.
- Log Data Display:** A table showing log entries with columns for No., Date & Time, Log Contents, Log Value, and User.

No.	Date & Time	Log Contents	Log Value	User
1	6/19/2007 1:06:50...	Start Site	Ver(3.5.0 [Build : 11]) - Lib(3.1.1.4)	Default
2	6/19/2007 1:06:50...	First Start Site		Default
3	6/19/2007 1:06:50...	Current Work drive	D Drive	Default

Export Log Data (1 to 7 days)

Disk Management

The Disk Management window is a native Windows function. This window displays the partition scheme and health status of the Hard Disk Drives in the DVR. This window is often used to troubleshoot a DVR, or verify the amount of Hard Drive storage installed. For more information about Disk Management, consult a Windows XP manual.

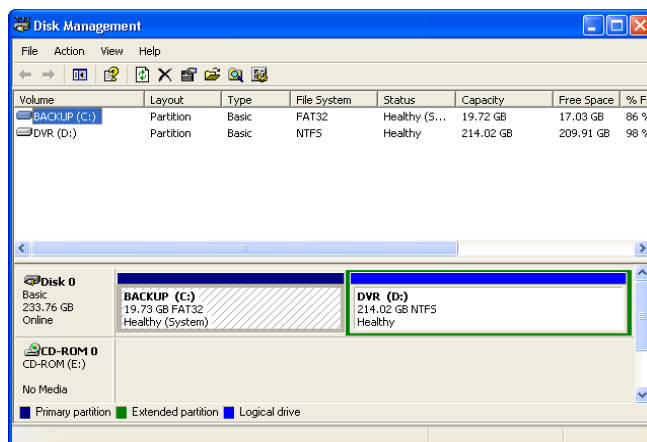

User Management

The User Management Console allows the administrator to create, edit, and delete user accounts. Each user account can be assigned different privileges to limit the usage of the DVR system. Users can be given administrator privileges by enabling all rights, however only the true administrator account can log into the User Management Console.

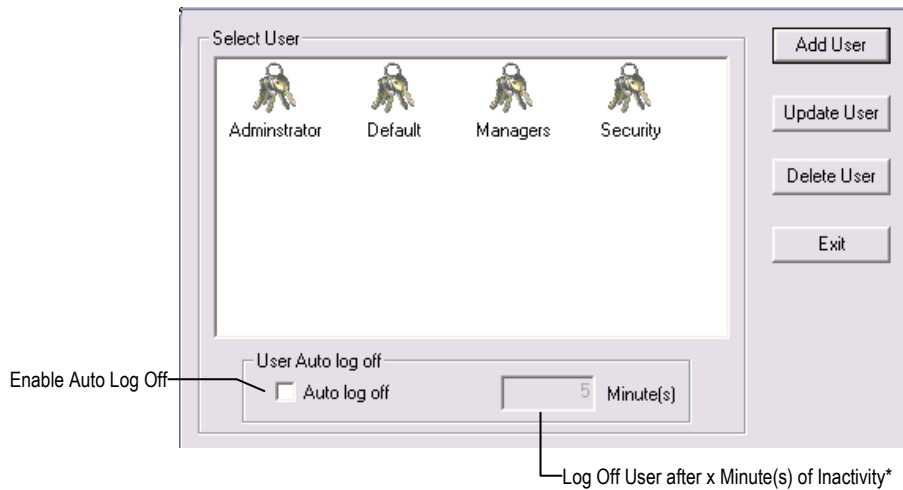

**Auto Log Off affects all users*

CAUTION: The Delete User button immediately deletes the user.

CAUTION: Auto log off will log off the user after the specified time of inactivity – even during playback or backup operations.

Add a New User

1. Open the Administrative Setup display.
2. Click the User Management button.
3. Click Add User to open the User Management window.
4. Enter a user name and password.
5. Enable appropriate Permissions.
6. Select cameras and audio channels to hide from the user.
7. Assign a User Rank.
8. Click the OK button to save changes and close the window.

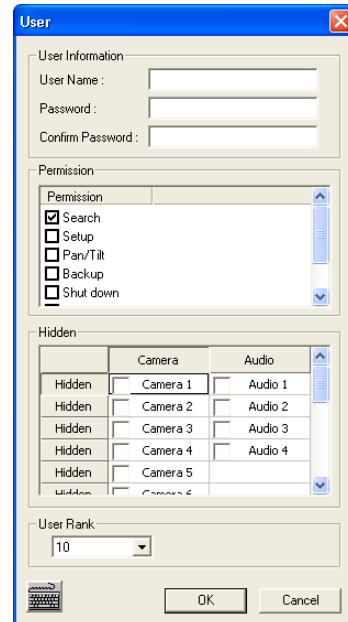

User Rank

The User Ranking structure allows the option to assign a privilege system (1-10 where one has the most rights) to users of the DVR Software. For example: Since only one user is allowed to use the PTZ controls at any one time, an administrator with a higher rank can kick another user out and take control of the PTZ.

The User Rank option affects:

SETUP ACCESS – Only one user can access Setup at any one time. A user with a higher rank will kick another user out and then open Setup.

PTZ CONTROL - The DVR Software can only have 1 user using the PTZ controls at any given time. A user with a higher rank will kick another user out and then open the PTZ controls.

1. Enter Setup.
2. Click the Administrative button.
3. Click the User Management button.
4. Enter the Administrator password and click OK.
5. Select a user from the Select User box and click the Update User button.
6. Set the user's rank using the User Rank list and press the OK button to save changes.

Changing the Administrator Password

1. Inside Administrative Setup, click the User Management button. When the prompt appears, click the Change Password button.
2. Enter the new password in the prompt that appears and click OK.

Default Administrator Password

The default administrator login is:

User: Administrator

Password: <none>

Log Management

The Log Management window provides the user the options to overwrite log files or schedule log deletion.

Setup Log Management Options

1. From the Administrative Setup Display click the Log Management button
2. Select the box to enable the Log File Overwrite Option

Set Log Overwrite

- a. Select Overwrite and define the size of the log file cache

Set Log Cache Size

- a. Select Do Not Overwrite and define the number of days to maintain log files.

Manually Delete Log Files

- a. Select the type(s) of log file to delete. System Log, Event Log, Alarm Log
- b. Click the Delete All button

3. Click the OK button to save the settings and close the window

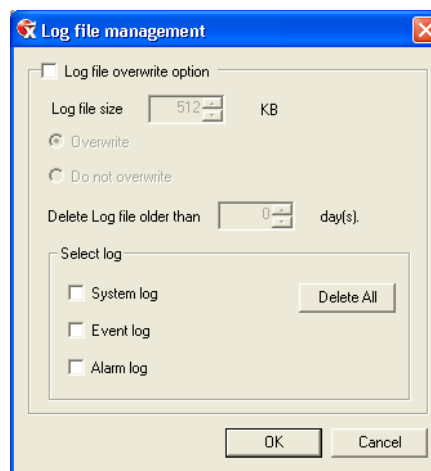

Status Check / Email

General

1. Click the Setup button on the Main Display.
2. Click the Administrative button.
3. Click Status Check/Email.
4. Select the Enable Email Alarm check box.
5. Enter a From Name and e-mail Address.

NOTE: This name and address will appear in the From line of the email alert message.

6. Enter the SMTP information for the "from" email account. Contact the email administrator for this information if necessary.
7. If using a secondary email account select the Use Secondary SMTP Box and complete the SMTP information.
8. Click the Test button to check settings.
9. Click Apply when finished.

The screenshot shows the 'Email Alarm' configuration window with the 'General' tab selected. The window has a title bar with a close button. Below the title bar are three tabs: 'SMART Information', 'SMART Alert', and 'Alarm Event'. Under 'SMART Information', there are sub-tabs for 'General', 'Users', 'Storage Check', and 'Recording Data Check'. The 'General' sub-tab is active. It contains a checkbox for 'Enable E-mail Alarm'. Below it is a 'Send User' section with 'From Name' and 'From Address' text boxes. There are two 'Primary SMTP Setting' sections, each with 'Host Address', 'User name', 'Password', and 'Port' (set to 25) text boxes. Each section has a 'Use Login' checkbox and a 'Test' button. A 'Use Secondary SMTP' checkbox is also present. At the bottom right, there are 'Apply' and 'Close' buttons.

Users

1. Setup the General tab.
2. Click the Users tab.
3. Select the type of event to send email on.
4. Enter the User Name and Email Address of an email recipient.
5. Click the Add button.
6. Repeat for additional recipients and types of events.

NOTE: A separate email notification for each type of event must be set up for a single recipient to receive notifications for each type of event.

7. Click Apply when finished.

The screenshot shows the 'Email Alarm' configuration window with the 'Users' tab selected. The window has a title bar with a close button. Below the title bar are three tabs: 'SMART Information', 'SMART Alert', and 'Alarm Event'. Under 'SMART Information', there are sub-tabs for 'General', 'Users', 'Storage Check', and 'Recording Data Check'. The 'Users' sub-tab is active. It features a table with two columns: 'Name' and 'E-Mail address'. To the right of the table is an 'Event' section with radio buttons for 'HDD Check Alarm Event', 'Recording Data Check', 'Event Alarm', and 'SMART Alarm'. Below that is a 'Registration' section with 'User' and 'E-mail Address' text boxes. At the bottom right, there are 'Add', 'Edit', 'Delete', 'Apply', and 'Close' buttons.

Storage Check

1. Setup the General and Users tabs first. (see above)
2. Select the Use Storage Check check box.
3. Define the number of minutes.
4. Select an Alert Option, Beep or Popup Message, if desired.
5. Click Apply.

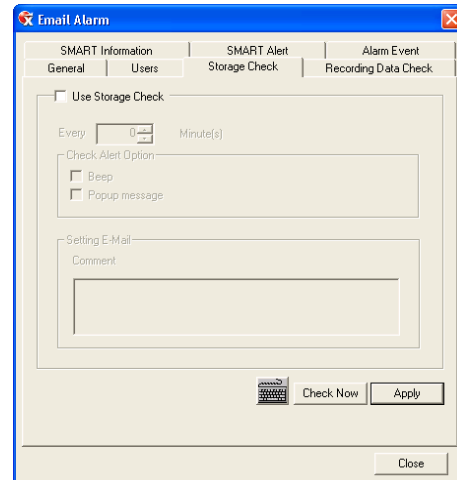

Recording Data Check

1. Setup the General and Users tabs first. (see above)
2. Select the Recording Data Check check box.
3. Define the number of hours between data checks.
4. Select the Action Method.
5. Click Apply.

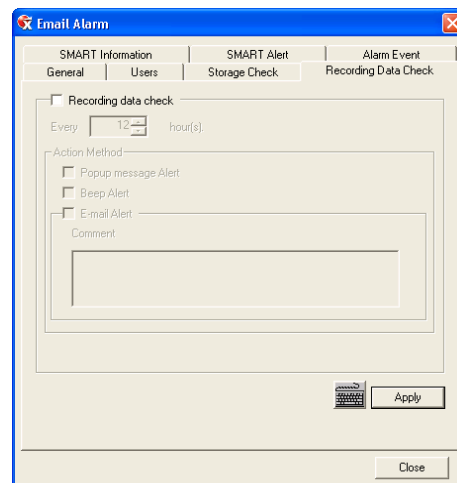

SMART Information

The SMART Information tab displays Hard Drive information.

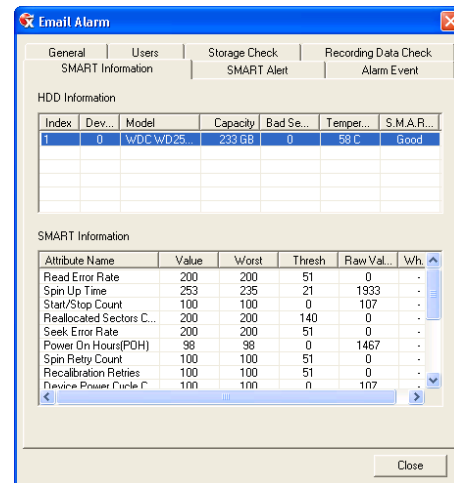

SMART Alert

1. Setup the General and Users tabs first. (see above)
2. Select the Enable SMART Alarm.
3. Define the number hours between SMART checks.
4. Select the type of SMART event to trigger an action.
5. Define the maximum HDD temperature.
6. Select an action method.
7. Click Apply.

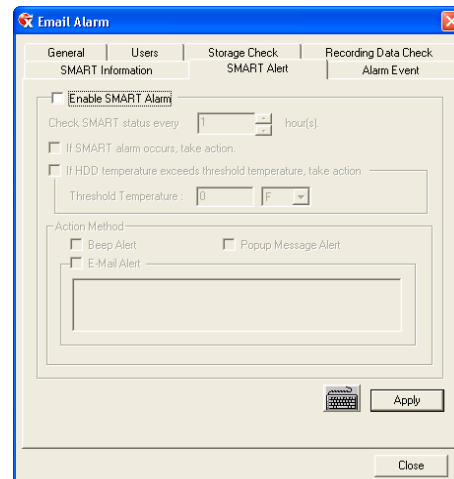

Alarm Event

1. Setup the General and Users tabs first. (see above)
2. Select the Use Email Alarm check box.
3. Define the number of minutes between recording data checks.
4. Select Motion and/or Sensor to send and alert on that type of event.
5. Click Apply.
6. Click Close to return to the Administration tab.

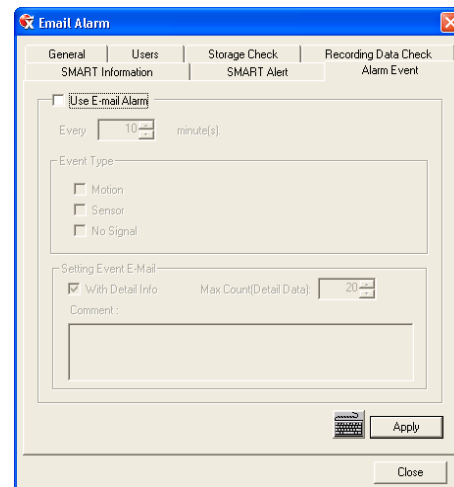

INSTANT RECORDING

The Instant Recording feature allows users to manually initiate recording on a specific camera, overriding the current schedule. When Instant Recording is activated the DVR flags the clip as an event so Instant Recording instances can be found using the Index Search

Instant Recording can be used, for example, when a suspicious object or person is detected and the user wants to flag that section of video for easy retrieval at a later date.

Activate Instant Recording

1. From the Live View screen, double right-click the camera on which to enable instant recording. An INSTANT label will be placed on the upper right corner of the video.
2. To turn the Instant Recording option off, double right-click the video a second time.

Searching 'Instant Recorded' Video

Enter the Search Mode, click the Index Search button, and then select the Instant Recording Option. See the Search chapter for more information.

NOTES:

SEARCH

This chapter includes the following information:

- Setup Overview
- Daylight Saving Time
- Index Search
- Preview Search
- Graphic Search

SEARCH OVERVIEW

The DVR has several options that allow the user to easily search, and find, a particular section of video. From Motion/Sensor indexing to calendar views highlighting days with recorded video; the DVR is equipped to help the user quickly find a specific video or event.

The following chapter describes in detail how to use the DVR search features.

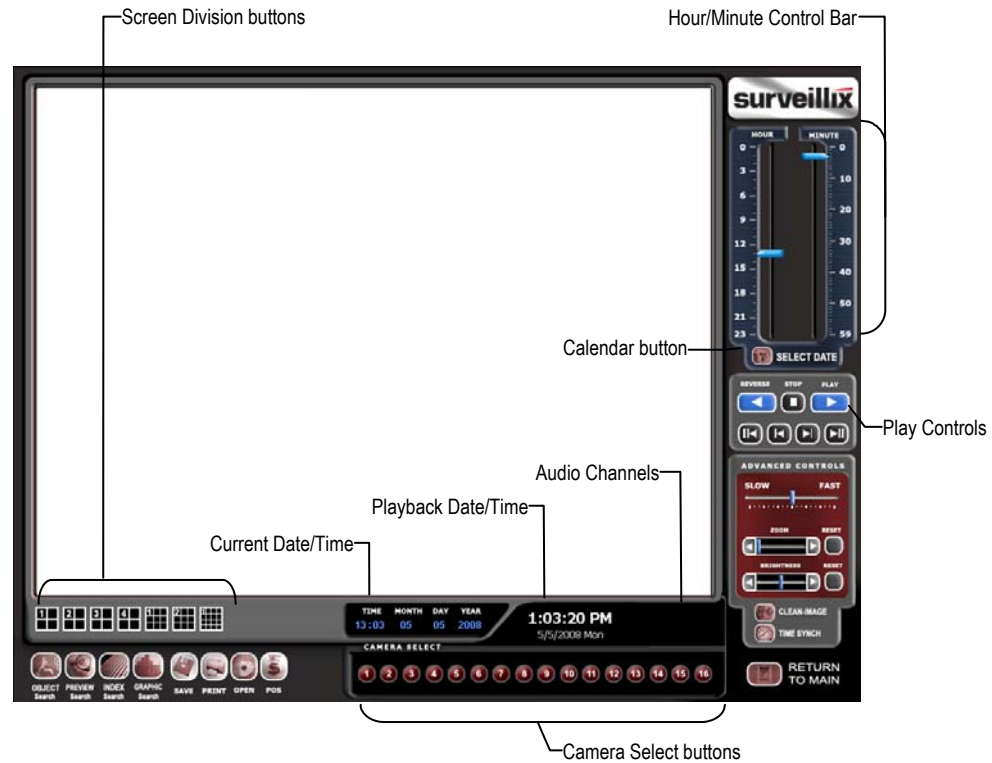

NOTE: Audio Channel buttons are only viewable when one camera is selected.

Play Controls

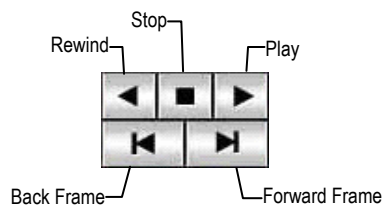

Back Frame	Moves video back one frame.
Rewind	Rewinds video.
Stop	Stops video playback
Play	Plays video.
Forward Frame	Moves video forward one frame.

Adjust the Brightness of an Image

1. Select an image to adjust by double-clicking on the desired image. Multiple images cannot be adjusted at one time.
2. Move the Brightness slide bar to the right or left to adjust the brightness.
3. Reset the Brightness by moving the slider back to the center of the bar.

Zooming In on an Image

1. Select an image to adjust by double-clicking on the desired image. Multiple images cannot be adjusted at one time.
2. Move the Zoom slide bar to the right or left to zoom in or out of an image.
3. Reset the Zoom by moving the slider back to its original position on the bar.

Zooming In on a Portion of an Image

1. Right-click the area of interest on the image and select Zoom.
- or - Double-right-click the image.
2. Repeat to zoom in further.
3. Continue clicking the right mouse button and the image zoom will cycle back to the original size.

Open Video from Saved Location

1. Previously saved video clips or backup files can be searched for content. Find file by date and time or by name.
2. Click the Open button to search for the saved file
3. Select a file from the list of saved clips and backup files or search by start hour.
4. Click OK to open the saved file

Time Sync

The Time Sync option synchronizes a single channel of video to playback in real time. Ordinarily the video may playback slower or faster depending on several factors, including how many PPS recorded and number of cameras playing at the same time.

1. Select a single image to synchronize by double-clicking on an image.
2. Click the Time Sync button. The video will now playback in real time.

Clean Image

The DVR is capable of recording video using one of three different resolutions. When using the 720 x 480 resolution, two boxes are mixed. Because of the timing gap between the two boxes, according to the standardized image rules, after image might occur to high speed moving images. The Surveillix DVR allows the user to remove this by clicking the Clean Image button.

DAYLIGHT SAVING TIME

The DVR automatically adjusts for Daylight Saving Time changes. When the hour “jumps forward” no video is lost because an hour is skipped. However when the hour “falls back” there is a duplicated hour that under normal circumstances would be recorded over. The Surveillix DVR actually records both hours and allows the user to select which hour to play if the need arises.

To access the 'lost hour':

1. From the Search screen, click the Calendar button.
2. Select the date when Daylight Saving time 'lost' an hour. The Daylight Saving option appears.
3. To play back the 'lost hour', select the Daylight Savings option.
4. Click OK to confirm the date and begin playing the video using standard search features.

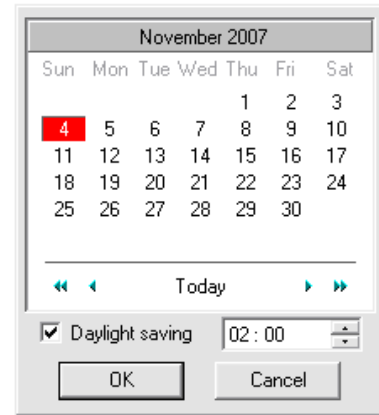

SAVE TO JPG OR AVI

The DVR can export single images in the Image file formats and save video clips in an .AVI format. Both .JPG and .AVI file formats are the most commonly used graphical formats today. Virtually every computer offers some type of support for these file formats which make them the most ideal formats to use.

JPG Optimized for compressing full-color or grayscale photographic images, .JPG images are 24-bit (16.7 million color) graphics. Use .JPG to export a single image or frame.

AVI .AVI image data can be stored uncompressed, but it is typically compressed using a Windows-supplied or third party compression and decompression module called a codec. .AVI is used to export a video clip.

1. From the Search screen, click the Save button.
2. Select the Export Type: Image File (JPG) or AVI File

NOTE: Different image format types provide different file-sizes, quality and compatibility

Image File

- a. Select Quality - 50>100. When size is not an issue, set the quality to 100.

AVI File

- a. Enter the duration (seconds) to record. Although 100 is the longest time displayed, a longer recording may be entered manually.
- b. Select a Compression Codec. Each codec provides different levels of quality, compatibility and file-size.
- c. Select Quality - 50>100. When size is not an issue, set quality to 100.

3. Click the Export button to save file. The Cancel button exits the window without exporting file.

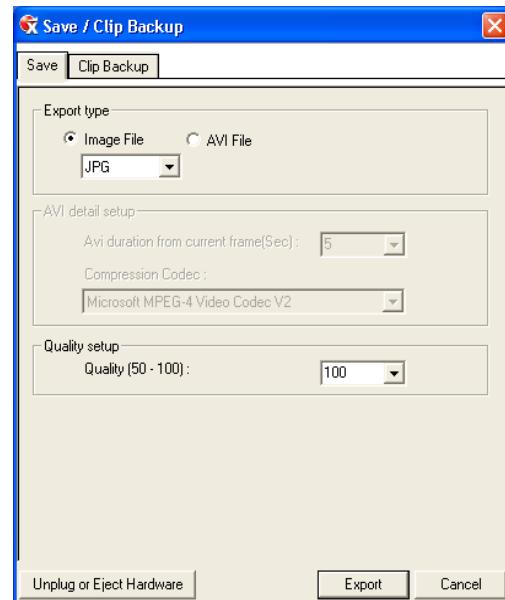

SINGLE CLIP BACKUP

Along with the Save option, a single camera backup option is also included with the Surveillix software. The single Camera or Clip Backup allows the user to backup a single camera without having to backup multiple cameras at a given time. The Clip Backup option gives the users the ability to choose a backup time frame, choose a specific camera, add memos, and even make a copy of the Backup Viewer if needed.

1. From the Search screen, click the Save button.
2. Select the drive from the file tree to save data to. (Hard disk drive, removable drive, CD/DVD drive)
3. Select one camera from the list of
4. Define the Start and End time of the backup clip
5. Select the Include Viewer to include a copy of the proprietary Backup Viewer Software to view the clip on virtually any windows machine
6. Click the Add Memo button to include additional information
7. Click the Backup button to start backup

NOTE: If backing up to a removable USB device click the Unplug or Eject Hardware button after backup is complete to safely remove the device.

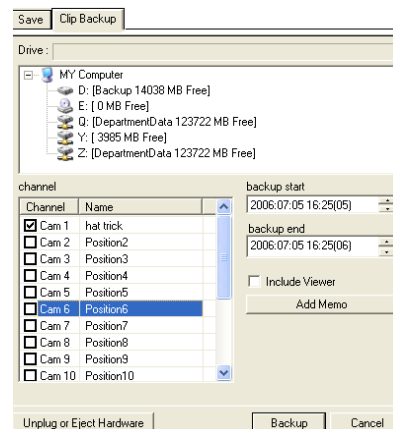

PRINTING AN IMAGE

1. Using the Search screen to locate the desired frame. Double-click the image.

NOTE: Only one camera can be selected at a time for this function to work.

2. Click the Print button. A Print Options window appears. Depending on the printer being used, there may be several printing options available. Refer to the printer manual for more information.
3. Click the Print button to print the selected images.

NOTE: The message "NO DEFAULT PRINTERS INSTALLED" will display if no printer is installed.

PERFORMING A BASIC SEARCH

There are several different types of searches that can be performed on the DVR. The most basic involves selecting the date, the time, the camera, and clicking play.

1. Click the Calendar button to select a date.
2. Select a time by adjusting the hour and minute slide bars.
3. Select one or more cameras.
4. Click Play. Video can be played forwards, backwards, or frame-by-frame.

INDEX SEARCH

Using the Index Search can greatly decrease the amount of time spent searching through saved video. The Index Search allows a user to perform a search based on criterion such as Sensor, Motion and Instant Record events

Performing an Index Search

1. Click the Calendar button on the Search Screen to select the date to search.
2. Click the Index Search button.
3. Select the cameras and sensors to include in the search
4. Select the Select Time check box to define a specific period.
5. Select an event type to search (sensor, motion, instant record) or select the All Event option.
6. Click OK. There may be a delay while results are returned. Results will be displayed in a column on the left side of the screen – Each line represents a segment of video. If no results are found, "NO IMAGE FOUND" will appear in the column.
7. Once the results are displayed, double-click any one to play the associated video.
8. Once the desired image is found, apply it to the Main Search by selecting the Close button at the bottom of the results column.

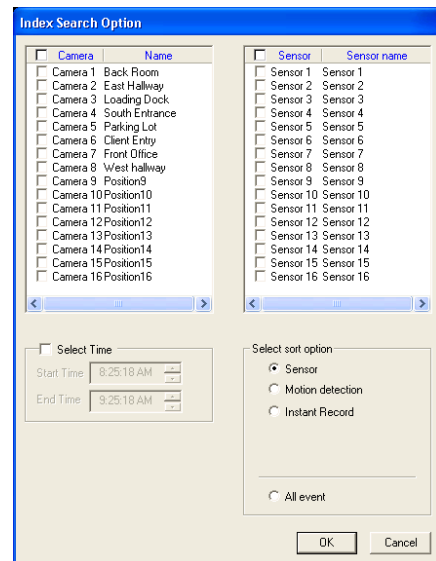

Index Search Results Display

Image Display Area

Event Recorded on Camera #

Time Event Occurred

Event Type:

M – Motion

S – Sensor

I – Instant Record

Time	Camera	Type
08:34:21	C01[Back R	M
08:35:34	C01[Back R	M
08:36:17	C01[Back R	M
08:36:38	C01[Back R	M
08:37:17	C01[Back R	M
08:38:49	C01[Back R	M
08:39:31	C01[Back R	M
08:40:31	C01[Back R	M
08:42:12	C01[Back R	M

PREVIEW SEARCH

Preview Search can be used in a number of circumstances to quickly find an exact moment where an event, such as a theft, occurred. The Preview Search gives a 24 Hour visual overview of a single camera by separating a 24 hour period (1 day) into 24 images, one image for each hour of the day. The search can then be further narrowed down into ten minute increments and one minute increments by selecting one of the images displayed.

These example images show how the Preview Search functions.

The first screen that appears has 24 images displayed. Each image represents the first second of each hour. If there is no image recorded during that period then nothing will be displayed.

When an hour is selected (by double-clicking on the image), a new screen appears with 6 images. Each of these images represents a 10 minute segment of video within the selected hour.

Once a 10 minute segment is selected (by double-clicking on the image) the final screen appears which breaks down that 10 minute segment into 1 minute increments (10 images).

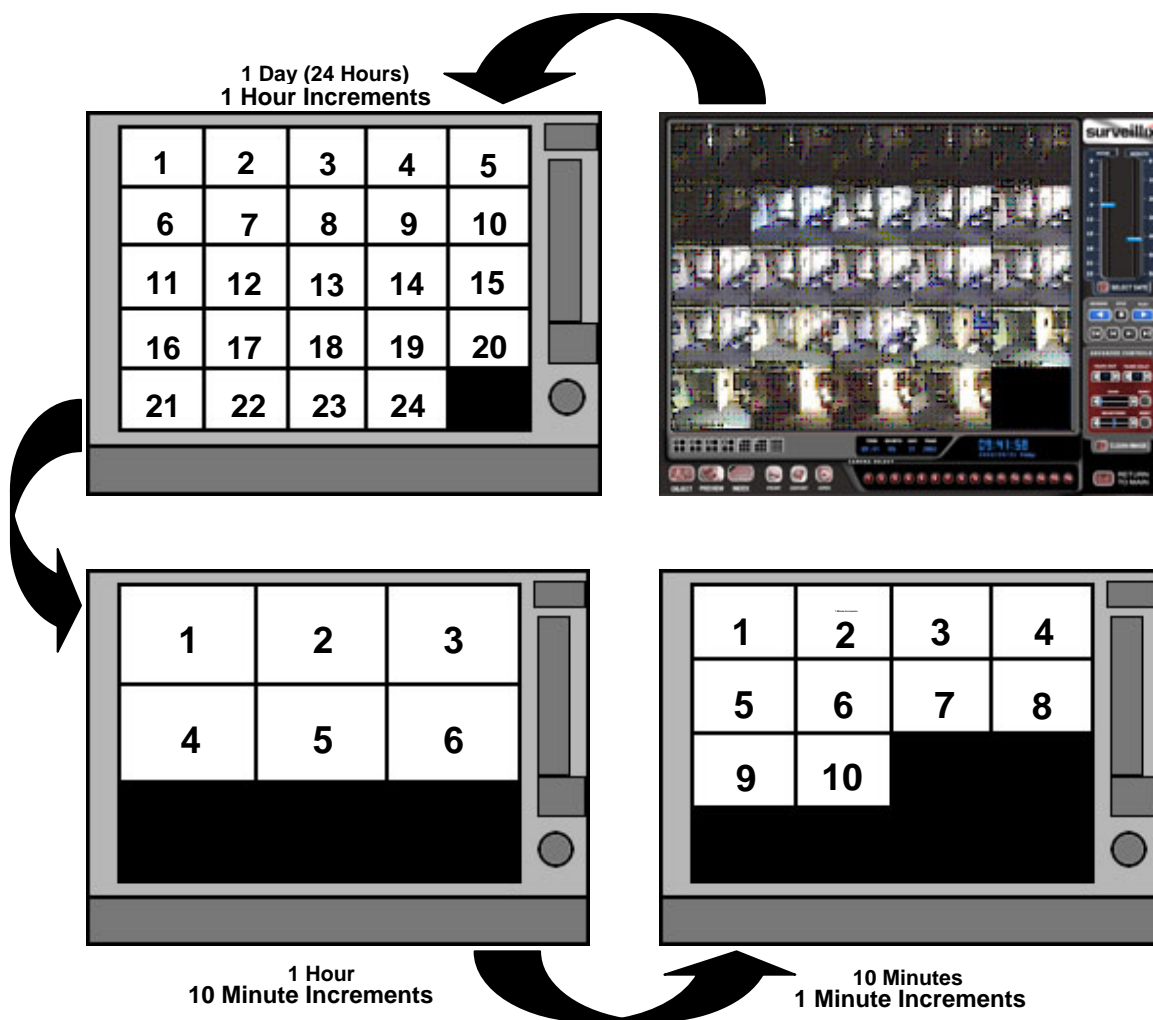

Performing a Preview Search

1. Select a single camera by either turning off all cameras but one or double-clicking a displayed image.
2. Select the Preview Search button. 24 images display. If there is no recorded video during a portion of the day, "No Image" will be displayed where the image should be.
3. Refine the search by double-clicking on an image to select it. 6 images display. If needed, return to the previous 24-image view by right-clicking on an image.
4. Refine the search by double-clicking on an image to select it. 10 images display. If needed, return to the previous 6-image view by right-clicking on an image.
5. Double-click an image to select the 1-minute segment of video to play. A single image displays. If needed, return to the previous 10-image view by right-clicking on an image.
6. Use the Play controls to play the video of the selected segment.
7. To exit out of the Preview search with the current image still selected, deselect the Preview Search button.

GRAPHIC SEARCH

The Graphic Search option displays video in graph format.

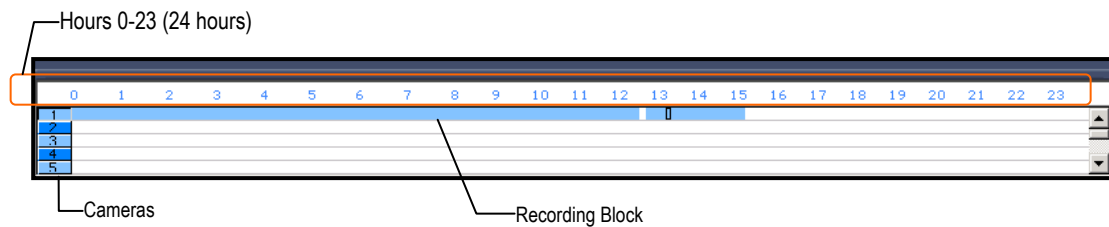

Performing a Graphic Search

1. Select the Graphic Search button on Search Screen Display
2. Click the calendar icon to select a day
3. Click an area of the blue recording block. Only one camera can be displayed at a time.
4. Recorded video from the corresponding camera and time block will display above
5. Use the mouse or arrow buttons to move through recording blocks and view video

OBJECT SEARCH

Object Search is a powerful search utility used to search a region on the video for any motion changes. Results are neatly displayed and can be viewed quickly.

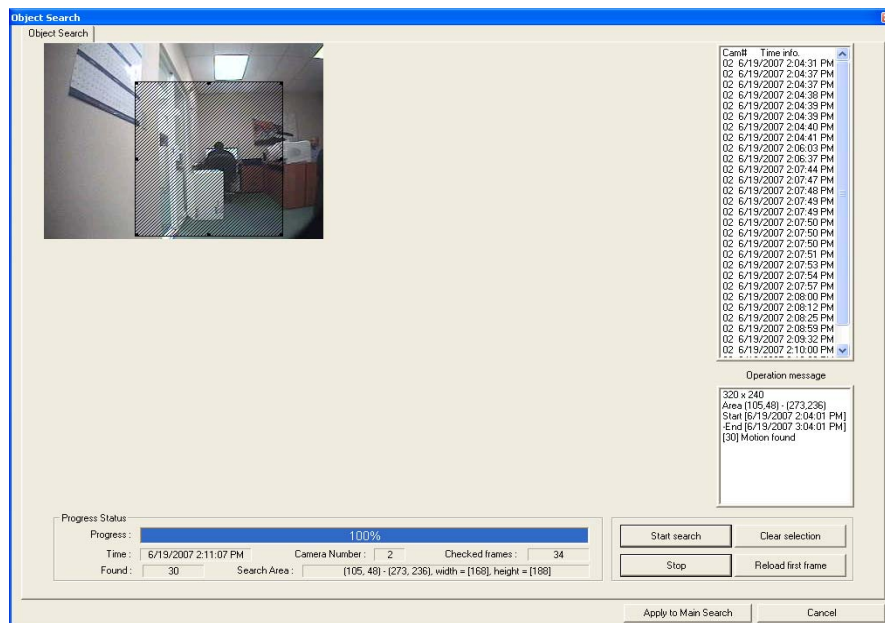

Performing an Object Search

1. Perform a Basic Search to determine the start time of the object search.
2. Select a single camera, either by turning off all cameras but one or by double-clicking a displayed image.
3. Click the Object Search button on the Search Screen Display
4. Click and drag the mouse on the video display to define a motion region box. Resize by pulling on the small square boxes located on the perimeter of the box.
5. Click the Start Search button, the Object Search Filter window will open
6. Select an end date/time. One hour is the default setting.
7. Adjust the sensitivity if necessary.

NOTE: If you select Key frame search the DVR only search key frames for motion in the selected area, and if you select Show detected image, the DVR will show each frame as it is searched; this will slow the search process significantly.

8. Click the OK button
9. Select a motion event from the search results list displayed on the right
10. Click the Apply to Main Search button to display the selected image in the main Search Screen and to use play controls
11. To start a new object search using the original image click the Reload First Frame button
12. To exit Object Search without selecting an image, click the Cancel button

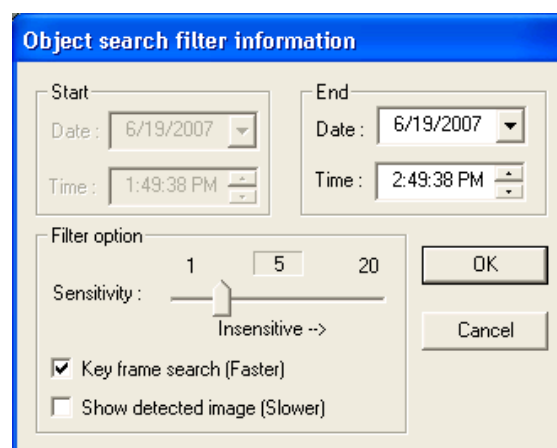

SEARCH IN LIVE

The Search in Live feature allows users to review events immediately while monitoring live video. Pause, rewind, and resume live video within seconds of an alarm event or suspicious activity.

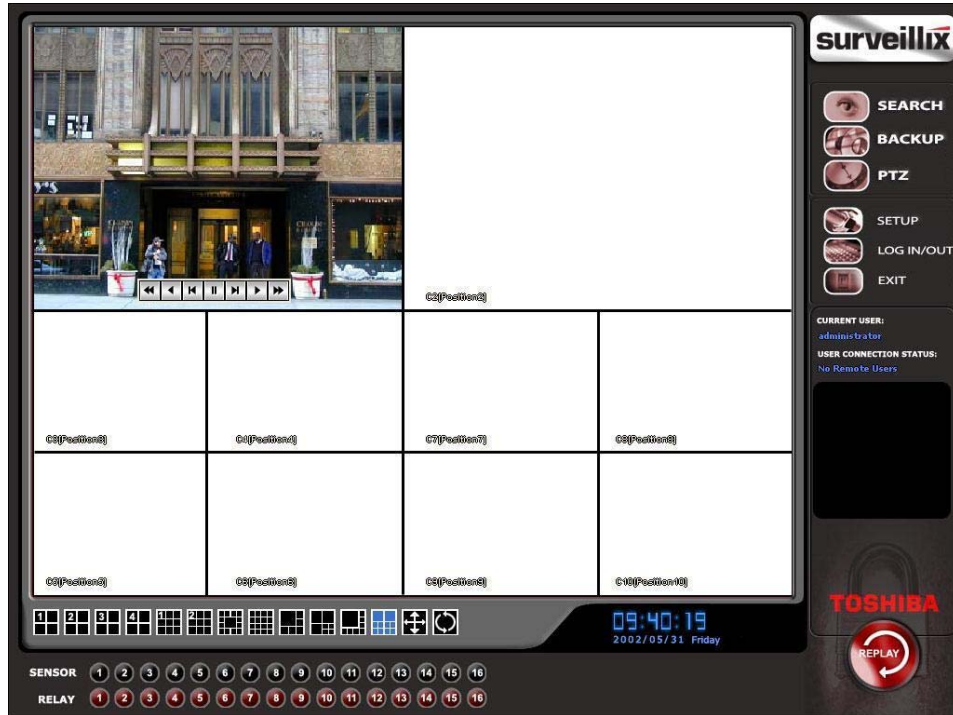

1. Move the mouse cursor over the desired live video display on the Live Display Screen.
2. Press the Scroll button on the mouse.
3. The Search in Live Controls will display at the bottom of the image.
4. Use the controls to pause, rewind, move frame-by-frame or resume playing as desired.



AUDIO PLAYBACK

Audio is played back at 48,000Hz. To play audio with the video:

1. Select a single camera by turning off all cameras but one using the Camera Select buttons. The audio buttons will be displayed.
2. Select a single audio channel to play. When an audio channel is selected, the Time Sync button will be automatically selected.
3. Click Play.

PAN / TILT / ZOOM

This chapter includes the following information:

- Overview
- Setting up the PTZ
- Creating and Viewing a Preset Position
- Creating and Viewing a Preset Pattern

PAN / TILT / ZOOM OVERVIEW

The PTZ controls within the DVR allow for powerful control over the cameras. This can be extremely beneficial by increasing the usefulness of the recorded video. Using the PTZ controls you can create custom preset configurations that can continuously sweep across large areas.

SETTING UP A PTZ CAMERA

Setting up a PTZ Camera is simple. The DVR comes preassembled with an internal PTZ adapter. The cabling may be run up to 2,000 ft using 22 Gauge Twisted Pair.

It is important to understand how the PTZ connects to the DVR. The DVR outputs an RS-232 signal and converts it to an RS-422/485 signal which is then sent to the PTZ camera.

Attaching the PTZ Adapter

Refer to the Connections section of this manual for information on connecting the PTZ camera to the DVR

Enable the PTZ Settings

1. Inside the DVR PTZ Setup, select the PTZ camera using the Camera Channel list.
2. Enable the PTZ functions of the camera by placing a check in the Enable Pan/Tilt check box.
3. Select the appropriate Protocol and set the PTZ Driver Address and Serial Port Settings (See Advanced PTZ Setup in the chapter).

NOTE: The majority of major PTZ manufacture protocols are included in this software. Refer to the Supported PTZ Protocols list in this manual.

4. Click Apply and Exit Setup.
5. From the Main Display Screen select the PTZ button (See the chapter on DVR Basics) The PTZ Controller will open.
6. Select the PTZ camera to control by clicking on its video on the main display screen. The camera number will appear inside the PTZ controls.
7. Using the PTZ controls, move the PTZ around.

ADVANCED PTZ SETUP

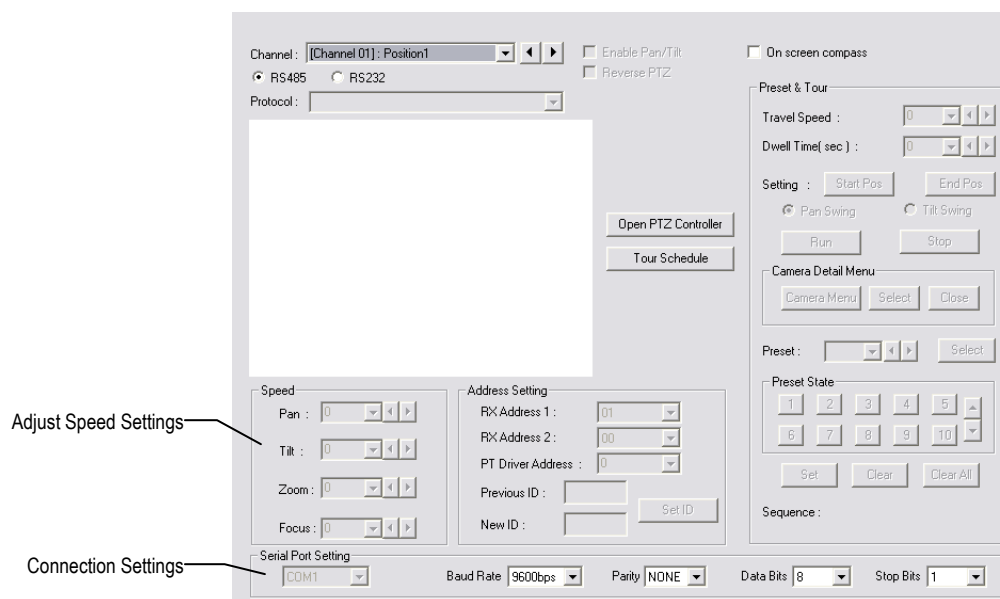

NOTE: Preset and Tour options may vary depending on the camera

Creating and Viewing Preset Positions

A Preset Position is a user-defined location where the camera can be pointed, zoomed in, and focused. Preset positions can be defined and labeled if the camera supports this.

Creating a Preset

1. Inside Setup, select the PTZ setup option and select the camera wish to edit.
2. If the camera is already selected click the Open PTZ Controller button
3. Move the selected camera to the desired position using the Pan/Tilt/Zoom/Focus controls.
4. In the Preset & Tour Detail section choose a Preset # (1-10) using the list or the Right and Left Arrow buttons and click Select.



NOTE: Preset positions can also be created using the advanced buttons on the PTZ graphical controller.

Viewing a Preset

1. From the Main Display Screen select the PTZ camera by clicking on it.
2. Using the keyboard click the number keys corresponding with the Preset Positions. The Camera will move to the saved Preset.

PTZ Address Settings

Some protocols support software address settings.

The RX Addresses and ID settings are compatible with a particular line of receivers that support 2 ID addresses

The PT Driver Address is associated with the PTZ ID address set on the camera. The addresses must match for the DVR to communicate with the proper PTZ camera. This is especially important when a large number of PTZ cameras are connected to the DVR.

NOTE: To select a PT Driver Address of 129-254, manually enter the ID in the box.

Address Setting

RX Address 1 : 01

RX Address 2 : 00

PT Driver Address : 0

Previous ID :

New ID :

Set ID

ACCESSING PTZ MENUS

Some protocols support the ability to access the Internal PTZ Onscreen Menu

Since every PTZ camera is different, the functions of these options can vary slightly.

The Surveillix DVR provides an easy way to access the cameras options. For explanations of what those options are please refer to the manual that came with the camera

NOTE: Use the arrow buttons on the PTZ controller move through the PTZ Menu options and/or highlight options.

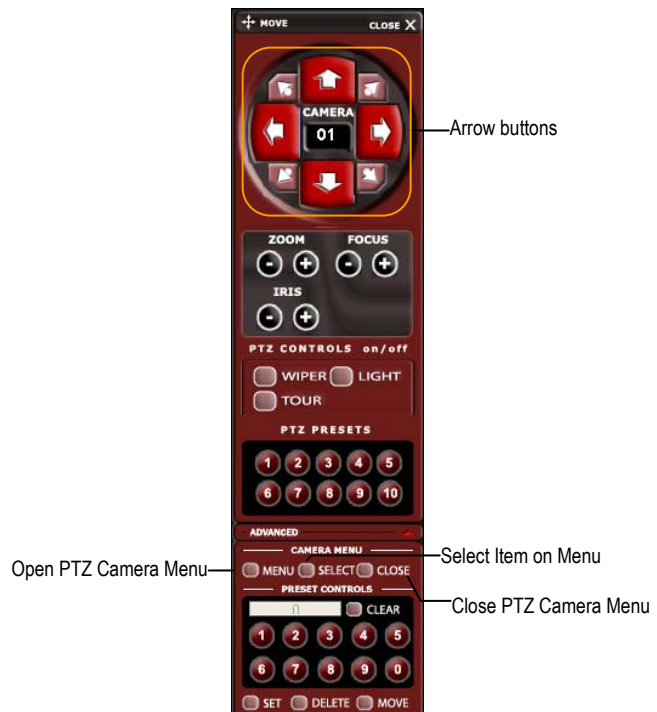

CONTROLLING A PTZ CAMERA

The Surveillix DVRs provide control for a PAN/TILT camera in two different ways.

- The first method is to use the Graphical PTZ Controller that appears when the PTZ button is clicked on the main screen.
- The second method is to use the mouse to control the camera directly from the live video display.

Using the Graphical PTZ Controller

- Use the Arrow buttons to control the direction of the PTZ camera
- To select a new camera, click the video display of a different camera on the Main Screen Display.

NOTE: Eight directions are available only for select protocols. Only four of the PTZ Control buttons work for all protocols (UP, DOWN, LEFT, RIGHT).

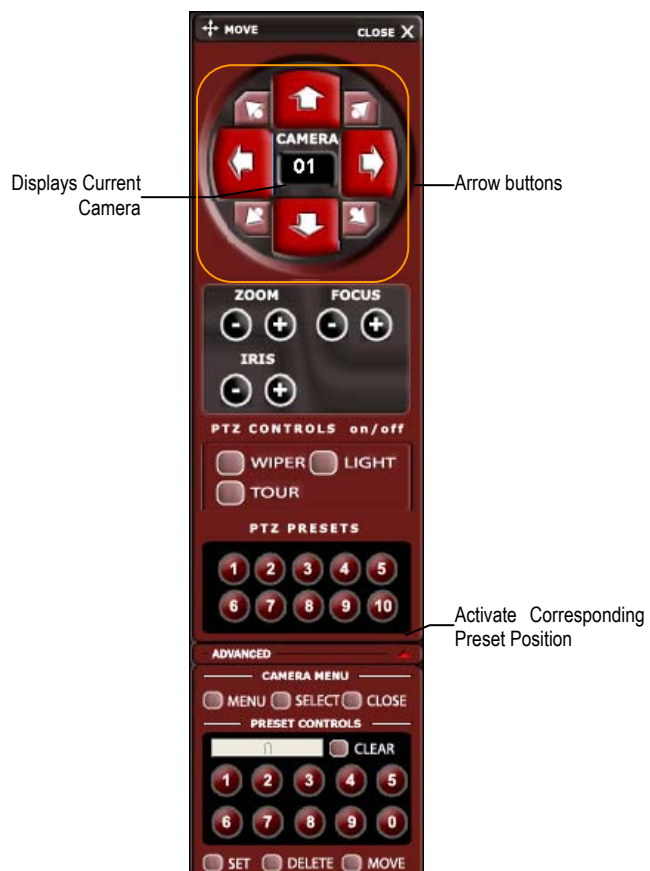

Using the On-Screen Compass

1. Click the Setup button on the main screen.
2. Click PTZ Setup.
3. Select the On Screen Compass check box to enable the feature.
4. Click Apply.
5. Click the Exit button to return to the main screen.
6. Click the PTZ button.
7. Control the PTZ by dragging the mouse on the screen in the desired direction. A green line will appear to show the direction the PTZ will move. The shorter the line the less the PTZ will move. The longer the line the more the PTZ will travel in the specified direction.



UNDERSTANDING TOURS

Preset & Tour

Travel Speed : 30

Dwell Time(sec) : 63

Setting : Start Pos End Pos

Pan Swing Tilt Swing

Run Stop

Travel Speed	The speed between one Preset position to the next
Dwell Time	The length of time (in seconds) that a PTZ Tour displays a Preset Position.
Setting: Start Pos / End Pos	Define a Mimic Tour. The Start Position button begins the 'recording' process. The Stop Position button ends it.
Pan Swing / Tilt Swing	This option enables the Horizontal (Pan) or Vertical (Tilt) 'Guard Tours'.
Run / Stop	Runs the selected Pan or Tilt Tour.

PTZ Tour Schedule

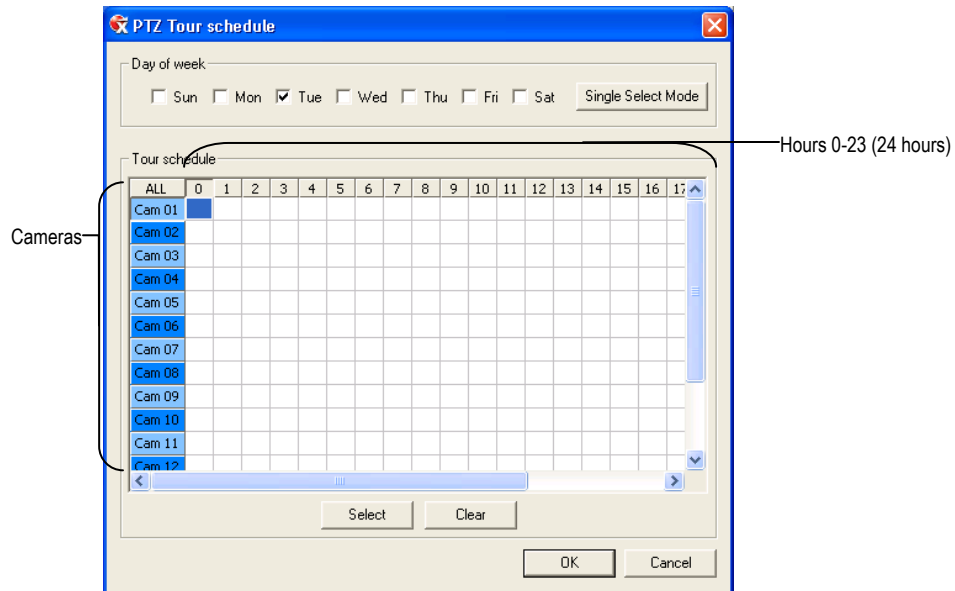

Create PTZ Tour Schedule

1. Click the Setup button on the Main Screen.
2. Click the PTZ Setup button.
3. Click the Tour Schedule button to open the PTZ Tour Schedule window.
4. In Single Select Mode select one day of the week to create a schedule for or toggle to Multi Select Mode to select multiple days with the same schedule.
5. Click and drag the mouse cursor to select blocks of time (hours 0-24) and corresponding cameras.
6. Click the Select button.
7. When finished click the OK button to save changes and close the window.

Supported Protocols

Protocols are added frequently. The Surveillix Server software may support new protocols that are not listed here.

The current supported protocols are:

ADEMCO RAPID DOME	LG (LVC-M300/310)
AMERICAN DYNAMICS	LG MULTIX
BOSCH AUTODOME	LG SPEED DOME
CBC (GANZ)	MERCER
C-BEL	MERIT LI-LIN
CELBO SPEED DOME	MERIT LI-LIN V6
CHIPER CPT (V9KR SERIES)	MIC1-300
CNB-AN102	MOLYNX
CNB-PTZ100	NICECAM
COMPUTAR	NIKO
COVI EVQ-1000	WSD-7425
DENNARD RS485	ORX-1000 (KRE-303)
DMP23-H2	PANASONIC
DONG YANG DSC-230/240	PANASONIC V2
DONG YANG SPEEDDOME	PELCO (P PROTOCOL 4800BPS)
DONG YANG UNITECH (DRX-502A)	PELCO DRD08/DRD14 SERIES
DONGYANG (255RXC)	PHILIPS (TC8560 & TC700)
DVRX-1000	SAE
DYNACOLOR	SAMSUNG (DRX-502A)
ERAESEEDS (CRX-1401)	SAMSUNG (MRX-1000)
ERNITEC	SAMSUNG (SCC-641)
EVERFOCUS EPTZ1000	SAMSUNG (SCC-C6407)
FASTRAX II	SAMSUNG (SPD-3300P)
FASTRAX IIE	SANTACHI
FILLTECH (DSC-230/PT-201)	SENSORMATIC SPEEDDOME-AD DELTADOME
FINE SYSTEM (CRR-1600)	SONY BRC-300
FOCVISION (KD1602)	SPD-2500P
GANZ ZC - PT SERIES	SUNGJIN (SJ2819RX)
HMC-250	SUNGJIN (SJ3000RX)
HSCP	T TIAT TRX-100
HONEYWELL (GC-655P)	T TIAT TTR-100
HONEYWELL (HSD-250)	TAMRON
HONEYWELL (HSD-251)	TELEEYE DOME
HONEYWELL (KDEC-300)	TOSHIBA (P PROTOCOL 4800BPS)
HONEYWELL HD6	ULTRAK (KD6)
INTER-M (VSD-640)	VCL
INTER-M(VRX-2101)	VCL- LEGACY
JAVELIN (ORBITOR)	VICON
JVC TK-C676/C55	VICON SURVEYOR 2000
KALATEL (CYBER DOME)	VIDEOALARM
KDC	VIDEOTREC
KODITEC	VISION TECH
LG (LPT-A100L)	WONWOO
LG (LVC-A70X'S)	WSD-7425D

BACKING UP VIDEO DATA

This chapter includes the following information:

- Overview
- Saving Video to a DVD-R
- Saving Video from a Single Camera
- Scheduling Regular Video Backup

BACKUP OVERVIEW

The DVR can easily backup important video data to an internal or external media location. The most commonly used forms of this are CD-R/RWs, External USB or FireWire Hard Drives, and Network Drives. Every DVR comes standard equipped with a DVD±RW drive, USB port, and Network Adapter.

The DVR is capable of performing a backup to multiple DVDs when the file sizes exceed the capacity of a single disk. You may also specify multiple locations for backup as well as the order they are recorded to.

The DVR backs up video data using a proprietary compression format that can only be read by the DVR Backup Viewer Software. This ensures the integrity of the data.

Throughout the backup process the DVR will continue recording without interruption. This is the result of the tremendous multiplexing power of the DVR which allows it to perform virtually all functions without disrupting the recording process.

NERO® EXPRESS

The DVR uses Windows® XP® Embedded running Nero Express 7 to write data to the DVD±RW Drive. This solution allows the DVR software to read and write data to the DVD-ROM Drive without the requirement of formatting the disk first.



CAUTION: Although many features are available within Nero, it is highly recommended that you do NOT use any features other than those necessary for the standard backup of video data as outlined in this section, loss of information or software instability may result.

BACKUP CENTER OVERVIEW

The Backup Center allows you to back up recorded video data from multiple dates and times to one or more locations including the DVD-ROM drive, Network Storage Locations, and External Hard Drives.

NOTE: USB performance is reduced during backup to preserve resources for recording.

General Backup Screen

The General Backup window is used for performing bulk backup of video recorded by all cameras for a selected period or periods to a specified storage location.

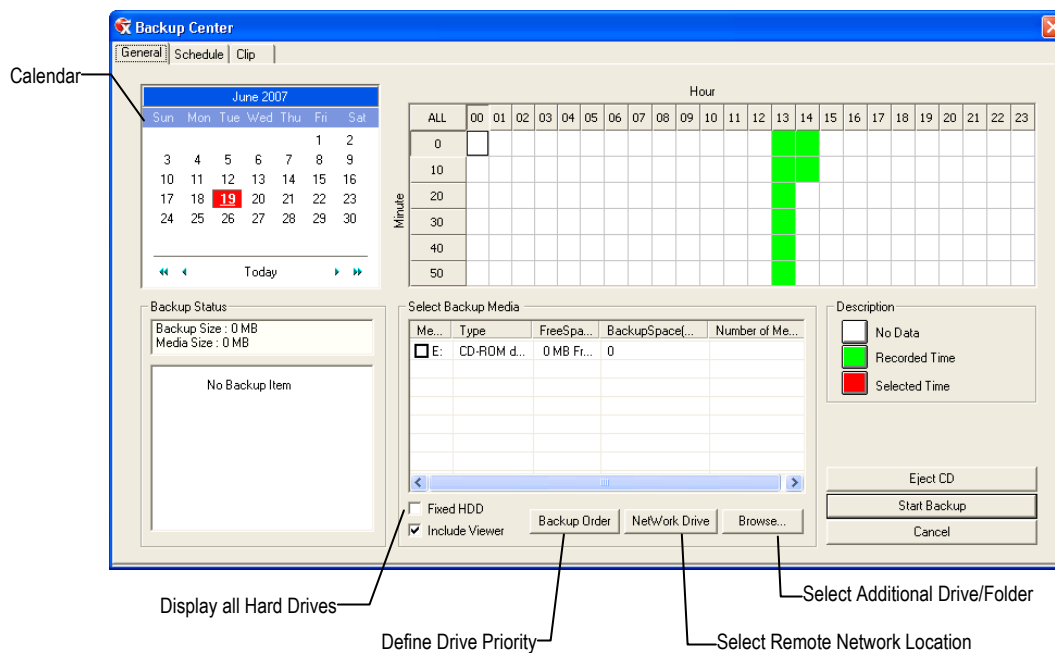

- Hour / Minutes** Recording data displays in hourly (24 horizontal columns) and 10 minute (6 vertical cells) segments. Green cells indicate time with recorded video. Red cells indicate time selected for backup.
- Backup Status** Displays the size of all video currently selected for backup, the available size of the media currently selected for backup to, and the dates and times of video currently selected for backup.

Performing a General Backup

1. Click the Backup button on the Main Display Screen.
2. Select the date or dates to back up video from using the calendar. Dates highlighted in blue contain recorded data.
3. Select the blocks of time to back up using the Hour/Minute Menu. Blocks of time with recorded video are highlighted in green. Blocks of time selected for backup are highlighted in red.
4. Select the drive or drives to save the backup video to using the Select Backup Media Menu, Network Drive button, or Browse button. When selecting the DVD±RW Drive you must specify the number of CD/DVDs to use for backup.
5. Set the backup order using the Backup Order button.
6. Select the Include Viewer check box to include the Backup Viewer Application.
7. Click the Start Backup button to begin the backup process. A progress bar will be displayed in the lower right corner of the main screen.

Clip Backup Screen

The Clip Screen is used for backing up video recorded by individual cameras for a selected period of time to a specified storage location

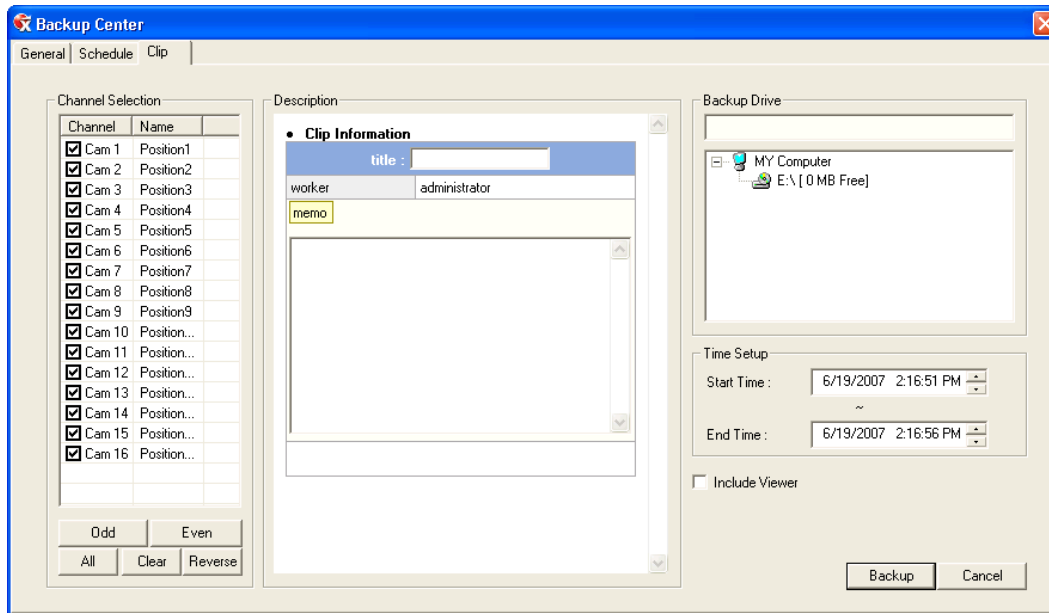

Performing a Clip Backup

1. Click the Backup button on the Main Display Screen.
2. Click the Clip Backup Tab at the top of the Backup Center Screen.
3. Set the Backup Time and End Time of the video to backup in the Time Setup Box.
4. Select the Cameras to back up in the Channel Selection Box.
5. Select the Backup Drive to save the backup video to.
6. Check the Include Viewer check box to include the Backup Viewer Application.
7. Enter pertinent clip information into the Clip Information section in the Description Box.
8. Click the Start Backup button to begin the backup process. A progress bar will be displayed in the lower right corner of the main screen.

Scheduled Backup Screen

The Scheduled Screen is used for backing up video recorded by all cameras at a regular interval.

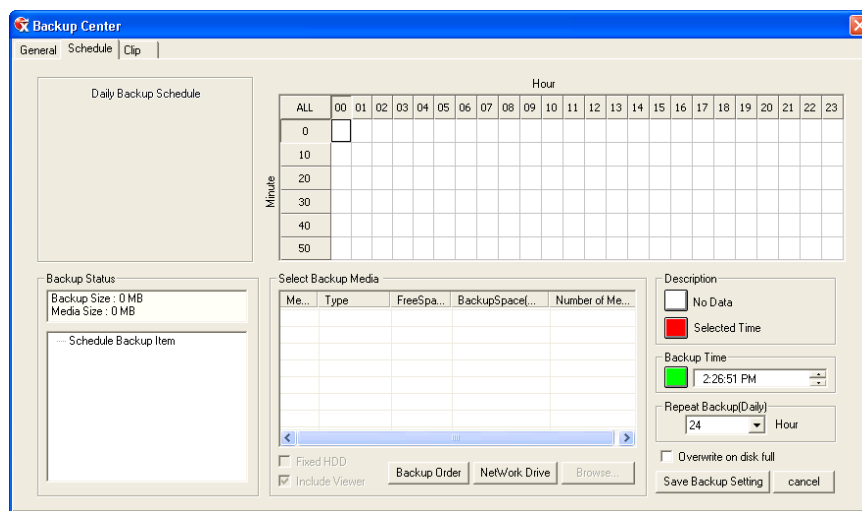

Performing a Scheduled Backup

1. Click the Backup button on the Main Display Screen.
2. Click the Schedule Tab at the top of the Backup Center Screen.
3. Set the Backup Time to perform the backup.
4. Set the Repeat Backup Time to specify the number of hours between backup procedures (between 1 and 24 hours).
5. Select the Backup Drive to save the backup video to using the Select Backup Media Menu or the Network Drive button. To save to a local drive or partition you must first rename the location "Backup"
6. Check the Overwrite on Disk Full checkbox to overwrite previous scheduled backups when the disk becomes full.
7. Click the Save Backup Setting button to save the current backup setting and return to the Main Display Screen.

Specifying Scheduled Backup Drives

In order to use the Scheduled Backup feature, one or more storage drives or partitions connected to the DVR must be labeled as a backup drive.

1. Exit and restart in Windows mode.
2. Double-click the My Computer icon on the DVRs desktop. A file menu will be displayed.
3. Right-click the drive to specify as a backup drive for Scheduled Backup and select the Rename option. Rename the drive 'Backup'. Repeat this process for all drives to use for Scheduled Backup. To remove a drive from use for Scheduled Backup, change its name to something besides 'Backup'.
4. Restart the application and return to the Schedule Tab in the Backup Center window.

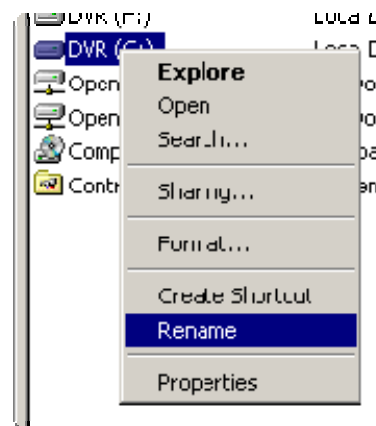

NOTES:

LAN / ISDN / PSTN CONNECTIONS

This chapter includes the following information:

- Overview
- Configuring TCP/IP Settings
- Connecting to a LAN

LAN OVERVIEW

The DVR can easily be connected to a Local Area Network (LAN) and uses Microsoft's® powerful and secure Windows® XP Embedded operating system. This allows for easy and well-documented instructions on setting up LAN connections no matter what type of LAN you want to use.

A LAN is a group of computers and other devices dispersed over a relatively limited area and connected by a communications link that allows one device to interact with any other on the network.

Examples of LAN connections include Ethernet, Token Ring, cable modems, DSL, FDDI, IP over ATM, IrDA (Infrared), wireless, and ATM-emulated LANs. Emulated LANs are based on virtual adapter drivers such as the LAN Emulation Protocol.

There are many reasons why using Microsoft® Windows® XP Embedded is superior to other platforms when running on a LAN. The number one reason is security. Windows XP Embedded is based on NT technology, which, historically has boasted the most reliable and secure Operating System in the world. Running the DVR on a secure network is important to prevent unwanted users from gaining access to confidential information. Unwanted users can compromise the integrity of the confidential data being stored and viewed, and in extreme circumstances can cause irreparable damage to the network.

Since connecting the DVR to a network can be extremely complex (depending on the network), this Surveillix DVR manual will cover only the basics. It is suggested that the administrator consult a Vendor or IT Administrator before attempting to create or connect to a LAN.

CONNECTING TO A LAN USING TCP/IP

The networking options of the DVR can create and edit all Network settings available on Windows XP Embedded. The DVR comes equipped with a 10/100 Network Interface Card (NIC). This card uses a standard RJ-45 connector.

The DVR comes configured in DHCP Mode. The DVR will automatically receive an IP address if your Network assigns DHCP. To configure a static IP address, refer to the instructions below.

Configuring TCP/IP Settings

1. Exit and restart in Windows mode.
2. Right-click the My Network Places icon located on the desktop and select Properties. The Network Connections window opens.
3. Right-click Local Area Connections and select Properties. The Local Area Connection Properties window opens.
4. Select the Internet Protocol (TCP/IP) by clicking on it once. Once it is highlighted, select the Properties button. The Internet Protocol (TCP/IP) Properties window opens.
5. Select Use the Following IP Address option. Enter the IP Address and Subnet mask appropriate for the network. It is recommended to contact the Network Administrator for appropriate IP settings.

Example:

- a. Common IP addresses are 10.0.0.25
- b. Common Subnet masks are 255.255.255.0

NOTE: In order to connect to the DVR through a remote LAN connection, a static IP address must be assigned. If the network assigns the IP address automatically (DHCP), contact the Network Administrator for help assigning a static IP address.

6. If the network requires you to specify the DNS information, enter it now by selecting the appropriate DNS options.
7. When finished configuring the TCP/IP settings close the Internet Protocol (TCP/IP) Properties window by clicking the OK button.
8. Close the Local Area Connection Properties window by clicking the OK button.
9. It may be required to restart Windows for the changes to take effect. Start > Shutdown > Restart.

EVENT SENTRY

This chapter includes the following information:

- Overview
- Setup Event Sentry

OVERVIEW

Event Sentry is designed to allow the user to monitor drive status in DVRs utilizing an internal RAID 5 array. This utility allows users to be notified via email in the event of a drive failure.

SETUP EVENT SENTRY

1. Double-click the Event Sentry Management icon on the desktop to launch the software.
2. The Setup Wizard will display the first time to explain features of the software. Read the displayed tips.
3. Click Next on each window; on the last window click Finish.
4. Select No More Tips Please! In the Tips and Tricks window
5. Click Close.
6. The main page of the Event Sentry Management console will display

Add Email Notification Filters

1. Find and expand Email Notification in the Left Panel. My Computer > Packages > Filter Packages > Email Notification
2. Right-click Email Critical Events and select Delete
3. Click Yes to confirm
4. Right-click Email Notification and select Add Filter
5. Name the filter IAANTmon:7
6. Click the IAANTmon:7 filter in the left panel. The filter options will display in the right panel.
7. Select IAANTmon from the Event Source List
8. Type 7 in the Event ID box

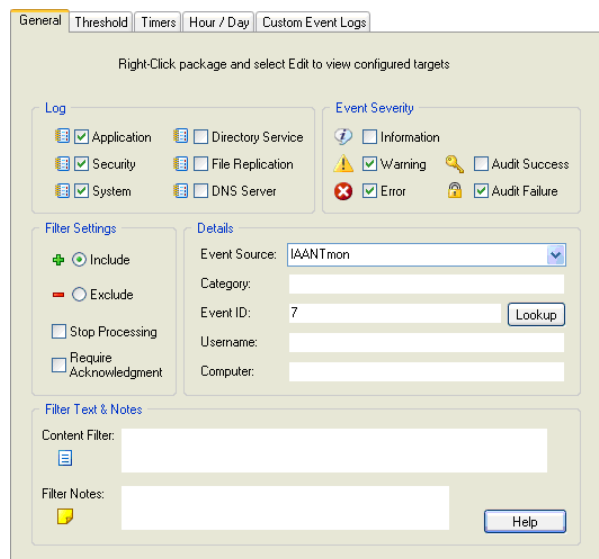
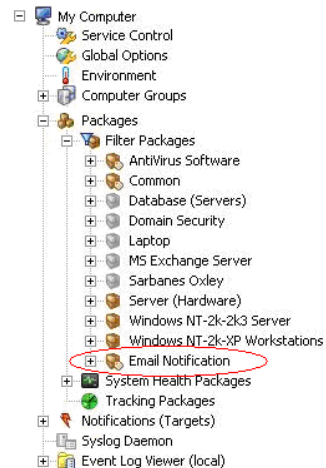

- Repeat the steps above to add two more filters:
IAANTmon:4 and IAANTmon:3

NOTE: The properties for each filter will remain the same except the Event ID box, which corresponds to the filter name.

- After all three filters are added save the settings. File > Save
- Exit the Event Sentry Management Software. File > Exit
- Double-click the Surveillix DVR icon on the desktop to restart the DVR software.
- The Event Sentry will run in the background and monitor the RAID array.

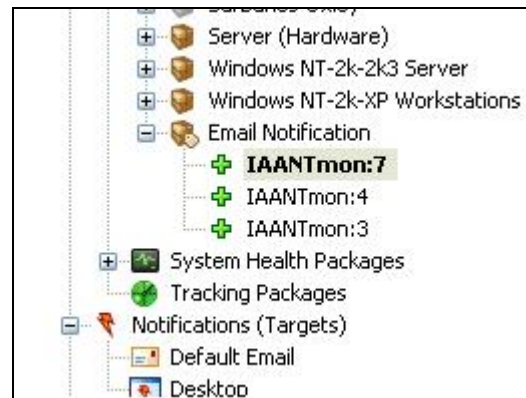

NOTES:

WEB VIEWER

This chapter includes the following information:

- Overview
- Configuring the Web Viewer

WEB VIEWER OVERVIEW

The DVR allows you to access video using Microsoft® Internet Explorer® 7.

Highlights:

View Live Video from most computers

Username and Password protected

Easy to use graphical interface

Basics:

75 users can access the Web DVR simultaneously. The Web Viewer is an easy, secure way to view live video from virtually any computer with an internet connection using Microsoft Internet Explorer.

In order to log in to the DVR server, a user account must be made for the user. This ensures that only authorized personnel are allowed to log in. In addition, each user can be assigned different privileges that allow them or deny them access to different functions. For example, a user can be granted access to only view cameras 4, 8 and 16.

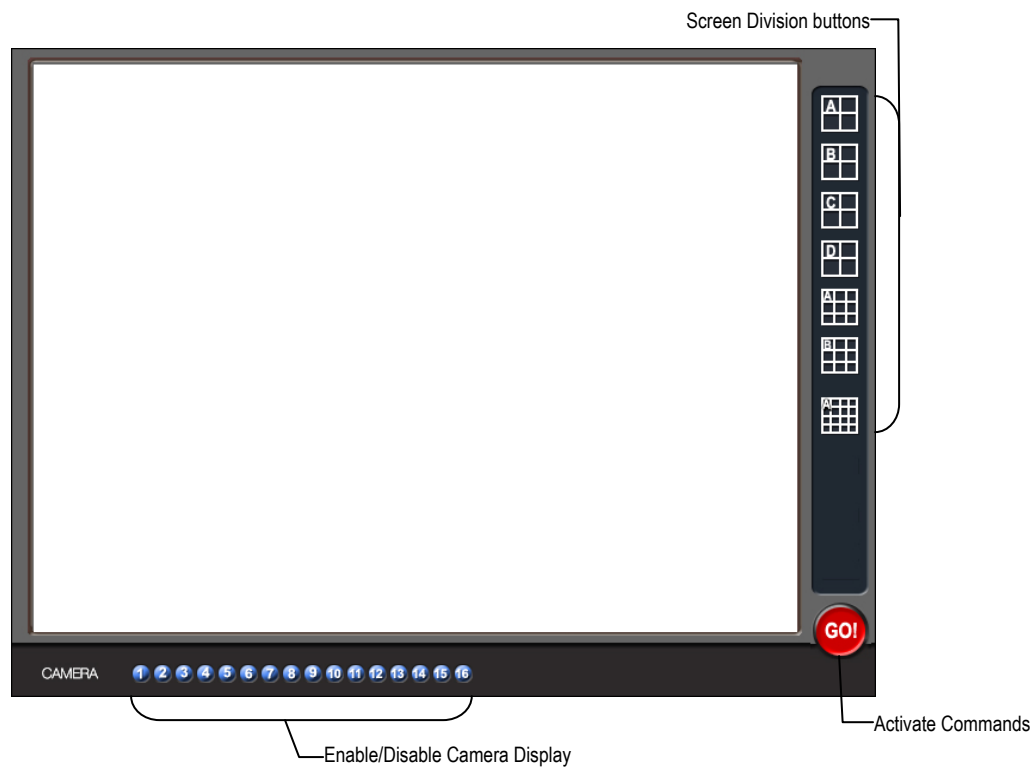

Configuring the Server for Remote Connection

1. Enter Setup on the DVR.
2. Click the Network Setup button.
3. Clear the Disable Remote Control option. You should now be allowed to adjust port settings if necessary.

NOTE: If you are using a Firewall, it may be necessary to adjust the port settings on both the DVR and the Firewall. Contact the Network Administrator for more information.

4. Select the Web Viewer (iDVR) check box.
5. Click Apply.
6. Make sure a User account is created. Without a user account, the Administrator account must be used.
7. The DVR server is now ready to receive incoming connections.

Connecting to a DVR Using Web Viewer

1. Open Microsoft Internet Explorer.
2. Enter the IP address of the DVR into the Address Bar.
3. When attempting this for the first time on a Computer a window will open and you will be asked to accept an Active X installation. Select Yes to this.

NOTE: If you receive a message saying Internet Explorer® security settings do not allow you to download Active X components then you will need to adjust the browser security settings. One way to do this is to add the IP address of the DVR to the trusted sites list inside Internet Explorer® settings. Contact the System administrator for additional help with adjusting Internet Explorer® settings.

4. When the Web Viewer finishes loading, select one or more cameras (or select a screen division button).
5. Click GO!
6. A login window will appear. Enter the Username and Password of an authorized user.
7. The cameras will display.

Closing the Web Viewer

To exit the Web Viewer close Internet Explorer.

NOTES:

INCLUDED SOFTWARE SETUP

This chapter includes the following information:

- Emergency Agent Overview
- Remote Software Overview
- Digital Verifier
- Backup Viewer
- SCS Multi Site Software Overview

EMERGENCY AGENT OVERVIEW

The Emergency Agent software is a utility that streams video across a Local Area Network to a Client PC when an alarm is detected on the DVR. The video that streams across can be stopped, played forwards and backwards, in slow motion or real speed.

The utility is loaded at startup and placed in the taskbar. It constantly monitors for a signal from the DVR. When an alarm signal is detected the Emergency Agent Image Viewer window opens and starts playing the video from the camera associated to the alarm.

CAUTION: SCS and Emergency Agent are not compatible to run on the same PC. If you have SCS installed you do not need Emergency Agent. SCS will perform the same alarm notification as Emergency Agent.

Configuring the DVR

To enable the Emergency Agent on the DVR follow these steps:

1. Enter Setup and confirm you are in the Camera Setup Menu.
2. Select a camera and then associate sensor(s) to that camera using the Sensor Connection Boxes.
3. Click the Network Setup button and make sure that Disable Remote Control is not checked.

NOTE: The Emergency Agent uses one port to transfer the data through (the Emergency Port). The port can be adjusted inside the Network Setting Menu if necessary. It is recommended that the default setting should be used unless the port must be changed.

4. Click the Schedule Setup button.
5. Select the Sensor option to open the sensor schedule window.
6. Enter the IP Address of the computer running the Emergency agent software.
7. Click the box next to the IP Address to enable it.
8. Create a schedule for the appropriate sensor.
9. Highlight the sensor schedule blocks and click the [E] Emergency Agent button.

Emergency IP:	IP	Use	IP
	IP 1	<input type="checkbox"/>	0.0.0.0

NOTE: The DVR will not send alarm events to the Client PC if the sensor schedule does not have the Emergency Agent Alarm Option enabled.

10. Click Apply.

Configuring the Client PC

All configurations takes place in the Emergency Agent window on the Client PC. For descriptions and locations of the buttons and features of the Emergency Agent window refer to the Emergency Agent window section later in this chapter.

1. Open the Emergency Agent window on the Client PC - Start >All Programs > Surveillix > Emergency Agent > Emergency Agent
2. Right-click in the DVR List and select New. Enter the DVR Code, DVR Name, and IP Address of the DVR to connect to in the Site Edit window that opens. Click OK
3. From the Options menu, click Setup.
4. Confirm that the Network Port in the Setup window is set to the same number as the Emergency Port in Network Settings on the DVR. If the numbers are different adjust the Network Port on the client PC to match the DVR.
5. Click OK.
6. Restart the Client PC.

DVR identification	
DVR Code	<input type="text"/>
DVR Name	<input type="text"/>
IP Address	<input type="text"/>
<input type="button" value="OK"/> <input type="button" value="Cancel"/>	

Emergency Agent Window

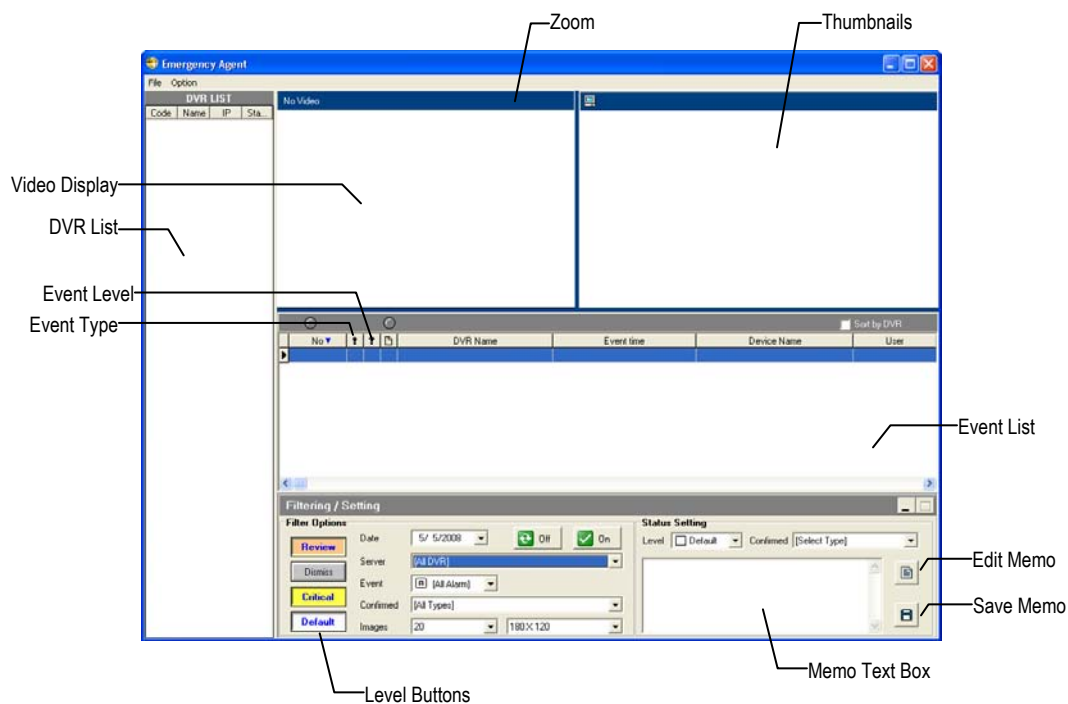

Setup Window

Network Port

Indicates the port which the Emergency Agent uses to listen for incoming events. This number should be changed to the same number as is set in the Emergency Port in Network Settings on the DVR.

Save Directory

Sets the location that recorded video footage is saved to.

Notice Options

Configuration settings for activating an audible indicator or popup window when the Emergency Agent receives an event.

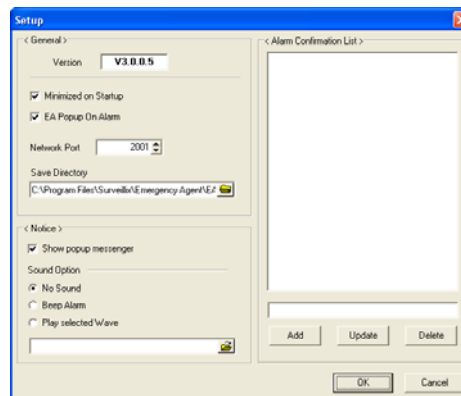

Alarm Confirmation List

Filter Event List

1. Select a DVR from the DVR List in the Filter Options section.
2. Select the Date to include.
3. Select the type of Event(s) to include.
4. Select the event levels (Review, Dismiss, Critical, Default).
5. Click the On button to display filtered event listings.

Add Items to Alarm Confirm List

1. From the Option menu, click Setup.
2. Type the desired text in the box below the Alarm Confirmation List.

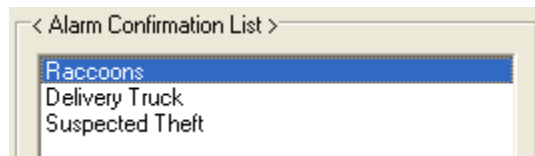

NOTE: The items in the Alarm Confirmation List will be available on a list under Status Setting in main Emergency Agent screen.

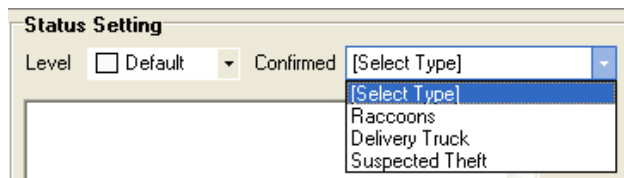

3. Click Add.
4. Click OK to save changes and close the window.

Search Alarm Window

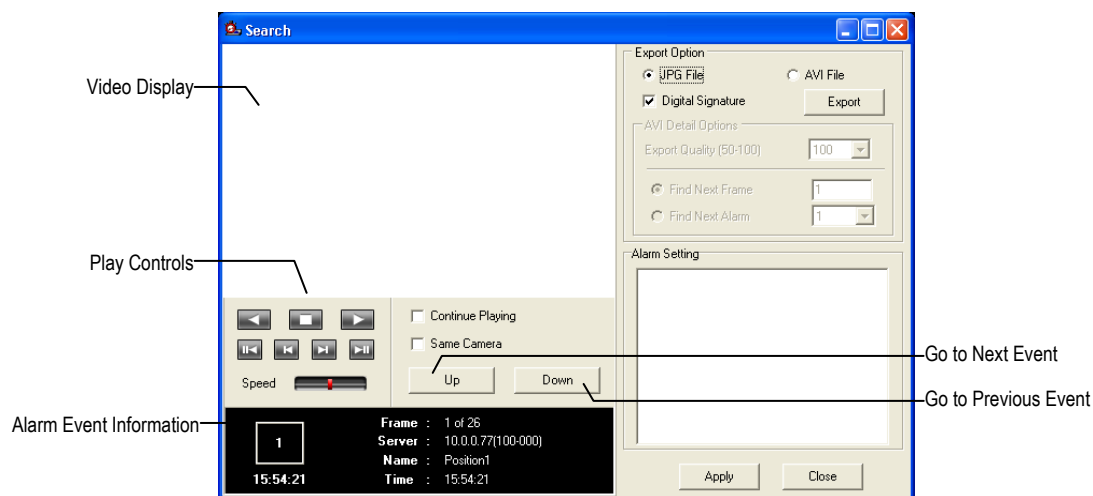

Export Quality

It may be necessary to reduce the overall size of an .AVI file; for example, to email to someone. .AVI file sizes can be reduced by reducing the image quality. However, reducing the image quality causes the .AVI video to appear more pixilated. When size is not an issue, setting quality to 100 is highly recommended.

Digital Signature

Adds a digital signature to the exported .JPG image for use with the Digital Signature Verifier to verify integrity of exported images and prevent tampering.

View Recorded Video

1. Double-click an event listing to open the Search Alarm window.
2. Use the play controls to locate the desired video.
3. Select the Continue Playing Box to watch all recorded events. When not selected, playback stops at the end of the alarm event.
4. Select the Same Camera Box to watch all events recorded by a single camera.
5. Click the Apply button after making any changes.

Export Video

1. Double-click an event listing to open the Search Alarm window.
2. Use the play controls to locate the desired video.
3. Click the Rewind button to return to the beginning or desired spot in the video.
4. Click the Stop button.
5. Select the Export Type – JPG or AVI.

Save JPG:

- a. Select the Digital Signature Box to embed a digital signature in a JPG file.
- b. Click the Export button.

Save AVI

- a. Reduce Export Quality only if necessary to reduce the size of the file.
- b. Click the Export button.

REMOTE SOFTWARE OVERVIEW

The DVR was specifically designed to be fully operated and maintained remotely. It connects using the standard TCP/IP protocol through connection types such as DSL, Cable Mode, T1, ISDN, 56K Modem, LAN, and more. The Surveillix Remote software allows you to view live video, search through archived video, export images and video clips and have virtually full Setup control.

Highlights:

Search archived video

View live video

Export images and video clips

Control relay outputs

Setup administration

Basics:

The DVR can have up to 5 simultaneous remote connections. Each user can perform functions on the DVR and will not affect the other users. The only exceptions to this are accessing Setup and controlling a PTZ camera. Only one user is allowed to access setup or control a PTZ camera at any given time. The pictures per second passed to the Remote Client vary greatly depending on the connection type and speed.

In order to log in to the DVR server, a user account must be made for the user. This ensures that only authorized personnel are allowed to log in. In addition, each user can be assigned different privileges that allow them or deny them access to different functions. For example, a user can be denied Searching and Setup privileges and only granted access to view cameras 4, 8 and 16.



It is highly recommended that users not be granted Setup privileges since this can pose a security risk. Only properly authorized Administrators should have access to Setup.

The Remote software operates virtually the same way as the DVR itself. The appearance of it matches the DVR almost identically; however, there are a few minor differences. Some search features are not available (such as the Index and Object Searches) as well as some Setup options.

Remote Client Minimum Requirements

Intel® Pentium® IV 1.4 Ghz or equivalent
512MB System Memory
DirectX 9 or higher
32 MB Video Card
Internet or LAN Connection (56K, DSL, Cable Modem, T1, ISDN, etc.)
TCP/IP installed
Microsoft® Windows® 2000 or XP Operating System
1024 x 768 display resolution
16 Bit color depth or better

Remote Client Recommended Requirements

Intel® Pentium® IV 2.4+ or equivalent
512MB System Memory
DirectX 9 or higher
Compatible video card (ATI Preferable)
Internet or LAN Connection (DSL, Cable Modem, T1, ISDN, etc.)
TCP/IP installed
Microsoft® Windows® 2000 or XP Operating System
1024 x 768 display resolution
32 Bit color depth or better

Remote Software Setup

Installing Remote Software

1. On the client computer, insert the Surveillix Software CD into the CD-ROM. The CD should play automatically.
2. When prompted, select the Install Remote Software option. Follow the installation instructions carefully.
3. When the software finishes installing, close any open installation windows.

Create a New Remote Connection

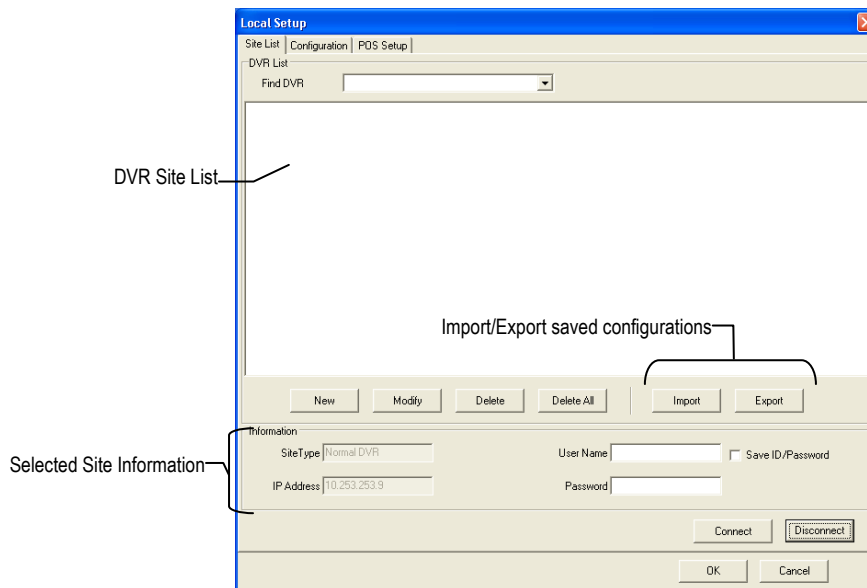

1. Select Start > Programs > Surveillix > Remote > Surveillix Remote Center. The Surveillix Remote Software opens and the Local Connection window opens.
2. Click New to open the Site Info window.
3. Select the Site Type and enter a Site Name. The Site Name will be the name displayed inside the connection box to help identify the server.
4. Enter the IP Address of the DVR server. By default the DVR is set to connect using DHCP.
5. Enter the Center Port. This setting is specified on the server.
6. Click OK.
7. Click the newly created connection and enter the login username and password. (case sensitive)
8. Click Connect.

Configuring the DVR

In order to access the DVR remotely, the DVR Server must be setup to allow remote connections.

Time Out Value	Specifies a value (in seconds) to wait for a signal from the Surveillix Remote Client. If a signal is not received by that time, the connection is dropped.
Center Port	Used to transfer the connection data.
Image Port	Used to transfer the image data.
Search Port	Used to transfer the search data.

The screenshot shows a configuration window with the following settings:

- Disable Remote Control
- Transport Setup**
 - Quality: NORMAL
 - Resolution: 360*240
- Network Setup**
 - TimeOut Value: 60
 - Emergency Port: 2001 (1024 - 5000)
 - Center Port: 2000 (1024 - 5000)
 - Image Port: 2002 (1024 - 5000)
 - Search Port: 2003 (1024 - 5000)

Configuring the Server for Remote Connection

1. Enter Setup on the DVR.
2. Click the Network Setup button to open the Network Menu.
3. Clear the Disable Remote Control option. You should now be allowed to adjust port settings if necessary.

NOTE: If you are using a Firewall, it may be necessary to adjust the port settings on both the DVR and the Firewall. Contact the Network Administrator for more information.

4. Click OK.
5. Make sure a User account is created. Without a user account, the Administrator account must be used.
6. The DVR server is now ready to receive incoming connections.

Access Remote Connection

1. Open the Remote Software.
2. Click the icon of the server as defined previously.
3. Enter the user name and password of an authorized remote user as defined in Network > Client Setup > User Account on the E-Series system.

NOTE: User Name and Password are both case sensitive.

4. Click the Connect button.

DIGITAL VERIFIER OVERVIEW

.JPG images and .AVI video files that are exported from the Digital Video Recorder are automatically embedded with a digital signature. Digital Signatures are a way to verify the authenticity of the images to ensure that they have not been tampered with or edited in any way. Included on the Software Installation DVD supplied with the DVR is the Digital Signature Verification program. This program can be installed on any computer and loads an image in question.

Installing the Digital Verifier

1. Insert the Software Installation CD into the CD-ROM. (Do not install on the DVR.)
2. Select the Digital Verifier option to begin installation. When the Welcome screen appears, click Next.
3. When the Setup Complete window appears click Finish. Installation is complete.

Using the Digital Verifier

1. Open the Digital Verification program by selecting Start > Programs > Surveillix > Digital Verifier > Digital Signature Verifier.
2. Click the Browse button to load the .JPG image.
3. Enter the Site Code of the DVR that the image was originally extracted from. (The Site Code is specified in the Site Information Setup Menu)
4. Click the Verify button to continue or Close to close the window without verifying.

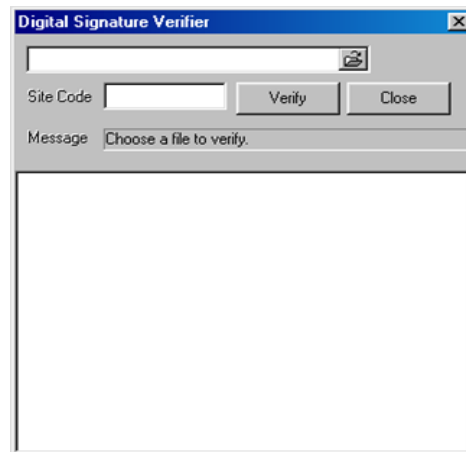

If the image has not been tampered with, a blue square will appear around the image with the message "Original image file."

If the image has been tampered with, a red square will appear around the image with the message "Entire image changed or wrong SITE CODE."

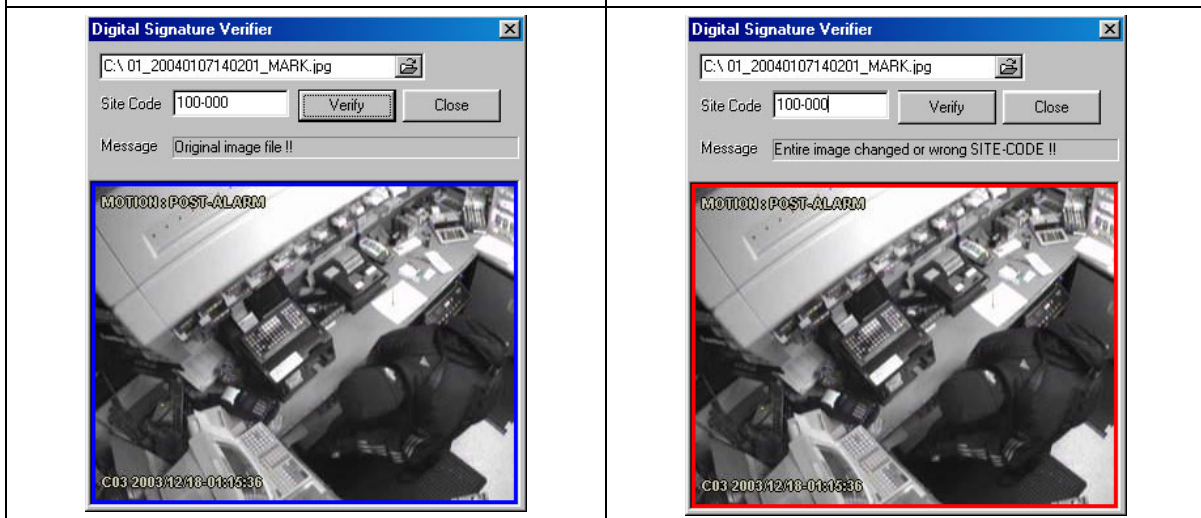

BACKUP VIEWER OVERVIEW

The Backup Viewer allows you to play back the exported video in its proprietary format. Video saved in this format is extremely difficult to tamper with and therefore is the ideal solution when law enforcement and the legal department are involved.

This video cannot be read by any other viewer.

The Backup Viewer operates essentially like the Search portion of the DVR software.

For detailed explanations of these functions, refer to the chapter on Search Options in this manual.

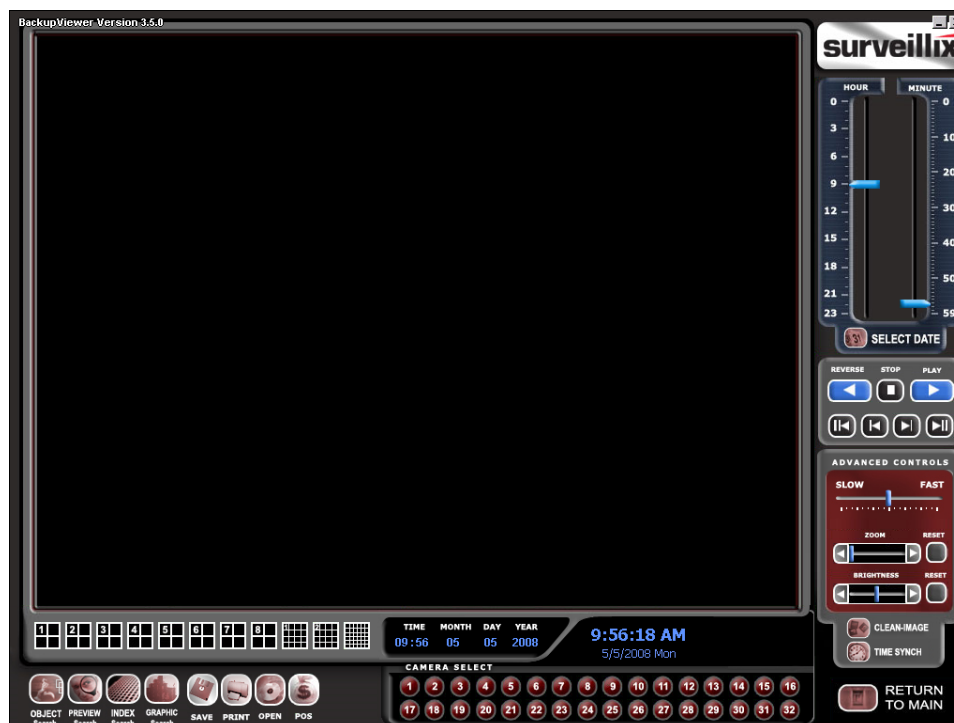

Installing Backup Viewer

1. Insert the Software Installation DVD into the DVD-ROM.
(Do not install on the DVR.)
2. Select the Backup Viewer option to begin installation.
When the Welcome screen opens, click Next.
3. Read the License Agreement and select the appropriate radio button to accept the terms of the license agreement.
Click Next.
4. Select Yes to install the POS component or Select No for a basic install.
Click Next.

NOTE: The POS component is only necessary when connecting to a server running the POS Upgrade.

5. When the Choose Destination Location window opens click Next.
This will install Backup Viewer in the default destination folder.
6. Select the shortcuts to install, or clear all boxes for no shortcuts.
Click Next.
7. When the InstallShield Wizard Complete window appears click Finish.
Setup is now complete.

Loading Video from DVD or Hard Drive

1. Open the Backup Viewer program: Start > Programs > Surveillix > Backup Viewer > Backup Viewer.
2. Click the Open button. The Total Backup Search window will open.
3. For Clip backup files, expand Clip and select the desired drive.

For Backup files, expand Backup and select the desired drive.

4. Click the desired backup file or clip.
5. Click OK.
The video will load into the Backup Viewer.

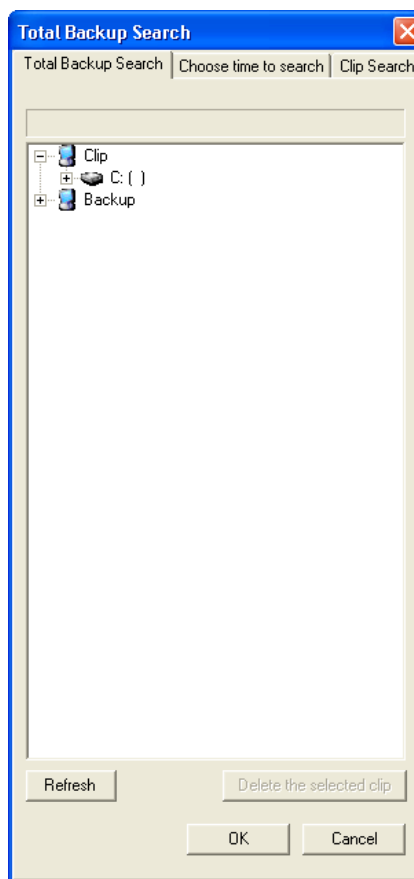

SCS OVERVIEW

SCS software is Network DVR Management Software; a powerful utility that allows 100 or more DVR units to be controlled using one computer. This software allows you to view live video, search saved video, edit and configure setup on each DVR, and import maps of buildings and other locations.

The SCS software was specifically designed as an enterprise software solution.

CAUTION: SCS and Emergency Agent are not compatible to run on the same PC. If you have Emergency Agent installed on this PC, you must uninstall it before installing SCS. SCS will perform the same alarm notification as Emergency Agent.

Highlights:

View Live Video from most computers

Username and Password protected

Easy to use graphical interface

Basics:

In order to log in to the DVR server, a user account must be made for each user. This ensures that only authorized personnel are allowed to log in. In addition, each user can be assigned different privileges that allow them or deny them access to different functions.

Configuring the Server for Remote Connection

1. Enter Setup on the DVR.
2. Click the Network Setup button.
3. Clear the Disable Remote Control option. You should now be allowed to adjust port settings if necessary.

NOTE: If you are using a Firewall, it may be necessary to adjust the port settings on both the DVR and the Firewall. Contact the Network Administrator for more information.

4. Click OK.
5. Make sure a User account is created. Without a user account, the Administrator account must be used.
6. The DVR server is now ready to receive incoming connections.

Connecting to an DVR

Refer to the Setup section of the SCS Manual for information on using the SCS Software. The SCS Manual can be found on the Software CD.

NOTES:

APPENDIX: SPECIFICATIONS

DVR SPECIFICATIONS

		8	16
CPU		Intel® Celeron 3.2+ GHz CPU	
Storage (Hard Drive)		250 GB Standard / Virtually Unlimited Storage Potential	
Storage MAX		Up to 4 HDD with DVD±RW	
Operating System		Microsoft® Windows® XP Embedded	
Viewing Rate	NTSC	Max 480 FPS	
	PAL	Max 480 FPS	
Recording Rate	NTSC	60 PPS – Max 60 PPS / 120 PPS – Max 120 PPS / 240 PPS – Max 240 FPS / 480 PPS – Max 480 PPS	
	PAL	60 PPS – Max 50 PPS / 120 PPS – Max 100 PPS / 240 PPS – Max 200 FPS / 480 PPS – Max 400 PPS	
Digital Control Output		8	16
Sensor Input		8	16
Resolution (60 PPS, 120 PPS)	NTSC	640x480 / 640x240 / 320x240	
	PAL	640x576 / 640x288 / 320x288	
Resolution (240 PPS, 480 PPS)	NTSC	720x480 / 720x240 / 360x240	
	PAL	720x576 / 720x288 / 360x288	
Image Compression		MJPEG	
Average File Size		360x240 – 3~5k	
		720x240 – 4~8k	
		720x480 – 7~12k	
Video Inputs		8CH (BNC)	16CH (BNC)
Looping Outputs		8CH (BNC) – Each can be terminated (75Ω)	16CH (BNC) – Each can be terminated (75Ω)
Composite Outputs		RCA	
Video Outputs		SVGA	
Max PPS Per Channel		30 Pictures Per Second (PPS) – NTSC / 25 Pictures Per Second (PPS) - PAL	
Motion Detection		Up to 5 Regions Per Channel / Adjustable Sensitivity	
Remote Operation		Full Remote Control Through PSTN, ISDN, ADSL, LAN, and TCP/IP	
Remote Software		Compatible with Microsoft Windows 2000,XP	
PAN / TILT / ZOOM		Built In RS-422/RS-485 Interface	
Recording Mode		Continuous, Motion Detection, Sensor, Scheduled Recording	
Backup		USB, DVD±RW	
Digital Signature		Supports Digital Signature Verification	
Emergency Agent		Transmitted through TCP/IP – SCS	

NOTES:

EVR SPECIFICATIONS

		8	16	32
CPU		Intel® 3.2+ GHz CPU		
Storage (Hard Drive)		250 GB Standard / Virtually Unlimited Storage Potential		
Storage MAX		Up to 8 HDD with DVD±RW		
Operating System		Microsoft® Windows® XP Embedded		
Viewing Rate	NTSC	Max 480 FPS		
	PAL	Max 480 FPS		
Recording Rate	NTSC	120 PPS – Max 120 PPS / 240 PPS – Max 240 FPS / 480 PPS – Max 480 PPS		
	PAL	120 PPS – Max 100 PPS / 240 PPS – Max 200 FPS / 480 PPS – Max 400 PPS		
Digital Control Output		8	16	16
Sensor Input		8	16	16
Resolution	NTSC	720x480 / 720x240 / 360x240		
	PAL	720x576 / 720x288 / 360x288		
Image Compression		MJPEG		
Average File Size		360x240 – 3~5k		
		720x240 – 4~8k		
		720x480 – 7~12k		
Video Inputs		8 CH (BNC)	16 CH (BNC)	32 CH (BNC)
Looping Outputs		8 CH (BNC)	16 CH (BNC)	32 CH (BNC)
Composite Outputs		RCA		
Video Outputs		S-Video, SVGA		
Max PPS Per Channel		30 Pictures Per Second (PPS) – NTSC / 25 Pictures Per Second (PPS) - PAL		
Motion Detection		Up to 5 Regions Per Channel / Adjustable Sensitivity		
Remote Operation		Full Remote Control Through PSTN, ISDN, ADSL, LAN, and TCP/IP		
Remote Software		Compatible with Microsoft Windows 2000,XP		
PAN / TILT / ZOOM		Built In RS-485 Interface		
Recording Mode		Continuous, Motion Detection, Sensor, Scheduled Recording		
Backup		USB, DVD±RW		
Digital Signature		Supports Digital Signature Verification		
Emergency Agent		Transmitted through TCP/IP – SCS		

NOTES:

HVR SPECIFICATIONS

		8	16	32
CPU		Intel® Dual Core 3.4Ghz CPU		
Storage (Hard Drive)		250 GB Standard / Virtually Unlimited Storage Potential		
Storage MAX		Up to 8 HDD with DVD±RW		
Operating System		Microsoft® Windows® XP Embedded		
Viewing Rate	NTSC	Max 480 FPS		
	PAL	Max 480 FPS		
Recording Rate	NTSC	x240 – Max 240 PPS / x480 – Max 480 PPS		
	PAL	x240 – Max 200 PPS / x480 – Max 400 PPS		
	IP cameras	Dependant on Network Video Device Encoding Rate		
Digital Control Output		8	16	16
Sensor Input		8	16	16
Resolution	NTSC	720x480 / 720x240 / 360x240		
	PAL	720x576 / 720x288 / 360x288		
	IP cameras	Recording resolutions dependant upon the resolutions the Network Camera supports		
Image Compression		MJPEG		
Average File Size	360x240 – 3~5k			
	720x240 – 4~8k			
	720x480 – 7~12k			
Video Inputs		8 CH (BNC)	16 CH (BNC)	32 CH (BNC)
Looping Outputs		8 CH (BNC)	16 CH (BNC)	32 CH (BNC)
Composite Outputs		RCA		
Video Outputs		S-Video, SVGA		
Max PPS Per Channel		30 Pictures Per Second (PPS) – NTSC / 25 Pictures Per Second (PPS) - PAL		
Motion Detection		Up to 5 Regions Per Channel / Adjustable Sensitivity		
Remote Operation		Full Remote Control Through PSTN, ISDN, ADSL, LAN, and TCP/IP		
Remote Software		Compatible with Microsoft Windows 2000,XP		
PAN / TILT / ZOOM		Built In RS-485 Interface		
Recording Mode		Continuous, Motion Detection, Sensor, Scheduled Recording		
Backup		USB, DVD±RW		
Digital Signature		Supports Digital Signature Verification		
Emergency Agent		Transmitted through TCP/IP – SCS		

Free Manuals Download Website

<http://myh66.com>

<http://usermanuals.us>

<http://www.somanuals.com>

<http://www.4manuals.cc>

<http://www.manual-lib.com>

<http://www.404manual.com>

<http://www.luxmanual.com>

<http://aubethermostatmanual.com>

Golf course search by state

<http://golfingnear.com>

Email search by domain

<http://emailbydomain.com>

Auto manuals search

<http://auto.somanuals.com>

TV manuals search

<http://tv.somanuals.com>