

# surveillix

## EVR - DVR - HVR Digital Video Recorder

Hardware Manual

model no. DVR8-X  
EVR8-X  
HVR8-X  
DVR16-X  
EVR16-X  
HVR16-X  
EVR32-X  
HVR32-X

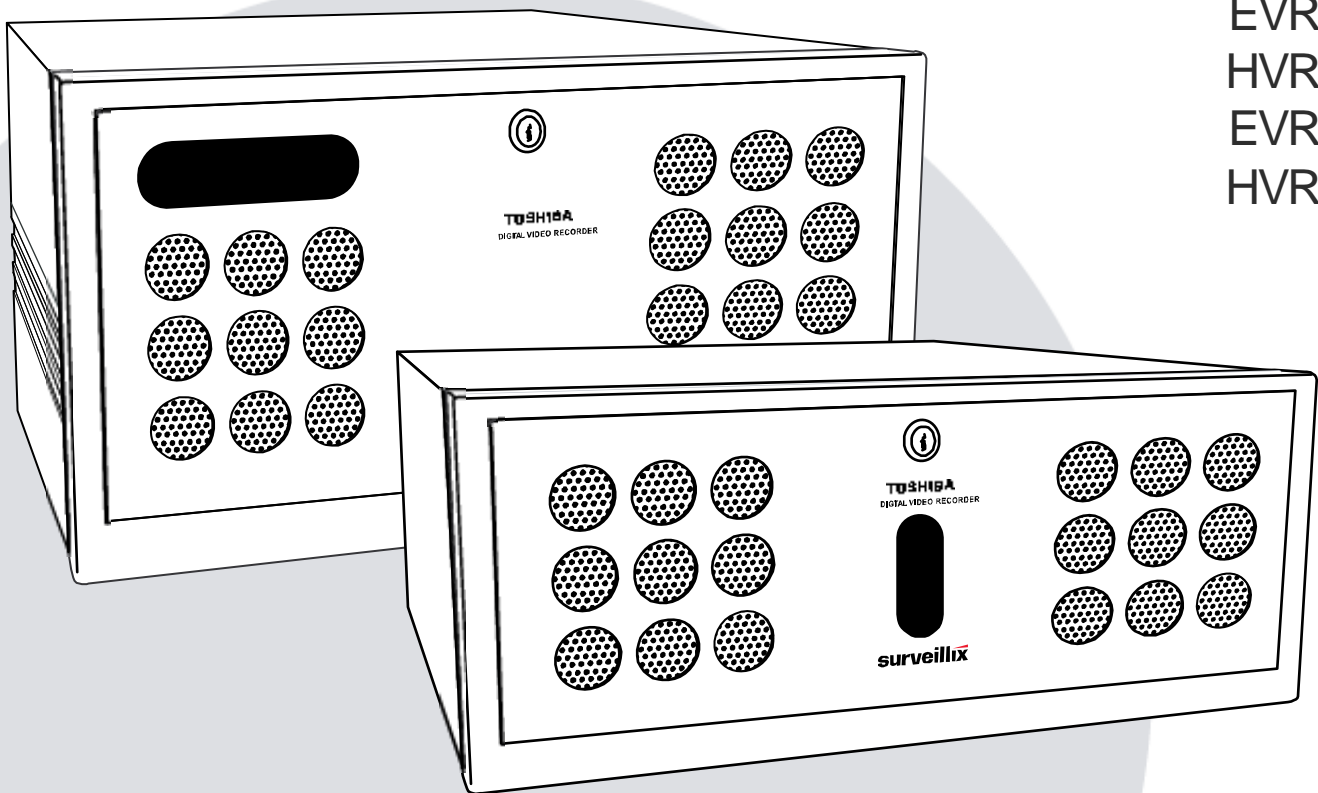

Please carefully read these instructions before using this product.  
Save this manual for future use.

**TOSHIBA**

Surveillix™ DVR/EVR/HVR  
Hardware Manual

Manual Edition 27895AD – DECEMBER 2007

Printed in USA

No part of this documentation may be reproduced in any means, electronic or mechanical, for any purpose, except as expressed in the Software License Agreement. Toshiba shall not be liable for technical or editorial errors or omissions contained herein. The information in this document is subject to change without notice.

THE INFORMATION IN THIS PUBLICATION IS PROVIDED “AS IS” WITHOUT WARRANTY OF ANY KIND. THE ENTIRE RISK ARISING OUT OF THE USE OF THIS INFORMATION REMAINS WITH RECIPIENT. IN NO EVENT SHALL TOSHIBA BE LIABLE FOR ANY DIRECT, CONSEQUENTIAL, INCIDENTAL, SPECIAL, PUNITIVE, OR OTHER DAMAGES WHATSOEVER (INCLUDING WITHOUT LIMITATION, DAMAGES FOR LOSS OF BUSINESS PROFITS, BUSINESS INTERRUPTION OR LOSS OF BUSINESS INFORMATION), EVEN IF TOSHIBA HAS BEEN ADVISED OF THE POSSIBILITY OF SUCH DAMAGES AND WHETHER IN AN ACTION OR CONTRACT OR TORT, INCLUDING NEGLIGENCE.

This software and documentation are copyrighted. All other rights, including ownership of the software, are reserved to DVR Support Center. TOSHIBA, and Surveillix are registered trademarks of TOSHIBA CORPORATION in the United States and elsewhere; Windows, and Windows XP are registered trademarks of Microsoft Corporation. All other brand and product names are trademarks or registered trademarks of the respective owners.

The following words and symbols mark special messages throughout this guide:



**WARNING:** Text set off in this manner indicates that failure to follow directions could result in bodily harm or loss of life.



**CAUTION:** Text set off in this manner indicates that failure to follow directions could result in damage to equipment or loss of information.

---

## LIMITED WARRANTY DIGITAL VIDEO RECORDER

The Imaging Systems Division of Toshiba America Information Systems, Inc. ("ISD") makes the following limited warranties. These limited warranties extend to the Original End-User ("You[r]").

### Limited Two (2) Year Warranty of Labor and Parts

The Imaging Systems Division of Toshiba America Information Systems warrants this product and parts against defects in material or workmanship for a period of two years from the date of original retail purchase by the end-user. During this period, ISD will repair or replace a defective product or part with a new or refurbished item. The user must deliver the entire product to the Surveillix DVR Repair Facility. The user is responsible for all transportation and insurance charges for the product to the DVR Repair Facility. ISD reserves the right to substitute Factory Refurbished Parts and / or Factory Refurbished Product in place of those in need of repair.

### Step-by-step Procedures – How to Obtain Warranty Service

[1] Verify operation of the unit by checking the instruction manual and web site for the latest updates at

[www.toshiba.com/taisisd](http://www.toshiba.com/taisisd)

[2] If there is a defect in material or workmanship, contact the Surveillix DVR Support Center at (877) 855-1349 [877-1-FIX] to speak to a technical support representative and schedule service.

[3] Arrange for delivery of the product to the Surveillix DVR Repair Facility. Products must be insured and securely packed, preferably in the original shipping carton. A letter explaining the defect and a copy of the bill of sale or other proof of purchase must be enclosed with a complete return street address and daytime telephone number. The Tracking Number should also be indicated on your documents. Charges for transportation and insurance must be prepaid by the end-user.

### Critical Use Disclaimer

The product is not designed for any "critical applications." "Critical applications" means life support systems, exhaust or smoke extraction applications, medical applications, commercial aviation, mass transit applications, military applications, homeland security applications, nuclear facilities or systems or any other applications where product failure could lead to injury to persons or loss of life or catastrophic property damage. Accordingly, Toshiba disclaims any and all liability arising out of the use of the product in any critical applications.

### Your Responsibilities

The above warranty is subject to the following conditions:

[1] You must retain the bill of sale or provide other proof of purchase.

[2] You must schedule service within thirty days after you discover a defective product or part.

[3] All warranty servicing of this product must be made by the Surveillix DVR Repair Facility.

[4] The warranty extends to defects in material or workmanship as limited above, and not to any products or parts that have been lost or discarded by user. The warranty does not cover damage caused by misuse, accident, improper installation, improper maintenance, or use in violation of instructions furnished by ISD. The warranty does not extend to units which have been altered or modified without authorization of ISD, or to damage to products or parts thereof which have had the serial number removed, altered defaced or rendered illegible.

**ALL WARRANTIES IMPLIED BY STATE LAW, INCLUDING THE IMPLIED WARRANTIES OF MERCHANTABILITY AND FITNESS FOR A PARTICULAR PURPOSE, ARE EXPRESSLY LIMITED TO THE DURATION OF THE LIMITED WARRANTIES SET FORTH ABOVE. Some states do not allow limitations on how long an implied warranty lasts, so the above limitation may not apply. WITH THE EXCEPTION OF ANY WARRANTIES IMPLIED BY STATE LAW AS HEREBY LIMITED, THE FOREGOING EXPRESS WARRANTY IS EXCLUSIVE AND IN LIEU OF ALL OTHER WITH RESPECT TO THE REPAIR OR REPLACEMENT OF ANY PRODUCTS OR PARTS. IN NO EVENT SHALL ISD BE LIABLE FOR CONSEQUENTIAL OR INCIDENTAL DAMAGES. Some states do not allow the exclusion or limitation of incidental or consequential damages so the above limitation may not apply.**

No person, agent, distributor, dealer, service station or company is authorized to change, modify or extend the terms of these warranties in any manner whatsoever. The time within which an action must be commenced to enforce any obligation of ISD arising under this warranty or under any statute, or law of the United States or any state thereof, is hereby limited to one year from the date you discover or should have discovered, the defect. This limitation does not apply to implied warranties arising under state law. Some states do not permit limitation of the time within which you may bring an action beyond the limits provided by state law so the above provision may not apply to user. This warranty gives the user specific legal rights, and user may also have other rights, which may vary from state to state.

TOSHIBA AMERICA INFORMATION SYSTEMS, INC.  
Imaging Systems Division

Copyright © 2007 Toshiba America Information Systems, Inc. All rights reserved.

**TOSHIBA**

---

## IMPORTANT SAFEGUARDS

---

1. **Read Owner's Manual** – After unpacking this product, read the owner's manual carefully, and follow all the operating and other instruction
2. **Power Sources** – This product should be operated only from the type of power source indicated on the label. If not sure of the type of power supply to your home or business, consult product dealer or local power company
3. **Ventilation** – Slots and openings in the cabinet are provided for ventilation and to ensure reliable operation of the product and to protect it from overheating, and these openings must not be blocked or covered. The product should not be placed in a built-in installation such as a bookcase or rack unless proper ventilation is provided or the manufacturer's instructions have been adhered to.
4. **Heat** – The product should be situated away from heat sources such as radiators, heat registers, stoves, or other products that produce heat.
5. **Water and Moisture** – Do not use this product near water. Do not exceed the humidity specifications for the product as detailed in the Appendix section in this manual
6. **Cleaning** – Unplug this product from the wall outlet before cleaning. Do not use liquid cleaners or aerosol cleaners. Use a damp cloth for cleaning.
7. **Power Cord Protection** – Power-supply cords should be routed so that they are not likely to be walked on or pinched by items placed against them, paying particular attention to cords at plugs, convenience receptacles, and the point where they exit from the product.
8. **Overloading** – Do not overload wall outlets, extension cords, or integral convenience receptacles as this can result in a risk of fire or electrical shock.
9. **Lightning** – For added protection for this product during storm, or when it is left unattended and unused for long periods, unplug it from the wall outlet. This will prevent damage to the product due to lightning and power line surges.
10. **Object and Liquid Entry Points** – Never insert foreign objects into the DVR unit, other than the media types approved by Toshiba, as they may touch dangerous voltage points or short-out parts that could result in a fire or electrical shock. Never spill liquid of any kind on the product.
11. **Accessories** – Do not place this product on an unstable cart, stand, tripod, bracket, or table. The product may fall, causing serious personal injury and serious damage to the product.
12. **Disc Tray** – Keep fingers well clear of the disc tray as it is closing. Neglecting to do so may cause serious personal injury.
13. **Burden** – Do not place a heavy object on or step on the product. The object may fall, causing serious personal injury and serious damage to the product.
14. **Disc** – Do not use a cracked, deformed, or repaired disc. These discs are easily broken and may cause serious personal injury and product malfunction.

---

## IMPORTANT SAFEGUARDS, continued

---

15. **Damage Requiring Service** – Unplug the unit from the outlet and refer servicing to qualified service personnel under the following conditions:
  - When the power-supply cord or plug is damaged.
  - If liquid has been spilled, or objects have fallen into the unit.
  - If the unit has been exposed to rain or water.
  - If the unit does not operate normally by following the operating instructions. Adjust only those controls that are covered by the operating instructions as an improper adjustment of other controls may result in damage and will often require extensive work by a qualified technician to restore the unit to its normal operation.
  - If the unit has been dropped or the enclosure has been damaged.
  - When the unit exhibits a distinct change in performance – this indicates a need for service.
16. **Servicing** – Do not attempt to service this product as opening or removing covers may expose the user to dangerous voltage or other hazards. Refer all servicing to qualified personnel.
17. **Replacement Parts** – When replacement parts are required, be sure the service technician has used replacement parts specified by the manufacturer or have the same characteristics as the original part. Unauthorized substitutions may result in fire, electric shock or other hazards.
18. **Safety Check** – Upon completion of any service or repairs to this unit, ask the service technician to perform safety checks to determine that the unit is in proper operating condition.

---

## NOTES ON HANDLING

---

Please retain the original shipping carton and/or packing materials supplied with this product. To ensure the integrity of this product when shipping or moving, repackage the unit as it was originally received from the manufacturer.

Do not use volatile liquids, such as aerosol spray, near this product. Do not leave rubber or plastic objects in contact with this product for extended periods of time. Rubber or plastic objects left in contact with this product for extended periods of time will leave marks on the finish.

The top and rear panels of the unit may become warm after long periods of use. This is not a malfunction.

---

## NOTES ON LOCATING

---

Place this unit on a level surface. Do not use it on a shaky or unstable surface such as a wobbling table or inclined stand.

If this unit is placed next to a TV, radio, or VCR, the playback picture may become poor and the sound may be distorted. If this happens, place the DVR unit away from the TV, radio, or VCR.

---

## NOTES ON CLEANING

---

Use a soft dry cloth for cleaning.

For stubborn dirt, soak the cloth in a weak detergent solution, wring well and wipe. Use a dry cloth to wipe it dry. Do not use any type of solvent, such as thinner and benzene, as they may damage the surface of the DVR unit.

If using a chemical saturated cloth to clean the unit, follow that product's instructions.

---

## NOTES ON MAINTENANCE

---

This DVR unit is designed to last for long periods of time. To keep the DVR unit always operational we recommend regular inspection maintenance (cleaning parts or replacement). For details, contact the nearest dealer.

---

## NOTES ON MOISTURE CONDENSATION

---

Moisture condensation damages the DVR unit. Read the following information carefully.

Moisture condensation occurs during the following cases:

When this product is brought directly from a cool location to a warm location.

When this product is moved to a hot and humid location from a cool location.

When this product is moved to a cool and humid location from a warm location.

When this product is used in a room where the temperature fluctuates.

When this product is used near an air-conditioning unit vent

When this product is used in a humid location.

**Do not use the DVR unit when moisture condensation may occur.**

If the DVR unit is used in such a situation, it may damage discs and internal parts. Remove any CD discs, connect the power cord of the DVR unit to the wall outlet, turn on the DVR unit, and leave it for two to three hours. After two to three hours, the DVR unit will warm up and evaporate any moisture. Keep the DVR unit connected to the wall and moisture will seldom occur.

---

## WARNING

---

TO REDUCE THE RISK OF ELECTRICAL SHOCK, DO NOT EXPOSE THIS APPLIANCE TO RAIN OR MOISTURE.  
DANGEROUS HIGH VOLTAGES ARE PRESENT INSIDE THE ENCLOSURE.  
DO NOT OPEN THE CABINET.  
REFER SERVICING TO QUALIFIED PERSONNEL ONLY.

---

## CAUTION

---

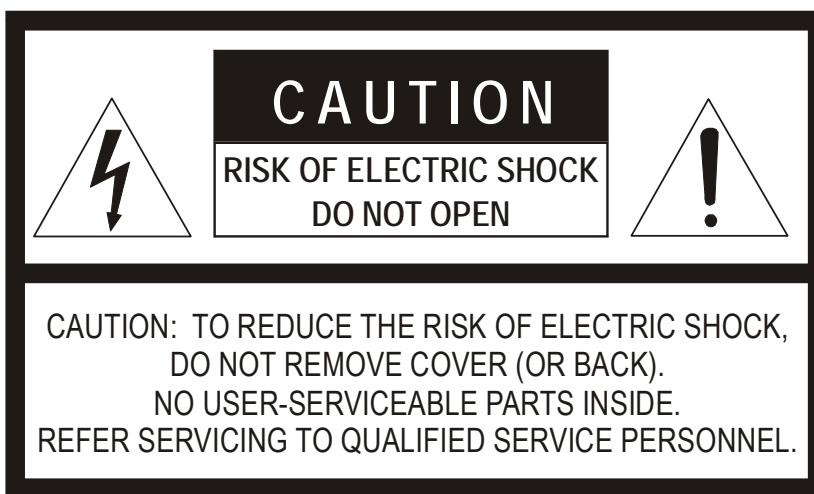

---

## EXPLANATION OF GRAPHICAL SYMBOLS

---



The lightning flash with arrowhead symbol, within an equilateral triangle, is intended to alert the user to the presence of un-insulated "dangerous voltage" within the product's enclosure that may be of sufficient magnitude to constitute a risk of electric shock to persons.



The exclamation point within an equilateral triangle is intended to alert the user to the presence of important operating and maintenance (servicing) instruction in the literature accompanying the product.

---

## **RACK MOUNT INSTRUCTIONS**

---

**Elevated Operating Ambient** – If installed in a closed or multi-unit rack assembly, the operating ambient temperature of the rack environment may be greater than room ambient. Therefore, consideration should be given to installing the equipment in an environment compatible with the maximum ambient temperature (T<sub>ma</sub>) specified by the manufacturer.

**Reduced Air Flow** – Installation of the equipment in a rack should be such that the amount of airflow required for safe operation of the equipment is not compromised.

**Mechanical Loading** – Mounting of the equipment in the rack should be such that a hazardous condition is not achieved due to uneven mechanical loading.

**Circuit Overloading** – Consideration should be given to the connection of the equipment to the supply circuit and the effect that overloading of the circuits might have on over current protection and supply wiring. Appropriate consideration of equipment nameplate ratings should be used when addressing this concern.

**Grounding** – Grounding of rack-mounted equipment should be maintained. Particular attention should be given to supply connections other than direct connections to the branch circuit (e.g. use of power strips).

---

## **FCC STATEMENT**

---

This equipment has been tested and found to comply with the limits for a Class A digital device, pursuant to Part 15 of the FCC Rules. These limits are designed to provide reasonable protection against harmful interference when the equipment is operated in a commercial environment. This equipment generates, uses, and can radiate radio frequency energy and, if not installed and used in accordance with the instruction manual, may cause harmful interference to radio communications. Operation of this equipment in a residential area is likely to cause harmful interference in which case the user will be required to correct the interference at his own expense.

---

## **UL NOTICE**

---

Underwriters Laboratories Inc. has not tested the performance or reliability of the security or signaling aspects of this product. UL has only tested for fire, shock and casualty hazards as outlined in UL's Standard for Safety UL 60950-1. UL Certification does not cover the performance or reliability of the security or signaling aspects of this product. UL MAKES NO REPRESENTATIONS, WARRANTIES OR CERTIFICATIONS WHATSOEVER REGARDING THE PERFORMANCE OR RELIABILITY OF ANY SECURITY OR SIGNALING RELATED FUNCTIONS OF THIS PRODUCT.

---



---

---

## CE NOTICE

---

This product is in conformity with the following European Directives:

**ELECTROMAGNETIC COMPATIBILITY DIRECTIVE, 89/336/EEC**  
(as amended by 92/31/EEC and by Article 5 of 93/68/EEC)

per the provisions of:

EN 55022:1994	EN 55024:1998	EN 61000-4-4:1995
EN 61000-3-2:1995	CISPR 24:1997	EN 61000-4-5:1995
EN 61000-3-3:1995	EN 61000-4-2:1995	EN 61000-4-6:1995
CISPR 22:1997	EN 61000-4-3:2002	EN 61000-4-11:1994

**LOW VOLTAGE DIRECTIVE, 73/23/EEC**  
(as amended by Article 13 of 93/68/EEC)

per the provisions of:

EN 60950-1: 2001

---



# Table of Contents

<b>PREFACE</b> .....	<b>1</b>
ABOUT THIS GUIDE .....	1
TECHNICIAN NOTES.....	1
<b>INTRODUCTION</b> .....	<b>3</b>
PRODUCT DESCRIPTION.....	3
FEATURES.....	4
<b>CONTROLS AND CONNECTIONS</b> .....	<b>7</b>
SYSTEM SPECIFICATIONS .....	8
FRONT PANEL CONTROLS AND LEDES .....	8
DVR/HVR .....	8
EVR/HVR .....	9
REAR PANEL CONNECTORS.....	10
DVR/HVR .....	10
EVR/HVR .....	11
PCI Card Configuration .....	12
x120 x60 PCI Configuration.....	12
x120R PCI Configuration.....	12
x240 8 and 16 Channel PCI Configuration .....	12
x240 32 Channel PCI Configuration .....	13
X480 8 and 16 Channel PCI Configuration.....	13
x480 32 Channel PCI Configuration .....	13
<b>GETTING STARTED</b> .....	<b>15</b>
IDENTIFYING INCLUDED COMPONENTS .....	16
OPTIONAL COMPONENTS .....	17
KEYBOARD SETUP .....	18
MOUSE SETUP.....	18
MONITOR SETUP .....	19
POWER SETUP.....	19
CONNECTING A VIDEO SOURCE TO THE DVR.....	20
CONNECTING SENSORS TO THE DVR.....	21
CONNECTING CONTROL OUTPUTS TO THE DVR.....	21
LOOPING OUTPUTS.....	22
LOOPING OUTPUT TERMINATION .....	22
CONNECTING A 16 CHANNEL AUDIO INPUT CABLE.....	22
CONNECTING A PTZ CAMERA.....	23
Attaching the RS-422 Adapter (x120 and x60 models) .....	23
Attaching the RS-485 Adapter (x120R, x240 and x480 models) .....	23
HARD DRIVE ARRAY.....	24
Swapping a Hard Drive .....	24
<b>APPENDIX: SPECIFICATIONS</b> .....	<b>27</b>
DVR SPECIFICATIONS.....	29
EVR SPECIFICATIONS.....	31
HVR SPECIFICATIONS.....	33



---

# PREFACE

## ABOUT THIS GUIDE

---

This manual is a setup and maintenance guide that can be used for reference when setting up the DVR unit and for troubleshooting when a problem occurs. Only authorized personnel should attempt to repair this unit.

Toshiba reserves the right to make changes to the DVR units represented by this manual without notice.

The following text and symbols mark special messages throughout this guide:

**NOTE:** Text set off in this manner indicates topics of interests that can help the user understand the product better.

**TIP:** Text set off in this manner indicates topics and points of interests that can be helpful when using or settings up the DVR unit.

## TECHNICIAN NOTES

---



**WARNING:** Only authorized technicians trained by Toshiba should attempt to repair this DVR unit. All troubleshooting and repair procedures that may be shown are for reference and minor repair only. Because of the complexity of the individual components and subassemblies, no one should attempt to make repairs at the component level or to make modifications to any printed wiring board. Improper repairs can create a safety hazard. And any indications of component replacement or printed wiring board modifications may void any warranty



**WARNING:** To reduce the risk of electrical shock or damage to the equipment:

- Do not disable the power grounding plug. The grounding plug is an important safety feature.
- Plug the power cord into a grounded (earthed) electrical outlet that is easily accessible at all times.
- Disconnect the power from the computer by unplugging the power cord either from the electrical outlet or the computer.



**CAUTION:** To properly ventilate your system, you must provide at least 3 inches (7.6 cm) of clearance at the front and back of the DVR unit.

---



# INTRODUCTION

## PRODUCT DESCRIPTION

---

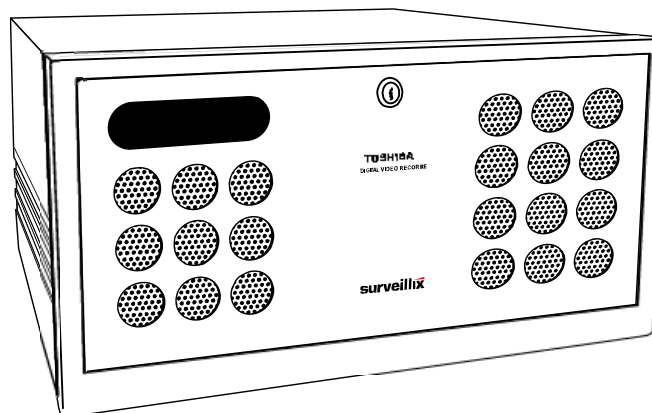

A Surveillix DVR is simply a server that performs as a High Definition Digital Recorder. By utilizing the many features of a computer, including processing power, storage capacity, graphics compression, and security features, the DVR unit is more powerful than the analog recorders of the past.

The Surveillix DVR server software comes pre-configured for fast and seamless integration within your existing IT infrastructure. Designed around Microsoft® Windows® XP, the server software offers unparalleled stability, security, and ease of use. Accordingly, your security investment has never been easier to maintain. Multiple users may simultaneously connect through any network connection for instantaneous live viewing, digital search, and off site video storage. Users can also connect remotely through DSL, Cable Modems, ISDN, or 56K dial-up. This powerful software enables users to establish recording schedules, create motion detection zones, use PTZ controls, and configure alarm inputs and outputs for each of the system's cameras. With the latest advancements in the DVR Server Software, searching and indexing your video archive has never been easier. Video can now be found, viewed, and exported in a number of file formats with just a few clicks.

The Surveillix DVR is a high performance security product ready to meet today's security demands.

## FEATURES

---

Toshiba's Surveillix DVRs include the following new features:

Optimized and Designed for Microsoft® Windows XP Embedded®

Supports up to 16 Relay Outputs on Alarm Activation

Supports up to 16 Sensor Inputs for Alarm Control

Remote System Operation & Configuration

Supports Multiple Simultaneous Remote Connections

PAN / TILT / ZOOM Controls

Simultaneous Video Search, Playback and Backup

Video Indexes for Easy Searching

Multiple Levels of Security Access

Up to 32 Looping Outputs

1 Composite Output

S Video Output

Up to 32 Camera Inputs

Up to 16 Network Recording Channels (HVR standard, upgrade option for EVR or DVR)

Up to 8 Audio Inputs

High Performance, Durable, Rack mount Case

Output the Video to a NTSC/PAL Display

Virtually Unlimited Storage Potential

Digital Signature Support

Continuous, Motion Detection, Alarm, Pre-Alarm, and Scheduled Recording Modes

Hardware Watchdog

Recording Resolution (X60, X120) - 640x480 / 640x240 / 320x240 NTSC  
640x576 / 640x288 / 320x288 PAL

Recording Resolution (X240, X480) - 720x480 / 720x240 / 360x240 NTSC  
720x576 / 720x288 / 360x288 PAL



NOTES:

NOTES:

# CONTROLS AND CONNECTIONS

This chapter includes the following information:

- Input / Output Connector Locations
- Front Panel Controls and LEDs
- Rear Panel Connectors

## SYSTEM SPECIFICATIONS

Surveillix™ state-of-the-art High Definition Digital Recorders are housed in a high performance and versatile 4U or 5U rack-mount case allowing easy storage of multiple DVRs for enterprise applications. Every Surveillix DVR unit comes equipped with the latest technology:

### EVR/DVR

Intel® Celeron D Processor  
 10/100 Network Interface  
 512 MB of System Memory  
 128 MB VGA Card  
 DVD±RW Recorder  
 Full Duplex High-Fi Sound Functionality  
 250 GB Video Storage Drive (minimum)

### HVR

Intel® Dual Core 3.4Ghz CPU (HVR)  
 10/100/1000 Gigabit Ethernet  
 1GB of System Memory  
 128 MB VGA Card  
 DVD±RW Recorder  
 Full Duplex High-Fi Sound Functionality  
 250 GB Video Storage Drive (minimum)

## FRONT PANEL CONTROLS AND LEDS

The front panel of the DVR unit contains the devices that will be commonly used for data removal, retrieval, and backup replacement. The most common components and buttons are shown below:

### DVR/HVR

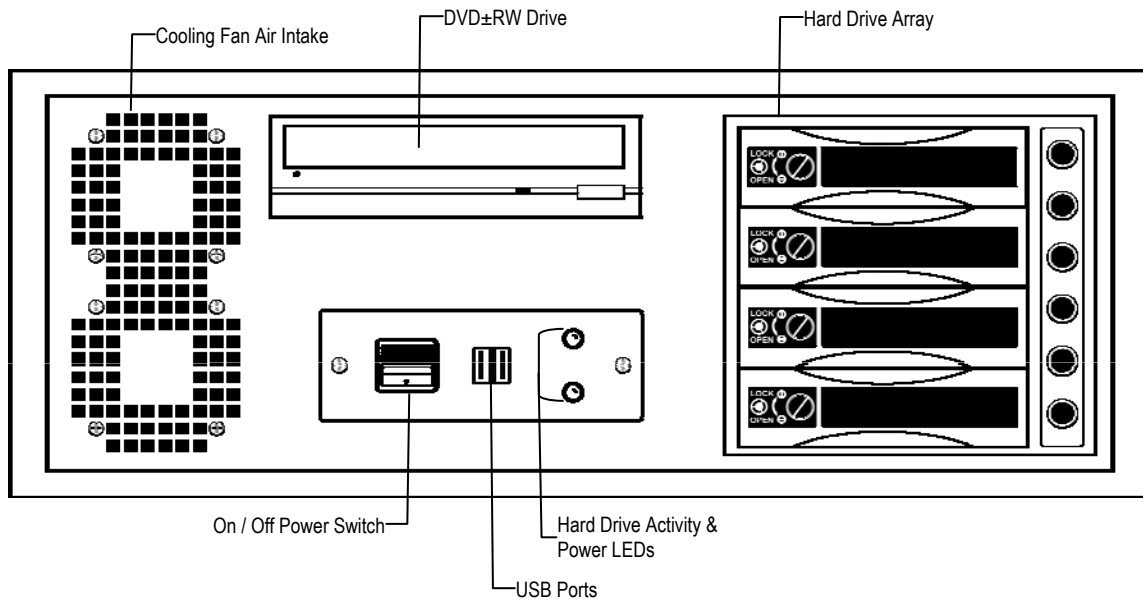

## EVR/HVR

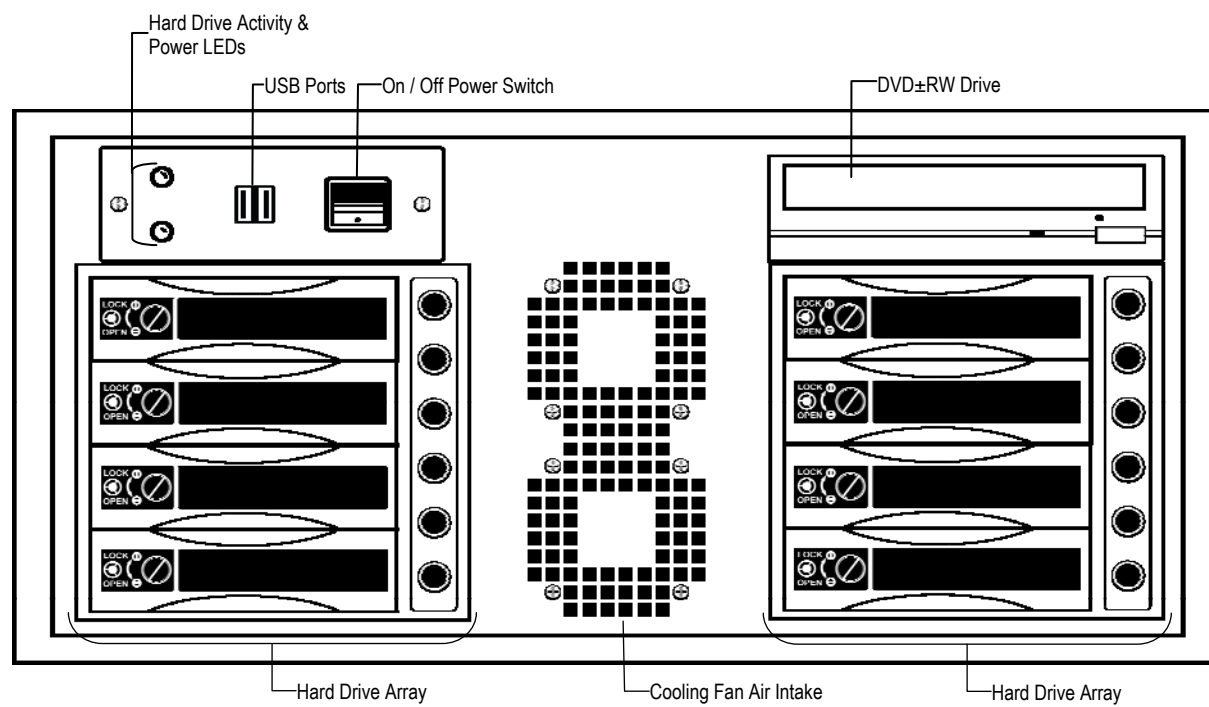

## REAR PANEL CONNECTORS

The rear panel of the DVR unit contains the connectors used to attach cameras, sensors, and relays to the DVR. Below are diagrams that outline the location and description of each connector:

### DVR/HVR

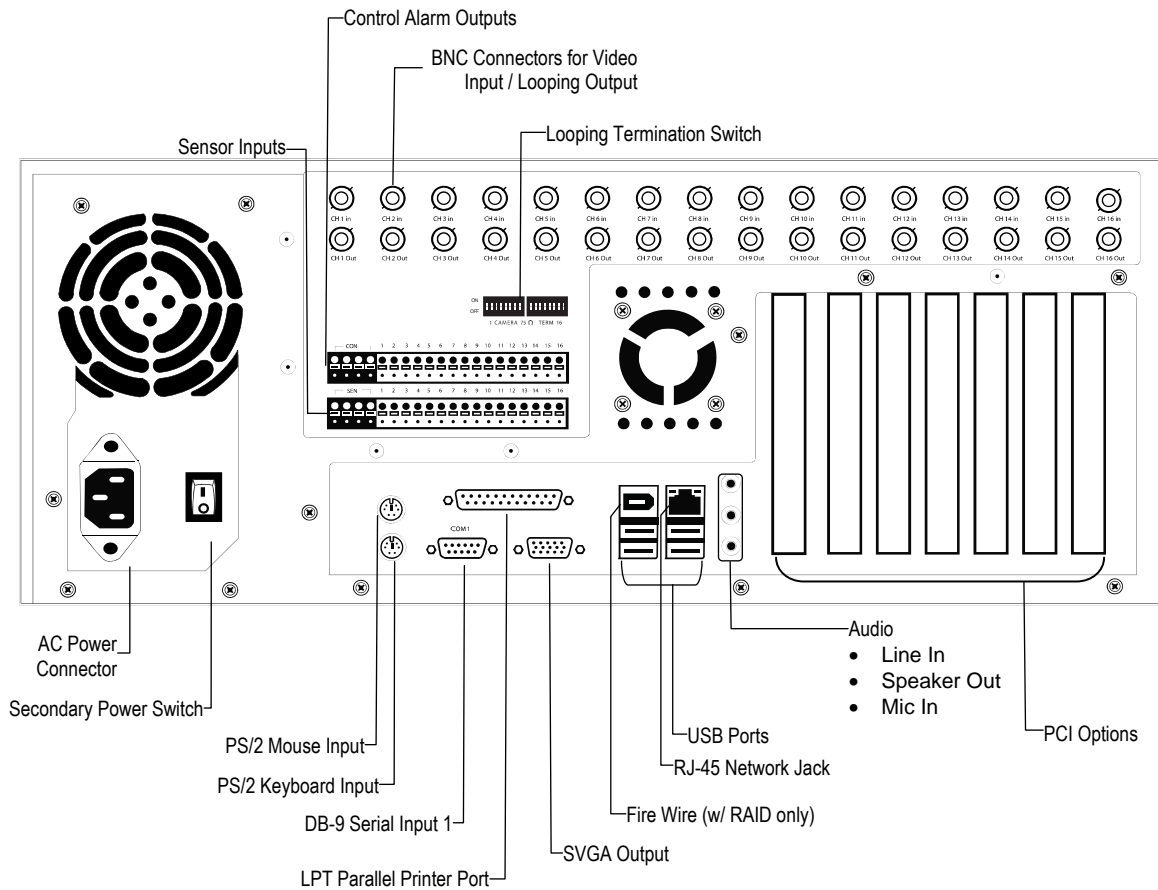

# EVR/HVR

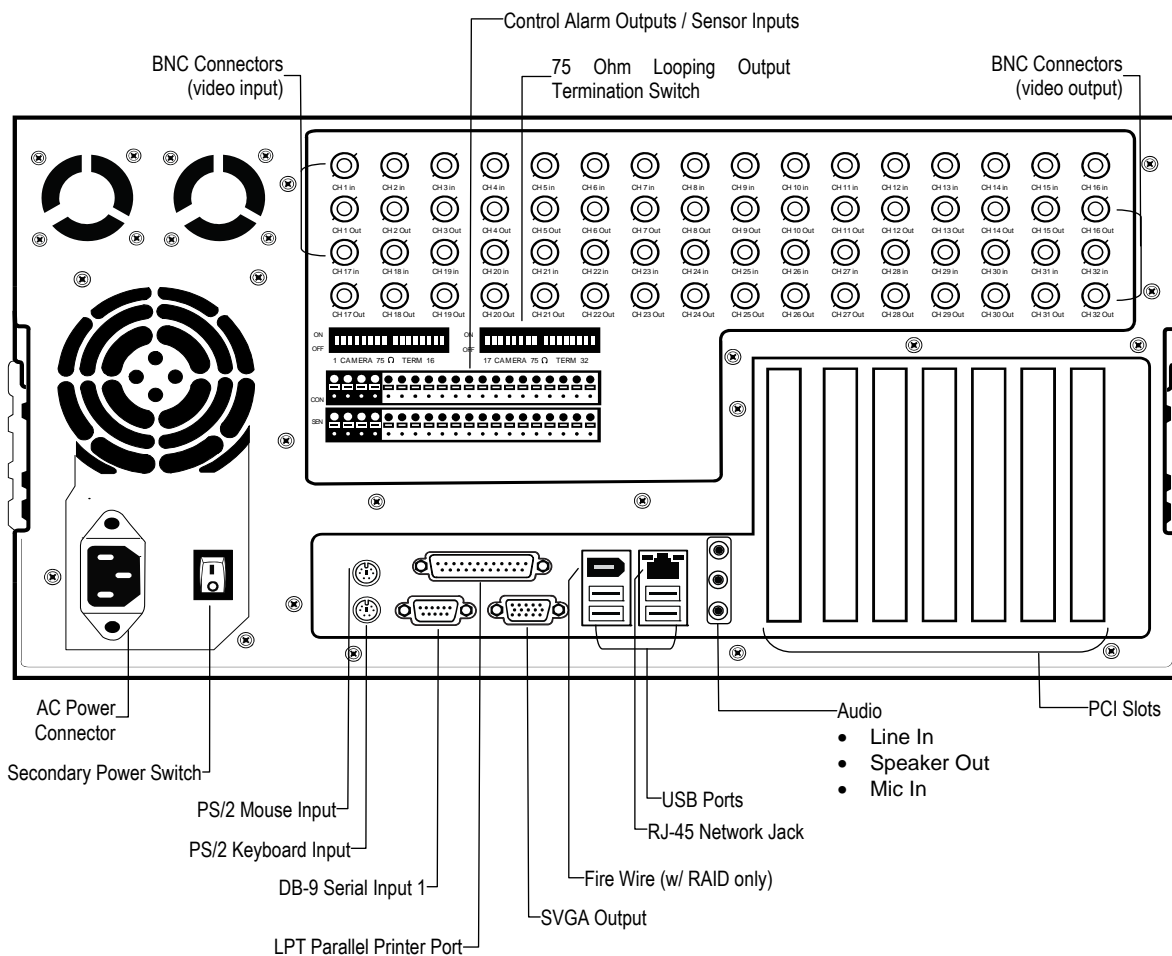

## PCI Card Configuration

### *x120 x60 PCI Configuration*

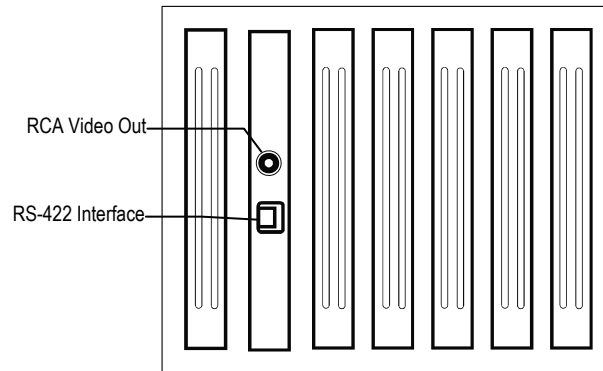

### *x120R PCI Configuration*

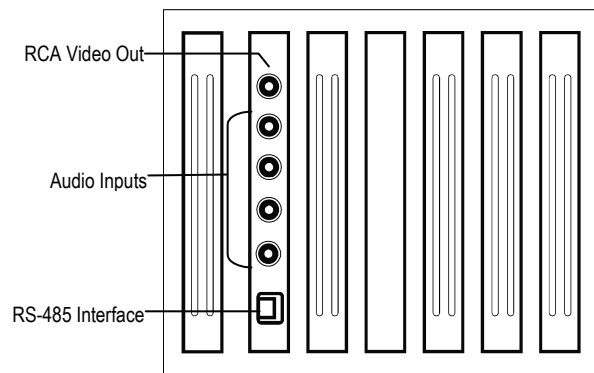

### *x240 8 and 16 Channel PCI Configuration*

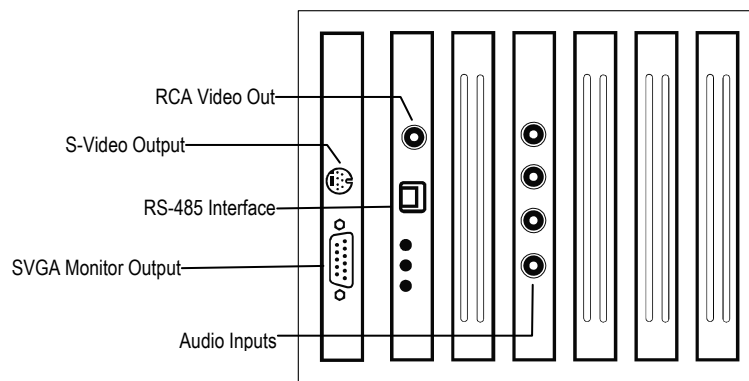



**x240 32 Channel PCI Configuration**

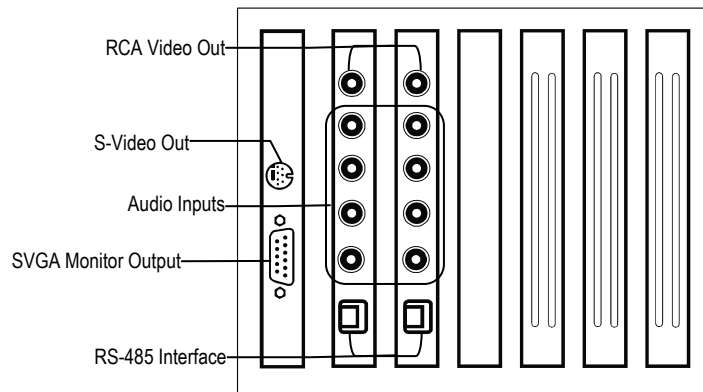

**X480 8 and 16 Channel PCI Configuration**

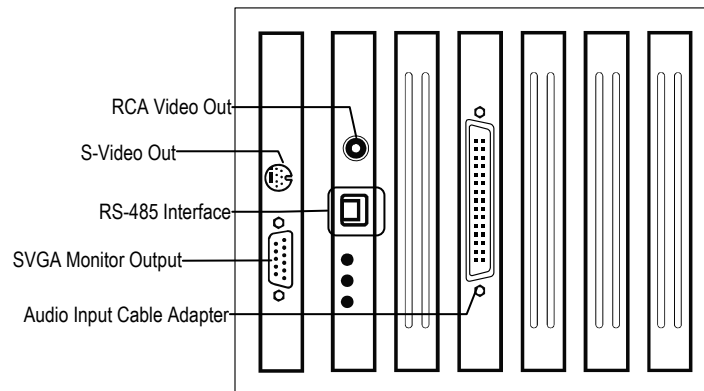

**x480 32 Channel PCI Configuration**

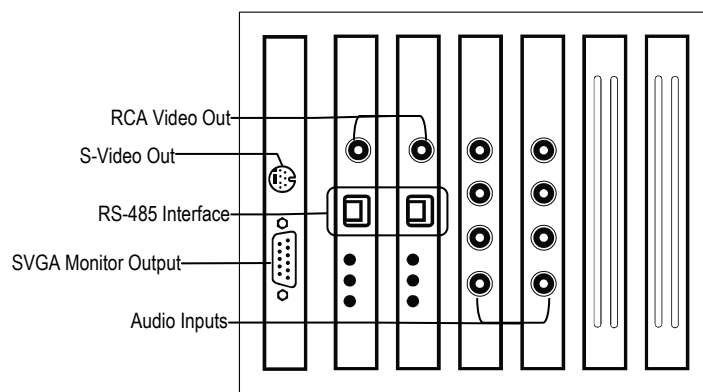

NOTES:







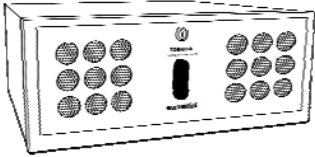

# GETTING STARTED

This chapter includes the following information:

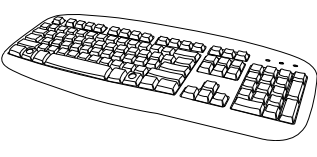
- Included Components
- Setting up the DVR Hardware
- Optional Components

## IDENTIFYING INCLUDED COMPONENTS

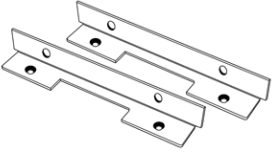
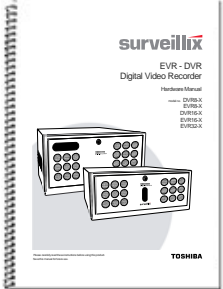
Surveillix™ DVRs come with a mouse, keyboard and selected software and cables. Identify the following components to make sure everything has been properly included with the new DVR unit. If any of the following items are missing, contact the dealer to arrange a replacement.

 <p>DVR Unit</p>	 <p>Mouse</p>	 <p>Keyboard</p>
 <p>Repair Disc/ Software Disc</p>	 <p>Power Adapter</p>	 <p>PTZ Adapter</p>
 <p>DVR Key</p>	 <p>Rack Mount Attachments with Screws</p>	 <p>DVR Manual</p>
 <p>RCA to BNC Adapter</p>	 <p>16 Channel Audio Input Cable*</p>	

\* 16 Channel Audio Input cable included standard with the 16Ch. 480 PPS models (optional with 16ch audio card upgrade).

---

## OPTIONAL COMPONENTS

---

To fully utilize the DVR unit's potential; several optional Surveillix components are listed below. Contact the dealer for more information.

### 1 Extra Video Storage Hard Drive

Each DVR unit has a virtually unlimited storage potential. Add additional Video Data Hard Drives to extend the amount of Video Data the DVR system can store before overwriting older data.

### 2 NP-FM56USB 56K External Modem

This 56K modem allows the user to connect the DVR to a standard phone line. Using this modem, either connect the unit to the Internet or allow a direct DVR to computer connection.

### 3 UPS UPS Power Backup

UPS Power Backups allow your DVR unit to remain fully functional even in the event of a power failure. UPS Power Backups also even the fluctuating power current out to provide a consistent, reliable power flow. This creates a stable environment for the DVR unit and reduces failure.

### 4 NP-4PKVM 4 Channel KVM Switch

The 4 Channel KVM switch allows you to have multiple boxes (up to 4) using only one keyboard, mouse and monitor. You can simply switch between the DVR units using the keyboard.

### 5 Hot Swappable Redundant Power Supplies

Every DVR and EVR has the option of a dual redundant hot swappable power supply. In the event of a component failure the inoperable power supply may be removed leaving the DVR running so no break in recording occurs. Simply replace the power supply with a new one and you are finished.

### 6 Raid Controller

A raid controller is available for increased performance or data reliability.

## KEYBOARD SETUP

---

To attach the keyboard to the DVR unit, plug the end of the Keyboard into the keyboard PS/2 Port located on the back of the machine. The keyboard PS/2 Port can be identified by the purple color. Refer to the Rear Panel Connectors diagram for more information.

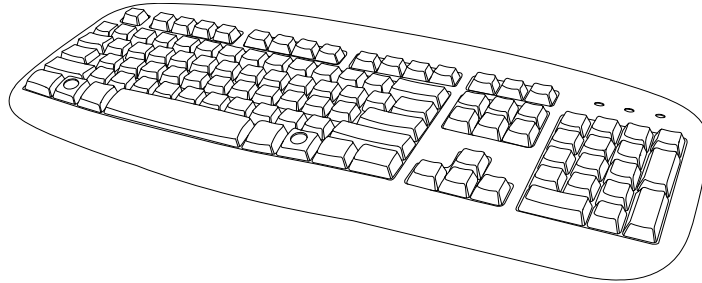

## MOUSE SETUP

---

To attach the mouse to the DVR unit, plug the end of the mouse into the mouse PS/2 Port located on the back of the machine. The mouse PS/2 Port can be identified by the green color.

The mouse uses a cursor called a pointer. Pointers come in many different shapes but are most commonly shaped like an arrow.

The mouse has two buttons: a left button and a right button. Quickly pressing and releasing one of these buttons is called clicking. Sometimes you will need to double-click – or click the same button twice quickly.

In this manual:

Click means to position the mouse cursor over an item and to single click the left button.

Right click means to position the mouse cursor over an item and to single click the right button.

Double-click means to position the mouse cursor over an item and to click the left button twice.

Select means to position the mouse cursor over a radio button, checkbox, or list item and click on it.

The scroll wheel in between the two buttons is used for added navigation functionality. By moving the wheel with index finger (scrolling), quickly move through multiple pages, lines, or windows. The wheel may also function as a third button allowing the user to quickly click or double-click an icon or a selected item

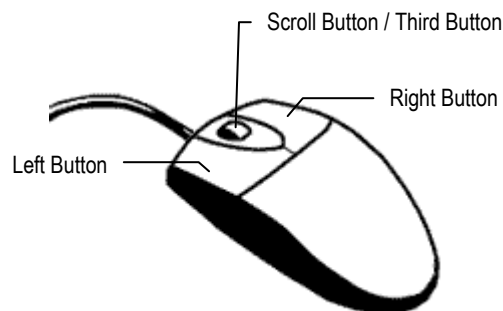

## MONITOR SETUP

---

The DVR may have one or both of the following connections available for monitors which can be used individually or in tandem.

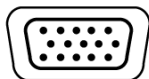

SVGA Output

To VGA Monitor.



S-Video Output

To TV/VCR.

Attach the monitor or monitors to the rear of the DVR unit using the cable supplied by the monitor manufacturer. Refer to the monitor manual for detailed information on how to setup and use it.

NOTE: The monitor must be capable of having a screen resolution of 1024 x 768 and display colors of at least 32 Bit

## POWER SETUP

---



**WARNING:**

To reduce the risk of electrical shock or damage to the equipment:

Do not disable the power grounding plug.  
The grounding plug is an important safety feature.

If the electrical plug you are using does not have a ground plug receptacle contact a licensed electrician to have it replaced with a grounded electrical outlet.

Plug the power cord into a grounded (earthed) electrical outlet that is easily accessible at all times.

Disconnect the power from the computer by unplugging the power cord either from the electrical outlet or the computer.

## CONNECTING A VIDEO SOURCE TO THE DVR

There are different types of Video Sources that can be plugged into the DVR unit including DVD players, VHS players, and CCTV Cameras. The back of the DVR unit contains up to 16 video inputs depending on the DVR model. The connectors use the BNC standard. The inputs are highlighted below.

### 8-Channel

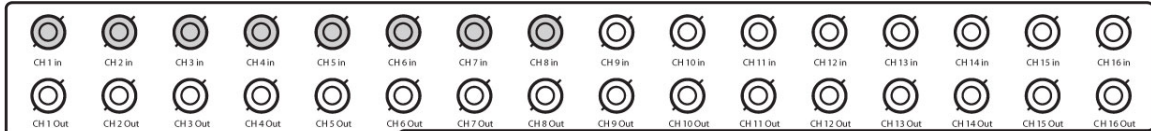

### 16 Channel

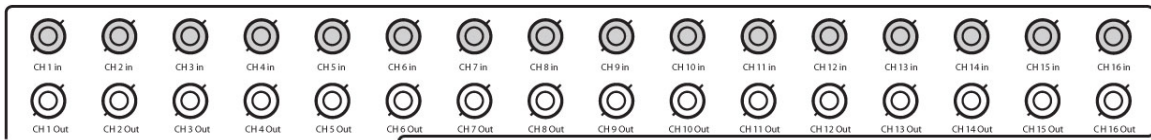

### 32 Channel

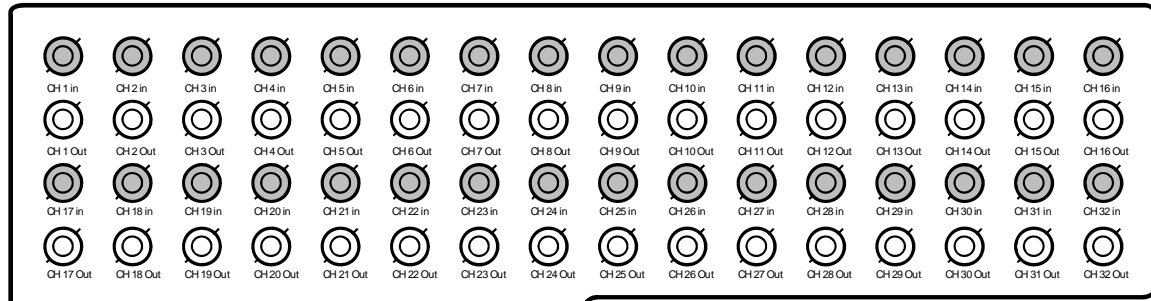

The video inputs are RG-53 BNC connectors. Plug one end into the video source (DVD, Camera, etc.) and plug the other end into the desired BNC input on the DVR unit.



## CONNECTING SENSORS TO THE DVR

Each DVR unit may have up to 16 Sensor inputs. These inputs can be used with devices such as infrared devices, motion device, glass breakage alarms, door and window trips, and many more. The Sensors can be set to Normally Open or Normally Closed inside the software.

There are 4 Common Grounds (-) and 16 sensor inputs (+). There is no power supplied to the ports so an external power supply must be used if power is necessary.

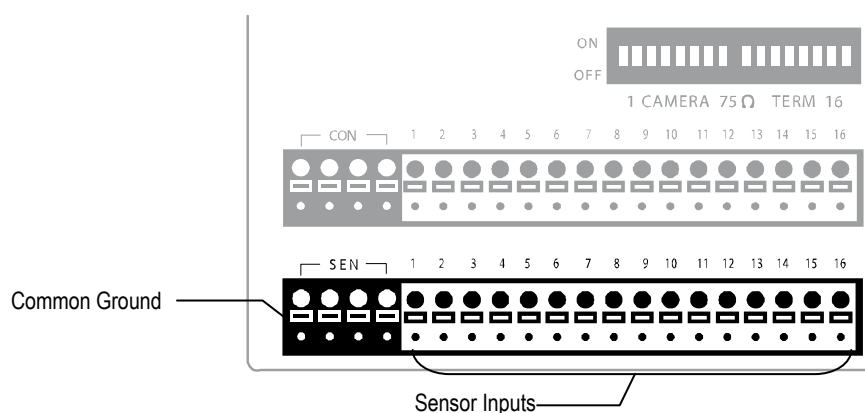

## CONNECTING CONTROL OUTPUTS TO THE DVR

Each DVR unit may have up to 16 Control Outputs. These outputs can be used to trigger devices such as Sirens, Phone Dialers, Lights, and any other relay activated device. There is no power supplied to the ports. Use an external power supply if necessary.

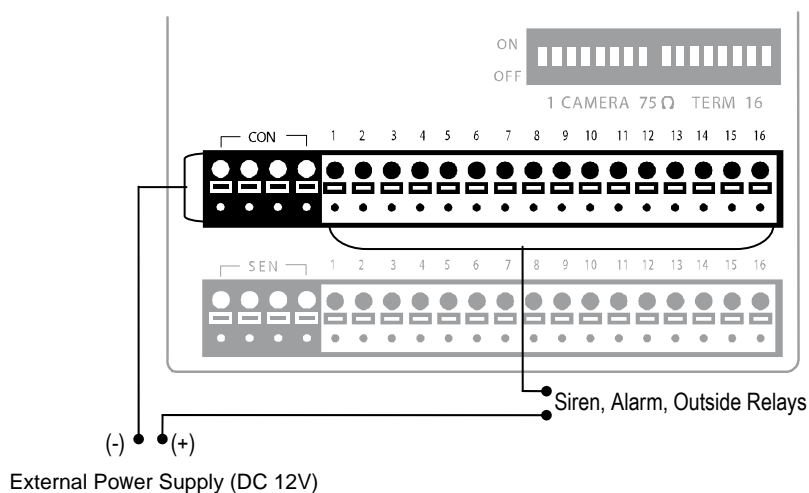

Use 12V, below 300mA. For controlling lights or other devices, use another external relay.

Maximum voltage is 24V AC @ 1 amp

Output uses a Form C Relay

## LOOPING OUTPUTS

The 8 and 16 Channel DVR units may have up to 16 Looping outputs. Depending on the destination of the outputs, each output may have to be terminated. Looping outputs for a 16 Channel DVR looping are highlighted below.

32 Channel EVR units may have up to 32 looping outputs.

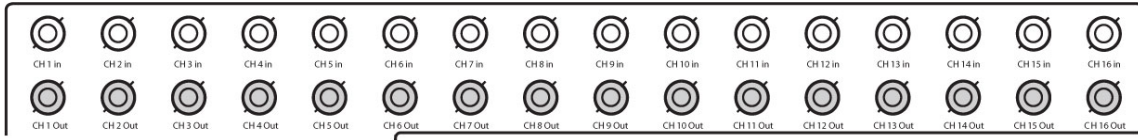

The Video inputs are RJ-59 BNC connectors. Make sure there is a video source connected to the input and then connect a cable to the Channel Out. The looping outs can be connected to video monitors or combined with adapters to connect to VCR's.

## LOOPING OUTPUT TERMINATION

When terminating the outputs becomes necessary, the DVR unit has built in termination that allows you to select individual outputs to terminate individually. It is not always necessary to terminate the output when using it. It is dependant on the device with which you are connecting it to. As a rule, if the image appears distorted or virtually unviewable, it most likely needs to be terminated.

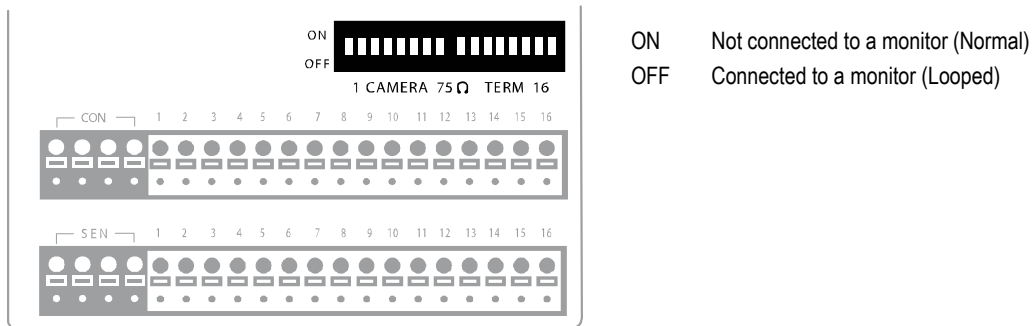

Always leave the dipswitch set to the ON position when the Looping Outputs are not used.

## CONNECTING A 16 CHANNEL AUDIO INPUT CABLE

The 16 channel audio input cable (standard with the 16Ch 480 PPS Surveillix DVR) connects to a single serial port in the back of the unit.

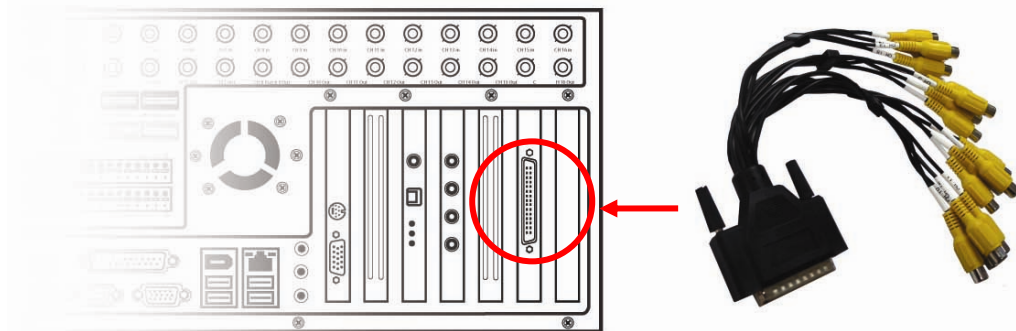

When connecting the 16 Channel Audio Input Cable, make sure to properly secure the cable to insure there is no loss of audio quality.

## CONNECTING A PTZ CAMERA

Setting up a PTZ Camera is simple. The DVR unit comes preassembled with an internal PTZ adapter. The cabling may be run up to 4,000 ft using 22 Gauge Twisted Pair.

It is important to understand how the PTZ connects to the DVR. The DVR outputs an RS-232 signal and converts it to an RS-422/485 signal which is then sent to the PTZ camera.

### Attaching the RS-422 Adapter (x120 and x60 models)

1. Locate the PTZ adapter cable
2. Connect the wires of the PTZ adapter to the PTZ camera. The red wire should connect to the RX+ on the camera and the brown wire should connect to the RX-.

**NOTE:** The PTZ adapter has four wires but only two are necessary for this application; the yellow and orange wires are not used currently.

3. Connect the other end of the adapter to the XVR unit as shown.
4. Assign the PTZ camera an ID number that coincides with the number assigned to it by the XVR unit

**Example:** If the camera is plugged into input number 5, set the PTZ unit to ID number 5.

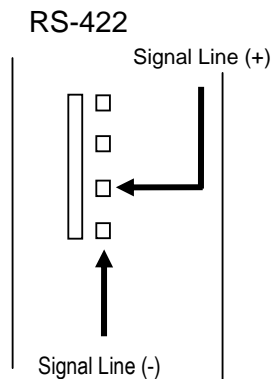

### Attaching the RS-485 Adapter (x120R, x240 and x480 models)

1. Locate the PTZ adapter cable.
2. Connect the two wires of the PTZ adapter to the PTZ camera. The red wire on the adapter should connect to the RX+ on the PTZ and the brown wire should connect to the RX-.
3. Connect the other end of the adapter to the DVR unit as shown
4. Assign the PTZ camera an ID number that coincides with the number assigned to it by the DVR unit.

**Example:** If the camera is plugged into input number 5, set the PTZ unit to ID number 5.

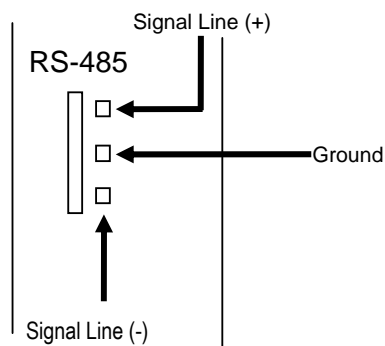

## HARD DRIVE ARRAY

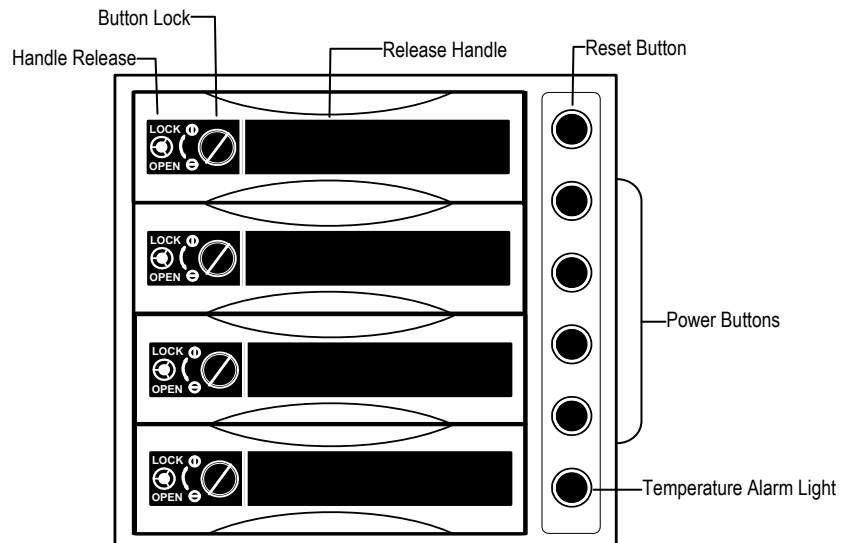

### Swapping a Hard Drive

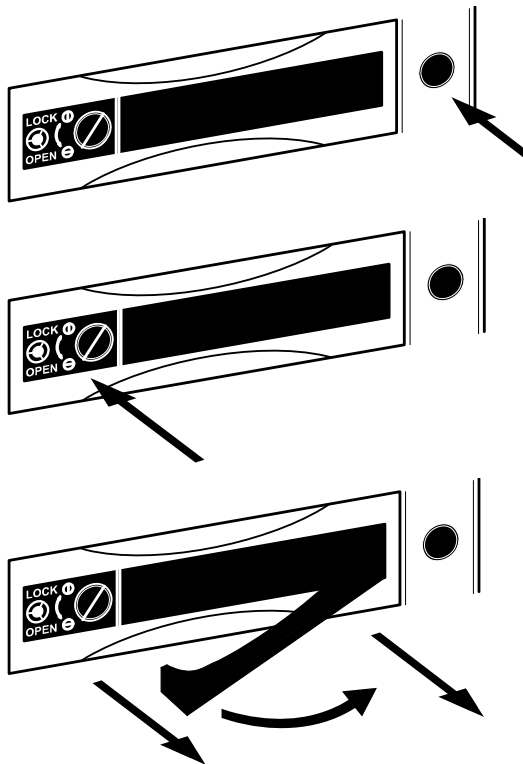

1. Press the Hard Drive Power Button to turn off power to the hard drive being removed.

2. Turn the Button Lock to the open position and push the Handle Release Button

3. Pull the Release Handle outward while removing the hard drive. Reverse steps to install.

NOTES:

NOTES:

# **APPENDIX: SPECIFICATIONS**





## DVR SPECIFICATIONS

		8	16
CPU		Intel® Celeron 3.2+ GHz CPU	
Storage (Hard Drive)		250 GB Standard / Virtually Unlimited Storage Potential	
Storage MAX		Up to 4 HDD with DVD±RW	
Operating System		Microsoft® Windows® XP Embedded	
Viewing Rate	NTSC	Max 480 FPS	
	PAL	Max 480 FPS	
Recording Rate	NTSC	60 PPS – Max 60 PPS / 120 PPS – Max 120 PPS / 240 PPS – Max 240 FPS / 480 PPS – Max 480 PPS	
	PAL	60 PPS – Max 50 PPS / 120 PPS – Max 100 PPS / 240 PPS – Max 200 FPS / 480 PPS – Max 400 PPS	
Digital Control Output		8	16
Sensor Input		8	16
Resolution (60 PPS, 120 PPS)	NTSC	640x480 / 640x240 / 320x240	
	PAL	640x576 / 640x288 / 320x288	
Resolution (240 PPS, 480 PPS)	NTSC	720x480 / 720x240 / 360x240	
	PAL	720x576 / 720x288 / 360x288	
Image Compression		MJPEG	
Average File Size		360x240 – 3~5k	
		720x240 – 4~8k	
		720x480 – 7~12k	
Video Inputs		8CH (BNC)	16CH (BNC)
Looping Outputs		8CH (BNC) – Each can be terminated (75Ω)	16CH (BNC) – Each can be terminated (75Ω)
Composite Outputs		RCA	
Video Outputs		SVGA	
Max PPS Per Channel		30 Pictures Per Second (PPS) – NTSC / 25 Pictures Per Second (PPS) - PAL	
Motion Detection		Up to 5 Regions Per Channel / Adjustable Sensitivity	
Remote Operation		Full Remote Control Through PSTN, ISDN, ADSL, LAN, and TCP/IP	
Remote Software		Compatible with Microsoft Windows 2000,XP	
PAN / TILT / ZOOM		Built In RS-422/RS-485 Interface	
Recording Mode		Continuous, Motion Detection, Sensor, Scheduled Recording	
Backup		USB, DVD±RW	
Digital Signature		Supports Digital Signature Verification	
Emergency Agent		Transmitted through TCP/IP – SCS	

NOTES:

## EVR SPECIFICATIONS

		8	16	32
CPU		Intel® 3.2+ GHz CPU		
Storage (Hard Drive)		250 GB Standard / Virtually Unlimited Storage Potential		
Storage MAX		Up to 8 HDD with DVD±RW		
Operating System		Microsoft® Windows® XP Embedded		
Viewing Rate	NTSC	Max 480 FPS		
	PAL	Max 480 FPS		
Recording Rate	NTSC	120 PPS – Max 120 PPS / 240 PPS – Max 240 FPS / 480 PPS – Max 480 PPS		
	PAL	120 PPS – Max 100 PPS / 240 PPS – Max 200 FPS / 480 PPS – Max 400 PPS		
Digital Control Output		8	16	16
Sensor Input		8	16	16
Resolution	NTSC	720x480 / 720x240 / 360x240		
	PAL	720x576 / 720x288 / 360x288		
Image Compression		MJPEG		
Average File Size		360x240 – 3~5k		
		720x240 – 4~8k		
		720x480 – 7~12k		
Video Inputs		8 CH (BNC)	16 CH (BNC)	32 CH (BNC)
Looping Outputs		8 CH (BNC)	16 CH (BNC)	32 CH (BNC)
Composite Outputs		RCA		
Video Outputs		S-Video, SVGA		
Max PPS Per Channel		30 Pictures Per Second (PPS) – NTSC / 25 Pictures Per Second (PPS) - PAL		
Motion Detection		Up to 5 Regions Per Channel / Adjustable Sensitivity		
Remote Operation		Full Remote Control Through PSTN, ISDN, ADSL, LAN, and TCP/IP		
Remote Software		Compatible with Microsoft Windows 2000,XP		
PAN / TILT / ZOOM		Built In RS-485 Interface		
Recording Mode		Continuous, Motion Detection, Sensor, Scheduled Recording		
Backup		USB, DVD±RW		
Digital Signature		Supports Digital Signature Verification		
Emergency Agent		Transmitted through TCP/IP – SCS		

NOTES:

## HVR SPECIFICATIONS

		8	16	32
CPU		Intel® Dual Core 3.4Ghz CPU		
Storage (Hard Drive)		250 GB Standard / Virtually Unlimited Storage Potential		
Storage MAX		Up to 8 HDD with DVD±RW		
Operating System		Microsoft® Windows® XP Embedded		
Viewing Rate	NTSC	Max 480 FPS		
	PAL	Max 480 FPS		
Recording Rate	NTSC	x240 – Max 240 PPS / x480 – Max 480 PPS		
	PAL	x240 – Max 200 PPS / x480 – Max 400 PPS		
	IP cameras	Dependant on Network Video Device Encoding Rate		
Digital Control Output		8	16	16
Sensor Input		8	16	16
Resolution	NTSC	720x480 / 720x240 / 360x240		
	PAL	720x576 / 720x288 / 360x288		
	IP cameras	Recording resolutions dependant upon the resolutions the Network Camera supports		
Image Compression		MJPEG		
Average File Size	360x240 – 3~5k			
	720x240 – 4~8k			
	720x480 – 7~12k			
Video Inputs		8 CH (BNC)	16 CH (BNC)	32 CH (BNC)
Looping Outputs		8 CH (BNC)	16 CH (BNC)	32 CH (BNC)
Composite Outputs		RCA		
Video Outputs		S-Video, SVGA		
Max PPS Per Channel		30 Pictures Per Second (PPS) – NTSC / 25 Pictures Per Second (PPS) - PAL		
Motion Detection		Up to 5 Regions Per Channel / Adjustable Sensitivity		
Remote Operation		Full Remote Control Through PSTN, ISDN, ADSL, LAN, and TCP/IP		
Remote Software		Compatible with Microsoft Windows 2000,XP		
PAN / TILT / ZOOM		Built In RS-485 Interface		
Recording Mode		Continuous, Motion Detection, Sensor, Scheduled Recording		
Backup		USB, DVD±RW		
Digital Signature		Supports Digital Signature Verification		
Emergency Agent		Transmitted through TCP/IP – SCS		

## Free Manuals Download Website

<http://myh66.com>

<http://usermanuals.us>

<http://www.somanuals.com>

<http://www.4manuals.cc>

<http://www.manual-lib.com>

<http://www.404manual.com>

<http://www.luxmanual.com>

<http://aubethermostatmanual.com>

Golf course search by state

<http://golfingnear.com>

Email search by domain

<http://emailbydomain.com>

Auto manuals search

<http://auto.somanuals.com>

TV manuals search

<http://tv.somanuals.com>