

TOSHIBA

INTERNET FACSIMILE

Gp120F / Gp125F

OPERATOR'S MANUAL

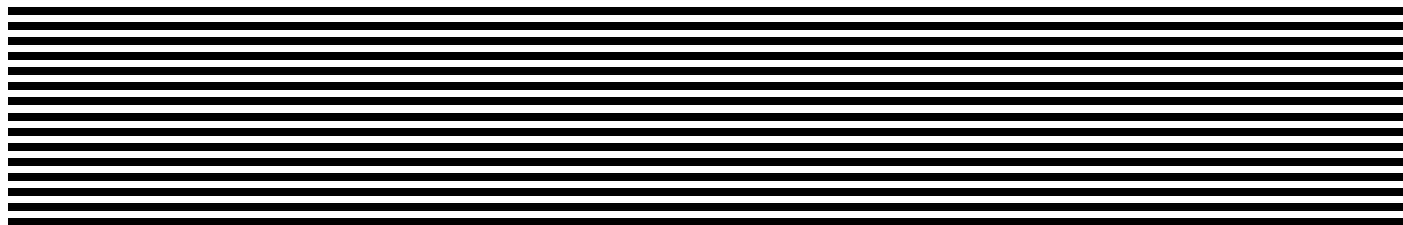
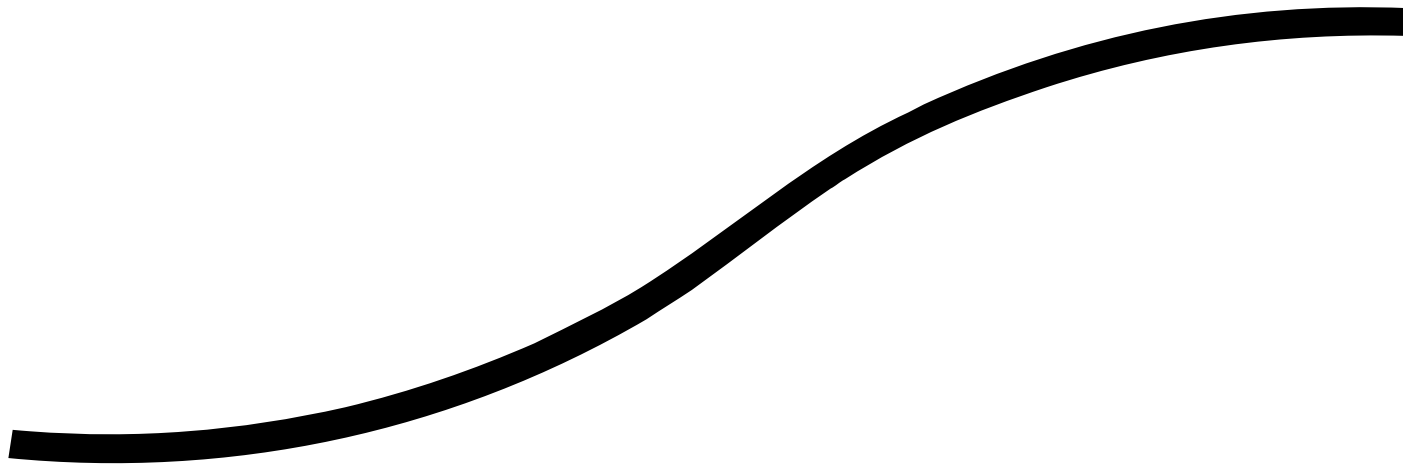

NOTICE TO USERS

Please read through this manual before using the machine. After reading it, be certain to keep it so that you may refer to it whenever necessary.

U. S. A.

WARNING FCC Notice: Part 15

This terminal has been tested and found to comply with the limits for a Class A digital device, pursuant to Part 15 of the FCC Rules. These limits are designed to provide reasonable protection against harmful interference when the equipment is operated in a commercial environment. This equipment generates, and can radiate radio frequency energy and, if not installed and used in accordance with this guide, may cause harmful interference to radio communications. Operation of this terminal in a residential area is likely to cause harmful interferences in which case the user will be required to correct the interference at his/her own expense.

WARNING FCC Notice: Part 68

This equipment complies with Part 68 of the FCC Rules. On the rear of this equipment is a label that contains, among other information, the FCC Registration Number and ringer equivalence number (REN) for this equipment. If requested, this information must be provided to the telephone company.

The REN is used to determine the quantity of devices that may be connected to the telephone line. Excessive REN's on the telephone line may result in the devices not ringing in response to an incoming call. In most, but not all areas, the sum of the REN's should not exceed five (5.0). To be certain of the number of devices that may be connected to the line, as determined by the total REN's contact the telephone company to determine the maximum REN for the calling area.

If your facsimile machine causes harm to the telephone network, the telephone company will notify you in advance that temporary discontinuance of service may be required. But if advance notice is not practical, you will be notified as soon as possible, also, you will be advised of your right to file a complaint with the FCC if you believe it is necessary.

The telephone company may make changes in its facilities, equipment, operations, or procedures that could affect the operation of the equipment. If this happens, the telephone company will provide advance notice in order for you to make the necessary modifications in order to maintain uninterrupted service.

If you experience trouble with this facsimile machine, please contact

TOSHIBA AMERICA BUSINESS SOLUTIONS, INC.
Electronic Imaging Division
2 Musick, Irvine, CA 92618-1631

for repair/warranty information. If the trouble is causing harm to the telephone network, the telephone company may request you remove the equipment from the network, until the problem is resolved.

The equipment may not used on coin service provided by the telephone network, connection to Party Line Service is subject to state tariffs. (Contact the state public utility commission, or corporation commission for information.)

This device is equipped with a USOC RJ11C connector.

THE TELEPHONE CONSUMER PROTECTION ACT: The Telephone Consumer Protection Act of 1991 makes it unlawful for any person to use a computer or other electronic device to send any message via a telephone fax machine unless such a message clearly contains in a margin at the top or bottom of each transmitted page or on the first page of the transmission, the date and time it is sent and an identification of the business or other entity, or other individual sending the message and the telephone number of the sending machine or such business, other entity, or individual.

In order to program this information into your fax machine, you should complete the setup procedures listed for station ID number and name on pages 42 and 43 in this manual.

This equipment is hearing aid compatible.

Canada

NOTICE: The Industry Canada label identifies certified equipment. This certification means that the equipment meets telecommunications network protective, operational and safety requirements as prescribed in the appropriate Terminal Equipment Technical Requirements document(s). The Department does not guarantee the equipment will operate to the user's satisfaction.

Before installing this equipment, users should ensure that it is permissible to connect a facsimile to the facilities of their local telecommunications company. The equipment must also be installed using an acceptable method of connection. The customer should be aware that compliance with the above conditions may not prevent degradation of service in some situations.

Repairs to certified equipment should be coordinated by a representative designated by the supplier. Any repairs or alterations made by the user to this equipment, or equipment malfunctions, may give the telecommunications company cause to request the user to disconnect the equipment.

Users should ensure for their own protection that the electrical ground connections of the power utility, telephone lines and internal metallic water pipe system, if present, are connected together. This precaution may be particularly important in rural areas.

CAUTION: Users should not attempt to make such connections themselves, but should contact the appropriate electric inspection authority, or electrician, as appropriate.

The Ringer Equivalence Number of your facsimile is 0.3

NOTICE: The Ringer Equivalence Number (REN) assigned to each terminal device provides an indication of the maximum number of terminals allowed to be connected to a telephone interface. The termination on an interface may consist of any combination of devices subject only to the requirement that the sum of the Ringer Equivalence Numbers of all the devices does not exceed 5.

TOSHIBA OF CANADA LIMITED

Office Product Group
191 McNABB STREET
MARKHAM, ONTARIO L3R 8H2

AVIS: L'étiquette d'Industrie Canada identifie le matériel homologué. Cette étiquette certifie que le matériel est conforme aux normes de protection, d'exploitation et de sécurité des réseaux de télécommunications, comme le prescrivent les documents concernant les exigences techniques relatives au matériel terminal. Le Ministère n'assure toutefois pas que le matériel fonctionnera à la satisfaction de l'utilisateur.

Avant d'installer ce matériel, l'utilisateur doit s'assurer qu'il est permis de le raccorder aux installations de l'entreprise locale de télécommunication. Le matériel doit également être installé en suivant une méthode acceptée de raccordement. L'abonné ne doit pas oublier qu'il est possible que la conformité aux conditions énoncées ci-dessus n'empêche pas la dégradation du service dans certaines situations.

Les réparations de matériel homologué doivent être coordonnées par un représentant désigné par le fournisseur. L'entreprise de télécommunications peut demander à l'utilisateur de débrancher un appareil à la suite de réparations ou de modifications effectuées par l'utilisateur ou à cause de mauvais fonctionnement.

Pour sa propre protection, l'utilisateur doit s'assurer que tous les fils de mise à la terre de la source d'énergie électrique, des lignes téléphoniques et des canalisations d'eau métalliques, s'il y en a, sont raccordés ensemble. Cette précaution est particulièrement importante dans les régions rurales.

Avertissement: L'utilisateur ne doit pas tenter de faire ces raccordements lui-même; il doit avoir recours à un service d'inspection des installations électriques, ou à un électricien, selon le cas.

L'indice d'équivalence de la sonnerie de ce matériel 0.3

AVIS: L'indice d'équivalence de la sonnerie (IES) assigné à chaque dispositif terminal indique le nombre maximal de terminaux qui peuvent être raccordés à une interface. La terminaison d'une interface téléphonique peut consister en une combinaison de quelques dispositifs, à la seule condition que la somme d'indices d'équivalence de la sonnerie de tous les dispositifs n'excède pas 5.

| | | | |
|---|-----------|--|-----------|
| NOTICE TO USERS | 1 | E-MAIL ACCOUNT SETUP | 59 |
| NOTICE TO USERS | 2 | E-mail Address Setting | 60 |
| INTRODUCTION | 5 | Error E-mail Forward Address Setting | 61 |
| FEATURES | 5 | Receive Mode Setting | 62 |
| Before Connecting the Machine to Internet | 6 | POP Server Address Setting | 63 |
| Internet FAX Transmission Overview | 7 | POP Time Setting | 64 |
| FACSIMILE UNIT DESCRIPTION | 9 | POP Login Name Setting | 65 |
| Rear View | 9 | POP Password Setting | 66 |
| Operation Panel | 9 | SMTP Server Address Setting | 67 |
| BASIC FUNCTIONS | 10 | E-MAIL PROPERTIES SETUP | 68 |
| RECEIVE E-MAIL | 10 | Print Text Body Setting | 69 |
| Automatic Receiving Mode | 10 | Body Page Limit Setting | 70 |
| Manual Receiving Mode | 10 | Send Disposition Setting | 71 |
| Receiving from SMTP Server | 10 | Print Header Setting | 72 |
| Output Print Format for Receiving E-mail | 11 | Print E-mail Error Setting | 73 |
| SEND E-MAIL | 13 | Print DSN Setting | 74 |
| Sending E-mail by Direct Input | 13 | Print Disposition Setting | 75 |
| Sending E-mail by Searching E-mail Addresses | 16 | Request DSN Setting | 76 |
| Sending E-mail by One Touch Dialing | 20 | Confirmation Timer Setting | 77 |
| Sending E-mail by Abbreviated Dialing | 21 | Set Confirmation Time Setting | 78 |
| Multi-Key Quick Broadcast Transmission | 23 | MSG Size Limit Setting | 79 |
| AUTOMATIC TELEPHONE DIALING REGISTRATION | 25 | ONRAMP GATEWAY SETUP | 80 |
| Abbreviated Dialer Registration | 25 | Setting Up a Relay Box with E-mail Address | 80 |
| Modify/Delete the Abbreviated Dial Number | 35 | OFFRAMP GATEWAY SETUP | 85 |
| One Touch Dialer Registration | 37 | Offramp Gateway, Offramp Gateway Overview | 85 |
| Modify/Delete the One Touch Key | 47 | How to send a document using Offramp Gateway | 86 |
| Group Number Registration | 49 | Setting Up for Offramp Gateway | 86 |
| SETUP | 53 | E-mail to FAX Gateway Setting | 87 |
| SETUP FLOW | 53 | Gateway Print Setting | 88 |
| TCP/IP CONFIGURATION | 54 | Gateway Security Setting | 89 |
| BootP/DHCP Setting | 54 | ADDITIONAL FUNCTIONS SETUP | 90 |
| IP Address Setting | 55 | FTP Server Login Name Setting | 90 |
| Subnetmask Setting | 56 | FTP Server Login Password Setting | 91 |
| Default Gateway Setting | 57 | LAN FAX Setting | 92 |
| Host Name Setting | 58 | IPX/SPX Protocol Setting | 93 |
| | | Frame Type Setting | 94 |

- LIST OF REPORTS 95**
- E-MAIL NOTIFICATION REPORTS PRINT FORMAT 95**
- DSN Report 95
- MDN Report 96
- Alert Report 97
- LIST AND REPORT PRINT FORMAT
AND PRINTING PROCEDURE 98**
- Transmission/Reception Journal (Communication Journal) 98
- Memory Transmission Report 99
- Reservation List 100
- Multi-Address Transmission Report 101
- Preset Dialing Number Lists 102
- Alphabetical Sort List 102
- Abbreviated Dial Number List 103
- Group Number List 104
- One Touch Number List 105
- Function List 106
- Menu List 108
- Power Failure List 110
- TROUBLESHOOTING 111**
- Error Message 111
- Error Code Printed on Report 115
- TECHNICAL WORD REFERENCE 117**

INTRODUCTION - FEATURES

The Internet Fax Kit enables your machine to transmit the document through the Internet or Intranet. This enables the machine to transmit the document as an E-mail between other Internet Fax machines and computers.

NOTE:

- The machine must be connected to the E-mail server in the local area network to use the Internet Fax functions. Ensure that your E-mail server is connected with the machine in the local area network.
- The parallel port is disabled when the Internet Fax kit is installed in the machine.

This machine can do the following after connecting to the Internet:

Send a document as an E-mail through the Internet:

This machine can send a document as an E-mail through the Internet. The scanned image is transferred to the TIFF-FX images and sent as attached file of an E-mail.

Automatic receiving and manual receiving of an E-mail:

This machine can automatically or manually check the email server to see whether an E-mail has been delivered. If an E-mail has been received, the machine will print out the E-mail.

73 one touch key to E-mail:

The remote party's E-mail address data can be registered to a one touch key. E-mail options can be registered for each address.

300 abbreviated dial numbers to E-mail:

E-mail addresses can be assigned to 300 abbreviated dial numbers in the range from No. 001 to 999.

Multi-address transmission to E-mail:

Transmissions of the same document to multiple E-mail addresses (up to 373 addresses) are possible using one operation sequence, in which preset abbreviated dial numbers (300), and one touch dial keys (73) can be used. When the multi-key is specified, key pad dialing of up to 1000 digits, or 100 locations, is also possible.

Relay transmission to E-mail (Onramp Gateway Transmission):

The DP120F/DP125F can serve as a relay station in relay transmission transactions to E-mail address end stations.

Offramp Gateway Transmission:

The DP120F/DP125F can be used as a Hub Station to forward E-mails from your client computer or Internet Fax machine to the any facsimiles through the public switched telephone network.

Error E-mail Transmission:

E-mails that cannot be printed by the machine can be forwarded to another E-mail address.

Supporting DSN (Delivery Status Notification):

Transmission result is retrieved from received DSN message and stored into Activity Report as a transmission report. This machine automatically print the DSN message.

Supporting MDN (Message Disposition Notification):

An MDN request is added in the mail header of E-mails. If the machine receives the image data which exceeds the capability of this machine, the machine responds with a failure in the MDN message back to the original sender.

Additional Functions:

Enables users to configure the FTP (File Transfer Protocol) login name and the password for TOSHIBA Viewer, the server address of the ImageVision2000/SmartLink, and frame type for the Novell communication.

Before Connecting the Machine to Internet

Before connecting to the network, read this section to understand the Internet Fax functions.

● POP and SMTP

The available functions depend on whether this machine is setup to use the POP or SMTP for retrieving E-mail from a mail server.

POP (Post Office Protocol) and SMTP (Simple Mail Transfer Protocol):

“SMTP” is a server protocol for sending E-mail messages between servers. Usually the E-mail systems that transfer E-mails over the Internet use SMTP to send messages from one server to another. Then the E-mail message can be retrieved with an E-mail client using either “POP” or “IMAP”. “POP” is a protocol used to retrieve E-mail from a mail server.

When this machine uses POP for the Receive Mode:

This machine works as a POP client. Similar to most e-mail applications, this machine uses POP for receiving an E-mail message and SMTP for sending an E-mail message.

When this machine uses SMTP for the Receive Mode:

This machine works as one of the mail servers. The machine can transfer an E-mail message in the SMTP transmission.

The following table shows the available functions according to the type of the protocols set for the Receive Mode.

| Fucntions | Receive Mode | |
|---|--------------|------|
| | POP | SMTP |
| Send a document as an E-mail | Yes | Yes |
| Automatic receiving of an E-mail | Yes | Yes |
| Manual receiving of an E-mail | Yes | No |
| One Touch Keys to E-mail | Yes | Yes |
| Abbreviated Dial Numbers to E-mail | Yes | Yes |
| Multi-address transmission to E-mail | Yes | Yes |
| Relay Transmission to E-mail (Onramp Gateway) | Yes | Yes |
| Offramp Gateway | No | Yes |
| Error E-mail Transmission | Yes | Yes |

If the use of the Offramp Gateway function is not necessary, it is recommended that the Receive Mode is set to “POP” because some settings will be required to be set on the mail server if the Receive Mode is set to “SMTP”. For more information about the Offramp Gateway function, see “OFFRAMP GATEWAY SETUP” on page 85.

● Precaution for Internet Transmission

Transmissions using the Internet Fax function are the same as E-mail transmissions. Before you start to use the Internet Fax function, it is recommended that you read this section and understand the precautions for Internet Transmission.

- The Internet Fax sends a document to the email server of Internet and it does not send via the PSTN alike regular facsimile transmissions.
- An error mail is sent back from the mail server when the E-mail document fails to be forwarded to the recipient.
- An error mail is sometimes not sent back even if the E-mail has failed.
- Internet transmission has low security. It is recommended that you use regular facsimile transmission when a confidential document is sent.
- It may take a considerable amount of time for the recipient to receive the document because of the line traffic in the Internet.
- If the document being transmitted has a large amount of data it may not be successfully sent due to the configuration of the E-mail Server.

● Confirmed E-mail Server

The following table shows the list of E-mail servers supported with the Internet Fax kit.

| | Server Name | Version |
|---|--------------------|--------------------------|
| 1 | Sendmail | 8.9.1 |
| | Qpopper | 3.0.2 |
| 2 | Sendmail | 8.9.3 |
| | Qpopper | 3.0.2 |
| 3 | Microsoft Exchange | 5.5 |
| 4 | Qmail | 1.03 |
| 5 | LotusDomino | 5.0.1a _(Intl) |

* Products names in this manual are the trademarks or registered trademarks of their respective companies.

NOTE:

The mail server listed above may, or may not be used depending on your environment.

Internet Fax Transmission Overview

The following is an overview of the various transmissions that can be performed using the Internet Fax function.

◆ Internet Fax to Internet Fax

The machine can send a document to another Internet Fax machine through the Internet or Intranet. The document is sent as an E-mail to the Internet Fax machine.

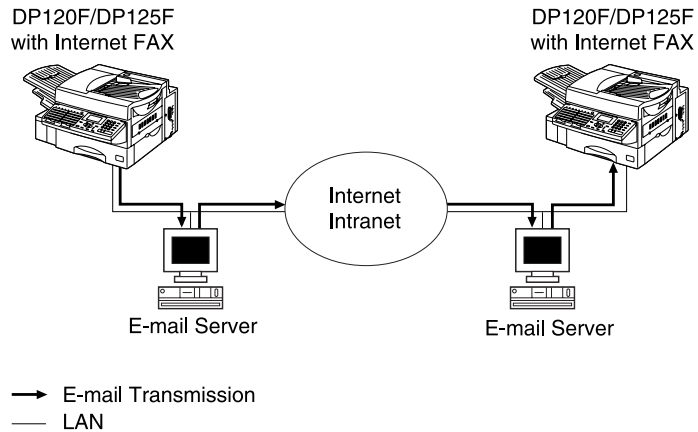

◆ Internet Fax to/from Client Computers

The machine can send a document to client computers through the Internet or Intranet. The client computers can send the E-mail to the machine as well.

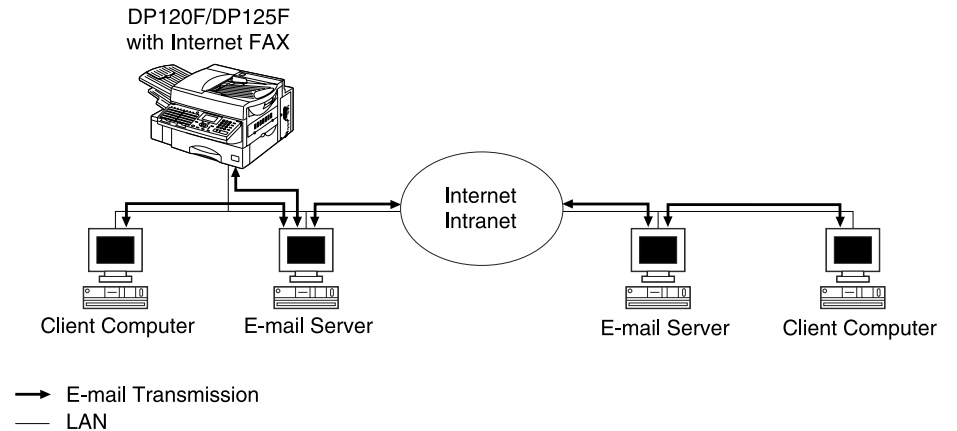

NOTE:

- The client computer receives TIFF-FX images when the machine sends a document using the Internet Fax function.
- The machine can only print out text files and TIFF-FX images. When sending E-mail from the client computer to this machine using the E-mail application, files other than text or TIFF-FX images cannot be sent.

Internet Fax Transmission Overview - continued

◆ Onramp Gateway Transmission

Using the Internet Fax function, E-mail addresses can be assigned to the ITU-T Mailbox in this machine. Therefore, ITU-T F-code compliant facsimiles can send documents to the ITU-T Mailbox in this machine and this machine can forward the received document to E-mail recipients assigned to the Mailbox using the relay function.

►P80 ONRAMP GATEWAY SETUP

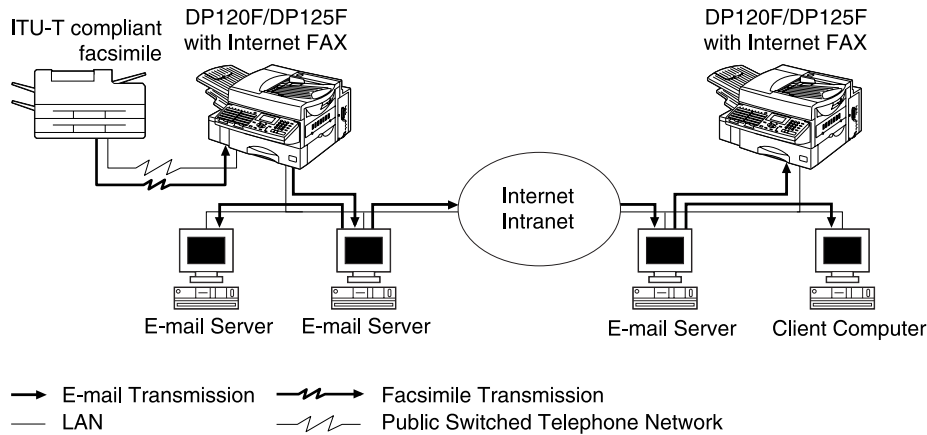

NOTE:

- Documents sent as an Internet Fax will be received as a TIFF-FX image on the client computer.

◆ Offramp Gateway Transmission

The machine can forward received E-mail documents to any facsimile through the public telephone line using Offramp Gateway transmission. If another Internet Fax machine or client computer sends a document to the Internet Fax machine through the Internet or Intranet, then the Internet Fax machine can forward the document to another facsimile through the public switched telephone network.

►P85 OFFRAMP GATEWAY SETUP

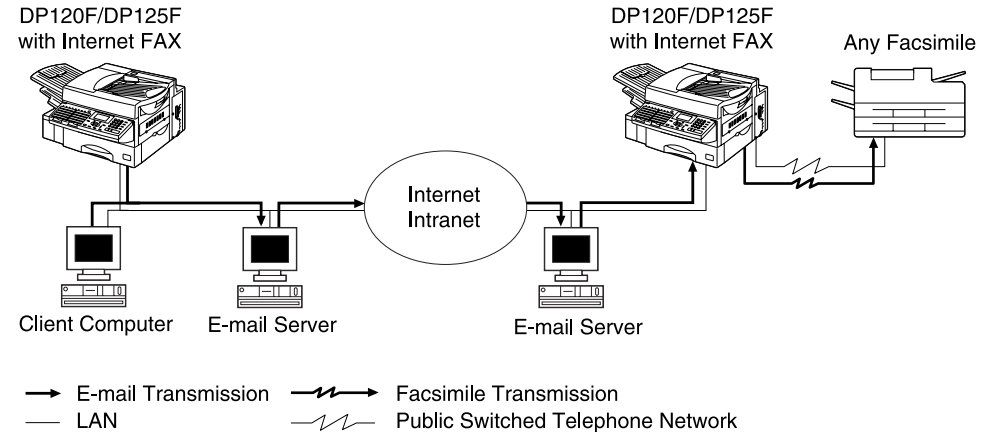

NOTE:

- To operate in this transmission, the machine must be set up to enable SMTP transmission. It is also required to configure the some settings on the mail server of your network.
- Documents sent as an Internet Fax will be received as a TIFF-FX image on the client computer.

- FACSIMILE UNIT DESCRIPTION

Rear View

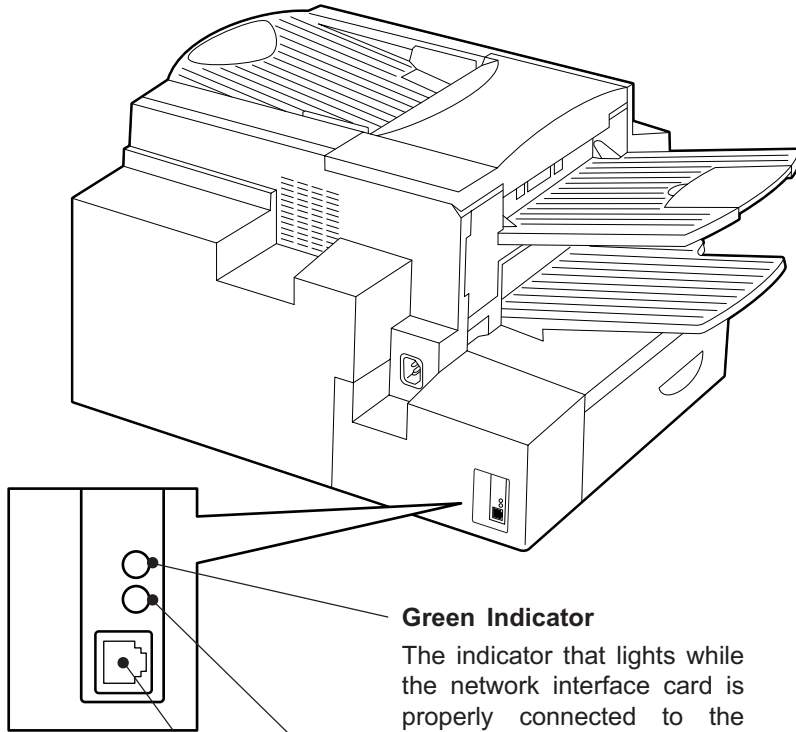

Green Indicator

The indicator that lights while the network interface card is properly connected to the network.

Amber Indicator

The indicator that blinks while data is being communicated.

10BASE-T/100BASE-TX I/F

Connection for the 10BASE-T or 100BASE-TX cable to an Ethernet network.

Operation Panel

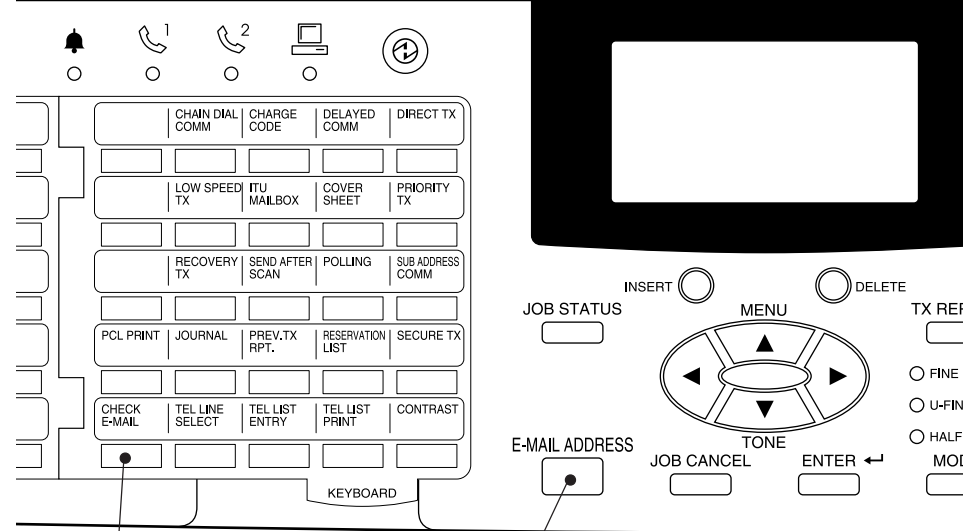

CHECK E-MAIL

Used to receive an E-mail immediately.

E-MAIL ADDRESS Key

Used to program E-mail addresses when programming One Touch Key or Abbreviated Numbers. By pressing this key prior to a transmission, an E-mail address can be entered for an Internet Fax transmission.

BASIC FUNCTIONS - RECEIVE E-MAIL

The methods to receive an E-mail vary according to the type of protocols used for receiving an E-mail.

When "POP" is selected for the Receive Mode, the following receiving methods are available:

- **Auto Receive**
The machine accesses the E-mail server at specified intervals to check whether any E-mail has been delivered. If an E-mail has been delivered, the machine will automatically retrieve and print out the E-mail.
- **Manual Receive**
When the CHECK E-MAIL button is pressed, the machine manually accesses the E-mail server to check whether any E-mail has been delivered. If an E-mail has been delivered, the machine receives and prints out the E-mail.

See "Receiving from SMTP Server" for SMTP transmission.

Printing of a received E-mail depends on the following settings:

- Print Text Body (See page 69)
- Body Page Limit (See page 70)
- Print Header (See page 72)
- Print E-mail Error (See page 73)

Users can set up these items to specify how the machine should perform when receiving an E-mail.

Available Format:

The machine can only print the TIFF-FX images and the text data. If the received E-mail contains files that are not the TIFF-FX images or text data, the machine will display an error message on the LCD Display.

However, the machine is able to print the E-mail except the parts in unknown format, or forward this E-mail to another E-mail address.

If you want to print the E-mail except the parts in unknown format, set up "Print E-mail Error" (See page 73).

If you want to forward the E-mail to another E-mail address when an error occurs, set up "Error E-mail Forward Address" (See page 61).

Automatic Receiving Mode

To automatically receive E-mails from the E-mail server, set up the "POP Time".

See the section "POP Time Setting" at "SETUP - E-MAIL ACCOUNT SETUP" (Page 64).

Manual Receiving Mode

To manually receive E-mails from the E-mail server, press:



```
CHECK E-MAIL
NOW SEARCHING
>
STOP TO CANCEL
```

">" mark moves from left to right. This mark continually moves until searching is completed.

When the E-mail has been received, the following screen appears and starts printing.

```
MAY-12-00 FRI11:59AM
RESIDUAL MEMORY 99%
PRINTING
```

When no E-mail has been received, the following screen appears.

```
MAY-12-00 FRI11:59AM
NO EXIST E-MAIL
```

If any other error messages are displayed, see "TROUBLE-SHOOTING."

Receiving from SMTP Server

Once an E-mail to this machine is delivered through the Internet, this machine will automatically retrieve E-mail from the SMTP server using the SMTP transmission.

When the Receive Mode is set to SMTP, the sub-domain for this machine must be assigned at the SMTP server to receive E-mail or enable the Offramp Gateway transmission. In this case, this machine works as one of the E-mail servers.

When the SMTP server receives an E-mail intended for the sub-domain of this machine, the SMTP server will transfer the E-mail to this machine using the SMTP transmission. If an E-mail is sent to the E-mail address of this Internet Fax machine, it will then print the E-mail out.

NOTE:

When the Receive Mode is set to SMTP, machine cannot retrieve an E-mail from the mail server manually.

Please refer to "OFFRAMP GATEWAY SETUP" on page 85 for further details.

Output Print Format for Receiving E-mail

When an Internet Fax message (or E-mail message) is received, the following output may be printed in addition to the originals (scanned data).

- Text Body
- Header

The Text Body and the Header of the received message is printed according to the settings of the E-mail properties on your machine.

● Text Body Output

This output is printed when the Print Text Body is set to ON or the E-mail has only the text body section and no attached image files.

►P69 SETUP - E-MAIL PROPERTIES SETUP - Print Text Body Setting

Sender name and address

Recipients Lists

Date and time of the E-mail message was sent

Subject of the E-mail message

Body of the message

```
From : "User01" <user01@toshiba.com>
To : <ifax@toshiba.com>
Cc :
Date : Fri, 2 Mar 2001 11:27:43 +0900
Subject : Internet Fax MAIL
```

```
An image data has been attached to this E-mail message
and image data is the Tiff file format.

You can see the attached message by Tiff viewer
such as the Imaging that is operated under the Windows 95, 98 or NT.
```

Output Print Format for Receiving E-mail - continued

● Header Output

This output is printed when the Print Header is set to ON.

►P72 SETUP - E-MAIL PROPERTIES SETUP - Print Header Setting

---- MAR-02-01 11:21 Received Mail ----

```
Received: from ttake02 (T_TAKE02 [192.1.4.35]) by marshal.toshiba.com with SMTP (Microsoft Exchange Internet Mail Service Version 5.5.2448.0)
id GDXCQP2K; Fri, 2 Mar 2001 11:23:18 +0900
Message-ID: <003601c0a2c0$65c7fe40$230401c0@ttake02>
From: "User01" <user01@toshiba.com>
To: <ifax@toshiba.com>
References: <200103025094228.31@ifxa.toshibatec.com>
Subject: Internet Fax MAIL
Date: Fri, 2 Mar 2001 11:27:43 +0900
MIME-Version: 1.0
Content-Type: multipart/mixed;
    boundary="====_NextPart_000_0033_01COA30B.CC9EC9A0"
X-Priority: 3
X-MSMail-Priority: Normal
X-Mailer: Microsoft Outlook Express 5.00.2314.1300
X-MimeOLE: Produced By Microsoft MimeOLE V5.00.2314.1300
```

This is a multi-part message in MIME format.

- SEND E-MAIL

The machine can send an E-mail using the following methods.

- **Direct Input**
Input the E-mail address directly to send a document.
- **Search E-mail Address**
Search an E-mail address from the local phonebook and histories to send a document.
- **One Touch Dialing**
Send a document to the E-mail address that is assigned to a One Touch key.
- **Abbreviated Dialing**
Send a document to the E-mail address that is assigned to an Abbreviated Dial Number.
- **Group Broadcast Transmission**
Send a document to E-mail addresses and fax numbers that are assigned to Group Number. The E-mail addresses and the fax numbers can be assigned to a Group Number, so that this feature allows you to send a document to multiple remote parties that included both E-mail addresses and fax numbers in a single operation. To operate this dial method, refer to the DP120F/DP125F Operator's Manual.
- **Multi-key Quick Broadcast Transmission**
This Multi-key Quick Broadcast Transmission allows you to send a document to a combination of the following numbers without pre-programming a group. By using this method, you can send a document to both E-mail addresses and fax numbers in a single operation.
 - Abbreviated Dial Numbers
 - One Touch Dial Keys
 - Search E-mail Address
 - Direct Input

When the document is sent to an E-mail address, the document is converted to TIFF-FX images.

E-mail Notification Reports printed after sending an E-mail

- **DSN Report** is printed when "Print DSN" is set to ON and the mail server successfully replied to your DSN request. See "DSN Report" on page 95 for a sample and descriptions.
- **MDN Report** is printed when "Print Disposition" is set to ON and the recipient successfully received your mail to reply to your MDN request. See "MDN Report" on page 96 for a sample and descriptions.
- **Alert Report** is printed when "Confirm. Timer" is set to ON and the machine cannot successfully receive the MDN requested from a recipient. See "Alert Report" on page 97 for a sample and descriptions.

These are printed according to the E-mail properties and the environments of the recipients. For further details of related E-mail properties settings, see "E-MAIL PROPERTIES SETUP" on page 68.

Sending E-mail by Direct Input

1 Display INTERNET-FAX SEND Menu

Press:

E-MAIL ADDRESS



PRESS SPEED DIAL,
ONE TOUCH KEY OR
ENTER TO ENTER
E-MAIL ADDRESS

Then press:

ENTER ↵



INTERNET-FAX SEND

E-MAIL ADDRESS :



2 Enter the E-mail address

Enter the E-mail address using the Keyboard and the Dial Keypad.

INTERNET-FAX SEND

E-MAIL ADDRESS :
xx@toshiba.com

When the E-mail address is displayed correctly on the LCD display, press:

ENTER ↵



DO YOU KNOW RECEIVER
RESOLUTION?

- 1 . YES
- 2 . NO

Sending E-mail by Direct Input - continued

3 Select the Resolution

This setting will allow you to specify the resolution for the documents you are sending, if you know the resolution capability of the recipient machine.

If you know the resolution capability of the recipient machine, press:

1

If you do not know the resolution capability of the recipient machine, press:

2

When "1.YES" is selected, the following screen appears. Continue to Step 3a.

PRESS MODE KEY
ON CONTROL PANEL
THEN PRESS ENTER

When "2.NO" is selected, the following screen appears. Skip to Step 5.

3a Resolution Setting

Press until the required resolution mode is indicated by the appropriate LED.

- : illuminated
- : extinguished

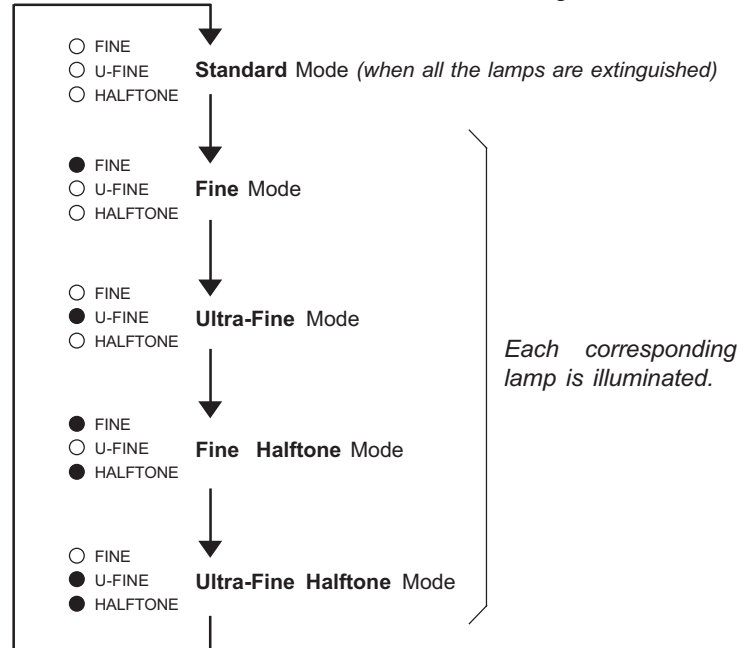

- * When Ultra-Fine is selected, the DF120F/DP125F will scan all documents at 406 dots/inch horizontal x 391 lines/inch vertical. Depending on the capabilities of the remote facsimile receiving this document, the document may be transmitted by the DF120F/DP125F at Ultra-Fine resolution (406 dots/inch horizontal x 391 lines/inch vertical) or it may be transmitted at Super Fine (203 dots/inch horizontal x 391 lines/inch vertical).

Then press:

ENTER

DO YOU KNOW RECEIVER
COMPRESSION?
1 . YES
2 . NO

Sending E-mail by Direct Input - continued

4 Select the Compression

This setting will allow you to specify the compression for the documents you are sending, if you know the compression capability of the recipient machine.

If you know the compression capability of the recipient machine, press:

1

If you do not know the compression capability of the recipient machine, press:

2

When "1.YES" is selected, the following screen appears. Continue to Step 3a.

```
COMPRESSION
1 .MH
2 .MR
3 .MMR
```

4 .JBIG

These items are outside the LCD frame. To view them, use the [▼] scroll key.

When "2.NO" is selected, the following screen appears. Skip to Step 5.

4a Compression Setting

Select the desired Compression.
Press:

1

(for MH)

2

(for MR)

3

(for MMR)

4

(for JBIG)

NOTE:

If you do not know the receiver's capabilities for the compression type, select "MH".

5 Scan the document

Your machine will automatically start scanning the document into memory (if enabled).

```
SCANNING INTO MEMORY
FILE NUMBER= 007
RESIDUAL MEMORY 98%
SCANNING PAGE : 003
```

After scanning, the machine starts transmission.

If the document is not loaded in the Document Tray, the following screen is displayed.

```
LOAD DOCUMENT
```

Load the document in the Document Tray. Then your machine will automatically start scanning the document.

Sending E-mail by Searching E-mail Addresses

1 Display the SPEED DIAL Menu

Press:

E-MAIL ADDRESS



PRESS SPEED DIAL,
ONE TOUCH KEY OR
ENTER TO ENTER
E-MAIL ADDRESS

Then press:

SPEED DIAL



SPEED DIAL
1 . ABB . NUMBERS
2 . SPEED DIAL

2 Select SPEED DIAL

Press:



1 . LOCAL ADDRESS
2 . RECEPTION HISTORY
3 . SENT HISTORY

3 Searching for an E-mail address

This operation searches for an E-mail address and sends the documents to the E-mail address.

You can search for an E-mail address in the following categories.

Local Addresses:

You can search for an E-mail address that is assigned to Abbreviated Dial Numbers or One Touch Dial Keys.

Reception History:

You can search for an E-mail address which the machine has received the E-mails from.

Sent History:

You can search for an E-mail address that the machine has sent the E-mails to.

3a Select the search category

To select the Local Addresses, press:



To select the Reception History, press:



To select the Sent History, press:



When "1.LOCAL ADDRESSES" is selected, the following screen appears. Continue to the next step.

1 . SEARCH NAME
2 . SEARCH E-MAIL ADDR
3 . ALL

When "2.RECEPTION HISTORY" is selected, the following screen appears. Skip to Step 3c.

RECEPTION HISTORY
NOW SEARCHING

Searching ends.

RECEPTION HISTORY
[STOP] :TO PREVIOUS
001@toshiba.com
[↑↓] 00001/00050

When "2.RECEPTION HISTORY" is selected but no E-mail addresses are in the list, the display indicates the following screen and returns to the first screen in this step.

RECEPTION HISTORY
E-MAIL ADDRESS :

After 2 seconds:

1 . LOCAL ADDRESSES
2 . RECEPTION HISTORY
3 . SENT HISTORY

Sending E-mail by Searching E-mail Addresses - continued

3 Searching for an E-mail address - continued

3a Select the search category - continued

When "3.SENT HISTORY" is selected, the following screen appears. Skip to Step 3d.

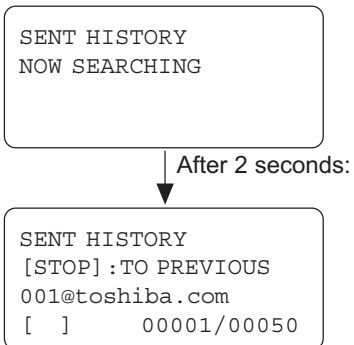

When "3.SEND HISTORY" is selected but no E-mail addresses are in the list, the display indicates the following screen and returns to the first screen in this step.

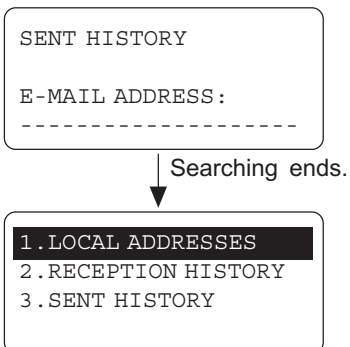

3b Search from Local Addressess

You can search for an E-mail address from the Local Addresses using the following method.

Search Name:

You can search for an E-mail address by the ID name.

Search E-mail Addr:

You can search for an E-mail address by its specific address.

All:

You can list all E-mail addresses that have been registered as Abbreviated Dial Numbers and One Touch Dial Keys.

3b-1 Select the search method

To select Search Name, press:

1

To select Search E-mail Addr, press:

2

To select All, press:

3

When "1.SEARCH NAME" is selected, the following screen appears. Continue to the next step.

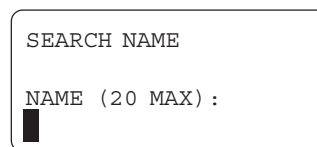

When "2.SEARCH E-MAIL ADDR" is selected, the following screen appears. Skip to Step 3b-4.

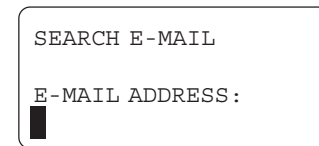

When "3.ALL" is selected, the following screen appears. Skip to Step 3b-6.

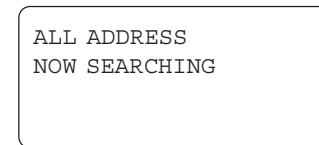

After 2 seconds:

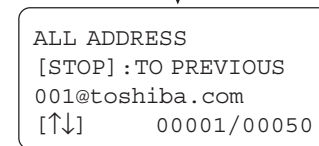

When "3.ALL" is selected but no E-mail address can be matched, the display indicates the following screen and returns to the first screen in this step.

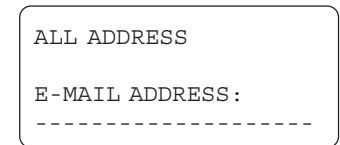

After 2 seconds:

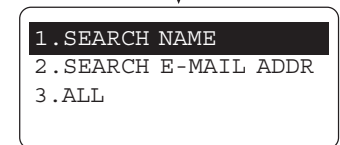

Sending E-mail by Searching E-mail Addresses - continued

3 Searching for an E-mail address - continued

3d Search from Local Addressess - continued

3b-2 Enter the Search Name

Enter the character(s) associated with the ID name of Abbreviated Dial Numbers or One Touch Dial Keys using the Keyboard and the Dial Keypad.

```
SEARCH NAME
NAME (20 MAX):
Toshiba█
```

Then press: 

The machine starts to search the ID names.

```
SEARCH NAME
NOW SEARCHING
NAME (20 MAX):
toshiba
```

Searching ends.

```
SEARCH NAME
[STOP]:TO PREVIOUS
New York Toshiba
[↑↓] 00001/00015
```

3b-3 Select the ID Name

Locate the screen of the desired ID name using the following scroll keys.



(for the previous screen)



(for the next screen)

```
SEARCH NAME
[STOP]:TO PREVIOUS
001
[↑↓] 00001/00015
```

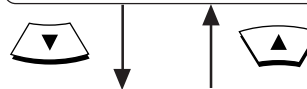

```
SEARCH NAME
[STOP]:TO PREVIOUS
002
[↑↓] 00002/00015
```

Then press: 

Skip to Step 4.

3b-4 Enter the Search E-mail Address

Enter the character(s) associated with the E-mail address assigned to Abbreviated Dial Numbers or One Touch Dial Keys using the Keyboard and the Dial Keypad.

```
SEARCH E-MAIL
E-MAIL ADDRESS:
toshiba█
```

Then press: 

The machine starts to search the E-mail addresses.

```
SEARCH E-MAIL
NOW SEARCHING
E-MAIL ADDRESS:
toshiba
```

Searching ends.

```
SEARCH E-MAIL
[STOP]:TO PREVIOUS
001@toshiba.com
[↑↓] 00001/00015
```

NOTE:

The machine searches all E-mail addresses that include the search name entered and applicable to the case.

When no E-mail address can be matched, the display indicates the following screen and returns to the first screen in this step.

```
SEARCH E-MAIL
E-MAIL ADDRESS:
-----
```

After 2 seconds:

```
SEARCH E-MAL
E-MAIL ADDRESS:
Toshiba
```

NOTE:

The machine searches all ID names that include the search name entered and applicable to the case.

When no ID name can be matched, the display indicates the following screen and returns to the first screen in this step.

```
SEARCH NAME
NAME (20 MAX):
-----
```

After 2 seconds:

```
SEARCH NAME
NAME (20 MAX):
Toshiba
```

Sending E-mail by Searching E-mail Addresses - continued

3 Searching for an E-mail address - continued

3b Search from Local Adresses - continued

3b-5 Select the E-mail address

Locate the screen of the desired E-mail address using the following scroll keys.



(for the previous screen)



(for the next screen)

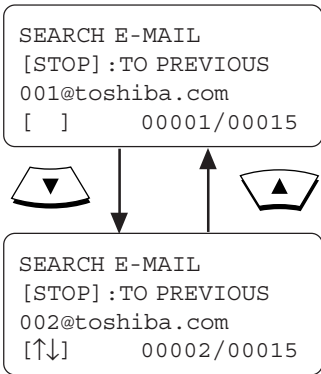

Then press:

Skip to Step 4.

3b-6 Select the E-mail address

Locate the screen of the desired E-mail address using the following scroll keys.



(for the previous screen)



(for the next screen)

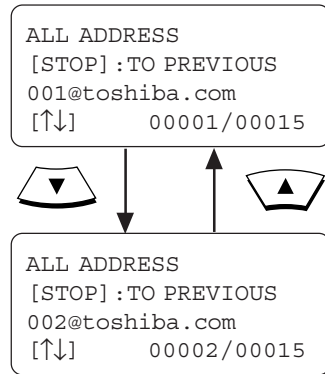

Then press:

Skip to Step 4.

3c Select from Reception History

Locate the screen of the desired E-mail address using the following scroll keys.



(for the previous screen)



(for the next screen)

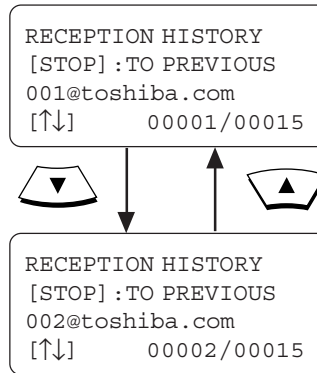

Then press:

Skip to Step 4.

3c Select from Sent History

Locate the screen of the desired E-mail address using the following scroll keys.



(for the previous screen)



(for the next screen)

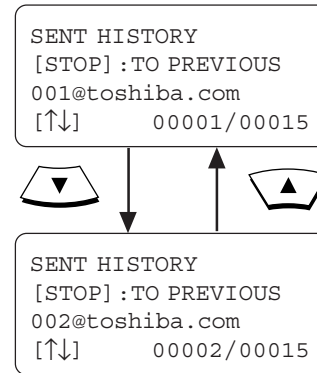

Then press:

Skip to Step 4.

4 Scan the document

Your machine will automatically start scanning the document into memory (if enabled).

```
SCANNING INTO MEMORY
FILE NUMBER=      007
RESIDUAL MEMORY  98%
SCANNING PAGE :  003
```

After scanning, the machine starts transmission.

If the document is not loaded in the Document Tray, the following screen is displayed.

LOAD DOCUMENT

Load the document in the Document Tray. Then your machine will automatically start scanning the document.

Sending E-mail by One Touch Dialing

If you have assigned an E-mail address to a One Touch key, you can send a document to the E-mail address by pressing the corresponding One Touch key.

1 One Touch Dialing for E-mail

Press:

E-MAIL ADDRESS



PRESS SPEED DIAL,
ONE TOUCH KEY OR
ENTER TO ENTER
E-MAIL ADDRESS

Then select the desired One Touch key from 01 to 73.

Example: One Touch key 01



The One Touch key number and the ID name appear on the LCD display for about 2 seconds.

ONE TOUCH= 01
NEWYORK OFFICE

NOTE:

When the One Touch key pressed is not programmed with an E-mail address, the message "NUMBER NOT LISTED" is displayed for 2 seconds and then the display returns to the Standby Mode.

2 Scan the document

Your machine will automatically start scanning the document into memory (if enabled).

SCANNING INTO MEMORY
FILE NUMBER= 007
RESIDUAL MEMORY 98%
SCANNING PAGE : 003

After scanning, the machine starts transmission.

If the document is not loaded in the Document Tray, the following screen is displayed.

LOAD DOCUMENT

Load the document in the Document Tray. Then your machine will automatically start scanning the document.

Sending E-mail by Abbreviated Dialing

If you have assigned an E-mail address to an Abbreviated Dial Number, you can send a document to the E-mail address by entering the corresponding Abbreviated Dial Number.

1 Display the SPEED DIAL Menu

Press:

E-MAIL ADDRESS



PRESS SPEED DIAL,
ONE TOUCH KEY OR
ENTER TO ENTER
E-MAIL ADDRESS

Then press:

SPEED DIAL



SPEED DIAL
1 . ABB. NUMBERS
2 . SPEED DIAL

2 Select ABB. NUMBERS

Press:



ABB. NUMBER = (1-999)

3 Enter the ABB. Number

Enter the Abbreviated Dial Number (1 to 999) assigned to the desired destination.

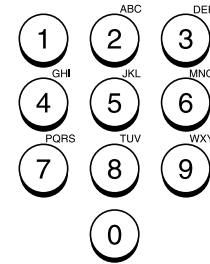

NOTE:

When an incorrect number is entered, use to delete preceding digits, or press once to start over.

Example of Abbreviated Dial Number, 10:

ABB. NUMBER = (1-999)
10

4 Press the START Key Tray

When the correct number is displayed, press:

START



The One Touch key or Abbreviated Dial Number and the name of the party will appear on the LCD display for about 2 seconds.

ABB. NUMBER= 10
LONDON OFFICE

NOTE:

When the number entered (within the range of 1 through 999) is not programmed with an E-mail address, the message "NOT AN EMAIL ADDRESS" is displayed for 2 seconds and then the display returns to the Standby Mode.

Sending E-mail by Abbreviated Dialing - continued

5 Scan the document

Your machine will automatically start scanning the document into memory (if enabled).

```
SCANNING INTO MEMORY
FILE NUMBER=      007
RESIDUAL MEMORY  98%
SCANNING PAGE :  003
```

After scanning, the machine starts transmission.

If the document is not loaded in the Document Tray, the following screen is displayed.

```
LOAD DOCUMENT
```

Load the document in the Document Tray. Then your machine will automatically start scanning the document.

Multi-Key Quick Broadcast Transmission

This Multi-key Quick Broadcast Transmission allows you to send a document to a combination of the following numbers without pre-programming a group.

- Abbreviated Dial Numbers
- One Touch Dial Keys
- Search E-mail Address
- Direct Input

NOTE:

By using this method, you can send a document to both E-mail addresses and fax numbers in a single operation. To send a document to fax number using this feature, refer to the DP120F/DP125F Operator's Manual.

1 Load the Document

Load the document face down in the Document Tray.

MAY-17-00 WED11:49

RESIDUAL MEMORY 100%
ENTER TEL NUMBER

2 Press the MULTI Key

Press:



MULTI GROUP 000
ENTER TEL NUMBER,
E-MAIL, SPEED DIAL
OR ONE TOUCH KEY

Press:



PRESS SPEED DIAL,
ONE TOUCH KEY OR
ENTER TO ENTER
E-MAIL ADDRESS

3 Enter the E-mail Address

Enter the E-mail address of the remote party using any of the four dialing methods.

- One Touch Key Dialing ... See page 19
- Abbreviated Dialing ... See page 20
- Search E-mail Address ... See page 15
- Direct Input ... See page 12

Repeat this step until the facsimile numbers of all the desired remote parties are entered.

When the E-mail addresses of all the desired remote parties are entered, go to Step 5.

To cancel or modify the E-mail addresses already being programmed to a Manual Group Dial, go to Step 4.

A screen like the one below is displayed.

MULTI GROUP 000
ABB NBR= 154
INFORMATION BUREAU

After 2 seconds:

MULTI GROUP 001
[↑] TO PREVIOUS
ENTER MORE OR
PRESS [START]

NOTE:



If you select the same entry twice, you are prompted to delete or retain that second entry.

Multi-Key Quick Broadcast Transmission - continued

4 Select the CANCEL or MODIFY Facsimile Number

5 Press the START Key

You can cancel or modify the Manual Group Dial Number registered in this facsimile.

Select the number you want to delete or modify using  or , and press:

ENTER 

```
MULTI GROUP
1.CANCEL
2.MODIFY
3.RETAIN
```

To select "1.CANCEL," go to Step 4a.

To select "2.MODIFY," go to Step 4b.

To select "3.RETAIN," go to Step 4c.

4a Cancel the Existing Number

To cancel the existing number, press:

1
(to CANCEL)

```
MULTI GROUP
ABB NBR=          154
CANCELLED
```

Return to Step 3.

4b Modify the Existing Number

To modify the existing number, press:

2
(to MODIFY)

```
MULTI GROUP
ABB.NUMBER= (1-999)
```

Go to Step 3 for the E-mail address entry.

4c Retain the Existing Number

To retain the existing number, press:

3
(to RETAIN)

```
MULTI GROUP      001
[↑] TO PREVIOUS
ENTER MORE
OR PRESS START
```

Return to Step 3.

Press:

START



```
SCANNING INTO MEMORY
JOB NUMBER=      002
FREE MEMORY :   98%
SCANNING PAGE : 003
```

When document scanning is completed:

Standby Mode screen

- AUTOMATIC TELEPHONE DIALING REGISTRATION

E-mail addresses can be assigned to Abbreviated Dial Numbers and One Touch Keys. The numbers are used for Abbreviated Dial E-mail transmission, One Touch E-mail transmission, and Group E-mail transmission. Once the addresses are assigned, the following features allow you to send documents to frequently sent addresses by pressing a few keys.

- **Abbreviated Dial Numbers**

This machine can store up to 300 E-mail addresses and 16-digit facsimile numbers with associated 20-character ID names. This information is stored into Abbreviated Dial Numbers labeled from 001 to 999.

- **One Touch Keys**

This machine can store up to 73 E-mail addresses and 16-digit facsimile numbers with associated 20-character ID names. This information is stored into One Touch Dial Numbers labeled from 01 to 99.

- **Group Numbers**

This machine can store up to 50 Broadcast Groups of Abbreviated Dial Numbers and One Touch Dial keys with associated 20-character location ID names. This information is stored into One Touch Dial Numbers labeled from 0001 to 1999.

Important Note:

The total number of available destinations will vary depending upon the amount of information stored in each Abbreviated Dial Number, One Touch Key, and Group Number.

You can register an E-mail address as an Abbreviated Dial Number or a One Touch Key by:

- Directly entering an E-mail address.
- Searching an E-mail address that has already been stored in the Abbreviated Dial Numbers or One Touch Keys or from the send/receive histories, and modifying it.

Abbreviated Dialer Registration

1 Display the TEL LIST ENTRY Menu

View the "50-73" Flip Panel to select the desired Function Key.

Press:



```
TEL LIST ENTRY
1 . ABB. NUMBERS
2 . GROUP NUMBERS
3 . ONE TOUCH KEYS
```

2 Display the ABB. NUMBERS Menu

To select "ABB. NUMBERS", press:



```
ENTER ABB. NUMBER
OR PRESS
[BACK] : TO PREVIOUS
[STOP] : TO COMPLETE
```

Upon entering the first number:

```
ABB. NUMBER ENTRY

ABB. NUMBER = (1-999)
1
```

Abbreviated Dialer Registration - continued

3 Enter an ABB. Dial Number

Enter an Abbreviated Dial Number from 1 to 999.

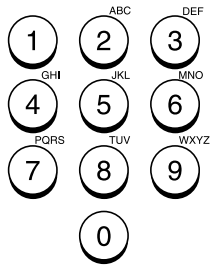

Make sure that the 3-digit number (001 to 999) appears correctly, then press:



NOTE:

Any leading zero (0) can be omitted from the Abbreviated Dial Number.

If the ABB. Dial Number you entered has not been previously registered, the following screen will be displayed. Skip to Step 5.

```
ABB. NBR=      001
ID NAME = (MAX20)
```

After 2 seconds:

```
ENTER NAME
ID NAME = (MAX20)
```

If the ABB. Dial Number you entered has been previously registered, continue to the next step.

4 When a Preset ABB. Dial Number is Active

If the selected Abbreviated Dial Number has been previously registered, the following information will be displayed on the LCD display.

```
ABB. NUMBER ENTRY
ALREADY ASSIGNED
ABB. NUMBER = 001
NEW YORK OFFICE
```

After 2 seconds:

```
ABB. NUMBER ENTRY
1. CANCEL
2. MODIFY
3. RETAIN
```

See the section "Modify/Delete the Abbreviated Dial Number" and continue the operation.

5 Enter the Location ID Name

Enter the Location ID name of the remote party to be assigned to the current Abbreviated Dial Number.

When the name is displayed correctly on the LCD display, press:



```
ABB. NBR=      001
1. TEL NUMBER
2. E-MAIL
```

6 Select the type

To register an E-mail address for the Abbreviated Dial Number, Press:

2

```
PRESS SPEED DIAL FOR
ADDRESS SEARCH OR
ENTER TO ENTER
E-MAIL ADDRESS
```

If the E-mail address is already assigned to this Abbreviated Dial Number, the following screen appears.

```
E-MAIL ADDRESS
ALREADY ASSIGNED

001@toshiba.com
```

After 2 seconds:

```
E-MAIL ADDRESS
1. CANCEL
2. MODIFY
3. RETAIN
```

See the section "Modify/Delete the Abbreviated Dial Number" and continue the operation.

Abbreviated Dialer Registration - continued

7 Select the input E-mail address method

To input an E-mail address directly, press:



To input an E-mail address by modifying the searched E-mail address, press:



When is pressed, the ENTER E-MAIL ADDRESS screen appears. Skip to Step 10.

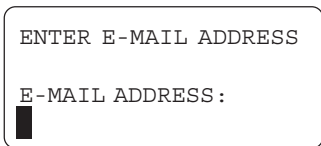

When is pressed, the following screen appears. Continue to the next step.

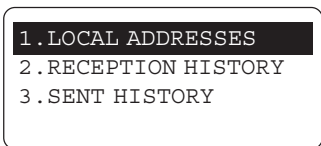

8 Searching for an E-mail address

This operation is to search an E-mail address and modify it to a new E-mail address.

You can search an E-mail address in the following categories.

Local Addresses:

You can search an E-mail address that is assigned to Abbreviated Dial Numbers or One Touch Dial Keys.

Reception History:

You can search an E-mail address which the machine has received E-mails from.

Sent History:

You can search an E-mail address which the machine has sent the E-mails to.

8a Select the search category

To select the Local Addresses, press:



To select the Reception History, press:



To select the Sent History, press:



When "1.LOCAL ADDRESSES" is selected, the following screen appears. Continue to the next step.

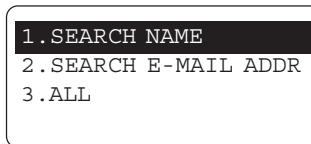

When "2.RECEPTION HISTORY" is selected, the following screen appears. Skip to Step 8c.

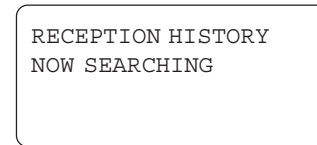

Searching ends.

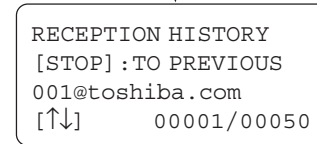

When "2.RECEPTION HISTORY" is selected but no E-mail address can be matched, the display indicates the following screen and returns to the first screen in this step.

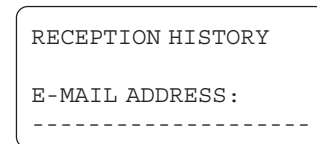

After 2 seconds:

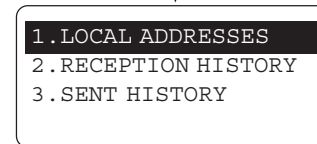

When "3.SENT HISTORY" is selected, the following screen appears. Skip to Step 8d.



Searching ends.

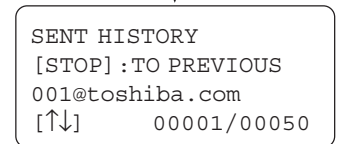

When "3.SENT HISTORY" is selected but no E-mail address can be matched, the display indicates the following screen and returns to the first screen in this step.

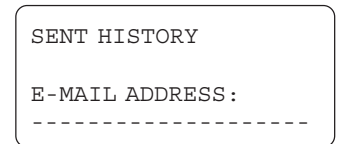

After 2 seconds:

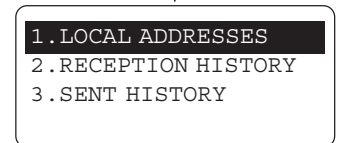

Abbreviated Dialer Registration - continued

8 Searching for an E-mail address - continued

8b Search from Local Addresses

You can search an E-mail address from the Local Addresses using the following method.

Search Name:

You can search an E-mail address by the ID name.

Search E-mail Addr:

You can search an E-mail address by the specific address.

All:

You can list all E-mail addresses that have been registered as Abbreviated Dial Numbers and One Touch Dial Keys.

8b-1 Select the search method

To select Search Name, press:

1

To select Search E-mail Addr, press:

2

To select All, press:

3

When "1.SEARCH NAME" is selected, the following screen appears. Continue to the next step.

```
SEARCH NAME
NAME (20 MAX):
█
```

When "2.SEARCH E-MAIL ADDR" is selected, the following screen appears. Skip to Step 8b-4.

```
SEARCH E-MAIL
E-MAIL ADDRESS:
█
```

When "3.ALL" is selected, the following screen appears. Skip to Step 8b-6.

```
ALL ADDRESS
NOW SEARCHING
```

After 2 seconds:

```
ALL ADDRESS
[STOP] :TO PREVIOUS
001@toshiba.com
[↑↓] 00001/00050
```

When "3.ALL" is selected but no E-mail address can be matched, the display indicates the following screen and returns to the first screen in this step.

```
ALL ADDRESS
E-MAIL ADDRESS:
-----
```

After 2 seconds:

```
1 . SEARCH NAME
2 . SEARCH E-MAIL ADDR
3 . ALL
```

Abbreviated Dialer Registration - continued

8 Searching for an E-mail address - continued

8d Search from Local Addresses - continued

8b-2 Enter the Search Name

Enter the character(s) associated with the ID name of Abbreviated Dial Numbers or One Touch Dial Keys using the Keyboard and the Dial Keypad.

```
SEARCH NAME
NAME (20 MAX) :
00
```

Then press: 

The machine starts to search the ID names.

```
SEARCH NAME
NOW SEARCHING
NAME (20 MAX) :
00
```

Searching ends.

```
SEARCH NAME
[STOP] :TO PREVIOUS
001
[↑↓] 00001/00015
```

NOTE:

The machine searches all ID names that include the search name entered and applicable to the case.

When no ID name can be matched, the display indicates the following screen and returns to the first screen in this step.

```
SEARCH NAME
NAME (20 MAX) :
-----
```

After 2 seconds:

```
SEARCH NAME
NAME (20 MAX) :
00
```

8b-3 Select the Search Name

Locate the screen of the desired ID name using the following scroll keys.



(for the previous screen)



(for the next screen)

```
SEARCH NAME
[STOP] :TO PREVIOUS
001
[↑↓] 00001/00015
```

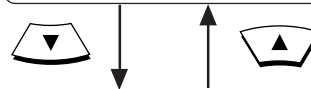

```
SEARCH NAME
[STOP] :TO PREVIOUS
002
[↑↓] 00002/00015
```

Then press: 

Skip to Step 9.

8b-4 Enter the Search E-mail Address

Enter the character(s) associated with the E-mail address assigned in Abbreviated Dial Numbers or One Touch Dial Keys using the Keyboard and the Dial Keypad.

```
SEARCH E-MAIL
E-MAIL ADDRESS :
toshiba
```

Then press: 

The machine starts to search the E-mail addresses.

```
SEARCH E-MAIL
NOW SEARCHING
E-MAIL ADDRESS :
toshiba
```

Searching ends.

```
SEARCH E-MAIL
[STOP] :TO PREVIOUS
001@toshiba.com
[↑↓] 00001/00015
```

NOTE:

The machine searches all E-mail addresses that include the search name entered and applicable to the case.

When no E-mail address can be matched, the display indicates the following screen and returns to the first screen in this step.

```
SEARCH E-MAIL
E-MAIL ADDRESS :
-----
```

After 2 seconds:

```
SEARCH E-MAL
E-MAIL ADDRESS :
toshiba
```

Abbreviated Dialer Registration - continued

8 Searching for an E-mail address - continued

8b Search from Local Addresses - continued

8b-5 Select the E-mail address

Locate the screen of the desired E-mail address using the following scroll keys.

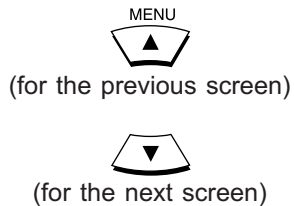

```
SEARCH E-MAIL  
[STOP] :TO PREVIOUS  
001@toshiba.com  
[↑↓] 00001/00015
```



```
SEARCH E-MAIL  
[STOP] :TO PREVIOUS  
002@toshiba.com  
[↑↓] 00002/00015
```

Then press:

Skip to Step 9.

8b-6 Select the E-mail address

Locate the screen of the desired E-mail address using the following scroll keys.

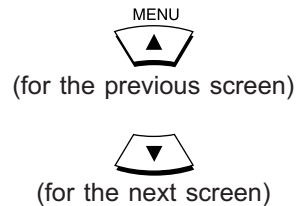

```
ALL ADDRESS  
[STOP] :TO PREVIOUS  
001@toshiba.com  
[↑↓] 00001/00015
```



```
ALL ADDRESS  
[STOP] :TO PREVIOUS  
002@toshiba.com  
[↑↓] 00002/00015
```

Then press:

Skip to Step 9.

8c Select from Reception History

Locate the screen of the desired E-mail address using the following scroll keys.

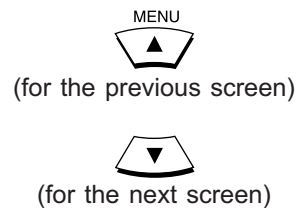

```
RECEPTION HISTORY  
[STOP] :TO PREVIOUS  
001@toshiba.com  
[↑↓] 00001/00015
```



```
RECEPTION HISTORY  
[STOP] :TO PREVIOUS  
002@toshiba.com  
[↑↓] 00002/00015
```

Then press:

Skip to Step 9.

8c Select from Sent History

Locate the screen of the desired E-mail address using the following scroll keys.

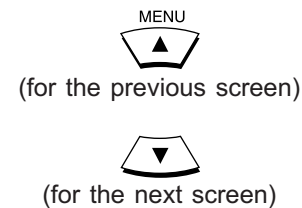

```
SENT HISTORY  
[STOP] :TO PREVIOUS  
001@toshiba.com  
[↑↓] 00001/00015
```

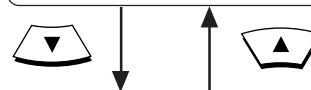

```
SENT HISTORY  
[STOP] :TO PREVIOUS  
002@toshiba.com  
[↑↓] 00002/00015
```

Then press:

Skip to Step 9.

9 Enter the E-mail address

Enter or modify the E-mail address to be assigned to the current Abbreviated Dial Number using the Keyboard and the Dial Keypad.

```
ENTER E-MAIL ADDRESS  
  
E-MAIL ADDRESS :  
001@toshiba.com
```

When the E-mail address is displayed correctly on the LCD display, press:

ENTER

```
DO YOU KNOW RECEIVER  
CAPABILITY?  
1 . YES  
2 . NO
```

Abbreviated Dialer Registration - continued

10 Select Receiver Capability

This setting will allow you to specify one or more following Receiver Capabilities for the Abbreviated Dial Number you are registering, if you know the capabilities of the recipient machine.

Resolution:

Selected to specify the resolution of images to be sent. This resolution is set to "200x200" as a default setting.

Compression:

Selected to specify the type of compression applied to images to be sent.

10a Select the Receiver Capability

If you know the capability of the recipient machine, press:

1

If you do not know the capability of the recipient machine, press:

2

When "1.YES" is selected, the following screen appears. Continue to the next step.

```
RECEIVER CAPABILITY
1 . DONE
2 . RESOLUTION
3 . COMPRESSION
```

When "2.NO" is selected, the following screen appears. Skip to Step 11.

```
E-MAIL OPTIONS?
1 . YES
2 . NO
```

10b Resolution Setting

To designate a specific resolution of the documents sent to this E-mail address, select RESOLUTION by pressing:

2

```
RESOLUTION
1 . 200x100
2 . 200x200
3 . 200x400
```

4 . 400x400
These items are outside the LCD frame. To view them, use the [▼] scroll key.

Select the desired Resolution. Press:

1

(for 200x100)

2

(for 200x200)

3

(for 200x400)

4

(for 400x400)

The display returns to the first screen in Step 10. Select the next option. If you have set up the Receiver Capability, Skip to Step 10d.

Abbreviated Dialer Registration - continued

10 Select Receiver Capability - continued

10c Compression Setting

To designate a specific compression of the documents sent to this E-mail address, select **COMPRESSION** by pressing:

3

```
COMPRESSION
1 .MH
2 .MR
3 .MMR
```

4 .JBIG

These items are outside the LCD frame. To view them, use the [▼] scroll key.

NOTE:

If you do not know the receiver's capabilities for the compression type, select "MH".

Select the desired Compression. Press:

1

(for MH)

2

(for MR)

3

(for MMR)

4

(for JBIG)

The display returns to the first screen in Step 10. If you have done so to set up the Receiver Capability, Skip to Step 10d.

10d Complete the Receiver Capability Setup

If you have completed the desired Receiver Capability setting for this Abbreviated Dial Number, select **DONE** by pressing:

1

```
E-MAIL OPTIONS?
```

```
1 .YES
```

```
2 .NO
```

11 Select E-mail Options

This setting will allow you to specify one or more following E-mail Options for the Abbreviated Dial Number you are registering.

Delayed Communication:

Default=off

Selected to program a transmission start time.

Confirmation Report:

Default=off

Selected to print a confirmation report after each transmission.

11a Select the E-mail Options

To set up the E-mail Options, press:

1

To skip the E-mail Options, press:

2

When "1.YES" is selected, the following screen appears. Continue to the next step.

```
E-MAIL OPTIONS
```

```
1 .DONE
```

```
2 .DELAYED COMM.
```

```
3 .TX REPORT
```

When "2.NO" is selected, the following screen appears. Skip to Step 12.

```
ABB. NBR= 001
```

```
1 .TEL NUMBER
```

```
2 .E-MAIL
```

```
3 .COMPLETE
```

Abbreviated Dialer Registration - continued

11 Select E-mail Options - continued

11b Delayed Communication Setting

To designate a specific time to start the transmission of the job using this Abbreviated Dial Number, press:

2

```
DELAYED COMM.  
  
TIME =HH:MM  
███
```

Enter the desired transmission start time in either 12-hour or 24-hour format depending on the machine setup. (Example: 23:30 in the 24-hour format).

```
DELAYED COMM.  
  
TIME =HH:MM  
23:30█
```

Then press:

ENTER ←
▭

```
DELAYED COMM.  
  
TIME =23:30
```

Displayed for 2 seconds

The display returns to the first screen in Step 11. Select the next Option or skip to Step 11d if you have completed the E-mail Options setting.

11c Confirmation Report Setting

To print a Confirmation Report automatically after sending documents using this Abbreviated Dial Number, select:

3

```
CONFIRMATION REPORT  
1.ON  
2.OFF
```

To enable a Confirmation Report, press:

1

To disable a Confirmation Report, press:

2

The display returns to the first screen in Step 11. If you have completed the E-mail Options setting, continue to the next step.

11d Complete the E-mail Options Setup

If you have completed the desired E-mail Options setting for this Abbreviated Dial Number, select DONE by pressing:

1

```
ABB. NBR= 001  
1.TEL NUMBER  
2.E-MAIL  
3.COMPLETE
```

Abbreviated Dialer Registration - continued

12 Complete the ABB. registration

If you have completed the registration for this Abbreviated Dial Number, select COMPLETE by pressing:

3

```
ABB. NBR=      001
PRESS ONE TOUCH KEY
TO ENTER OR
[ENTER] :TO SKIP
```

If you do not want to assign this Abbreviated Dial Number to a One Touch Key, press:

ENTER ←

The display returns to the screen in Step 2.

STOP

Press  to exit the Menu

Operation mode and return to the Standby Mode.

If you want to assign this Abbreviated Dial Number to a One Touch Key, continue to the next step.

NOTE:

If you want to edit or cancel the registration of this Abbreviated Dial Number, press 2.

```
E-MAIL ADDRESS
ALREADY ASSIGNED
001@toshiba.com
```

After 2 seconds:

```
E-MAIL ADDRESS
1.CANCEL
2.MODIFY
3.RETAIN
```

See the section “Modify/Delete the Abbreviated Dial Number” and continue the operation.

13 Assign the Abbreviated Dial Number to a One Touch Key

10a Assign the One Touch Key

To assign this Abbreviated Dial Number to a One Touch Key, press the desired One Touch Key (Example: One Touch Key 01).

01

```
ABB. NBR=      001
ONE TOUCH=     01
L.A. OFFICE
REGISTERED
```

After 2 seconds:

```
ENTER ABB. NUMBER
OR PRESS
[BACK] :TO PREVIOUS
[STOP] :TO COMPLETE
```

Returns to Step 2.

STOP

Press  to exit the Menu

Operation mode and return to the Standby Mode.

10b Use a Preassigned One Touch Key

If the desired One Touch Key has been previously linked to another Abbreviated Dial Number or preset with a separate One Touch number, one of the following screens will be displayed.

One Touch key has been assigned to an Abbreviated Number:

```
ONE TOUCH=     01
ALREADY ASSIGNED
ABB. NBR=      003
SMITH'S OFFICE
```

One Touch key has been assigned with an Individual Phone Number:

```
ONE TOUCH=     01
ALREADY ASSIGNED
ONE TOUCH=     01
WEST REGION CENTER
```

After 2 seconds:

```
ONE TOUCH=     01
CANCEL ?
1.CANCEL
2.RETAIN
```

To CANCEL the existing link or One Touch assignment and return to Step 10a, press:

1

To RETAIN the existing link or One Touch assignment and return to Step 10a, press:

2

Returns to Step 10a.

```
ABB. NBR=      001
PRESS ONE TOUCH KEY
TO ENTER OR
[ENTER] :TO SKIP
```

Modify/Delete the Abbreviated Dial Number

1 Display the TEL LIST ENTRY Menu

View the "50-73" Flip Panel to select the desired Function Key.

Press:

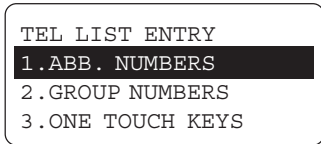

2 Display the ABB. NUMBERS Menu

To select "ABB. NUMBERS", press:

1

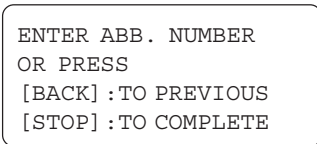

Upon entering the first number:

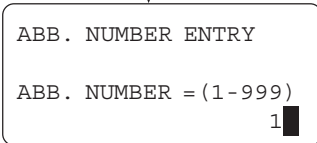

3 Enter the ABB. Dial Number

Enter the Abbreviated Dial Number that you want to modify or delete from 1 to 999.

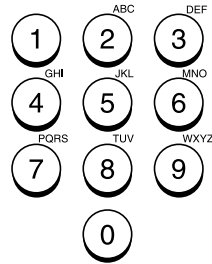

Make sure that the 3-digit number (001 to 999) appears correctly, then press:



NOTE:

Any leading zero (0) can be omitted from the Abbreviated Dial Number.

The following screen will be displayed.

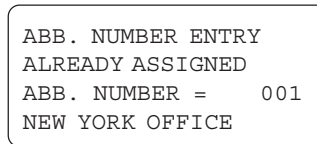

After 2 seconds:

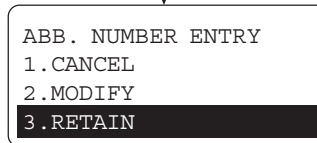

4 Change the ABB. Information

You can cancel, modify, or retain Abbreviated Dial Numbers registered in this facsimile.

- **CANCEL**
Deletes the information stored in the selected Abbreviated Dial Number. It will also remove the number from all associated Group Dialing Directories.
- **MODIFY**
Allows you to change the remote facsimile number and/or associated Location ID name. This selection is recommended if the location is used in Group Dialing Directories.
- **RETAIN**
Retains the selected Abbreviated Dial Number information without modification.

4a Cancel the ABB. Dial Information

To cancel (or delete) the contents stored in the Abbreviated Dial Number, press:

1

(to CANCEL)

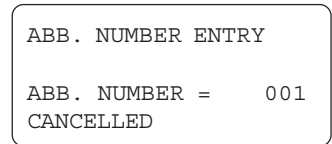

After 2 seconds:

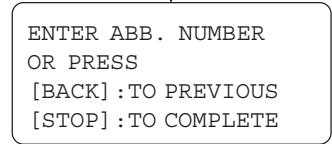

Return to Step 2.

Press to exit the Menu

Operation mode and return to the Standby Mode.

Modify/Delete the Abbreviated Dial Number - continued

4 Change the ABB. Information - continued

4b Modify the ABB. Dial Information

To change the E-mail address or the ID Name currently assigned to this Abbreviated Dial Number, press:

2

(to MODIFY)

The ID Name currently assigned is displayed on the bottom row.

```
ABB. NBR=      001
ID NAME = (MAX20)
```

After 2 seconds:

```
ENTER NAME
ID NAME = (MAX20)
XXXXXXXX
```

Rename the Location ID name of the remote party to be assigned to the current Abbreviated Dial Number.

When the name is displayed correctly on the LCD display, press:

ENTER ↵

```
ABB. NBR=      001
1. TEL NUMBER
2. E-MAIL
3. COMPLETE
```

If you continue to modify the E-mail address and other options, press:

2

If you want to complete the modification, press:

3

When you select “2.E-MAIL”, the following screen appears.

```
E-MAIL ADDRESS
ALREADY ASSIGNED
001@toshiba.com
```

After 2 seconds:

```
E-MAIL ADDRESS
1. CANCEL
2. MODIFY
3. RETAIN
```

To continue modifying the E-mail address and other options, press:

2

```
PRESS SPEED DIAL FOR
ADDRESS SEARCH OR
ENTER TO ENTER
E-MAIL ADDRESS
```

Go to Step 7 in the section of “Abbreviated Dialer Registration” and continue the operation.

When you select “3.COM-plete”, the following screen appears.

```
ABB. NBR=      001
PRESS ONE TOUCH KEY
TO ENTER OR
[ENTER] : TO SKIP
```

Go to Step 12 in the section of “Abbreviated Dialer Registration” and continue the operation.

4c Retain the Current ABB. Dial Information

If you do not wish to change the Abbreviated Dial Number information, press:

3

(to RETAIN)

```
ENTER ABB. NUMBER
OR PRESS
[BACK] : TO PREVIOUS
[STOP] : TO COMPLETE
```

Return to Step 3 to select a different Abbreviated Dial Number or press

STOP

to return to the Standby Mode.

One Touch Dialer Registration

This machine provides up to 73 One Touch Dial keys. Keys 1 to 49 are accessible with the Flip Panel in the "01-49" view. Keys 50 to 73 are accessible with the Flip Panel in the "50-73" view.

1 Display the TEL LIST ENTRY Menu

View the "50-73" Flip Panel to select the desired Function Key.

Press:

TEL LIST
ENTRY



```
TEL LIST ENTRY
1.ABB. NUMBERS
2.GROUP NUMBERS
3.ONE TOUCH KEYS
```

2 Display the ONE TOUCH KEYS Menu

To select "ONE TOUCH KEYS", press:

3



```
PRESS ONE TOUCH KEY
OR PRESS
[BACK] : TO PREVIOUS
[STOP] : TO COMPLETE
```

3 Select a One Touch Location

Press the desired One Touch key.

Example: One Touch key 03

03



If the One Touch key has not been used and the following menu is displayed, skip to Step 5.

```
ONE TOUCH=      03
ID NAME = (MAX20)
```

After 2 seconds:

```
ENTER NAME
ID NAME = (MAX20)
```

4 When a Preset One Touch is Active

When the E-mail address is assigned to this One Touch key, the following screen is displayed.

```
ONE TOUCH =      03
ALREADY ASSIGNED
ONE TOUCH =      03
FRISCO OFFICE
```

After 2 seconds:

```
ONE TOUCH KEY ENTRY
1.CANCEL
2.MODIFY
3.RETAIN
```

When the Abbreviated Dial Number is assigned to this One Touch key, the following screen is displayed.

```
ONE TOUCH=      03
ALREADY ASSIGNED
ABB. NUMBER =    001
NEWYORK OFFICE
```

After 2 seconds:

```
ONE TOUCH KEY ENTRY
1.CANCEL
2.RETAIN
```

See the section "Modify/Delete the One Touch Key" and continue the operation.

One Touch Dialer Registration - continued

5 Enter the Location ID Name

Enter the Location ID name of the remote party to be assigned to the current One Touch key.

When the name is displayed correctly on the LCD display, press:

ENTER ←

ONE TOUCH = 03
1. TEL NUMBER
2. E-MAIL

6 Select the type

To select to register an E-mail address for the One Touch key, Press:

2

PRESS SPEED DIAL FOR
ADDRESS SEARCH OR
ENTER TO ENTER
E-MAIL ADDRESS

If the E-mail address is already assigned to this One Touch key, the following screen appears.

E-MAIL ADDRESS
ALREADY ASSIGNED

001@toshiba.com

After 2 seconds:

E-MAIL ADDRESS
1. CANCEL
2. MODIFY
3. RETAIN

See the section “Modify/Delete the One Touch Key” and continue the operation.

7 Select the input E-mail address method

To input an E-mail address directly, press:

ENTER ←

To input an E-mail address by modifying the searched E-mail address, press:

SPEED DIAL

When is pressed, the ENTER E-MAIL ADDRESS screen appears. Skip to Step 10.

ENTER E-MAIL ADDRESS

E-MAIL ADDRESS:
█

When is pressed, the following screen appears. Continue to the next step.

1. LOCAL ADDRESSES
2. RECEPTION HISTORY
3. SENT HISTORY

One Touch Dialer Registration - continued

8 Searching for an E-mail address

This operation is to search for an E-mail address and modify it to a new E-mail address.

You can search for an E-mail address in the following categories.

Local Addresses:

You can search for an E-mail address that is assigned to Abbreviated Dial Numbers or One Touch Dial Keys.

Reception History:

You can search for an E-mail address which the machine has received the E-mails from.

Sent History:

You can search for an E-mail address which the machine has sent E-mails to.

8a Select the search category

To select the Local Addresses, press:

1

To select the Reception History, press:

2

To select the Sent History, press:

3

When "1.LOCAL ADDRESSES" is selected, the following screen appears. Continue to the next step.

```
1 . SEARCH NAME
2 . SEARCH E-MAIL ADDR
3 . ALL
```

When "2.RECEPTION HISTORY" is selected, the following screen appears. Skip to Step 8c.

```
RECEPTION HISTORY
NOW SEARCHING
```

Searching ends.

```
RECEPTION HISTORY
[STOP] :TO PREVIOUS
001@toshiba.com
[↑↓]      00001/00050
```

When "2.RECEPTION HISTORY" is selected but no E-mail address can be matched, the display indicates the following screen and returns to the first screen in this step.

```
RECEPTION HISTORY
E-MAIL ADDRESS :
-----
```

After 2 seconds:

```
1 . LOCAL ADDRESSES
2 . RECEPTION HISTORY
3 . SENT HISTORY
```

When "3.SENT HISTORY" is selected, the following screen appears. Skip to Step 8d.

```
SENT HISTORY
NOW SEARCHING
```

Searching ends.

```
SENT HISTORY
[STOP] :TO PREVIOUS
001@toshiba.com
[↑↓]      00001/00050
```

When "3.SENT HISTORY" is selected but no E-mail address can be matched, the display indicates the following screen and returns to the first screen in this step.

```
SENT HISTORY
E-MAIL ADDRESS :
-----
```

After 2 seconds:

```
1 . LOCAL ADDRESSES
2 . RECEPTION HISTORY
3 . SENT HISTORY
```

One Touch Dialer Registration - continued

8 Searching for an E-mail address - continued

8b Search from Local Adresses

You can search for an E-mail address from the Local Adresses using the following method.

Search Name:

You can search for an E-mail address by the ID name.

Search E-mail Addr:

You can search for an E-mail address by the E-mail address.

All:

You can list all E-mail addresses that have been registered as Abbreviated Dial Numbers and One Touch Dial Keys.

8b-1 Select the search method

To select Search Name, press:

1

To select Search E-mail Addr, press:

2

To select All, press:

3

When "1.SEARCH NAME" is selected, the following screen appears. Continue to the next step.

SEARCH NAME
NAME (20 MAX):
█

When "2.SEARCH E-MAIL ADDR" is selected, the following screen appears. Skip to the Step 8b-4.

SEARCH E-MAIL
E-MAIL ADDRESS:
█

When "3.ALL" is selected, the following screen appears. Skip to Step 8b-6.

ALL ADDRESS
NOW SEARCHING

After 2 seconds:

ALL ADDRESS
[STOP] : TO PREVIOUS
001@toshiba.com
[↑↓] 00001/00050

When "3.ALL" is selected but no E-mail address can be searched, the display indicates the following screen and returns to the first screen in this step.

ALL ADDRESS
E-MAIL ADDRESS:

After 2 seconds:

1 . SEARCH NAME
2 . SEARCH E-MAIL ADDR
3 . ALL

One Touch Dialer Registration - continued

8 Searching for an E-mail address - continued

8d Search from Local Addressess - continued

8b-2 Enter the Search Name

Enter the character(s) associated with the ID name of Abbreviated Dial Numbers or One Touch Dial Keys using the Keyboard and the Dial Keypad.

```
SEARCH NAME
NAME (20 MAX) :
00
```

Then press: 

The machine starts to search the ID names.

```
SEARCH NAME
NOW SEARCHING
NAME (20 MAX) :
00
```

Searching ends.

```
SEARCH NAME
[STOP] :TO PREVIOUS
001
[↑↓] 00001/00015
```

NOTE:

The machine searches all ID names that include the search name entered and applicable to the case.

When no ID name can be matched, the display indicates the following screen and returns to the first screen in this step.

```
SEARCH NAME
NAME (20 MAX) :
-----
```

After 2 seconds:

```
SEARCH NAME
NAME (20 MAX) :
00
```

8b-3 Select the Search Name

Locate the screen of the desired ID name using the following scroll keys.



(for the previous screen)



(for the next screen)

```
SEARCH NAME
[STOP] :TO PREVIOUS
001
[↑↓] 00001/00015
```



```
SEARCH NAME
[STOP] :TO PREVIOUS
002
[↑↓] 00002/00015
```

Then press: 

Skip to Step 9.

8b-4 Enter the Search E-mail Address

Enter the character(s) associated with the E-mail address assigned to Abbreviated Dial Numbers or One Touch Dial Keys using the Keyboard and the Dial Keypad.

```
SEARCH E-MAIL
E-MAIL ADDRESS :
toshiba
```

Then press: 

The machine starts to search the E-mail addresses.

```
SEARCH E-MAIL
NOW SEARCHING
E-MAIL ADDRESS :
toshiba
```

Searching ends.

```
SEARCH E-MAIL
[STOP] :TO PREVIOUS
001@toshiba.com
[↑↓] 00001/00015
```

NOTE:

The machine searches all E-mail addresses that include the search name entered and matched the case.

When no E-mail address can be matched, the display indicates the following screen and returns to the first screen in this step.

```
SEARCH E-MAIL
E-MAIL ADDRESS :
-----
```

After 2 seconds:

```
SEARCH E-MAL
E-MAIL ADDRESS :
toshiba
```

One Touch Dialer Registration - continued

8 Searching for an E-mail address - continued

9 Enter the E-mail address

8b Search from Local Addressess - continued

8b-5 Select the E-mail address

Locate the screen of the desired E-mail address using the following scroll keys.

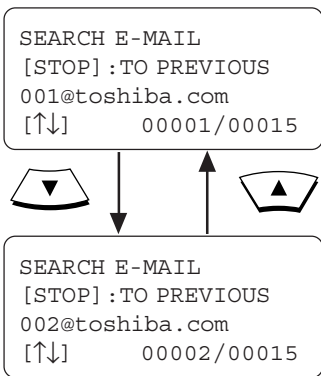
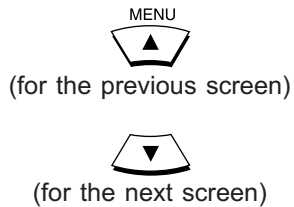

Then press:

Skip to Step 9.

8b-6 Select the E-mail address

Locate the screen of the desired E-mail address using the following scroll keys.

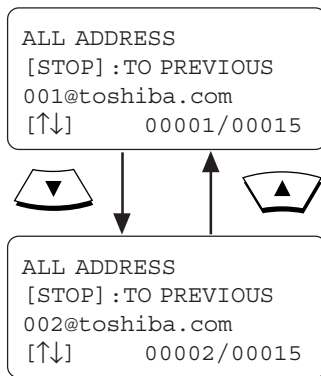
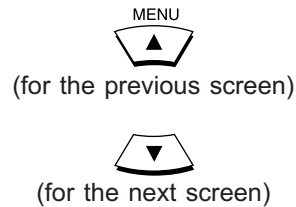

Then press:

Skip to Step 9.

8c Select from Reception History

Locate the screen of the desired E-mail address using the following scroll keys.

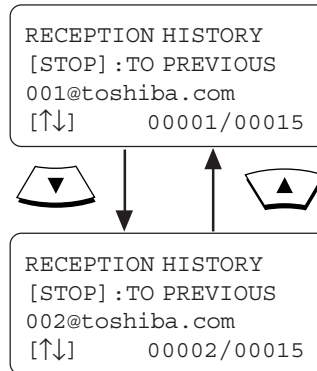
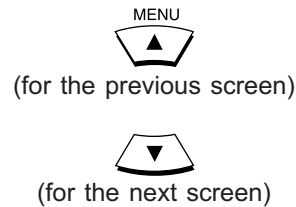

Then press:

Skip to Step 9.

8c Select from Sent History

Locate the screen of the desired E-mail address using the following scroll keys.

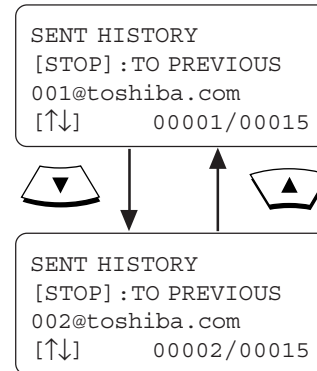
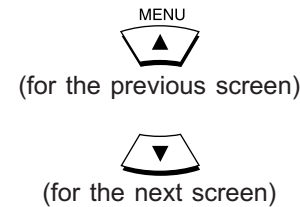

Then press:

Skip to Step 9.

Enter or modify the E-mail address to be assigned to the current One Touch key using the Keyboard and the Dial Keypad.



When the E-mail address is displayed correctly on the LCD display, press:

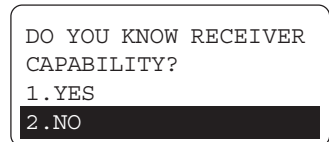

One Touch Dialer Registration - continued

10 Select Receiver Capability

This setting will allow you to specify one or more following Receiver Capabilities for the One Touch key you are registering, if you know the capabilities of the recipient machine.

Resolution:

Selected to specify the resolution of images to be sent. This resolution is set to "200x200" as a default setting.

Compression:

Selected to specify the type of compression applied to images to be sent.

10a Select the Receiver Capacity

If you know the capability of the recipient machine, press:

1

If you do not know the capability of the recipient machine, press:

2

When "1.YES" is selected, the following screen appears. Continue to the next step.

```
RECEIVER CAPABILITY
1 .DONE
2 .RESOLUTION
3 .COMPRESSION
```

When "2.NO" is selected, the following screen appears. Skip to Step 11.

```
E-MAIL OPTIONS?
1 .YES
2 .NO
```

10b Resolution Setting

To designate a specific resolution of the documents sent to this E-mail address, select RESOLUTION by pressing:

2

```
RESOLUTION
1 .200x100
2 .200x200
3 .200x400
```

4 .400x400

These items are outside the LCD frame. To view them, use the [▼] scroll key.

Select the desired Resolution. Press:

1

(for 200x100)

2

(for 200x200)

3

(for 200x400)

4

(for 400x400)

The display returns to the first screen in Step 10. Select the next option. If you have set up the Receiver Capability, Skip to Step 10d.

One Touch Dialer Registration - continued

10 Select Receiver Capability - continued

10c Compression Setting

To designate a specific compression of the documents sent to this E-mail address, select COMPRESSION by pressing:

3

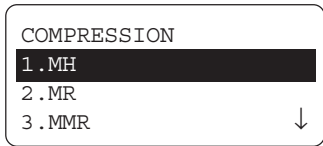

4 .JBIG

These items are outside the LCD frame. To view them, use the [▼] scroll key.

NOTE:

If you do not know the receiver's capabilities for the compression type, select "MH".

Select the desired Compression. Press:

1

(for MH)

2

(for MR)

3

(for MMR)

4

(for JBIG)

The display returns to the first screen in Step 10. If you have done so to set up the Receiver Capability, Skip to Step 10d.

10d Complete the Receiver Capability Setup

If you have completed the desired Receiver Capability setting for this One Touch key, select DONE by pressing:

1

E-MAIL OPTIONS?

1 .YES

2 .NO

11 Select E-mail Options

This setting will allow you to specify one or more following E-mail Options for the One Touch key you are registering.

Delayed Communication:

Default=off

Selected to program a transmission start time.

Confirmation Report:

Default=off

Selected to print a confirmation report after each transmission.

11a Select the E-mail Options

To set up the E-mail Options, press:

1

To skip the E-mail Options, press:

2

When "1.YES" is selected, the following screen appears. Continue to the next step.

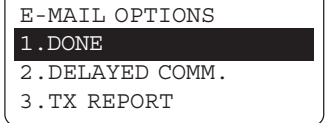

When "2.NO" is selected, the following screen appears. Skip to Step 12.

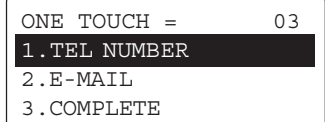

One Touch Dialer Registration - continued

11 Select E-mail Options - continued

11b Delayed Communication Setting

To designate a specific time to start the transmission of the job using this One Touch key, press:

2

```
DELAYED COMM.  
  
TIME =HH:MM  
███
```

Enter the desired transmission start time in either 12-hour or 24-hour format depending on the machine setup. (Example: 23:30 in the 24-hour format).

```
DELAYED COMM.  
  
TIME =HH:MM  
23:30█
```

Then press:



```
DELAYED COMM.  
  
TIME =23:30
```

Displayed for 2 seconds

The display returns to the first screen in Step 11. Select the next Option or skip to Step 11d if you have completed the E-mail Options setting.

11c Confirmation Report Setting

To print a Confirmation Report automatically after sending documents using this One Touch key, select:

3

```
CONFIRMATION REPORT  
1.ON  
2.OFF
```

To enable a Confirmation Report, press:

1

To disable a Confirmation Report, press:

2

The display returns to the first screen in Step 11. If you have completed the E-mail Options setting, continue to the next step.

11d Complete the E-mail Options Setup

If you have completed the desired E-mail Options setting for this One Touch key, select DONE by pressing:

1

```
ONE TOUCH = 03  
1.TEL NUMBER  
2.E-MAIL  
3.COMPLETE
```

One Touch Dialer Registration - continued

12 Complete the One Touch Key registration

If you have completed the registration for this One Touch key, select COMPLETE by pressing:

3

ONE TOUCH = 03
L.A. OFFICE
REGISTERED

After 2 seconds:

PRESS ONE TOUCH KEY
OR PRESS
[BACK] : TO PREVIOUS
[STOP] : TO COMPLETE

Returns to Step 2.

STOP

Press  to exit the Menu

Operation mode and return to the Standby Mode.

NOTE:

If you want to edit or cancel the registration of this One Touch key, press 2.

E-MAIL ADDRESS
ALREADY ASSIGNED

001@toshiba.com

After 2 seconds:

E-MAIL ADDRESS
1. CANCEL
2. MODIFY
3. RETAIN

See the section "Modify/Delete the One Touch Key" and continue the operation.

Modify/Delete the One Touch Key

1 Display the TEL LIST ENTRY Menu

View the "50-73" Flip Panel to select the desired Function Key.

Press:



```
TEL LIST ENTRY
1.ABB. NUMBERS
2.GROUP NUMBERS
3.ONE TOUCH KEYS
```

2 Display the ONE TOUCH KEY Menu

To select "ONE TOUCH KEYS", press:



```
PRESS ONE TOUCH KEY
OR PRESS
[BACK] : TO PREVIOUS
[STOP] : TO COMPLETE
```

3 Select a One Touch Location

Press the One Touch key that you want to modify or delete.

Example: One Touch key 03



When the E-mail address is assigned to this One Touch key, the following screen is displayed.

```
ONE TOUCH =      03
ALREADY ASSIGNED
ONE TOUCH =      03
FRISCO OFFICE
```

After 2 seconds:

```
ONE TOUCH KEY ENTRY
1.CANCEL
2.MODIFY
3.RETAIN
```

When the Abbreviated Dial Number is assigned to this One Touch key, the following screen is displayed.

```
ONE TOUCH=      03
ALREADY ASSIGNED
ABB. NUMBER =   001
NEWYORK OFFICE
```

After 2 seconds:

```
ONE TOUCH KEY ENTRY
1.CANCEL
2.RETAIN
```

4 Change the One Touch Key Information

You can cancel or retain the One Touch key once registered in the facsimile.

- **CANCEL**
Deletes the information stored in the selected One Touch key. It will also remove the number from all associated Group Dialing Directories.
- **MODIFY**
Allows you to change the remote facsimile number and/or associated Location ID name. This selection is recommended if the location is used in Group Dialing Directories.
- **RETAIN**
Retains the selected One Touch key information without modification.

4a Cancel the One Touch Assignment

To cancel (or delete) the One Touch key assignment, press:



(to CANCEL)

```
ONE TOUCH KEY ENTRY

ONE TOUCH=      03
CANCELLED
```

```
ENTER ONE TOUCH KEY
OR PRESS
[BACK] : TO PREVIOUS
[STOP] : TO COMPLETE
```

Return to Step 2.

STOP

Press  to exit the Menu

Operation mode and return to the Standby Mode.

Modify/Delete the One Touch Key - continued

4 Change the One Touch Key Information - continued

4b Modify the One Touch Key Information

To change the E-mail address or ID Name currently assigned to this One Touch key, press:

2

(to MODIFY)

The ID Name currently assigned is displayed on the bottom row.

```
ONE TOUCH =      03
ID NAME = (MAX20)
```

After 2 seconds:

```
ENTER NAME
ID NAME = (MAX20)
XXXXXXXX
```

Rename the Location ID name of the remote party to be assigned to the current One Touch key.

When the name is displayed correctly on the LCD display, press:

ENTER ↵

```
ONE TOUCH =      03
1. TEL NUMBER
2. E-MAIL
3. COMPLETE
```

If you continue to modify the E-mail address and other options, press:

2

If you want to complete the modification, press:

3

When you select “2.E-MAIL”, the following screen appears.

```
E-MAIL ADDRESS
ALREADY ASSIGNED
001@toshiba.com
```

After 2 seconds:

```
E-MAIL ADDRESS
1. CANCEL
2. MODIFY
3. RETAIN
```

To continue modifying the E-mail address and other options, press:

2

```
PRESS SPEED DIAL FOR
ADDRESS SEARCH OR
ENTER TO ENTER
E-MAIL ADDRESS
```

Go to Step 7 in the section of “One Touch Dialer Registration” and continue the operation.

When you select “3.COM-plete”, the following screen appears.

```
ABB. NBR=      001
PRESS ONE TOUCH KEY
TO ENTER OR
[ENTER] : TO SKIP
```

Go to Step 12 in the section of “One Touch Dialer Registration” and continue the operation.

4c Retain the Current ABB. Dial Information

If you do not wish to change the One Touch key information, press:

3

(to RETAIN)

```
PRESS ONE TOUCH KEY
OR PRESS
[BACK] : TO PREVIOUS
[STOP] : TO COMPLETE
```

Return to Step 3 to select a different One Touch key or

press  to return to the Standby Mode.

Group Number Registration

E-mail addresses can be assigned to the Group Numbers.

You can send a document to multiple remote stations in a single operation. This is referred to as Group Dialing or Multi-address Transmission.

It is useful to preset addresses, to which Multi-address Transmissions are often performed, in a group. To make a Multi-address Transmission easier, you can assign such a group to a One Touch key.

The preset groups can also be used as groups for Multi-polling Receptions.

You can register up to 50 Broadcast Groups using any combination of Group Numbers from 1 to 1999 (no duplications allowed). You may also assign each group an optional name of up to 20 characters. Each group can contain any combination of the 300 Abbreviated and/or 73 One Touch dials and can be assigned to a One Touch key.

NOTE:

The E-mail addresses and the fax numbers can be assigned to the same Group Number. To assign the fax number to a Group Number, refer to the DP120F/DP125F Operator's Manual.

1 Display the TEL LIST ENTRY Menu

View the "50-73" Flip Panel to select the desired Function Key.

Press:



```
TEL LIST ENTRY
1.ABB. NUMBERS
2.GROUP NUMBERS
3.ONE TOUCH KEYS
```

2 Display the GROUP NUMBERS Menu

To select "GROUP NUMBERS," press:



```
ENTER GROUP NUMBER
OR PRESS
[BACK]:TO PREVIOUS
[STOP]:TO COMPLETE
```

3 Enter a Group Number

Enter a Group Number (1 to 1999).

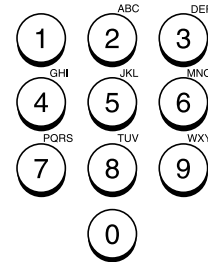

Example: 1

```
GROUP NBR ENTRY
GROUP NBR =(1-1999)
1
```

Then press:



```
GROUP NUMBER= 0001
GROUP NAME =(MAX20)
```

Displayed for 2 seconds

The display changes to the following for character entry (go to Step 5).

```
ENTER NAME
GROUP NAME =(MAX20)
```

If the number entered is already registered as a Group Number, you will receive an LCD prompt like the one below.

```
GROUP NBR ENTRY
ALREADY ASSIGNED
GROUP NUMBER= 0001
OREGON GRP
```

After 2 seconds:

```
GROUP NBR ENTRY
1.CANCEL
2.MODIFY
3.RETAIN
```

To select "1.CANCEL," go to Step 4a.

To select "2.MODIFY," go to Step 4b.

To select "3.RETAIN," go to Step 4c.

Group Number Registration - continued

4a Cancel the Existing Group

To cancel the existing Group, press:

1

(to CANCEL)

```
GROUP NBR ENTRY
GROUP NUMBER= 0001
CANCELLED
```

After 2 seconds:

```
ENTER GROUP NUMBER
OR PRESS
[BACK] : TO PREVIOUS
[STOP] : TO COMPLETE
```

Return to Step 3.

4b Modify the Existing Group

To change the existing Group, press:

2

(to MODIFY)

Go to Step 5 for the Group Name entry.

```
GROUP NUMBER= 0001
GROUP NAME = (MAX20)
```

After 2 seconds:

```
ENTER NAME
GROUP NAME = (MAX20)
COLORADO GRP █
```

The current Group Name is displayed.

Skip to Step 5.

4c Retain the Existing Group

To retain the existing Group, press:

3

(to RETAIN)

```
ENTER GROUP NUMBER
OR PRESS
[BACK] : TO PREVIOUS
[STOP] : TO COMPLETE
```

Return to Step 3.

5 Enter the Group Name

Enter the Group Name (comprised of up to 20 characters) associated with the Group Number using the Keyboard and the Keypad.

(When no name is entered in this step, no name will be given to the Group Number.)

When the name is displayed correctly on the LCD display, press:

ENTER ↵

```
GROUP NUMBER= 0001
ENTER SPEED DIAL, OT
OR E-MAIL KEY
ENTER TO COMPLETE
```

6 Enter a Remote Station

Press:

E-MAIL ADDRESS



```
GROUP NUMBER= 0001
```

```
ENTER ABB. NBR OR OT
[ENTER] TO COMPLETE
```

NOTE:

The E-mail addresses and the fax numbers can be assigned to the same Group Number. To assign the fax number to a Group Number, refer to the DP120F/DP125F Operator's Manual.

Group Number Registration - continued

6 Enter a Remote Station - continued

Enter the E-mail addresses of the remote stations to be pre-set in the group.

If a remote station is assigned to a One Touch key, press the One Touch key.

If a remote station is assigned to an Abbreviated Dial Number, enter the number then press **ENTER** .

Example:
Abbreviated Dial Number 118 (preset as DENVER OFFICE):

1

+

1

+

8

+

ENTER 



```
GROUP NUMBER= 0001
ABB. NBR= 118
DENVER OFFICE
```

After 2 seconds:

```
GROUP NUMBER= 0001
ABB. NBR= 118
ENTER ABB. NBR OR OT
[ENTER] TO COMPLETE
```

Repeat this step until all of the required remote station addresses are entered. Then go to Step 8.

NOTE:

- When the entered Abbreviated Dial Number or One Touch key has not been registered with an E-mail address, the display shows the message "NO ENTRY." Then returns to Step 5.
- When the entered Abbreviated Dial Number or One Touch key is already assigned in this group, the display shows the screens below.

Go to Step 7a or Step 7b.

```
GROUP NUMBER= 0001
ALREADY ASSIGNED
ABB. NBR= 118
DENVER OFFICE
```

After 2 seconds:

```
ABB. NBR= 118
CANCEL ?
1 .CANCEL
2 .RETAIN
```

7a Cancel the Group Number Setting

To delete the existing remote station from this group, press:

1

(to CANCEL)

```
GROUP NUMBER= 0001
ABB. NBR= 118
CANCELLED
```

After 2 seconds:

```
GROUP NUMBER= 0001
ENTER ABB. NBR OR OT
[ENTER] :TO COMPLETE
```

Return to Step 6.

7b Retain the Group Number Setting

To retain this remote station in this group, press:

2

(to RETAIN)

```
GROUP NUMBER= 0001
ENTER ABB. NBR OR OT
[ENTER] :TO COMPLETE
```

Return to Step 6.

8 Complete Group Station Entries

When all the stations necessary for this group are entered in Step 6, press:

ENTER 



```
GROUP NUMBER= 0001
PRESS ONE TOUCH KEY
TO ENTER OR
[ENTER] :TO SKIP
```

Group Number Registration - continued

9 Assign a One Touch Key

To assign this group to a One Touch key, press the desired One Touch key.

Example: One Touch key 35.

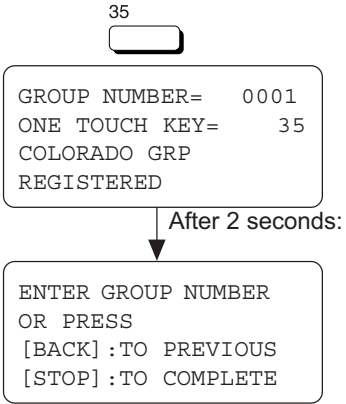

Returns to Step 3.

Press to display the previous screen in Menu Screen mode.

Or,

press to complete the Group Setting operation and return to the Standby Mode.

To skip assigning this group to a One Touch key, press:

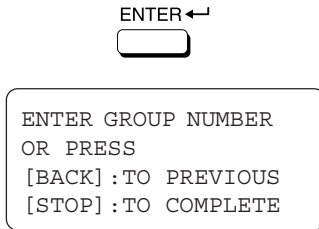

Return to Step 3.

Press to display the previous screen in Menu Screen mode.

Press to complete the Group Setting operation and return to the Standby Mode.

If the selected One Touch key is already linked to or registered with any data, the following is displayed.

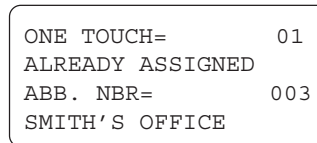

After 2 seconds:

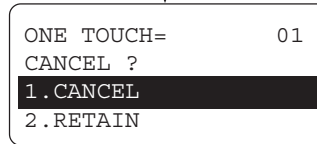

To select "1.CANCEL" (to cancel the existing link or preset data of this One Touch key), press:

1

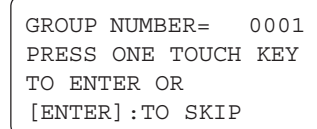

Returns to Step 9.

To RETAIN, press:

2

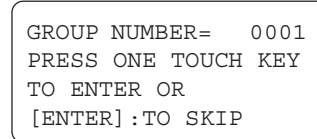

Returns to Step 9.

SETUP - SETUP FLOW

The following table describes the Initial Setup Flow according to your conditions or needs.

To use the functions, the network configuration for this machine must be set up correctly. For the values of the network configuration, contact to your network administrator.

TCP/IP Configuration Setup

The items and the parameter values for the TCP/IP Configuration Setup differs whether the IP address of this machine is obtained from a DHCP server or assigned manually.

►P54 TCP/IP CONFIGURATION SETUP

NOTE:

When you want to set to SMTP for the Receive Mode, the IP address must be assigned manually.

| Item | Use DHCP Server | Assign IP Address |
|-----------------|-----------------|-----------------------|
| BootP/DHCP | Set to ON | Set to OFF |
| IP Address | Not required | Required |
| Subnetmask | Not required | Required if necessary |
| Default Gateway | Not required | Required if necessary |
| Host Name | Required | Required |

• BootP/DHCP

Set to enable or disable the BootP/DHCP whether obtaining the IP address from the DHCP server. When the TCP/IP settings of this machine are provided by the DHCP server, set this to ON. Set this to OFF the BootP/DHCP when you want to assign the TCP/IP settings manually.

• IP Address

Assign the IP address of this machine. Do not set this when the IP address is obtained from the DHCP server. The machine uses the IP address here even if the BootP/DHCP is set to be enabled.

• Subnetmask

Assign the Subnetmask if required.

• Default Gateway

Assign the Default Gateway address when the machine is used in the network through a router.

• Host Name

Set the name of this machine. This name is used as the sender name for E-mails.

E-mail Account Setup

The items and the parameter values for the E-mail Account Setup differs whether the machine uses POP or SMTP for the Receive Mode. Available functions vary according to the type of the Receive Mode. For further details, refer to "INTRODUCTION - FEATURES".

►P59 E-MAIL ACCOUNT SETUP

NOTE:

When the IP address is obtained from the DHCP server, the Receive Mode cannot be set to SMTP.

| Item | POP | SMTP |
|------------------------------|------------|--------------|
| E-mail Address | Required | Required |
| Error E-mail Forward Address | Required | Required |
| Receive Mode | Set to POP | SMTP |
| POP Server Address | Required | Not required |
| POP Time | Required | Not required |
| POP Login Name | Required | Not required |
| POP Password | Required | Not required |
| SMTP Server Address | Required | Required |

E-mail Properties Setup

You can also configure the E-mail properties. After the machine is set up, it is recommended to configure the E-mail properties to use Internet Fax features.

►P68 E-MAIL PROPERTIES SETUP

Onramp Gateway Setup

In order to use the Onramp Gateway Transmission, you must set some configurations correctly.

►P80 ONRAMP GATEWAY SETUP

Offramp Gateway Setup

In order to use the Offramp Gateway Transmission, you must set some configurations correctly.

►P85 OFFRAMP GATEWAY SETUP

Additional Functions Setup

The setup functions for Novell and Network utilities (FTP) become available when the Internet Fax Kit is fitted, though they are not used for Internet Fax setup.

►P90 ADDITIONAL FUNCTIONS SETUP

- TCP/IP CONFIGURATION

This section describes the procedures to configure the TCP/IP for the Network Interface Card to connect to the Internet.

BootP/DHCP Setting

1 Display the TCP/IP Menu

Press:



```
01 . DONE
02 . BOOTP/DHCP
03 . IP ADDRESS
04 . SUBNET MASK ↓
```

```
05 . DEFAULT GATEWAY
06 . HOST NAME
```

2 Display the BOOTP/DHCP Menu

Press:



```
BOOTP/DHCP
1 . ON
2 . OFF
```

3 Select the BootP/DHCP Mode

Enable or Disable the BootP/DHCP function.



(for ON-Enable)



(for OFF-Disable)

```
OPERATION COMPLETED
```

Displayed for 2 seconds



The display returns to Step 1.

Continue to set another item, or press 0 + 1 to select "1.DONE" to exit the Menu Operation mode and return to the Standby Mode.

When "1.DONE" is selected, the Network Interface Card starts initializing. Wait for few minutes until the Network Interface Card completes initializing.

IP Address Setting

1 Display the TCP/IP Menu

Press:



01 . DONE
02 . BOOTP/DHCP
03 . IP ADDRESS
04 . SUBNET MASK

05 . DEFAULT GATEWAY
06 . HOST NAME

2 Display the IP ADDRESS Menu

Press:

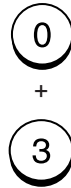

IP ADDRESS
000.000.000.000

3 Enter the IP address

Enter the IP address.

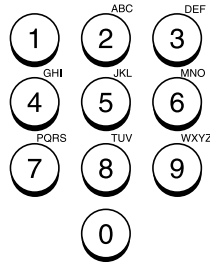

IP ADDRESS
172.016.110.110

NOTE:

- "000.000.000.000" cannot be assigned for the IP address.
- The second 8-digit number and third 8-digit number cannot be set to "000".
i.e: xxx.000.xxx.xxx
xxx.xxx.000.xxx

When the correct IP address is displayed, press:



OPERATION COMPLETED

Displayed for 2 seconds

The display returns to Step 1.

Continue to set another item, or press 0 + 1 to select "1.DONE" to exit the Menu Operation mode and return to the Standby Mode.

When "1.DONE" is selected, the Network Interface Card starts initializing. Wait for few minutes until the Network Interface Card completes initializing.

Subnetmask Setting

1 Display the TCP/IP Menu

Press:



01 . DONE
02 . BOOTP/DHCP
03 . IP ADDRESS
04 . SUBNET MASK

05 . DEFAULT GATEWAY
06 . HOST NAME

2 Display the SUBNET MASK Menu

Press:

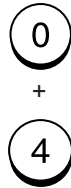

SUBNET MASK
000.000.000.000

3 Enter the Subnetmask

Enter the Subnetmask.

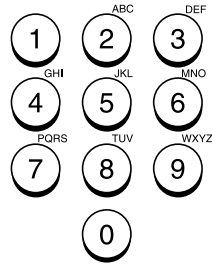

SUBNET MASK
255.255.000.000

NOTE:
"000.000.000.000" and
"255.255.255.255" cannot
be assigned for the
Subnetmask.

When the correct Subnetmask
is displayed, press:



OPERATION COMPLETED

Displayed for 2 seconds

The display returns to Step 1.

Continue to set another item, or
press 0 + 1 to select
"1.DONE" to exit the Menu Op-
eration mode and return to the
Standby Mode.

When "1.DONE" is selected,
the Network Interface Card
starts initializing. Wait for few
minutes until the Network Inter-
face Card completes initializ-
ing.

Default Gateway Setting

1 Display the TCP/IP Menu

Press:



01 . BOOTP/DHCP
02 . IP ADDRESS
03 . SUBNET MASK
04 . DEFAULT GATEWAY ↓

05 . HOST NAME

2 Display the DEFAULT GATEWAY Menu

Press:



DEFAULT GATEWAY
000.000.000.000

3 Enter the Default Gateway address

Enter the Default Gateway address.

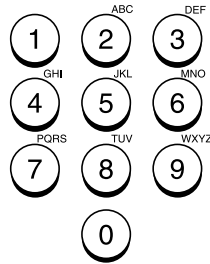

DEFAULT GATEWAY
255.000.000.000

When the correct Default Gateway address is displayed, press:



OPERATION COMPLETED

Displayed for 2 seconds

The display returns to Step 1.

Continue to set another item, or press 0 + 1 to select "1.DONE" to exit the Menu Operation mode and return to the Standby Mode.

When "1.DONE" is selected, the Network Interface Card starts initializing. Wait for few minutes until the Network Interface Card completes initializing.

Host Name Setting

1 Display the TCP/IP Menu

Press:



01 . BOOTP / DHCP
02 . IP ADDRESS
03 . SUBNET MASK
04 . DEFAULT GATEWAY ↓

05 . HOST NAME

This item is outside the LCD frame. To view them, use the [▼] scroll key.

2 Display the HOST NAME Menu

Press:



HOST NAME
(MAX 254 :)
█

3 Enter the Host Name

Enter the Host Name using the Keyboard and Numeric Keypad.

HOST NAME
(MAX 254 :)
XXXXXX█

When the correct Subnetmask is displayed, press:



OPERATION COMPLETED

Displayed for 2 seconds



The display returns to Step 1.

Continue to set another item, or press 0 + 1 to select "1.DONE" to exit the Menu Operation mode and return to the Standby Mode.

When "1.DONE" is selected, the Network Interface Card starts initializing. Wait for few minutes until the Network Interface Card completes initializing.

- E-MAIL ACCOUNT SETUP

This section describes the procedures to set E-mail account information on the machine so that you can send and receive E-mails with this machine.

NOTE:

Before you set up the E-mail account information, your E-mail account must be created on the E-mail server. Please confirm the following information before configuring the E-mail settings in your machine.

- Ask your administrator for your E-mail account information.
- The machine is connected with the E-mail server in the local area network.

The available transmission vary according to the type of the Receive Mode: POP or SMTP.

The machine can do the following when using POP for the Receive Mode:

- **Internet Fax to Internet Fax**
- **Internet Fax to/from Client Computers**
- **Onramp Gateway Transmission**

The machine can do the following when using SMTP for the Receive Mode:

- **Internet Fax to Internet Fax**
- **Internet Fax to/from Client Computers**
- **Onramp Gateway Transmission**
- **Offramp Gateway Transmission**

NOTE:

Please see "INTRODUCTION - Internet Fax Transmission Overview" on page 7 for the descriptions for each transmission method.

The items you should set up vary according to your Incoming E-mail server type.

When this machine uses POP for the Receive Mode:

- **E-mail address**
- **Error E-mail forward address**
- **Receive mode**
- **POP server address**
- **POP time**
- **POP login name**
- **POP password**
- **SMTP server address**

When this machine uses SMTP for the Receive Mode:

- **E-mail address**
- **Error E-mail forward address**
- **Receive mode**
- **SMTP server address**

NOTE:

Some configuration of the mail server will be required in order to use the machine for the Offramp Gateway transmission. For further details, refer to "OFFRAMP GATEWAY SETUP" on page 85.

E-mail Address Setting

This sets the E-mail address of the machine.

1 Display the E-MAIL Menu

Press:



```
01 . E-MAIL ADDRESS
02 . ERR EMAIL FW ADDR
03 . RECEIVE MODE
04 . POP SERVER ADDR ↓
```

```
05 . POP TIME
06 . POP LOGIN NAME
07 . POP PASSWORD
08 . SMTP SERVER ADDR
```

2 Display the E-MAIL ADDRESS Menu

Press:

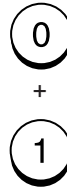

```
E-MAIL ADDRESS
(MAX 256: )
█
```

When the Receive Mode is set to POP, go to Step 3a.

When the Receive Mode is set to SMTP, go to Step 3b.

3 Enter the E-mail address

3a When the Receive Mode is set to POP

Enter the E-mail address using the Keyboard and Numeric Keypad.

```
E-MAIL ADDRESS
(MAX 256: )
xxx@toshiba.com █
```

When the correct E-mail address is displayed, press:



The display returns to Step 1.

3b When the Receive Mode is set to SMTP

When the Receive Mode is set to SMTP, the domain of your E-mail address becomes a name added the sub-address for this machine and domain name of the SMTP server. You can use any username for the E-mail address.

NOTE:

The sub-address of this machine is set in the SMTP server by the network administrator. Please ask your network administrator for more details.

Enter the E-mail address using the Keyboard and Numeric Keypad. For example:

```
sub-address: host1
Domain: toshiba.com
"username@host1.toshiba.com".
```

```
E-MAIL ADDRESS
(MAX 256: )
xxx@host1.toshiba.com
```

When the correct E-mail address is displayed, press:



The display returns to Step 1.

Error E-mail Forward Address Setting

This sets the E-mail address to forward the received E-mail when an error occurs and the machine cannot print the E-mail.

NOTE:

The machine recognizes an error if the E-mail contains files of other than text format or TIFF-FX format. The machine can forward this E-mail to another E-mail address when this happens. It is recommended to set the address to forward the E-mail to a personal computer because personal computers are normally be able to view the files.

1 Display the E-MAIL Menu

Press:



```
01.E-MAIL ADDRESS
02.ERR EMAIL FW ADDR
03.RECEIVE MODE
04.POP SERVER ADDR ↓
```

```
05.POP TIME
06.POP LOGIN NAME
07.POP PASSWORD
08.SMTP SERVER ADDR
```

2 Display the E-MAIL ADDRESS Menu

Press:



```
ERR EMAIL FW ADDRESS
(MAX 256:)
█
```

3 Enter the E-mail address

Enter the E-mail address using the Keyboard and Numeric Keypad.

```
ERR EMAIL FW ADDRESS
(MAX 256:)
xxx@toshiba.com █
```

When the correct E-mail address is displayed, press:



The display returns to Step 1.

Receive Mode Setting

This sets the type of protocols used for receiving E-mail.

NOTE:

To perform the Offramp Gateway transmission, the Receive Mode must set to "SMTP".

See "OFFRAMP GATEWAY SETUP" on page 85 for further details.

1 Display the E-MAIL Menu

Press:



```
01 . E-MAIL ADDRESS
02 . ERR EMAIL FW ADDR
03 . RECEIVE MODE
04 . POP SERVER ADDR ↓
```

```
05 . POP TIME
06 . POP LOGIN NAME
07 . POP PASSWORD
08 . SMTP SERVER ADDR
```

2 Display the RECEIVE MODE Menu

Press:

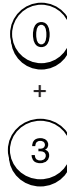

```
RECEIVE MODE
1 . POP
2 . SMTP
```

3 Select the Receive Mode

Select the Receive Mode.

To select the POP server, press:



To select the SMTP server, press:



```
OPERATION COMPLETED
```

Displayed for 2 seconds



The display returns to Step 1.

POP Server Address Setting

This sets the IP address of the POP server. This must be set when "POP" is selected in "Receive Mode."

1 Display the E-MAIL Menu

Press:



```
01 . E-MAIL ADDRESS
02 . ERR EMAIL FW ADDR
03 . RECEIVE MODE
04 . POP SERVER ADDR ↓
05 . POP TIME
06 . POP LOGIN NAME
07 . POP PASSWORD
08 . SMTP SERVER ADDR
```

2 Display the POP SERVER ADDR Menu

Press:



```
POP SERVER ADDRESS
000.000.000.000
```

3 Enter the POP server address

Enter the POP server address.

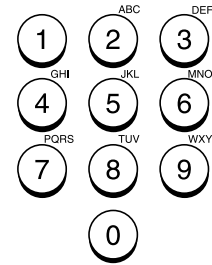

```
POP SERVER ADDRESS
172.016.110.120
```

When the correct POP server address is displayed, press:



```
OPERATION COMPLETED
```

Displayed for 2 seconds



The display returns to Step 1.

POP Time Setting

This sets the time interval to check whether or not new E-mail has been received at the POP server. This setting is valid when "POP" is selected in "Receive Mode."

"10MINS" is selected as the default setting.

1 Display the E-MAIL Menu

Press:



01. E-MAIL ADDRESS
02. ERR EMAIL FW ADDR
03. RECEIVE MODE
04. POP SERVER ADDR ↓

05. POP TIME
06. POP LOGIN NAME
07. POP PASSWORD
08. SMTP SERVER ADDR

These items are outside the LCD frame. To view them, use the [▼] scroll key.

2 Display the POP TIME Menu

Press:

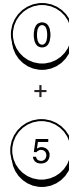

POP TIME
01. 1MIN
02. 2MINS
03. 5MINS ↓

04. 10MINS
05. 30MINS
06. 1HR
07. 2HRS
08. 6HRS
09. 12HRS
10. 24HRS

These items are outside the LCD frame. To view them, use the [▼] scroll key.

3 Select the POP Time

Select the desired POP Time.

Press:

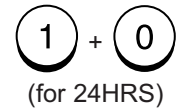
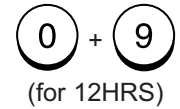
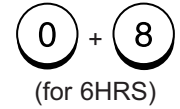
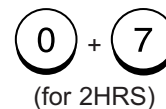
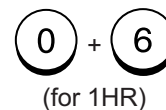
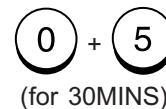
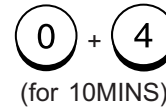
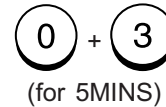
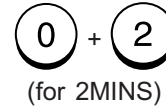
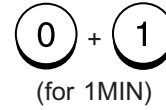

OPERATION COMPLETED

Displayed for 2 seconds



The display returns to Step 1.

POP Login Name Setting

This sets the user name to log in the POP server. This must be set when "POP" is selected in "Receive Mode."

NOTE:

The user name to log in the POP server is provided by the administrator of the E-mail server. Ask your administrator for the user name if you do not know it.

1 Display the E-MAIL Menu

Press:



```
01.E-MAIL ADDRESS
02.ERR EMAIL FW ADDR
03.RECEIVE MODE
04.POP SERVER ADDR ↓
```

```
05.POP TIME
06.POP LOGIN NAME
07.POP PASSWORD
08.SMTP SERVER ADDR
```

These items are outside the LCD frame. To view them, use the [▼] scroll key.

2 Display the POP LOGIN NAME Menu

Press:



```
POP LOGIN NAME
(MAX 32:)
public
```

NOTE:

"public" is set as the default POP login name.

3 Enter the POP Login Name

Enter the POP Login Name using the Keyboard and Numeric Keypad.

```
POP LOGIN NAME
(MAX 32:)
xxxxx
```

When the correct POP Login Name is displayed, press:



The display returns to Step 1.

POP Password Setting

This sets the password to log in the POP server. This must be set when "POP" is selected in "Receive Mode."

NOTE:

The password to log in the POP server is provided by the administrator of the E-mail server. Ask your administrator for the password if you do not know it.

1 Display the E-MAIL Menu

Press:



```
01 . E-MAIL ADDRESS
02 . ERR EMAIL FW ADDR
03 . RECEIVE MODE
04 . POP SERVER ADDR ↓
```

```
05 . POP TIME
06 . POP LOGIN NAME
07 . POP PASSWORD
08 . SMTP SERVER ADDR
```

These items are outside the LCD frame. To view them, use the [▼] scroll key.

2 Display the POP PASSWORD Menu

Press:



```
POP PASSWORD
(MAX 32:)
pass
```

NOTE:

"pass" is set as the default POP Password.

3 Enter the POP Password

Enter the POP Password using the Keyboard and Numeric Keypad.

```
POP PASSWORD
(MAX 32:)
xxxx
```

When the correct POP Password is displayed, press:



The display returns to Step 1.

SMTP Server Address Setting

This sets the IP address of the SMTP server which is used for an Outgoing E-mail server.

NOTE:

When "SMTP" is selected in "Receive Mode", the machine also retrieves E-mails from the SMTP server assigned here using SMTP transmission. In this case, this machine works as one of the mail servers.

1 Display the E-MAIL Menu

Press:

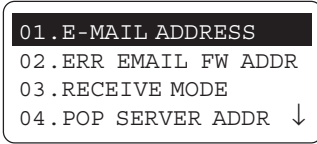

- 05. POP TIME
- 06. POP LOGIN NAME
- 07. POP PASSWORD
- 08. SMTP SERVER ADDR

These items are outside the LCD frame. To view them, use the [▼] scroll key.

2 Display the SMTP SERVERADDR Menu

Press:

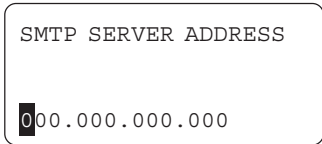
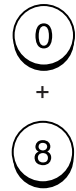

3 Enter the POP server address

Enter the SMTP server address.

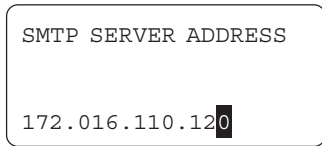
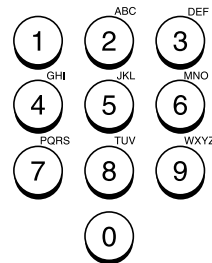

When the correct SMTP server address is displayed, press:

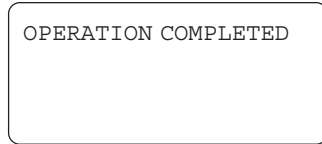

Displayed for 2 seconds

The display returns to Step 1.

- E-MAIL PROPERTIES SETUP

This section describes the procedures to set the E-mail properties on how the machine activates the Internet Fax function. The following table describes the E-mail properties that can be set up. See the following sections for more information about each item.

| Properties Name | Description | Default |
|--------------------|---|----------|
| Print Text Body | This is to set On or Off for printing the body section of the received E-mail. However, when the received E-mail has only the body section, the body section is printed even if this is set to Off. | On |
| Body Page Limit | This is to set the maximum number of the pages to be printed when receiving an E-mail. If the number of the pages to be printed exceeds the limit, the machine interrupts the printing. | 5 |
| Send Disposition | This is to set On or Off for replying to the MDN request when receiving the documents from other machines using the Internet Fax function. | OFF |
| Print Header | This is to set On or Off for printing the header section of the received E-mail. | ON |
| Print E-mail Error | This is to set On or Off for printing only the items that can be printed normally when an error occurs. The items that machine recognizes to be erroneous are not printed. | ON |
| Print DSN | This is to set On or Off for printing the DSN. | OFF |
| Print Disposition | This is to set On or Off for printing the MDN replied from a recipient that informs you the message successfully received by a recipient. | ON |
| Request DSN | This is to set On or Off for sending the DSN request. | ON |
| Confirm. Timer | This is to set On or Off for printing the alert report if the machine does not receive the MDN reply from a recipient in the time interval set in "Set Confirm. Time." | ON |
| Set Confirm. Time | This is to set the time interval to wait for the MDN reply before printing the alert report. | 15MINS |
| MSG Size Limit | This is to set the maximum size for sending documents using the Internet Fax function. If the size of documents exceeds the maximum size, the machine sends the documents separately. | 2.0MBYTE |

NOTE:

There are also the E-mail properties related to the Offramp Gateway function. When you set the Receive Mode to "SMTP", you can additionally configure the following items. For further details, see "OFFRAMP GATEWAY SETUP" on page 85.

| Properties Name | Description |
|-----------------------|---|
| E-mail to FAX Gateway | This sets the machine to allow forwarding the document that is received by the Offramp Gate-way transmission. (See page 87.) |
| Gateway Print | This sets whether to print the document sent from the Inter-net FAX machine using the Offramp Gateway transmis-sion. The machine prints the document before forwarding it to the facsimile, so that you can confirm what is sending using the Offramp Gateway. (See page 88.) |
| Gateway Security | This sets whether to check the fax number where the docu-ment is sent before allowing the Offramp Gateway. If the fax number of the facsimile is not registered as One Touch dials or Abbreviated dials, the machine does not allow the Offramp Gateway for this document. (See page 89.) |

Print Text Body Setting

This sets whether or not the body section of the received E-mail is printed

NOTE:

When the Internet Fax function is used only between other DP120F/DP125Fs, it is recommended to select OFF.

1 Display the E-MAIL Menu

Press:

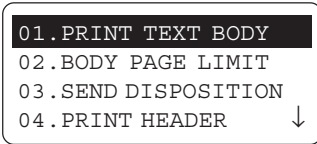

- 05.PRINT E-MAIL ERR
- 06.PRINT DSN
- 07.PRINT DISPOSITION
- 08.REQUEST DSN
- 09.EMAIL TO FAX GTWY
- 10.GATEWAY PRINT
- 11.GATEWAY SECURITY
- 12.CONFIRM. TIMER
- 13.SET CONFIRM. TIME
- 14.MSG SIZE LIMIT

2 Display the PRINT TEXT BODY Menu

Press:

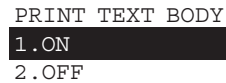

3 Enable/Disable the Print Text Body

Enable or Disable the Print Text Body function.



OPERATION COMPLETED

Displayed for 2 seconds



The display returns to Step 1.

Body Page Limit Setting

This sets the maximum number of the pages to be printed in the range from 1 to 99 when receiving an E-mail. If the number of the pages to be printed exceeds the limit, the machine interrupts the printing.

NOTE:

The received body text data may be garbled during transferred through the Internet. This is a known problem with E-mail transmissions over the Internet. It is recommended to select ON to avoid printing of a large amount of the garbled data.

1 Display the E-MAIL Menu

Press:



- 01 .PRINT TEXT BODY
- 02 .BODY PAGE LIMIT
- 03 .SEND DISPOSITION
- 04 .PRINT HEADER
- 05 .PRINT E-MAIL ERR
- 06 .PRINT DSN
- 07 .PRINT DISPOSITION
- 08 .REQUEST DSN
- 09 .EMAIL TO FAX GTWY
- 10 .GATEWAY PRINT
- 11 .GATEWAY SECURITY
- 12 .CONFIRM. TIMER
- 13 .SET CONFIRM. TIME
- 14 .MSG SIZE LIMIT

2 Display the BODY PAGE LIMIT Menu

Press:

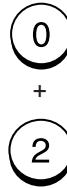

BODY PAGE LIMIT

5

NOTE:

"5" is set as the default Body Page Limit.

3 Enter the number of Body Page Limit

Enter the number for the Body Page Limit.

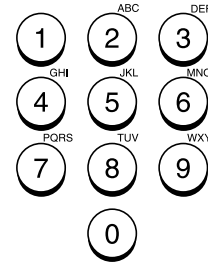

BODY PAGE LIMIT

8

NOTE:

The numbers in the range from 1 to 99 can be entered.

When the correct number is displayed, press:



OPERATION COMPLETED

Displayed for 2 seconds

The display returns to Step 1.

Send Disposition Setting

This sets the reply to the MDN request when receiving the documents from other DP120F/DP125F using the Internet Fax function.

MDN, *Message Disposition Notification*, is used to notify the sender of the disposition of a message after it has been successfully delivered to a recipient.

NOTE:

This function is only available when the remote unit and the your Incoming E-mail server support the MDN.

1 Display the E-MAIL Menu

Press:



```
01.PRINT TEXT BODY
02.BODY PAGE LIMIT
03.SEND DISPOSITION
04.PRINT HEADER ↓
```

```
05.PRINT E-MAIL ERR
06.PRINT DSN
07.PRINT DISPOSITION
08.REQUEST DSN
09.EMAIL TO FAX GTWY
10.GATEWAY PRINT
11.GATEWAY SECURITY
12.CONFIRM. TIMER
13.SET CONFIRM. TIME
14.MSG SIZE LIMIT
```

2 Display the SEND DISPOSITION Menu

Press:



```
SEND DISPOSITION
1.ON
2.OFF
```

3 Enable/Disable the Send Disposition

Enable or Disable the Send Disposition function.

1
(for ON-Enable)

2
(for OFF-Disable)

```
OPERATION COMPLETED
```

Displayed for 2 seconds

↓
The display returns to Step 1.

Print Header Setting

This sets whether or not the header section of the received E-mail is printed.

1 Display the E-MAIL Menu

Press:



```
01.PRINT TEXT BODY
02.BODY PAGE LIMIT
03.SEND DISPOSITION
04.PRINT HEADER ↓
```

```
05.PRINT E-MAIL ERR
06.PRINT DSN
07.PRINT DISPOSITION
08.REQUEST DSN
09.EMAIL TO FAX GTWY
10.GATEWAY PRINT
11.GATEWAY SECURITY
12.CONFIRM. TIMER
13.SET CONFIRM. TIME
14.MSG SIZE LIMIT
```

2 Display the PRINT HEADER Menu

Press:



```
PRINT HEADER
1.ON
2.OFF
```

3 Enable/Disable the Print Header

Enable or Disable the Print Header function.

1

(for ON-Enable)

2

(for OFF-Disable)

```
OPERATION COMPLETED
```

Displayed for 2 seconds



The display returns to Step 1.

Print E-mail Error Setting

This sets you would like to print only the items that can be printed normally when an error occurs. The items that the machine recognize to be erroneous are not printed.

NOTE:

- When this is set to ON, the range of the printed section varies according to the settings of Print Text Body and Print Header.
- When this is set to OFF, the machine interrupts printing if any error is found.

1 Display the E-MAIL Menu

Press:



```
01.PRINT TEXT BODY
02.BODY PAGE LIMIT
03.SEND DISPOSITION
04.PRINT HEADER ↓
```

```
05.PRINT E-MAIL ERR
06.PRINT DSN
07.PRINT DISPOSITION
08.REQUEST DSN
09.EMAIL TO FAX GTWY
10.GATEWAY PRINT
11.GATEWAY SECURITY
12.CONFIRM. TIMER
13.SET CONFIRM. TIME
14.MSG SIZE LIMIT
```

These items are outside the LCD frame. To view them, use the [▼] scroll key.

2 Display the PRINT E-MAIL ERR Menu

Press:



```
PRINT E-MAIL ERR
1.ON
2.OFF
```

3 Enable/Disable the Print E-mail Error

Enable or Disable the Print E-mail Error function.



```
OPERATION COMPLETED
```

Displayed for 2 seconds

↓
The display returns to Step 1.

Print DSN Setting

This sets whether or not the DSN is printed when it is announced from the E-mail server or the recipient.

DSN, *Delivery Status Notification*, is used to notify the sender of the status of the message that has been sent. The status, such as failed delivery, delayed delivery, successful delivery, or the gatewaying of a message into an environment that may not support DSNs, is notified when an E-mail with the DSN request is sent.

NOTE:

To receive and print the DSNs, the DSN must be generated by the remote E-mail server.

1 Display the E-MAIL Menu

Press:



```
01.PRINT TEXT BODY
02.BODY PAGE LIMIT
03.SEND DISPOSITION
04.PRINT HEADER ↓
```

```
05.PRINT E-MAIL ERR
06.PRINT DSN
07.PRINT DISPOSITION
08.REQUEST DSN
09.EMAIL TO FAX GTWY
10.GATEWAY PRINT
11.GATEWAY SECURITY
12.CONFIRM. TIMER
13.SET CONFIRM. TIME
14.MSG SIZE LIMIT
```

These items are outside the LCD frame. To view them, use the [▼] scroll key.

2 Display the PRINT DSN Menu

Press:



```
PRINT DSN
1.ON
2.OFF
```

3 Enable/Disable the Print DSN

Enable or Disable the Print DSN function.



(for ON-Enable)



(for OFF-Disable)

```
OPERATION COMPLETED
```

Displayed for 2 seconds



The display returns to Step 1.

Print Disposition Setting

This sets whether or not the MDN is printed when it is announced from the recipient. The machine sends the MDN request to the recipient in every transmission, so that the machine receives the MDN when the recipient supports the MDN request.

MDN, *Message Disposition Notification*, is used to notify the sender of the disposition of a message after it has been successfully delivered to a recipient.

NOTE:

The MDN may not reply when the environment or the recipients does not support the MDN.

1 Display the E-MAIL Menu

Press:

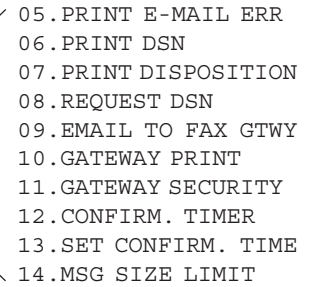
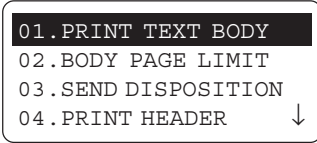

These items are outside the LCD frame. To view them, use the [▼] scroll key.

2 Display the PRINT DISPOSITION Menu

Press:



3 Enable/Disable the Print Disposition

Enable or Disable the Print Disposition function.



Displayed for 2 seconds



The display returns to Step 1.

Request DSN Setting

This sets whether or not the DSN is requested when sending a document from the machine using the Internet FAX function.

DSN, Delivery Status Notification, is used to notify the sender of the status of the message that has been sent. The status, such as failed delivery, delayed delivery, successful delivery, or the gatewaying of a message into an environment that may not support DSNs, is notified when an E-mail with the DSN request is sent.

NOTE:

The DSN may not reply when the Incoming E-mail server of the recipient does not support or generate the DSN. In this case, the error logs are retained in the E-mail server of the recipient. These error logs may be an obstacle to the mail server. Therefore, it is recommended to select OFF for this function if you are not sure that the E-mail server of the recipient supports the DSN.

1 Display the E-MAIL Menu

Press:



```
01 .PRINT TEXT BODY
02 .BODY PAGE LIMIT
03 .SEND DISPOSITION
04 .PRINT HEADER ↓
```

```
05 .PRINT E-MAIL ERR
06 .PRINT DSN
07 .PRINT DISPOSITION
08 .REQUEST DSN
09 .EMAIL TO FAX GTWY
10 .GATEWAY PRINT
11 .GATEWAY SECURITY
12 .CONFIRM. TIMER
13 .SET CONFIRM. TIME
14 .MSG SIZE LIMIT
```

These items are outside the LCD frame. To view them, use the [▼] scroll key.

2 Display the REQUESTDSN Menu

Press:

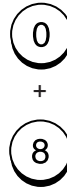

```
REQUEST DSN
1 .ON
2 .OFF
```

3 Enable/Disable the Request DSN

Enable or Disable the Request DSN function.

1

(for ON-Enable)

2

(for OFF-Disable)

OPERATION COMPLETED

Displayed for 2 seconds



The display returns to Step 1.

Confirmation Timer Setting

This sets whether or not the alert report is printed when the machine does not receive a MDN reply from recipients, in the time interval set in "Set Confirm. Time."

When the I-Fax message that you sent from the machine is not received successfully by recipients, you cannot get any response for the MDN. In this case, you can print the alert report tells you the machine does not receive the MDN from the recipients by setting this item ON.

NOTE:

If the Incoming E-mail server of the recipient does not support the MDN, the machine prints the alert report whether the recipient receives the document successfully or not. If you are not sure that the recipients can reply the MDN request, it is recommended to select OFF.

1 Display the E-MAIL Menu

Press:



```
01.PRINT TEXT BODY
02.BODY PAGE LIMIT
03.SEND DISPOSITION
04.PRINT HEADER ↓
```

```
05.PRINT E-MAIL ERR
06.PRINT DSN
07.PRINT DISPOSITION
08.REQUEST DSN
09.EMAIL TO FAX GTWY
10.GATEWAY PRINT
11.GATEWAY SECURITY
12.CONFIRM. TIMER
13.SET CONFIRM. TIME
14.MSG SIZE LIMIT
```

These items are outside the LCD frame. To view them, use the [▼] scroll key.

2 Display the Confirm. Timer Menu

Press:



```
CONFIRMATION TIMER
1.ON
2.OFF
```

3 Enable/Disable the Confirmation Timer

Enable or Disable the Confirmation Timer function.



```
OPERATION COMPLETED
```

Displayed for 2 seconds



The display returns to Step 1.

Set Confirmation Time Setting

This sets the time interval to wait for the MDN reply before printing the alert report.

This setting is available when "Confirm. Timer" is set to ON.

1 Display the E-MAIL Menu

Press:



01. PRINT TEXT BODY
02. BODY PAGE LIMIT
03. SEND DISPOSITION
04. PRINT HEADER ↓

05. PRINT E-MAIL ERR
06. PRINT DSN
07. PRINT DISPOSITION
08. REQUEST DSN
09. EMAIL TO FAX GTWY
10. GATEWAY PRINT
11. GATEWAY SECURITY
12. CONFIRM. TIMER
13. SET CONFIRM. TIME
14. MSG SIZE LIMIT

These items are outside the LCD frame. To view them, use the [▼] scroll key.

2 Display the Set Confirm. Time Menu

Press:



SET CONFIRM. TIME
1. 15MINS
2. 30MINS
3. 1HR ↓

4. 4HRS
5. 24HRS

These items are outside the LCD frame. To view them, use the [▼] scroll key.

3 Select the Confirmation Time

Select the desired Confirmation Time.

Press:

1
(for 15MINS)

2
(for 30MINS)

3
(for 1HR)

4
(for 4HRS)

5
(for 24HRS)

OPERATION COMPLETED

Displayed for 2 seconds



The display returns to Step 1.

MSG Size Limit Setting

This sets the maximum size for sending documents using the Internet FAX function. If the size of documents exceeds the maximum size, the machine sends the documents separately.

NOTE:

The document that contains only one page of an image cannot be separated even if the document size exceeds the limit. In this case, the machine interrupts the job.

1 Display the E-MAIL Menu

Press:



```
01.PRINT TEXT BODY
02.BODY PAGE LIMIT
03.SEND DISPOSITION
04.PRINT HEADER ↓
```

```
05.PRINT E-MAIL ERR
06.PRINT DSN
07.PRINT DISPOSITION
08.REQUEST DSN
09.EMAIL TO FAX GTWY
10.GATEWAY PRINT
11.GATEWAY SECURITY
12.CONFIRM. TIMER
13.SET CONFIRM. TIME
14.MSG SIZE LIMIT
```

These items are outside the LCD frame. To view them, use the [▼] scroll key.

2 Display the MSG Size Limit Menu

Press:



```
MSG SIZE LIMIT
1.0.5MBYTE
2.1.0MBYTE
3.1.5MBYTE ↓
```

```
4.2.0MBYTE
5.2.5MBYTE
```

These items are outside the LCD frame. To view them, use the [▼] scroll key.

3 Select the MSG Size Limit

Select the desired MSG Size Limit.

Press:

1
(for 0.5Mbyte)

2
(for 1.0Mbyte)

3
(for 1.5Mbyte)

4
(for 2.0Mbyte)

5
(for 2.5Mbyte)

```
OPERATION COMPLETED
```

Displayed for 2 seconds



The display returns to Step 1.

- ONRAMP GATEWAY SETUP

Onramp Gateway uses the relay function which is one of the ITU-T Mailbox features. The ITU-T F-code compliant facsimiles can send the document to the Relay Mailbox in the machine and then the DP120F/DP125F transfers the document to the E-mail addresses of other Internet Fax machines and client computers programmed in the Relay Box.

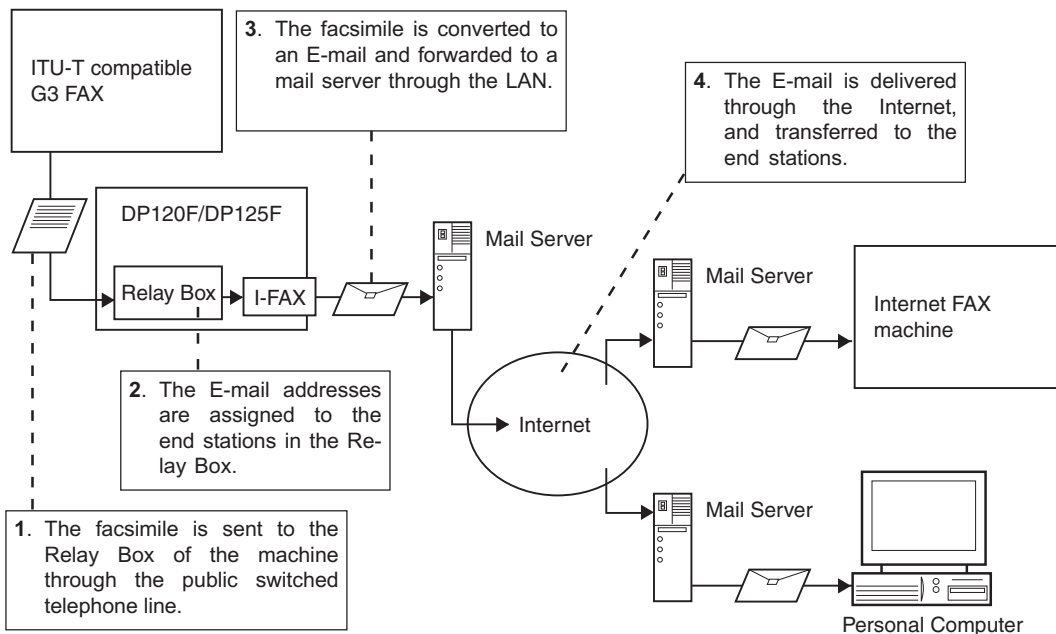

To use this machine as the Hub Station for Onramp Gateway transmission, set up a Relay Box in the DP120F/DP125F hub unit. Using this function, all ITU-T F-code compliant facsimiles can receive or transmit documents to and from the DP120F/DP125F. Relay Boxes must be setup prior to utilizing the DP120F/DP125F as a Relay Box Hub. For more information, see the section about "RELAY TRANSMISSION" in the DP120F/125F OPERATOR'S MANUAL.

You can assign a maximum of 50 End Stations. Both E-mail addresses and facsimile numbers can be assigned in a Relay Box. When the End Stations are the facsimile numbers, you can assign them using Abbreviated Dial Numbers, One Touch Keys, and Group Numbers. However, when the End Stations are E-mail addresses, you can assign them only using Abbreviated Dial Numbers and One Touch Keys.

This section describes the procedures to assign the E-mail addresses to a Relay Box.

NOTE:
To assign the facsimile numbers to a Relay Box, see the section about "RELAY TRANSMISSION" in the DP120F/125F OPERATOR'S MANUAL.

Setting Up a Relay Box with E-mail Address

1 Display the MAILBOX Menu

Turn the Flip Panel to the "50-73" view to select the desired Function Key.

Press:

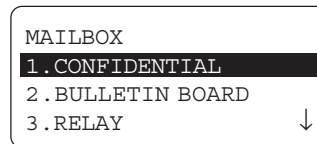

4. BOX SETUP
These item is outside the LCD frame. To view them, use the [▼] scroll key.

2 Select SETUP & DELETE

Select "4.BOX SETUP" by pressing:



Setting Up a Relay Box with E-mail Address - continued

3 Select MAILBOX SETUP

Select "2.MAILBOX SETUP" by pressing:

2

MAILBOX TYPE
1 . CONFIDENTIAL
2 . BULLETIN BOARD
3 . RELAY

4 Select the RELAY

Select "3.RELAY" by pressing:

3

ENTER NEW BOX NBR
BOX NUMBER = (MAX20)
■

5 Enter the Box Number

PROGRAM PASSWORD?
1 . YES
2 . NO

6 Select the Password Option

Select whether or not to use the password option for this relay box.

To set the password option for this relay box, press:

1

Go to Step 7.

If you do not wish to set the password option with this relay box, press:

2

Go to Step 8.

7 Enter the Password

Enter the password (max. 20 digits).

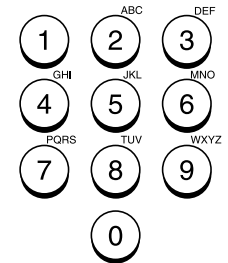

ENTER PASSWORD
PASSWORD = (MAX20)
XXXXX■

Then press:



RELAY END NUMBER
PRESS E-MAIL KEY,
SPEED DIAL KEY OR
ONE TOUCH KEY

Setting Up a Relay Box with E-mail Address - continued

8 Enter the End Station

Repeat this step until all of the required end stations are entered. Then go to Step 9.

NOTE:

Also the facsimile numbers can be assigned to a Relay Box where E-mail addresses have been assigned. To assign the facsimile numbers to a Relay Box, see the section about "RELAY TRANSMISSION" in the DP120F/125F OPERATOR'S MANUAL.

Press:

E-MAIL ADDRESS



RELAY END NUMBER

PRESS SPEED DIAL KEY
OR ONE TOUCH KEY

NOTE:

Group Numbers cannot be used in conjunction with E-mail addresses in a relay box.

8a Enter the One Touch Key of End Station

If an end station is assigned to a One Touch Key, press:

Example: One Touch Key 35.

35



RELAY END NUMBER

ONE TOUCH = 35
XXXXXX

After 2 seconds:

RELAY END NUMBER
ONE TOUCH = 35
ENTER MORE OR
PRESS [START]

Continue the operation from the beginning of Step 8.

If no E-mail address is assigned to this One Touch key, the following screen is displayed.

RELAY END NUMBER

ONE TOUCH = 35
NOT ENTRY

After 2 seconds:

RELAY END NUMBER
PRESS E-MAIL KEY,
SPEED DIAL KEY OR
ONE TOUCH KEY

Try again from the beginning of Step 8.

Setting Up a Relay Box with E-mail Address - continued

8 Enter the End Station - continued

8b Enter the Abbreviated Dial Number of End Station

If an Abbreviated Dial Number is assigned to the end station, press:



Enter the Abbreviated Dial Number.

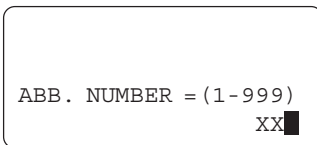
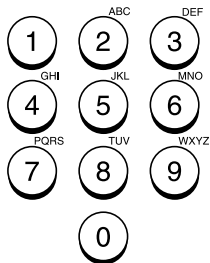

Then press:

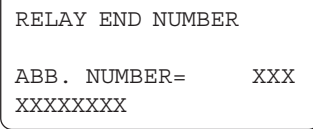

After 2 seconds:

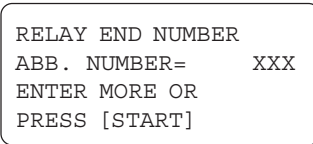

Continue the operation from the beginning of Step 8.

If no E-mail address is assigned to the Abbreviated Dial Number, the following screen is displayed.

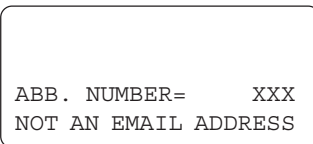

After 2 seconds:

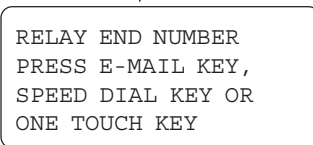

Try again from the beginning of Step 8.

9 Complete the End Station Entry

When all the desired End Station Entries (One Touch Keys or Abbreviated Dial Numbers) are completed under the same Relay Box, press:

START

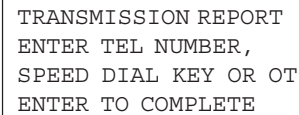

10 Enter the Number to send the Transmission Result

Enter the facsimile number you want to send the relay transmission report (relay transmission End Stations results) to.

If you do not desire a relay transmission report, press:



The following screen is displayed for about 2 seconds to indicate that the Mailbox is registered.



The display returns to the screen in Step 2.

10a Enter the Number Using the Dial Keypad

Enter the facsimile number using the Dial Keypad.

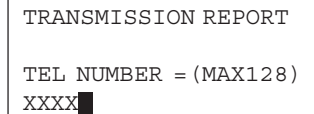
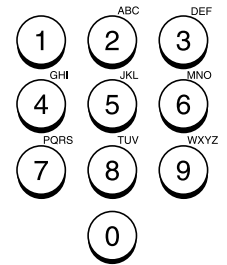

Then press:



The following screen is displayed for about 2 seconds to indicate that the Mailbox is registered.



Setting Up a Relay Box with E-mail Address- continued

10 Enter the Number to send the Transmission Result - continued

10b Enter the Number using the One Touch Key

Press the desired One Touch Key.

Example: One Touch Key 01.

01

TRANSMISSION REPORT
ONE TOUCH 01

The following screen is displayed for about 2 seconds to indicate that the Mailbox is registered.

REGISTERED

The display returns to the screen in Step 2.

10b Enter the Number using the Abbreviated Dial Number

Press the desired Abbreviated Dial Number.

SPEED DIAL

+
1

Enter the Abbreviated Dial Number.

1 2 3
GHI JKL MNO
4 5 6
PQRS TUV WXYZ
7 8 9
0

TRANSMISSION REPORT
ABB. NBR= 001

10 Complete the Relay Box Setup

If you complete the Relay Box Setup, press:

1

The display returns to the Standby Mode.

Then press:

ENTER ←

The following screen is displayed for about 2 seconds to indicate that the Mailbox is registered.

REGISTERED

The display returns to the screen in Step 2.

- OFFRAMP GATEWAY SETUP

Offramp Gateway, Offramp Gateway Overview

◆ What is a “Offramp Gateway”?

This machine can be used as a Hub Station to forward E-mails from your client computer or Internet Fax machine to the any facsimile through the public switched telephone network.

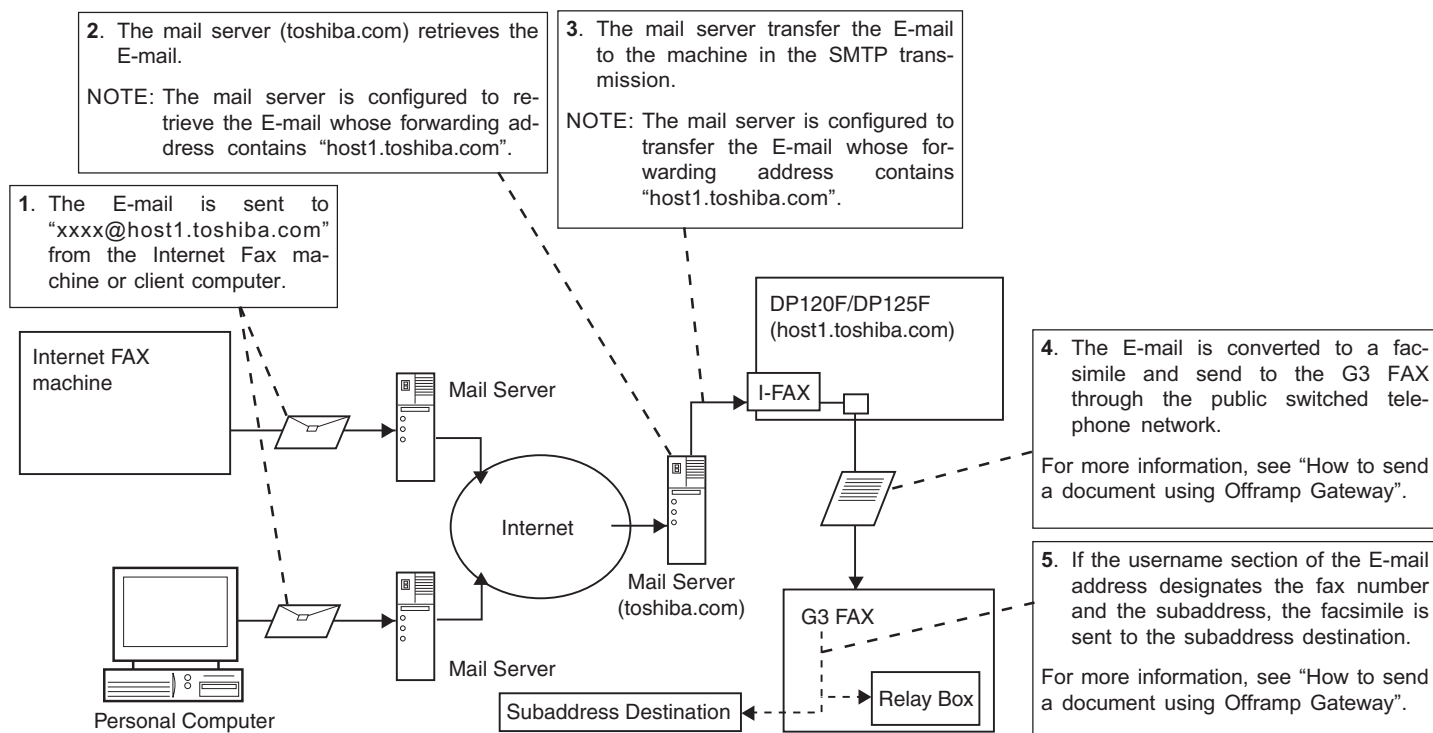

For example, the document can be sent to the machine in a country or city through the Internet, then the document is sent from this machine to the any facsimiles through the local public telephone line.

◆ What is “SMTP”?

This machine uses Simple Mail Transfer Protocol (SMTP) to enable the Offramp Gateway transmission. “SMTP” is a server protocol for sending E-mail messages between servers. Usually the E-mail systems that transfer E-mails over the Internet use the SMTP to send messages from one server to another. Therefore, when this machine uses the SMTP to transfer E-mails, this machine works as a mail server.

◆ How this machine can receive E-mail through SMTP?

For the DP120F/DP125F to receive transmissions in SMTP mode from the mail server, the specific domain (that relates to the DP120F/DP125F) E-mail address must be set up on the Host mail server. To set this on the mail server, the hostname of this machine must be designated. If the hostname of this machine is designated as “host1.toshiba.com”, it is set to transfer the E-mail to this machine when an E-mail to “xxx@host1.toshiba.com” is delivered to the Internet.

How to send a document using Offramp Gateway

Using the Offramp Gateway transmission, you can send E-mail documents to a facsimile connected in the public switched telephone network. Also, this machine supports addressing the ITU-T Mailbox in the remote facsimile.

When you send an E-mail using the Offramp Gateway transmission, the syntax of the Offramp-email-address must be specified correctly.

● Sending to Facsimile

Offramp-email-address syntax:

FAX=xxxxxxxx@FQDN

["xxxxxxxx" is the telephone number of a facsimile.]

For example when the assigned domain name (FQDN) for this machine is "host1.toshiba.com" and the facsimile number is "1212121212":

i.e. FAX=1212121212@host1.toshiba.com

● Sending to Subaddress

Offramp/subaddress-email-address syntax:

FAX=xxxxxxxx/T33S=yyyy@FQDN

["xxxxxxxx" is the telephone number of a facsimile.]

["yyyy" is the subaddress.]

SUPPLEMENT:

"T33S" is a syntax code to specify a subaddress. When you send to a subaddress using the Offramp Gateway, the facsimile number and the subaddress number is separated with "/".

For example when the assigned domain name (FQDN) for this machine is "host1.toshiba.com", the facsimile number is "1212121212", and the subaddress is "1234":

i.e. FAX=1212121212/T33S=1234@host1.toshiba.com

NOTE:

Any international telephone number entry is not accepted for the facsimile number in the Offramp-email-address.

Setting Up for Offramp Gateway

To setup this machine for the Offramp Gateway transmission:

| E-mail Account Setup | Note |
|----------------------|--|
| E-mail Address | The domain of your E-mail address becomes a name added the sub-address for this machine and domain name of the SMTP server. For example, if the domain name of the mail server is "toshiba.com" and sub-address of this machine is "host1", the domain of the E-mail address for this machine will be a FQDN ^{*1} that the sub-address is added to this domain. [i.e. username@host1.toshiba.com] (See page 60.) |
| Receive Mode | Set to "SMTP". (See page 62.) |
| SMTP Server Address | Assign the IP address of the main mail server that supplies the domain for your machine. (See page 67.) |

*1 "Fully Qualified Domain Name" consists of a host name and domain name.

| Offramp Gateway Properties Setup | Note |
|----------------------------------|--|
| E-mail to FAX Gateway | This sets the machine to allow forwarding the document that is received by the Offramp Gateway transmission. (See page 87.) |
| Gateway Print | This sets whether to print the document sent from the Internet FAX machine using the Offramp Gateway transmission. The machine prints the document before forwarding it to the facsimile, so that you can confirm what is sent using the Offramp Gateway. (See page 88.) |
| Gateway Security | This sets whether to check the fax number where the document is being sent to before allowing the document to be forwarded via the Offramp gateway. If the fax number of the facsimile is not registered as One Touch dials or Abbreviated dials, the machine does not allow the Offramp Gateway for this document. (See page 89.) |

Important:

Some settings are required to be configured at the SMTP server.

- The domain name for this machine must be assigned on the main SMTP server.
- Set up the SMTP server to forward the E-mail to this machine when the SMTP server receives an E-mail whose address contains the host name for this machine.

Ask your administrator to set up the SMTP server.

E-mail to FAX Gateway Setting

This sets the machine to allow forwarding the document that is received by the Offramp Gateway transmission.

If this is set to ON, it is recommended to set up "Gateway Print" and "Gateway Security".

1 Display the E-mail Menu

Press:



```
01.PRINT TEXT BODY
02.BODY PAGE LIMIT
03.SEND DISPOSITION
04.PRINT HEADER ↓
```

```
05.PRINT E-MAIL ERR
06.PRINT DSN
07.PRINT DISPOSITION
08.REQUEST DSN
09.EMAIL TO FAX GTWY
10.GATEWAY PRINT
11.GATEWAY SECURITY
12.CONFIRM. TIMER
13.SET CONFIRM. TIME
14.MSG SIZE LIMIT
```

These items are outside the LCD frame. To view them, use the [▼] scroll key.

2 Display the EMAIL TO FAXGTWY Menu

Press:



```
EMAIL TO FAX GTWY
1.ON
2.OFF
```

3 Enable/Disable the EMAIL TO FAX GTWY

Enable or Disable the E-mail to FAX Gateway function.

1
(for ON-Enable)

2
(for OFF-Disable)

```
OPERATION COMPLETED
```

Displayed for 2 seconds

↓
The display returns to Step 1.

Gateway Print Setting

This sets whether to print the E-mail that is sent to the Offramp Gateway transmission. The machine prints the document before forwarding it to the facsimile, so that you can confirm what is being sent using the Offramp Gateway.

This setting is available when the "E-mail to FAX GTWY" is set to ON.

1 Display the E-mail Menu

Press:



01. PRINT TEXT BODY
02. BODY PAGE LIMIT
03. SEND DISPOSITION
04. PRINT HEADER ↓

05. PRINT E-MAIL ERR
06. PRINT DSN
07. PRINT DISPOSITION
08. REQUEST DSN
09. EMAIL TO FAX GTWY
10. GATEWAY PRINT
11. GATEWAY SECURITY
12. CONFIRM. TIMER
13. SET CONFIRM. TIME
14. MSG SIZE LIMIT

These items are outside the LCD frame. To view them, use the [▼] scroll key.

2 Display the GATEWAY PRINT Menu

Press:



PRINT COPY OF
DOCUMENT AT GATEWAY
1. ON
2. OFF

3 Enable/Disable the Gateway Print

Enable or Disable the Gateway Print function.

1
(for ON-Enable)

2
(for OFF-Disable)

OPERATION COMPLETED

Displayed for 2 seconds

↓
The display returns to Step 1.

Gateway Security Setting

This sets whether to check the fax number where the document is sent before allowing the Offramp Gateway.

If the fax number of the facsimile is not registered as One Touch dials or Abbreviated dials, the machine does not allow the Offramp Gateway for this document.

This setting is available when the "E-mail to FAX GTWY" is set to ON.

NOTE:

Any person who knows the sub-domain of your machine, can send documents from another Internet Fax machine by the Offramp Gateway transmission regarding your machine as the relay station. This item is for setting the security for E-mail to FAX Gateway function.

1 Display the E-mail Menu

Press:



```
01.PRINT TEXT BODY
02.BODY PAGE LIMIT
03.SEND DISPOSITION
04.PRINT HEADER
```

```
05.PRINT E-MAIL ERR
06.PRINT DSN
07.PRINT DISPOSITION
08.REQUEST DSN
09.EMAIL TO FAX GTWY
10.GATEWAY PRINT
11.GATEWAY SECURITY
12.CONFIRM. TIMER
13.SET CONFIRM. TIME
14.MSG SIZE LIMIT
```

These items are outside the LCD frame. To view them, use the [▼] scroll key.

2 Display the GATEWAY SECURITY Menu

Press:



```
GATEWAY SECURITY
1.ON
2.OFF
```

3 Enable/Disable the Gateway Security

Enable or Disable the Gateway Security function.

1
(for ON-Enable)

2
(for OFF-Disable)

```
OPERATION COMPLETED
```

Displayed for 2 seconds

The display returns to Step 1.

- ADDITIONAL FUNCTIONS SETUP

The following additional functions are available when the Internet Fax kit is installed to the machine.

- FTP Server Login Name
- FTP Server Login Password
- LAN FAX
- IPX/SPX Protocol
- Frame Type

FTP Server Login Name Setting

This allows you to set the user name to log into the FTP server on the machine.

The user name is required to transmit data between a personal computer and the machine using the TOSHIBA Viewer.

NOTE:

The "public" is assigned as the default login name.

1 Display the FTP Menu

Press:



01.FTP SRV LOGIN NAM
02.FTP SRV LOGIN PWD

2 Display the FTP SRV LOGIN NAM Menu

Press:



FTP SRV LOGIN NAME
(MAX 32:)
public

3 Enter the Login Name

Enter the Login Name using the Keyboard and Numeric Keypad.

FTP SRV LOGIN NAME
(MAX 32:)
XXXXX

When the correct Login Name is displayed, press:



The display returns to Step 1.

FTP Server Login Password Setting

This allows you to set the password to log into the FTP server on the machine. This password is required to transmit data between a personal computer and the machine using the TOSHIBA Viewer.

NOTE:

The "pass" is assigned as the default login password.

1 Display the FTP Menu

Press:



```
01.FTP SRV LOGIN NAM
02.FTP SRV LOGIN PWD
```

2 Display the FTP SRV LOGIN PWD Menu

Press:

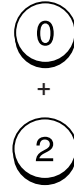

```
FTP SRV LOGIN PWD
(MAX 32:)
pass
```

3 Enter the Login Password

Enter the Login Password using the Keyboard and Numeric Keypad.

```
FTP SRV LOGIN PWD
(MAX 32:)
XXXXX
```

When the correct Login Password is displayed, press:



The display returns to Step 1.

LAN FAX Setting

This allows you to set the IP address of the ImageVision2000 or SmartLink server. Only the server assigned here can access this machine.

1 Display the LAN FAX Menu

Press:



01.LAN FAX SRV ADDR

2 Display the LAN FAX SERVER ADDR Menu

Press:



LAN FAX SERVER ADDR

000.000.000.000

3 Enter the LAN FAX server address

Enter the server address of the ImageVision2000 or SmartLink2000.

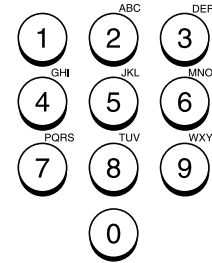

LAN FAX

172.016.110.124

When the correct LAN FAX server address is displayed, press:



OPERATION COMPLETED

Displayed for 2 seconds

The display returns to Step 1.

IPX/SPX Protocol Setting

This allows you to enable or disable the Network Interface Card to connect using the IPX/SPX protocol.

When the machine connects to the NetWare server, the IPX/SPX protocol must be set to ON.

NOTE:
This is set to ON as a factory default.

1 Display the NETWORK (NOVELL) Menu

Press:

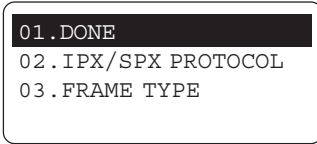

2 Display the FRAME TYPE Menu

Press:



3 Select the IPX/SPX Protocol Mode

Enable or Disable to use the IPX/SPX Protocol.

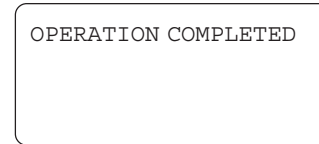

Displayed for 2 seconds



The display returns to Step 1.

Continue to set another item, or press 0 + 1 to select "1.DONE" to exit the Menu Operation mode and return to the Standby Mode.

When "1.DONE" is selected, the Network Interface Card starts initializing. Wait for few minutes until the Network Interface Card completes initializing.

Frame Type Setting

This allows you to change the frame type of the Network Interface Card.

When the machine connects to the NetWare server, the machine uses this frame type.

NOTE:

The "AUTO" is set as the default frame type.

1 Display the NETWORK (NOVELL) Menu

Press:



```
01 . DONE
02 . IPX/SPX PROTOCOL
03 . FRAME TYPE
```

2 Display the FRAME TYPE Menu

Press:

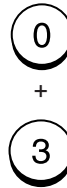

```
FRAME TYPE
01 . AUTO
02 . 802.3
03 . ETHERNET II
```

04 . 802.3 SNAP
05 . 802.2

These items are outside the LCD frame. To view them, use the [▼] scroll key.

3 Select the frame type

Select the desired frame type.

Press:

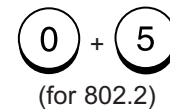
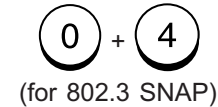
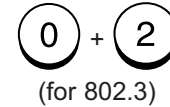
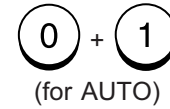

OPERATION COMPLETED

Displayed for 2 seconds



The display returns to Step 1.

The display returns to Step 1.

Continue to set another item, or press 0 + 1 to select "1.DONE" to exit the Menu Operation mode and return to the Standby Mode.

When "1.DONE" is selected, the Network Interface Card starts initializing. Wait for few minutes until the Network Interface Card completes initializing.

DSN Report

Successful Report of DSN

```
From      : System Administrator <postmaster@TOSHIBA.COM>
To        : ifax <ifax@TOSHIBA.COM>
Cc        :
Date      : Fri, 2 Mar 2001 11:53:43 +0900
Subject   : Delivered: Internet Fax MAIL
```

Your message

```
To:      user01
Subject:  Internet Fax MAIL
```

was delivered to the following recipient (s) :

```
user01 on Fri, 2 Mar 2001 11:39:17 +0900
```

This message indicates that the E-mail was successfully sent to the recipients.

Unsuccessful Report of DSN

```
From      : System Administrator <postmaster@TOSHIBA.COM>
To        : ifax <ifax@TOSHIBA.COM>
Cc        :
Date      : Fri, 2 Mar 2001 11:53:43 +0900
Subject   : Undelivered: Internet Fax MAIL
```

Your message

```
To:      user01
Subject:  Internet Fax MAIL
```

did not reach the following recipient (s) :

```
user01@toshiba.com on Fri, 2 Mar 2001 11:39:17 +0900
The recipient name is not recognized
The MTS-ID of the original message is : c=US;a=
;p=Toshiba;I=MARSHAL0103020253GDXCQP26
MSEXCH:IMS:Toshiba:TOSHIBA.COM:MARSHAL 0 (000C05A6) Unknown
Recipient
```

This message indicates that the E-mail was not delivered successfully to the recipients.

This is a notification message that the mail server has successfully or unsuccessfully delivered the E-mail message to a recipient.

Printing Procedure

Auto Print (if programmed; see page 74):

Printing will automatically start when the DSN message is received from the mail server.

NOTE:

To receive the DSN from the mail server, you must send an E-mail with the DSN request. To set this option, see page 76.

Also, the mail server of the recipients should support the DSN.

MDN Report

From : <ifax@toshiba.com>
To : <user01@toshiba.com>
Cc :
Date : Fri, 2 Mar 2001 11:53:43 +0900
Subject : Disposition notification (MDN) : Success
Message ID : <200103025113610.43@Ifxa.toshibatec.com>

This report relates to a message you sent with the following header fields:

Message-id: <200103025113610.43@Ifxa.toshibatec.com>
To: user01@toshiba.com
Subject: Internet Fax MAIL

This is a Return Receipt for the mail that you sent to the above recipient.
The message and attached file may have been printed or saved. This is no guarantee that the message has been read or understood.

Reporting-UA: Ifxa.toshibatec.com
Original-Recipient: rfc822;ifax@toshiba.com
Final-Recipient: rfc822;user01@toshiba.com
Original-message-ID: <200103025113610.43@Ifxa.toshibatec.com>
Disposition: automatic-action/MDN-sent-automatically;dispatched
Media-Accept-Features: (&(color=Binary)
(image-file-structure=TIFF-limited)
(| (image-coding= [MH, MR, MMR])
& (image-coding=JBIG)
(image-coding-constraint=JBIG-T85)
(JBIG-stripe-size=128)))
(| (&(dpi=200) (dpi-xyratio= [200/100, 1, 200/400]))
(&(dpi=300) (dpi-xyratio=1))
(&(dpi=400) (dpi-xyratio=1))
(paper-size= [A4, legal, letter])
(MRC-mode=0)
(ua-media=stationery)

This is a notification message that the recipient has successfully received the E-mail message.

Printing Procedure

Auto Print (if programmed; see page 75):

Printing will automatically start when the MDN message is received from the recipient.

NOTE:

To receive the MDN from the recipient, you must send an E-mail with the MDN request. To set this option, see page 71.

SUPPLEMENT:

The MDN will not print if the E-mail message has not been successfully received by the recipient, or the recipient does not support the MDN. In this case, you can print the Alert Report that tells you have not received the MDN from the recipient. See page 97 about the Alert Report.

Alert Report

MAR-02-01 11:22 F- 039 ALERT REPORT

PAGE : 001
DATE & TIME : MAR-02-01 11:37
E-MAIL : ifax@toshiba.com

JOB NUMBER : 039
DATE : MAR-02-01 11:22
TO : user01@toshiba.com
NUMBER OF PAGES : 001
STATUS : *** NOT SURE IF THIS MESSAGE WAS SENT OR NOT, BECAUSE MDN NOT RECEIVED ***

This is a alert report that the recipient has not responded for the MDN.

Printing Procedure

Auto Print (if programmed; see page 77):

Printing will automatically start when the time interval set has passed after the E-mail message with MDN request has been sent.

NOTE:

This report indicates that the you could not received the MDN from the recipient. This report may be printed although the E-mail message is successfully received by recipients in case the recipients do not support MDN.

- LIST AND REPORT PRINT FORMAT AND PRINTING PROCEDURE

Transmission/Reception Journal (Communication Journal)

"TO" is replaced with "FROM" in a RECEPTION JOURNAL

Facsimile/Telephone Number of this facsimile unit, Line 1

Facsimile/Telephone Number of this facsimile unit, Line 2

E-mail Address of this facsimile unit

Your Station's ID Name

Time of output of this list or report

Machine Counter Information

List/Report Name

TRANSMISSION JOURNAL

PAGE : 001
 TIME : MAY-17-00 14:25
 TEL NUMBER1 : 12345678901234567890
 TEL NUMBER2 : 12345678901234567890
 E-MAIL : ifax@toshiba.com
 NAME : ABCDEFGHIJKLMNOPQRSTUVWXYZ12345678901234
 SCAN COUNT : 1234 (000004D2)
 PRINT COUNT : 2345 (00000929)
 DRUM COUNT : 3456 (00000D80)

| NBR. | FILE NBR | DATE | TIME | DURATION | PGS | TO | DEPT NBR | ACCOUNT | MODE | STATUS |
|------|----------|--------|-------|----------|-----|--------------------|----------|---------|-----------|--------|
| 001 | 020 | MAY-17 | 12:06 | 00/25 | 003 | user02@toshiba.com | | | ML 00 | OK |
| 002 | 020 | MAY-17 | 14:01 | 59/59 | 099 | ◆+1234567890 | 01 | 9999 | ◆G3 502 P | NG 20 |

Serial No. (lists the transmissions in the order they took place)

Date and Time the communication started

Length of each transaction: Minutes/Seconds

Number of Pages

Remote Station's Fax/Telephone Number or E-mail Address ("◆" is alternate number or sub-address dial was used.)

Account No. (printed only when the Account Number option is ON and used)

Communication Mode
 G3 = G3
 EC = ECM
 EX = ECM with shortened protocol
 ML = E-mail
 HW, HR = RDC communication ("◆" is 2nd line communication)

Department No. (indicates the department responsible for this transmission job; printed only when the Department Control option is ON)

Result:
 OK (successful)
 NG (failure)
 P = Polling
 SR, R = Relay Communication
 SB = Mailbox Communication

| | 1st (bps) | 2nd (Resolution) | 3rd (Mode) |
|---|-----------|------------------|------------|
| 0 | 2400 | 8x3.85 | MH |
| 1 | 4800 | 8x7.7 | MR |
| 2 | 7200 | 8x15.4 | MMR |
| 3 | 9600 | - | JBIG |
| 4 | 12000 | 16x15.4 | |
| 5 | 14400 | | |
| 6 | V.34 | | |
| 8 | | 300dpi | |

Transmission/Reception Journal shows the result of each communication for up to the past 150 transmissions/receptions.

Printing Procedure

Auto Print (available if programmed; see page 195 of the DP120F/DP125F Operator's Manual):

Printing will automatically start whenever 150 transmissions (or 150 receptions) are completed.

Manual Print (always available; see page 196 of the DP120F/DP125F Operator's Manual):

VERY IMPORTANT:
 Up to date Activity Journals must be maintained by the user. In the event an electronic circuit board must be replaced in this unit, information pertaining to Scan, Print, and Drum counters must be entered into the replacement electronic circuit board. This information is listed at the top of every journal.

Memory Transmission Report

MEMORY TRANSMISSION REPORT

PAGE : 001
TIME : MAY-17-00 14:25
TEL NUMBER1 : 12345678901234567890
TEL NUMBER2 : 12345678901234567890
E-MAIL : ifax@toshiba.com
NAME : ABCDEFGHIJKLMNOPQRSTUVWXYZ12345678901234

FILE NUMBER : 070
DATE : MAY-17 14:18
TO : user01@toshiba.com
DOCUMENT PAGES : 001
START TIME : MAY-17 14:20
END TIME : MAY-17 14:23
SENT PAGES : 000
STATUS : NG 7B

- File Number of the transmission job
- Date and time when the job is accepted
- Remote Party's Name, Facsimile/Telephone Number, or E-mail Address
- Number of pages input to memory
- Time when the transmission started
- Time when the transmission ended (the time when a Recovery Transmission is designated)
- Number of pages transmitted normally
- Transmission result

This is the result report printed after a Memory Transmission. (A job transmitted after the document is first scanned into memory.)

Printing Procedure

Auto Print (if programmed, see page 198 of the DP120F/DP125F Operator's Manual):

Printing will automatically start after a transmission is completed.

Reservation List

This is a listing of the communication jobs now reserved in memory.

Printing Procedure

Manual Print
Turn the Flip Panel to the "50-73" view to select the desired Function Key.

Press:



RESERVATION LIST

PAGE : 001
 TIME : MAY-17-00 14:25
 TEL NUMBER1 : 12345678901234567890
 TEL NUMBER2 : 12345678901234567890
 E-MAIL : ifax@toshiba.com
 NAME : ABCDEFGHIJKLMNOPQRSTUVWXYZ12345678901234

| TX/RX | FILE NBR | FUNCTION | PGS | MAIL | DATE | TIME | TO |
|-------|----------|--------------------|-----|------|--------|-------|---------------------|
| | 015 | E-MAIL TO FAX GTWY | 001 | | MAY-16 | 22:35 | ✉user01@toshiba.com |

| POLLING/FAX MAILBOX | FILE NBR | FUNCTION | PGS | MAIL | DATE | TIME | TO |
|---------------------|----------|----------|-----|------|------|------|----|
| | | | | | | | |

| RECOVERY TX | FILE NBR | FUNCTION | PGS | MAIL | DATE | TIME | TO |
|-------------|----------|----------|-----|------|------|------|----|
| | | | | | | | |

| PC JOB | FILE NBR | FUNCTION | PGS | MAIL | DATE | TIME | TO |
|--------|----------|----------|-----|------|------|------|----|
| | | | | | | | |

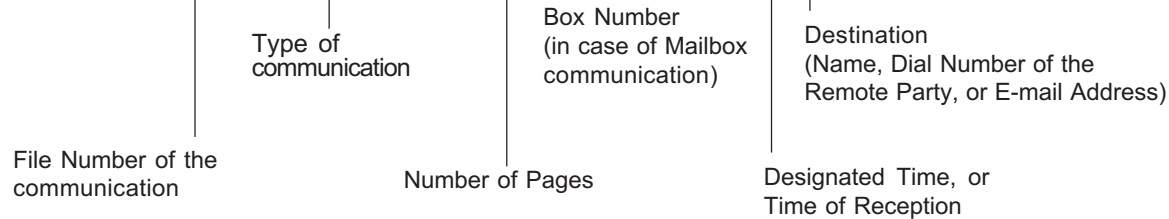

Multi-Address Transmission Report

MULTI TRANSMISSION REPORT

PAGE : 001
 TIME : MAY-17-00 14:25
 TEL NUMBER1 : 12345678901234567890
 TEL NUMBER2 : 12345678901234567890
 E-MAIL : ifax@toshiba.com
 NAME : ABCDEFGHIJKLMNOPQRSTUVWXYZ12345678901234

FILE NUMBER : 005
 DATE : MAY-17 14:18
 DOCUMENT PAGES : 15
 START TIME : MAY-17 10:56
 END TIME : MAY-17 14:18 (RECOVERY TIME:MAY-17 14:18)

SUCCESSFUL

GROUP NUMBER

| | | | | | | | | | | |
|------|--------------------|------|-----|-----|-----|-----|-----|-----|-----|-----|
| 0001 | ABCDEFGHIJKLMNQRST | ABB. | 001 | 002 | 003 | 004 | 005 | 006 | 007 | 008 |
| | | | 009 | 010 | | | | | | |
| | | OT | 02 | 05 | | | | | | |

ONE TOUCH NUMBER

01 ✉user01@toshiba.com

E-MAILS

✉user02@toshiba.com

UNSUCCESSFUL

GROUP NUMBER

| | | | | | | |
|------|----------------------|----|----|--------------------|------------|----|
| 0002 | AABBCCDDEEFFGGHHIIJJ | OT | 33 | AAABBBCCDDDEEFFFGG | SENT PAGES | 01 |
|------|----------------------|----|----|--------------------|------------|----|

Receiver where an error occurred
 SENT PAGES ... Number of pages sent normally

Receiver where the transmission was completed normally

This is the result report printed after a Multi-address Transmission.

Printing Procedure

Auto Print (if programmed; see page 199):

Printing will automatically start after all transmissions in the operation have been completed successfully or unsuccessfully.

Preset Dialing Number Lists

Alphabetical Sort List

PHONEBOOK IN ALPHABETICAL ORDER

PAGE : 001
 TIME : MAY-17-00 14:25
 TEL NUMBER1 : 12345678901234567890
 TEL NUMBER2 : 12345678901234567890
 E-MAIL : ifax@toshiba.com
 NAME : ABCDEFGHIJKLMNOPQRSTUVWXYZ12345678901234

| NAME | LOCATION | FAX NUMBER/E-MAIL ADDRESS |
|--------------------|----------|--|
| ABCDEFGHIJKLMNQRST | OT 01 | 1234567890123456789012345678901234567890 ◆0987654321 SUB:09876543210987654321 SEP:998877665544 PWD:***** ☐user01@toshiba.com ☐user02@toshiba.com |
| BCDEFGHIJKLMNQRST | ABB. 001 | |

Names of Abbreviated Dial Number, One Touch Key or Group Number

OT One Touch Key Numbers
 ABB. Abbreviated Dial Numbers
 Group Group Number

Station Dial Number/E-Mail Address

- ☐ E-mail Address
- ◆ Alternate Dial Number
- SUB, SEP, or PWD
 Type of Sub-address

Issues a listing of names programmed to Abbreviated Dial Numbers, One Touch Keys, and Group Numbers.

Printing Procedure

Turn the Flip Panel to the "50-73" view to select the desired Function Key.

Press:



TELEPHONE NBR LIST

- 1. BY NAME
- 2. ABB. NUMBERS
- 3. GROUP NUMBERS

- 4. ONE TOUCH NBR
- 5. ALL REPORT

To select "1. BY NAME," press:



Preset Dialing Number Lists - continued

Abbreviated Dial Number List

ABBREVIATED TEL NUMBER LIST

PAGE : 001
 TIME : MAY-17-00 14:25
 TEL NUMBER1 : 12345678901234567890
 TEL NUMBER2 : 12345678901234567890
 E-MAIL : ifax@toshiba.com
 NAME : ABCDEFGHIJKLMNOPQRSTUVWXYZ12345678901234

| ABB.NBR | NAME | TEL NUMBER/E-MAIL ADDRESS | TIME | MONI | BPS | REPORT | LINE | MAILMODE |
|---------|--------------------|--|-------|------|-----|--------|------|------------|
| 001 | ABCDEFGHIJKLMNQRST | 1234567890123456789012345678901234567890 | 23:45 | CN | 144 | CN | 1 | |
| | | 1234567 | | | | | | |
| | | ◆0987654321 | | | | | | |
| | | SUB:12345678901234567890 | | | | | | |
| | | SEP:112233445566 | | | | | | |
| | | PWD:***** | | | | | | |
| | | ✉user01@toshiba.com | | | | | | 200x200 MH |
| 109 | GREENVILLE OFFICE | ✉user02@toshiba.com | | | | | | 200x200 MH |

Abbreviated Dial Number: 109

Station Name: GREENVILLE OFFICE

TEL NUMBER/E-MAIL ADDRESS:

- ✉... E-mail Address
- ◆... Alternate Dial Number
- SUB, SEP, or PWD
- ... Type of Sub-address

Designated Time: 23:45

Line Monitoring: CN

Communication Speed Limit (x 100): 144

TX Report Issue/Non-issue Status: CN

Resolution: 200x200 MH

Compression: 200x200 MH

Attached Fax Option Status (if any)

Issues a list of remote station dialing numbers assigned as Abbreviated Dial Numbers.

Printing Procedure

Turn the Flip Panel to the "50-73" view to select the desired Function Key.

Press:



TELEPHONE NBR LIST

1. BY NAME
2. ABB. NUMBERS
3. GROUP NUMBERS
4. ONE TOUCH NBR
5. ALL REPORT

To select "2.ABB. NUMBERS," press:



Preset Dialing Number Lists - continued

Group Number List

GROUP NUMBER INFORMATION

PAGE : 001
TIME : MAY-17-00 14:25
TEL NUMBER1 : 12345678901234567890
TEL NUMBER2 : 12345678901234567890
E-MAIL : ifax@toshiba.com
NAME : ABCDEFGHIJKLMNOPQRSTUVWXYZ12345678901234

| GROUP NUMBER | GROUP NUMBER NAME | OT/ABB. NUMBER |
|--------------|-------------------------|---|
| 0001 | ABCDEFGHIJKLMNQRST | OT 01 02 03 04 05 06 07 08 09 10 11 12 13 14 15 16 17 18 19 20 ABB. 001 002 003 004 005 006 007 008 009 010 011 012 013 014 015 016 017 018 019 020 021 022 023 024 025 026 027 028 029 030 031 032 033 034 999 |
| 1111 1999 | ABBCCDDDEEEEEE ZZZZZ | ABB. 100 200 300 400 500 OT 31 32 33 ABB. 995 996 997 998 999 |

Group Number

Group Name

One Touch Key Numbers and Abbreviated Dial Numbers belonging to the Group:

OT One Touch Key Numbers

ABB. Abbreviated Dial Numbers

Issues a list of One Touch Key or Abbreviated Dial Numbers registered in Multi-address Groups or Multi-polling Groups.

Printing Procedure

Turn the Flip Panel to the "50-73" view to select the desired Function Key.

Press:



TELEPHONE NBR LIST

- 1. BY NAME
- 2. ABB. NUMBERS
- 3. GROUP NUMBERS

4. ONE TOUCH NBR

5. ALL REPORT

To select "3.GROUP NUMBERS," press:



Preset Dialing Number Lists - continued

One Touch Number List

ONE TOUCH NUMBER INFORMATION

PAGE : 001
 TIME : MAY-17-00 14:25
 TEL NUMBER1 : 12345678901234567890
 TEL NUMBER2 : 12345678901234567890
 E-MAIL : ifax@toshiba.com
 NAME : ABCDEFGHIJKLMNOPQRSTUVWXYZ12345678901234

| OT NBR | NAME/FUNCTION | ABB. FAX NUMBER & E-MAIL | TIME | MONI | BPS | REPORT | LINE | MAILMODE |
|--------|--------------------|---|-------|------|-----|--------|------|--------------------------|
| 01 | ABCDEFGHIJKLMNQRST | 1234567890123456789012345678901234567890 1234567 ◆0987654321 SUB:12345678901234567890 SEP:112233445566 PWD:***** ✉user01@toshiba.com ✉user02@toshiba.com | 23:45 | ON | 144 | ON | 2 | |
| 09 | ABB.NBR | | | | | | | 200x200 MH 200x200 MH |

One Touch Key Number

Station Name, or use of the key

Abbreviated Dial Number, Group Number, actual Dial Number, or E-mail Address

✉... E-mail Address

◆... Alternate Dial Number

SUB, SEP, or PWD

... Type of Sub-address

Designated Time

Line Monitoring

Communication Speed Limit (x 100)

TX Report Issue/Non-issue Status

Attached Facsimile Option Status (if any)

Resolution

Compression

Issues a list of dial numbers of the remote stations assigned to One Touch Dial Keys.

Printing Procedure

Turn the Flip Panel to the "50-73" view to select the desired Function Key.

Press:



TELEPHONE NBRS LIST

1. BY NAME
2. ABB. NUMBERS
3. GROUP NUMBERS
4. ONE TOUCH NBRS
5. ALL REPORT

To select "4. ONE TOUCH NBRS," press:



Function List

Fuction List (First Copy)

FUNCTION LIST

```
PAGE : 001
TIME : MAY-17-00 14:25
TEL NUMBER1 : 12345678901234567890
TEL NUMBER2 : 12345678901234567890
E-MAIL : ifax@toshiba.com
NAME : ABCDEFGHIJKLMNOPQRSTUVWXYZ12345678901234

DIAL TYPE(LINE1) : MF
DIAL TYPE(LINE2) : MF
CALL NUMBER :
KEYBOARD TYPE : QWERTY
MEMORY SIZE : 8MB

MACHINE SETTING
  RINGER VOLUME : 4
  ALARM VOLUME : 3
  KEY TOUCH VOLUME : 4
  MONITOR VOLUME : 4
  SUPER POWER SAVER : MANUAL
  PRINTER POWER SAVER : ON
    START TIME : 00:00
    END TIME : 00:00
  FAX SEPARATOR PAGE : OFF
  COPY SEPARATOR PAGE : OFF
  PC SEPARATOR PAGE : OFF
  SEPARATOR PAGE TRAY : AUTO
  ACCOUNT CODE : OFF
  PRINT DENSITY : 0
  DOCUMENT LENGTH : 1m
  LINE MONITOR : OFF
  RECEIVE INTERVAL : 3MIN
  ECM : ON
  DOCUMENT MODE : STD
  CONTRAST : NORMAL
  COLLATED COPY : OFF
  LETTER HEAD PAPER : OFF
  REDIAL MODE INTERVAL : 1MIN
  REDIAL MODE COUNTER : 5
  AUTO RECEIVE MODE : AUTO
    RING DELAY : 1
  AUTO RECEIVE MODE(LINE2) : TX/RX

TX SETTINGS
  MEMORY TX : ON
  SECURITY TX : OFF
  COVER SHEET : OFF
  RECOVERY TX : OFF
  TTI : INSIDE
  SEND AFTER SCAN : OFF

RX SETTINGS
  SECURE RX : OFF
  MEMORY RX : ON
  RX REDUCTION : ON
  DISCARD : ON
  REV.ORDER PRINT : OFF
  PRIVILEGED RX : OFF
  RTI : OFF
  RX MULTI COPY : 1

REPORT & LIST
  JOURNAL
    MANUAL : TX & RX
    AUTO : ON
  FAX/POLL/RELAY REPORTS
    COMMUNICATION REPORT : ON ERROR
    A5 SIZE PRINT : OFF
    MEMORY TX : ON ERROR (IMAGE)
    A5 SIZE PRINT : OFF
    MULTI TX : ON ERROR (IMAGE)
    MULTI POLL : ON ERROR
    RELAY ORIGINATOR : ON ERROR (IMAGE)
    RELAY STATION : ON ERROR (IMAGE)
    RELAY DESTINATION : ON ERROR (IMAGE)
  RECEPTION LIST
    LOCAL MAILBOX : OFF
    REMOTE MAILBOX : OFF
    RELAY STATION : ON

REMOTE SERVICE
  REMOTE ACCESS : OFF
  DOWNLOAD : NO JOB
  RDC PASSWORD :

TOTAL PAGE
  SCAN : 237
  PRINT : 231
```

Function List - continued

Function List (Second Copy)

FUNCTION LIST

PAGE : 001
TIME : MAY-17-00 14:25
TEL NUMBER1 : 12345678901234567890
TEL NUMBER2 : 12345678901234567890
E-MAIL : ifax@toshiba.com
NAME : ABCDEFGHIJKLMNOPQRSTUVWXYZ12345678901234

NETWORK (TCP/IP)
BOOTP/DHCP : OFF
IP ADDRESS : 192.1.4.34
SUBNET MASK : 255.255.0.0
DEFAULT GATEWAY : 0.0.0.0
HOST NAME : ifax.toshiba.com
NETWORK (E-MAIL)
E-MAIL ADDRESS : ifax@toshiba.com
ERR E-MAIL FW ADDR : admin@toshiba.com
RECEIVE MODE : POP
DELIVERY NOTIFICATION : NOT SUPPORTED (POP)
POP SERVER ADDR : 192.1.5.121
POP TIME : 10MINUTES
POP LOGIN NAME : ifax
POP PASSWORD : pass
SMTP SERVER ADDR : 192.1.5.121
NETWORK (FTP)
FTP SRV LOGIN NAM : public
FTP SRV LOGIN PWD : pass
NETWORK (LAN FAX)
LAN FAX SRV ADDR : 0.0.0.0
NETWORK (NOVELL SETTING)
IPX/SPX PROTOCOL : ENABLE
FRAME TYPE : AUTO
E-MAIL
PRINT TEXT BODY : ON
BODY PAGE LIMIT : 05
SEND DISPOSITION : ON
PRINT HEADER : ON
PRINT E-MAIL ERR : ON
PRINT DSN : ON
PRINT DISPOSITION : ON
REQUEST DSN : ON
E-MAIL TO FAX GTWY : OFF
GATEWAY PRINT : ON
GATEWAY SECURITY : ON
CONFIRM. TIMER : ON
SET CONFIRM. TIME : 15MINUTES
MSG SIZE LIMIT : 2.0MBYTE
FLASH ROM (OPTION)
PROGRAM : 1AUWWTS1SPA01045
 : DEC-11-00
LANGUAGE : 2AUWWTS1SPA01015
 : SEP-01-00

Issues a list to confirm the functions currently set in this facsimile unit.

Printing Procedure

To display the main menu, press:



1.COMM. OPTIONS
2.LISTS
3.INITIAL SETUP
4.DEFAULT SETTINGS ↓

To select "2.LISTS," press:



1.FUNCTION
2.DEPARTMENT
3.ITU MAILBOX

Then, to select "1.FUNCTION," press:



Menu List

Menu List (First Copy)

MENU LIST

PAGE : 001
TIME : MAY-17-00 14:25
TEL NUMBER1 : 12345678901234567890
TEL NUMBER2 : 12345678901234567890
E-MAIL : ifax@toshiba.com
NAME : ABCDEFGHIJKLMNOPQRSTUVWXYZ12345678901234

1.COMM. OPTIONS

- 1.PAGE NUMBER
- 2.LINE MONITOR
- 3.TURNAROUND POLL
- 4.ECM
- 5.SECURITY TX

2.LISTS

- 1.FUNCTION
- 2.DEPARTMENT
- 3.ITU MAILBOX

3.INITIAL SETUP

- 1.LANGUAGE
- 2.DATE & TIME
- 3.TERMINAL ID
- 4.DIAL TYPE
- 5.NETWORK
 - 01.TCP/IP
 - 01.DONE
 - 02.BOOTP/DHCP
 - 03.IP ADDRESS
 - 04.SUBNET MASK
 - 05.DEFAULT GATEWAY
 - 06.HOST NAME
 - 02.E-MAIL
 - 01.E-MAIL ADDRESS
 - 02.ERR EMAIL FW ADDR
 - 03.RECEIVE MODE
 - 04.POP SERVER ADDR
 - 05.POP TIME
 - 06.POP LOGIN NAME
 - 07.POP PASSWORD
 - 08.SMTP SERVER ADDR
 - 03.FTP
 - 01.FTP SRV LOGIN NAM
 - 02.FTP SRV LOGIN PWD
 - 04.LAN FAX
 - 01.LAN FAX SRV ADDR
 - 05.NETWORK (NOVELL)
 - 01.DONE
 - 02.IPX/SPX PROTOCOL
 - 03.FRAME TYPE

4.DEFAULT SETTING

1.MACHINE SETTINGS

- 01.SPEAKER VOLUME
 - 01.RINGER VOLUME
 - 02.ALARM VOLUME
 - 03.KEY TOUCH VOLUME
 - 04.MONITOR VOLUME
- 02.POWER SAVER
- 03.SEPARATOR PAGE
- 04.DEPARTMENT CODE
- 05.ACCOUNT CODE
- 06.PRINTER DENSITY
- 07.DOCUMENT LENGTH
- 08.LINE MONITOR
- 09.RECEIVE INTERVAL
- 10.ECM
- 11.DOCUMENT MODE
- 12.COLLATE COPY
- 13.LETTER HEAD PAPER
- 14.REDIAL MODE
 - 01.INTERVAL
 - 02.COUNTER
- 15.AUTO RECEIVE MODE
- 16.LINE-2 MODE

2.TX SETTINGS

- 01.MEMORY TX
- 02.SECURITY TX
- 03.COVER SHEET
- 04.RECOVERY TX
- 05.TTI
- 06.SEND AFTER SCAN

3.RX SETTINGS

- 01.SECURE RX
- 02.MEMORY RX
- 03.RX REDUCTION
- 04.DISCARD
- 05.REV.ORDER PRINT
- 06.PRIVILEGED RX
- 07.RTI
- 08.RX MULTI COPY

Menu List - continued

Menu List (Second Copy)

MENU LIST

PAGE : 001
TIME : MAY-17-00 14:25
TEL NUMBER1 : 12345678901234567890
TEL NUMBER2 : 12345678901234567890
E-MAIL : ifax@toshiba.com
NAME : ABCDEFGHIJKLMNOPQRSTUVWXYZ12345678901234

4. REPORTS & LIST

- 01. JOURNAL
- 02. COMM. REPORT
 - 01. TX REPORT
 - 02. MEMORY-TX REPORT
 - 03. MULTI-ADD REPORT
 - 04. MULTIPOLL REPORT
 - 05. RELAY ORG. REP
 - 06. RELAY STN. REP
 - 07. SET RELAY END REP
- 03. RECEPTION LIST
 - 01. LOCAL MAILBOX
 - 02. REMOTE MAILBOX
 - 03. RELAY

5. REMOTE SERVICE

- 01. REMOTE ACCESS
- 02. DOWNLOAD
- 03. RDC PASSWORD
- 04. SUPPLY ORDER

6. E-MAIL

- 01. PRINT TEXT BODY
- 02. BODY PAGE LIMIT
- 03. SEND DISPOSITION
- 04. PRINT HEADER
- 05. PRINT E-MAIL ERR
- 06. PRINT DSN
- 07. PRINT DISPOSITION
- 08. REQUEST DSN
- 09. EMAIL TO FAX GTWY
- 10. GATEWAY PRINT
- 11. GATEWAY SECURITY
- 12. CONFIRM. TIMER
- 13. SET CONFIRM. TIME
- 14. MSG SIZE LIMIT

5. MENU LIST

9. TEST MODE

- 1. AUTO TEST
 - 01. ADF TEST
 - 02. KEY TEST
 - 03. LED TEST
 - 04. LCD TEST
 - 05. SPEAKER TEST
 - 06. SWITCH TEST
 - 07. TEST PRINT
- 2. INDIVIDUAL TEST
- 3. TEST RESULT LIST

Issues a list of menu items through which functions or options can be set.

This list can be a useful guide during machine programming.

Printing Procedure

To display the main menu, press:



- 1. COMM. OPTIONS
- 2. LISTS
- 3. INITIAL SETUP
- 4. DEFAULT SETTINGS ↓

- 5. MENU LIST
- 9. TEST MODE

To select "5.MENU LIST," press:



Power Failure List

POWER FAILURE LIST

PAGE : 001
 TIME : MAY-17-00 14:25
 TEL NUMBER1 : 12345678901234567890
 TEL NUMBER2 : 12345678901234567890
 E-MAIL : ifax@toshiba.com
 NAME : ABCDEFGHIJKLMNOPQRSTUVWXYZ12345678901234

| TX/RX | FILE NBR | FUNCTION |
|-------|----------|----------------|
| | 001 | MULTI TX |
| | 005 | POLLING RX |
| | 006 | PRG. CONT POLL |
| | 010 | MULTI POLLING |

| POLLING/FAX M-BOX/MAIL BOX | FILE NBR | FUNCTION | MAIL | FROM | DATE | TIME |
|----------------------------|----------|------------------|----------------------|----------------|--------|-------|
| | 101 | POLLING | | LOCAL | MAY-16 | 11:23 |
| | 106 | CONFIDENTIAL BOX | *1234567890#12345678 | 99999999999999 | MAY-17 | 07:55 |
| | 107 | BULLETIN BOARD | #####123#999* | LOCAL | MAY-17 | 07:55 |

| MEMORY RECEPTION | FILE NBR | FUNCTION | MAIL | FROM/TO | DATE | TIME |
|------------------|----------|----------|------|--------------------|--------|-------|
| | 222 | EMAIL | | ✉ ifax@toshiba.com | MAY-16 | 21:37 |

| RECOVERY TX | FILE NBR | FUNCTION |
|-------------|----------|----------|
| | 333 | EMAIL |

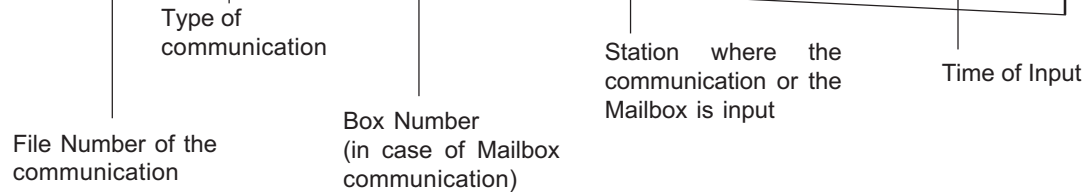

This facsimile has a battery to back up the document memory contents. However, when the power is turned off for a lengthy period (due to a power failure, etc.), the communication data stored in memory will be cleared. A list of the File Numbers of those cleared communications will be printed.

Printing Procedure

This list is automatically printed after recovery from a power failure event.

Error Messages

If an abnormal condition arises in the machine or an incorrect operation is performed, an alarm buzzer is generated for about 4 seconds and a message to indicate the nature of the error appears in the LCD Display. In that case, take corrective action according to the following table.

| Error Message | Cause / Solution ● ○ | Error Message | Cause / Solution ● ○ |
|-----------------------------|--|----------------------------|--|
| IMAGE INPUT ERROR | <ul style="list-style-type: none"> ● The connectors of the Internet Fax unit are not connected correctly or the machine or Internet Fax unit has been damaged. ○ Confirm that all connectors of the Internet Fax unit are connected to the machine correctly. If this Error Message is repeatedly displayed, the Internet Fax unit should be replaced. Call for service. | MEMORY OVERFLW | <ul style="list-style-type: none"> ● There is not enough memory to receive or send the document. ○ When this error is diaplyed during receiving an E-mail, set "Error E-mail Forward Address" to forward this document to a personal computer (see page 61). When this error is displayed during sending an E-mail, reduce the size set at "MSG Size Limit". |
| IMAGE OUTPUT ERROR | <ul style="list-style-type: none"> ● The connectors of the Internet Fax unit are not connected correctly or the machine or Internet Fax unit has been damaged. ○ Confirm that all connectors of the Internet Fax unit are connected to the machine correctly. If this Error Message is repeatedly displayed, call for service. | ERROR ANALY. MAIL | <ul style="list-style-type: none"> ● The document is sent in unknown format by the E-mail server or E-mail application of the sender. ○ Ask the sender that the E-mail application and the E-mail server is compatible with the Internet Fax. |
| IMAGE DECODING ERROR | <ul style="list-style-type: none"> ● The received document includes unknown format files or damaged image or text data. ○ Set "Error E-mail Forward Address" to forward this document to a personal computer (see page 61). | MAIL DECODING ERROR | <ul style="list-style-type: none"> ● The Internet Fax unit has been damaged. ○ Call for service. |
| MAIL RECEIVING ERROR | <ul style="list-style-type: none"> ● Failed to receive the document from the E-mail server. ○ Confirm the E-mail account settings and E-mail properties are correctly configured. | MAIL EDITING ERROR | <ul style="list-style-type: none"> ● The Internet Fax unit has been damaged. ○ Call for service. |
| | | MAIL SENDING ERROR | <ul style="list-style-type: none"> ● The destination is not found. ○ Confirm the sending or forwarding address is correct. |

Error Messages - continued

| Error Message | Cause / Solution ● ○ | Error Message | Cause / Solution ● ○ |
|-----------------------------|---|-----------------------------|---|
| SMTP SRV NOT CONNECT | <ul style="list-style-type: none"> ● The machine cannot connect to the SMTP server. ○ Confirm the setting of "SMTP Server Address" that the IP address of the SMTP server correctly assigned (see page 67). If this Error Message is repeatedly displayed, ask your administrator of the E-mail server. | INVALID ZERO DATA | <ul style="list-style-type: none"> ● "0" is entered at "Body Page Limit" or "000" is set to any 8-digit section of "IP address". ○ Input a correct value. |
| HOST NAME ERROR | <ul style="list-style-type: none"> ● Host Name is not set correctly. ○ Set the "Host Name" correctly (see page 58). | CANNOT SET TCP/IP | <ul style="list-style-type: none"> ● This error message is displayed by setting the IP address, Subnetmask, and Default Gateway while the machine obtains the TCP/IP settings from the DHCP server. ○ Set OFF the "BootP/DHCP" to assign the TCP/IP manually (see page 54). |
| E-MAIL ADDRESS ERROR | <ul style="list-style-type: none"> ● Your E-mail address is not set correctly. ○ Set the "E-mail Address" correctly (see page 60). | INVALID HOST NAME | <ul style="list-style-type: none"> ● The invalid character is entered for Host Name. ○ Input a correct value. |
| SMTP SRV NOT EXIST | <ul style="list-style-type: none"> ● The SMTP server address is not assigned. ○ Set the "SMTP Server Address" (see page 67). | INVALID E-MAIL ADDR | <ul style="list-style-type: none"> ● The invalid character is entered for E-mail Address. ○ Input a correct value. |
| OUTPUT TRAP ERROR | <ul style="list-style-type: none"> ● The Network Interface Card does not work properly while trapping. ○ Power your machine off, then back on. If the error condition is cleared, confirm normal operation. If this Error Message is repeatedly displayed, call for service. | INVALID ERR E-MAIL | <ul style="list-style-type: none"> ● The invalid character is entered for Error E-mail Forward Address. ○ Input a correct value. |
| MIB ERROR | <ul style="list-style-type: none"> ● The machine receives an invalid MIB request. ○ Confirm the sender's computer has no problems. | INVALID POP3 LOGIN | <ul style="list-style-type: none"> ● The invalid character is entered for POP Login Name. ○ Input a correct value. |
| NETWORK ACCESS ERROR | <ul style="list-style-type: none"> ● The Network Interface Card or Internet Fax unit has been damaged. ○ The Network Interface Card or Internet Fax unit must be replaced. Call for service. | INVALID POP3 PWD | <ul style="list-style-type: none"> ● The invalid character is entered for POP Password. ○ Input a correct value. |
| NETWORK INITIALIZING | <ul style="list-style-type: none"> ● The Network Interface Card is initializing. ○ Wait until the Network Interface Card completes initializing. | INVALID FTP LGN NAME | <ul style="list-style-type: none"> ● The invalid character is entered for FTP Server Login Name. ○ Input a correct value. |

Error Messages - continued

| Error Message | Cause / Solution ● ○ | Error Message | Cause / Solution ● ○ |
|-----------------------------|---|-------------------------------|--|
| INVALID FTP PASSWORD | <ul style="list-style-type: none"> ● The invalid character is entered for FTP Server Login Password. ○ Input a correct value. | POP3 SRV NOT CONNECT | <ul style="list-style-type: none"> ● The machine cannot connect to the POP server. ○ Ask your administrator of the E-mail server that the settings for your account is configured correctly. |
| ENTRY AREA FULL | <ul style="list-style-type: none"> ● There is not enough memory to store the One Touch key, Speed Dial, or dialing history. ○ Delete the unnecessary address data. | LOW BATTERY | <ul style="list-style-type: none"> ● The power of the battery of the Internet Fax unit is low. ○ Power your machine on, then wait for a while for charging. If this Error Message is repeatedly displayed, the battery must be replaced. Call for service. |
| INVALID DATA | <ul style="list-style-type: none"> ● The communication problems in the interfaces between the Mother PCB and I-FAX PCB occur. ○ Turn off the machine and then turn on to restart the machine. If the error cannot be recovered, call for service. | BATTERY ERROR | <ul style="list-style-type: none"> ● The battery is not connected to the Internet Fax unit correctly or the battery is out of order. ○ Connect the battery to the Internet Fax unit correctly. If this error message is repeatedly displayed, replace the battery. Call for service. |
| NOT POP3 RECV. MODE | <ul style="list-style-type: none"> ● This error message is displayed by pressing the [Check E-mail] key while the Receive Mode is set as SMTP. ○ Select POP for Receive Mode setting (see page 62) if your Incoming E-mail server is the POP server. If the Receive Mode is set to SMTP, the [Check E-mail] key is not available. | INTERNET FAX SENDING | <ul style="list-style-type: none"> ● This message is displayed by pressing any button on the Operation Panel while the machine is sending the E-mail. ○ Wait until sending the E-mail is finished. |
| POP3 SRV. NOT EXIST | <ul style="list-style-type: none"> ● The machine cannot find the POP server in the Network when checking the E-mail. ○ Ask your administrator of the E-mail server. | INTERNET FAX RECEIVING | <ul style="list-style-type: none"> ● This message is displayed by pressing any button on the Operation Panel while the machine is receiving the E-mail. ○ Wait until receiving the E-mail is finished. |
| IP ADDRESS NOT EXIST | <ul style="list-style-type: none"> ● The IP address is not assigned. ○ Assign the IP address (see page 55). | PRINTING... | <ul style="list-style-type: none"> ● This message is displayed by pressing any button on the Operation Panel while the machine is printing the received E-mail. ○ Wait until printing the E-mail is finished. |
| E-MAIL NOT EXIST | <ul style="list-style-type: none"> ● No E-mail has been received. | | |
| BAD POP3 LOGIN NAME | <ul style="list-style-type: none"> ● The your user name is locked to log in the POP server or the password is incorrect. ○ Confirm the POP Login Password is set correctly (see page 66) or ask your administrator of the E-mail server that your user name is not locked. | | |

Error Messages - continued

| Error Message | Cause / Solution |
|----------------------------|---|
| MIB ACCESSING | <ul style="list-style-type: none">● This message is displayed by pressing any button on the Operation Panel while the machine is analyzing the MIB.○ Wait until analyzing the MIB is finished. |
| FTP ACCESSING | <ul style="list-style-type: none">● This message is displayed by pressing any button on the Operation Panel while the machine is transmitting the data in the FTP.○ Wait until the FTP transmission is finished. |
| COMMAND ERROR | <ul style="list-style-type: none">● The command error occurs while performing the Network Test.○ Call for service. |
| S-MEDIA NOT EXIST | <ul style="list-style-type: none">● The Smart Media is not inserted while performing the Smart Test.○ Insert the Smart Media in the Smart Media slot. |
| RAM 0B:NG | <ul style="list-style-type: none">● The RAM has become defective.○ Call for service. |
| RAM 1C:NG | <ul style="list-style-type: none">● The RAM has become defective.○ Call for service. |
| CHKSUM ERR:PROGRAM | <ul style="list-style-type: none">● The programming data has been damaged.○ Call for service. |
| CHKSUM ERR:FUNCTION | <ul style="list-style-type: none">● The function setting data has been damaged.○ Call for service. |
| CHKSUM ERR:LANGUAGE | <ul style="list-style-type: none">● The language data has been damaged.○ Call for service. |
| CHKSUM ERR:BOOT | <ul style="list-style-type: none">● The boot programming data has been damaged.○ Call for service. |

Error Codes Printed on Reports

When an Error Code is printed as a status indication on Transmission Reports, etc. related to Internet Fax transmission, refer to the following description for the applicable Error Code to determine the cause.

Receive Code

| Error Code | Cause | How to Correct |
|------------|--|--|
| 70 | Memory Overflow and "Error E-mail Forward Address" is assigned | Contact your sender to resend the document by reducing the sent pages. Or confirm the E-mail data forwarded to the "Error E-mail Forward Address". |
| 71 | Memory Overflow | Contact your sender to resend the document by reducing the sent pages. |
| 72 | Attached File Error and "Error E-mail Forward Address" is assigned | Confirm the settings of related Network data such as E-mail address, IP address or SMTP server address, etc. Or confirm the E-mail data forwarded to the "Error E-mail Forward Address". |
| 73 | Attached File Error | Confirm the settings of related Network data such as E-mail address, IP address or SMTP server address, etc. |
| 74 | TIFF File Error | Contact your sender to resend the document with correct TIFF image files. |
| 75 | TIFF File Error and "Error E-mail Forward Address" is assigned | Contact your sender to resend the document with correct TIFF image files. Or confirm the E-mail data forwarded to the "Error E-mail Forward Address". |

| Error Code | Cause | How to Correct |
|------------|--|--|
| 76 | Offramp Gateway Security Error and "Error E-mail Forward Address" is assigned | Contact your sender to confirm the Offramp E-mail address (fax number) is correct because the machine cannot forward the offramp gateway document to the facsimile number not registered in the OT and ABB dials when the Gateway Security is set to ON. Or confirm the E-mail data forwarded to the "Error E-mail Forward Address". |
| 77 | Offramp Gateway Security Error | Contact your sender to confirm the Offramp E-mail address (fax number) is correct because the machine cannot forward the offramp gateway document to the facsimile number not registered in the OT and ABB dials when the Gateway Security is set to ON. |
| 78 | Offramp Gateway Telephone Number and/or Sub address Error and "Error E-mail Forward Address" is assigned | Contact your sender to confirm the Offramp E-mail address (fax number) is correct. Or confirm the E-mail data forwarded to the "Error E-mail Forward Address". |
| 79 | Offramp Gateway Telephone Number and/or Sub address Error | Contact your sender to confirm the Offramp E-mail address (fax number) is correct. |

Error Codes Printed on Reports - continued

Transmit Code

| Error Code | Cause | How to Correct |
|------------|--------------------------------------|--|
| 7A | Memory Overflow | Reduce the scan resolution or the compression of scan method and resend. Or increase the limitation size set at the "MSG SIZE LIMIT" if it is not set to maximum. |
| 7B | Communication Error with SMTP server | Confirm the following: <ul style="list-style-type: none">- SMTP Server Address is correctly set.- LAN cable is correctly connected.- IP Address of this machine is correctly assigned.- E-mail Address of this machine is correctly set. Then send again. |
| 7C | Delivery Error | Resend the document or check the any error condition occurs in reception side. If MDN/DSN report was printed, check the report to refer the information. |
| 7D | Processing Error in Reception side | Resend the document or check the any error condition occurs in reception side. If MDN/DSN report was printed, check the report to refer the information. |

TECHNICAL WORD REFERENCE

This section describes technical words used in this manual and basic terms for the network technology.

D

Default Gateway

Default Gateway commonly refers to a gateway address of the router. The router is a device that connects between a LAN and other LANs.

DHCP, *dynamic host configuration protocol*

DHCP is a protocol for the purpose of assigning dynamic IP addresses to devices on a network. Using DHCP, the devices obtain the different IP address every time the device connects to the network.

Domain

Domain defines a group of computers and devices on the network. Within the Internet, domains are defined by the IP address or DNS name, such as "toshiba.com".

DNS, *domain name system (service)*

DNS is an Internet service that manages the translations between IP addresses and domain names. Instead of identifying a host with an IP address, the host can be identified with alphabetic name using the DNS. Within the Internet, DNS is commonly used to identify a host. For example, "www.toshiba.com" is a DNS domain name that assigned using the DNS.

DSN, *delivery status notification*

DSN is a system to notify the electric mail sender of the status of the message that been sent. The status, such as failed delivery, delayed delivery, successful delivery, or the gateway of a message into an environment that may not support DSNs, is notified when an electric mail with the DSN request is sent.

E

E-mail, *electric mail*

E-mail is the transmission of messages for over communications network, enables to transfer the electric files stored on a disk between most mainframes and computers on network.

E-mail Address

A name that identifies an electric post office box in a mail server within the Internet. E-mail address consists of two elements, user name that identifies the post office box in a mail server and host name that identifies the mail server, and they are divided by "@". Within the Internet, usually the domain name is used for the host name. For example, "ifax@toshiba.com" is an E-mail address. "ifax" is a user name, and "toshiba.com" is the domain name that identifies the mail server.

ESMTP, *extended simple mail transfer protocol*

ESMTP is defined as the service extensions based on SMTP, for the purpose of providing some improvements from SMTP. Enhancing SMTP, ESMTP provides a new command to support the DSN and MDN. (Refer to "SMTP")

F

FQDN, *fully qualified domain name*

FQDN is a domain name that completely identifies the host computer and consists of a host and all level of the domain name. FQDN is always starts with a host and ends with top-level domain. For example, when the host name is "host1" and the domain name is "toshiba.com", the FQDN will be "host1.toshiba.com".

FTP, *file transfer protocol*

FTP is a protocol commonly used for transferring files on the Internet.

G

H

Host

Host refers to a computer connected to a TCP/IP network.

Hostname

Hostname is a name to identifies a computer connected to a TCP/IP network. Within the Internet, a DNS domain name is used for the Hostname.

I

IP Address

IP Address is used to identify the node on a TCP/IP network. It is described with 32-bit numeric address written as four numbers separated by periods.

Internet

The Internet is a global network of networks connecting millions of computers worldwide via many computer networks using a simple standard common addressing system and TCP/IP (Transmission Control Protocol/Internet Protocol).

Internet FAX

Internet FAX enables to transmit a facsimile through the local area network (LAN) and the Internet communication instead of the public switched telephone network (PSTN).

L

LAN, local area network

LAN is a computer network that consists of computers in a small area. Each individual computer can share and access data and devices in a LAN.

M

MDN, message disposition notification

MDN is a system to notify the electric mail sender of the disposition of a message after electric mail has been successfully delivered to a recipient.

MIB, management information base

MIB is a database of objects that can be monitored by a network management system. Such as SNMP and RMON monitors the device on the network using the MIB formats.

MIME, multipurpose internet mail extensions

MIME is a specification for the purpose of formatting non-ASCII messages. MIME enables to send and receive graphics, audio, and video files through the Internet mail system.

MTA, mail transfer agent

A server application that transfers the electric mail sent from the MUA is called MTA.

MUA, mail user agent

A client application that send or receive the electric mail is called MUA.

N

Node

Node is a generic term of a processing location in network. It can be a computer or network devices, such as printer. Every node has unique network address such as DLC address and MAC address.

P

POP/POP3, post office protocol

POP is a protocol to retrieve the E-mail message from a mail server. Most E-mail applications use POP. POP3 is a newer version of the POP protocol.

PSTN, public switched telephone network

PSTN is a global telephone system enables to communicate in worldwide using copper wires to transmit analog data.

S

SMTP, simple mail transfer protocol

SMTP is a server protocol to transfer the E-mail message between servers. Most E-mail system uses SMTP to transfer the E-mail messages over the Internet.

SNMP, simple network management protocol

SNMP is a suite of protocols for the purpose of managing complex networks. The device compatible to SNMP stores the data of itself in MIB format.

Subnet/Subnet Mask

Subnet is a portion of a network specified with a common address component for the purpose of a security and performance. On TCP/IP network, a portion of a network is specified with Subnet Mask. Subnet Mask determines what subnet an IP address belongs to on the network.

T

TCP/IP, transmission control protocol/internet protocol

TCP/IP is a suite of protocols to connect the network nodes on the Internet. TCP/IP actually composed of several protocols; such as TCP and IP. TCP is used to manage the transmission of the data between applications. IP is used to manage the transmission of the data between host computers. Using TCP/IP, the node is identified with a 32-bit numeric address called "IP address".

TIFF, tagged image file format

TIFF is a file format for storing bitmapped images. The image files in TIFF format commonly describes with a ".tif" extension.

DP120F/DP125F
Internet Facsimile
E1-XXXXXX

TOSHIBA TEC CORPORATION

© Copyright TOSHIBA TEC CORPORATION 2000
ALL RIGHTS RESERVED

DP120F/DP125F Internet Facsimile

Free Manuals Download Website

<http://myh66.com>

<http://usermanuals.us>

<http://www.somanuals.com>

<http://www.4manuals.cc>

<http://www.manual-lib.com>

<http://www.404manual.com>

<http://www.luxmanual.com>

<http://aubethermostatmanual.com>

Golf course search by state

<http://golfingnear.com>

Email search by domain

<http://emailbydomain.com>

Auto manuals search

<http://auto.somanuals.com>

TV manuals search

<http://tv.somanuals.com>