

TOSHIBA FAX

TF 251

Instruction manual

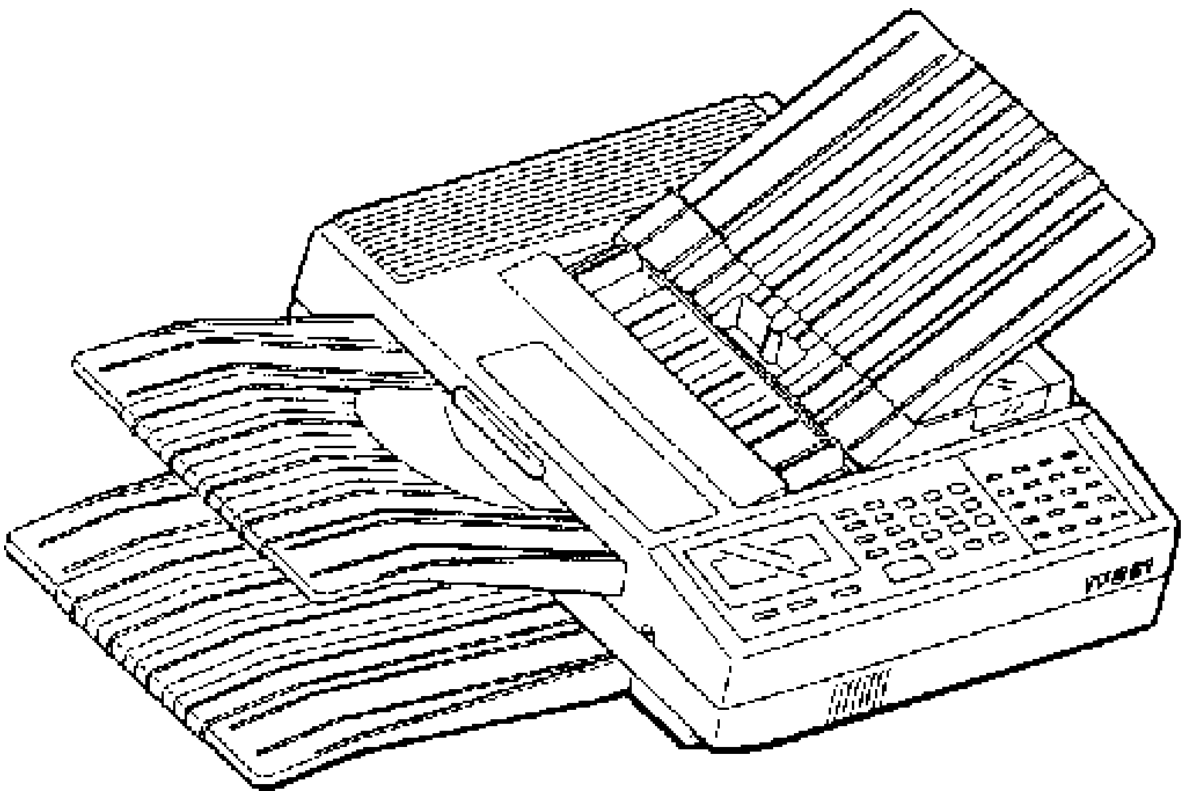

TOSHIBA

**TOSHIBA TF251 Facsimile
Operator's Manual**

Copyright © 1989 TOSHIBA CORPORATION.

Printed in Japan. All rights reserved. No part of this manual may be reproduced, stored in a retrieval system, or transmitted, in any form or by any means, electronic, mechanical, photocopying, recording or otherwise, without written permission of TOSHIBA CORPORATION.

While every precaution has been taken in the preparation of this manual, TOSHIBA CORPORATION assumes no responsibility for errors or omissions, nor is any liability assumed for consequences arising from operation of the equipment based on information contained herein.

NOTICE FOR CONNECTION TO THE TELECOMMUNICATION SYSTEMS

NOTICE TO USERS

NOTES FOR U.K. USE

1. The BABT Certificate Number/Approval Number for the Model TF251 is NS/3005/3/K/601106. It is APPROVED for connection to Telecommunication systems specified in the instructions for use subject to the conditions set out in them.
2. This apparatus has been approved for the use of the following facilities.
 - a) Storage of telephone numbers for retrieval by a predetermined code. (If problems occur, verify stored number).
 - b) Automatic Call initiation.
 - c) Operation in the presence or absence of Initial or Secondary Proceed Indication.
 - d) Automatic Dialling Facilities.
 - e) Automatic Storage of Last Number Dialed.
 - f) Automatic Repeat Attempt Facilities.
 - g) Auto Clear from the call originating end.
 - h) Series Connection Facility.

The loudspeaking monitor function described on page 34 of this guide has not been approved for use in the UK and has been disabled.

Any other usage will invalidate the approval of the apparatus if as a result, it then ceases to conform to the standards against which approval was granted.

3. The connection to the telecommunication systems must be unplugged before the earth is disconnected. The connection to the telecommunication systems must not be hardwired.
4. This apparatus may be used on telecommunication systems employing loop- disconnect or MF signalling.
5. This apparatus is not suitable as an extension to a payphone for use on shared service lines or for use on 1+1 carrier systems.
6. The approval of this apparatus for connection to the telecommunication systems is invalidated if it is used with or connected to:
 - a) internal software that has not been formally accepted by BABT
or
 - b) external control software/control apparatus which causes the operation of the terminal or associated call set up equipment to contravene the requirements of the standard set out in BABT/SITS/82/005S/D.

All apparatus connected to the facsimile machine and thereby connected directly or indirectly to telecommunication systems must be approved apparatus as defined in Section 22 of the British Telecommunication Act 1984.

7. This apparatus is suitable for connection only to direct exchange lines on the pstn directly or via a compatible PABX. The supplier of the apparatus should be consulted for an up to date list of PBXs/RBS' with which the apparatus is compatible.

The user should refer to BS 6789:section 6.1 clause 2.4 for information relating to Relevant Branch Systems (RBS).

It cannot be guaranteed that the apparatus will operate under all possible conditions of connection to compatible PABX. Any cases of difficulty should be referred in the first instance to supplier of the apparatus.

8. Ringer Equivalence Number (REN) = 3.
The REN is a customer guide indicating approximately the maximum number of items of apparatus that should be connected simultaneously to the line.

The sum of the RENs of the individual items should not exceed 4. The REN value of a BT telephone is assumed to be 1 unless otherwise marked.

Only one telephone and the facsimile machine should be connected to the line. Where the telephone is a separate unit it must only be connected to the appropriate socket on the Line Jack break-in adaptor. Any apparatus connected to this socket must comply with BS 6301.

9. The voltage drop introduced by the apparatus between the PSTN and the associated telephone at a current of 40mA d.c. is 0.5 Volts.

The apparatus should not be used in conjunction with other series connected apparatus such that the aggregate declared voltage drops of all this apparatus, together with the voltage drop introduced at 40 mA D.C. by any separate wiring that is used to link apparatus, exceeds 2.0 Volts.

While operation may be possible initially, changes to or modernization of the network taking place in the normal course of events may result in the apparatus being connected to a network service with which it was not designed to be compatible. Failure of the apparatus to work under these circumstances may not be the responsibility of the network operator.

10. PBX Operation.

PBX's that return a secondary proceed indication after the access digit may require a pause to be inserted in the dial number between the access digit and the remaining digits. If pauses are required for PBX operation, the pause button on the operator panel can be used. WARNING: Care should be taken that at least 2 and no more than 5 are inserted. Failure to comply with this requirement may result in unsatisfactory operation.

11. WARNING: The interconnection of the port on this apparatus either directly or by way of other apparatus may produce hazardous conditions on the BT network and advice should be obtained from a competent engineer before such a connection is made.

AB1105

CARE AND MAINTENANCE

To keep your Toshiba Facsimile in good operating condition, follow these simple steps:

- All repairs must be made by an authorized Toshiba service representative.
- Keep your unit away from source of excessive heat and moisture.
- Do not allow any liquids to spill on or into the cabinet.
- Do not place the unit near a television set, radio set, etc.
- When necessary, wipe the cabinet with a clean cloth.
Do not use soaps, detergents, abrasives, glass cleaners, etc.
- Do not open the unit except as instructed in this manual.
- Use only AC 220-240V power source. And, do not connect the plug into an AC outlet used with high power consumption equipment.
- Avoid location subject to vibration.
- Do not drop, hit and/or get excessive shock to the unit.
- When room temperature drops below 4°C, do not raise the temperature suddenly.

Also:

- Handle recording paper carefully, making sure not to wrinkle or tear it.
- Do not store recording paper near sunlight, excessive heat and humidity.
- Never use recording paper not recommended by Toshiba. For best performance, use only Toshiba recording paper.

Transmission

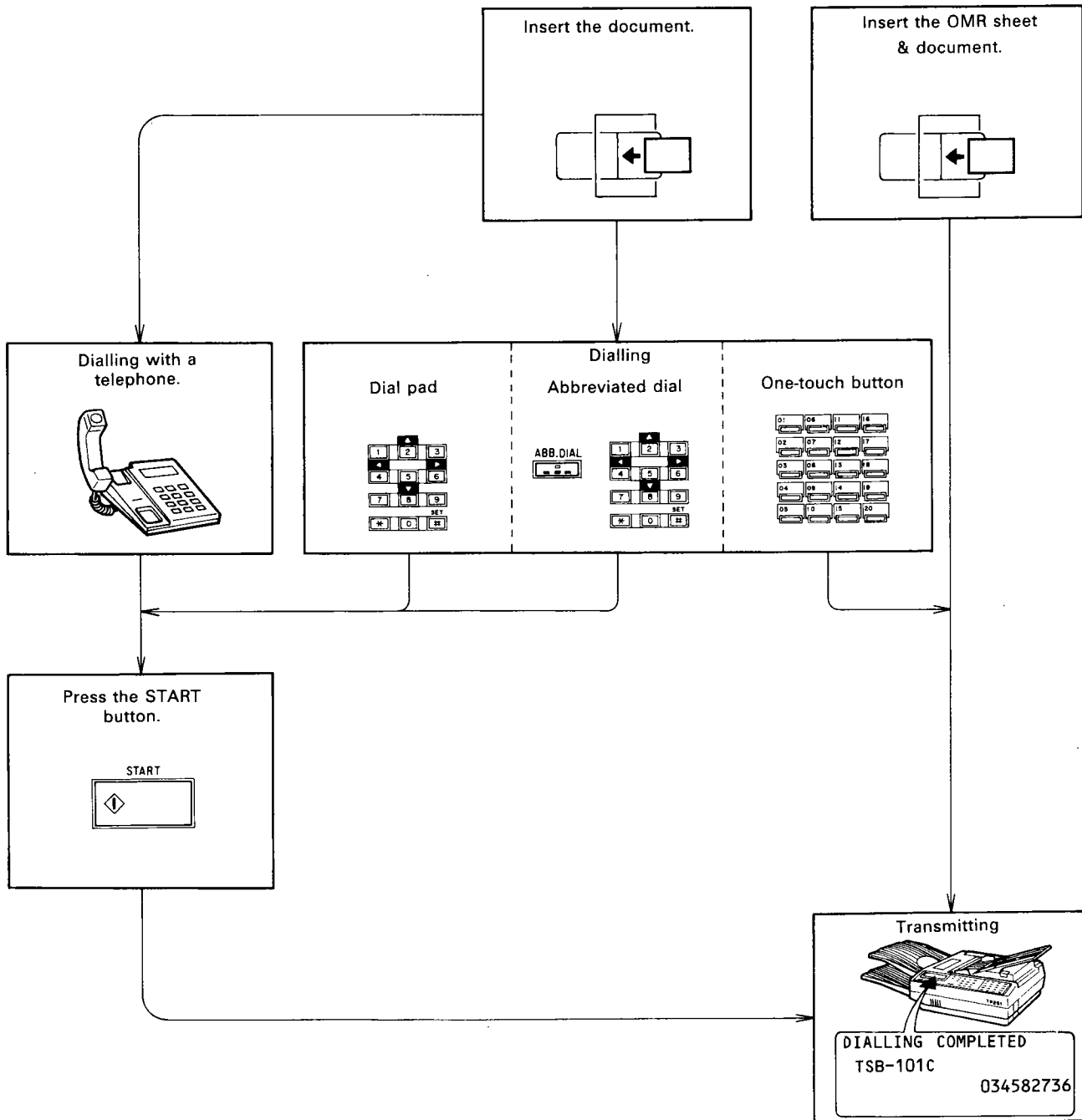

Receiving

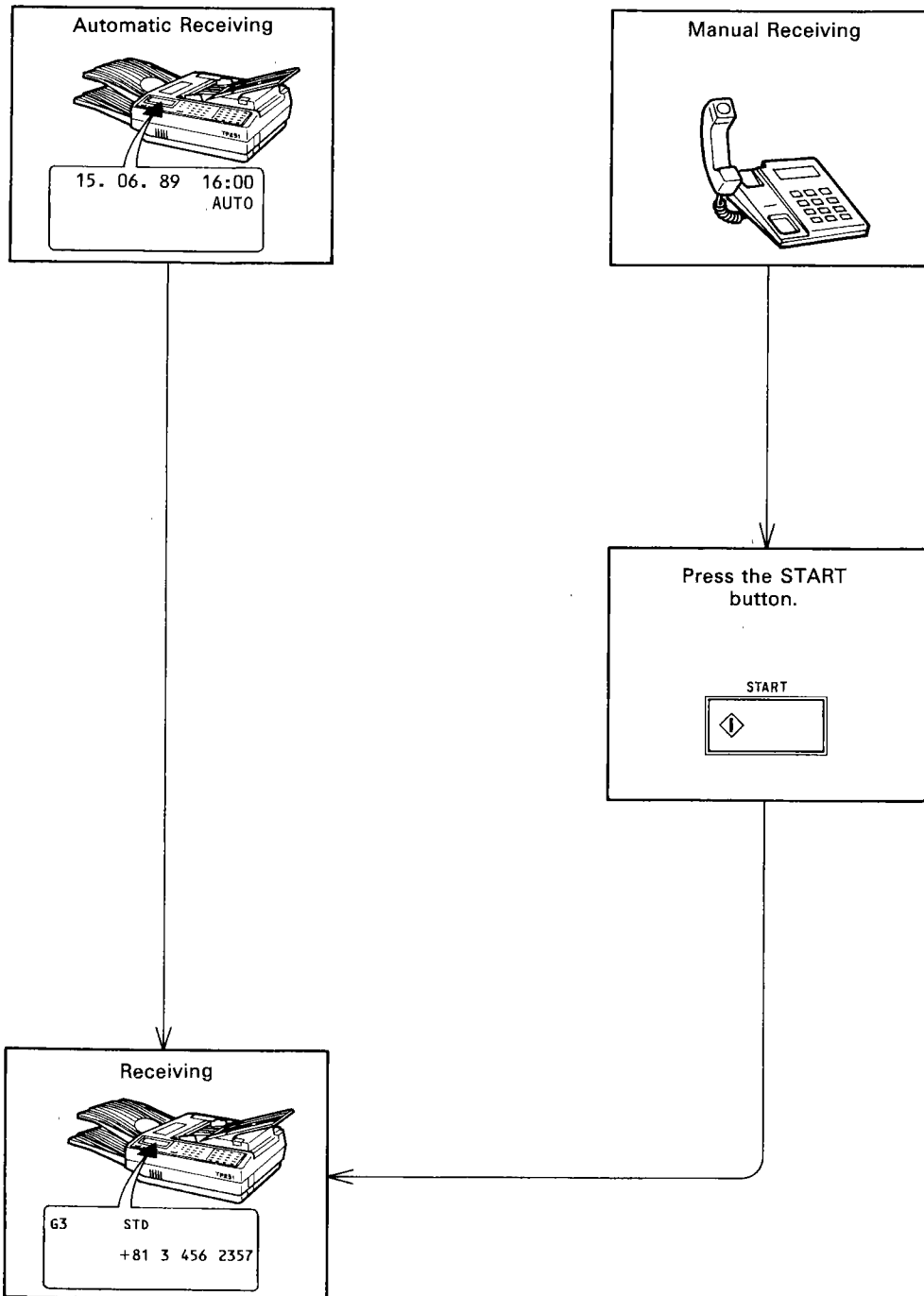

Table of Contents

FEATURES	8	RECEIVING	
ABOUT THIS MANUAL	8	Automatic Reception	41
BEFORE STARTING		Manual Reception by Telephone	42
Unpacking	9	Call Reservation	43
Location and Names of Parts	9	Memory Reception	44
Operating Panel	10	COPYING	
Menu Operation	12	Copying Documents	45
How to Set the ID Name	13	FACSIMILE NETWORK	46
Assembling the Components	14	Multi-address Transmission	47
Assembling the Recording Paper	16	Relay Transmission	51
Making Connections	17	Mailbox	54
Registering Terminal ID Name	18	Polling	55
Setting the Functions	19	OMR SHEETS	
Multiple Languages	20	Filling out OMR Sheets	60
TRANSMISSION		Using OMR Sheets	61
Setting Documents	21	Operation Table of OMR Sheets	62
Acceptable Documents	22	LISTS, REPORTS AND TEST MODE	
Setting Facsimile Resolution and Contrast	23	Communication Journals	63
Dialling with Telephone	25	Communication Reports	64
Key Pad Dialling	26	Telephone Number, Reservation & Function Lists	66
Abbreviated Dialling and One-touch Key Dialling	27	Test Mode	68
Registering or Modifying for Abbreviated Dialling	28	TROUBLESHOOTING	
and One-touch Key Dialling	28	Error Messages	69
Confirming the Transmission	29	Recording Paper Jam	71
Delayed Transmission	30	Document Jam	73
Confirming/Cancelling the Delayed	33	Troubleshooting for Transmission	74
Transmission	33	Troubleshooting for Reception	75
Transmitting by Program Button	34	Error Codes	76
Overseas Transmission	36	MENU OPERATION FLOW CHART	77
Selecting the Number of Pages	37	SPECIFICATIONS	80
and Department Code (Option)	37		
Call Reservation	38		
Transmission Reservation	39		
Manual Redialing	40		

FEATURES

- Menu operation with LCD
- One-touch dialling
- Multiple languages
- Optical mark reader (OMR) sheet
- Turnaround and multi-address polling
- Error correction mode (ECM)
- Multi address transmission
- Relay transmission
- Memory reception
- Mailbox
- Operator call
- Terminal identification
- Communication journal and transmission report

ABOUT THIS MANUAL

This manual is organized to help you find the information you need, as quickly and easily as possible.

- "BEFORE STARTING", explains the basic components and functions of your facsimile machine.
- "TRANSMISSION", describes how to send the document.
- "RECEIVING", explains how to receive the document.
- "COPYING", describes how to copy the document.
- "FACSIMILE NETWORK", explains how to use the network communication capabilities in combination with other facsimile.
- "OMR SHEETS", describes how to use the OMR sheets.
- "LISTS & REPORTS", describes the various printouts that you can use to keep track of settings and check the status of document you send.
- "TROUBLESHOOTING", lists error messages that are displayed and what action to take.
- "MENU OPERATION FLOW CHART", lists the menu displays.
- "SPECIFICATIONS", contains the technical specifications for the TF251.

BEFORE STARTING

Unpacking

When you unpack your Toshiba TF251, you will find the following:





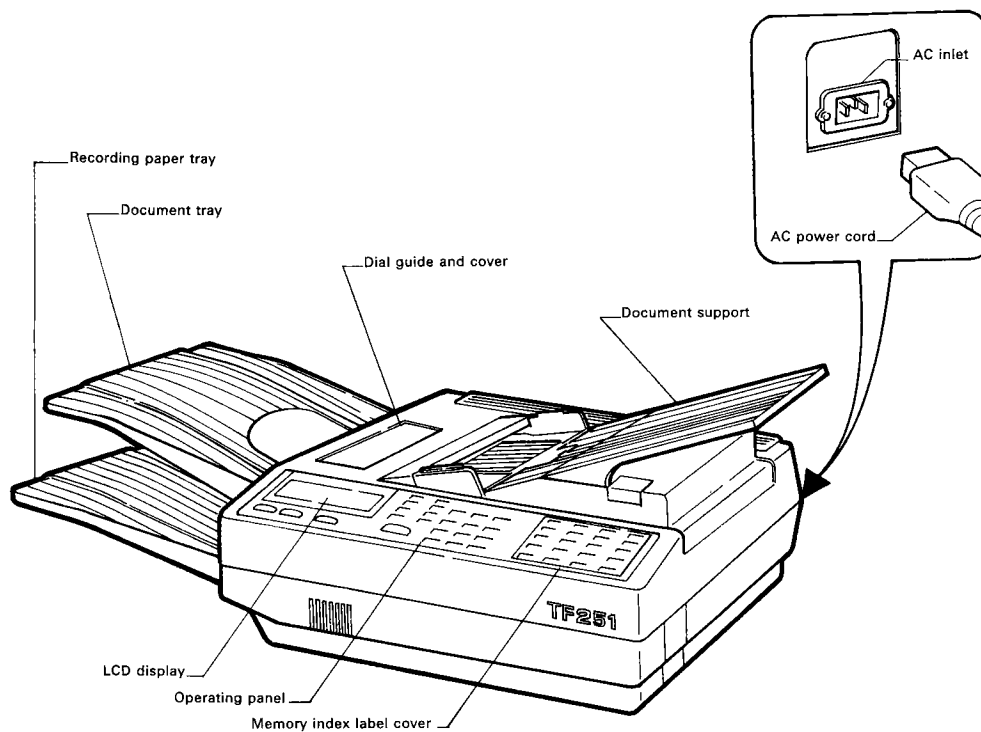



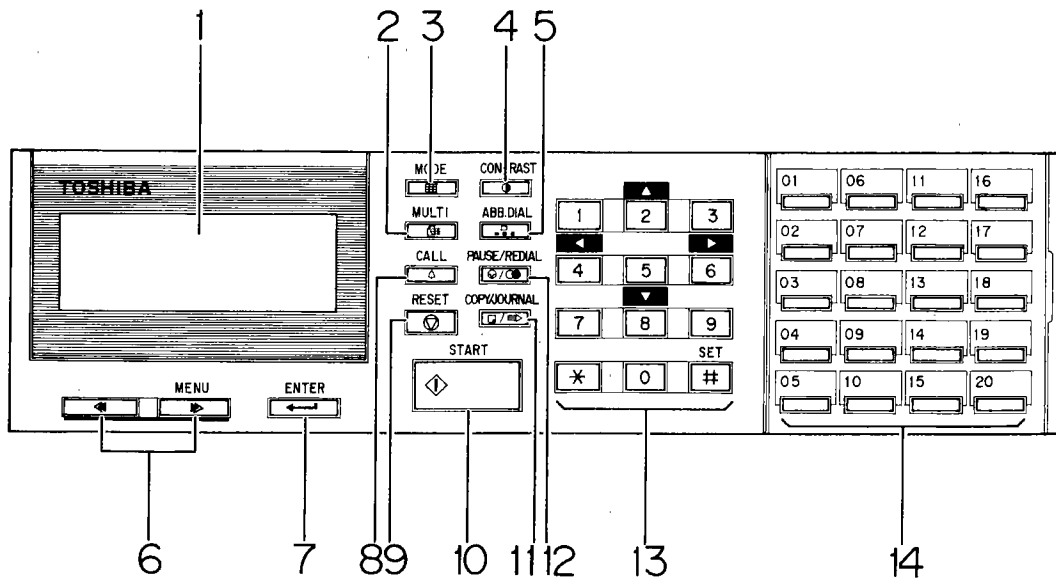



- Operator's manual
- OMR sheets-Auto Dialler
- Plastic guide sheet with rivets
- Dial guide and cover
- Document tray
- Recording paper tray
- Document support
- Connector cover and screw
- One roll of recording paper (inside the TF251)
- TF251 itself
- Communication cable (2m)
- AC power cord
- Carrier sheet (for undersized documents)
- Menu list

Location and Names of Parts



Operating Panel



1. LCD display
2. MULTI () button
Sends the same documents to multiple addresses, initiates multiple polling.
3. MODE () button
Selects the resolution for sending or copying documents [Standard (STD), Fine(FINE), Semi-superfine(S.FINE), Standard gray scale(STD-GR), Fine gray scale(FINE-GR), Semi-super fine gray scale(S.FINE-GR)].
4. CONTRAST () button
Selects the contrast (normal, dark, light).
5. ABB. DIAL () button
Gives you access to stored abbreviated telephone numbers.
6. MENU button
 : Menu select key or go to next display.
BACK SHIFT button
 : Back shift or back to upper display.
7. ENTER () button
Enter key or return to idle.
8. CALL () button
Informs the other party that you want to speak by telephone after the communication, but before disconnecting the line. When the incoming calls ring, lift the handset and depress the CALL () button to speak.
9. RESET () button
Stops operation and cancels any alarm.
Also, cancels operating job and ejects the document.
10. START () button
Starts send or receive operation.
And, presets the recording paper.
11. COPY/JOURNAL () button
COPY : Allows you to use the facsimile for simple copying.
JOURNAL: Prints transmission and/or reception journals.
12. PAUSE/REDIAL () button
PAUSE: Enters pause for PABX exchanges in abbreviated numbers.
Do not insert PAUSE between normal telephone number.
REDIAL: Press it to redial immediately while "WAITING TO REDIAL" is displayed.
13. Dial pad
14. One-touch dialling buttons

Menu Operation

You can use your facsimile's operations, registrations and settings by selecting the menu display.

MENU



- Press to select the menu display.
- Press to go to next menu display.



- Press to back-shift (modification or correction of misentry).
- Press to go/return to the upper menu display.

ENTER





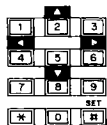



- Press to enter after confirming an input content.
- Press to return to idle.



- Press to enter the code number to select the item on the menu display.
- Press to enter TEL number, ABB. number, etc.

How to Set the ID Name



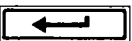

During menu operation, you can register an address name at "ENTER ABB. NUMBER", a group name at "ENTER GROUP NUMBER" and a relay name at "ENTER RELAY NUMBER". Each of these names can be registered up to 20 characters.

- | | |
|--|--|
|  | <ul style="list-style-type: none"> ● Moves the cursor up. ● If it is at the first line, moves it to the third line. |
|  | <ul style="list-style-type: none"> ● Moves the cursor left. ● If it is at the first character, moves it to the 20th file. |
|  | <ul style="list-style-type: none"> ● Moves the cursor right. ● If it is at the 20th character, moves it to the first file. |
|  | <ul style="list-style-type: none"> ● Moves the cursor down. ● If it is at the third line, moves it to the first line. |
| <p>SET</p>  | <ul style="list-style-type: none"> ● Sets the character indicated by the cursor. |
|  | <ul style="list-style-type: none"> ● Moves the input position left to correct an incorrect character. |
| <p>MENU</p>  | <ul style="list-style-type: none"> ● Inputs the blank instead of a character. ● Moves an input position right to correct an incorrect character. |
| <p>ENTER</p>  | <ul style="list-style-type: none"> ● Press after inputting a name, to register it, or to return to menu operation. |

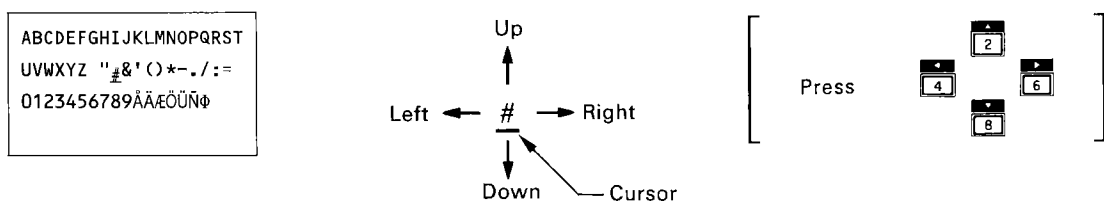
Registering a Character

1. The character selection display appears when registering an ID name.
2. Move the cursor to the desired character.



3. Press the SET () button to select it.
 The character selected will be displayed at the lowest line.
 If the input character is wrong, press the MENU button (, ) to correct it.
4. Confirm the input ID name and press the ENTER () button.
 The display will return to menu operation.

Assembling the Components

1. Before assembling please disconnect the AC plug.

2. Plastic guide sheet

Attach the plastic guide sheet that prevents the recording paper from curling to the bottom of the TF251. Turn the TF251 on its side and attach the sheet by pressing the plastic rivets into the 3 holes. Make sure to face the tabs away from the paper exit.

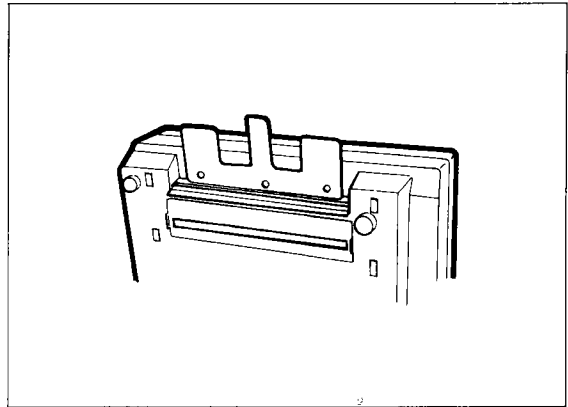
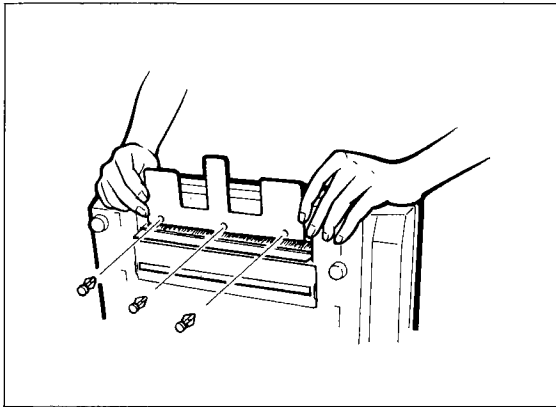

3. Document support

Insert the tabs on the bottom of the document support in the slots on the recording paper cover. Press down on the document support until it seats firmly.

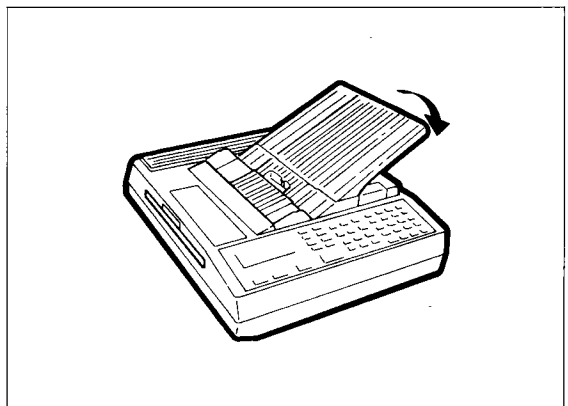
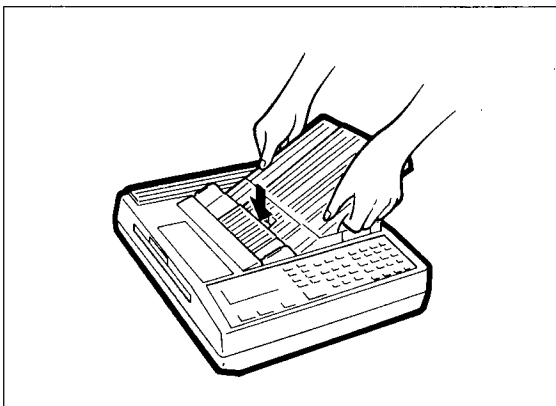

4. Recording paper tray

Align the open slots on the sides of the recording paper tray with the round projections inside the TF251 case. Push the tray in until it snaps into place.

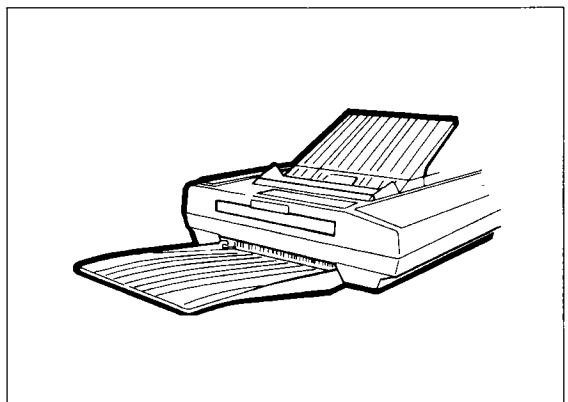
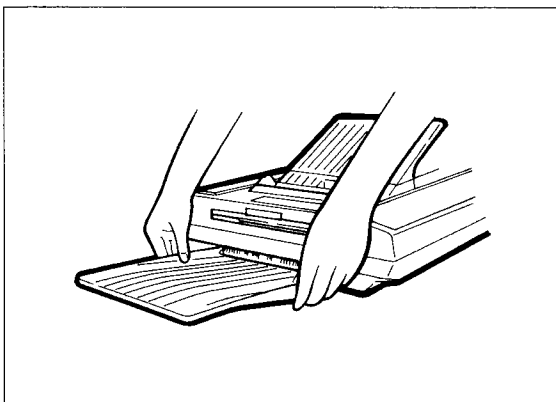

5. Document tray

Rest the tabs on the connecting edge of the document tray in the opening in the TF251 case. Tilt the tray up slightly while pushing it in until you feel it catch inside.

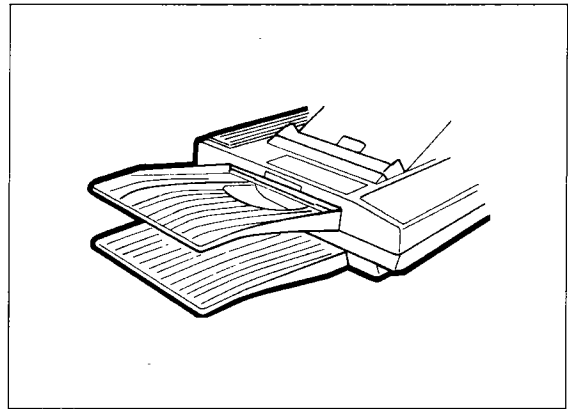
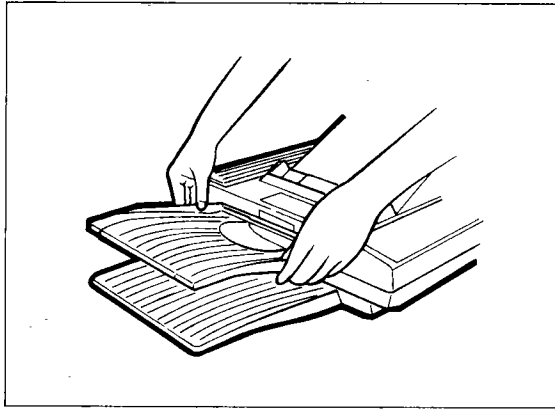

6. Memory index label cover

Insert the feed on the top edge of the memory index label cover into the holes above the one-touch dialing button panel. Lower the cover carefully over the panel and snap it into place.

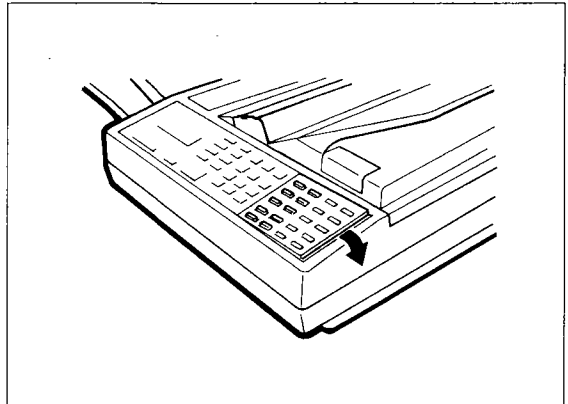
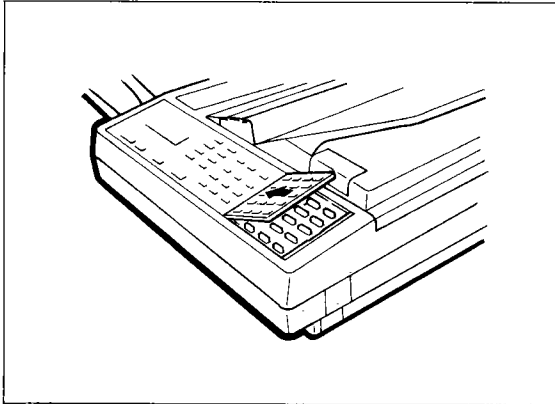

Assembling the Recording Paper

1. Open the paper compartment cover and remove the roll of recording paper.
2. Pull out the green paper release knob and remove the strip of paper inserted to protect the thermal head during shipment.

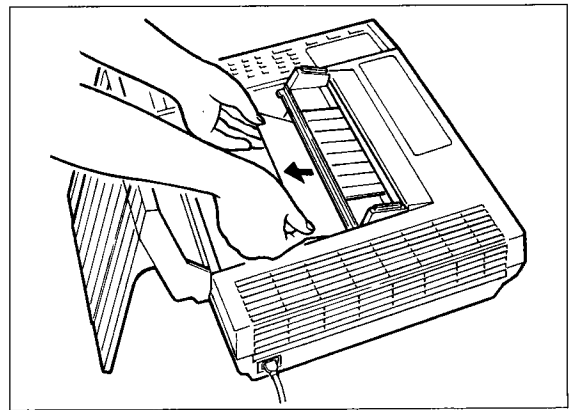
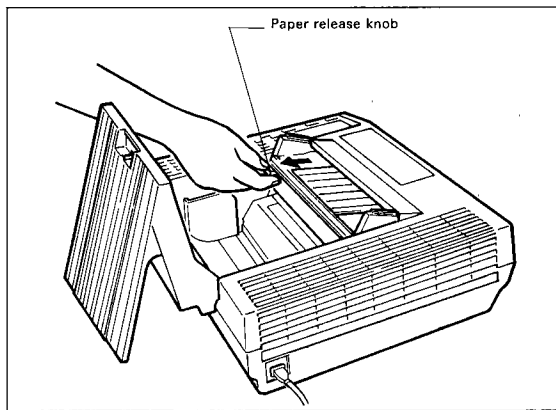

3. Unwrap the roll of recording paper and load it as shown in the figures on the inside of the cover.

The orientation of the recording paper must be shown as below.

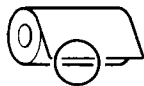

YES

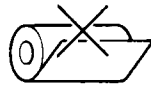

NO

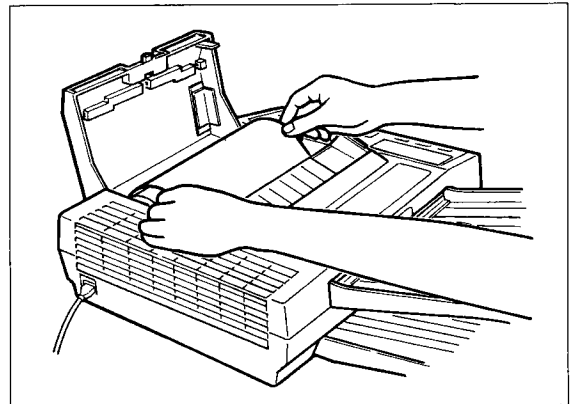

4. Push the green knob back into position and close the cover.

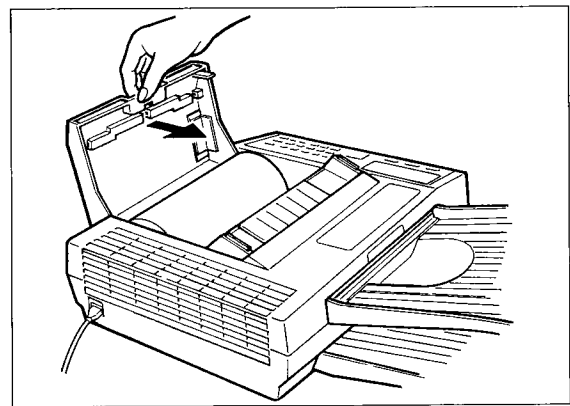
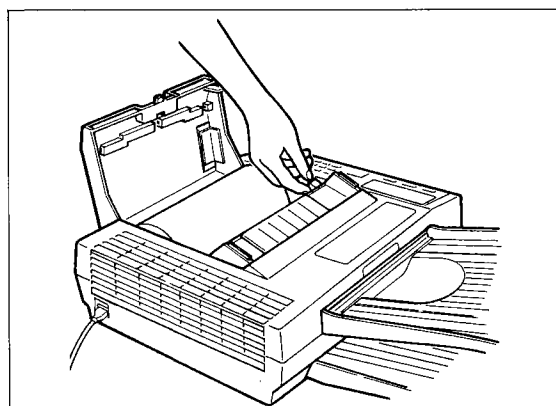

5. Copy a sheet of paper to check that it feeds correctly.

Making Connections

1. Plug one end of the connecting cable into the TEL jack. Plug the other end of the connecting cable into the wall jack.
2. Assemble the connector cover by tightening the screw.

- Notes:**
- Do not share the AC circuit with other electrical appliances using a high current.
 - In the event of a noisy subscriber line, there is a possibility that the transmit speed will drop or faulty transmission will be caused.
 - A Toshiba authorized person will connect the telephone cord and the connecting cables and assemble the connector cover.

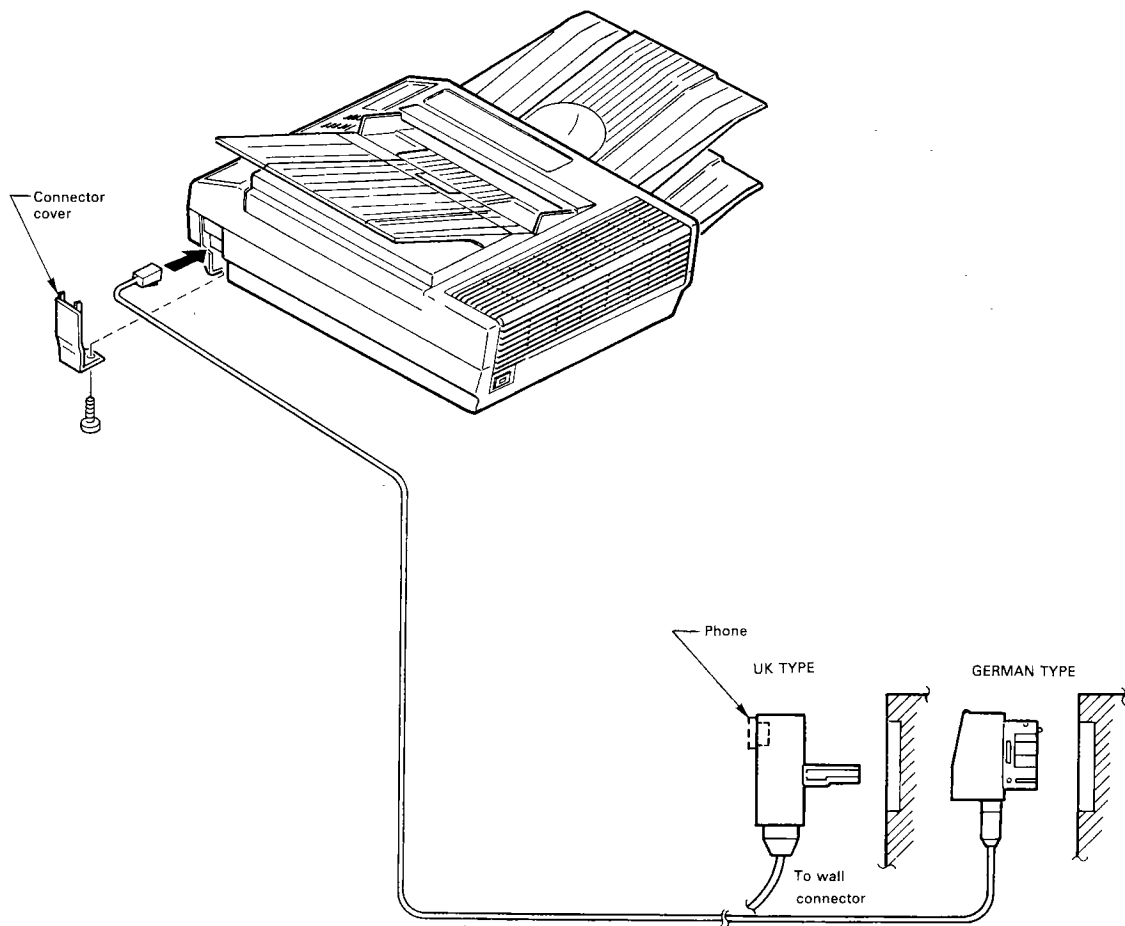

Registering Terminal ID Name

ID name (User name and TEL number) is printed at the top of every page you send, by registering it. An international code can be added.

Print-out eg.

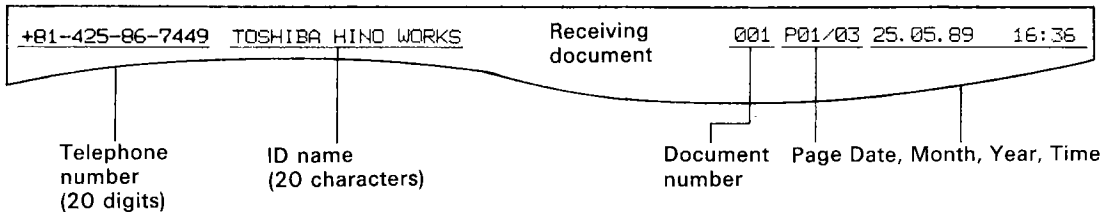

1 ● Press and .
(Able to omit)

2

```

SET TERMINAL ID
ID NAME= (MAX20)
    
```

- Registers user name.
 1. Character selection display appears.
 2. Move the cursor to the desired character.
 3. Press the SET () button to select it. (Max. 20 characters)
 4. Press the ENTER () button.

3

```

INTERNATIONAL CODE?
1.YES
2.NO
    
```

- If you want to add the international code, press key.
- When it is not needed, press key.

4

```

SET TERMINAL ID
NAME= TOSHIBA
TEL NUMBER= (MAX20)
+■
    
```

- Register TEL number of your facsimile. (Max. 20 digits including "+")
- Press the ENTER () button.
- Note:** When the international code is added, "+" is displayed and next you must register the country number (1-3 digits) as the international code.

5

```





15. 06. 89 12:00
      AUTO
    
```

- Press the ENTER () button registering of the terminal ID name has been completed.

Note: In F.R. Germany, ID name must be registered by an authorized Toshiba dealer.

Setting the Functions

You can adjust or select for various functions.

1. Press the MENU () button twice, and then the **6** key.
2. Select the menu display by the MENU button (, ).
3. Input the code number.
4. Input a value for the function.
5. Press the ENTER () button.
6. To set another function, repeat from item 2.
To return to idle, press the ENTER () button.



Code No.	Display	Code No.	Display
1	<div style="border: 1px solid black; padding: 5px;"> 1. ENGLISH 2. DEUTSCH 3. ITALIANO </div>	7	<div style="border: 1px solid black; padding: 5px;"> SET VOLUME VOLUME LEVEL= (0-7) 4 </div>
2	<div style="border: 1px solid black; padding: 5px;"> SET RECEPTION MODE 1. AUTO 2. MANUAL </div>		
3	<div style="border: 1px solid black; padding: 5px;"> SET DATE & TIME DD-MM-YY HH:MM 23-06-89 20:55 </div>		
4	<div style="border: 1px solid black; padding: 5px;"> JOURNAL OUTPUT 1. MANUAL 2. AUTO 3. ERROR CODE </div>		
	<div style="border: 1px solid black; padding: 5px;"> MANUAL OUTPUT 1. Tx & Rx JOURNAL 2. Tx JOURNAL 3. Rx JOURNAL </div>		
	<div style="border: 1px solid black; padding: 5px;"> AUTOMATIC JOURNAL 1. ON 2. OFF </div>		
	<div style="border: 1px solid black; padding: 5px;"> SET ERROR CODE 1. ON 2. OFF </div>		
5	<div style="border: 1px solid black; padding: 5px;"> SET TTI 1. INSIDE 2. OUTSIDE </div>		
6	<div style="border: 1px solid black; padding: 5px;"> SET CONTRAST 1. NORMAL 2. DARK 3. LIGHT </div>		

: Initial value at shipment

Multiple Languages

You can change the language on the display and lists by pressing the one-touch key assigned to the language function. You must set up an one-touch key before you can use it!

■ To register the language function

- 1** ● Press , , and .
(Able to omit)
- 2** ● Press the one-touch key you wish to register the language function.
- 3** ● Press key to register the language.

■ To change the language

- 1** ● Press the one-touch key assigned to the language function.
- 2**

1.ENGLISH
2.DEUTSCH
3.ITALIANO

 - Select the code number of the language and press the ENTER () button.
 - You will change all of lists and LCD message.

TRANSMISSION

Setting Documents

1. Adjust the document guide to fit the document you want to send.

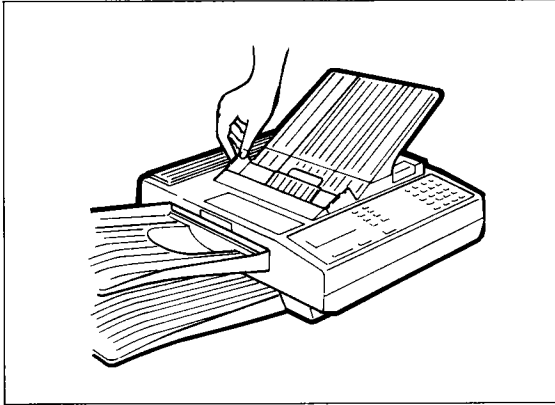

2. Place the document face-down and insert it gently.

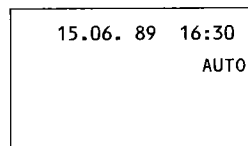
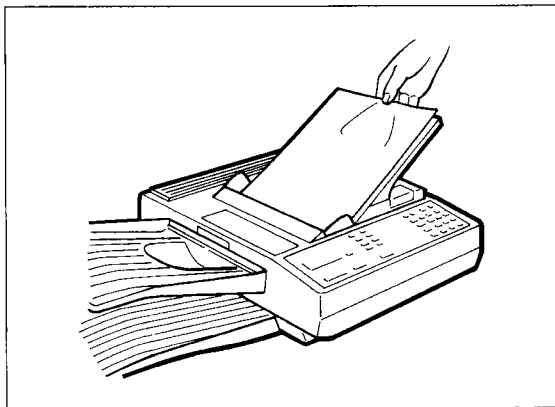

Insert the document,
the display is changed.

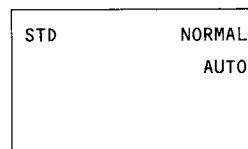

3. You can load up to 20 sheets in the automatic document feeder.

Stagger the leading edges of the sheet slightly, and insert the sheets with a slight push to assure smooth feeding.

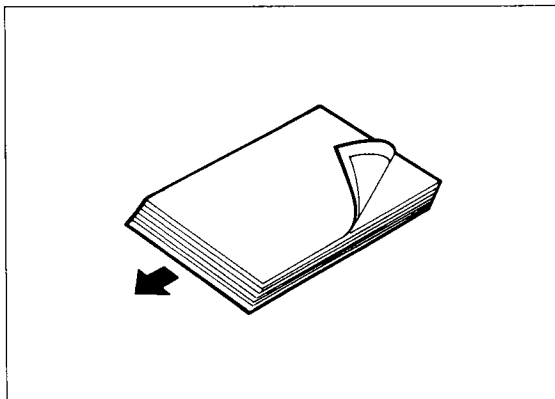

NOTE: To remove the document, press the RESET button.

Acceptable Documents

The following table gives the guidelines for the document sizes that can be copied or sent with the TF251.

Item	Single sheet	Multiple sheet
Page width	148 to 216 mm (5.8 to 8.5 inches)	148 to 216 mm (5.8 to 8.5 inches)
Page length	100 to 1000 mm (4 to 39 inches)	100 to 297 mm (4 to 11.7 inches)
Thickness	0.05 to 0.25 mm (0.002 to 0.0098 inches)	0.06 to 0.12 mm (0.0024 to 0.0047 inches)
No. of sheets	1	20 or less
Paper type	Uncoated on both sides	Uncoated on both sides

Note 1: Multiple sheets must be the same size and paper type.
Note 2: Hand assistance is needed for pages longer than 297 mm (11.7 inches).

In addition, the documents should meet the following requirements:

- No torn, wrinkled, or damp pages
- No folded pages or pages with holes
- No transparent pages or pages with a smooth, shiny finish
- No cloth or metal sheets

Small, torn, wrinkled, or damp documents or those with holes may sometimes be copied or sent if they are first placed in a carrier sheet as explained in the below.

Another way to send problem documents is by copying them first on a standard copy machine, then use the copy in your TF251.

To use the carrier sheet, lift the clear cover film and place a single page face-up on the paper with the top of the document toward the hinged end. Cover the page with the vinyl film.

Now place the carrier sheet with the document face-down on the document support and proceed as usual for single sheet sending. If you need the carrier sheet, it is recommended to consult nearest Toshiba service station.

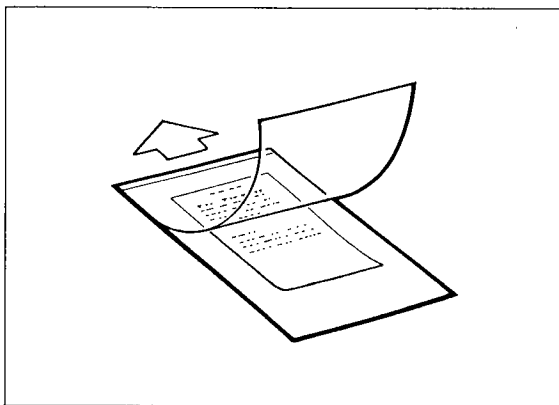

Setting Facsimile Resolution and Contrast

You can adjust the resolution and contrast settings of your facsimile to suit the type of documents you usually send.

Use the following guideline for determining which settings are most appropriate for you.

Standard resolution(STD):	for normal documents
Fine resolution(FINE):	for detailed documents or documents with small type
Semi-fuper fine resolution(S.FINE):	for more detailed documents (Used only with Toshiba facsimiles)
Standard gray scale(STD-GR):	for normal photograph
Fine gray scale(FINE-GR):	for detailed photograph
Semi-super fine gray scale(S.FINE-GR):	for more detailed photograph (Used compatible with Toshiba facsimiles)
Normal contrast(NORMAL):	for normal documents
Dark contrast(DARK):	for high-contrast documents
Light contrast(LIGHT):	for low-contrast documents, such as those written in pencil

1

```

15.06. 89 16:30
                AUTO
    
```

- Load the documents.

2

```

STD                NORMAL
                AUTO
    
```

- Press the MODE () button.

3

[German type]



```

SET NONSTANDARD MODE
1.STD    4.STD-GR
2.FINE   5.FINE-GR
3.S.FINE 6.S.FINE-GR
    
```

- Selects the nonstandard resolution mode.
- If you wish to select the standard resolution mode, press the MODE () button again.

```



SET STANDARD MODE
1.STD    4.FINE-GR
2.FINE
3.STD-GR
    
```

- For example, press .
- After 2 seconds or pressing the ENTER () button, the display goes to the following.

[Other type]

```

SET MODE
1.STD    4.STD-GR
2.FINE   5.FINE-GR
3.S.FINE 6.S.FINE-GR
    
```

- Selects the resolution mode.
- For example, press .
- After 2 seconds or pressing the ENTER () button, the display goes to the following.

4

```



FINE-GR          NORMAL
    
```

- Press the CONTRAST () button.

5

```

SET CONTRAST
1.NORMAL
2.DARK
3.LIGHT
    
```

- Selects the contrast mode.
- For example, press .
- After 2 seconds or pressing the ENTER () button, the display goes to next.

6



```

FINE-GR          LIGHT
    
```

■ Fine unavailable

If the capability of the termination doesn't conform to one of your selectable in density, the LCD appears as follows.

```
ON LINE
TSB-I0IC
+81 3 456 2736
FINE UNAVAILABLE
```

- Audible alarm sounds for 4 seconds and visual alarm "FINE UNAVAILABLE" continues until about 30 seconds.
- Press the MODE () button immediately and you can transmit your documents. But operator's desirable density is ignored.
- If the operator doesn't press the MODE () button, the display goes to the following.

```
15. 06. 89 16:30

FEATURE UNAVAILABLE
```

- Change to set other resolution and try the transmission again.

Dialling with Telephone

1

```
15. 06. 89 16:30
                AUTO
```

- Load the documents.
- Set the mode & the contrast.

2

```
FINE          NORMAL
                AUTO
```

- Dial the other party's facsimile numbers with the telephone.

3

```
ON LINE
```

- When you hear the high-pitched response tone after the other facsimile answers, press the START () button and then hang up.

4

```
EX   FINE
      +81 3 456 1287
```

- During transmission, the telephone number or ID of the called party, resolution and transmission mode are displayed. Transmission mode is as follows:

G2 CCITT Group 2 Mode
G3 CCITT Group 3 Mode
HS Toshiba high-speed transmission mode
EC CCITT Group 3 Error Correction Mode
EX Toshiba Error Correction Mode

5

[Normal completion]

```
EX   FINE
      +81 3 456 1287
      OK 01
```

- The transmission has completed normally.
- After 2 seconds, the TF251 returns to the idle status.
- The normal tone rings for a second.

[Transmission error]

```
EX   FINE
      +81 3 456 1287
      COMMUNICATION ERROR
```

- Try the transmission again.
- The abnormal tone rings and "COMMUNICATION ERROR" is displayed for 4 seconds, then the TF251 returns to the idle status.

Key Pad Dialling

1

15. 06. 89 16:30
AUTO

- Load the documents.
- Set the mode & the contrast.

2

FINE	NORMAL
	AUTO

- Enter the other party's facsimile numbers using the TF251's control panel ten key pad.

3

FINE	NORMAL
TEL NUMBER = (MAX38)	
0123456789■	

- When you have entered the number correctly, press the START (- To correct misentry, press and re-enter the number.

4

ON LINE

5

[Normal completion]

HS	FINE
	0123456789
OK 03	

- The transmission was completed normally.
- After 2 seconds, the TF251 returns to the idle status.

[The address is busy.]

WAITING TO REDIAL

- Redial 3 times at intervals of 3 minutes.
- Times and intervals changeable by service technician.

[Transmission error]

HS	FINE
	0123456789
COMMUNICATION ERROR	

- Try the transmission again.

Abbreviated Dialling and One-Touch key Dialling

You can transmit simply by entering an ABB. number or by pressing a one touch key.

1



```
15. 06. 89 16:30
          AUTO
```

- Load the documents.
- Set the mode & the contrast.

2

[ABB. dialling]

```
FINE      NORMAL
          AUTO
```

- Press ABB. DIAL () button and the abbreviated 2 digits number (01-50)
- For example, press  and .

```
FINE      NORMAL
ABB. NUMBER= (01-50)
          12
```

- Press the START () button.

[One-touch dialling]

```
FINE      NORMAL
          AUTO
```

- Press the one-touch key (01-20)
The START () button is not needed for one-touch dialling.

3

[Normal completion]

```
EX      FINE
TSB-IOIC
      +81 3 456 1287
```

- The transmission has completed normally.
- After 2 seconds, the TF251 returns to the idle status.

[The address is busy.]

```
WAITING TO REDIAL
TSB-IOIC
```

- Redials 3 times at intervals of 3 minutes.

[Transmission error]

```
EX      FINE
TSB-IOIC
      +81 3 456 1287
COMMUNICATION ERROR
```

- Try the transmission again.

Registering or Modifying for Abbreviated Dialling and One-touch Key Dialling

You can register up to 50 TEL numbers for the abb. dialling and use up to 20 of the abb. numbers for the one-touch dialling.

- 1** ● Press , , **5** and **1** .
(Able to omit)

2

ENTER ABB. NUMBER
OR PRESS
[<]:TO CONTINUE
[↵]:TO COMPLETE

- Enter the 2 digits abbreviated number (01 – 50) you wish to assign.
- Confirm the abb. numbers and press the ENTER () button.
- For example, press **0** , **1** and ENTER () button.

- 3** [TEL number has already registered.]

ABB. NBR =01
1.CANCEL
2.MODIFY
3.RETURN

- If this abb. number has already been used, select one of the code numbers in this display.
If you press **1** key, this cancels the contents of this abb. number and returns to item 2. **2** key, goes to the following item to modify. **3** key, returns to item 2.
- If it is not registered, goes to the following item.

[TEL number is not registered.]

ABB. NBR =01

TEL NUMBER= (MAX38)
■

- Enter the TEL number (max. 38 digits) you wish to register.
If an address is foreign, input the overseas call number, a country number, a local number and an address number.
- Confirm the TEL number and press the ENTER button.

- Sometime a pause (3.3 seconds delay) is required for an overseas transmission or a PBX system.
Input a pause along with the TEL number by pressing the PAUSE/REDIAL () button.

4

ABB. NBR =01
TEL NBR =0425-86-74
ID NAME= (MAX20)

- Registers address name.
(Refer to "HOW TO SET THE ID NAME", in page)
- 1. Character selection display appears.
- 2. Move the cursor to the desired character.
- 3. Press the SET () button to select it. (Max. 20 characters)
- 4. Press the ENTER () button.

5

ABB. NBR =01
LINE SPEED?
1.9600BPS
2.4800BPS

- Select the transmission speed.
If you select **2** key, the transmission speed is slower, but the transmission becomes more certain.
- Press the ENTER () button.

- 6** [Registering as an one-touch key.]

ABB. NBR =01
PRESS ONE TOUCH KEY
TO ENTER OR
[↵]:TO SKIP

- Press the one-touch key (01 – 20) you wish to register the content of this abb. number and then go to item 7.
- If you do not wish to register, press the ENTER () button, and then go to item 7.

[One Touch Key is registered.]

ONE TOUCH=01

1.CANCEL
2.RETAIN

- If this one-touch key has already been used, select the code number in this display.
If you press **1** key, this cancels the content of this one-touch key and returns to the previous item. **2** key, returns to the previous item.

7

ENTER ABB. NUMBER
OR PRESS
[<]:TO CONTINUE
[↵]:TO COMPLETE

- If you wish to register another, repeat from item 2.
- If you are finished, press the ENTER () button.

Confirming the Transmission

You can confirm whether the transmission was completed normally, or not.

■ For normal transmission (except for memory transmission)

When the transmission has finished

```
15. 06. 89 16:30
                AUTO
```

- When a transmission has finished normally, you hear the end tone for 1 second.
- At this time, the OK sign and the number of the documents sent normally are displayed for 2 seconds, and returns to idle.

```
15. 06. 89 16:30
                AUTO
COMMUNICATION ERROR
```

- If a communication error has occurred, you hear the error tone for 4 seconds.
- At this time, communication error is displayed. To cancel the error display, press the RESET () button.

The display of last transmission result

- Press , **4** and **1**.

```
TSB-I0IC
                012345678
OK 06
```

- OK or NG sign and the number of the documents sent normally are displayed for 4 seconds.

Transmission journal

Print out the transmission journal by pressing the COPY/JOURNAL () button while no documents are loaded in the automatic document feeder.

Note: If press the COPY/JOURNAL () button while the document is loaded in the automatic document feeder, the TF251 starts the copy operation.

Single transmission report

It is possible to print out the transmission report for the last transmission after every transmission or only upon a communication error.

You request Toshiba's authorized person to set the functions of single transmission report, single memory transmission report, multi-address transmission report and multi-polling report.

Delayed Transmission

It is possible to program your TF251 to send documents to a specific location at a specific time. The following procedure is used to set up a delayed transmission.

■ Delayed transmission by menu operation (For single transmission)

- 1**
 - Load the documents.
 - Set the mode & the contrast.
 - 2**
 - Press , and .
 - 3**

SINGLE TRANSMIT

TEL NUMBER=

■

 - Dial the remote facsimile transceiver.
For key-pad dialling or abb. dialling, press the ENTER () button after entering the TEL number.
 - 4**

SINGLE TRANSMIT

DELAYED TRANSMIT?

1.NO 2.YES

 - Press key.
 - 5**

SINGLE TRANSMIT

START TIME =HH:MM

■■:■■

 - Input the time at which you wish to send, in a 24-hour clock format.
ex. 8:30am →
8:30pm →
 - Confirm the data input and press the ENTER () button.
 - 6**

SINGLE TRANSMIT

TO MEMORY ?

1.YES 2.NO

 - Select whether the documents are input to memory or not.
If you press key, the documents are read into the memory and you can remove them from the machine.
With documents in memory, no additional operations may be entered into memory. But the automatic document feeder is available for non-memory operations.
 - 7**

15. 06. 89 16:30

AUTO

MEMORY IN USE

 - When you input to the memory, "MEMORY IN USE" is displayed.
The documents are automatically sent at the specified time.
- Multi-address transmission, mail-box transmission, relay transmission, polling reception, multi-polling reception, operate in the same basic way.

■ Delayed transmission by one touch key

You can transmit simply by initiating a delayed transmission by one touch key.

- 1**
- Load the documents.
 - Set the mode & the contrast.

2

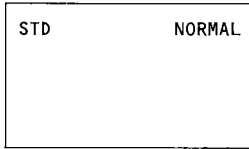

- Press the one-touch key assigned to the delayed transmission.

3

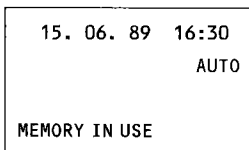

- The documents are sent to the specified address at the specified time.
- "MEMORY IN USE" is displayed when you set to use in memory by the one-touch key.

Note: When a document for delayed transmission has been entered to memory, the memory reception will not operate.

■ Registering the delayed transmission (For single transmission)

A delayed transmission operation can be programmed into a one touch key.

- 1** ● Press , , **5** and **4**.
(Able to omit)

- 2** ● Press the one-touch key (01-20) you wish to register.
● For example, press **20**.

PROGRAM KEY ENTRY
PRESS ONE TOUCH KEY
TO ENTER OR
[←]: TO COMPLETE

- 3** [Already assigned]

ONE TOUCH=20
1.CANCEL
2.MODIFY
3.RETAIN

- If this one-touch key has been assigned, select the code number in this display.
If you press **1** key, this cancels the content of this one-touch key and returns to item 2. **2** key, goes to the following item to modify. **3** key, returns to item 2.
- If it is not assigned, goes to the following item.

[Not assigned]

- Press **3**, **1** and **1**.

- 4** ● Dial to the address.
For key-pad dialling or abb. dialling, press the ENTER () button after setting TEL number.

SINGLE TRANSMIT

TEL NUMBER=
■

- 5** ● Same as the "Delayed transmission by menu operation", items 4 to 7.



- Multi-address transmission, mail-box transmission, relay transmission, polling reception, multi-polling reception operate in the same basic way.

Confirming/Cancelling the Delayed Transmission

■ Confirming the delayed transmission

You can confirm that the delayed transmission/polling reception has been programmed by the reservation list.

To print out the reservation list,

press ,  and .

■ Cancelling the delayed transmission

You can cancel the delayed transmission/polling reception by pressing the RESET () button.





1 ● Press the RESET () button.

2

CANCEL? 1.DOCUMENT FEEDER 2.MEMORY 3.POLLING RECEIVE →
4.NO

The code number of the reserved operation is blinking.

● Select the code number you wish to cancel.

If you press  key, the delayed transmission or the polling transmission, for which the documents are loaded in the automatic document feeder, is cancelled.  key, the delayed transmission, the multi-address transmission or the polling transmission, for which the documents have been input to the memory, is cancelled.  key, the delayed polling is cancelled.  key, no operation is cancelled and returns to idle.

3

ARE YOU SURE? 1.YES 2.NO

● Select whether to cancel the operation, or not.

If you press  key, no operation is cancelled and returns to idle.

4

CANCELLED

● When pressing  key, this operation is cancelled.

5

CANCEL LIST PRINTING

● The cancel list is printed out.

Transmitting by Program Button

You can transmit simply or conveniently by a program button.

A one-touch key in which a certain operation has been registered is called a program button.

The registerable operations

- Monitor function
- Multiple languages function
- Single transmission
- Multi-address transmission
- Mail-box transmission
- Relay transmission
- Single polling receiving
- Multi-polling receiving
- Polling from Mail-box







Monitor function

You can monitor the line after pressing the one-touch key assigned to the monitor function and dialling. When monitoring the line, you can determine whether the other party's line is busy or not.





If you press the RESET () button when the other party's line is busy, the machine has no monitor function for the document.

If the machine recognizes that the other party is a facsimile machine, the monitor function is turned OFF.



To register the monitor function,

- 1 ● Press , ,  and .
(Able to omit)
- 2 ● Press the one-touch key to which you wish to register the monitor function.
- 3 ● Press  key and the ENTER () button.

How to use the monitor function by "OPTIONS",

- 1 ● Press , ,  and .
(Able to omit)
- 2 ● The LINE MONITOR is set to ON. When this menu is recalled, the LINE MONITOR is set to OFF.
- 3 ● After 2 seconds and press the ENTER () button, the TF251 returns to the idle status.
● The monitor function should be activated before you try to use it.

Dialling while monitoring the line,

- 1 ● Press the one-touch key assigned to the monitor function.
- 2 ● Press the one-touch key assigned to the one-touch dialling. Or press the ABB. DIAL () button and an abb. number (2 digits) and the START () button, or ten key pad dialling.

Registering menu operation

The following is a menu of operations (except for the monitor and language function) which can be programmed into a one-touch key.

Once programmed you can transmit/receive simply by pressing this program button.

● Single transmission



● Multi-address transmission

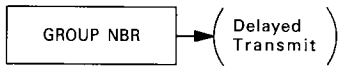

● Mail-box transmission

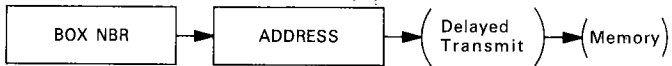

● Relay transmission



● Single polling receiving



● Multi-polling receiving



Overseas Transmission

■ No normal speed transmission

There are cases where the normal transmission speed of 9.6K is not possible for overseas communication.

In this case, set "4800 bps" by options or during the entering of an abb. number.

1 ● Press ,  and .

2

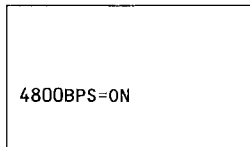



4800BPS=ON

● "4800BPS=ON" is displayed for 2 seconds.

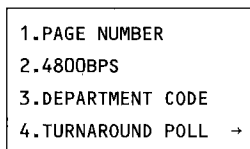
3



1.PAGE NUMBER
2.4800BPS
3.DEPARTMENT CODE
4.TURNAROUND POLL →

● Press the ENTER () button and the machine returns to idle.
If you want to set OFF, press  key instead of the ENTER () button.

4

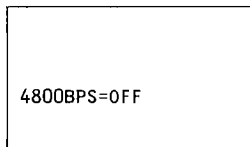

4800BPS=OFF

● Then, press the ENTER () button.
"4800 BPS=OFF" is displayed for 2 seconds.

Selecting the Number of Pages and Department Code (Option)

The number of pages; 2 digits, will be printed at the top of every page you send, if you select the number of pages option.



Additionally, if you wish to print out a department code of 5 digits on the transmission journal, you may select that option.

By selecting the department code option, you can determine what department or person has sent what or how many transmissions.

Print out eg.

+0425-86-7449 TOSHIBA HINO WORKS		001 P01/03 25.05.89 16:36						
Page								
<u>TRANSMISSION-JOURNAL</u>		TIME : 25.05.89 17:07						
		TEL NUMBER : +0425-86-7449						
		NAME : TOSHIBA HINO WORKS						
NBR	DATE	TIME	DURATION	PGS	TO	DEPT. CODE	MODE	STATUS
001	25.05	16:44	00/37	02	ABC CORP.	99017	EC	31
002	25.05	16:47	01/53	05	+03 999 0123		EC	31
003	25.05	16:50	00/00	00	035551111			
004	25.05	16:52	00/44	02	AIRBAG SYSTEM P21	56112	G3	00
005	25.05	16:54	00/37	02	PRESENT7 INC.		G3	00
006	25.05	16:57	01/31	01	JAPAN&USA ICL ROOM-3		G2	33
007					NET-EYE CORP. #2103	00475	G2	
				Department code				

■ Selecting the number of pages

- 1
 - Load the documents.
 - Set the mode & the contrast.
 - Press  and .

2

1.PAGE NUMBER
2.4800BPS
3.DEPARTMENT CODE
4.TURNAROUND POLL →

- Press  key.

3

PAGE NUMBER=
■■

- Enter the number of pages (2 digits) you wish to send. If you make a mistake, re-enter.
- Press the ENTER () button.

■ Selecting department code

1

1.PAGE NUMBER
2.4800BPS
3.DEPARTMENT CODE
4.TURNAROUND POLL →

- Press  key, to select the department code option.

2

DEPARTMENT CODE=
■■■■■

- Enter the numbers of department code (5 digits), press the ENTER () button.

Call Reservation

This feature lets you signal the other party that you want to speak with them after your facsimile exchange is completed and before disconnecting the line.

- 1**
- Press the CALL () button while the document is being sent.

```
G3   STD
     +12 3 456 7890
```



- 2**
- After that document is sent, the operator call signal is send.

```
G3   STD
     +12 3 456 7890
     CALL REQUEST
```

- 3**
- If you hear the call signal, lift the handset of telephone and press the CALL () button within 15 seconds to speak.

```
G3   STD
     +12 3 456 7890
     CALL
```

The feature can only be used when you have a telephone connected to your facsimile.

- Notes:**
- This feature can only be used when the other party has a telephone connected to their facsimile.
 - During the call reservation if you press the CALL () button again, the call reservation is cancelled.
 - If the other party does not press the CALL () button within 15 seconds after calling, the TF251 prints out the call back message when TEL number of the other party is informed.

Print-out eg.

```
VOICE REQUEST
                                     TIME      : 02.06.89 17:15
                                     TEL NUMBER : +0425-86-7449
                                     NAME       : TOSHIBA HIND WORKS

FOLLOWING FACSIMILE ATTEMPTED VOICE COMMUNICATION
TEL NBR      0425 22 5590
```

- When the calling tone is heard from your machine, lift the handset of telephone and press the CALL () button on the TF251. And then, you can speak with the calling party.

Transmission Reservation

During reception, you can set up the TF251 to reserve the line for the next transmission.

1

```
G3   STD
     +81 3 456 1287
```

- Load the documents in the automatic document feeder.
- Set the mode & the contrast, if you need.

2

```
STD           NORMAL
```

- Activate the transmission by abbreviated number or one-touch key dialling.

3

```
G3   STD
     +81 3 456 1287
TX RESERVATION:OT_02
```

- When the facsimile reception communication ends, the documents will be sent automatically.

- Notes :**
- Transmission reservation is only possible with abbreviated number or one-touch key dial locations. Before this operation, the correct telephone number must have been entered into an abbreviated number or one-touch key.
 - Once the documents are reserved for transmission, you can not cancel that operation until the reception ends.
 - The transmission reservation can not work during reception in G2 mode.

Manual Redialling

While waiting for the automatic redialling of a busy number, you may press the PAUSE/REDIAL () button to have the TF251 immediately redial the number.

1

WAITING TO REDIAL
AUTO

- Press the PAUSE/REDIAL () button.

2

DIALLING
TSB-IOIC
03456

- Starts the redialling.

- Notes :**
- In the case of a memory transmission, manual redialling is not possible. You must wait for the normal automatic redial operation.
The PAUSE/REDIAL () button works only when "WAITING TO REDIAL" is displayed.
 - As the automatic redialling is set to 3 times at 3-minute intervals, the manual redialling is not counted.

RECEIVING

Automatic Reception

In the automatic reception mode, the TF251 automatically answers incoming calls and receives any incoming documents.

If you wish to operate in the automatic reception mode, it is necessary that you select the TF251 to AUTO.

(Refer to "SETTING THE FUNCTIONS", in page 19.)

1

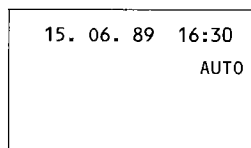

15. 06. 89 16:30
AUTO

- Idle status.

2

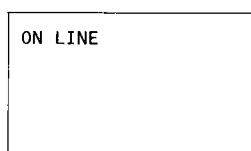

ON LINE

- The TF251 automatically detects the incoming ring signal.

3

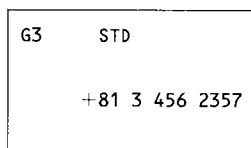

G3 STD
+81 3 456 2357

- The documents are being received.

4

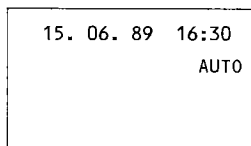

15. 06. 89 16:30
AUTO

- When the reception is completed, the TF251 returns to the idle status.

Manual Reception by Telephone

The manual reception mode is convenient when you wish to use your telephone line for voice as well as facsimile communications.

By selecting the manual mode you can answer the telephone call yourself and activate the facsimile manually if necessary.

(Refer to "SETTING THE FUNCTIONS", in page 19.)



1

15. 06. 89 16:30
MANUAL

- When the phone rings, lift the handset of telephone and speak to the caller.

2

ON LINE

- If the other party wants to send the document, press the START () button.
- In case of automatic transmission by the other party, you hear the ready tone every 3 seconds and so press the START () button.

3

G3 STD

+81 3 456 2357

- When starting to receive the document, hang up the handset.

4

15. 06. 89 16:30
MANUAL

- when the reception is completed, the TF251 returns to the idle status.

Call Reservation

You may call the other party after receiving the document.

1

```
G3   STD
      +81 3 456 2357
```

- Press the CALL () button while the document is being received.

2

```
G3   STD
      +81 3 456 2357
      CALL REQUEST
```

- When the facsimile reception of all documents ends, the operator call signal is sent.

3

```
G3   STD
      +81 3 456 2357
      CALL
```

- If you hear the call signal, lift the handset of telephone and press the CALL () button within 15 seconds to speak.

- Notes:**
- During the call reservation, if you press the CALL () button again, the call reservation is cancelled.
 - If you do not answer the telephone within 15 seconds after receiving the operator call signal, the TF251 prints out the call back message when TEL number of the other party is informed.

Print-out eg.

```
VOICE REQUEST
                                     TIME      : 02.06.89 17:14
                                     TEL NUMBER : +0425-86-7449
                                     NAME       : TOSHIBA HIND WORKS

FOLLOWING FACSIMILE ATTEMPTED VOICE COMMUNICATION
TEL NBR      0425 22 5590
```

Memory Reception

When the recording paper has run out during the reception, the TF251 can continue to receive data into the memory as a substitute reception up to the memory full.

- Note:**
- When a document for delayed transmission or polling reservation has been entered to memory, the memory reception will not operate.
 - The memory reception can not work in Group 2 mode.

1

```
15. 06. 89 16:30
                AUTO
PAPER EMPTY
MEMORY RECEPTION
```

- The recording paper is empty.
- Received document(s) stored in memory.

2

- Insure that the power switch stays ON, while loading the new roll of recording paper. Document(s) in memory will be lost if the power is turned OFF !

The orientation of the recording paper must be as shown below.

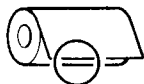

YES

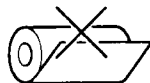

NO

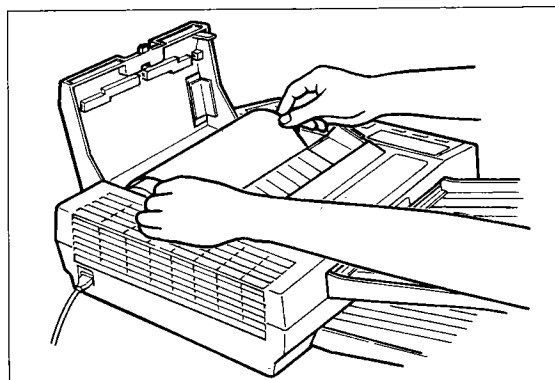

Refer to "ASSEMBLING THE RECORDING PAPER", in page 16.

3

```
15. 06. 89 16:35
                AUTO
PRESS START
MEMORY RECEPTION
```

- Press the START () button, and the received data will be printed out.
- No need to mention the reception journal if it is only printed after every 40 transactions and then, only if the switch is activated.

Note: This function is not used in F.R.Germany.

COPYING

Copying Documents

You can also use your facsimile for simple copying.

1

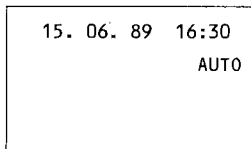

- Load the documents in the automatic document feeder.

2

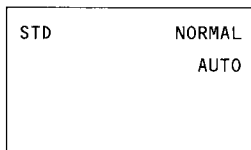

- Press the MODE () button to select the resolution.

[German type]

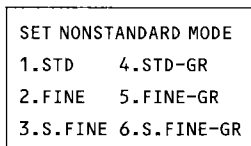

- For example, press  for "FINE-GR".

Note: The change of the mode setting cannot be performed between pages.

[Other type]

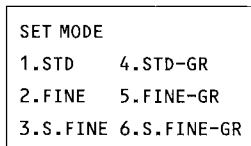

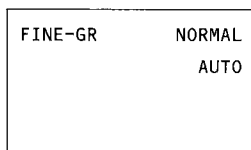

- For example, press  for "FINE-GR".

3



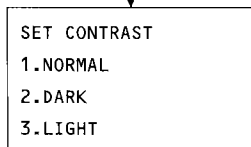

- Press the CONTRAST () button to select the contrast.

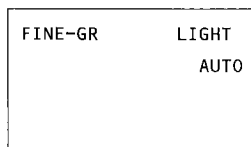

- For example, press  for "LIGHT".

4



- Press the COPY () button to start the copy operation.

5

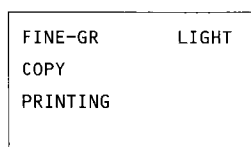

- The document is feeding through the unit and copied.

FACSIMILE NETWORK

This machine can provide additional economic benefits, in terms of time and money, when used in a facsimile network. With the exception of multi-address transmission, these facsimile network features require coordination between the involved facsimiles; particularly, the "hub" machine.

Multi-address transmission:

Transmits documents to multiple addresses (each in turn) during one transmission procedure. It is convenient and can save the operator time and effort.

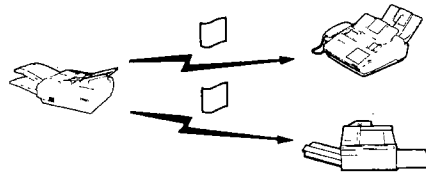

Relay transmission:

Transmits documents & multiple address instructions to a relay (hub) facsimile, which transmits the documents to the multiple addresses in sequence, during one transmission procedure. It is convenient and can save the operator time and effort.

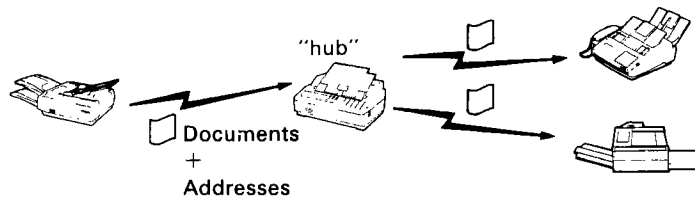

Mail-box communication:

Transmits documents to mail or receive them.

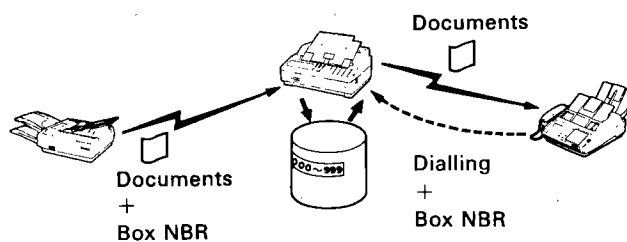

Polling communication:

The "to be polled" operator loads the documents at the transmitting facsimile in advance. The "polling" operator dials the transmitting facsimile and receives the documents.

This feature is convenient for a daily report.

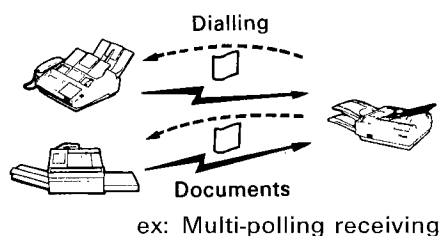

Multi-address Transmission

Transmits documents to multiple addresses, in sequence, during one transmission procedure.
There are some operations for multi-address transmission.

- The MULTI () button operation can select every single address from abb. number or one-touch key.
- Menu operation (multi-address transmission) can select every multi-address group and delay the transmission.
- The multi-transmission is performed by depressing the one-touch key in which multi-address group is registered.
- The multi-transmission is performed by only pressing the one-touch key (program button) that the menu operation of multi-transmission is registered.

■ Multi-address transmission by single setting (Use the MULTI () button)

- 1**
- Load the documents.
 - Set the mode & the contrast.

- 2**
- Press the MULTI () button.

3

STD	NORMAL
ENTER ABB. NUMBER OR	
ONE TOUCH KEY	

- Set the address by abb. dialling (2 digits abb. number) or one touch key.
- When you have set by abb. dialling, press the ENTER () button.

4

ABB. NBR =12-34
ONE TOUCH=01
ENTER MORE OR
PRESS [START]

- If you continue to set the address, repeat from item 3.
There is a max. of 20 addresses for one-touch keys and a max. of 50 addresses for abb. numbers.
- Once you finish selecting abb. number or one-touch keys, press the START () button.

5

ABB. NBR =12-34
ONE TOUCH=01
READING IN MEMORY
80% USED

- The documents are read into memory.
The TF251 then transmits to the multiple addresses from memory.

■ Multi-address transmission by group settings (Use menu operation)

- 1 ● Load the documents.
● Set the mode & the contrast.

- 2 ● Press ,  and .

3

MULTI TRANSMIT
GROUP NUMBER=(01-15)
■■

- Input the 2 digits multi-address group number.
- Confirm the multi-address group number and press the ENTER button.

4

MULTI TRANSMIT
GROUP NBR=03
ENTER MORE OR PRESS
[←]:TO COMPLETE

- If you wish to input additional group numbers, repeat item 3.
- If you are finished, press the ENTER () button. After this, you can set the delayed transmission. (Refer to "DELAYED TRANSMISSION", in page 30.)

5

15. 06.89 16:30
AUTO
MEMORY IN USE

- The documents are read into memory. The TF251 then transmits to the multiple addresses from memory.
- For a delayed transmission, they are transmitted at the specified time, automatically.

■ Multi-address transmission by group settings (Use the one-touch key in which the multi-address number is registered)

- 1 ● Load the documents.
● Set the mode & the contrast.

- 2 ● Press the one-touch key in which the multi-address number is registered.

3

STD	NORMAL
ONE TOUCH=01	
TOSHIBA GROUP	

- "ONE TOUCH=01" is displayed on the LCD for 2 seconds.



STD	NORMAL
READING IN MEMORY	
80% USED	

- The documents are read into memory. The TF251 then transmits to the multiple addresses from memory.

■ Multi-address transmission by group settings

(Use the one-touch key as a program button in which the menu operation for the multi-address transmission is registered)

1 ● Load the documents.

● Set the mode & the contrast.

2

```
STD          NORMAL
ONE TOUCH=02
MULTI GROUP
```

● Press the one-touch key in which the menu operation for the multi-address transmission is registered.

3

```
15. 06. 89 16:30
                AUTO
MEMORY IN USE
```

● The documents are read into memory.

The TF251 then transmits to the multiple addresses from memory.

● For a delayed transmission, they are transmitted at the specified time, automatically.

■ Confirming the multi-address transmission

When the transmission has finished, a multi-transmission report is printed.

Note: During the multi-address transmission, "MEMORY IN USE" is displayed.

In this procedure, while waiting for the automatic redialling of a busy number, the manual redialling is not possible.

You must wait for the normal automatic redial operation.

The manual redialling works only when "WAITING TO REDIAL" is displayed.

■ Registering for multi-address group

You can register the abb. numbers for a multi-address group numbers, and select up to 15 groups for the system.

These group numbers are useful for multi-address function.

- 1 ● Press , , **5** and **2**.
(Able to omit)

2



ENTER GROUP NUMBER
OR PRESS
[<]: TO CONTINUE
[↵]: TO COMPLETE

- Input the 2 digits multi-address group number you wish to assign.
- Confirm the multi-address group number and press the ENTER () button.

3

GROUP NBR=01

GRP. NAME= (MAX20)

- Registers multi-address group name.
(Refer to "HOW TO SET THE ID NAME", in page 13)
 1. Character selection display appears.
 2. Move the cursor to the desired character.
 3. Press the SET () button to select it. (Max. 20 characters)
 4. Press the ENTER () button.

4

GROUP NBR=01

ENTER ABB. NUMBER OR
[↵]: TO CONTINUE

- Input the 2 digits abb. number you wish to register as an address.
- Confirm the abb. number and press the ENTER () button.

5

GROUP NBR=01
ABB. NBR=01-02-03
ENTER ABB. NUMBER OR
[↵]: TO CONTINUE

- If you wish to continue to input abb. numbers, repeat item 4.
- If you have finished entering abb. numbers, press the ENTER () button.

6

GROUP NBR=01
PRESS ONE TOUCH KEY
TO ENTER OR
[↵]: TO SKIP

- Press the one-touch key to which you wish to register the contents of this multi-address group number.
- If you do not wish to register, press the ENTER () button.

7

ENTER GROUP NUMBER
OR PRESS
[<]: TO CONTINUE
[↵]: TO COMPLETE

- If you wish to register another group, repeat from item 2.
- If you wish to stop, press the ENTER () button.

Relay Transmission (See page 46.)

A Relay transmission permits the TF251 to transmit documents to multiple addresses by means of a relay (hub) facsimile. This can help in minimising phone expenses involved with numerous distant locations. Such a Relay Transmission network requires advance preparation to coordinate group and abb. number coding in the "hub" machine.

- The relay station is a TF-341M (Toshiba facsimile).
- The TF251 can not function as a Relay (hub) station.

There are three operations for relay transmission.

- The one-touch key in which the relay group number is registered
- Menu operation (relay transmission)
- The one-touch key (program button) in which the menu operation of relay transmission is registered

■ **Relay transmission by one-touch key**

(Use the one-touch key in which the relay group number is registered)

- 1**
 - Load the documents.
 - Set the mode & the contrast.
- 2**
 - Press the one-touch key in which the relay group number is registered.
- 3**
 - The TF251 transmits the documents to the relay station.

STD	NORMAL
ONE TOUCH=20	
RELAY GROUP	

■ Relay transmission by menu operation

- 1**
- Load the documents.
 - Set the mode & the contrast.

- 2**
- Press ,  and .

3

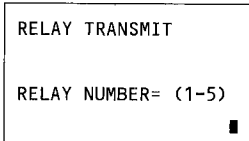

RELAY TRANSMIT
RELAY NUMBER= (1-5)

- Input the one digit relay group number (1-5).
- Confirm the relay group number and press the ENTER () button. After this, you can select delayed transmission and the transmission from memory.
(Refer to "DELAYED TRANSMISSION", in page 30.)

4

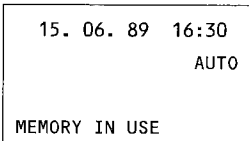

15. 06. 89 16:30
AUTO
MEMORY IN USE

- The TF251 transmits the documents to the relay station. For the transmission from memory, the documents are read into memory. For the delayed transmission, the documents are transmitted at the specified time, automatically.

■ Relay transmission by one-touch key

(Use the one-touch key as a program button in which the menu operation of the relay transmission is registered)

- 1**
- Load the documents.
 - Set the mode & the contrast.

- 2**
- Press the one-touch key in which the menu operation of the relay transmission is registered.

3

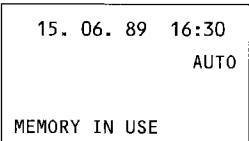

15. 06. 89 16:30
AUTO
MEMORY IN USE



- Transmits the documents to the relay station.
- For the transmission from memory, the documents are read into memory. For the delayed transmission, the documents are transmitted at the specified time, automatically.

■ Confirming the relay transmission

The multi-transmission report is sent back by setting the return code. (Refer to page 53.)

■ Registering for relay group

You can register addresses for relay group number, and it up to 5 groups for the facsimile network.



- 1 ● Press , , and .
(Able to omit)
- 2

ENTER RELAY NUMBER
OR
[<]:TO CONTINUE
[↵]:TO COMPLETE

 - Enter the one digits relay group number you wish to assign.
 - Confirm the relay number and press the ENTER button.
- 3

RELAY NBR=1

RELAY NAME= (MAX20)

 - Registers relay group name.
(Refer to "HOW TO SET THE ID NAME", in page 13.)
 1. Character selection display appears.
 2. Move the cursor to the desired character.
 3. Press the SET () button to select it. (Max. 20 characters)
 4. Press the ENTER () button.
- 4

RELAY NBR=1
ENTER RELAY STATION
ABB. NUMBER= (01-50)

■■

 - Enter the 2 digits abb. number of the relay station(Only an abb. number is valid for the relay station).
 - Confirm it and press the ENTER () button.
- 5

RELAY NBR=1
RELAY STN=01
END ADDRESS= (00-99)

■■

 - Enter the 2 digits end-address (end-group number) which is registered in the relay station.
 - Confirm it and press the ENTER () button.

RELAY NBR=1
RELAY STN=01
RETURN CODE= (00-99)

■■

 - Enter the 2 digits return code (abbreviated number) which the master station is registered in the relay station.
 - Confirm it and press the ENTER () button.
Go to item 6.
- 6

RELAY NBR=1
PRESS ONE TOUCH KEY
TO ENTER OR
[↵]:TO SKIP

 - Press the one-touch key to which you wish to register the contents.
 - If you do not wish to register, press the ENTER () button.
- 7

ENTER RELAY NUMBER
OR
[<]:TO CONTINUE
[↵]:TO COMPLETE

 - If you wish to register another relay number, repeat from item 2.
 - If you wish to finish, press the ENTER () button.

Mailbox

Some Toshiba facsimiles, such as the TF-341M, have a mailbox function that allows you to send confidential information. A document sent to a mailbox is not printed immediately but is stored in memory. It can only be printed by someone who knows the security code of the mailbox. Your facsimile can only send a document to another Toshiba facsimile which has a mailbox function.

■ Mail-box transmission

You can select the mail-box by menu operation. And you can register these operations to an one-touch key as a program button.

- 1**
- Load the documents.
 - Set the mode & the contrast.

- 2**
- Press ,  and .

3

TRANSMIT TO MAIL BOX
BOX NUMBER=(00-99)
■■

- Input the 2-digits mail-box number.
- Confirm the mail-box number and press the ENTER () button.

4

TRANSMIT TO MAIL BOX
BOX NBR=01
TEL NUMBER=
■

- Input the mail-box station by key pad dialling, abb. dialling or one-touch dialling.
- If you input by key pad dialling or abb. dialling, press the ENTER () button after entering.
After this, you can select delayed transmission and transmission from memory.

5

15. 06. 89 16:30
AUTO
MEMORY IN USE

- The TF251 transmits the documents to the mail-box station.
For the transmission from memory, the documents are read into memory.
For the delayed transmission, the documents are transmitted at the specified time, automatically.

Polling

The "to be polled" operator must set the documents at the transmitting facsimile in advance. At the receiving facsimile, the "polling operator" dials (polls) the transmitting facsimile. Then you can receive the documents.

There are four methods of polling communication.

- Polling reservation
- Polling reception
- Turnaround polling
- Multi-polling reception

Note: ● If you select the 4 digits security code as check-code, you can receive from Toshiba's TF-series facsimile transceivers only.

You should select the "NO" or "TEL" as check-code if you poll or reserve a polling transmission for another facsimile transceivers.

■ Polling reservation (For example: polling reservation with a security code)

- 1**
- Load the documents.
 - Set the mode & the contrast.

- 2**
- Press , and .

3

POLLING RESERVE	
SECURITY CODE/TEL?	
1.NO	3.CODE
2.BOTH	4.TEL

- Select the check-code.
To select security code, press key.

4

POLLING RESERVE	
SECURITY CODE=	
■■■■	

- Input the 4 digits security code.
- Confirm the security code and press the ENTER () button.

5

POLLING RESERVE	
TO MEMORY?	
1. YES	2. NO

- Select whether the documents are input to memory or not.
- If you press key, the documents are read into memory (Info. -box).
In this case, when the documents are polled, they remain in memory. Therefore another facsimile can poll them again and again.

6

15. 06. 89	16:30
	AUTO
POLLING RES.	
(MEMORY IN USE)	

- For a transmission from memory, the documents are read into memory.
The TF251 then transmits the documents when your machine receives the polling signal and the same security code or the same telephone number.

- Note:**
- If you wish to cancel polling reservation, press the RESET () button. And then press key, you can cancel polling reservation.
 - When you wish to cancel polling reservation in memory, you should select "2. MEMORY" in the cancel menu.

■ Polling reception

There are three operations for polling reception.

- Normal polling reception
- Polling by menu operation
- The one touch key (program button) in which the single polling reception operation is registered.

Normal polling reception

(For example: reception with a security code)

[Idle status]

1

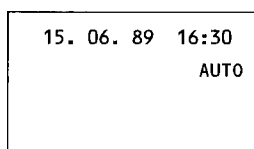

15. 06. 89 16:30
AUTO

- Input the address by key pad dialling, abb. dialling or one-touch dialling without documents on the automatic document feeder.
- If you input by key pad dialling or abb. dialling, press the START () button after setting.

2

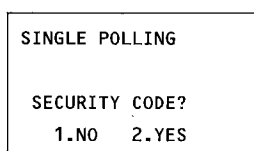

SINGLE POLLING
SECURITY CODE?
1.NO 2.YES

- Select whether you are using a security code, or not. To set the security code, press  key.

3

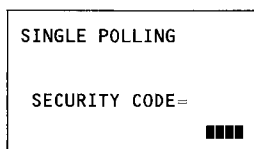

SINGLE POLLING
SECURITY CODE=
■■■■

- Input the 4 digit security code.
- Confirm the security code, press the ENTER () button.

4

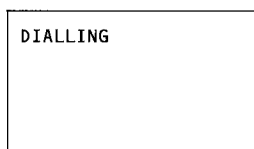

DIALLING

- Polls to the address.

Polling by menu operation

- 1** ● Press , **2** and **2**

2

SINGLE POLLING

TEL NUMBER=

█

- Input the address by key pad dialling, abb. dialling or one-touch dialling.
- If you input by key pad dialling or abb. dialling, press the ENTER () button.

3

SINGLE POLLING

SECURITY CODE ?

1.NO 2.YES

- Select whether you are using a security code, or not. To set the security code, press **2** key.

4

SINGLE POLLING

SECURITY CODE=

■■■■

- Input the 4 digits security code.
- Confirm the security code, press the ENTER () button. After this, you can set the delayed polling. (Refer to "DELAYED TRANSMISSION", in page 30.)

5

DIALLING

- Polls to the address. For the delayed polling, polls at the specified time, automatically.

Polling reception

(Use the one-touch key as a program button in which the operation is registered)

- 1** ● Press the one-touch key in which the single polling operation is registered.
- 2** ● Polls to the address.
- For the delayed polling, polls at the specified time.

■ Turnaround polling

You can poll another facsimile transceiver after transmitting your documents, by one operation.

- 1** ● Load the documents.
- Set the mode & the contrast.
 - Press , **3** and **4**.

2

TURNAROUND POLL

SECURITY CODE?

1.NO 2.YES

- Select whether you are using a security code, or not. To set the security code, press **2** key.

3

TURNAROUND POLL

SECURITY CODE=

■■■■

- Input the 4 digit security code.
- Confirm the security code, press the ENTER () button.

- 4** ● Follow to operate usual send the documents.

■ Multi-polling reception

Polls and receives from multiple addresses in sequence.

There are several methods for multi-polling reception, much the same as multi-address transmission.

- The MULTI () button operation
- Menu operation (Multi-polling receiving)
- The one-touch key in which a multi-address group is registered.
- The one-touch key (program button) in which the menu operation for multi-polling is registered.

Multi-polling reception by a single setting

(Use the MULTI () button)

(For example: receiving with a security code)

1 ● Press the MULTI () button.

2

MULTI POLLING
ENTER ABB. NUMBER OR
ONE TOUCH KEY

- Set the address by abb. dialling (ABB. DIAL and 2-digit abb. number) or one-touch key.
- Press the ABB. DIAL () button when you have set by abb. dialling.

3

ABB. NBR=12

ENTER MORE OR
PRESS [START]

- If you have additional addresses to set, repeat item 2.
- If you are finished, press the START () button.

4

MULTI POLLING

SECURITY CODE?
1.NO 2.YES

- Select whether you are using a security code, or not. To set the security code, press  key.

5

MULTI POLLING

SECURITY CODE= 

- Input the 4 digits security code.
- Confirm the security code, press the ENTER () button. After this, you can set the delayed polling. (Refer to "DELAYED TRANSMISSION" in page 30.)

6

DIALLING

- Polls to the multiple addresses. For the delayed polling polls at the specified time, automatically.

Multi-polling reception by group settings

(Use menu operation)

(For example: receiving without a security code)

1 ● Press , **2** and **3**.

2

MULTI POLLING
GROUP NUMBER=(01-15) ■■

- Input the 2 digit multi-address group number.
- Confirm the multi-address group number and press the ENTER () button.

3

MULTI POLLING
GROUP NBR=03
ENTER MODE OR PRESS
[]: TO COMPLETE

- If you wish to input additional group numbers repeat item 2.
- If you are finished, press the ENTER () button.

4 ● Select whether you are using a security code, or not.
If you do not intend to set a security code, press **1** key. After this, you can set the delayed polling.
(Refer to "DELAYED TRANSMISSION", in page 30.)

5 ● Polls to the multiple addresses.
For the delayed polling, polls at the specified time, automatically.

Multi-polling reception by group settings

(Use the one-touch key in which the multi-address group number is registered)

(For example: receiving without a security code)

1 ● Press the one-touch key in which the multi-address group number is registered.

2 ● Select whether you are using a security code, or not.
When not using a security code, press **1** key.

3 ● Polls to the multiple addresses.

Multi-polling reception by group settings

(Use the one-touch key as a program button in which the menu operation for the multi-polling is registered)

1 ● Press the one-touch key in which the menu operation for the multi-polling is registered.

2 ● Polls to the multiple addresses.

Confirming the multi-polling reception

When the multi-polling has finished, the multi-polling report is printed (if you have selected that operation).

You can select output condition from "always", "at polling error" and "no printing", set by an authorized Toshiba dealer..

OMR SHEETS

Most of the functions which you can set using the operating panel can also be set using a special sheet that is fed through the facsimile at the start of a document.

This sheet, called an Optical Mark Reader (OMR) sheet, has the advantage that it can be reused several times. So that all you have to do is included to this sheet at the beginning of the document when sending to a particular facsimile.

When beginning a transmission using the OMR sheet, additional OMR sheet tasks are possible. But, this is not possible when you commence transmission without using OMR sheets.

Filling Out OMR Sheets

Use lead pencil (HB or darker) to fill out the OMR sheet.

An OMR sheet consists of 10 rows for marking settings and other information. To select settings, fill in the box above the item with the pencil.

The OMR sheet performs the following settings:

- Transmission/Polling: Tx/Po
- Relay/Mail Box RL/MB
- Mode: ST (Standard)/FI (Fine)/SF (Semi-Super Fine)/HS (High Speed)
- Contrast: DK (Dark)/NR (Normal)/LI (Light)/GRY (Gray)
- Number of pages to be sent: 1/2/3/4/5/6/7/8/9/10
- Overseas Transmission: 4800bps ON/OFF
- Polling Security Code
 - Code 1: 0/1/2/3/4/5/6/7/8/9
 - Code 2: 0/1/2/3/4/5/6/7/8/9
 - Code 3: 0/1/2/3/4/5/6/7/8/9
 - Code 4: 0/1/2/3/4/5/6/7/8/9
- Starting time: Immediate transmission starts if no marking. (Marking by 24-hour method)
- Group number: 1/2/3/4/5/6/7/8/9/10/11/12/13/14/15
- Relay group number: 1/2/3/4/5
- Abbreviated number: 01 - 50
- Mail box number
 - Box No. 1: 0/1/2/3/4/5/6/7/8/9
 - Box No. 2: 0/1/2/3/4/5/6/7/8/9

Fill out it in order to Code 1, 2, 3 and 4.

Using OMR Sheets

To use an OMR sheet, simply place it face down in the automatic document feeder and then load your document(s) on top of the OMR sheet.

The diagram shows an OMR sheet with the following fields and their corresponding marking positions:

- TX, PO, R, L, M, B**: Marking positions for transmission parameters.
- ST, J1, SF, HSL, GR, NR, LI, GRAY, CONTRAST, MODE**: Marking positions for mode and contrast settings.
- NUMBER OF PAGES**: Marking positions for digits 1 through 10.
- 480000**: A fixed value field.
- SEC CODE1, SECURITY CODE, SEC CODE2, SEC CODE3, SEC CODE4**: Marking positions for security codes.
- HOUR**: Marking positions for digits 10 and 20.
- START TIME**: Marking positions for digits 0 through 9.
- GROUP NUMBER**: Marking positions for digits 1 through 10.
- ABBREVIATED NBR.**: Marking positions for digits 01-10 and 11-20.
- MAIL BOX NBR.**: Marking positions for digits 0 through 9.
- BOX NBR. 1, BOX NBR. 2**: Marking positions for box numbers 0 through 9.

Labels at the bottom of the sheet: **OMR AUTO-CALLER** and **TOSHIBA TF251**. A small number **8182** is visible at the bottom right corner.

- Notes:
- If you mark items that cannot be done simultaneously, such as selecting both dark (DK) and normal (NR), your facsimile will reject the OMR sheet and display "OMR ERROR".
 - The maximum number of pages that you can send when using an OMR sheet is 20, including the OMR sheet itself.
 - If you continue to reuse an OMR sheet, it will eventually become soiled and will not be read correctly. Replace old OMR sheets with new ones.
 - If no marking at MODE and/or CONTRAST, they are set to the home position of your machine. If marking at GRAY only and no marking at CONTRAST, your machine goes to OMR error.
 - It is not possible for the polling reservation.
 - They are able to set for one or more group number and/or abb. number. This function results in multi-address transmission or multi-polling.
 - You should mark a mail box number for mail box communication. A mail box number is 2 digits. If number of digit is mismatched, your machine goes to OMR error.

Operation Table of OMR Sheets

You can set the various operations by the OMR sheet(s).

The items to be set for each operation are shown in the table below.

	Tx	Po	Rl	MB	Ⓐ	SECURITY CODE 1 ~ 4	START TIME	GROUP NBR.	RLY- GRP	ABB. NBR.	MAIL BOX NBR.
Single Tx	⊙				○		○			⊙	
Multi- address Tx	⊙				○		○	⊙ * 1 or more		⊙ * 1 or more	
Mail-box Tx	⊙			⊙	○		○			⊙ Mail station	⊙ 2-digit
Relay Tx	⊙		⊙		○		○		⊙		
Single polling		⊙				⊙ ★ 4-digit	○			⊙	
Multi- polling		⊙				⊙ ★ 4-digit	○	⊙ * 1 or more		⊙ * 1 or more	

Notes: Ⓐ : This item contains MODE, CONTRAST, NUMBER OF PAGES and 4800bps.

⊙ : You must set the item of ⊙.

○ : You can select the item of ○.

* : You must mark GROUP NUMBER or ABB. NUMBER.

★ : You must mark if SECURITY CODE is set by transmitting party at polling.

LISTS, REPORTS AND TEST MODE

Communication Journals

The communication journal is printed out by two methods, automatic journal output and manual journal output, as follows.

- Automatic journal output: If the automatic journal output mode of the "INSTALLATION" is set to ON, the communication journal is printed out automatically when the memory becomes full after every 40 transactions.
- Manual journal output: Press the COPY/JOURNAL () button to (with no document in the automatic document feeder) print out the communication journal.

Print-out eg.

Facsimile's telephone No. ID name

TRANSMISSION-JOURNAL

TIME : 05.06.89 10:09
 TEL NUMBER : +0425-86-7449
 NAME : TOSHIBA HIND WORKS

NBR	DATE	TIME	DURATION	PGS	TO	DEPT. CODE	MODE	STATUS
001	25.05	18:22	00/49	03	ABC CORP.		G3 M	OK
002	25.05	18:23	01/01	03	RED-EYE CORP. #2103		G3 M	OK
003	25.05	18:25	01/01	03	COMMUNICATION MIX I.		G3 M	OK
004	25.05	18:30	00/50	03	ABC CORP.	56120	G3 M	OK
005	25.05	18:31	00/00	00	AIRBAG SYSTEM P21	56120	M	50
006	25.05	18:33	00/51	03	PRESENT? INC.	56120	G3 M	OK
007	25.05	18:34	00/00	00	JAPAN&USA ICL ROOM-3	56120	M	50
					ABC CORP. #2103	56120	G3 M	OK

Address's facsimile telephone Nos. or name

Department code

Number of pages

Minutes/Seconds

Communication starting date & time

Error code

Completion status (OK or NG)

Communication mode

G2 CCITT Group 2 Mode

G3 CCITT Group 3 Mode

HS Toshiba high-speed transmission mode

EC CCITT Group 3 Error Correction Mode

EX Toshiba Error Correction Mode

M By memory

P By polling

RECEPTION-JOURNAL

TIME : 25.05.89 18:19
 TEL NUMBER : +0425-86-7449
 NAME : TOSHIBA HIND WORKS

NBR	DATE	TIME	DURATION	PGS	FROM	MODE	STATUS
001	25.05	17:12	00/26	01	+0245 12 3456	EX	
002	25.05	18:00	00/20	01	+0245 12 3456	EX	P
003	25.05	18:02	00/52	03	+001258641235	HS	
004	25.05	18:05	03/51	02		G2	
005	25.05	18:16	01/26	05	0458 99 9909	HS	

Communication Reports

Each communication report is printed out after the communication is completed, or when an error occurs(or not at all).

You can select whether or not or when to print the report set by an authorized Toshiba dealer.

Print-out ex.

<u>TRANSMISSION-REPORT</u>							TIME	: 25.05.89 18:46	
							TEL NUMBER	: +0425-86-7449	
							NAME	: TOSHIBA HINO WORKS	
NBR	DATE	TIME	DURATION	PGS	TO	DEPT.CODE	MODE	STATUS	
010	25.05	18:45	01/25	03	0458 99 9909		G3	00	
(ERROR ON P;AGES : 01)									

Numbers of pages which were not sent correctly.

<u>MULTI TRANSMISSION REPORT</u>			TIME	: 25.05.89 18:43	
			TEL NUMBER	: +0425-86-7449	
			NAME	: TOSHIBA HINO WORKS	
<u>GROUP NBR : 15</u>					
ABB NBR :					
START TIME : 25.05.89 18:29					
END TIME : 25.05.89 18:43					
PAGES : 03					
<u>SUCCESSFUL</u>					
01	ABC CORP.		03-123-4567		
03	PRESENT? INC.		013-258-5600		
05	RED-EYE CORP. #2103		03-999-5678		
<u>UNSUCCESSFUL</u>					
				<u>SEND PGS</u>	
02	AIRBAG SYSTEM P21		035551111		00
04	JAPAN&USA ICL ROOM-3		00112586985		00
50	COMMUNICATION MIX I.		0425-86-2240		00

Multi-communication group number & name

Address's facsimile Abb. number, name & telephone No.

MEMORY TRANSMISSION REPORT

TIME : 27.05.89 10:33
TEL NUMBER : +0425-86-7449
NAME : TOSHIBA HIND WORKS

TEL NUMBER : 0123-45-6789
START TIME : 27.05.89 10:33
END TIME : 27.05.89 10:33
DOC. PAGES : 01
SEND PAGES : 01

CANCEL LIST

TIME : 25.05.89 19:56
TEL NUMBER : +0425-86-7449
NAME : TOSHIBA HIND WORKS

1. DOCUMENT TRANSMISSION

** CANCELLED **

ABB. NUMBER
TEL NUMBER 0425-84-5200
TIME OF TRANS. 20:20
NUMBER OF PAGES

When memory is erased
at power failure,
**CANCELLED BY POWER
FAILURE** is displayed.

2. MEMORY TRANSMISSION

(POLLING)

GROUP NUMBER
ABB. NUMBER
TEL NUMBER
TIME OF TRANS. :
NUMBER OF PAGES 01

for polling
transmission set

3. POLLING RECEPTION

GROUP NUMBER
ABB. NUMBER 01
TEL NUMBER
TIME OF POLL. 21:00

Telephone Numbers Reservation & Function Lists

The registered and set lists are printed out by the menu operation.

● Telephone number list: Press , **4** and **3**.

• TELEPHONE NUMBERS LIST •

TIME : 25.05.89 20:13
TEL NUMBER : +0425-06-7449
NAME : TOSHIBA HIND WORKS

ABBREVIATED TEL NUMBER INFORMATION

ABB. NBR	NAME	TEL NUMBER	4900BPS
01	ABC CORP.	03-123-4567	
02	AIRBAG SYSTEM P21	035551111	ON
03	PRESENT? INC.	013-250-5600	
04	JAPAN&USA ICL ROOM-3	00112596985	
05	RED-EYE CORP. #2103	03-999-5678	ON
50	COMMUNICATION MIX 1.	0425-06-2240	ON

GROUP NUMBER INFORMATION

GROUP NBR	NAME	ABB. NBR
01	BAR GROUP	01 03 05 50
02	WORKS FRIENDS	02 03 04
10	PLAYBOOL GROUP	01 05 50
15	ALL (OLD+NEW)	01 02 03 04 05 50

RELAY NUMBER INFORMATION

RELAY NBR	NAME	RELAY STN	END ADDR.	RET. CODE
1	GOOD DAY	03	04	04
2	FIGHT-NOW	01	50	55
5	RETRY99	05	50	55

ONE TOUCH KEY INFORMATION

OT NBR	FUNCTION	ID (TEL. NBR ABB. NBR GROUP NBR)	S/R	TIME	MAIL	MEM. IN
01	ABB. NBR	01	S/R			
02	ABB. NBR	02	S/R			
03	ABB. NBR	04	S/R			
04	GRP. NBR	G01	S/R			
05	ABB. NBR	05	S/R			
06	MONITOR					
07	LANGUAGE					
08	GRP. NBR	RG2	S/R			
09	GRP. NBR	RG1	S/R			
10	GRP. NBR	G15	S/R			
11	OPERATE	03-456-7890	S	22:20		
12	OPERATE	0425-22-0052	R			
14	OPERATE	001-1-212-123-5076	S		01	
15	GRP. NBR	G10	S/R			
16	OPERATE	00181033217654	S	00:20		ON
17	OPERATE	03	S			
18	OPERATE	G01	R	23:20		
19	GRP. NBR	G02	S/R			
20	ABB. NBR	03	S/R			

Printed at overseas transmission

End address and return code

Memory in use or not
Mail box in use or not
Starting time, hour & minute
S: Send, R: Receive

- Reservation list: Press , and .





<u>CANCEL LIST</u>		TIME	: 25.05.09 19:56
		TEL NUMBER	: +0425-06-7449
		NAME	: TOSHIBA HIND WORKS
1. DOCUMENT TRANSMISSION		** CANCELLED **	
ABB. NUMBER			
TEL NUMBER		0425-04-5200	
TIME OF TRANS.		20:20	
NUMBER OF PAGES			
2. MEMORY TRANSMISSION		(POLLING)	
GROUP NUMBER			
ABB. NUMBER			
TEL NUMBER			
TIME OF TRANS.		:	
NUMBER OF PAGES		01	
3. POLLING RECEPTION			
GROUP NUMBER			
ABB. NUMBER		01	
TEL NUMBER			
TIME OF POLL.		21:00	

- Function list: Press , and .

<u>FUNCTION LIST</u>		TIME	: 25.05.09 20:18
		TEL NUMBER	: +0425-06-7449
		NAME	: TOSHIBA HIND WORKS
. RECEPTION MODE		:	AUTO
. JOURNAL			
AUTO		:	OFF
MANUAL		:	TX&RX
ERROR CODE		:	OFF
. TTI		:	INSIDE
. CONTRAST(HOME POSITION)		:	NORMAL
. VOLUME LEVEL		:	4
. TOTAL PAGE			
SCAN		:	524692
PRINT		:	525958

Test Mode



You can check the operation panel and the print head by using TEST MODE function.

1 ● Press , ,  and .

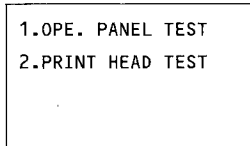
2



1.OPE. PANEL TEST
2.PRINT HEAD TEST

- Press  key, and you can check the LCD and switches on the operation panel.
- Press  key, and the test pattern prints out.

■ OPE. PANEL TEST

Ope. panel test is used to check fluorescent lamp, the LCD and switches on the operation panel. In this mode,

- Fluorescent lamp is turned on.
- The LCD is turned on and off at 1 second interval.
- Depressed switch is displayed on the LCD.

Finally press the RESET () key to return to the idle state.

TROUBLESHOOTING

Error Messages

The TF251 continuously monitors its status and displays a message if it detects an abnormality. At the same time, it sounds an alarm to alert the operator. The messages and the responses you should make to them are explained below.

MEMORY ERASED
PRESS RESET

- Memory is erased due to discharged or disconnected back-up battery.
- Press the RESET () button.
Re-enter all data of the ID name, abb. number, etc..

15. 06. 89 16:30
AUTO
CUTTER ERROR

- Cutter has not returned to its proper position.
- Turn the POWER switch OFF and then ON.

15. 06. 89 16:30
AUTO
POWER FAILURE
MEMORY REC. LOST

- Memory reception or memory transmission data has been erased by power failure.
- Press the RESET () button.

15. 06. 89 16:30
AUTO
DOCUMENT JAM

- The document is jammed.
- Remove the jammed document and then press the RESET () button.

15. 06. 89 16:30
AUTO
PAPER JAM

- The recording paper is jammed.
- Remove the jammed paper.

15. 06. 89 16:30
AUTO
PAPER EMPTY

- The recording paper is empty.
- Load a new roll of recording paper.

When the recording paper is loaded in case of both "PAPER JAM" and "PAPER EMPTY", the LCD shows:

15. 06. 89 16:30
AUTO
PRESS START

- Press the START () button the recording paper is reset, and the TF251 returns to the idle status.

UF NORMAL
MEMORY OVERFLOW

- Memory is full. Memory is cleared.
- Try again by dividing the communication.

15. 06. 89 16:30
AUTO
COMMUNICATION ERROR

- A communication error has occurred.
- Try again.

15. 06. 89 16:30
AUTO
POWER FAILURE

OMR JOB
OMR ERROR

NOT PERMISSIBLE

NUMBER NOT LISTED

TSB-IOIC
+81 3 456 2736
FEATURE UNAVAILABLE

TPH OVERHEAT



15. 06. 89 16:30
AUTO
TPH OVERHEAT

- A power failure has occurred.
- See the cancel list or the transmission report and try again.

- The TF251 rejects data on the OMR sheet.
- Re-fill out the OMR sheet and try again.
- Re-check the OMR sheet, dirty or damaged.
- Check for invalid entries or incomplete erasures.

- This operation or setting is not permitted.
For example, use the relay transmission without system password.

- Abbreviated, group or relay number is not registered.
For example, use the one touch dialling or abbreviated dialling which is not registered, and the LCD shows it.
- Register the abbreviated number.

- The other party's machine does not have relay or mail box capability, or try to poll the other party which the document is not loaded.
- Press the RESET () button.

- The head is over-heated.
- The TF251 can not be operated.
Please wait, while the facsimile is cooling.

- Press the RESET () button, and the LCD shows in the left display.

Recording Paper Jam

When the recording paper jams, the following message is displayed on the LCD. Follow the procedure given below.

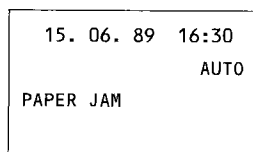

1. Leave the POWER switch ON, and open the paper compartment cover.
2. Press the BACK SHIFT button () to release the cutter.
3. Pull the green paper release knob.
4. Grasp the jammed paper firmly on both edges and pull it to the rear of the machine.
Make sure any small pieces of paper which may have torn off are removed, use tweezers if necessary.

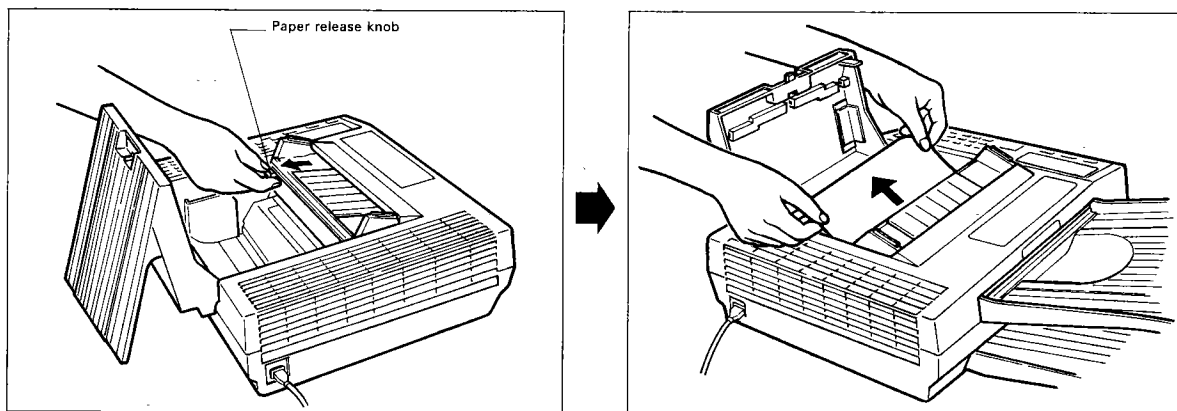

5. Cut off any wrinkled paper from the end of the roll; making the end square and clean.
6. Reload the paper as shown in the figures on the inside of the cover.

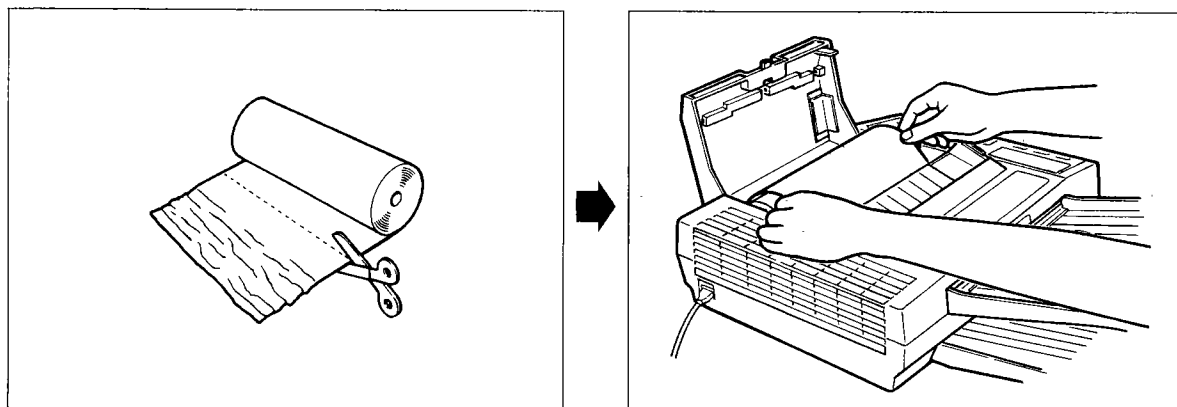

7. Push the green knob back into position and close the cover.
8. When there is data in memory (from a substitute reception), press the START () button and the received data is printed out.

Note: If the POWER switch is turned OFF when the message of "MEMORY IN USE" or "MEMORY RECEPTION" is displayed on the LCD, the data will be erased.

- When the jammed paper is not removed by the first procedure.
(The recording paper may be jammed in the cutter/platen roller area.)

1. Be sure to turn the POWER OFF.
2. Stand the machine on the desk and hold it by one hand.
Determine if the recording paper is accessible from the bottom access panel.
3. Gently pull the jammed recording paper until the jam is removed.

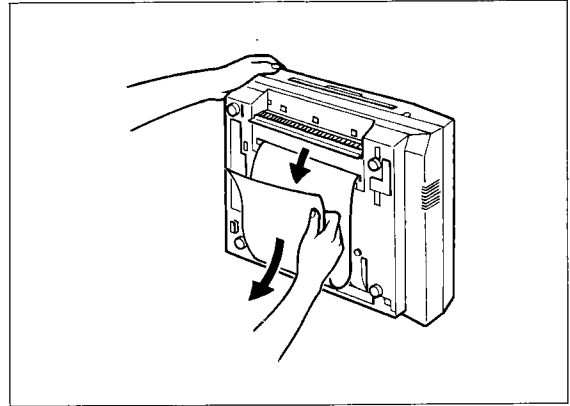
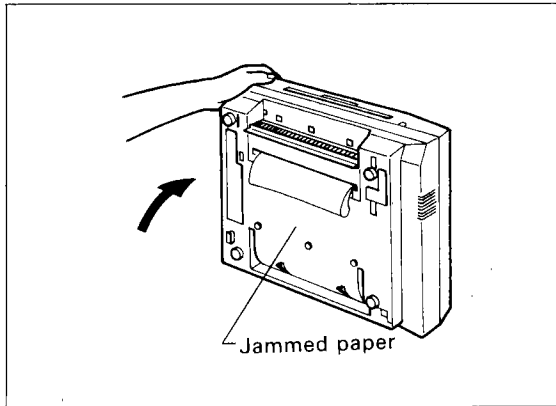

4. Cut off the recording paper.
5. Lay down the machine normally.

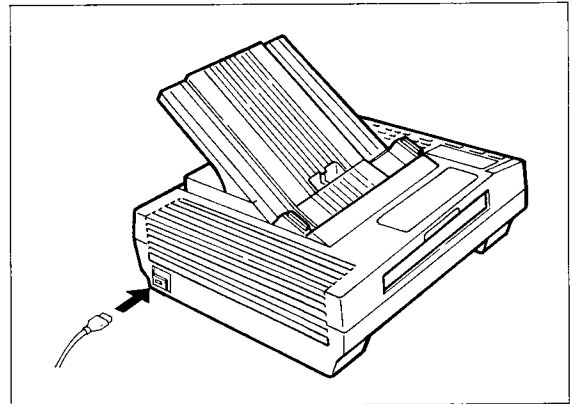
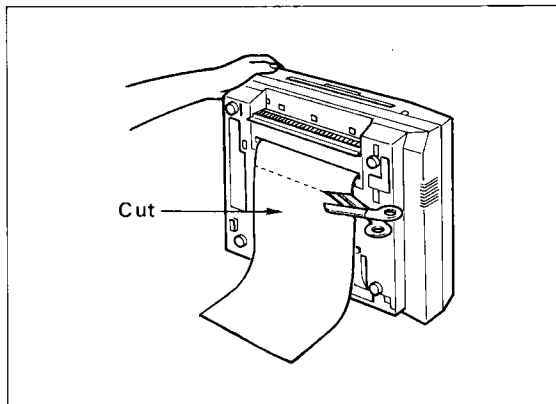

6. Pull the green paper release knob.
7. Pull the recording paper and reload it correctly.
8. Push the green knob back into position and close the cover.
9. Turn the POWER switch back ON and press the START () button.

Document Jam

When a document jams during a transmission, a following message is displayed on the LCD. Follow the procedure given below.

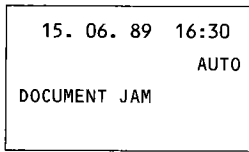

1. Leave the POWER switch ON.
2. Pull out the grey document release bar above the document output slot. This will release the pressure on the feed rollers.

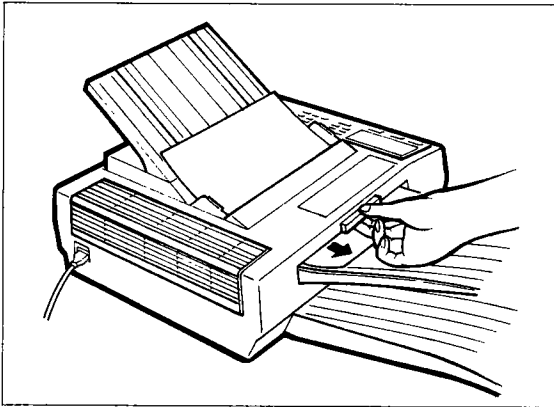

3. Grasp the jammed document firmly on both edges and pull it back to the rear. Make sure any small pieces of document which may have torn off are removed, use tweezers if necessary.

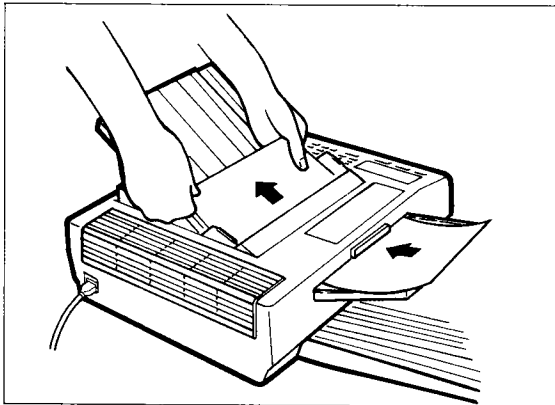

4. Push the grey document release bar back into place.
5. Press the RESET (⏏) button to erase the displayed message of "DOCUMENT JAM".
5. Copy the jammed document on a standard copy machine and resend it.

Note: If the POWER switch is turned OFF when the message of "MEMORY IN USE" is displayed on the LCD, the data in memory will be erased.
Make a copy of the damaged document on a standard copy machine and re-establish the transmission.

Troubleshooting for Transmission

PROBLEM

The document is loaded, but the facsimile does not work.

The document is loaded, but the facsimile does not feed the document.

The START (⏏) button has been pressed, but the transmission does not start.

Operation is normal, but the facsimile message cannot always be sent.

REMEDY

- Check to see that the AC power cord is plugged into an active outlet.
- Check to see if there is a message on the LCD and follow the remedy instructions given in this manual. Press the RESET (⏏) button.
- Check to see if the document release lever is in the proper position.
Adjust it if necessary.
- Is the document size larger than the specified maximum size?
- Is the number of the documents within the 20 sheets limit?
- Are there any related messages on the LCD? Follow the instructions for that message and then press the RESET (⏏) button to release the message.
- Did you hang up the handset before pressing the START (⏏) button?
If so, press the START (⏏) button and then hang up the handset.
- Is the previous document jammed?
Press the RESET (⏏) button to expel the document.
- Check whether there is a problem with the receiving machine, or if there is a compatibility problem.

Troubleshooting for Reception

PROBLEM

The START (ⓧ) button has been pressed, but the document reception does not start.

No recording paper appears during the reception.

If the recording paper has been replaced, but the message "PAPER EMPTY" is still displayed.

There is no image on the recording paper.

REMEDY

- Is the AC power plug connected to an active power outlet?
- Are you out of recording paper?
- Did you hang up the handset before pressing the START (ⓧ) button?
If so, try again and replace the handset after pressing the START (ⓧ) button.
- Check to see if the recording paper is correctly loaded.
- Check whether the recording paper is correctly inserted.
- Check whether the recording paper is correctly loaded. Insure the paper wasn't loaded backwards!
- Check with the sending party to make sure the document wasn't fed in upside down.

Error Codes

USER CODE	SERVICE CODE	DESCRIPTION	REMEDY
10	10	Paper empty	Replace a recording paper.
11	11	Paper jam	Remove the jammed recording paper.
12	12	Document jam	Remove the jammed document.
20	20	Power failure	Set the POWER switch from OFF to ON.
22	22	Memory error	
25	25	TPH overheat	Keep the POWER switch OFF until cooled down.
30	30	Reset button is depressed.	
31	31	No answer	Check the telephone number of call back message, and then call the other party by telephone.
33	33	Polling error	Ask the other party the password.
40	40	OMR error	Fill out OMR sheet correctly, and try again.
50	50	Auto dial error	Send the document again.
80	B0	Communication error in phase B	} Call the other party and ask the facsimile is OK, or not.
80	D0	Communication error in phase D	
81	B8	Feature unavailable (Preread error)	
81	B1	Feature unavailable (Terminal constants mismatch)	
82	B4	Training or phasing error	
83	C1	No high speed signal	
84	84	Carrier OFF during reception	
86	D2	Received picture error	
87	87	No memory left at remote terminal	

- Notes:**
- The error code is printed out only if it is set to do so.
 - To print service code on a communication journals, you should set "ERROR CODE" to "ON". Therefore, press **▶**, **4**, **3**, **1** and the ENTER (**↵**) button. (Refer to "SETTING THE FUNCTIONS", in page 19.)

MENU OPERATION FLOW CHART

MENU Button

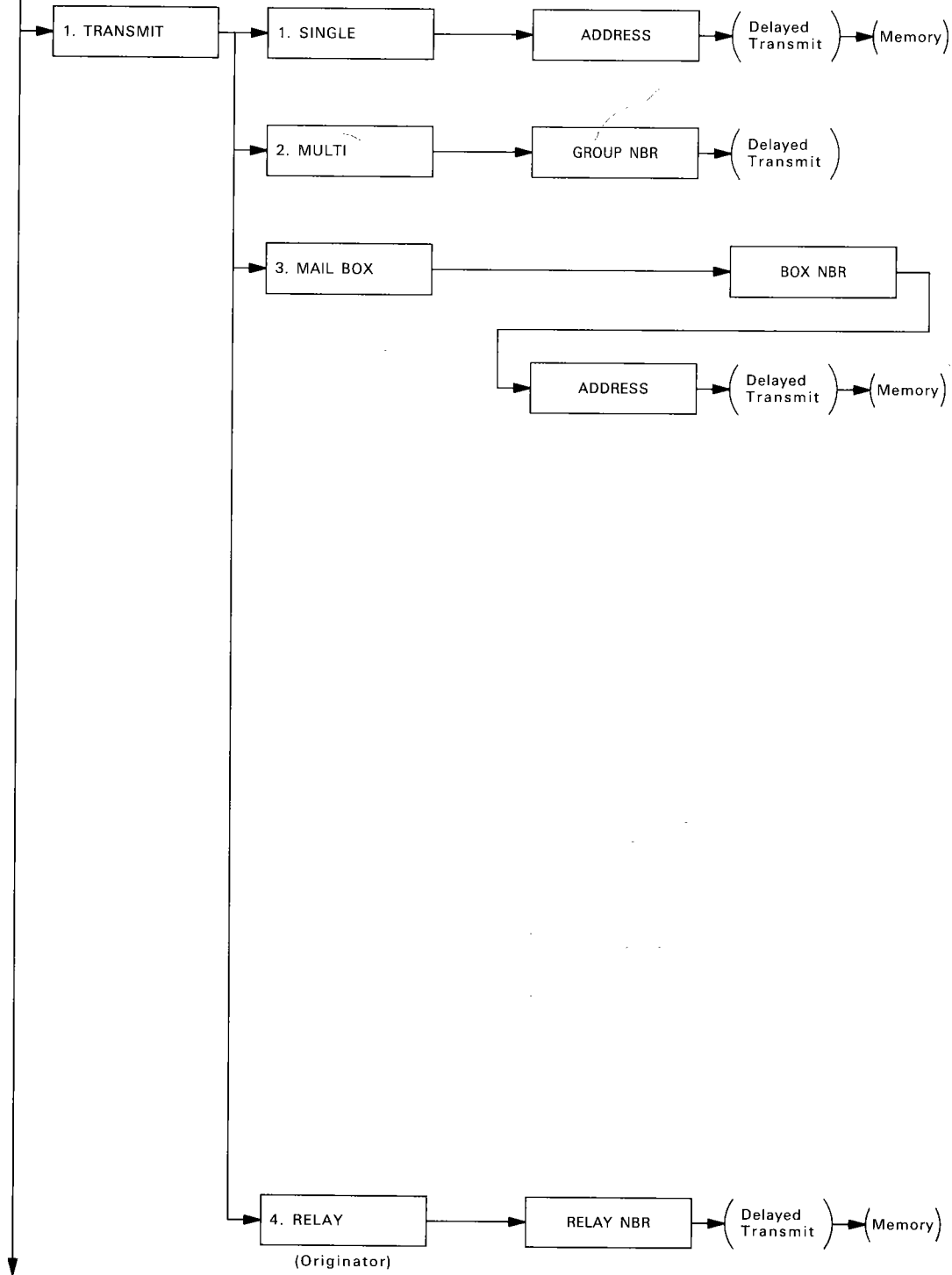

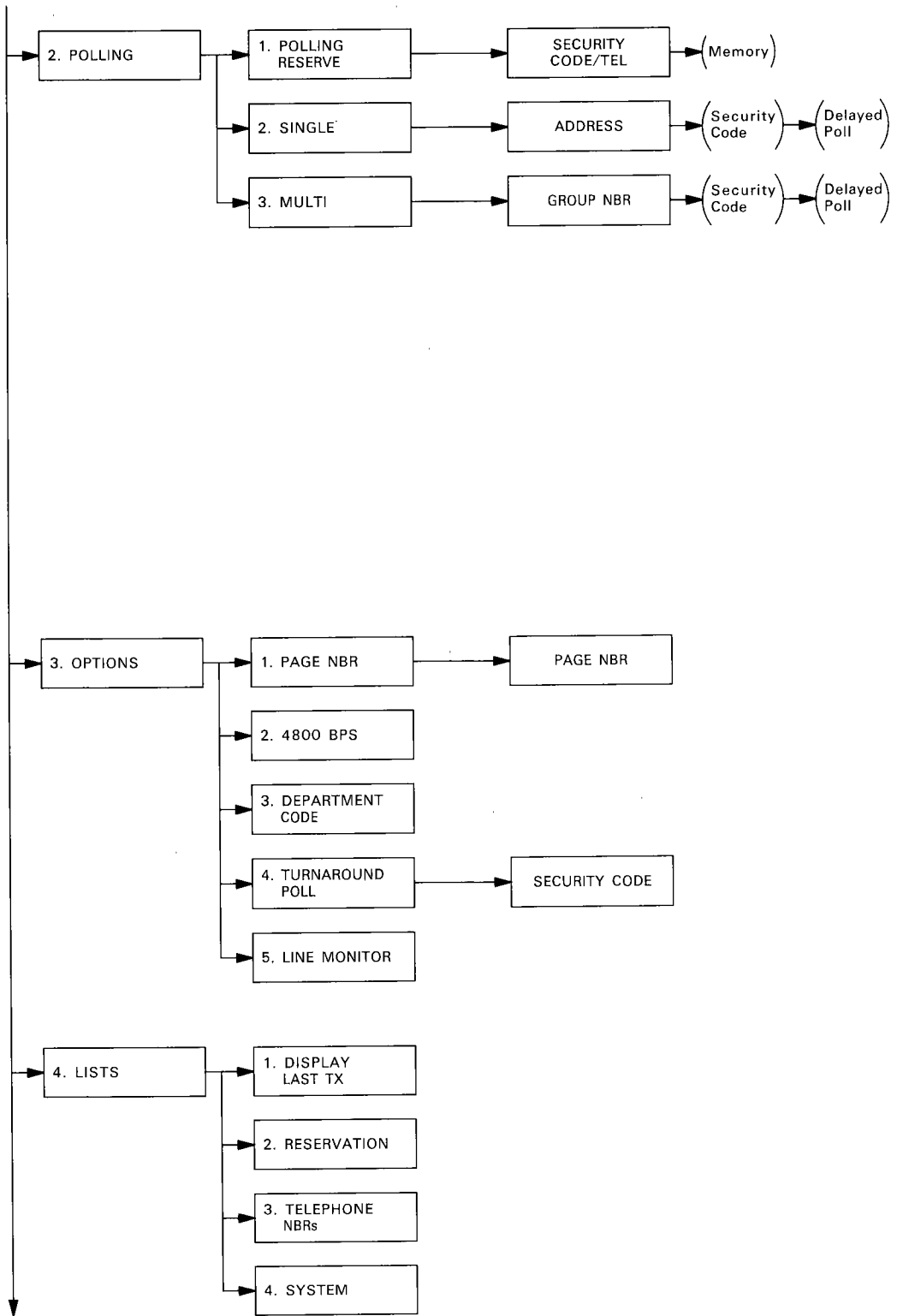

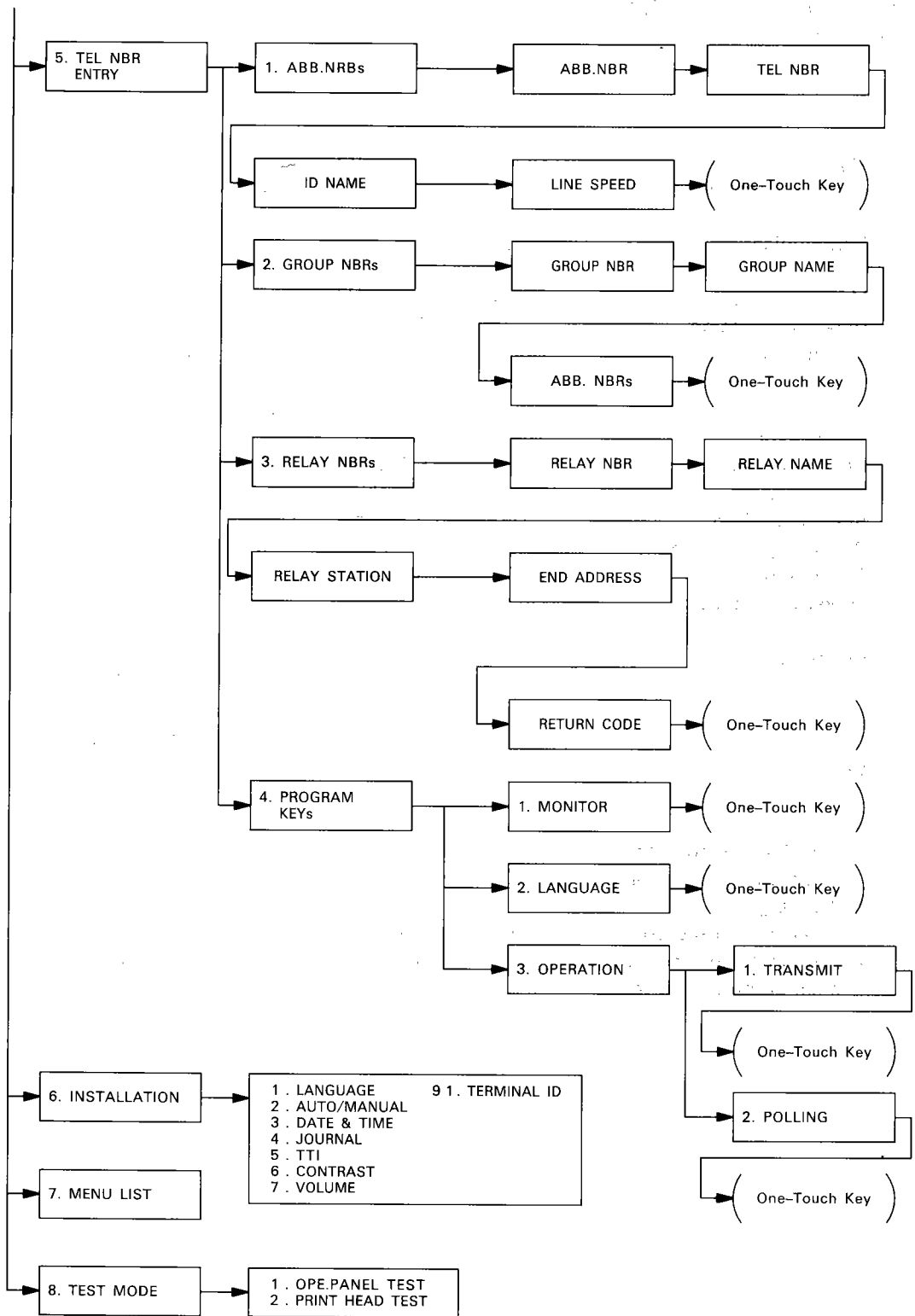

SPECIFICATIONS

Type	Desktop facsimile transceiver
Applicable circuits	PSTN (Public Switched Telephone Network) behind PABX, or 2-wire Private line
Communication modes	CCITT ECM, G3, or G2 HS, EX
Modem speed	9600, 7200, 4800, 2400 bps
Data compression	MH, MR, MMR
Scanning density	Horizontal: 8 dots/mm (203 pels/inch) Vertical: 15.4, 7.7 or 3.85 lines/mm (392, 196 or 98 lines/inch)
Printer type	Thermal sensitive
Document width	216 mm (8.5 inches) ~ 148 mm (5.8 inches)
Printing width	215 mm (8.5 inches) \pm 1 %
Scanning width	215 mm (8.5 inches) \pm 1 %
Recording paper size	210 mm \times 100 m (8.3 inches \times 328 feet)
Power supply	220-240 V AC, 50/60 Hz
Power consumption	Operating: 130 W Standby: 12 W
Dimensions	Width: 313 mm (12.3 inches) Depth: 393 mm (15.5 inches) Height: 135 mm (5.31 inches) (Excluding document and recording paper trays)
Weight	7.0 kg (15.4 lbs), without paper roll

- The clock function and memory data of the TF251 are backup by built-in battery. If the power switch is turned OFF for a long time, a week or more, memory data may be erased due to the battery being discharged.
- Usually keep the power switch ON or data in memory may be erased.
- After installing the machine, keep the power switch ON for 24 hours or more to allow the memory back up battery to reach full charge.

Free Manuals Download Website

<http://myh66.com>

<http://usermanuals.us>

<http://www.somanuals.com>

<http://www.4manuals.cc>

<http://www.manual-lib.com>

<http://www.404manual.com>

<http://www.luxmanual.com>

<http://aubethermostatmanual.com>

Golf course search by state

<http://golfingnear.com>

Email search by domain

<http://emailbydomain.com>

Auto manuals search

<http://auto.somanuals.com>

TV manuals search

<http://tv.somanuals.com>