

QUICK START

58/65L5400U (United States model)
58/65L5400UC (Canada model)

Unpack the box

1. Remove the components and TV from the box. Save the packing materials in case you need them later.
2. Remove the documentation for important information.

CAUTION The Resource Guide contains important safety precautions not included in this document. Please review completely prior to using this product. Complete instructions are contained in the User's Guide located on Toshiba's web site at:
For United States: support.toshiba.com
For Canada: www.toshiba.ca/support/ceg

Notice

- **Subject to Change.** Product specifications, configurations, prices, system/component/options availability are all subject to change without notice.

NOTE A High-Definition signal is needed to receive a High-Definition picture. Once you have a High-Definition signal you need to connect it to a High-Definition input on your TV. Not all channels are currently broadcasting in HD. Standard analog TV channels and HD channels, even on the same network, broadcast on different channels. (Example: ABC analog may be on channel 4, while ABC-HD may be on channel 104.)

Check the components

Your TV comes with:

- Remote control and batteries.
- Several documents, including the Resource Guide, and Standard Limited Warranty (L5400U only).
- Pedestal stand and hardware.
- All other cables and adapters are sold separately.
- If any items are missing or damaged, notify your dealer immediately.

- For the United States, the Standard Limited Warranty is located at support.toshiba.com/warranty.
- For Canada, the terms and conditions of the Limited One (1) Year Warranty on Parts and Labour can be found at www.toshiba.ca/support Click on Televisions, Select Warranty, then Select Standard Warranty & Service Plans and Select Flat Panel Television (bilingual).

Get detailed product information:

L5400U series: A comprehensive User's Guide for your model is available at support.toshiba.com, as well as up-to-date product information.
 L5400UC series: For up-to-date product information, visit www.toshiba.ca/support/ceg. For detailed product specifications, **Select Product**, then **select Model** and **select Model Number**.

Choosing a location for your LED TV

To display your TV on the included Pedestal Stand:

Observe the following safety precautions:

1. Read and follow the pedestal assembly instructions section in this document.
- CAUTION** Before beginning pedestal assembly, carefully lay the TV facedown on a flat, cushioned surface such as a quilt or blanket. Leave the bottom of the unit protruding over the edge of the surface and assemble the pedestal as indicated below.

- NOTE** Extreme care should always be used when attaching or removing the pedestal stand to avoid damage to the display panel.
2. Assemble the pedestal stand with the hardware provided.
 3. After assembling the pedestal, place the TV on a sturdy, level surface that can support the entire bottom surface of the stand and the weight of the unit.
 4. Be sure to secure the TV to a wall stud, pillar, surface, or other immovable structure.

CAUTION Always place the TV on a sturdy, level, stable surface that can support the entire bottom surface of the stand and the weight of the unit using the following method:

Secure the TV with a sturdy strap to a wall stud, pillar, or other immovable structure.

When connecting the strap:

- attach the strap to the TV using the hooks or clips on the back of the TV.
- make sure the strap is tight, secure, and parallel to the floor.

To display your TV using a Wall Bracket:

If you decide to wall mount your LED TV, always use a wall bracket Listed by an independent laboratory (such as UL, CSA, ETL) that is appropriate for the size and weight of the TV:

CAUTION Two people are required for installation.

1. Unplug and remove any cables and/or other component connectors from the rear of the TV.
2. Always use the screws supplied or recommended by the wall mount manufacturer.
3. Follow the instructions provided with your wall bracket. Before proceeding, make sure the appropriate bracket(s) are attached to the wall and the back of the TV as described in the instructions provided with the wall bracket.
4. After attaching the appropriate bracket(s) to the wall and the back of the TV, remove the pedestal stand from the TV, as described in this instruction document.

VESA Mounting Pattern

| TV Size | Hole Pattern (H x V) | Screw Size |
|---------|----------------------|------------|
| 58" | 400mm x 400mm | M6 |
| 65" | 400mm x 400mm | M6 |

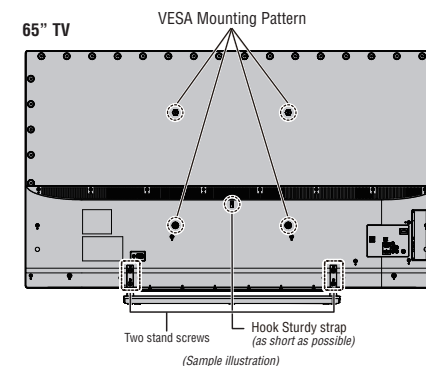
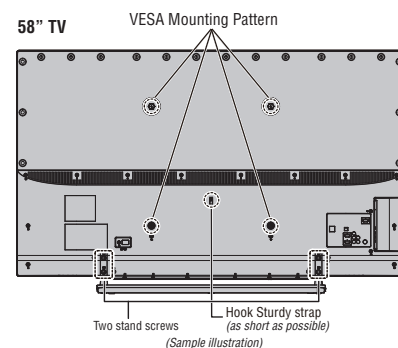

Pedestal Assembly Instructions

WARNING To prevent possible electric shock, protect the power cord from being pinched when attaching the pedestal stand.

NOTE Extreme care should always be used when attaching the pedestal stand to avoid damage to the LCD panel.
 For safety information, please review the User's Guide online:
 For United States: support.toshiba.com
 For Canada: www.toshiba.ca/support/ceg

CAUTION Before beginning pedestal assembly, carefully lay the front of the LCD Panel face down on a flat, cushioned surface such as a quilt or blanket. Leave the bottom of the unit protruding over the edge of the surface and assemble pedestal as indicated below.

CAUTION Two people are required for installation to avoid injury or damage to the TV.

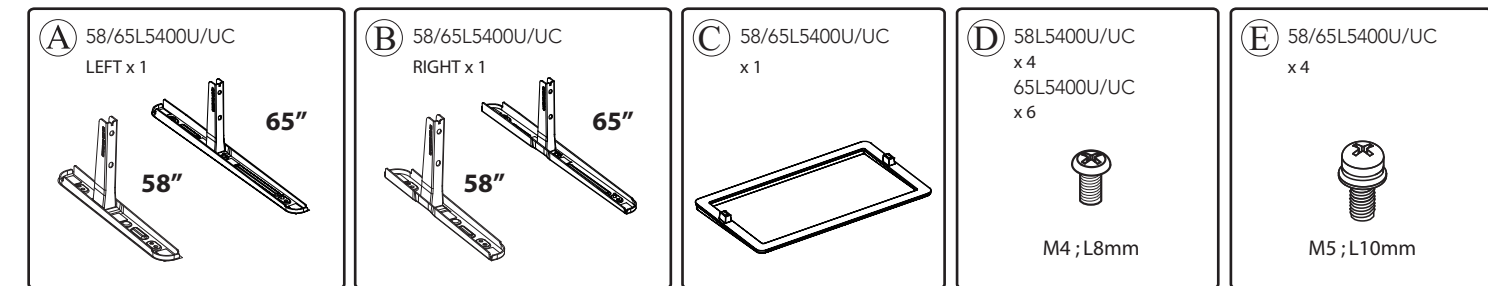

58/65L5400U/UC model

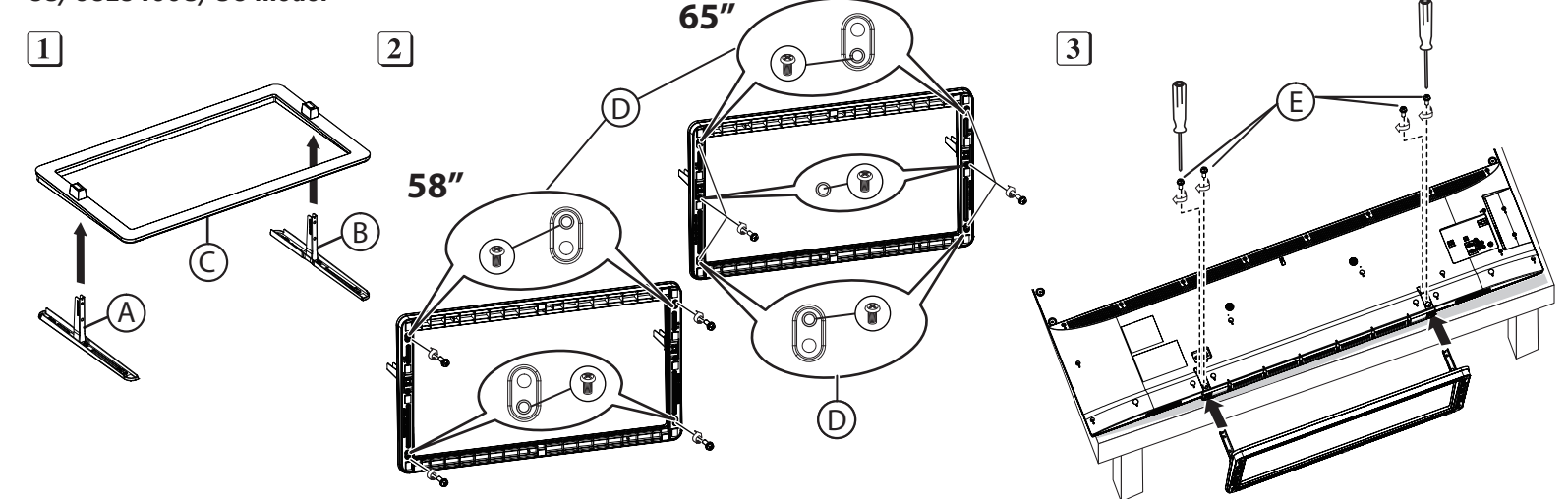

Register Your Toshiba Television

Enhance your ownership experience by taking a few minutes to register your Toshiba product at register.toshiba.com (for L5400U series) or support.toshiba.com/warranty/ (for L5400UC series). Completing product registration allows Toshiba to provide you with product information updates, special offers and promotions. Failure to complete product registration will not diminish your rights under the Standard Limited Warranty.



Please Do The Following Before Returning This Product To The Store.

If you are experiencing a technical problem or have questions regarding operation, authorized service centers, warranty or parts, please contact our Customer Support Center at:

For L5400U series (United States model):
(800) 631-3811 From Inside the United States
(949) 583-3050 From Outside the United States

For L5400UC series (Canada model):
1-800-268-3404 From within Canada

Many questions regarding parts, service, and warranties can be answered by visiting the Customer Support Section of our website:

L5400U series: support.toshiba.com
L5400UC series: www.toshiba.ca/support/ceg

THANK YOU

Receiving an HDTV Signal

There are three basic ways to receive an HDTV signal on your new TV:

- 1. Over-the-Air (Antenna)**
Connect a high quality outside antenna (not supplied) directly to the antenna input on the TV (reception cannot be guaranteed and is based on proximity to the local signal).
- 2. Cable or Phone Company HDTV Service**
Cable or phone company HDTV service customers will need to subscribe to High-Definition service from your local provider. (Additional monthly subscription cost may apply).
- 3. Satellite**
Satellite customers will need a High-Definition satellite receiver and appropriate dish hardware. (Additional monthly subscription cost may apply).

Connecting to a High-Definition Input on your TV

You can connect directly from an antenna, or if you are using an HD cable box or HD satellite box, there are three standard connections that can be used to receive an HD signal.

1. Antenna Input
To connect directly from an antenna or basic cable: connect the cable directly to the antenna input on the back of the TV.

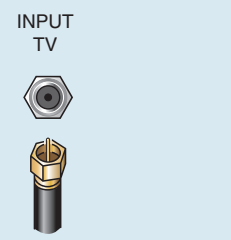

2. HDMI® to HDMI®
HDMI® is the best connection for HDTV. This is a digital connection that carries both digital video and digital audio.

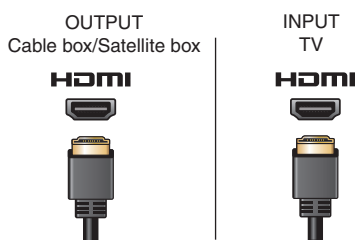

3. DVI to HDMI®
Your HD cable box or HD satellite receiver may have a DVI connection. This will be connected to the HDMI® jack on the TV using an HDMI® cable and an HDMI® to DVI converter. DVI carries digital video only.

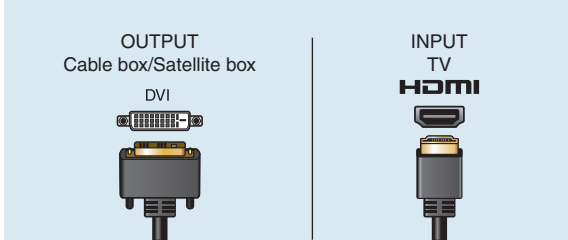

4. Component Video Input
ColorStream™ HD component may also be used to receive HDTV. Use if no HDMI® or DVI jack is available. There are three jacks color-coded with red-green-blue on the back of the TV and HD cable box or HD satellite receiver. This connection will require a separate analog audio connection (use the red and white audio connections).

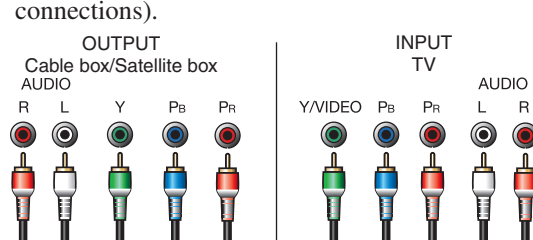

Initial Setup

You must select a **Language**, either **Home/Store** mode, before you can exit out of the Setup Menu. The **EXIT** button will not function until these selections have been made.

- 1. Menu Language**
Select a language.
- 2. Time Zone**
Select a time zone
Press **OK**.
- 3. Store / Home Mode**
Select Store or Home Mode.
Press **OK**.
- 4. ANT / CABLE in**
Select Antenna or Cable.
Press **OK**.

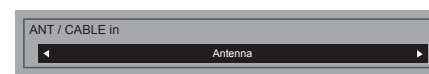
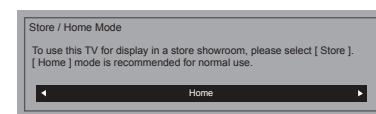

- 5. Start Scan**
Select **Start Scan**.
Press **OK**.

NOTE For Network Setup instructions, please refer to the User's Guide.

NOTE If you want to stop scanning, press **EXIT** while scanning.

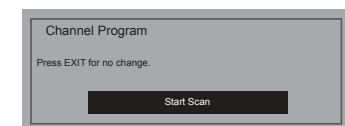

Navigating the menu system

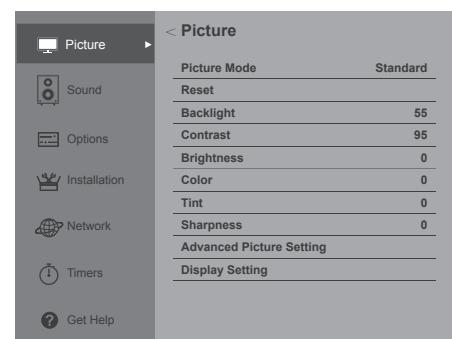

(Sample Image)

You can use the buttons on the remote control to access and navigate your TV's onscreen menu system.

- Press **MENU** to open the menu system.
- When a menu is opened, use the arrow buttons (▲▼◀▶) on the remote control, to move in the corresponding direction in the menu.
- Press **OK** to save your menu settings or select a highlighted item. (A highlighted menu item appears in a different color in the menu).
- All menus close automatically if you do not make a selection within 30 seconds.
- To close a menu instantly, press **EXIT**.

Quick Tour

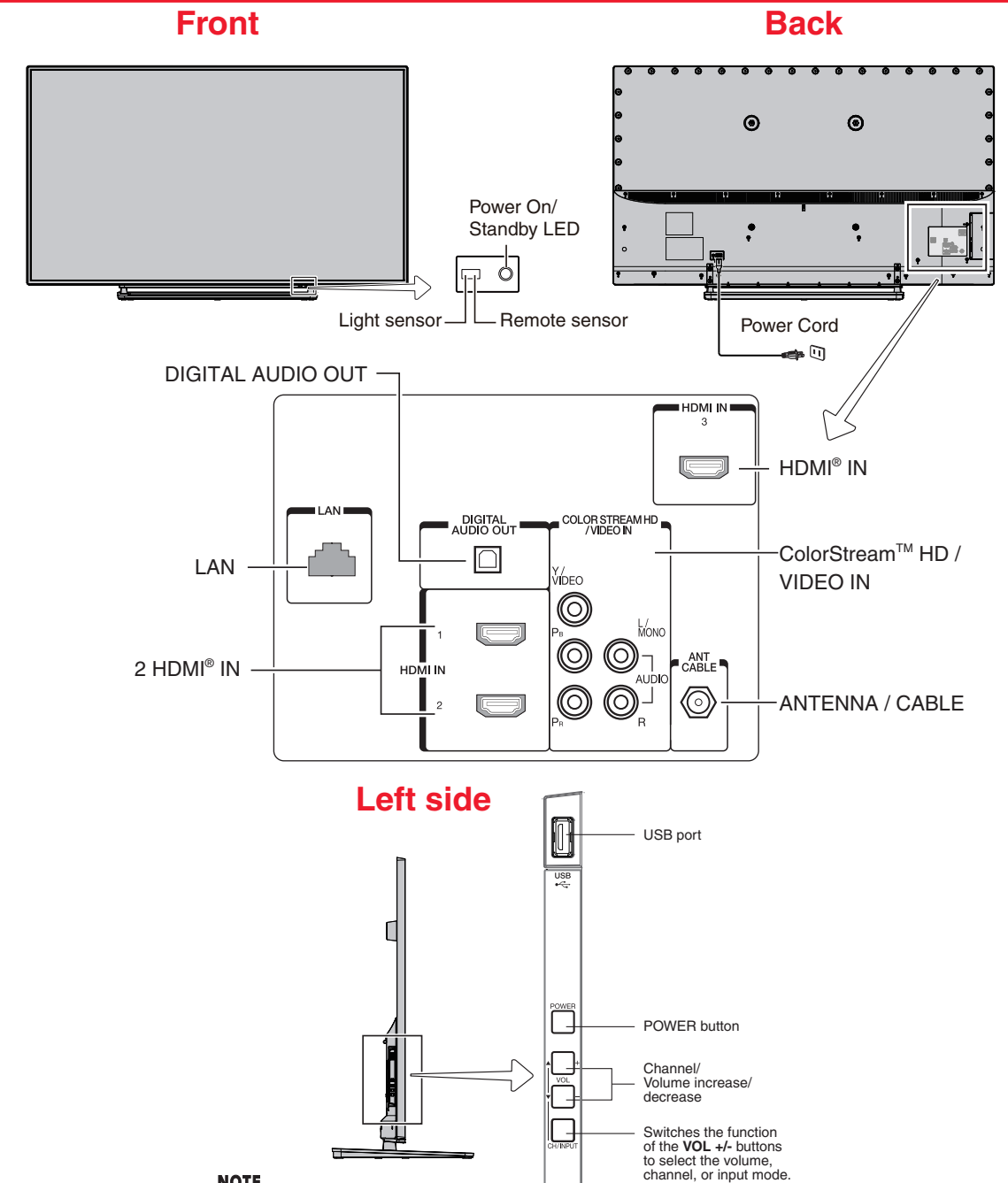

(Sample Illustration) L5400U/UC series

Need Help? Most problems are easy to correct. Save time with one of these simple solutions.

Consult the electronic User's Guide
L5400U series: To access the electronic User's Guide please visit support.toshiba.com
Type in your product model or serial number, press **GO**, and then click Manuals & Specs.
L5400UC series: To access the electronic User's Guide please visit www.toshiba.ca/support/ceg

Call Toshiba Customer Support Center
If you are experiencing a technical problem or have questions with regards to operation, authorized service centers, warranty or parts, Toshiba Customer Support Center is ready to help.
L5400U series: (800) 631-3811 From inside the United States
(949) 583-3050 From outside the United States
L5400UC series: 1-800-268-3404 From within Canada

Visit Toshiba's Support Web site
L5400U series: support.toshiba.com
L5400UC series: www.toshiba.ca/support/ceg

ColorStream is a trademark of Toshiba America Information Systems, Inc. The terms HDMI and HDMI High-Definition Multimedia Interface, and the HDMI Logo are trademarks or registered trademarks of HDMI Licensing LLC in the United States and other countries. All other brand and product names are trademarks or registered trademarks of their respective companies.

Printed on recycled paper

TOSHIBA
Leading Innovation >>>



© 2014 Toshiba America Information Systems, Inc. • GMA501289011 • 7/14

Free Manuals Download Website

<http://myh66.com>

<http://usermanuals.us>

<http://www.somanuals.com>

<http://www.4manuals.cc>

<http://www.manual-lib.com>

<http://www.404manual.com>

<http://www.luxmanual.com>

<http://aubethermostatmanual.com>

Golf course search by state

<http://golfingnear.com>

Email search by domain

<http://emailbydomain.com>

Auto manuals search

<http://auto.somanuals.com>

TV manuals search

<http://tv.somanuals.com>