

surveillix

NVS Network Video Recorder

User Manual

model no. NVSPRO8-2U-X
NVSPRO8-4U-X

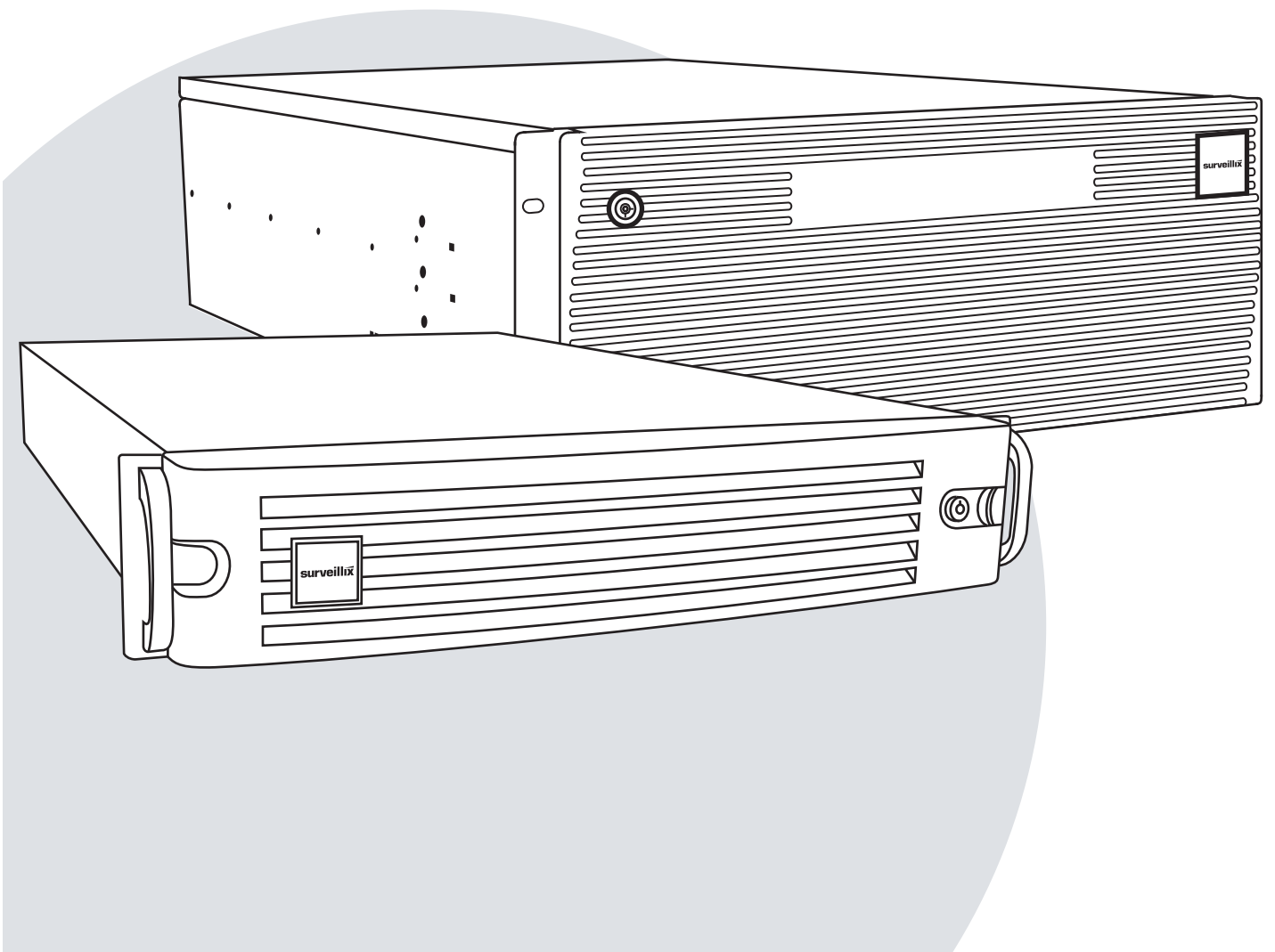

Please carefully read these instructions before using this product.
Save this manual for future use.

TOSHIBA

Surveillix™ NVS PRO
Operations Manual (G5 Hardware & Version 4.5 Software)

Manual Edition 31472AB – OCTOBER 2012

Printed in USA

No part of this documentation may be reproduced in any means, electronic or mechanical, for any purpose, except as expressed in the Software License Agreement. Toshiba America Information Systems (TAIS) shall not be liable for technical or editorial errors or omissions contained herein. The information in this document is subject to change without notice.

THE INFORMATION IN THIS PUBLICATION IS PROVIDED "AS IS" WITHOUT WARRANTY OF ANY KIND. THE ENTIRE RISK ARISING OUT OF THE USE OF THIS INFORMATION REMAINS WITH RECIPIENT. IN NO EVENT SHALL TOSHIBA BE LIABLE FOR ANY DIRECT, CONSEQUENTIAL, INCIDENTAL, SPECIAL, PUNITIVE, OR OTHER DAMAGES WHATSOEVER (INCLUDING WITHOUT LIMITATION, DAMAGES FOR LOSS OF BUSINESS PROFITS, BUSINESS INTERRUPTION OR LOSS OF BUSINESS INFORMATION), EVEN IF TIAS HAS BEEN ADVISED OF THE POSSIBILITY OF SUCH DAMAGES AND WHETHER IN AN ACTION OR CONTRACT OR TORT, INCLUDING NEGLIGENCE.

This software and documentation are copyrighted. All other rights, including ownership of the software, are reserved to DVR Support Center. TIAS and Surveillix are registered trademarks of TOSHIBA CORPORATION in the United States and elsewhere; Windows, and Windows 2000 are registered trademarks of Microsoft Corporation. All other brand and product names are trademarks or registered trademarks of the respective owners.

The following words and symbols mark special messages throughout this guide:

WARNING: Text set off in this manner indicates that failure to follow directions could result in bodily harm or loss of life.

CAUTION: Text set off in this manner indicates that failure to follow directions could result in damage to equipment or loss of information.

LIMITED WARRANTY

NETWORK VIDEO RECORDER

The Imaging Systems Division of Toshiba America Information Systems, Inc. ("ISD") makes the following limited warranties. These limited warranties extend to the Original End-User ("You[r]").

Limited Three (3) Year Warranty of Labor and Parts

The Imaging Systems Division of Toshiba America Information Systems warrants this product and parts against defects in material or workmanship for a period of three years from the date of original retail purchase by the end-user. During this period, ISD will repair or replace a defective product or part with a new or refurbished item. The user must deliver the entire product to the Surveillix DVR Repair Facility. The user is responsible for all transportation and insurance charges for the product to the DVR Repair Facility. ISD reserves the right to substitute Factory Refurbished Parts and / or Factory Refurbished Product in place of those in need of repair.

Step-by-step Procedures - How to Obtain Warranty Service

[1] Verify operation of the unit by checking the instruction manual and web site for the latest updates at

www.toshibasecurity.com

[2] If there is a defect in material or workmanship, contact the Surveillix DVR Support Center at (877) 855-1349 [877-855-1FIX] to speak to a technical support representative and schedule service.

[3] Arrange for delivery of the product to the Surveillix DVR Repair Facility. Products must be insured and securely packed, preferably in the original shipping carton. A letter explaining the defect and a copy of the bill of sale or other proof of purchase must be enclosed with a complete return street address and daytime telephone number. The Tracking Number should also be indicated on your documents. Charges for transportation and insurance must be prepaid by the end-user.

Critical Use Disclaimer

The product is not designed for any "critical applications." "Critical applications" means life support systems, exhaust or smoke extraction applications, medical applications, commercial aviation, mass transit applications, military applications, homeland security applications, nuclear facilities or systems or any other applications where product failure could lead to injury to persons or loss of life or catastrophic property damage. Accordingly, Toshiba disclaims any and all liability arising out of the use of the product in any critical applications.

Your Responsibilities

The above warranty is subject to the following conditions:

[1] You must retain the bill of sale or provide other proof of purchase.

[2] You must schedule service within thirty days after you discover a defective product or part.

[3] All warranty servicing of this product must be made by the Surveillix DVR Repair Facility.

[4] The warranty extends to defects in material or workmanship as limited above, and not to any products or parts that have been lost or discarded by user. The warranty does not cover damage caused by misuse, accident, improper installation, improper maintenance, or use in violation of instructions furnished by ISD. The warranty does not extend to units which have been altered or modified without authorization of ISD, or to damage to products or parts thereof which have had the serial number removed, altered defaced or rendered illegible.

ALL WARRANTIES IMPLIED BY STATE LAW, INCLUDING THE IMPLIED WARRANTIES OF MERCHANTABILITY AND FITNESS FOR A PARTICULAR PURPOSE, ARE EXPRESSLY LIMITED TO THE DURATION OF THE LIMITED WARRANTIES SET FORTH ABOVE. Some states do not allow limitations on how long an implied warranty lasts, so the above limitation may not apply. WITH THE EXCEPTION OF ANY WARRANTIES IMPLIED BY STATE LAW AS HEREBY LIMITED, THE FOREGOING EXPRESS WARRANTY IS EXCLUSIVE AND IN LIEU OF ALL OTHER WITH RESPECT TO THE REPAIR OR REPLACEMENT OF ANY PRODUCTS OR PARTS. IN NO EVENT SHALL ISD BE LIABLE FOR CONSEQUENTIAL OR INCIDENTAL DAMAGES. Some states do not allow the exclusion or limitation of incidental or consequential damages so the above limitation may not apply.

No person, agent, distributor, dealer, service station or company is authorized to change, modify or extend the terms of these warranties in any manner whatsoever. The time within which an action must be commenced to enforce any obligation of ISD arising under this warranty or under any statute, or law of the United States or any state thereof, is hereby limited to one year from the date you discover or should have discovered, the defect. This limitation does not apply to implied warranties arising under state law. Some states do not permit limitation of the time within which you may bring an action beyond the limits provided by state law so the above provision may not apply to user. This warranty gives the user specific legal rights, and user may also have other rights, which may vary from state to state.

TOSHIBA AMERICA INFORMATION SYSTEMS, INC.
Imaging Systems Division

Copyright © 2012 Toshiba America Information Systems, Inc. All rights reserved.

TOSHIBA
Leading Innovation >>>

IMPORTANT SAFEGUARDS

1. **Read Owner's Manual** – After unpacking this product, read the owner's manual carefully, and follow all the operating and other instruction
2. **Power Sources** – This product should be operated only from the type of power source indicated on the label. If you are not sure of the type of power supply to your home or business, consult your product dealer or local power company
3. **Ventilation** – Slots and openings in the cabinet are provided for ventilation and to ensure reliable operation of the product and to protect it from overheating, and these openings must not be blocked or covered. The product should not be placed in a built-in installation such as a bookcase or rack unless proper ventilation is provided or the manufacturer's instructions have been adhered to.
4. **Heat** – The product should be situated away from heat sources such as radiators, heat registers, stoves, or other products that produce heat.
5. **Water and Moisture** – Do not use this product near water.
6. **Cleaning** – Unplug this product from the wall outlet before cleaning.
7. **Power Cord Protection** – Power-supply cords should not be routed so that they are not likely to be walked on or pinched by items placed against them, paying particular attention to cords at plugs, convenience receptacles, and the point where they exit from the product.
8. **Overloading** – Do not overload wall outlets; extension cords, or integral convenience receptacles as this can result in a risk of fire or electrical shock.
9. **Lightning** – For added protection for this product during storm, or when it is left unattended and unused for long periods of time, unplug it from the wall outlet. This will prevent damage to the product due to lightning and power line surges.
10. **Object and Liquid Entry Points** – Never insert foreign objects into the NVR, other than the media types approved by Toshiba as they may touch dangerous voltage points or short-out parts that could result in a fire or electrical shock. Never spill liquid of any kind on the product.
11. **Accessories** – Do not place this product on an unstable cart, stand, tripod, bracket, or table. The product may fall, causing serious personal injury and serious damage to the product.
12. **Disc Tray** – Keep fingers clear of the disc tray as it is closing. Neglecting to do so may cause serious personal injury.
13. **Burden** – Do not place a heavy object on or step on the product. The object may fall, causing serious personal injury and serious damage to the product.
14. **Disc** – Do not use a cracked, deformed, or repaired disc. These discs are easily broken and may cause serious personal injury and product malfunction.
15. **LAN Port** - This equipment is for indoor use and all the communication wirings are limited to inside of the building.

IMPORTANT SAFEGUARDS, continued

16. **Damage Requiring Service** – Unplug the unit from the outlet and refer servicing to qualified service personnel under the following conditions:
 - a. When the power-supply cord or plug is damaged.
 - b. If liquid has been spilled, or objects have fallen into the unit.
 - c. If the unit has been exposed to rain or water.
 - d. If the unit does not operate normally by following the operating instructions. Adjust only those controls that are covered by the operating instructions as an improper adjustment of other controls may result in damage and will often require extensive work by a qualified technician to restore the unit to its normal operation.
 - e. If the unit has been dropped or the enclosure has been damaged.
 - f. When the unit exhibits a distinct change in performance - this indicates a need for service.
17. **Servicing** – Do not attempt to service this product yourself as opening or removing covers may expose you to dangerous voltage or other hazards. Refer all servicing to qualified personnel.
18. **Replacement Parts** – When replacement parts are required, be sure the service technician has used replacement parts specified by the manufacturer or have the same characteristics as the original part. Unauthorized substitutions may result in fire, electric shock or other hazards.
19. **Safety Check** – Upon completion of any service or repairs to this unit, ask the service technician to perform safety checks to determine that the unit is in proper operating condition.

BATTERY EXPLOSION CAUTION STATEMENT

CAUTION: Risk of Explosion if Battery is replaced by an Incorrect Type.
Dispose of Used Batteries According to the Instructions.

NOTES ON HANDLING

Please retain the original shipping carton and/or packing materials supplied with this product. To ensure the integrity of this product when shipping or moving, repackage the unit as it was originally received from the manufacturer.

Do not use volatile liquids, such as aerosol spray, near this product. Do not leave rubber or plastic objects in contact with this product for extended periods of time. Rubber or plastic objects left in contact with this product for extended periods of time will leave marks on the finish.

The top and rear panels of the unit may become warm after long periods of use. This is not a malfunction.

NOTES ON LOCATING

Place this unit on a level surface. Do not use it on a shaky or unstable surface such as a wobbling table or inclined stand.

If this unit is placed next to a TV, radio, or VCR, the playback picture may become poor and the sound may be distorted. If this happens, place the recorder away from the TV, radio, or VCR.

AVOID VOLATILE LIQUID

Do not use volatile liquids, such as an insect spray, near the unit. Do not leave rubber or plastic products touching the unit for a long time. They will leave marks on the finish. Do not use a chemically saturated cloth.

NOTES ON MAINTENANCE

To keep the recorder always operational we recommend regular inspection maintenance (cleaning parts or replacement). For details, contact the nearest dealer.

NOTES ON MOISTURE CONDENSATION

Moisture condensation damages the recorder. Read the following information carefully.

Moisture condensation occurs during the following cases:

When this product is brought directly from a cool location to a warm location.

When this product is moved to a hot and humid location from a cool location.

When this product is moved to a cool and humid location from a warm location.

When this product is used in a room where the temperature fluctuates.

When this product is used near an air-conditioning unit vent

When this product is used in a humid location.

Do not use the recorder when moisture condensation may occur.

If the recorder is used in such a situation, it may damage discs and internal parts. Remove any CD discs, connect the power cord of the recorder to the wall outlet, turn on the recorder, and leave it for two to three hours. After two to three hours, the recorder will warm up and evaporate any moisture. Keep the recorder connected to the wall and moisture will seldom occur.

WARNING

TO REDUCE THE RISK OF ELECTRICAL SHOCK, DO NOT EXPOSE THIS APPLIANCE TO RAIN OR MOISTURE.
DANGEROUS HIGH VOLTAGES ARE PRESENT INSIDE THE ENCLOSURE.
DO NOT OPEN THE CABINET.
REFER SERVICING TO QUALIFIED PERSONNEL ONLY.

CAUTION

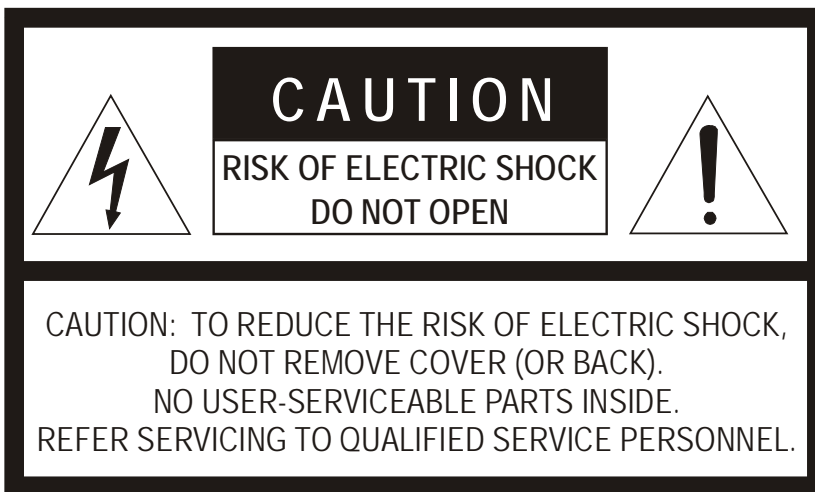

RACK MOUNT INSTRUCTIONS

Elevated Operating Ambient – If installed in a closed or multi-unit rack assembly, the operating ambient temperature of the rack environment may be greater than room ambient. Therefore, consideration should be given to installing the equipment in an environment compatible with the maximum ambient temperature (T_{ma}) specified by the manufacturer.

Reduced Air Flow – Installation of the equipment in a rack should be such that the amount of airflow required for safe operation of the equipment is not compromised.

Mechanical Loading – Mounting of the equipment in the rack should be such that a hazardous condition is not achieved due to uneven mechanical loading.

Circuit Overloading – Consideration should be given to the connection of the equipment to the supply circuit and the effect that overloading of the circuits might have on over current protection and supply wiring. Appropriate consideration of equipment nameplate ratings should be used when addressing this concern.

Grounding – Grounding of rack-mounted equipment should be maintained. Particular attention should be given to supply connections other than direct connections to the branch circuit (e.g. use of power strips).

FCC STATEMENT

INFORMATION TO THE USER: This equipment has been tested and found to comply with the limits for a Class B digital device, pursuant to Part 15 of the FCC Rules. These limits are designed to provide reasonable protection against harmful interference in a residential installation. This equipment generates, uses and can radiate radio frequency energy and, if not installed and used in accordance with the instructions, may cause harmful interference to radio communications. However, there is no guarantee that interference will not occur in a particular installation. If this equipment does cause harmful interference to radio or television reception, which can be determined by turning the equipment off and on, the user is encouraged to try to correct the interference by one or more of the following measures:

- Reorient or relocate the receiving antenna.
- Increase the separation between the equipment and receiver.
- Connect the equipment into an outlet on a circuit different from that to which the receiver is connected.
- Consult the dealer or an experienced radio/TV technician for help.

USERS OF THE PRODUCT ARE RESPONSIBLE FOR CHECKING AND COMPLYING WITH ALL FEDERAL, STATE, AND LOCAL LAWS AND STATUTES CONCERNING THE MONITORING AND RECORDING OF VIDEO AND AUDIO SIGNALS. TOSHIBA SHALL NOT BE HELD RESPONSIBLE FOR THE USE OF THIS PRODUCT IN VIOLATION OF CURRENT LAWS AND STATUTES.

Disclaimer

We disclaim any responsibility and shall be held harmless for any damages or losses incurred by the user in any of the following cases:

1. Fire, earthquake or any other act of God; acts by third parties; misuse by the user, whether intentional or accidental; use under extreme operating conditions.
2. Malfunction or non-function resulting in indirect, additional or consequential damages, including but not limited to loss of expected income and suspension of business activities.
3. Incorrect use not in compliance with instructions in this user's manual.
4. Malfunctions resulting from misconnection to other equipment.
5. Repairs or modifications made by the user or caused to be made by the user and carried out by an unauthorized third party.
6. Notwithstanding the foregoing, Toshiba's liabilities shall not, in any circumstances, exceed the purchase price of the product.

Usage Limitation

The product is not designed for any "critical applications." "Critical applications" means life support systems, exhaust or smoke extraction applications, medical applications, commercial aviation, mass transit applications, military applications, homeland security applications, nuclear facilities or systems or any other applications where product failure could lead to injury to persons or loss of life or catastrophic property damage.

Accordingly, Toshiba/TAIS disclaims any and all liability arising out of the use of the product in any critical applications.

Table of Contents

PREFACE	15
About this Guide	15
Technician Notes	15
INTRODUCTION	16
Product Description	16
Features.....	17
CONTROLS AND CONNECTIONS	18
Front Panel Controls.....	19
2U Front Panel	19
4U Front Panel	19
Rear Panel Connectors.....	20
2U Rear Panel.....	20
4U Rear Panel.....	20
GETTING STARTED	21
Identifying Included Components.....	22
Keyboard Setup.....	23
Mouse Setup.....	23
Monitor Setup	24
Power Setup	24
Hard Drive Array (2U Only).....	25
Removing a Hard Drive	25
Inserting a Hard Drive.....	25
Hard Drive Array (4U Only).....	25
Inserting a Hard Drive.....	25
Rackmount Kit Installation	26
Preparing for Setup	26
Separating the Section of the Rack Rails	26
Installing the Inner Rail Extensions.....	27
Installing the Outer Rack Rails	27
Installing the Recorder into a Rack.....	27
4U Front Bezel Installation.....	28
Turning On the NVR	28
Turning Off the NVR	28
NVR Basics	29
Setting the Time and Date	30
Accessing the DVR Utility	30
Exporting Settings	30
Importing NVR Settings.....	30
Changing Video Format.....	30
Display Screen.....	31
CPU Meter.....	31
Live Camera Options.....	31
Camera View	32
Recording Status Indicator	32
Special Recording	32

Edit Live View Channels	33
Screen Division Buttons.....	33
64 Channel Screen Division	34
Custom Live View Divisions.....	34
Setup Options.....	35
Setup Overview	36
Camera Setup.....	37
Network Video	38
Connecting a Network Device	38
Assigning a Network Device to a Channel.....	39
Assigning Audio Channels to a Network Device.....	40
Assigning Dual Streams	41
Camera Configuration	42
Upgrade and Registration.....	43
Motion Setup.....	45
Create a Motion Area	45
Regular Interval Recording.....	45
General Setup.....	46
Voice Warning	47
Connecting to a Wide Screen Display	47
Connecting a Second Monitor	47
Volume	47
Hybrid Sensor Setup	48
Auto Sequence Setting.....	49
Schedule Setup	50
Recording Schedule	50
Sensor Schedule	51
Scheduling Alarm Events	52
Emergency Agent Schedule	52
Special Day Schedule	52
System Restart Setup.....	53
Network Setup	54
Administrative Setup.....	55
Disk Management.....	55
Setting Up DDNS.....	56
User Management.....	57
Changing the Administrator Password	58
Log Management.....	59
Status Check / Email	60
Information.....	63
Instant Recording.....	63
Activate Instant Recording.....	63
Searching 'Instant Recorded' Video	63
Search.....	64
Search Overview	65
Play Controls	65
Adjust the Brightness of an Image.....	66
Zooming in on an Image.....	66
Zooming in on a Portion of an Image.....	66
Open Video from a Saved Location.....	66
Time Sync.....	66
Clean Image	66
Performing a Basic Search	67
Printing an Image.....	67
Daylight SAVIng Time.....	67

Save to JPG or AVI.....	68
Bookmarks.....	69
Clip Backup	70
Index Search.....	71
Performing an Index Search.....	71
Index Search Results Display.....	71
Preview Search.....	72
Performing a Preview Search.....	73
Graphic Search.....	73
Performing a Graphic Search	73
Object Search.....	74
Performing an Object Search	74
Motion Search.....	75
Performing a Motion Search.....	75
Audio Playback	75
Search in Live.....	76
Pan / Tilt / Zoom.....	77
Pan /Tilt / Zoom Overview.....	78
Enable the PTZ Settings.....	78
Advanced PTZ Setup.....	78
Creating and Viewing Preset Positions.....	79
Accessing PTZ Menus	79
Controlling a PTZ Camera	80
Using the Graphical PTZ Controller.....	80
Using the On-Screen Compass	80
Understanding Tours	81
PTZ Tour Schedule	81
backing up Video Data	82
Backup Overview	83
Nero® Express	83
General Screen Overview	84
Clip Screen Overview	85
Scheduled Screen Overview	86
lan / isdn / pstn connections	87
LAN Overview.....	88
Connecting to a LAN Using TCP/IP	88
Configuring TCP/IP Settings.....	88
LDAP Integration.....	89
Features.....	90
Installing Active Directory.....	90
Web Viewer	92
Web Viewer Overview.....	93
Configuring the Server for Remote Connection.....	94
Connecting to a Recorder Using Web Viewer	94
Closing the Web Viewer	94
Included Software Setup	95
The Surveillix App Overview	96
Emergency Agent Overview	96
Configuring the Recorder	96
Configuring the Client PC.....	97
Setup Window	97

Emergency Agent Window	98
Search Alarm Window	99
Remote Software Overview	100
Remote Software Setup	101
Digital Verifier Overview.....	103
Installing the Digital Verifier	103
Using the Digital Verifier	103
Backup Viewer Overview	104
Installing Backup Viewer	104
Loading Video from DVD or Hard Drive.....	104
Software Upgrades.....	105
SCS Overview	106
Purchasing SCS Software Upgrade	106
Configuring the Server for Remote Connection.....	106
Connecting to a Recorder.....	106

PREFACE

ABOUT THIS GUIDE

This manual is a setup and maintenance guide that can be used for reference when setting up the recorder and for troubleshooting when a problem occurs. Only authorized personnel should attempt to repair this unit.

Toshiba reserves the right to make changes to the recorders represented by this manual without notice.

The following text and symbols mark special messages throughout this guide:

Note Text set off in this manner indicates topics of interests that can help the user understand the product better.

Tip Text set off in this manner indicates topics and points of interests that can be helpful when using or settings up the recorder.

TECHNICIAN NOTES

Warning Only authorized technicians trained by Toshiba should attempt to repair this recorder. All troubleshooting and repair procedures that may be shown are for reference and minor repair only. Because of the complexity of the individual components and subassemblies, no one should attempt to make repairs at the component level or to make modifications to any printed wiring board. Improper repairs can create a safety hazard. And any indications of component replacement or printed wiring board modifications may void any warranty

Warning To reduce the risk of electrical shock or damage to the equipment:

- Do not disable the power grounding plug. The grounding plug is an important safety feature.
- Plug the power cord into a grounded (earthed) electrical outlet that is easily accessible at all times.
- Disconnect the power from the computer by unplugging the power cord either from the electrical outlet or the computer.

Caution To properly ventilate your system, you must provide at least 3 inches (7.6 cm) of clearance at the front and back of the recorder.

INTRODUCTION

PRODUCT DESCRIPTION

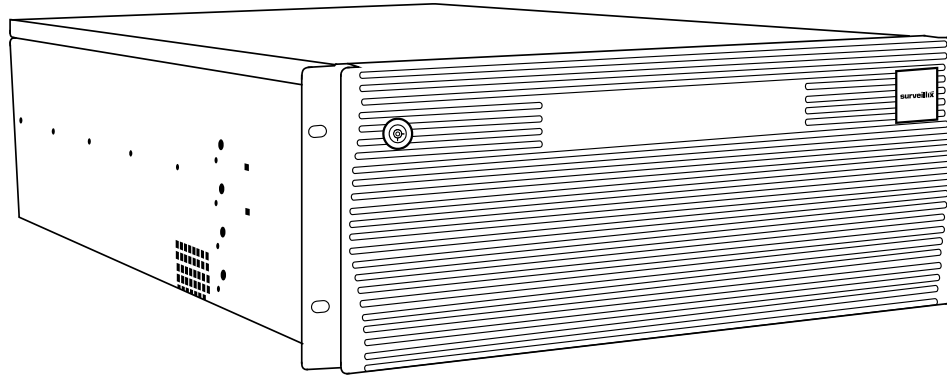

A Surveillix NVS Pro is a network video recorder, a server that performs as a High Definition Network Digital Recorder. By utilizing the many features of a computer, including processing power, storage capacity, graphics compression, and security features, the recorder is more powerful than the analog recorders of the past.

The Surveillix server software comes pre-configured for fast and seamless integration within your existing IT infrastructure. Designed around Microsoft® Windows 7 Embedded®, the server software offers unparalleled stability, security, and ease of use. Accordingly, your security investment has never been easier to maintain. Multiple users may simultaneously connect through any network connection for instantaneous live viewing, digital search, and off site video storage. Users can also connect remotely through DSL, Cable Modems, or ISDN. This powerful software enables users to establish recording schedules, create motion detection zones, use PTZ controls, and configure alarm inputs and outputs for each of the system's cameras. With the latest advancements in the IPS Server Software, searching and indexing your video archive has never been easier. Video can now be found, viewed, and exported in a number of file formats with just a few clicks.

The Surveillix network video recorder is high performance security product ready to meet today's security demands.

FEATURES

Surveillix recorders include the following new features:

- Optimized and designed for Microsoft® Windows 7 Embedded
- Supports up to 64 network cameras
- Remote system operation & configuration
- Supports multiple simultaneous remote connections
- PAN / TILT / ZOOM controls
- Simultaneous video search, playback and backup
- Video indexes for easy searching
- Multiple levels of security access
- Optional POS and ATM support
- High performance, durable, rackmount case
- Output the video to a NTSC/PAL display
- Up to 48TB internal storage
- Digital signature support
- Continuous, motion detection, alarm, pre-alarm, and scheduled recording modes
- Software Watchdog
- Camera dependant recording resolutions

CONTROLS AND CONNECTIONS

This chapter includes the following information:

- Input / Output Connector Locations
- Front Panel Controls and LEDs
- Rear Panel Connectors

FRONT PANEL CONTROLS

The front panel of the recorder contains the devices that will be commonly used for data removal, retrieval, and backup replacement. The most common components and buttons are shown below.

2U Front Panel

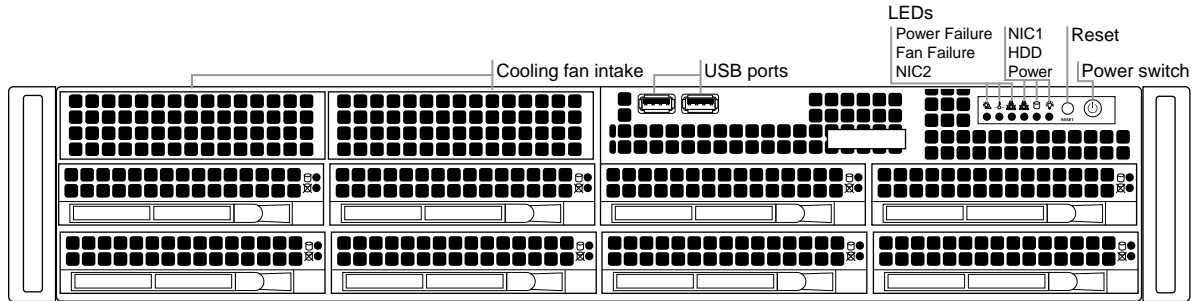

4U Front Panel

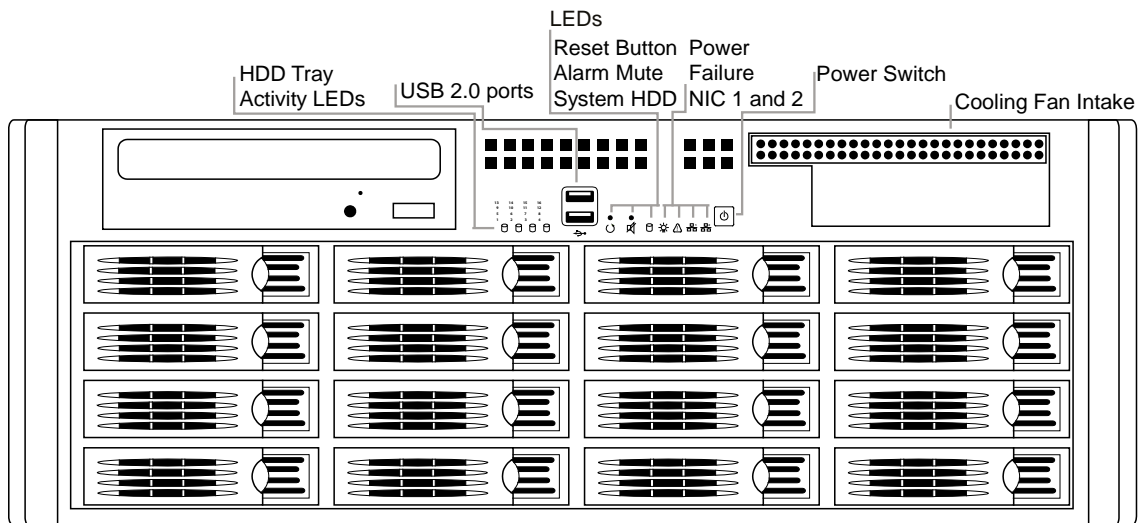

REAR PANEL CONNECTORS

The rear panel of the recorder contains the connectors used to attach cameras, sensors, and relays to the recorder. Below are diagrams that outline the location and description of each connector.

2U Rear Panel

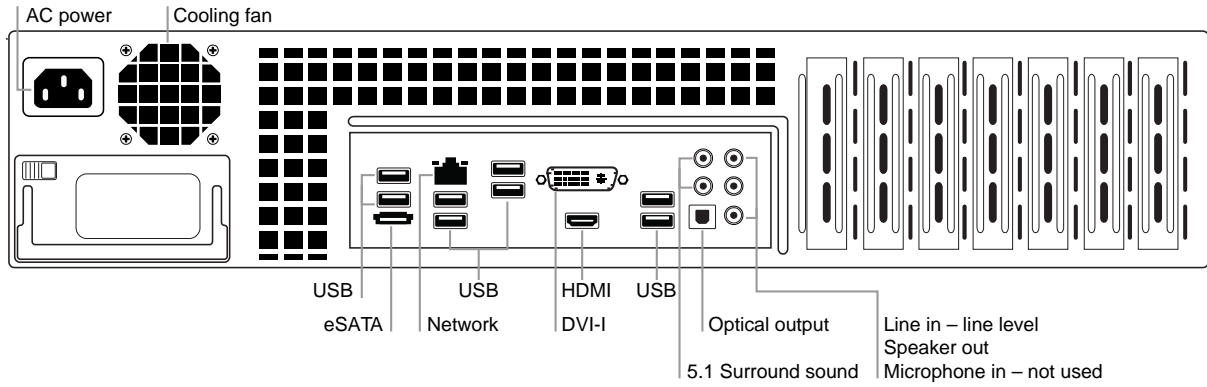

4U Rear Panel

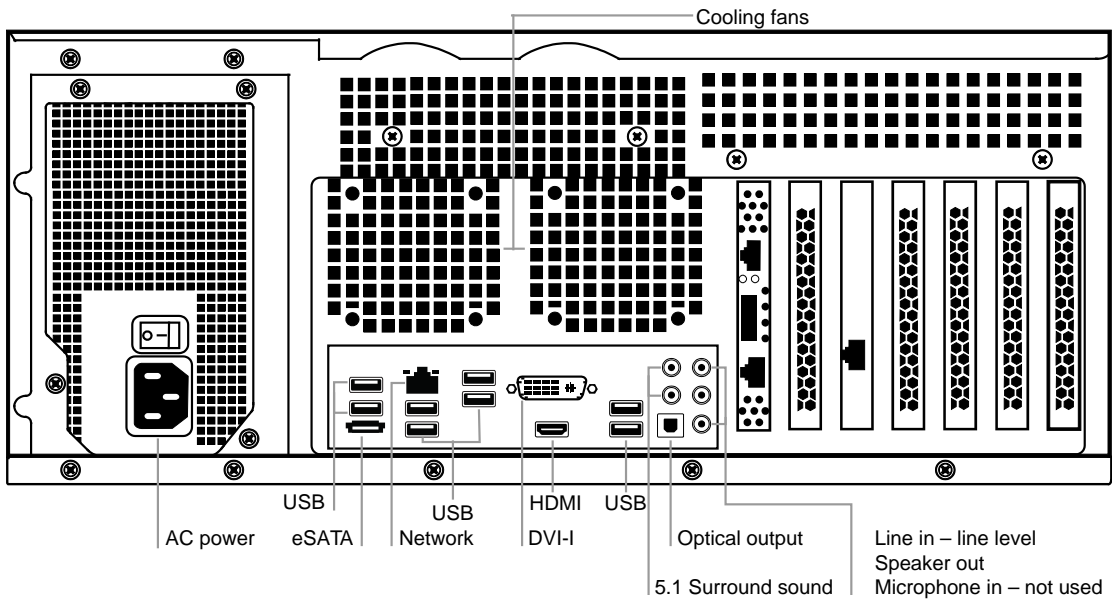







GETTING STARTED

This chapter includes the following information:

- Included Components
- Setting up the DVR Hardware
- Optional Components

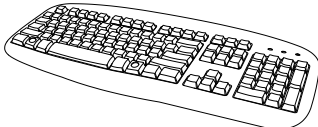
IDENTIFYING INCLUDED COMPONENTS

Surveillix recorders come with a mouse, keyboard and selected software and cables. Identify the following components to make sure everything has been properly included with the new recorder. If any of the following items are missing, contact the dealer to arrange a replacement.

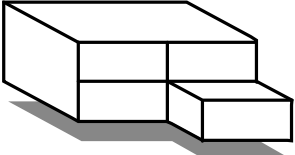
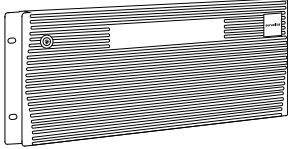
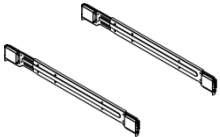
 <p>NVR Case Key (varies by model)</p>	 <p>Mouse</p>	 <p>Keyboard</p>
 <p>Repair Disc/ Software Disc</p>	 <p>Power Cable</p>	 <p>DVI to VGA Adapter</p>
 <p>HDD Drives (Shipped separately for 4U only)</p>	 <p>Bezel Cover (4U Only)</p>	 <p>Rackmount Rail Kit</p>

KEYBOARD SETUP

To attach the keyboard to the recorder, plug the end of the Keyboard into a USB port located on the back of the machine.

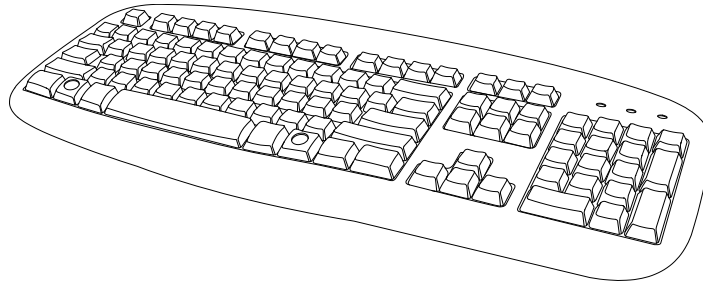

MOUSE SETUP

To attach the mouse to the recorder, plug the end of the mouse into a USB port located on the back of the machine.

The mouse uses a cursor called a pointer. Pointers come in many different shapes but are most commonly shaped like an arrow.

The mouse has two buttons: a left button and a right button. Quickly pressing and releasing one of these buttons is called clicking. Sometimes you will need to double-click – or click the same button twice quickly.

In this manual:

Click means to position the mouse cursor over an item and to single click the left button.

Right click means to position the mouse cursor over an item and to single click the right button.

Double-click means to position the mouse cursor over an item and to click the left button twice.

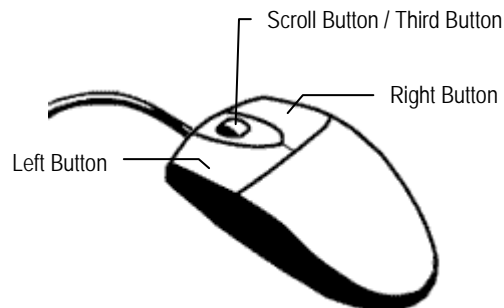

Select means to position the mouse cursor over a radio button, checkbox, or list item and click on it.

The scroll wheel in between the two buttons is used for added navigation functionality. By moving the wheel with index finger (scrolling), quickly move through multiple pages, lines, or windows. The wheel may also function as a third button allowing the user to quickly click or double-click an icon or a selected item



MONITOR SETUP

The recorder has the following connections available to attach a monitor.

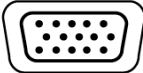
	HDMI Output	To TV / Digital Monitor
	DVI-I Output	To TV / Digital Monitor
	DVI to SVGA Adapter	Connect adapter to DVI output to connect an analog VGA Monitor.

Attach the monitor or monitors to the rear of the recorder using the cable supplied by the monitor manufacturer. Refer to the monitor manual for detailed information on how to setup and use it.

Note The monitor must be capable of having a screen resolution of 1024 x 768 and display colors of at least 32 Bit

POWER SETUP



WARNING:

To reduce the risk of electrical shock or damage to the equipment:

Do not disable the power grounding plug.
The grounding plug is an important safety feature.

If the electrical plug you are using does not have a ground plug receptacle contact a licensed electrician to have it replaced with a grounded electrical outlet.

Plug the power cord into a grounded (earthed) electrical outlet that is easily accessible at all times.

Disconnect the power from the computer by unplugging the power cord either from the electrical outlet or the computer.

HARD DRIVE ARRAY (2U ONLY)

Hard drives in the NVS Pro 8-2U are arranged top to bottom in the HDD cage. A minimum of one and a maximum of four hard drives may be installed in the hard drive cage. The hard drive installed in bay one contains the operating system and if removed will render the recorder inoperable.

Removing a Hard Drive

1. Push the release button for the drive to remove.
2. Pull the release handle outward, sliding the drive tray out of the drive cage.

Inserting a Hard Drive

1. Slide the drive tray into the drive cage.
2. Press the release handle until it clicks, locking the drive tray in place.

HARD DRIVE ARRAY (4U ONLY)

Hard drives in the 4U model are arranged top to bottom in the HDD cage. A minimum of one and a maximum of sixteen hard drives may be installed in the hard drive cage. The 4U is shipped with the hard drives in a separate box. To insert the drives, follow these instructions. The drives must be inserted in order, 1-16 (depending on how many drives you purchased). The drive trays are marked with the number of their port. See the diagram for the order of the hard drive ports on the 4U.

Inserting a Hard Drive

1. Pull the blue button on the drive tray to release the latch.
2. Slide the drive tray into the drive cage.
3. Close the latch until it clicks, locking the drive tray in place.

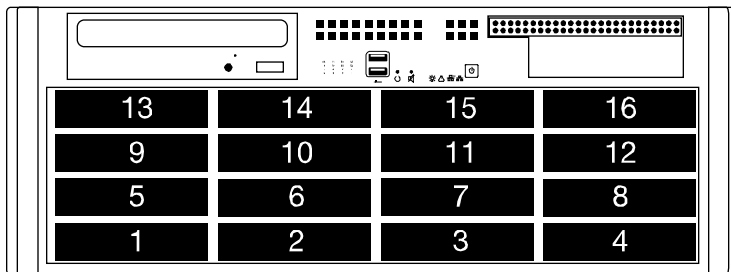

RACKMOUNT KIT INSTALLATION

This section provides information on installing the Surveillix 2U and 4U NVRs into a rack unit with the rack rails provided. There are a variety of rack units on the market which may mean the assembly procedure will differ slightly. You should refer to the installation instructions that came with the rack unit you are using.

Preparing for Setup

The box your Surveillix recorder was shipped in should include two sets of rail assemblies, two rail mounting brackets and the mounting screws you will need to install the system into the rack. Please read this section in its entirety before you begin the installation procedure outlined in the sections that follow.

Note These rails are designed to fit a rack between 26 and 33.5 inches deep.

Separating the Section of the Rack Rails

The package includes two rail assemblies in the rack mounting kit. Each assembly consists of two sections: an inner fixed chassis rail that secures directly to the server chassis and an outer fixed rack rail that secures directly to the rack itself.

1. Locate the rail assembly in the packaging.
2. Extend the rail assembly by pulling it outward.
3. Press the quick-release tab.
4. Separate the inner rail extension from the outer rail assembly.
5. Repeat steps for the second rail assembly.

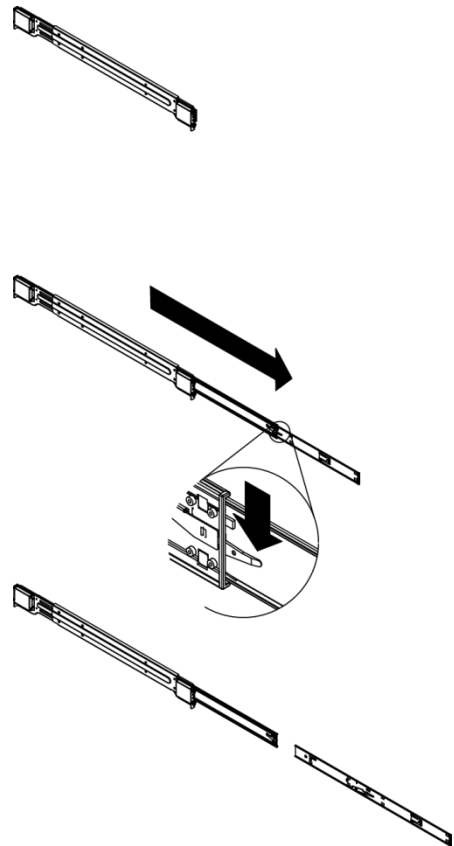

Installing the Inner Rail Extensions

Each rackmount kit includes a set of inner rails in two sections: inner rails and inner rail extensions. The inner rails are pre-attached to the chassis, and do not interfere with normal use of the chassis if you decide not to use a server rack. The inner rail extension is attached to the inner rail to mount the chassis in the rack.

1. Place the inner rail extensions on the side of the chassis aligning the hooks of the chassis with the rail extension holes. Make sure the extension faces "outward" just like the pre-attached inner rail.
2. Slide the extension toward the front of the chassis.
3. Optional: Secure the chassis with 2 screws as illustrated. (4 screws are provided on 4U models.)
4. Repeat steps for the other inner rail extension.

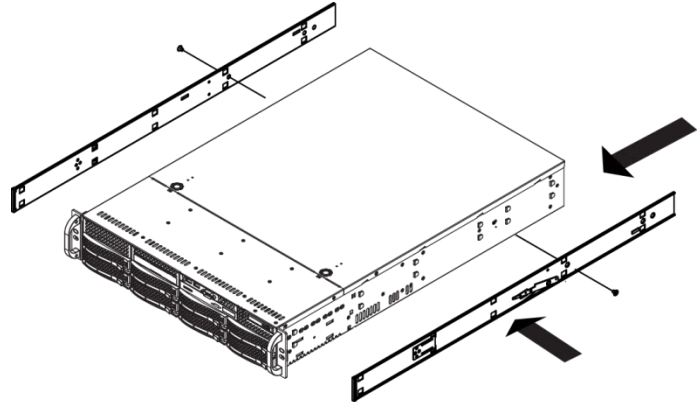

Installing the Outer Rack Rails

Outer rails attach to the rack and hold the chassis in place. The outer rails will extend between 30 inches and 33 inches.

1. Secure the back end of the outer rail to the rack, using the leaf springs and screws provided.
2. Press the button where the two outer rails are joined to retract the smaller outer rail.
3. Hang the hooks of the rails onto the rack holes and if desired, use screws to secure the front of the outer rail onto the rack.
4. Repeat steps for the other outer rail extension.

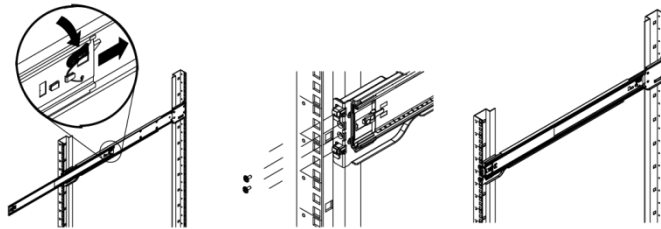

Installing the Recorder into a Rack

1. Extend the outer rails.
2. Align the inner rails with the outer rails on the rack.
3. Slide the inner rails into the outer rails, keeping pressure even on both sides. When pushed all the way into the rack, the rails will click into a locked position (preventing removal without pressing the quick-release tabs).

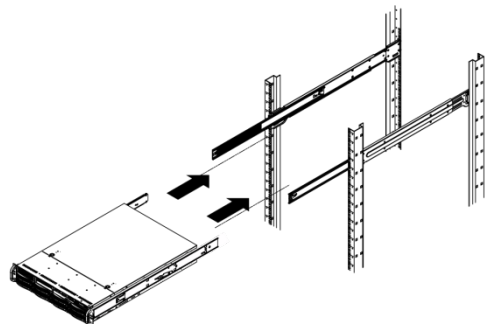

4U FRONT BEZEL INSTALLATION

The 4U is shipped with handles attached to the front of the unit. If you choose to mount the front bezel to your recorder, you will need to remove the handles and attach the bezel before attaching the rackmount rails.

1. Remove the two screws from each handle.
2. Install the include bezel clips and fasten with screws.
3. Align and slide the right side of the bezel into the right clip.
4. Slide the left side of the bezel into the left clip.
5. Lock the bezel by turning the key counterclockwise.

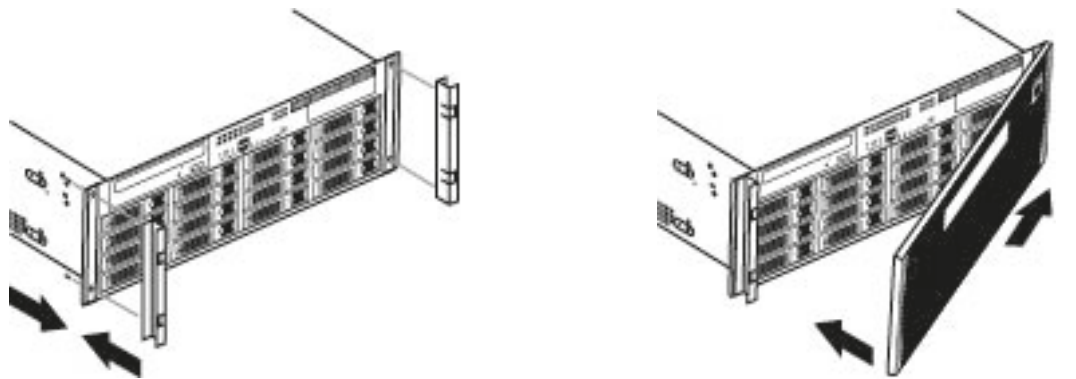

TURNING ON THE NVR

1. Turn on the monitor and any external peripherals (ex. Printers, External Storage Devices, etc.) connected to the recorder.
2. Turn on the Secondary Power Switch located in the rear of the recorder.
3. Press the Power Switch located on the front of the recorder.
4. The recorder will run a series of self-tests. After two or three minutes, a series of messages may be displayed as the various hardware and software subsystems are activated. Under normal circumstances, users should not be asked to respond to these messages. If asked to respond to the messages (adding a Printer, Monitor, etc for the first time) follow the instructions carefully.
5. Startup is complete when the Surveillix NVR software is finished loading and displays the main menu screen.

TURNING OFF THE NVR

1. Click **Exit** on the main menu screen of the NVR software.
2. Select **Power Off** from the list and click OK. The recorder may take several minutes to shut down completely.

Caution Always be sure to follow the proper procedures when turning off the power to the recorder. NEVER disconnect the power to the recorder while it is still running or in the process of shutting down. Doing so can cause data loss, file corruption, system instability and hardware failure.

NVR BASICS

This chapter includes the following information:

- Becoming familiar with the Display screen
- Defining Screen Divisions

SETTING THE TIME AND DATE

1. Exit to Windows by clicking **Exit** on the Display screen and then clicking **Restart in Windows Mode**.
2. Click the **Start** button  > **Control Panel**.
3. Click **Date and Time** inside **Control Panel**.
4. Adjust the Date and Time.
5. When finished, click **Apply**, then **OK**, then close all open windows and restart the recorder. Do this by clicking **Start** and selecting **Restart** from the **Shut Down** menu.

ACCESSING THE DVR UTILITY

Exporting Settings

Exporting settings can help configure multiple recorders quickly or reconfigure a unit that has been reset to factory defaults. Some things must be kept in mind when using this feature.

You cannot use this function on:

- Recorders that are different models.
- When upgrading from certain software versions. (This feature cannot be used when upgrading from v2.x to v3.x)

1. Exit to Windows by clicking **Exit** on the Display screen then and select **Restart in Windows Mode**.
2. Click the **Start** button  > **All Programs > Surveillix > vFormat**.
3. Click **Export** in the **System Setting tool** section.
4. Select a location to save the settings file and click **Save**. The **DVR Utility** will export the NVR settings and automatically close.

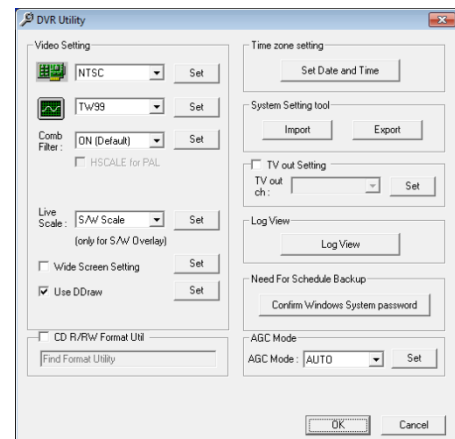

Importing NVR Settings

1. Exit to Windows by clicking **Exit** on the Display screen then and select **Restart in Windows Mode**. (See the Display screen section later in this chapter)
2. Click the **Start** button  > **All Programs > Surveillix > vFormat**.
3. Click **Import** in the **System Setting Tool** section.
4. Select the location of the settings file to import and click **Open**.
5. Click **Yes** to import the data file.

Changing Video Format

1. Exit to Windows by clicking **Exit** on the Display screen then and select **Restart in Windows Mode**. (See the Display screen section later in this chapter)
2. Click the **Start** button  > **All Programs > Surveillix > vFormat**.
3. Select the appropriate video setting from the list in the **Video Setting** section—NTSC or PAL.
4. Click **Set**.

DISPLAY SCREEN

Each time the recorder starts, the program defaults to the Display screen. The following diagram outlines the buttons and features used on the Display screen. You should become familiar with these options as this is the screen that will be displayed the majority of the time.

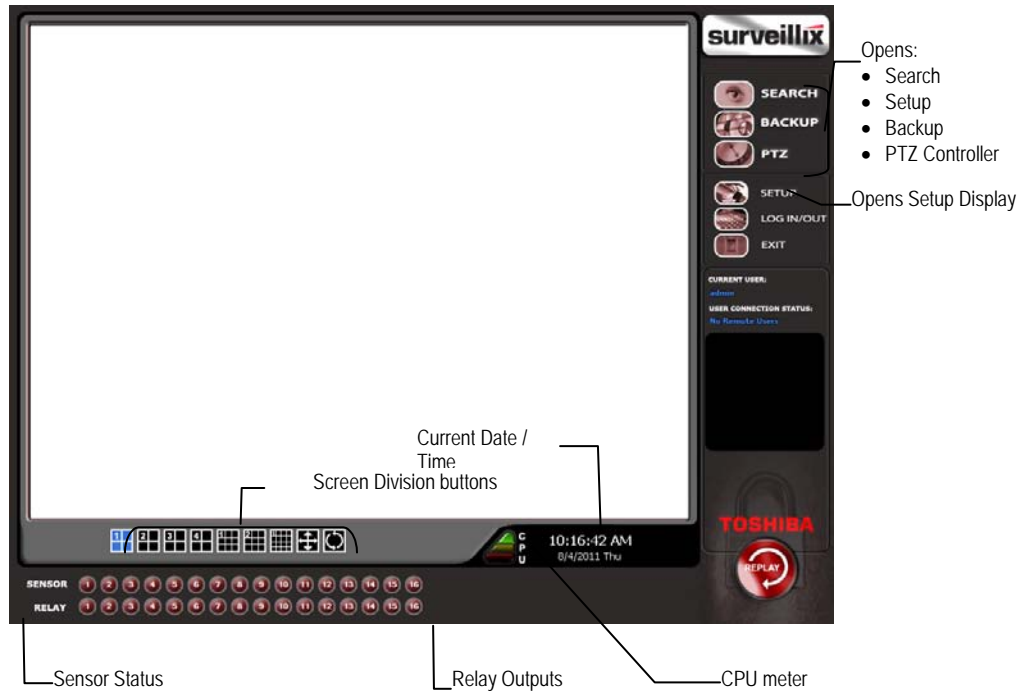

CPU Meter

Use the CPU meter to monitor the system resources on your recorder.

- GREEN - System configuration OK
- YELLOW - Caution; evaluate system configuration and consider decreasing system loading
- RED - System configuration has been exceeded which may affect stability; decrease system loading or upgrade system with CPU performance package

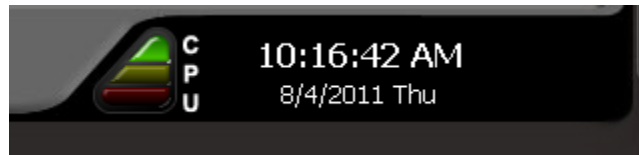

Live Camera Options

Right-click a camera on the Display screen to display these options:

- Full Screen
- Instant Recording
- Search In Live

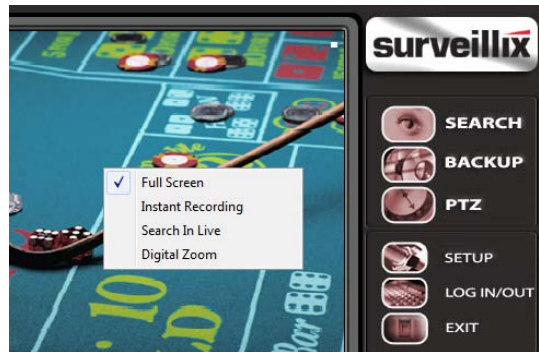

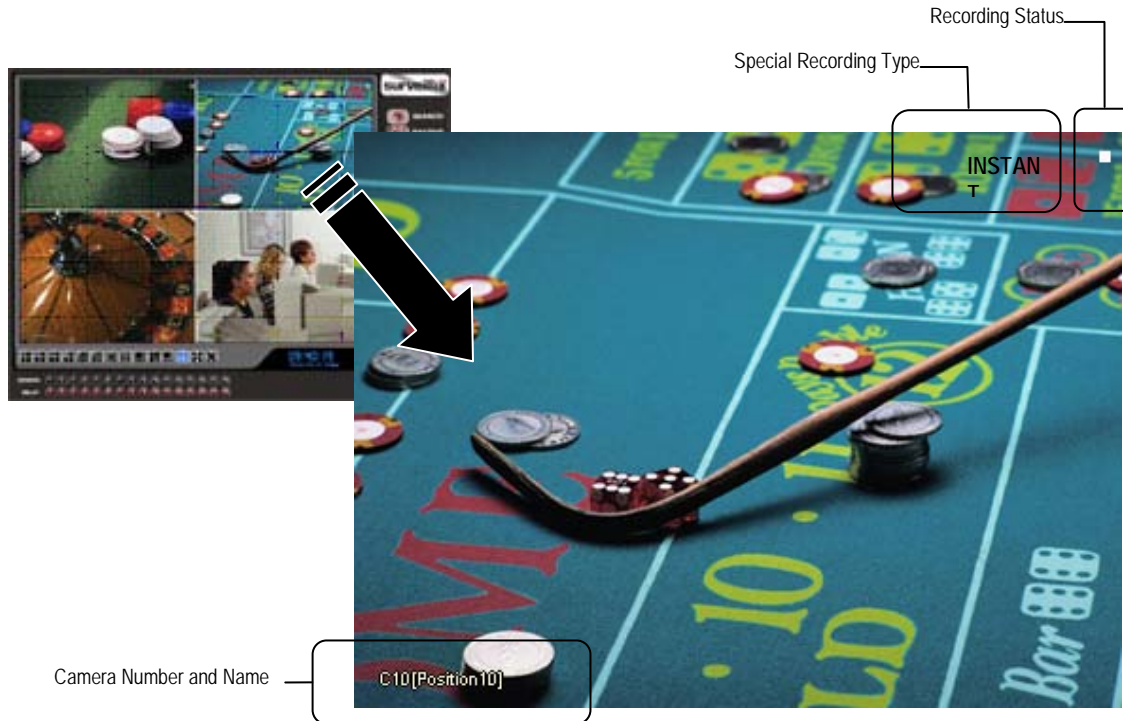

CAMERA VIEW



Recording Status Indicator

The camera status for each camera is displayed in the upper right corner on the Video Display Area. The following are the different states for each camera:

	Recording	Displayed when the camera is currently being recorded to the recorder.
	Motion Detection	Displayed when a camera (set up for motion detection) detects motion.
	Display	Displayed when the camera is currently not being recorded to the recorder.

Special Recording

There are two types of Special Recording. Text is displayed on the camera indicating what type of Special Recording is activated.

SENSOR

Sensor is displayed when a sensor, associated with a given camera, is activated.

INSTANT

Instant Recording is a manual activation of the recording for the selected camera. Regardless of the recording method, Instant Recording will start the camera recording and also flag the video for future searches using the Index Search feature. INSTANT is displayed when a user activates the instant recording option. Double right-click the video display to activate and deactivate the Instant Recording option.

EDIT LIVE VIEW CHANNELS

By default, the recorder only allows live video from four network channels at one time on the local server. This protects the processor resources for recording data. The SCS software allows you to view live video from multiple recorders at once and with the same limitations that the recorder has on the number of live IP based video channels. If more than four channels of live video are required on the local server, you can enable the recorder to show up to 16 channels. Be aware that displaying 16 channels of live IP based video is resource intensive and may dramatically impact system performance.

To enable the recorder to view 16 channels of live video:

1. Click **Exit** on the display screen and select **Restart in Windows Mode**.
2. Double-click the **Edit Live View Channels** icon on the desktop.
3. If you wish to continue, confirm the two warning windows.

The live view display will switch to 16 channel mode. To return the recorder to 4 channel mode, run the utility again using the same instructions.

SCREEN DIVISION BUTTONS

Note When viewing live video from Network Cameras, only 4CH will display at one time. If more live view channels are required on the local server, see the Edit Live View Channels instructions.



1st Four Cameras View – Displays cameras 1-4 in the Video Display Area. To return to a different Multi-Camera View, select a different Screen Division option from the Screen Division menu.



2nd Four Cameras View – Displays cameras 5-8 in the Video Display Area. To return to a different Multi-Camera View, select a different Screen Division option from the Screen Division menu.



3rd Four Cameras View – Displays cameras 9-12 in the Video Display Area. To return to a different Multi-Camera View, select a different Screen Division option from the Screen Division menu.



4th Four Cameras View – Displays cameras 13-16 in the Video Display Area. To return to a different Multi-Camera View, select a different Screen Division option from the Screen Division menu.



Full Screen – The Full Screen Option allows you to view the Video Display Area using the entire viewable area on the monitor. When this is selected, no menu options are visible. You can activate the Full Screen Option by clicking on the Full Screen button within the Screen Division menu. You can deactivate Full Screen mode by right clicking on the screen.



Auto Sequence – Sequences through the Screen Divisions sets. For example, selecting the 1A and then the Loop button will sequence through 1A, 2A, 3A, 4A and then repeat.

64 Channel Screen Division

To access channels 17-32, 33-48, and 49-64 on a 64-channel NVS,

Mouse over the channel section indicator next to the screen division buttons. The channel section will display as 16X 1, 16X 2, and 16X 4 to indicate the channel section you are currently viewing.



Click the desired channel section.



Custom Live View Divisions

Customize your Live View screen by changing the order of the cameras. Each screen division can be individually customized but a camera can only be displayed once in each group view.

Create custom live view divisions:

1. On the Display screen click **Setup**, and then click **General**.
2. Click **Sequence Setting**.
3. Drag and drop cameras from the Channel List to the desired location within the Division Group.

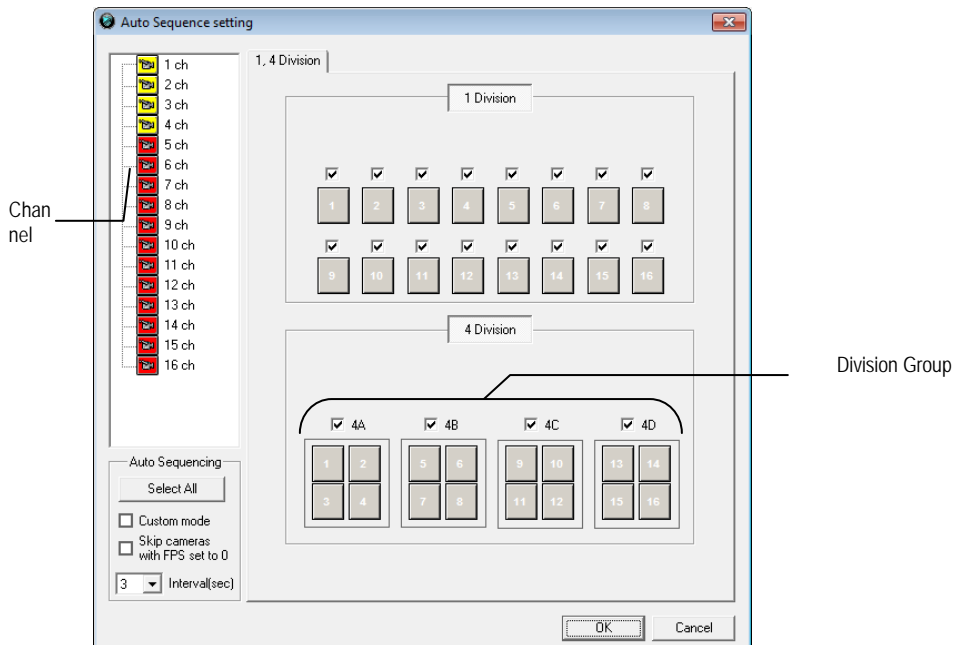

SETUP OPTIONS

This chapter includes the following information:

- Setup Overview
- Camera Setup
- Network Video
- Motion
- Schedule
- Network
- Administrative
- Information
- PTZ

SETUP OVERVIEW

The Setup options allow you to optimize your recorder by adjusting things like camera names, restart schedules, recording schedules and more. It is extremely important that you setup your recorder correctly for several reasons.

- **Recording Schedules** – Increase the amount of pertinent recorded video that is saved on the recorder by optimizing the recording schedule. Optimize the type of recording done by adding motion detection to this as well, again increasing the amount of useful video.
- **Camera Naming** – Name each camera so the location can be easily identified and include any other pertinent information that may be helpful when viewing it on the Video Display Area.
- **Configure Network Cameras** – Connect to and configure cameras that are available on the network the NVR is connected to.



CAMERA SETUP

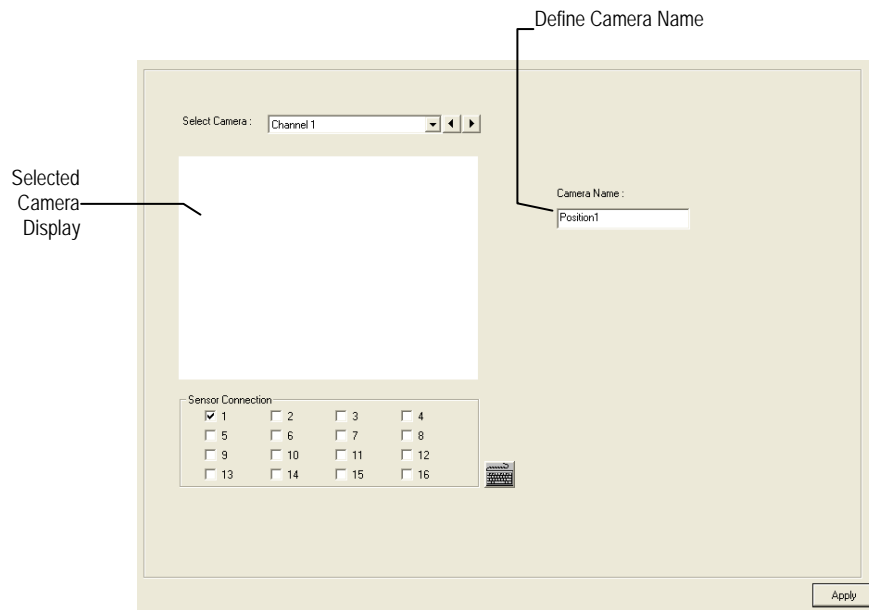

- **Select Camera** – Selects the camera to be edited.
- **Selected Camera Display** – Displays the live camera feed from the camera selected.
- **Sensor Connection** – Specify which sensors are currently in use
- **Camera Name** – Specify a name for each camera.

NETWORK VIDEO

Connecting a Network Device

The screenshot displays a web-based configuration interface for network video. At the top, there is a navigation bar with tabs: License, Add/Remove Device, Channel Setup, Audio Setup, and Camera Configuration. Below this is the 'Device List' section, which contains a table with columns for Server Name, IP, Port, and Device Type. The table is currently empty. Below the table is the 'Device Properties' section, which includes several input fields and buttons. The 'Device Type' field is a dropdown menu with 'NE-VS201' selected. The 'Device Name' field is empty. The 'IP / URL' field contains '10.40.80.8'. The 'Port#' field contains '80'. The 'User ID' field contains 'Admin'. The 'Password' field is empty. To the right of these fields are four buttons: 'Find Cameras', 'Add', 'Update', and 'Delete'.

Connecting Manually

1. From the **Live View** screen, click **Setup**.
2. Click **Network Video**.
3. Select your network device from the **Device Type** list.
4. Type a **Device Name**.
5. Type the **IP/URL address**, **Port#**, **User ID** and **Password** of the device.
6. Click **Add**.
7. Click **Apply**.
8. Proceed to Assigning a Network Device to a Channel.

Connecting with Find Cameras

1. From the **Live View** screen, click **Setup**.
2. Click **Network Video**.
3. Click **Find Cameras** to automatically find all connected Network cameras.
4. Select the check box next to the desired camera.
5. Type the **User ID** and **Password** of the device.
6. Click **Get Device**.
7. Click **Apply**.
8. Proceed to Assigning a Network Device to a Channel.

Assigning a Network Device to a Channel

1. From the Live View screen, click Setup.
2. Click Network Video.
3. Click the Channel Setup tab.

The screenshot shows a software interface with a top navigation bar containing tabs: License, Add/Remove Device, Channel Setup (selected), Audio Setup, and Camera Configuration. The main area is divided into two panels. The left panel, titled 'Channel List', contains a table with columns 'Channels', 'Device', and 'Device Stream'. The right panel, titled 'Channel Properties', contains a 'Position Name' text field, a 'Select Device' dropdown menu, and three checkboxes: 'PTZ Camera' (checked), 'Wide Screen', and 'Intensive' (with sub-options 'Intensive Motion', 'Intensive Sensor', and 'Intensive Instant'). At the bottom of the right panel are three buttons: 'Apply All', 'Delete All', and 'Drag & Drop Cameras'.

Channels	Device	Device Stream
<input type="checkbox"/> Position1	<None>	<None>
<input type="checkbox"/> Position2	<None>	<None>
<input type="checkbox"/> Position3	<None>	<None>
<input type="checkbox"/> Position4	<None>	<None>
<input type="checkbox"/> Position5	<None>	<None>
<input type="checkbox"/> Position6	<None>	<None>
<input type="checkbox"/> Position7	<None>	<None>
<input type="checkbox"/> Position8	<None>	<None>
<input type="checkbox"/> Position9	<None>	<None>
<input type="checkbox"/> Position10	<None>	<None>
<input type="checkbox"/> Position11	<None>	<None>
<input type="checkbox"/> Position12	<None>	<None>
<input type="checkbox"/> Position13	<None>	<None>
<input type="checkbox"/> Position14	<None>	<None>
<input type="checkbox"/> Position15	<None>	<None>
<input type="checkbox"/> Position16	<None>	<None>

4. Click an available channel on the **Channel List**.
5. Type the desired **Position Name**.
6. On the **Select Device** list, select the appropriate network device added previously.
7. If the device has PTZ capabilities, select the **PTZ Camera** check box to enable.
8. If the device displays wide screen video, select the **Wide Screen** check box to allow it to display properly.
9. If supported, select the **Use Network Camera Motion Detection** check box.
10. Select **Intensive Motion**, **Intensive Sensor**, and/or **Intensive Instant** to increase the recording rate on an event.
11. Click **Apply** to save your selections.

Assigning Audio Channels to a Network Device

1. From the Live View screen, click **Setup**.
2. Click **Network Video**.
3. Click the **Audio Setup** tab.

The screenshot shows the 'Audio Setup' tab in a software interface. At the top, there are navigation tabs: 'License', 'Add/Remove Device', 'Channel Setup', 'Audio Setup' (selected), and 'Camera Configuration'. The main area is divided into two panels: 'Channel List' and 'Channel Properties'.

Channel List

Channels	Device	Device Stream
<input type="checkbox"/> Position1	<None>	<None>
<input type="checkbox"/> Position2	<None>	<None>
<input type="checkbox"/> Position3	<None>	<None>
<input type="checkbox"/> Position4	<None>	<None>
<input type="checkbox"/> Position5	<None>	<None>
<input type="checkbox"/> Position6	<None>	<None>
<input type="checkbox"/> Position7	<None>	<None>
<input type="checkbox"/> Position8	<None>	<None>
<input type="checkbox"/> Position9	<None>	<None>
<input type="checkbox"/> Position10	<None>	<None>
<input type="checkbox"/> Position11	<None>	<None>
<input type="checkbox"/> Position12	<None>	<None>
<input type="checkbox"/> Position13	<None>	<None>
<input type="checkbox"/> Position14	<None>	<None>
<input type="checkbox"/> Position15	<None>	<None>
<input type="checkbox"/> Position16	<None>	<None>

Channel Properties

Select Device
<None>

Record Network Audio

Enable Network Audio in Live View

Apply All

Delete All

Drag & Drop Cameras

4. Click an available channel on the **Channel List**.
5. On the **Select Device** list, select the appropriate network device added previously.
6. To record the network audio, select the **Record Network Audio** check box. The recorder will record incoming audio from the selected camera and the audio channel will be available on the search screen.
7. To access the audio channel from the Live View screen, select the **Enable Network Video in Live View** check box. This will allow users to listen to live audio from compatible connected cameras.

Assigning Dual Streams

Dual stream support enables you to take advantage of two different streams from an IP camera. One stream can be high definition forensic video, while the other stream can be a lower resolution for live display. This allows for SCS or Remote to display more cameras while utilizing lower bandwidth and less CPU usage.

The second stream is used for motion detection in the server, which lightens the processing load for centrally-managed motion detection configurations. Dual Stream can be configured to allow for the continued use of Hot Spot when desired.

Dual streaming functions are limited to cameras that support this feature.

1. From the **Live View** screen, click **Setup**.
2. Click **Network Video**.
3. Click the **Channel Setup** tab.

The screenshot displays the 'Channel Setup' interface. On the left is the 'Channel List' table, and on the right is the 'Channel Properties' configuration panel.

Channels	Device	Main Stream	Sub Stream
<input checked="" type="checkbox"/> Position1	10.88.88.56	Stream 1	<None>
<input type="checkbox"/> Position2	<None>	<None>	<None>
<input type="checkbox"/> Position3	<None>	<None>	<None>
<input type="checkbox"/> Position4	<None>	<None>	<None>
<input type="checkbox"/> Position5	<None>	<None>	<None>
<input type="checkbox"/> Position6	<None>	<None>	<None>
<input type="checkbox"/> Position7	<None>	<None>	<None>
<input type="checkbox"/> Position8	<None>	<None>	<None>
<input type="checkbox"/> Position9	<None>	<None>	<None>
<input type="checkbox"/> Position10	<None>	<None>	<None>
<input type="checkbox"/> Position11	<None>	<None>	<None>
<input type="checkbox"/> Position12	<None>	<None>	<None>
<input type="checkbox"/> Position13	<None>	<None>	<None>
<input type="checkbox"/> Position14	<None>	<None>	<None>
<input type="checkbox"/> Position15	<None>	<None>	<None>
<input type="checkbox"/> Position16	<None>	<None>	<None>

The 'Channel Properties' panel on the right includes the following fields and options:

- Position Name:** Position1
- Select Device:** 10.88.88.56
- Main Stream:** Stream 1
- Sub Stream:** <None>
- PTZ Camera
- Network Camera Motion Detection
- Wide Screen
- Intensive:**
 - Intensive Motion
 - Intensive Sensor
 - Intensive Instant

At the bottom of the panel are three buttons: 'Apply All', 'Delete All', and 'Drag & Drop Cameras'.

4. Click an available channel on the **Channel List**.
5. Type the desired **Position Name**.
6. On the **Select Device** list, select the appropriate network device added previously.
7. If the device has dual streaming capabilities, choose the appropriate streams in the **Main Stream** and **Sub Stream** drop-down menus.
8. Click **Apply** to save your selections.

Camera Configuration

The Camera Configuration tab displays information on all cameras connected to the Surveillance recorder.

Note The maximum bit rate with a non-RAID recording solution is 90 megabits per second.

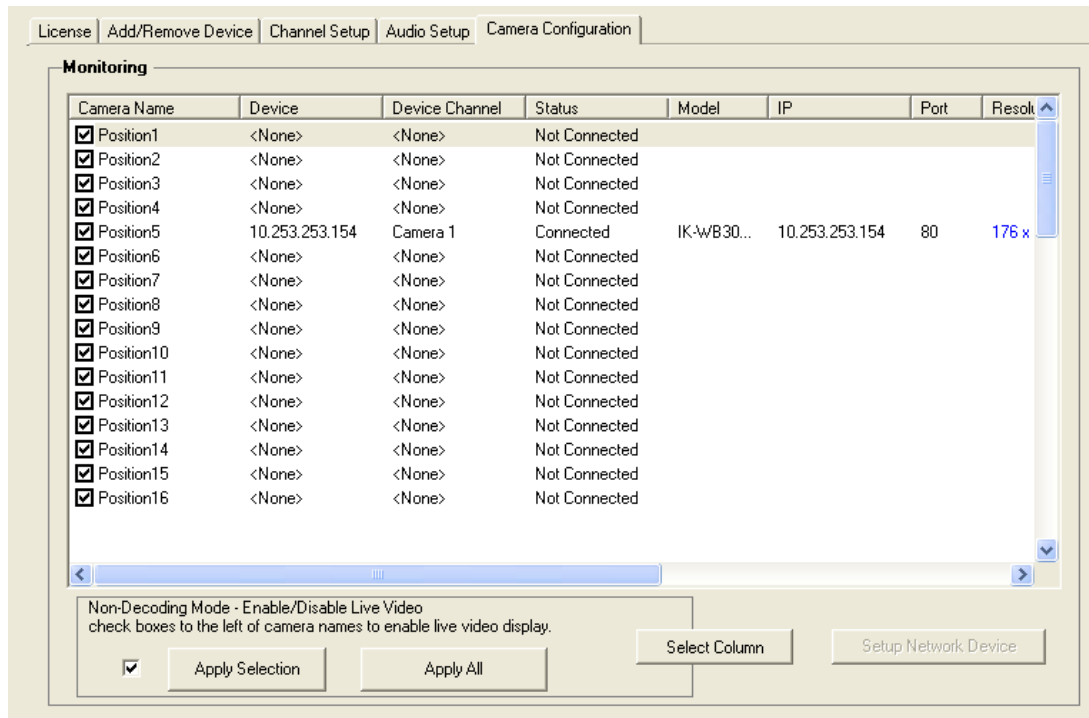

Disable/Enable Live Video

- To disable the live view of a network device (to conserve resources), unselect the check to the left of the Camera Name. The camera channel will display "Non-Decoding Mode Enabled" on a black background
- To enable the live view of network device, select the check box next to the Camera Name that you want available for live video display.

Displaying More Columns

The Camera Configuration tab can be customized to display the information you use most. Click **Select Column** to add or remove specific columns.



Capture FPS

IP Address

Codec

Record FPS

Port Number

Quality

Schedule

Resolution

PTZ

Manufacturer

Record FPS

Model

Frame Rate

Accessing the Configuration Menu

Use the Surveillix interface to access basic network device menu functions.

1. From the **Live View** screen, click **Setup**.
2. Click **Network Cameras**.
3. Click the **Camera Configuration** tab.
4. Highlight the desired camera.
5. Click **Setup Network Device**.

Upgrade and Registration

Have the following information available before registering the recorder upgrade.

Product Serial Number: This may be the Product Serial Number displayed on the product sticker on the left side of the recorder; or the the unique Product Serial Number provided with the purchase of additional channel licenses.

System ID: The System ID is a number that is generated by the Surveillix unit. This is a unique code generated using the MAC address of the recorder.

Locating the System ID

1. From the **Display** screen, click **Setup**.
2. Click **Network Cameras**.
3. Click the **License** tab.

License Information

Trial Version - 30 days remaining.

System ID:

License Key:

Channel Connection License

License Key	Total	Used	Free

Obtaining the Unlock Code

1. Open an Internet browser and go to <http://register.surveillixdvr.com>

Product Serial Number

System ID

Submit

2. Type the **Product Serial Number** that was provided by Surveillix.
3. Type the **System ID** generated by the recorder.
4. Click **Submit**.

Software Registration

Product Name	01 Channel IP Camera Unlock
Product Serial Number	8802020204
System ID	4e88f753-e87c-08
DVR Serial Number:	8802020204

Please verify the information and press NEXT to proceed.

5. Verify the information.
6. Click **Next** if the information is correct.
7. Once validated, you will be provided with the Unlock Code.
8. Print the page and save for later reference.

Software Registration

The following is your unlock code. Keep this number in a safe place as you will need it if you ever reinstall the software.

Unlock Code	8802020204-148f753e87c08
Product	01 Channel IP Camera Unlock
Product SN	8802020204
DVR SN	8802020204

NOTE: This unlock code cannot be transferred to a different computer.

MOTION SETUP

The recorder allows the user to adjust several different Motion Settings and create motion detection areas.

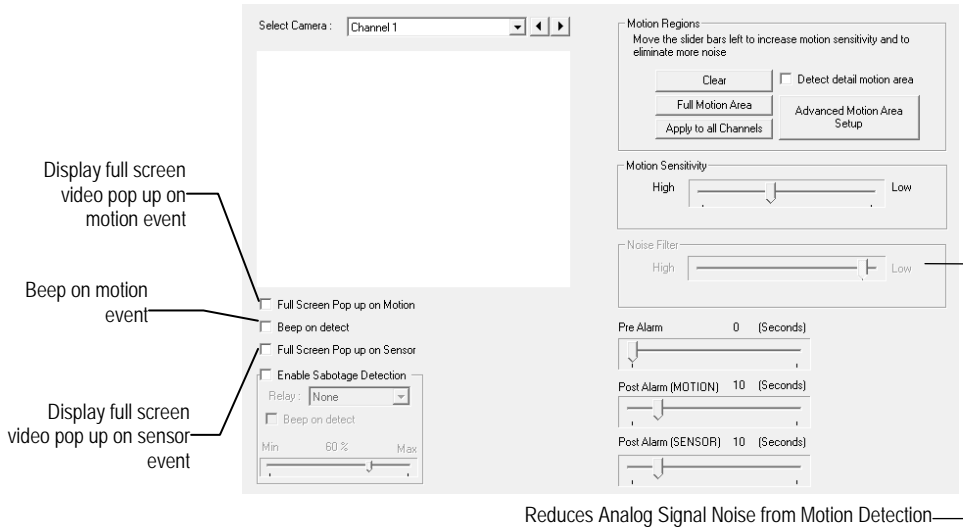

Create a Motion Area

1. From the Display screen, click **Setup**.
2. Click **Motion**.
3. Select a camera from the **Select Camera** list.
4. Select the **Detect Detail Motion Area** check box.
5. Click **Clear**.
6. Click **Advanced Motion Area Setup**.
7. Click a **Motion Detection Area** shape button.
8. Drag the mouse over the camera image.

Note To create a polygon shape, click the mouse at each point and double-click to close the shape.

9. Click **OK**.
10. Move the sliders to adjust motion sensitivity and the noise filter.
11. Define the pre-alarm and post-alarm recording time for a motion event.

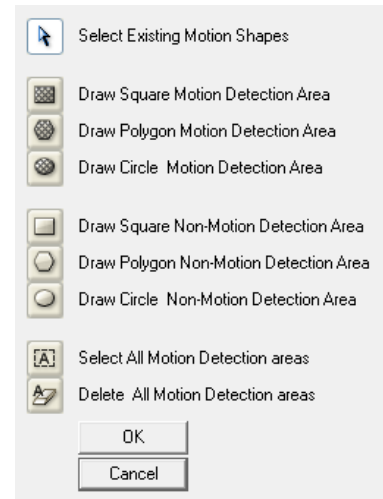

Pre Alarm – 0 - 120 Seconds [The number of seconds the recorder records before motion is detected—to ensure any motion occurring between I-frames is captured, set to a value greater than 0]

Post Alarm (MOTION) – 0 - 120 Seconds [The number of seconds the recorder records after it stops detecting motion]

Regular Interval Recording

Regular Interval Recording allows users to record a single frame every few minutes or hours when there is no motion. This option is only available when Motion recording or Sensor recording is selected in the recording schedule.

Note Regular Interval Recording is only supported by the MJPEG codec. See Frame Setup for more information on selecting the recording codec.

To enable Regular Interval Recording:

1. Select the Regular Interval Recording check box.
2. Specify how often to capture an image when no motion is occurring. Users can capture as few as one image per second.

GENERAL SETUP

The screenshot displays the 'GENERAL SETUP' window with the following sections:

- Voice Warning:** Includes a volume slider, a microphone icon, and a globe icon. Checkboxes for Motion Event, Sensor Event, and Sabotage Event.
- Video Loss Alarm:** Checkboxes for Video loss alarm beep, Video loss alarm output, and Video loss alarm Log.
- Intensive On:** Checkboxes for Intensive on Sensor and Intensive on Motion.
- Display:** Checkboxes for Display Motion Detection Area Box, Display Sensor Status BAR, Display Control Status BAR, Motion detect on Continuous recording, Hide network connectivity, IP Camera key frame decoding, and Use full screen. Includes a font selection box (MS sans serif) and an OSD font button. A Display Size dropdown menu is set to 1280 x 1024.
- Function:** Checkboxes for Beep on login fail and Live Afterimage Filter. Includes buttons for Hybrid Sensor setup, Audio, Volume, Control Panel, and Sequence Setting.

Display

IP Camera Key Frame Decoding

This will only show key frames (I-frames) in the live view in order to reduce the CPU load. Enabling this function does not impact recorded or remote streaming video.

Use Full Screen

Stretch the Surveillix interface to use the full monitor screen based on the resolution set in Windows.

Display Size

Select from available monitor display sizes. Use to correctly display video on wide screen monitors.

Function

Beep on Login Fail

Enables the recorder to beep continuously in response to a failed login attempt. Only an authorized login will stop the beeping.

Sequence Setting

Allows the video out picture to automatically cycle through channels at a set speed. Example: .Cycle through channels 1-6 at four-second intervals.

Dual Monitor

Enable a second monitor connected to the recorder. See *Connecting a Second Monitor* for complete instructions.

Hybrid Sensor Setup

This interface is used to link Hard Contact Sensor Inputs from supported Network Devices to the recorder software.

Voice Warning

The recorder allows users to play a sound file when either a Motion event or Sensor event occurs. This file can be a custom created sound file that is unique to the application. The selected WAV file is played through speakers attached to the recorder.

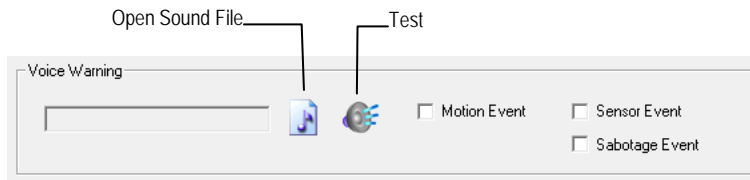

1. Click the **Open Sound File** icon to browse for a WAV file. The selected file will display in the box on the left.
2. Click the **Test** icon to verify the audio file.
3. Select **Motion Event** and/or **Sensor Event** to trigger the audio file.

Connecting to a Wide Screen Display

1. Click **Exit** on the Display screen and select **Restart in Windows Mode**.
2. Right-click the **Desktop** and select **Screen Resolution**.
3. From the Resolution list, select the proper resolution of the connected display.

Tip Refer to the display documentation for the proper resolution settings.

4. Click **Apply**, confirm the change, then click **OK**.
5. Double-click the **Surveillix Server** icon on the Desktop.
6. Click **Setup** on the Display screen and then click **General**.
7. Under **Display Settings**, select **Use Full Screen**.
8. Click **Apply** then click **Exit Setup**.

Connecting a Second Monitor

All recorders can support two connected monitors. If a second monitor is connected to the recorder, follow these steps to enable the Dual Monitor settings.

1. Click **Exit** on the Display screen and select **Restart in Windows Mode**.
2. Right-click the **Desktop** and select **Screen Resolution**.
3. Click the secondary display screen and from the Multiple displays list click **Extend** these displays.

Tip If a second display is not shown click **Detect**; if the second display does not appear, verify that the second monitor is properly connected.

4. Click **Apply**, confirm the change, then click **OK**.

Tip Refer to the display documentation for the proper resolution settings.

5. Double-click the **Surveillix Server** icon on the Desktop.
6. Click **Setup** on the Display screen and then click **General**.
7. Under **Function**, select **Dual Monitor**.
8. Click **Apply** then click **Exit Setup**.

Volume

The volume control allows fine tuning of the volume settings on the recorder.

Volume Options:

- **Device/Speakers** – Used to adjust the volume for all sound coming from the system's speakers.
- **System Sounds** – Used to adjust the volume for the system sounds exclusively.

Hybrid Sensor Setup

This interface is used to link Hard Contact Sensor Inputs from supported Network Devices to the recorder software.

The Network Device List is a list of available IP camera devices that have sensors enabled. When a device is selected, the lower table will populate with a list of the sensors for the device.

- Click the arrow next to a sensor or relay to display the number of the sensor on the recorder. You can then associate a sensor or relay from the recorder with a sensor or relay on the network device.

Network Device Sensor Setup

* Network Device List (Select a device.)

Address (Port)	Model (Type)	Sensor count	Relay count

* Sensor / Relay list

Sensor count	DVR Sensor No	Relay	DVR Relay No

Apply Close

Auto Sequence Setting

Auto Sequencing is available either in the Display screen when Auto Sequencing has been enabled. Auto Sequencing conveniently displays video channels at specified intervals and sequences through each selected channel.

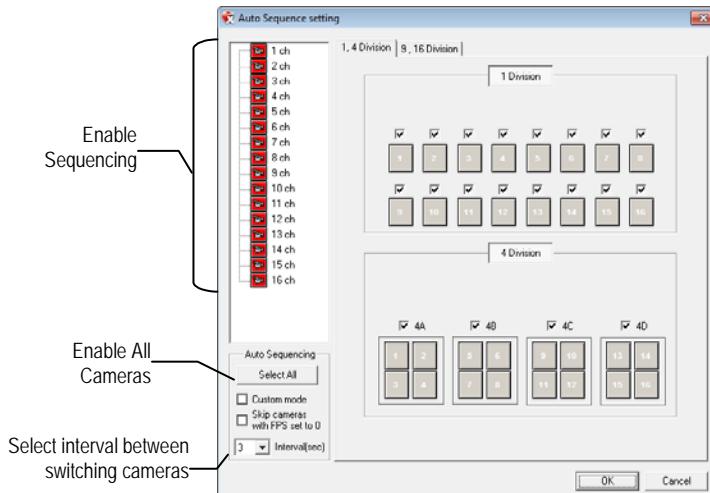

Custom Mode

Create non-standard screen division layouts.

Skip 0 FPS Channel

Sequence skips cameras with no video signal.

Create Custom Auto Sequence

1. From the Display screen, click **Setup**.
2. Click **General**.
3. Click **Sequence Setting**.
4. Click individual cameras in the left pane or click **Select All** to include all cameras in the sequence.
5. Select an **Interval** time (in seconds) to display each screen in the sequence.
6. Select screen division options for appropriate cameras.
7. Click **OK**, click **Apply**, then click **Exit Setup**.

SCHEDULE SETUP

Recording Schedule

The Recording Schedule window allows you to create different recording schedules based on the day, time, and type of recording desired. In addition, this window contains the System Restart options.

Recording schedule window

Single Day Selection / Multi Day selection

Create Special Day recording schedules

Recording mode options

Emergency IP setup

Recording schedule window

Recording

Sensor

Day of week

SUN MON TUE WED THU FRI SAT

Single Selection Mode

Restart setup

Recording schedule

ALL	0	1	2	3	4	5	6	7	8	9	10
CAM01											
CAM02											
CAM03											
CAM04											
CAM05											
CAM06											
CAM07											
CAM08											
CAM09											
CAM10											
CAM11											
CAM12											
CAM13											
CAM14											
CAM15											
CAM16											

Special day

Normal Day Mode

9/14/2011

Save special day

Delete special day

No recording

Continuous

Motion

Event : (A) Alarm Event (R) Central Station (E) Emergency Agent Delete Alarm

Emergency IP: IP Use IP Emergency Time (sec.): 5

IP 1 0.0.0.0

Sensor Schedule

The Sensors will supersede all other types of recording modes (Motion and Continuous). Regardless of the recording schedule of a particular camera, if a sensor event occurs the associated cameras will begin recording as a Sensor Event. Sensor Recordings will be flagged and searchable using the Index Search Mode. Cameras are associated to sensors in the Camera Setup menu.

The screenshot shows the 'Sensor schedule window' with the following components:

- Recording Mode:** Radio buttons for 'Recording' and 'Sensor' (selected).
- Day of week:** Checkboxes for SUN, MON, TUE, WED (checked), THU, FRI, SAT. A 'Single Selection Mode' button is also present.
- Recording schedule:** A grid with columns for days 0-9 and rows for sensors SEN01-SEN16. SEN01-SEN05 are highlighted in red. SEN06-SEN08 are highlighted in white.
- Special day:** A section on the right with a 'Normal Day Mode' dropdown, a date selector (9/14/2011), and 'Save special day' and 'Delete special day' buttons.
- Buttons:** 'Restart setup', 'Enable', and 'Disable' buttons.
- Event options:** Radio buttons for '(A) Alarm Event', '(R) Central Station', and '(E) Emergency Agent', plus a 'Delete Alarm' button.
- Emergency IP setup:** A section with 'Emergency IP:' label, 'IP Use' checkboxes, an IP address field (0.0.0.0), and an 'Emergency Time (sec.):' dropdown (5).

Create a Recording Schedule

Select a day to begin creating the schedule for -or- click **Single Day Selection**, enabling **Multi Day Selection**, to create the same schedule for multiple days.

Highlight the Time-Blocks within the **Recording Schedule** window for the camera(s) selected to schedule. Once the desired Time-Blocks are highlighted, click a Recording Mode button. The Time-Blocks should now appear Blue for Motion, Yellow for Continuous and White for No Recording.

Note Leave cameras recording with Sensor Detection set to **No Recording** for the specified time block(s).

Create a Sensor Schedule

Click **Schedule** and then select the **Sensor** option. Select a single day or click **Single Day Selection** to include multiple days in the schedule.

Highlight the Time-Blocks within the **Recording Schedule** window for the sensor(s) to enable and schedule. Once the time blocks are highlighted click **Enable**. The time block will now appear red.

Scheduling Alarm Events

There are three types of Alarm Events:

- **ALARM EVENT:** This option logs the Alarm Events on the local server.
- **CENTRAL STATION:** This option sends a Map Alarm to SCS.
- **EMERGENCY AGENT:** This option sends the Alarm Event to the Emergency Agent software.

Motion can be designated as an alarm event. Often motion does not need to be treated as an Alarm event. For example: During work hours, motion that occurs is expected and should not be treated as an alarm. However, after business hours, any motion that occurs could be treated as an alarm.

1. From the Display screen, click **Setup**.
2. Click **Schedule**.
3. Select either **Recording** or **Sensor**.
4. Highlight time blocks in the schedule that have been set to **Motion** (or **Sensor**) and click the desired **Event** buttons (**Alarm Event**, **Central Station**, **Emergency Agent**). A corresponding letter will display in the selected time blocks.

Emergency Agent Schedule

Video recording triggered by motion or sensor events can be sent to the Emergency Agent software.

1. Enable the **Emergency Agent Event**. (see Scheduling Alarm Events above).
2. Enter the **IP Address** of a PC running the Emergency Agent software under Emergency IP.
3. Select the check box next to the IP Address to enable it. Only one IP Address is supported at a time.
4. Enter the recording duration (in seconds) in the **Emergency Time** box.

Tip See the Emergency Agent chapter for detailed information on setting up the Emergency Agent software.

Special Day Schedule

You can create days that have a unique recording schedule. For example: Holidays, Special Events, etc.

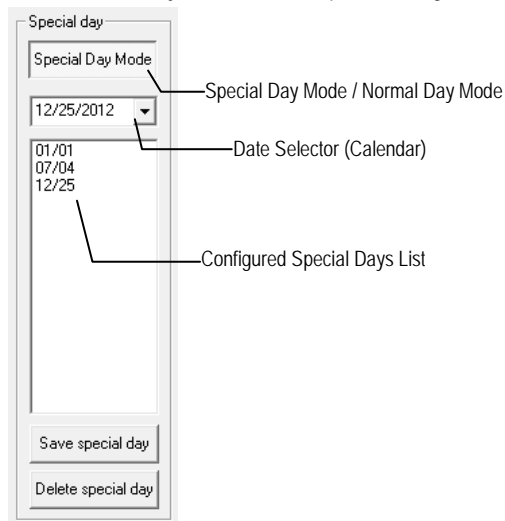

Creating/Editing a 'Special Day' Schedule

1. Click **Normal Day Mode** to enable the Special Day Mode.
2. Select a day by typing the date or clicking the down arrow to select the date from a calendar.
3. Highlight the time-blocks within the **Recording Schedule** window for the camera(s) selected. Once the desired **Time-Blocks** are highlighted, click a **Recording Mode** button.
4. When finished creating the schedule click **Save Special Day**.

Note The special day should now appear as a date in the Special Day Schedule. To edit it, highlight it on the list and repeat steps 3 and 4 above.

Deleting a 'Special Day' Schedule

1. Select a date from the **Special Days** list.
2. Click **Delete Special Day**.

System Restart Setup

Restart Setup allows you to define a schedule wherein the recorder automatically restarts according to specified parameters.

The screenshot shows a dialog box titled "System restart setup". Inside, there is a section labeled "System Restart Time" containing seven panels, one for each day of the week: Monday, Tuesday, Wednesday, Thursday, Friday, Saturday, and Sunday. Each panel has an "Enable" checkbox, a "Time" field with two dropdown menus (both set to "00"), and two radio buttons: "Restart" (selected) and "Off". At the bottom of the dialog are "OK" and "Cancel" buttons.

Create System Restart Schedule

1. From the Display screen, click **Setup**.
2. Click **Schedule**.
3. Click **Restart Setup**.
4. Select **Enable** for each day of the week that a restart is desired.
5. Specify the time of day to schedule the system restart.
6. Select either **Restart** or **Off**.

Note If **Off** is selected, the recorder will shut down at the specified time but not restart.

7. Click **OK**, click **Apply**, then click **Exit Setup**.

NETWORK SETUP

Network Setup allows the user to adjust settings such as Ports, setup emergency PPP information for use with the Emergency Agent and enable Remote Access.

View IP Address Displays the IP address of the recorder.

Transport Rate Throttles the bandwidth on the recorder. This option is based on percentages of images sent.

Resolution By setting the resolution low, the images will be sent faster. However, the image quality will be reduced considerably. When set to Original, full quality video will be sent [720 x 480 (NTSC) 720 x 576 (PAL)]. The Original Setting is very bandwidth-intensive.

Time Out Value When attempting to connect to the recorder, if the connection does not succeed during the timeout period (seconds), the connection will be terminated.

Emergency Port Used to connect with the Alarm Monitor software.

Center Port Used to connect with the Surveillix remote software (Remote, SCS, MDVR). This port must be specified in the remote software to connect to the recorder.

Note Center Port 1025 is not available.

Image Port Used to transfer the video to the remote software.

Search Port Used to transfer search information to the remote software.

Note If connecting to the recorder through a firewall, the above ports must be open to incoming and outgoing traffic.

Health Check Port Enables SCS to receive information regarding the health of the recorder.

Keyboard control Select the **Use Keyboard Control** check box to enable use of a connected RS-232 PTZ Joystick/Keyboard.

Two-Way Audio Communication Select the **Enable Audio Communication** check box to enable two-way audio between the DVR and SCS using a microphone connected to the DVR.

ADMINISTRATIVE SETUP

ADMINISTRATION - Displays the Log files, Storage Management and User Management.

Select Log: User Management (Create and configure User accounts), Storage Management (Disk Management, Status Check/Email), Other Management (Program Management(ETC), File Information)

Select Date: System Log (Calendar for September 2011)

Log Type:

- System Log
- Event Log
- Alarm Log
- Drive Check Log

Export:

- Choose 1-week period to export
- Start Date: 9/15/2011
- End Date: 9/15/2011
- Export log data (Text)
- Export log data (Raw)

* Pages : Page 1(00001 ~ 01000) * Total log size : 48.48 KB

NO	Date & Time	Log Contents	Log Value	User
1	9/14/2011 0:00:00...	Create data directory	[F] Date:20110914, Time:0	Default
2	9/14/2011 1:00:00...	Create data directory	[F] Date:20110914, Time:1	Default
3	9/14/2011 2:00:00...	Create data directory	[F] Date:20110914, Time:2	Default
4	9/14/2011 3:00:00...	Create data directory	[F] Date:20110914, Time:3	Default
5	9/14/2011 4:00:00...	Create data directory	[F] Date:20110914, Time:4	Default
6	9/14/2011 5:00:00...	Create data directory	[F] Date:20110914, Time:5	Default
7	9/14/2011 6:00:00...	Create data directory	[F] Date:20110914, Time:6	Default
8	9/14/2011 7:00:00...	Create data directory	[F] Date:20110914, Time:7	Default
9	9/14/2011 8:00:00...	Create data directory	[F] Date:20110914, Time:8	Default
10	9/14/2011 9:00:00...	Create data directory	[F] Date:20110914, Time:9	Default
11	9/14/2011 9:13:37...	Terminate of Site		Default
12	9/14/2011 9:25:46...	Start Site	Ver(4.5.0 [Build : 48]) - Lib(2.0.3.7)	Default

Log Data Display

Export Log Data (1 to 7 days)

Disk Management

The Disk Management window is a native Windows function. This window displays the partition scheme and health status of the Hard Disk Drives in the recorder. This window is often used to troubleshoot a recorder, or verify the amount of Hard Drive storage installed. For more information about Disk Management, consult a Windows 7 manual.

Disk Management

Volume	Layout	Type	File System	Status	Capacity	Free Spa...
(C:)	Simple	Basic	NTFS	Healthy (S...	39.66 GB	27.95 GB
DVR (E:)	Simple	Basic	NTFS	Healthy (P...	213.05 GB	200.80 GB
DVR (F:)	Simple	Basic	NTFS	Healthy (P...	213.05 GB	141.02 GB

Disk 0
Basic
465.76 GB
Online

Volume	Capacity	File System	Status
(C:)	39.66 GB	NTFS	Healthy (System, Boot, F...
DVR (E:)	213.05 GB	NTFS	Healthy (Primary Partition)
DVR (F:)	213.05 GB	NTFS	Healthy (Primary Partition)

Legend: ■ Unallocated ■ Primary partition

Setting Up DDNS

Dynamic Domain Name System (DDNS) is a service that provides a static address to simplify remote connection to the recorder. This service is most useful for installations where the WAN (public) IP address is dynamic (changes from time to time). Most public IP addresses are dynamic unless a static address has been specifically ordered from the internet service provider.

Enable DDNS

To enable this functionality of the recorder, follow the steps below:

1. Click **Setup** on the Display screen and log in as Administrator if prompted.
2. Click **Administrative**.
3. Click **Program Management (ETC)** and enter the Administrator password when prompted.
4. Click **Show** (to the right of Dynamic DNS Configuration).

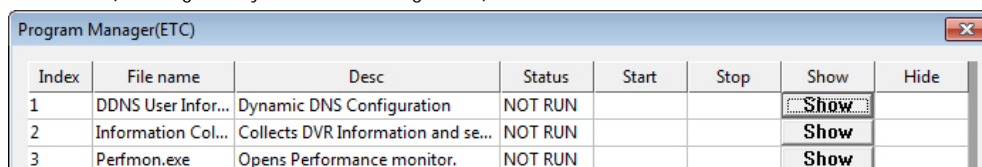

Index	File name	Desc	Status	Start	Stop	Show	Hide
1	DDNS User Infor...	Dynamic DNS Configuration	NOT RUN			Show	
2	Information Col...	Collects DVR Information and se...	NOT RUN			Show	
3	Perfmon.exe	Opens Performance monitor.	NOT RUN			Show	

5. Select **Enable DDNS**.
6. Enter the **User Name**, **Password**, and **Hostname** specified on the DDNS document shipped with your recorder.
7. Click **OK**, then close the **Program Manager** window.

Note Ensure the recorder has an IP address by setting it statically. The Network settings may need to be changed. If you are not sure of the correct values, contact the individual or department responsible for network administration at the site.

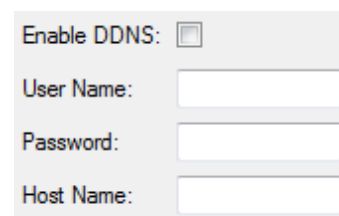

Enable DDNS:

User Name:

Password:

Host Name:

Set the IP Address

The IP address of the recorder is set in Windows; to set the IP address follow the steps below:

1. On the Display screen, click **Exit** and choose **Restart in Windows Mode**.
2. Right-click **My Network Places** and click **Properties**.
3. On the **General** tab, click **Internet Protocol (TCP/IP)** and then click **Properties**.
4. Select **Use the following IP address**.
5. Enter values for the **IP Address**, **Subnet Mask**, and **Default Gateway** (these may be specified by the department responsible for network administration).
 - a. **IP Address**: The first three sets of numbers should match the router's local IP address and the last set should be a unique number between 1-254.
 - b. **Subnet Mask**: This should match the router's setting (commonly 255.255.255.0 for 192.X addresses and 255.0.0.0 for 10.X addresses).
 - c. **Default Gateway**: This is the router's internal IP address. Once DDNS is configured, the router the recorder connects to will need to have port forwarding configured.

For further instruction on this process, visit http://www.portforward.com/english/routers/port_forwarding/outerindex.htm

Once DDNS and port forwarding have been configured, the recorder will be accessible from any remote site by entering the HOSTNAME into the address bar of Internet Explorer or the IP Address field in remote software.

User Management

The User Management Console allows the administrator to create, edit, and delete user accounts. Each user account can be assigned different privileges to limit the usage of the recorder system. Users can be given administrator privileges by enabling all rights, however only the true administrator account can log into the User Management Console.

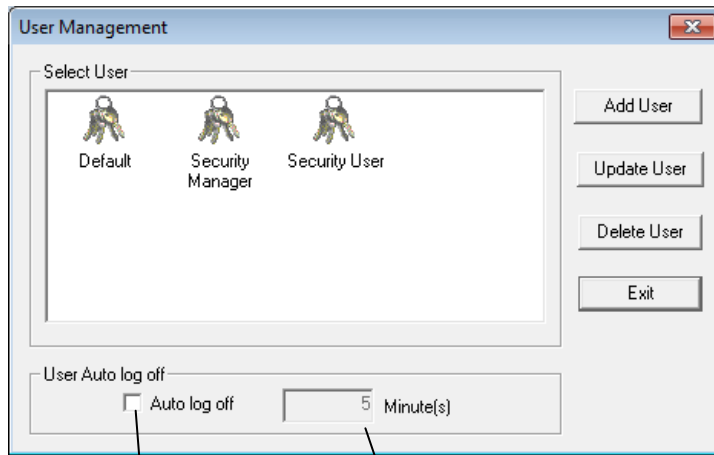

Enable Auto Log Off

Log Off Users who are inactive for the designaed time (this settings affects all users).

Note The Delete User button immediately deletes the user – use cautiously.

Add a New User

1. From the Display screen, click **Setup**.
2. Click **Administrative**.
3. Click **User Management**.
4. Click **Add User** to open the User window.
5. Enter a **User Name** and **Password**.
6. Enable appropriate **Permissions**.
7. Selecting **Camera** or **Audio** channels will hide those channels from the user.
8. Assign a **User Rank**.
9. Click **OK**, click **Exit**, Click **Apply**, Click **Exit Setup**.

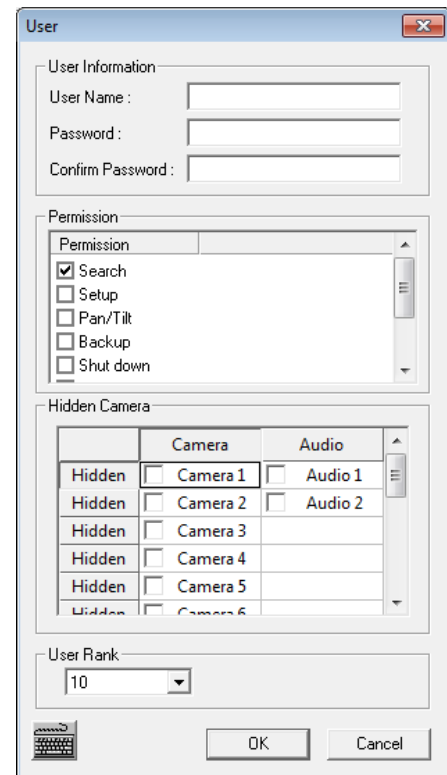

User Rank

The User Ranking structure allows the option to assign a privilege level to users who access the recorder remotely (1-10 where one has the highest privilege). For example: Since only one user is allowed to use the PTZ controls at any one time, a user with a rank of 1 will kick a user with a rank of 2 out of the PTZ controls.

The User Rank option affects:

SETUP ACCESS - The recorder software can only have one user accessing Setup at any given time. A user with a higher rank will kick another user out of the Setup menu.

NOTE Changes made by a lower ranked user may NOT save when a higher ranked user kicks the lower ranked user out of the Setup menu.

PTZ CONTROL - The recorder software can only have one user using the PTZ controls at any given time. A user with a higher rank will kick another user out of the PTZ controls.

1. From the Display screen, click **Setup**.
2. Click **Administrative**.
3. Click **User Management**.
4. Enter the Administrator password and click **OK**.
5. Select a user from the Select User box and click **Update User**.
6. Set the user's rank using the **User Rank** list and click **OK** to save changes.

Changing the Administrator Password

1. Inside Administrative setup, click User Management.
2. When the prompt appears, click Change Password.
3. Enter the new password and click **OK**.

Default Administrator Password

The default administrator login is:

User: Administrator

Password: <blank>

Log Management

The Log Management window provides you the options to overwrite log files or schedule log deletion.

Set Up Log Management Options

1. From the Administrative setup click **Log Management**.
2. Select **Log File Overwrite Option** to enable.
3. Select **Overwrite** or **Do Not Overwrite**.
4. If Overwrite is selected:
 - a. Enter a maximum **Log File Size**.
 - b. Choose a number of days to keep logs (**Delete Log File Older Than**).

Note Log files can also be manually deleted. Simply select the log you want to delete on the bottom portion of the window, then click **Delete All**.

5. Click **OK** to save the settings and close the window.

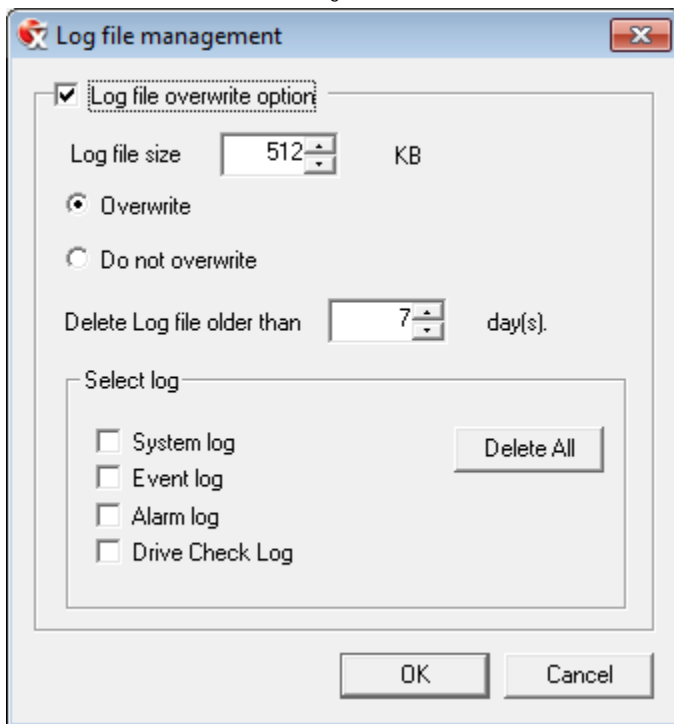

Status Check / Email

General

1. From the Display screen, click **Setup**.
 2. Click **Administrative**.
 3. Click **Status Check/Email**.
 4. Select **Enable Email Alarm**.
 5. Enter a **From Name** and email **Address**.
- Note** This name and address will appear in the **From** line of email alert messages.
6. Enter the SMTP information for the email account that will be used to send emails from the recorder. Contact your administrator for this information if necessary.
 7. If using a secondary email account select **Use Secondary SMTP** and complete the SMTP information.
 8. Click **Test** to check settings (a test message will be sent to the **From Address**).
 9. When you are finished, click **Apply** then **Close**.

The screenshot shows the 'Email Alarm' configuration window with the 'General' tab selected. The window has a title bar and a menu bar with options: Recording Data Check, SMART Information, SMART Alert, Alarm Event, MySurveillix, General, Users, and Storage Check. The main content area includes a checkbox for 'Enable E-mail Alarm'. Below it are two input fields for 'Send User': 'From Name' and 'From Address'. There are two sections for SMTP settings: 'Primary SMTP Setting' and 'Use Secondary SMTP'. Each section has input fields for 'Host Address', 'User name', 'Password', and 'Port' (set to 25). There are also checkboxes for 'Use Login' and 'Test' buttons. At the bottom right, there are 'Apply' and 'Close' buttons.

Users

1. Set up the General tab first.
 2. Select the type of **Event** to send email on.
 3. Enter the **User** and **E-mail Address** of a desired recipient.
 4. Click **Add**.
 5. Repeat for additional recipients and types of events.
- Note** A separate email notification for each type of event must be set up for a single recipient to receive notifications for each type of event.
6. When you are finished, click **Apply** then **Close**.

The screenshot shows the 'Email Alarm' configuration window with the 'Users' tab selected. The window has a title bar and a menu bar with options: Recording Data Check, SMART Information, SMART Alert, Alarm Event, MySurveillix, General, Users, and Storage Check. The main content area features a table with two columns: 'Name' and 'E-Mail address'. To the right of the table are radio buttons for 'Event' selection: 'HDD Check Alarm Event', 'Recording Data Check', 'Event Alarm' (which is selected), and 'SMART Alarm'. Below the table and event selection are input fields for 'Registration User' and 'E-mail Address', along with 'Add', 'Edit', and 'Delete' buttons. At the bottom right, there are 'Apply' and 'Close' buttons.

Storage Check

1. Set up the General and Users tabs first.
2. Select **Use Storage Check**.
3. Define the frequency of storage checks (in minutes).
4. Select an additional **Alert Option** if desired: **Beep** or **Popup Message**.
5. Add a **Comment** that will be seen in the email message if desired.
6. When you are finished, click **Apply** then **Close**.

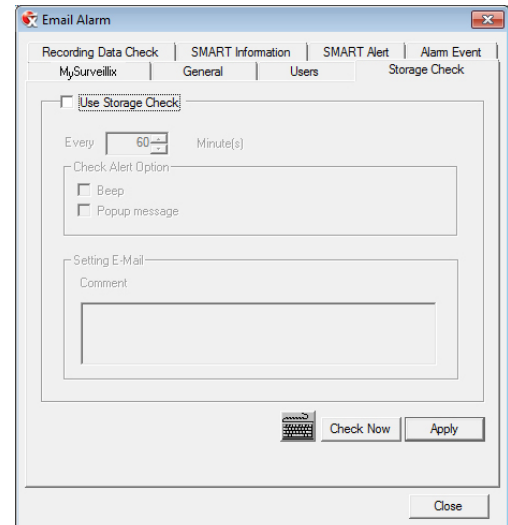

Recording Data Check

1. Set up the General and Users tabs first.
2. Select **Recording Data Check**.
3. Define the frequency of data checks (in hours).
4. Select the **Action Method**: **Popup Message Alert**, **Beep Alert**, or **Email Alert**.
5. Add a **Comment** that will be seen in the email message if desired.
6. When you are finished, click **Apply** then **Close**.

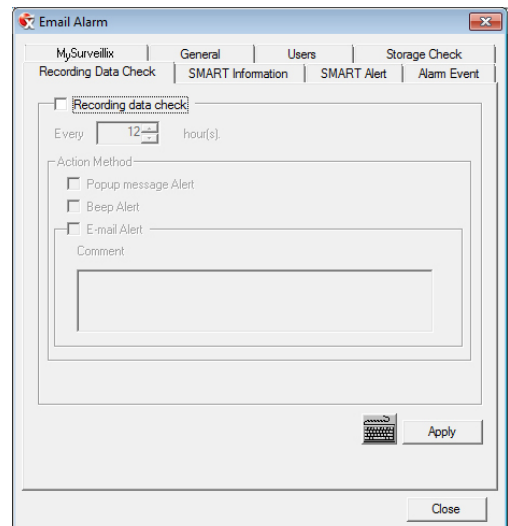

SMART Information

The SMART Information tab displays Hard Drive information.

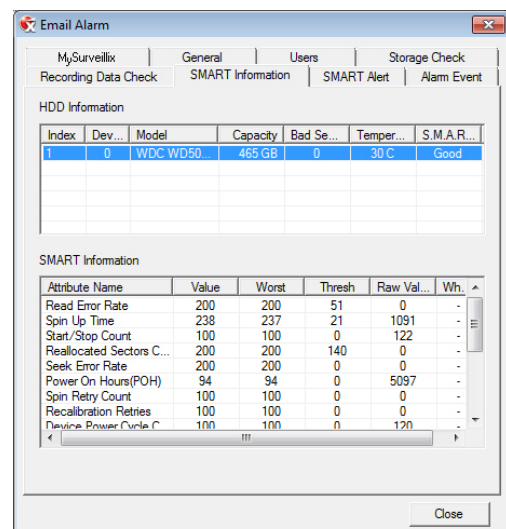

SMART Alert

1. Set up the General and Users tabs first.
2. Select **Enable SMART Alarm**.
3. Define the frequency of SMART status checks (in hours).
4. Select the type of SMART event to trigger an action.
5. If selecting for temperature checks, define the maximum HDD temperature.

Note Recommend 65°C/150°F if using Temperature Threshold.

6. Select an **Action Method**: **Beep Alert**, **Popup Message Alert**, or **Email Alert**.
7. Add a **Comment** that will be seen in the email message if desired.
8. When you are finished, click **Apply** then **Close**.

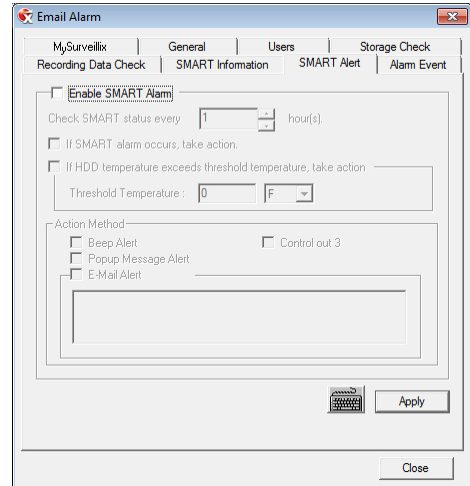

Alarm Event

1. Set up the General and Users tabs first.
2. Select **Use Email Alarm**.
3. Define the frequency to send email alerts (in minutes).
4. Select the **Event Type**: **Motion**, **Sensor**, **No Signal** (video loss).
5. Select **With Detail Info** to receive a still image attachment of the associated camera in the email message.
6. **Max Count** defines the number of message that will contain detailed data within the frequency time frame.
7. Add a **Comment** that will be seen in the email message if desired.
8. When you are finished, click **Apply** then **Close**.

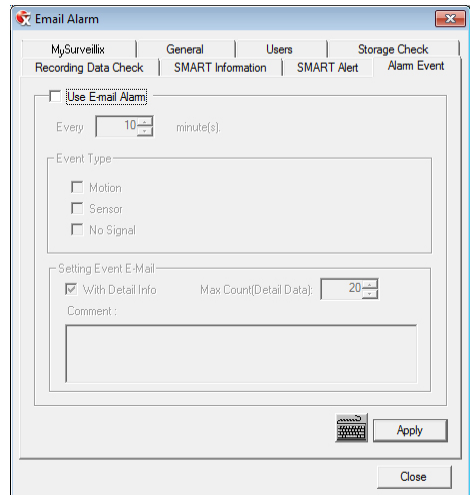

MySurveillix

1. Set up the **General** and **Users** tabs first.
3. Select **My Surveillix**.
4. Select **My Surveillix**.
5. Define the **Send Time** to designate the time the recorder will send updates to MySurveillix.
6. Enter a numeric **Security Code** if desired (this is an additional security measure to prevent unauthorized users from adding the recorder to their MySurveillix account).
7. Select **Send notification to MySurveillix on alarm events** if you want the recorder to report alarm events to MySurveillix.
8. When you are finished, click **Apply** then **Close**.

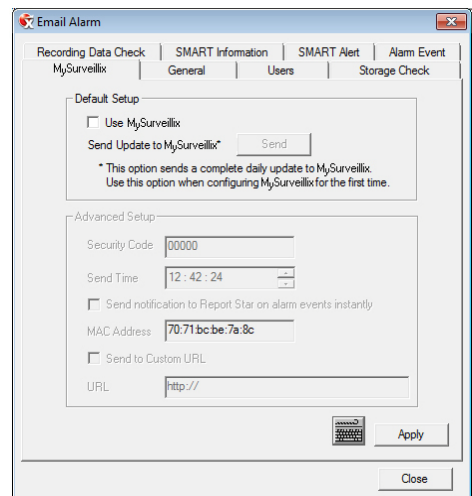

INFORMATION

The Information display allows users to define the site code necessary for connecting to remote software, save comments relative to the recorder, store tech support and contact number information, and see the currently running server software version.

The screenshot shows a web-based interface for configuring site information. It is divided into several sections:

- Site Information:** Includes fields for Site Code (100-000), Board Serial #, System Serial #, Decoder, Video Format (NTSC), and a Notes section containing the URL www.surveillancedvr.support.com.
- Drive Information:** Lists storage details for C, D, E, and F drives, including total and free space in MB.
- Telephone Number:** Fields for Contact Number and Tech. Support (866)275-4387.
- Header:** Displays 'DVR Version 4.5.0' and 'Currently Running Server Software Version'.

Callouts point to 'Total HDD /Available HDD Space' (pointing to the Drive Information section), 'Currently Running Server Software Version' (pointing to the top right), 'User-Defined Contact Numbers' (pointing to the telephone number fields), and 'User Entered Comments' (pointing to the Notes section).

Site Code

A user-specified unique identification name used by other recorder software to identify the recorder. (Remote, Emergency Agent, SCS, Digital Signature Verifier)

INSTANT RECORDING

The Instant Recording feature allows users to manually initiate recording on a specific camera, overriding the current schedule. When Instant Recording is activated the recorder flags the clip as an event so Instant Recording instances can be found using the Index Search. Instant Recording can be used, for example, when a suspicious object or person is detected and you want to flag that section of video for easy retrieval at a later date.

Activate Instant Recording

1. From the Display screen, right-click the camera on which to enable instant recording and choose **Instant Recording** (or double right-click). An **INSTANT** label will be placed on the upper right corner of the video.
2. To turn the Instant Recording Option off, right-click the camera and choose **Instant Recording** (or double right-click).

Searching 'Instant Recorded' Video

1. From the Display screen click **Search**.
2. Click **Index Search**.
3. Select the **Instant Recording** option. See the Search chapter for more information.

SEARCH

This chapter includes the following information:

- Search Overview
- Daylight Saving Time
- Index Search
- Preview Search
- Graphic Search
- Motion Search

SEARCH OVERVIEW

The recorder has several options that allow the user to easily search through, and find, a particular section of video. From Motion/Sensor indexing to calendar views highlighting days with recorded video; the recorder is equipped to help the user quickly find a specific video or event.

The following chapter describes how to use the Search features.

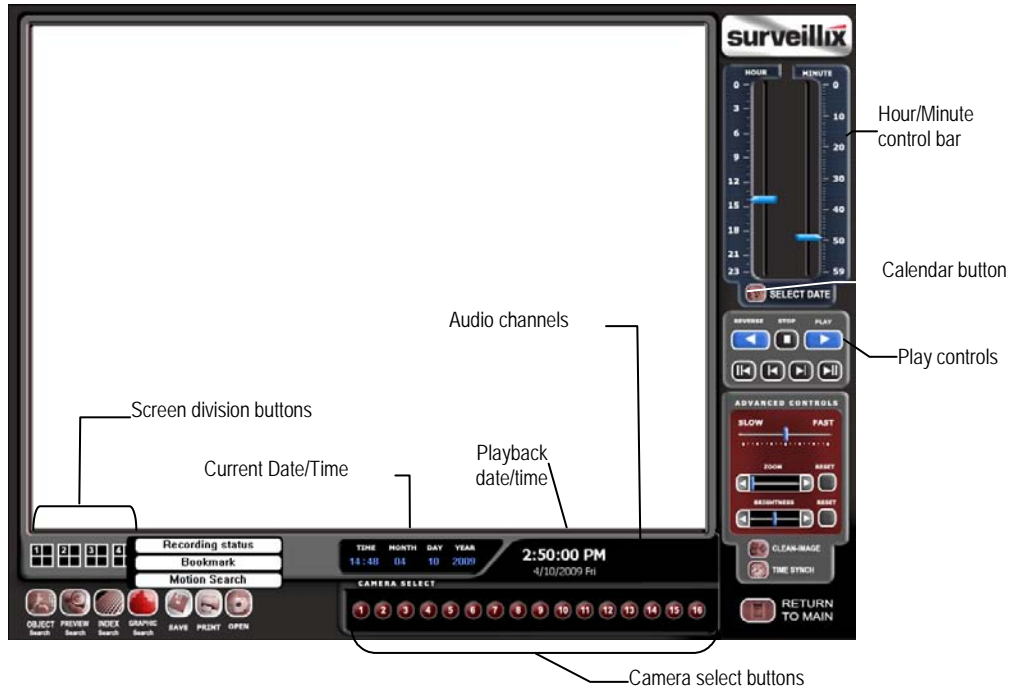

Note Audio Channel buttons are only viewable when one camera is selected.

Play Controls

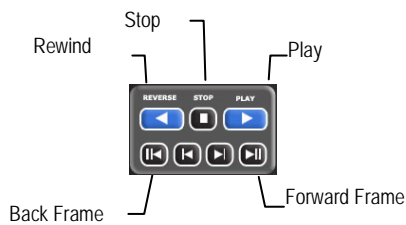

- Back Frame** Moves video back one frame
- Rewind** Rewinds video
- Stop** Stops video playback
- Play** Plays video
- Forward Frame** Moves video forward one frame

Adjust the Brightness of an Image

Select an image to adjust by double-clicking on the desired image. Multiple images cannot be adjusted at one time.

1. Move the Brightness slide bar to the right or left to adjust the brightness.
2. Reset the Brightness by moving the slider back to the center of the bar.

Zooming in on an Image

1. Select an image to adjust by double-clicking on the desired image. Multiple images cannot be adjusted at one time.
2. Move the Zoom slide bar to the right or left to zoom in or out of an image.
3. Reset the Zoom by moving the slider back to its original position on the bar.

Zooming in on a Portion of an Image

1. Right-click the area of interest on the image and select Zoom.
- or - Double-right-click the image.
2. Repeat to zoom in further.
3. Continue clicking the right mouse button and the image zoom will cycle back to the original size.

Open Video from a Saved Location

Previously saved video clips or backup files can be searched for content. Find file by date and time or by name.

1. Click **Open** to search for the saved file.
2. Select a file from the list of saved clips and backup files or search by start hour.
3. Click **OK** to open the saved file.

Time Sync

The Time Sync option synchronizes a single channel of video to playback in real time. Ordinarily the video may playback slower or faster depending on several factors, including how many IPS recorded and number of cameras playing at the same time.

1. Select a single image to synchronize by double-clicking on an image.
2. Click **Time Sync**. The video will now playback in real time.

Clean Image

The recorder is capable of recording video using one of three different resolutions. When using the 720 x 480 resolution, two fields are mixed. Because of the timing gap between the two fields, according to the standardized image rules, after image might occur to high speed moving images. The Surveillix recorder allows the user to remove this by clicking **Clean Image**.

PERFORMING A BASIC SEARCH

There are several different types of searches that can be performed on the recorder. The most basic involves selecting the date, time, camera, and clicking play.

1. Click the **Calendar** button to select a date.
2. Select a time by clicking the up and down arrows to the right of the time display.
3. Click **OK**.
4. Select one or more cameras.
5. Click **Play**. Video can be played forwards, backwards, or frame-by-frame.

PRINTING AN IMAGE

1. Using the Search screen, locate a frame to print.

Note Only one camera can be selected at a time for this function to work.

2. Click **Print**. A **Print Options** window appears. Depending on the printer being used, there may be several printing options available. Refer to the printer manual for more information.
3. Click **Print** to print the selected images.

Note The message NO DEFAULT PRINTERS INSTALLED will display if no printer is installed.

DAYLIGHT SAVING TIME

The recorder automatically adjusts for Daylight Saving Time changes. When the hour “jumps forward” no video is lost because an hour is skipped. However when the hour “falls back” there is a duplicated hour that under normal circumstances would be recorded over. The Surveillix recorder actually records both hours and allows the user to select which hour to play if the need arises.

To access the ‘lost hour’:

1. From the Search screen, click the **Calendar** button.
2. Select the date when Daylight Saving time ‘lost’ an hour. The Daylight Saving option appears.
3. To play back the ‘lost hour’, select Daylight Saving, select **02:00 (2AM)** for the time.
4. Click **OK** to confirm the date and begin playing the video using standard search features.

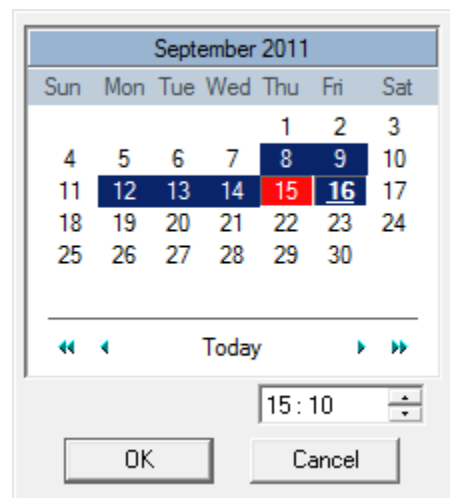

SAVE TO JPG OR AVI

The recorder can export single images in a JPG Image file format and save video clips in an AVI format. Both JPG and AVI file formats are the most commonly used graphical formats today. Virtually every computer offers some type of support for these file formats which make them the most ideal formats to use. Only one camera can be selected at a time for this function to work.

Image Images can be exported in **JPG**, **PNG**, or **BMP** formats. The **JPG** format is optimized for compressing full-color or grayscale photographic images (uses lossy compression, and will create a small file size). The **PNG** format is designed to maintain more quality while still compressing full-color or grayscale photographic images (uses a lossless compression, and will create a medium file size). The **BMP** format can be used for full-color or grayscale photographic images (uses little, or no compression, and will create a large file size). Use any of these options to export a single image or frame.

AVI AVI image data can be stored uncompressed, but it is typically compressed using a Windows-supplied or third party compression and decompression module called a codec. AVI is used to export a video clip.

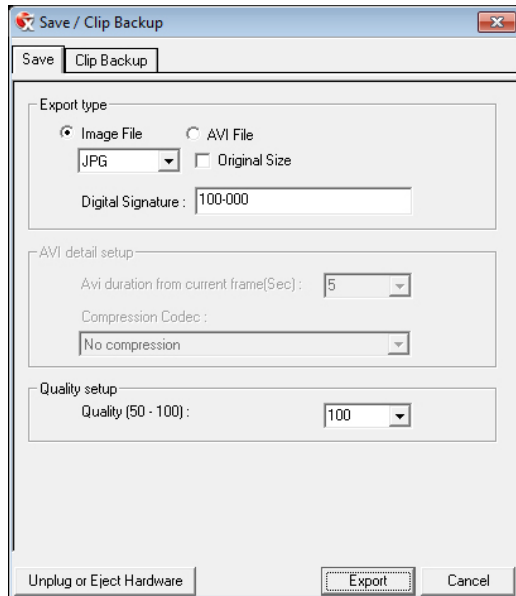

1. From the Search screen, click **Save**.
2. Select the **Export Type: Image File (JPG, PNG, or BMP) or AVI File**.

Image File

- a) Select **Quality (50-100)**. When size is not an issue, set the quality to 100.

AVI File

- a) Enter the **duration** (in seconds) to save. Although suggestions are provided, a selection between 1 and 3600 can be entered manually.
 - b) Select a **Compression Codec**. Each codec provides different levels of quality, compatibility and file-size.
 - c) Select **Quality - 50>100**. When size is not an issue, set quality to 100.
3. The digital signature is already entered, but can be changed if required.
 4. Click **Export**.
 5. Select a location to save the file, enter a name for the file, and click **Save**.
 - c. Clicking **Cancel** will exit the window without exporting file.

Bookmarks

Use bookmarks to mark a video clip during a search. Export bookmarked data using the Clip Backup feature.

1. Perform a search for the desired video.
2. Stop playback at the beginning of the desired clip.
3. Right-click the video and select **Start Bookmark**.
4. Click the **Play** button to continue playback.
5. Stop playback at the end of the desired clip.
6. Right-click the video at the desired end point and select **End Bookmark**.
7. Type a name to identify the bookmark in the **Title** box.
8. Enter a memo or notes in the **More Information** box.
9. You may also select additional channels to include video at different locations recorded at the same time.
10. Click **Create**.

The 'Create bookmark' dialog box features a 'Select bookmark channel' section with a list of 10 channels (Cam 1 to Cam 10) and their respective positions. Cam 1 is selected. To the right is a 'Title' text box and a 'More Information' text area. Below the channel list are 'All', 'None', and 'Reverse' buttons. At the bottom, there are 'Bookmark start time' and 'Bookmark end time' fields, both set to 9/15/2011 3:10:00 PM and 3:10:03 PM respectively. 'Create' and 'Cancel' buttons are at the bottom right.

Modify Bookmarks

You can modify a previously created bookmark to change the start or end time of the clip, add additional comments, change the title, or add additional cameras.

1. From the Search screen, click **Bookmark**.
2. On the calendar, select the date the desired bookmarks were created.
3. Select the desired bookmark from the list.
4. Make the desired change.
5. Click **Modify**.
6. When the modification is complete, click **Cancel** to close the window.

The 'Bookmark search dialog' window includes a calendar for 'September 2011' with the 15th highlighted. Below the calendar is a list of channels (Cam 1 to Cam 11) and their positions. To the right is a table with 'Index' and 'Title' columns, showing one entry: '1 Bookmark1'. Below the channel list are 'All', 'None', and 'Reverse' buttons. At the bottom, there are 'Start Time' and 'End Time' fields, both set to 5:56:56 PM and 5:58:00 PM respectively. 'Move', 'Modify', 'Delete', and 'Cancel' buttons are at the bottom right.

Clip Backup

Within the Save option, Clip Backup can also be utilized to backup a single camera or multiple channels. The Clip Backup option gives you the ability to choose a backup time frame, choose a specific camera or cameras, add memos, and even include the Backup Viewer if needed.

1. From the Search screen, click **Save**.
2. Select the drive from the file tree to save data to (Hard disk drive, removable drive (USB), CD/DVD drive).
3. Select desired cameras from the list.
4. Define the **Start** and **End** time and date that you wanted to backup.
5. Select **Include Viewer** to include a copy of the proprietary Backup Viewer Software to view the clip on virtually any Windows workstation.
6. Click **Add Memo** to include additional information.
7. Click **Backup** to start the backup.

Note If backing up to a removable USB device click the Unplug or Eject Hardware button after backup is complete to safely remove the device.

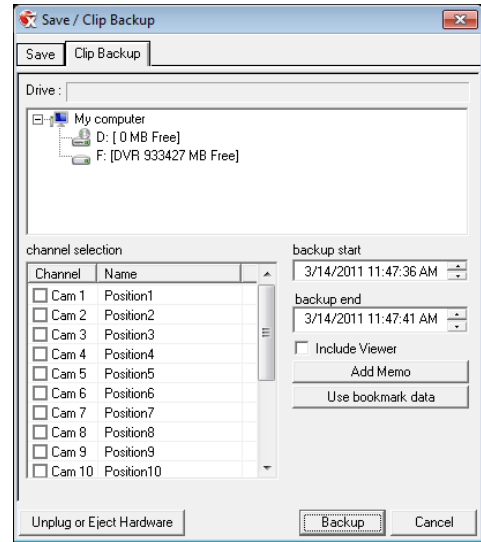

Single Clip Backup Using Bookmark Data

1. From the Search screen, click **Save**.
2. Select the drive from the file tree to save data to. (Hard disk drive, removable drive, CD/DVD drive).
3. Click **Use Bookmark Data**.
4. On the calendar, select the date the desired bookmarks were created.
5. Select the desired bookmark from the list.

Note To include multiple bookmarks in a clip backup, select the Multi Backup check box before selecting the desired bookmarks.

6. Select **BV Copy** to include a copy of the proprietary Backup Viewer software to view the clip on virtually any Windows workstation.
7. Click **Start Backup** to start the backup.

Note If backing up to a removable USB device click the **Unplug or Eject Hardware** button after backup is complete to safely remove the device.

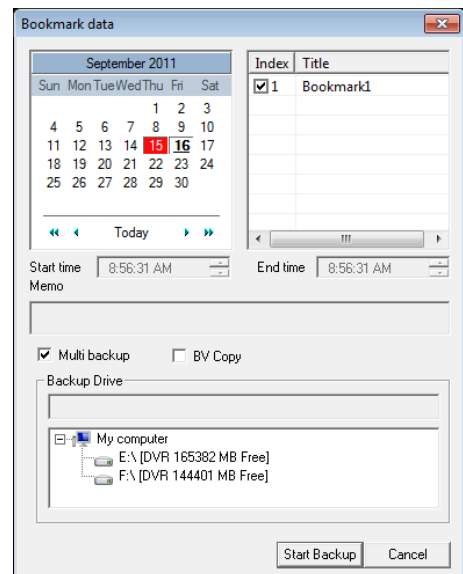

INDEX SEARCH

Using the Index Search can greatly decrease the amount of time spent searching through saved video. The Index Search allows you to perform a search based on criteria such as Sensor, Motion and Instant Record events.

Performing an Index Search

1. Click the **Calendar** button on the Search screen to select the date to search.
2. Click **Index Search**.
3. Select the cameras and sensors to include in the search.
4. Select the **Select Time** check box to define a specific period.
5. Select an event type to search (**Sensor**, **Motion**, **Instant Record**) or select the **All Event** option.
6. Click **OK**. There may be a delay while results are returned. Results will be displayed in a column on the right side of the screen – Each line represents a segment of video. If no results are found, "NO IMAGE FOUND" will appear in the column.
7. Once the results are displayed, double-click any one to play the associated video.
8. Once the desired image is found, apply it to the Main Search by clicking **Close** at the bottom of the results column.

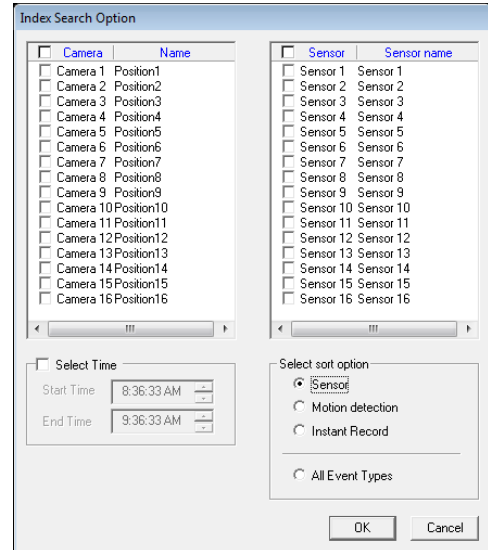

Index Search Results Display

Image Display Area

Event Recorded on Camera #

Time Event Occurred

Event Type:
M – Motion
S – Sensor
IR – Instant Record

Time	Camera	Type
08:34:21	C01[Back R	M
08:35:34	C01[Back R	M
08:36:17	C01[Back R	M
08:36:38	C01[Back R	M
08:37:17	C01[Back R	M
08:38:49	C01[Back R	M
08:39:31	C01[Back R	M
08:40:31	C01[Back R	M
08:42:12	C01[Back R	M

The image shows a software interface with a video player on the left and a list of search results on the right. An arrow points from the first row of the results table to the video player, which displays a street scene with a red car. The results table has columns for Time, Camera, and Type, with small icons next to the Type column entries.

PREVIEW SEARCH

Preview Search can be used in a number of circumstances to quickly find an exact moment where an event, such as a theft, occurred. The Preview Search gives a 24 Hour visual overview of a single camera by separating a 24 hour period (1 day) into 24 images, one image for each hour of the day. The search can then be further narrowed down into ten minute increments and one minute increments by selecting one of the images displayed.

These example images show how the Preview Search functions.

The first screen that appears has 24 images displayed. Each image represents the first second of recorded video in each hour. If there is no image recorded during that period then nothing will be displayed.

When an hour is selected (by double clicking on the image), a new screen appears with 6 images. Each of these images represents the first second of video for a 10 minute segment of video within the selected hour.

Once a 10 minute segment is selected (by double-clicking on the image) the final screen appears which breaks down that 10 minute segment into 1 minute increments (10 images).

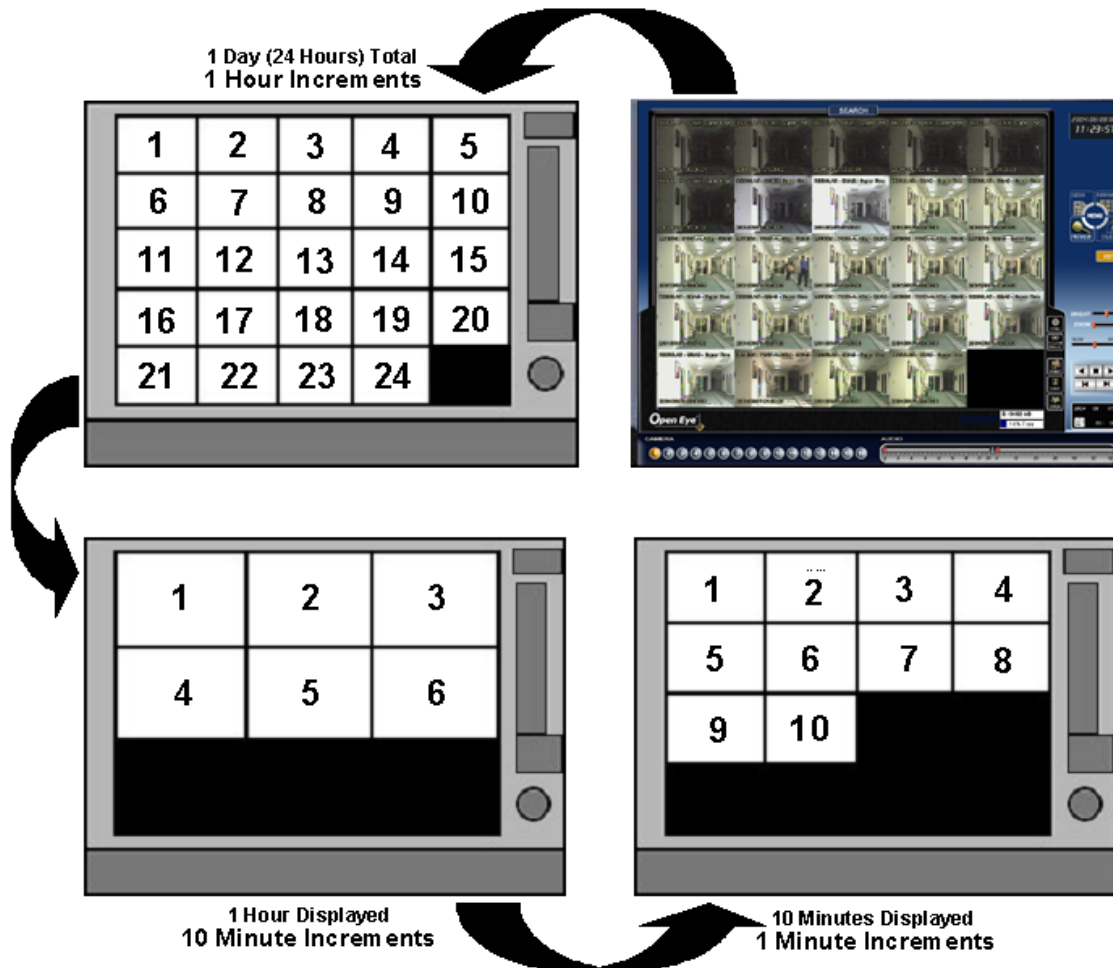

Performing a Preview Search

1. Select a single camera channel.
2. Click **Preview**. 24 images display. If there is no recorded video during a portion of the day, "No Image" will be displayed where the image would be.
3. Refine the search by double-clicking on an image to select it. 6 images display. If needed, return to the previous 24-image view by double-right-clicking on any image.
4. Refine the search by double-clicking on an image to select it. 10 images display. If needed, return to the previous 6-image view by double-right-clicking on any image.
5. Double-click an image to select the 1-minute segment of video to play. A single image displays. If needed, return to the previous 10-image view by double-right-clicking on the image.
6. Use the **Play** controls to play the video of the selected segment.
7. To exit out of the **Preview** search with the current image still selected, click **Preview** again.

GRAPHIC SEARCH

The Status Search option displays video in graph format.

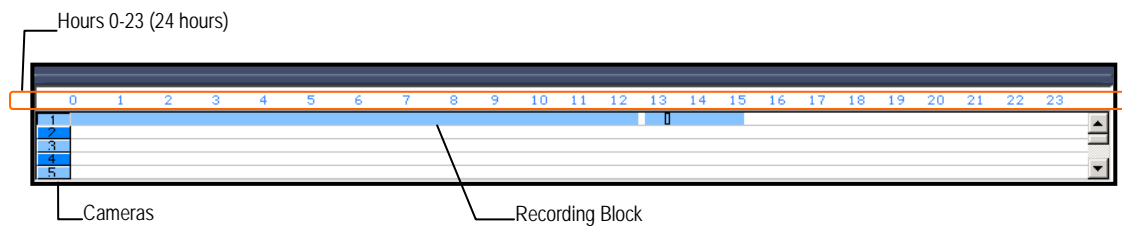

Performing a Graphic Search

1. Click **Graphic Search** on the Search screen.
2. Click the calendar icon to select a day.
3. Click on an area of the blue recording block. Only one camera can be displayed at a time.

Note Each recording block represents a 10 minute time frame.

4. Recorded video from the corresponding camera and time block will display above.
5. Use the mouse or arrow buttons to move through recording blocks and view video.
6. To exit out of **Status** search with the current image still selected, click **Status** again.

OBJECT SEARCH

Object Search is a powerful search utility that is used to search a region on the video for any motion changes. Results are neatly displayed and can be viewed quickly.

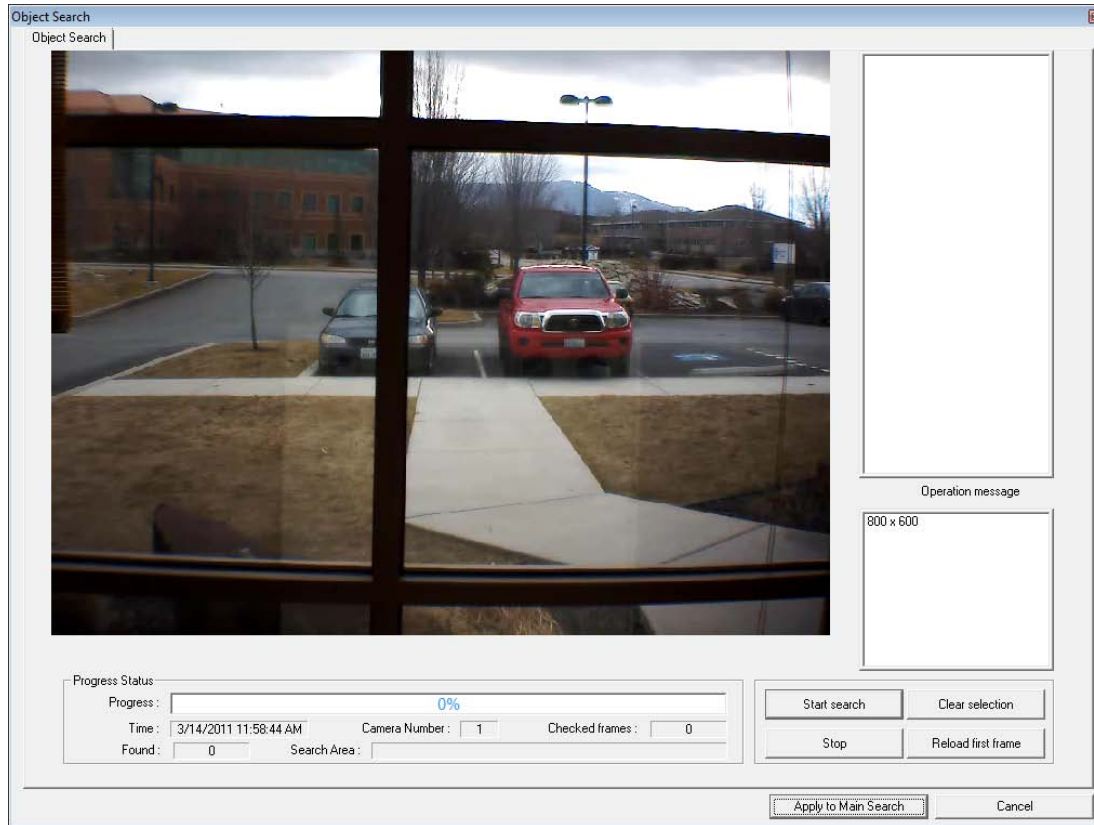

Performing an Object Search

1. Select a single camera channel.
2. Click **Object Search**.
3. Click and drag the mouse on the video display to define a motion region area. Resize by pulling on the small square boxes located on the outer perimeter of the area.
4. Click **Start Search**, the **Object Search Filter Information** window will open
5. Select an **End** date/time.
6. Adjust the sensitivity if necessary.
7. Click **OK**.
8. Select a motion event from the search results list displayed on the right
9. Click **Apply to Main Search** to display the selected image in the main **Search** screen and to use play controls.
10. To start a new object search using the original image, click **Reload First Frame**.
11. To exit **Object Search** without selecting an image, click **Cancel**.

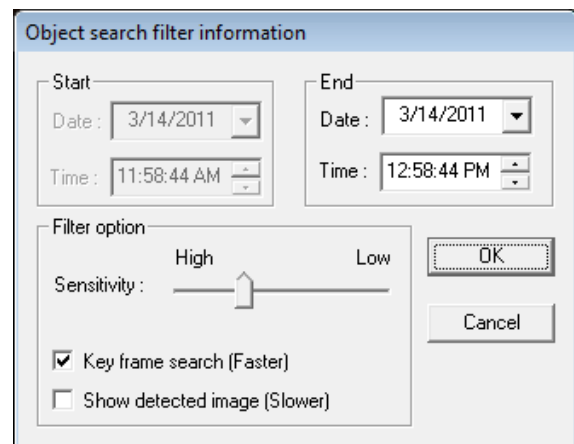

MOTION SEARCH

The Motion Search provides a dynamic display of the levels of motion in recorded video. Adjust the level of motion to only play clips of video at or above that level.

To enable motion data to be saved for Motion search, ensure that you select the following settings:

1. On the Motion setup page under Motion Regions, select **Detect Detail Motion Area**.
2. On the General setup page under Display, select **Motion Detect on Continuous Recording**.

Note Motion Search is only available for newly recorded video; it is not compatible with video recorded prior to installing version 3.6.

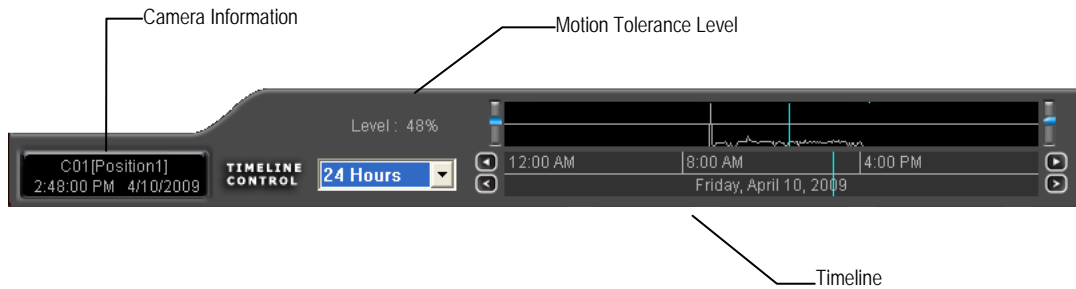

Performing a Motion Search

1. Select a single camera channel.
2. Click **Motion**.
3. Click the calendar icon to select a day.
4. Adjust the motion level line.
5. Adjust the timeline display settings.
6. Click the play button to start playback.
7. To exit out of **Motion** search with the current image still selected, click **Motion** again.

Tip You can drag the blue line on the Timeline or motion level box to adjust the time.

AUDIO PLAYBACK

Audio is played back at 48,000Hz.

To play audio with the video:

1. Select a single camera channel. The audio options will be displayed in the lower right.
2. Select a single audio channel to play. When an audio channel is selected, the **Time Sync** button will be automatically selected.
3. Click **Play**.

SEARCH IN LIVE

The Search in Live feature allows users to review events immediately while monitoring live video. Pause, rewind, and resume live video within seconds of an alarm event or suspicious activity.

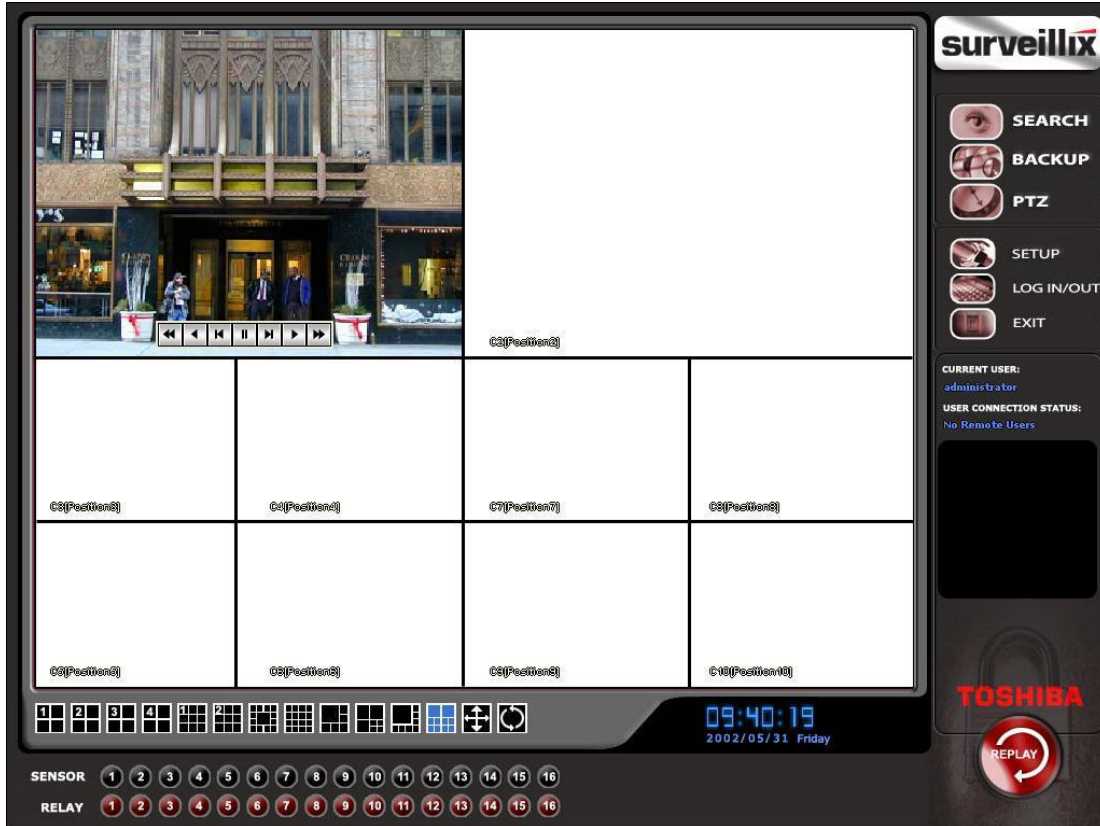

1. Move the mouse cursor over the desired live video display on the Live Display screen.
2. Right-click and choose **Search In Live** (or click the scroll wheel on the mouse).
3. The Search In Live controls will display at the bottom of the image.
4. Use the controls to pause, rewind, move frame-by-frame or resume playing as desired.



5. To exit Search in Live, right-click the camera channel again and choose **Search In Live** (or click the scroll wheel on the mouse).

PAN / TILT / ZOOM

This chapter includes the following information:

- Overview
- Setting up the PTZ
- Creating and Viewing a Preset Position
- Creating and Viewing a Preset Pattern

PAN /TILT / ZOOM OVERVIEW

The PTZ controls within the recorder allow for powerful control over the cameras. This can be extremely beneficial to you by increasing the usefulness of the recorded video. Using the PTZ controls, you can create custom preset configurations that can continuously sweep across large areas.

Note PTZ setup and control is only available for supported video encoders with a PTZ RS-485 pass-through.

Enable the PTZ Settings

1. Inside the recorder PTZ Setup, select the PTZ camera using the **Camera Channel** list.
2. Enable the PTZ functions of the camera by selecting the **Enable Pan/Tilt** check box.
3. Select the appropriate Protocol and set the PTZ Driver Address and Serial Port Settings (See Advanced PTZ Setup in this chapter).

Note The majority of major PTZ manufacturer protocols are included in this software. Refer to the Supported Protocols list in this manual.

4. Click **Apply**, then click **Exit**.
5. From the Display screen, click **PTZ**. The PTZ Controller will open.
6. Select the PTZ camera to control by clicking on the display screen. The camera number will appear inside the PTZ controls.
7. You can now move the PTZ camera using the PTZ controls.

ADVANCED PTZ SETUP

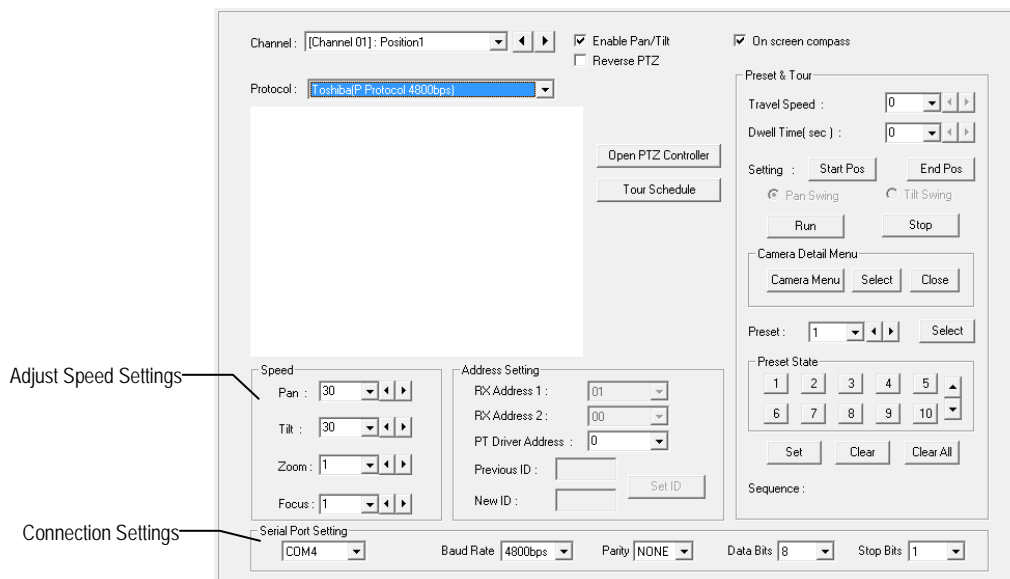

Note Preset and tour options may vary depending on the camera

Creating and Viewing Preset Positions

A Preset Position is a user-defined location where the camera can be pointed, zomed-in, and focused. Preset positions can be defined and labeled if the camera supports this.

Creating a Preset

1. Inside Setup, click **PTZ** and select the camera.
2. If the camera is already selected, click **Open PTZ Controller**.
3. Move the selected camera to the desired position using the **Pan/Tilt/Zoom/Focus** controls.
4. In the **Preset & Tour Detail** section, choose a **Preset #** (1-10) using the list or the Right and Left Arrow buttons and click **Select**.

Note Preset positions can be created using the advanced buttons on the PTZ graphical controller.

Viewing a Preset

1. From the Display screen, select the PTZ camera by clicking on it.
2. Using the keyboard, click the number keys corresponding with the Preset Positions. The camera will move to the saved Preset.

PTZ Address Settings

- Some protocols support software address settings.
- The RX-Addresses and ID settings are compatible with a particular line of receivers that support 2 ID addresses.
- The PT Driver Address is associated with the PTZ ID address set on the camera. The addresses must match for the recorder to communicate with the proper PTZ camera. This is especially important when a large number of PTZ cameras are connected to the recorder.

Note To select a PT Driver Address of 129-256, manually enter the ID in the box.

ACCESSING PTZ MENUS

- Some protocols support the ability to access the Internal PTZ Onscreen menu.
- Since every PTZ camera is different, the function of these options can vary slightly.
- The Surveillix recorder provides an easy way to access the camera options. For explanations of what those options are, please refer to the user manual for the camera.

Note Use the arrow buttons on the PTZ controller to move through the PTZ menu options and/or highlight options.

CONTROLLING A PTZ CAMERA

Surveillix recorders provide control for a PAN/TILT/ZOOM camera in two different ways.

- Use the Graphical PTZ Controller that appears when the PTZ button is clicked on the Display screen.
- Use the mouse to control the camera directly from the live video display (On-Screen Compass)

Using the Graphical PTZ Controller

1. Use the Arrow buttons to control the direction of the PTZ camera.
2. To select a new camera, click the video display of a different camera on the Display screen display.

Note Eight directions are available only for select cameras. Only four of the PTZ Control buttons work for all protocols (UP, DOWN, LEFT, RIGHT).

Note The Advanced menu panel on the graphical PTZ controller can be used to set PTZ preset positions (on supported cameras), as well as move to presets up to 254.



Using the On-Screen Compass

1. Click **Setup** on the Display screen.
2. Click **PTZ**.
3. Select the **On Screen Compass** check box to enable the feature.
4. Click **Apply**.
5. Click **Exit** to return to the Display screen.
6. Click **PTZ**.
7. Control the PTZ by dragging the mouse on the screen in the desired direction.

Note A green line will appear to show the direction in which the PTZ camera will move. The shorter the line, the less the PTZ will move. The longer the line, the more the PTZ will travel in the specified direction.



Understanding Tours

Travel Speed – The speed between one Preset Position to the next

Dwell Time – The length of time (in seconds) that a PTZ Tour displays a Preset Position

Setting: Start Pos / End Pos – Define a Mimic Tour. The Start Position button begins the recording process. The Stop Position ends it.

Pan Swing / Tilt Swing – This option enables the Horizontal (Pan) or Vertical (Tilt) Guard Tours.

Run / Stop – Runs the selected Pan or Tilt tour



PTZ Tour Schedule

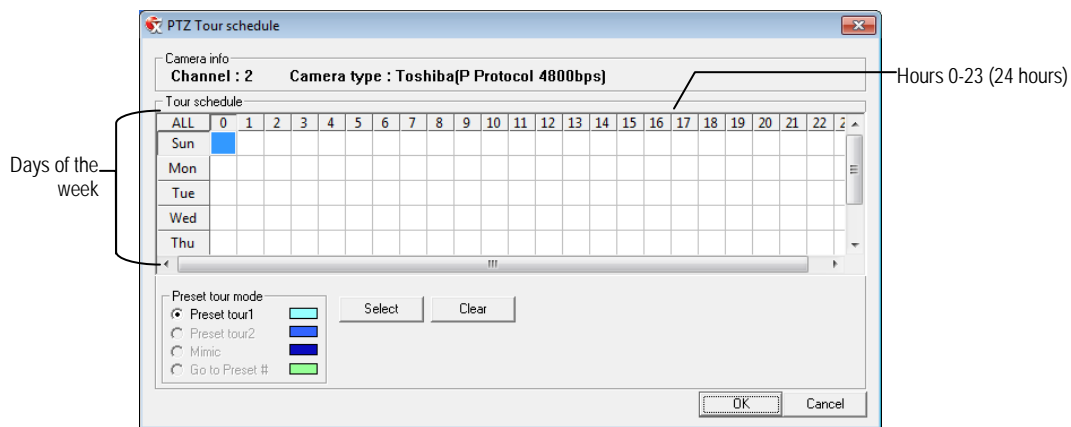

1. Click **Setup** on the Display screen.
2. Click **PTZ**.
3. Select the desired PTZ camera channel from the **Channel** list.
4. Click **Tour Schedule** to open the **PTZ Tour Schedule** window.
5. Click and drag the pointer to select blocks of time (hours 0-24) on the desired days of the week.
6. Click **Select**.
7. When finished, click **OK** to save changes and close the window

BACKING UP VIDEO DATA

This chapter includes the following information:

- Overview
- Saving Video to a DVD
- Saving Video from a Single Camera
- Scheduling Regular Video Backup

BACKUP OVERVIEW

The Backup Center allows you to back up recorded video data from multiple dates and times to one or more locations including the DVD-RW drive, Network Storage Locations, and External Hard Drives.

The recorder can easily backup important video data to an internal or external media location. The most commonly used forms of this are CD-Rs, DVD-Rs, External USB or FireWire Hard Drives, and Network Drives. Every recorder comes equipped with a DVD-RW drive, USB port, and Network Adapter.

The recorder is capable of performing a backup to multiple CD/DVDs when the file sizes exceed the capacity of a single disk. You may also specify multiple locations for backup as well as the order they are recorded to.

The recorder backs up video data using a proprietary compression format that can only be read by the Surveillix Backup Viewer software. This ensures the integrity of the data.

Throughout the backup process the recorder will continue recording data without interruption. This is the result of the tremendous multiplexing power of the recorder, which allows it to perform virtually all functions without disrupting the recording process.

Nero® Express

The recorder uses Windows® 7® Embedded running Nero® Express 9.0 to write data to the DVD-RW Drive. This solution allows the recorder software to read and write data to the DVD-RW Drive without formatting the disk first.



Caution

Although many features are available within Nero, it is highly recommended that you do NOT use any features other than those necessary for the standard backup of video data as outlined in this section, loss of information or software instability may result.

General Screen Overview

The General Backup Screen is used for performing bulk backup of video recorded by all cameras for a selected period, or periods, to a specified storage location.

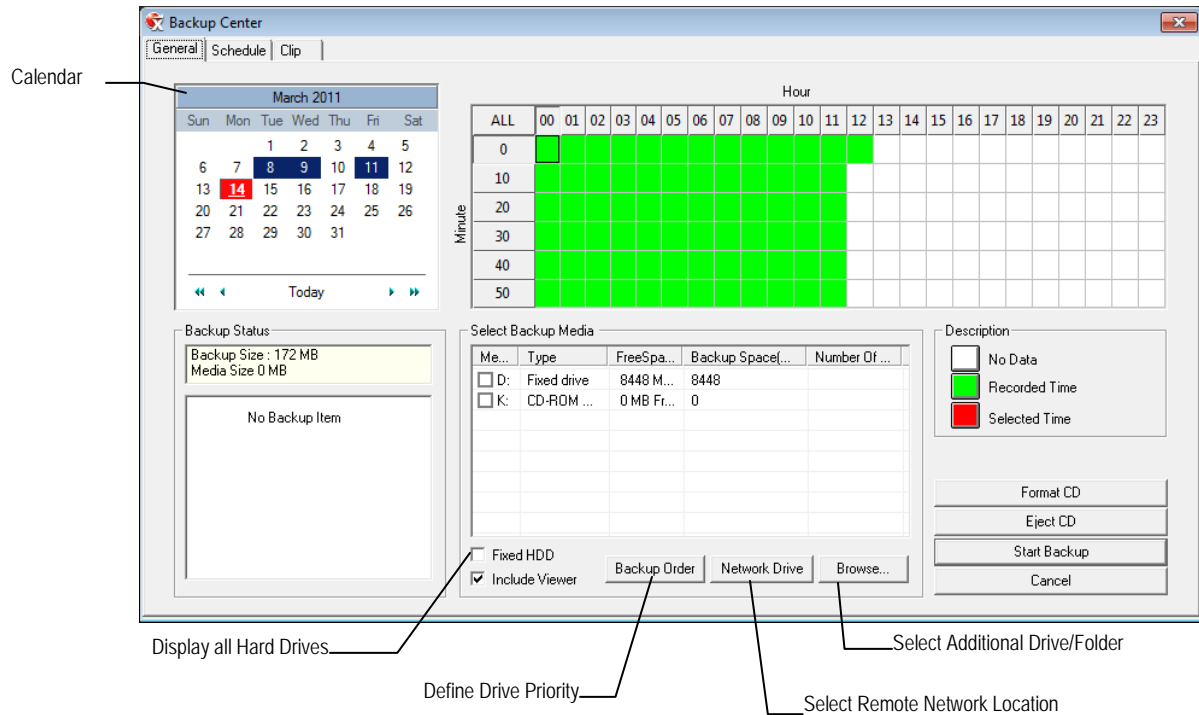

Hour / Minutes

Recording data displays in hourly (24 vertical columns) and 10-minute (6 horizontal rows) segments. Green cells indicate time with recorded video. Red cells indicate time selected for backup.

Backup Status

Displays the size of all video currently selected for backup, the available size of the media currently selected for backup to, and the dates and times of video currently selected for backup.

Fixed HDD

Display all Hard Drives

Performing a General Backup

1. Click **Backup** on the Display screen.
2. Select the date or dates to back up using the calendar. Dates highlighted in blue contain recorded data.
3. Select the blocks of time to back up using the Hour/Minute grid. Blocks of time with recorded video are highlighted in green. Blocks of time selected for backup are highlighted in red.
4. Select the backup drive or drives under **Select Backup Media**, or click **Network Drive**, or **Browse**. When selecting the CD-ROM drive you must specify the number of CDs to use for backup.
5. Click **Backup Order** to set the backup order.
6. Select the **Include Viewer** check box to include the Backup Viewer Application.
7. Click **Start Backup** to begin the backup process. A progress bar will be displayed in the lower right corner of the Display screen.

Clip Screen Overview

The Clip Screen is used for backing up video recorded by individual cameras for a selected period of time to a specified storage location

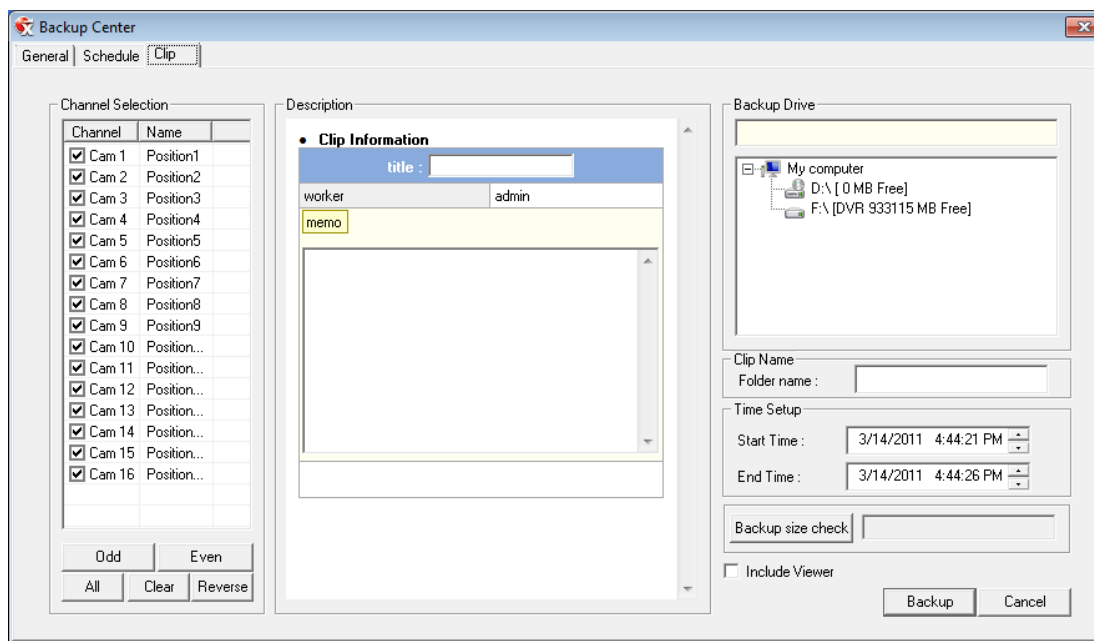

Performing a Clip Backup

1. Click **Backup** on the Display screen.
2. Click the **Clip** tab at the top of the Backup Center window.
3. Set the **Start Time** and **End Time** under **Time Setup**.
4. Select the cameras to back up in the **Channel Selection** box.
5. Select the **Backup Drive** to save the backup video to.
6. Type the **Folder Name** for the clip files under **Clip Name**.
7. Select **Include Viewer** to include the Backup Viewer software.
8. Enter pertinent clip information into the **Clip Information** section in the Description box.
9. Click **Backup Size Check** to confirm the file size of the clip backup.
10. Click **Backup** to begin the backup process. A progress bar will be displayed in the lower right corner of the Display screen.

Scheduled Screen Overview

The Scheduled Backup Screen is used for performing bulk backup of video recorded by all cameras on a regular scheduled basis (1-24 hours). The Scheduled Backup Screen is similar to the General Backup Screen.

Performing a Scheduled Backup

1. Click **Backup** on the Display screen.
2. Click the **Schedule** tab at the top of the Backup Center window.
3. Select the blocks of time to back up using the **Hour/Minute Grid**. Blocks of time with recorded video are highlighted in green. Blocks of time selected for backup are highlighted in red.
4. Set the **Backup Time** to perform the backup.
5. Set the **Repeat Backup(Daily)** time to specify the number of hours between backup procedures (between 1 and 24 hours).
6. Select the **Backup Drive** to save the backup video under **Select Backup Media** or click **Network Drive**. To save to a local drive or partition you must first rename the location "BACKUP".
7. Select **Overwrite on Disk Full** to overwrite previous backup files when the disk becomes full.
8. Click **Save Backup Setting** to save the current backup setting and return to the Display screen.

Specifying Scheduled Backup Drives

In order to use the Scheduled Backup feature one or more storage drives or partitions connected to the recorder must be specified as a backup drive.

1. From the Display screen, click **Exit** and choose **Restart in Windows Mode**.
2. Double-click **My Computer**.
3. Right-click on the drive to specify as a backup drive for Scheduled Backup and click **Rename**. Rename the drive to 'Backup'. Repeat this process for all drives to use for Scheduled Backup. To remove a drive from use for Scheduled Backup, change its name to something other than 'Backup'.
4. Restart Surveillix and return to the **Schedule** tab in the **Backup Center** window.

Note The C: Drive CANNOT be used as a backup location; this is done intentionally to protect the operating system.

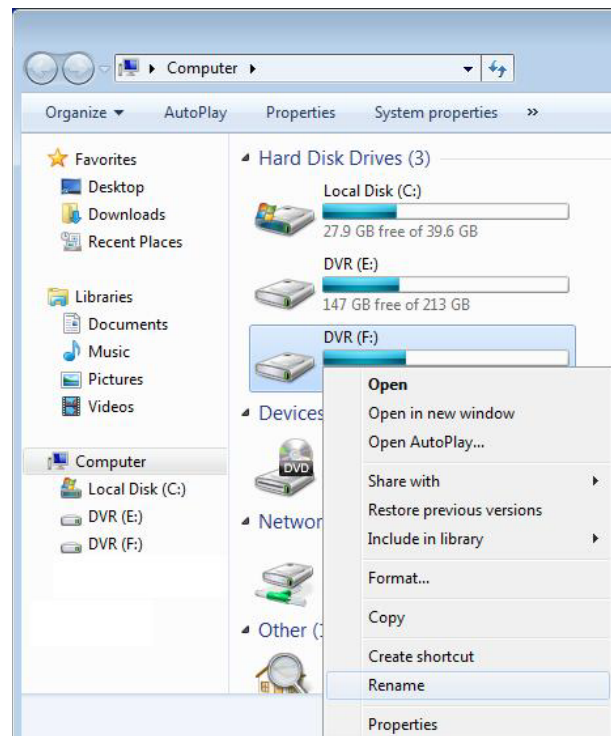

LAN / ISDN / PSTN CONNECTIONS

This chapter includes the following information:

- Overview
- Configuring TCP/IP Settings
- Connecting to a LAN
- LAN / ISDN / PSTN Connections

LAN OVERVIEW

The recorder can be easily connected to a Local Area Network (LAN) and uses Microsoft's® powerful and secure Windows® 7 Embedded operating system. This allows for easy and well-documented instructions on setting up LAN connections no matter what type of LAN you want to use.

A LAN is a group of computers and other devices dispersed over a relatively limited area and connected by a communications link that allows one device to interact with any other on the network.

There are many reasons why using Microsoft® Windows® 7 Embedded is superior to other platforms when running on a LAN. The number one reason is security. Windows 7 Embedded is based on the Microsoft's Windows platform, which, historically has boasted the most reliable and secure operating system in the world. Running the recorder on a secure network is important to prevent unwanted users from gaining access to confidential information. Unwanted users can compromise the integrity of the confidential data being stored and viewed, and in extreme circumstances can cause irreparable damage to the network.

Since connecting the recorder to a network can be extremely complex (depending on the network), this Surveillix recorder manual will cover only the basics. It is suggested that the recorder administrator consult the Vendor or IT Administrator before attempting to create or connect to a LAN.

CONNECTING TO A LAN USING TCP/IP

The networking options of the recorder can be created and modified via the standard networking options available on Windows 7 Embedded. The recorder comes equipped with a 10/100/1000 Network Interface Card (NIC). This card uses a standard RJ-45 connector, and should be connected using CAT5 Ethernet cable to achieve optimal communication speeds.

Configuring TCP/IP Settings

1. On the Display screen, click **Exit** and select **Restart in Windows Mode**.
2. Right-click **Network** on the desktop and select **Properties**.
3. Click **Local Area Connection**.
4. Click **Properties**.
5. Select **Internet Protocol Version 4 (TCP/IPv4)**, then click **Properties**.
6. Select **Use the Following IP Address** option. Enter the **IP Address** and **Subnet** mask appropriate for the network. It is recommended to contact the Network Administrator for appropriate IP settings.

- Example:**
- a. Common IP addresses are 192.168.0.25 or 10.0.0.25
 - b. Common Subnet masks are 255.255.255.0 or 255.0.0.0

Note In order to connect to the recorder through a remote LAN connection, a static IP address must be assigned. If the network assigns the IP address automatically (DHCP), contact the Network Administrator for help assigning a static IP address.

7. If the network requires you to specify the DNS information, enter it now by selecting the appropriate DNS options.
8. When finished configuring the TCP/IP settings click **OK** to close the **Internet Protocol (TCP/IP) Properties** window.
9. Click **Close** and then **Close** again to close both **Local Area Connection Properties** windows.

LDAP INTEGRATION

This chapter includes the following information:

- Installing LDAP

FEATURES

The instructions below are for LDAP with Server Software version 3.6.36 and above.

- The recorder server does not need to be joined to the Domain. The recorder server will query the LDAP server for accounts and authorization levels.
- The recorder server creates groups within LDAP for each of the permissions on the recorder. Simply join a Domain user to these groups to provide access to that function in the recorder.
- Recorder access within LDAP is based on the Site Code within the recorder software. This allows an administrator to group recorders with the same Site Code.
- Remote and Multi-Site management software works with LDAP logins.

INSTALLING ACTIVE DIRECTORY

Required Items

- Name of LDAP server.
 - Account in LDAP server that has Domain Admin rights. This user will be used initially to create the OU's and Groups within LDAP.
1. Verify that the recorder server is connected to a network that has a valid LDAP server.
Ensure that the TCP/IP settings are configured correctly for DNS resolution and gateway if needed.
Check to verify that you can ping the LDAP server without issues.
 2. Set up DVR Site Code to be used for LDAP authorization. The default will be 100-000. This site code can be used to group recorders together within LDAP.
 - a) Log in to the recorder using the local recorder administrator account (non-Active Directory).
 - b) Navigate to the **Setup -> Information** tab and change the **Site Code**.
 3. Log on to the recorder server with the domain account with administrator privileges (see above required items).
If successful, the recorder will log the administrator user on without any error messages. You may log off the recorder once this is completed without errors.

Note If you encounter an error please verify that the above required items are correct.

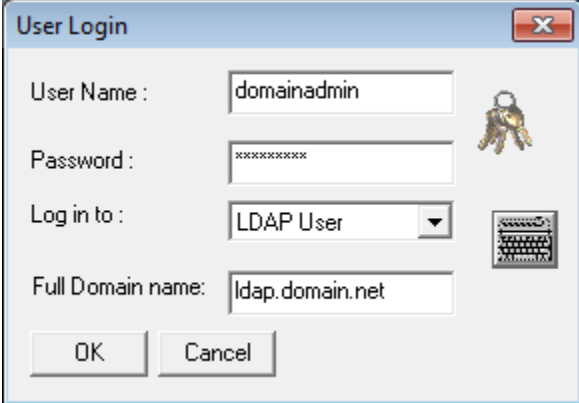

The screenshot shows a 'User Login' dialog box with the following fields and values:

- User Name : domainadmin
- Password : [masked]
- Log in to : LDAP User
- Full Domain name: ldap.domain.net

Buttons: OK, Cancel

- Go to the Active Directory Users and Computers application. You should now see an OU called DVR with an OU inside of it named the same as the Site Code above (example 100-000).

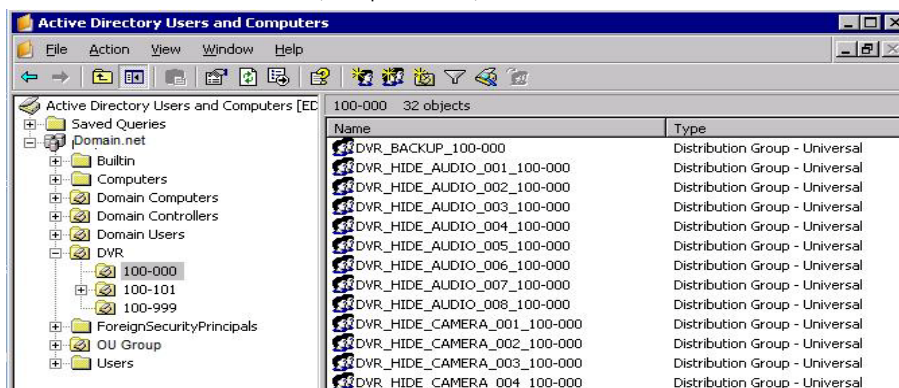

- You can now add users within Active Directory to the groups the recorder has created. When a user belongs to a group he or she will have access (or be denied access in the case of Audio or Camera channels) to that permission on any recorders with that site code.

Group	Description
DVR_BACKUP_100-000	Backup access to DVRs with site code 100-000
DVR_HIDE_AUDIO_0XX_100-000	Hides audio channel XX for site code 100-000
DVR_HIDE_CAMERA_0XX_100-000	Hides camera XX for DVRs - site code 100-000
DVR_INSTANT_100-000	Instant recording access to DVR
DVR_PTZ_100-000	PTZ access to DVRs - site code 100-000
DVR_PTZEX_100-000	Access to advanced PTZ control
DVR_RELAYOUT_100-000	Access to toggle relays from live view
DVR_SEARCH_100-000	Access to search on DVRs - site code 100-000
DVR_SETUP_100-000	Access to setup on DVRs - site code 100-000
DVR_SHUTDOWN_100-000	Grants the ability to shut down the DVR server

Note The above site codes may be different depending on what site code the recorder server had when it was logged into LDAP.

- You can now log in to the recorder server using any of the Active Directory users who belong to one of the above groups.

WEB VIEWER

This chapter includes the following information:

- Overview
- Configuring the Web Viewer

WEB VIEWER OVERVIEW

The recorder allows you to access video using Microsoft® Internet Explorer® 7 and above.

Highlights:

- View Live Video from most computers
- Username and Password protected
- Easy to use graphical interface

Basics:

75 users can access the Web Viewer simultaneously (if network bandwidth allows). The Web Viewer is an easy, secure way to view live video from virtually any computer with an internet connection using Microsoft Internet Explorer.

In order to log in to the recorder server, a user account must be made for the user. This ensures that only authorized personnel are allowed to log in. In addition, each user can be assigned different privileges that allow them or deny them access to different cameras. For example: a user can be granted access to only view cameras 4, 8 and 16.

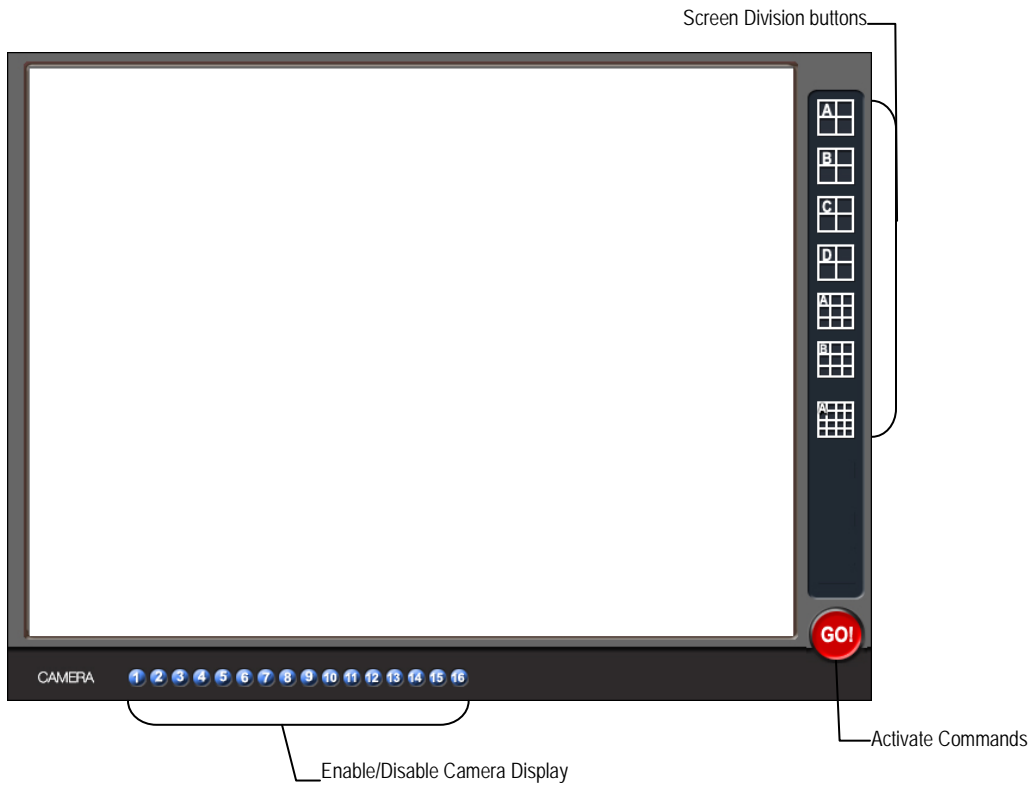

Configuring the Server for Remote Connection

1. From the Display screen, click **Setup**.
2. Click **Network**.
3. Ensure that **Disable Remote Control** is cleared.

Note If you are using a Firewall, it may be necessary to adjust the port settings on both the recorder and the Firewall. Contact the Network Administrator for more information.

4. Select **Web Viewer (iDVR)**.
5. Click **Apply**.

Note If no additional user accounts have been created the administrator account will be the only account that can connect to the recorder remotely.

6. The recorder server is now ready to receive incoming connections from Remote Software, SCS, MDVR, or the Web Viewer.

Connecting to a Recorder Using Web Viewer

1. Open Microsoft Internet Explorer.
2. Enter the IP address of the recorder into the Address Bar.
3. When attempting this for the first time on a workstation a prompt will ask you to accept an ActiveX installation. Select **Yes**.

Note If you receive a message saying Internet Explorer® security settings do not allow you to download ActiveX components then you will need to adjust the browser security settings. One way to do this is to add the IP address of the recorder to the trusted sites list inside Internet Explorer® settings. Contact the System administrator for additional help with adjusting Internet Explorer settings.

4. When the Web Viewer finishes loading, click **GO!**
5. A login window will appear. Enter the **Username** and **Password** of an authorized user.
6. The cameras will display.

Closing the Web Viewer

To exit the Web Viewer close Internet Explorer.

INCLUDED SOFTWARE SETUP

This chapter includes the following information:

- The Surveillix App Overview
- Emergency Agent Overview
- Remote Software Overview
- Digital Verifier
- Backup Viewer

THE SURVEILLIX APP OVERVIEW

The Surveillix App software, available for iPhone, Android, and Blackberry, allows you to access your Surveillix recorder from almost anywhere on your mobile device. The Surveillix App gives you the ability to view live video from your cameras using a simple interface.

For a list of supported models, installation instructions and download links, go to http://www.toshibasecurity.com/mobile_apps.jsp

EMERGENCY AGENT OVERVIEW

The Emergency Agent software is a utility that streams video across a Local Area Network to a Client PC when an alarm is detected on the recorder. The video that streams across can be stopped, played forwards and backwards, in slow motion or real speed.

The utility is loaded at startup and placed in the taskbar. It constantly monitors for a signal from the recorder. When an alarm signal is detected the Emergency Agent Image Viewer window opens and starts playing the video from the camera associated to the alarm.

Configuring the Recorder

To enable the Emergency Agent on the recorder follow these steps:

1. From the Display screen, click **Setup**.
2. Click **Camera**.
3. Select a camera and associate sensors to that camera using **Sensor Connection** option.
4. Click **Network** and make sure that **Disable Remote Control** is cleared.

Note The Emergency Agent uses one port to transfer the data through the network (the Emergency Port). The port can be adjusted inside the Network menu if necessary. It is recommended that the default setting should be used unless the port must be changed.

5. Click **Schedule**.
6. Enter the IP Address of the workstation running the Emergency agent software under Emergency IP section.

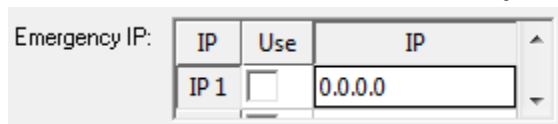

Emergency IP:	IP	Use	IP
	IP 1	<input checked="" type="checkbox"/>	0.0.0.0

7. Click the box next to the IP Address to enable it.
8. Select the **Sensor** option and create a schedule for the appropriate sensor (see the Schedule Setup chapter in this manual for further details).
9. Click **Apply**, then click **Exit Setup**.

Configuring the Client PC

All configurations take place in the Emergency Agent window on the Client PC for descriptions and locations of the buttons and features of the Emergency Agent window refer to the Emergency Agent window section later in this chapter.

1. Open the Emergency Agent window on the Client PC - **Start > All Programs > Surveillix > Emergency Agent > Emergency Agent**.
2. Right-click in the **DVR List** and select **New**. Enter the **DVR Code**, **DVR Name**, and **IP Address** of the recorder.
3. Click the **Options** menu and select **Setup**.
4. Confirm that the **Network Port** in the **Setup** window is set to the same number as the Emergency Port in Network Settings on the recorder. If the numbers are different adjust the **Network Port** on the client PC to match the recorder.
5. Click **OK**.
6. Restart the Client PC.

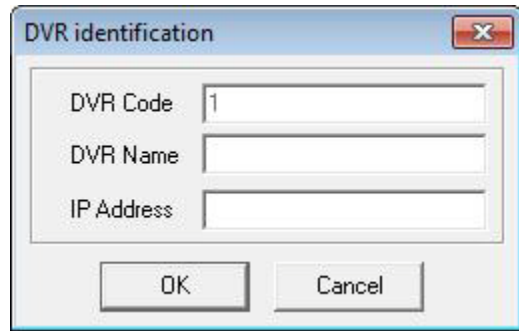

Setup Window

Network Port

Indicates the port which the Emergency Agent uses to listen for incoming events. This number should be changed to the same number as is set in the Emergency Port in Network Settings on the recorder.

Save Directory

Sets the location that recorded video footage is saved to.

Notice Options

Configuration settings for activating an audible indicator or popup window when the Emergency Agent receives an event.

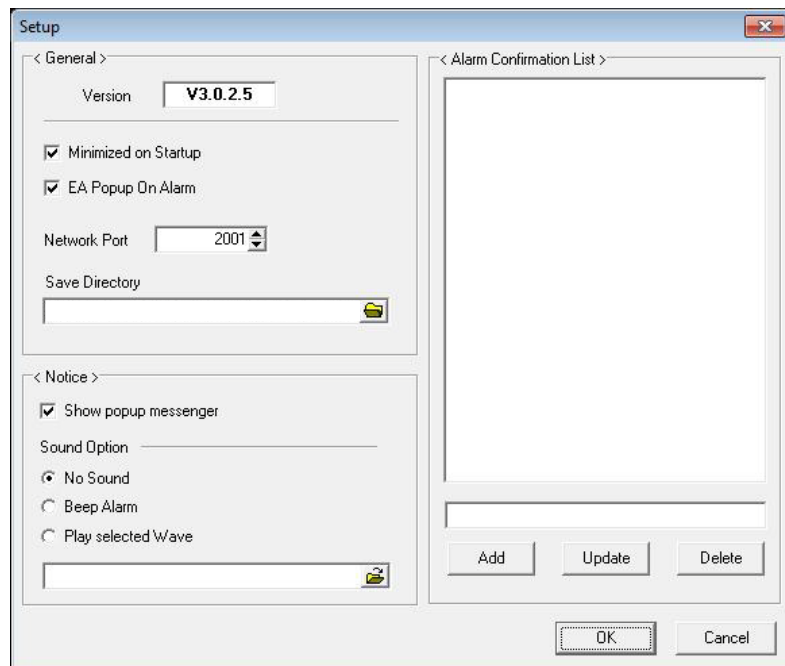

Emergency Agent Window

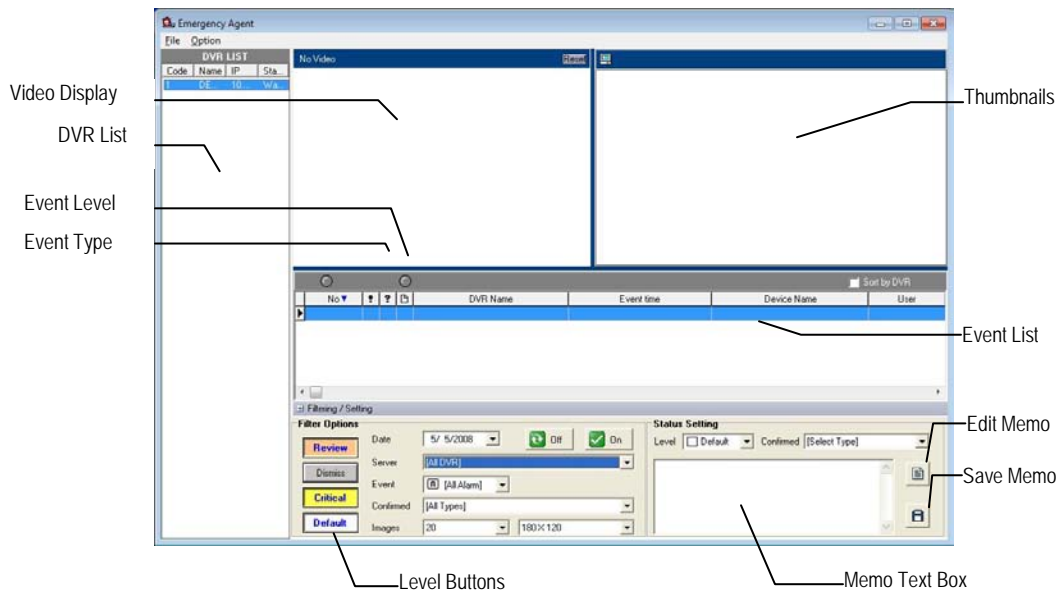

Filter Event List

1. Select a recorder from the DVR List in the **Filter Options** section.
2. Select the **Date** to include.
3. Select the type of **Events** to include.
4. Select the event levels (**Review**, **Dismiss**, **Critical**, **Default**).
5. Click the **On** button to display filtered event listings.

Add Items to Alarm Confirmation List

1. From the Option menu, click **Setup**.
2. Type the desired text in the box below the Alarm Confirmation List.

Note The items in the **Alarm Confirmation List** will be available on a list under **Status Setting** on the main Emergency Agent screen.

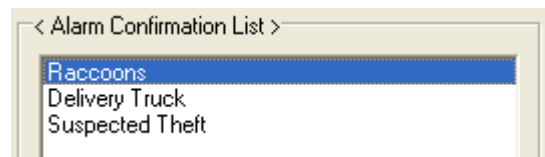

3. Click **Add**.
4. Click **OK** to save changes and close the window.

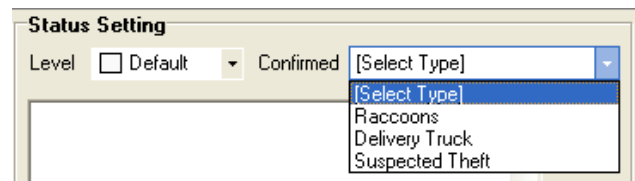

Search Alarm Window

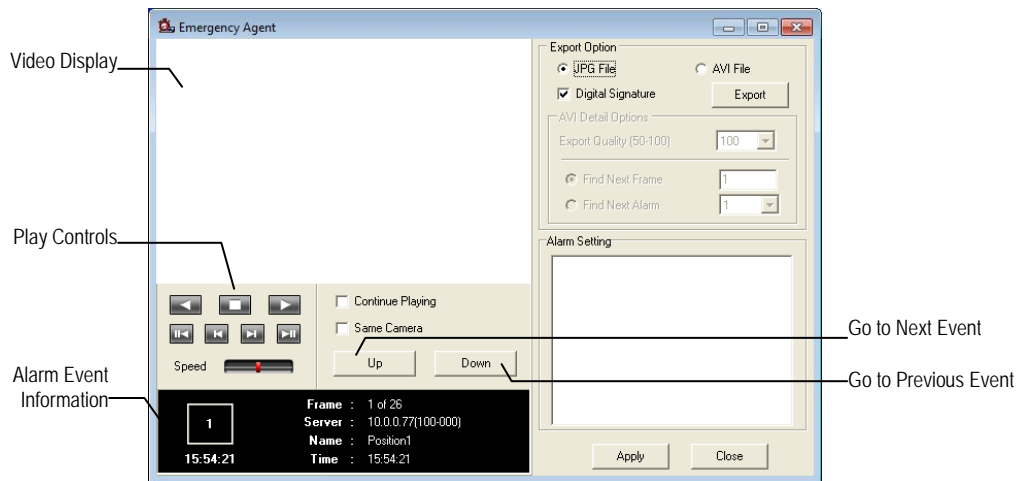

Export Quality

It may be necessary to reduce the overall size of an AVI file; for example, to email to someone. AVI file sizes can be reduced by reducing the image quality. However, reducing the image quality causes the AVI video to appear more pixilated. When size is not an issue, setting quality to 100 is highly recommended.

Digital Signature

Adds a digital signature to the exported JPG image for use with the Digital Signature Verifier to verify integrity of exported images and prevent tampering.

View Recorded Video

1. Double-click an event listing to open the Search Alarm window.
2. Use the play controls to locate the desired video.
3. Select the **Continue Playing** check box to watch all recorded events. When cleared, playback stops at the end of the alarm event.
4. Select the **Same Camera** check box to watch all events recorded by a single camera.
5. Click **Apply** after making any changes.

Export Video

1. Double-click an event listing to open the **Search Alarm** window.
2. Use the play controls to locate the desired video.
3. Click the **Rewind** button to return to the beginning or desired spot in the video.
4. Click the **Stop** button.
5. Select the **Export Option** – JPG or AVI.
6. Select the **Digital Signature** check box to embed a digital signature in a JPG file.
7. Reduce **Export Quality** only if necessary to reduce the size of the AVI file.
8. Click **Export**.

REMOTE SOFTWARE OVERVIEW

The recorder was specifically designed to be fully operated and maintained remotely. It connects using the standard TCP/IP protocol through connection types such as DSL, Cable Mode, T1, ISDN, LAN, and more. The Surveillix Remote software allows you to view live video, search through archived video, export images and video clips and have virtually full Setup control. Surveillix Remote Software is Microsoft® Windows XP®, Windows Vista®, and Windows 7® compatible.

Highlights:

- Search archived video
- View live video
- Export images and video clips
- Control relay outputs
- Setup administration

Basics:

The recorder can have up to 5 simultaneous remote connections. Each user can perform functions on the recorder and will not affect the other users. The only exceptions to this are accessing Setup and controlling a PTZ camera. Only one user is allowed to access setup or control a PTZ camera at any given time. The pictures per second passed to the Remote Client vary greatly depending on the connection type and speed.

In order to log in to the recorder server, a user account must be made for the user. This ensures that only authorized personnel are allowed to log in. In addition, each user can be assigned different privileges that allow them or deny them access to different functions. For example: a user can be denied Searching and Setup privileges and only granted access to view cameras 4, 8 and 16.



It is highly recommended that users not be granted Setup privileges since this can pose a security risk. Only properly authorized Administrators should have access to Setup.

The Remote software operates virtually the same way as the recorder itself. The appearance of it matches the recorder almost identically; however, there are a few minor differences. Some search features are not available (such as the Index and Object Searches) as well as some Setup options.

Remote Software Setup

Installing Remote Software

1. On the client workstation, insert the Surveillix Software CD into the CD-ROM. The CD should play automatically.
2. When prompted, select the Install Remote Software option. Follow the installation instructions carefully.
3. When the software finishes installing, close any open installation windows.

Create a New Remote Connection

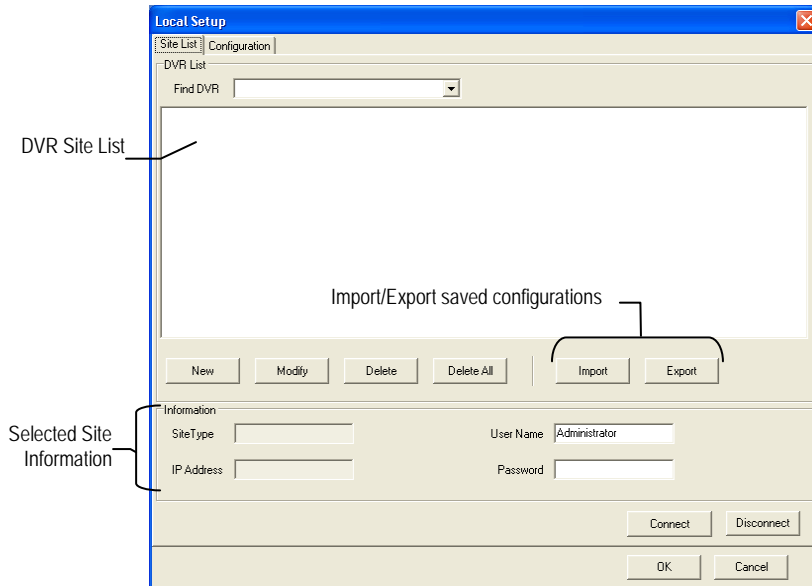

1. Select **Start > Programs > Surveillix > Remote > Surveillix Remote Center**. The Surveillix Remote Software opens and the Local Connection window opens.
2. Click **New** to open the **Site Info** window.
3. Select the Site Type and enter a Site Name. The Site Name will be the name displayed inside the connection box to help identify the unit.
4. Enter the **IP Address** of the recorder.
5. Enter the **Center Port**. This setting is specified in the server software.
6. Click **OK**.
7. Click on the newly created connection and enter the login username and password (case sensitive).
8. Click **Connect**.

Configuring the Recorder

In order to access the recorder remotely, the recorder Server must be setup to allow remote connections.

Time Out Value

Specifies a value (in seconds) to wait for a signal from the Surveillix Remote Client. If a signal is not received by that time, the connection is dropped.

Center Port

Used to transfer the connection data.

Image Port

Used to transfer the image data.

Search Port

Used to transfer the search data.

Network Setup	
TimeOut Value :	<input type="text" value="60"/>
Emergency Port : (1024 - 5000)	<input type="text" value="2001"/>
Center Port : (1024 - 5000)	<input type="text" value="2000"/>
Image Port : (1024 - 5000)	<input type="text" value="2002"/>
Search Port : (1024 - 5000)	<input type="text" value="2003"/>

Configuring the Server for Remote Connection

1. From the Display screen, click **Setup**.
2. Click **Network**.
3. Ensure that **Disable Remote Control** is cleared.

Note If you are using a Firewall, it may be necessary to adjust the port settings on both the recorder and the Firewall. Contact the Network Administrator for more information.

4. Click **Apply**.

Note If no additional user accounts have been created the administrator account will be the only account that can connect to the recorder remotely.

5. The recorder server is now ready to receive incoming connections from Remote Software, SCS, or MDVR.

DIGITAL VERIFIER OVERVIEW

JPG images and AVI video files that are exported from the Digital Video Recorder are automatically embedded with a digital signature. Digital Signatures are a way to verify the authenticity of the images to ensure that they have not been tampered with or edited in any way. Included on the Software Installation DVD supplied with the recorder is the Digital Signature Verification program. This program can be installed on any computer and loads an image in question.

Installing the Digital Verifier

1. Insert the Software Installation CD into the CD-ROM. (Do not install on the recorder.)
2. Select the **Digital Verifier** option to begin installation.
3. When the **Welcome** screen appears, click **Next**.
4. When the **Setup Complete** window appears click **Finish**. Installation is complete.

Using the Digital Verifier

1. Open the Digital Verification program by selecting Start > Programs > Surveillix > Digital Verifier > Digital Signature Verifier.
2. Click the **Browse** button to load the JPG image.
3. Enter the **Site Code** of the recorder that the image was originally extracted from. (The Site Code is specified in the Information Setup menu)
4. Click **Verify** to continue or **Close** to close the window without verifying.

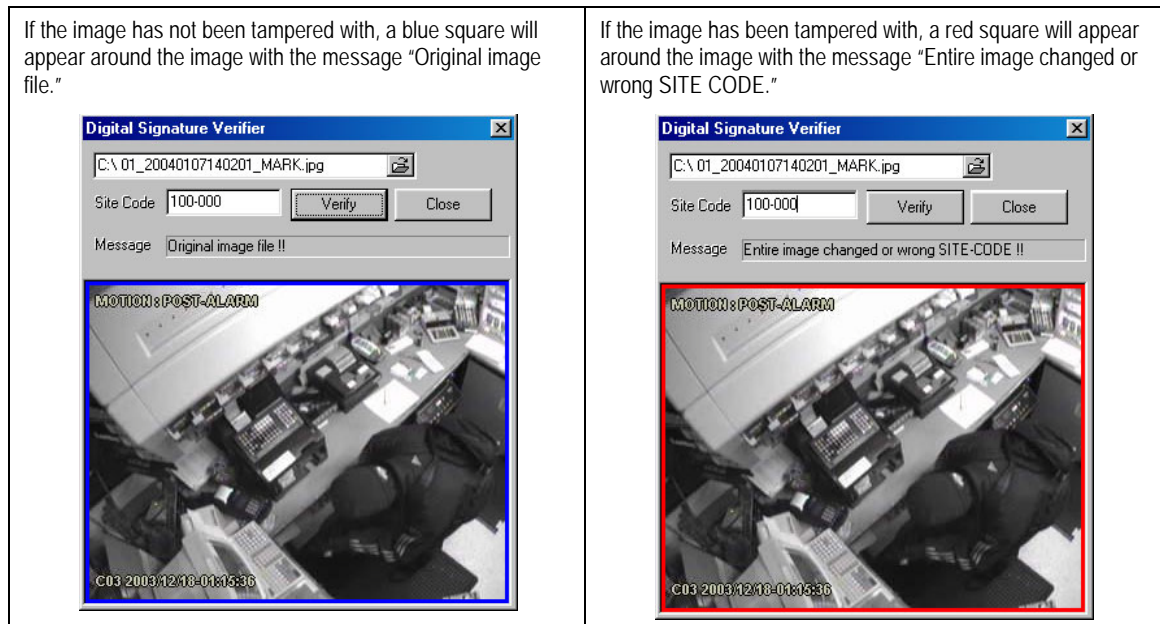

BACKUP VIEWER OVERVIEW

The Backup Viewer allows you to play back the exported video in its proprietary format. Video saved in this format is extremely difficult to tamper with and therefore is the ideal solution when law enforcement and the legal department are involved. This video cannot be read by any other viewer. The Backup Viewer operates essentially like the Search portion of the recorder software.

For detailed explanations of these functions, refer to the chapter on Search Options in this manual.

Installing Backup Viewer

1. Insert the Software Installation DVD into the DVD-ROM.
(Do not install on the recorder.)
2. Select the **Backup Viewer** option to begin installation.
When the Welcome screen opens, click **Next**.
3. Read the **License Agreement** and select the appropriate radio button to accept the terms of the license agreement.
Click **Next**.
4. Select **Yes** to install the POS component or select **No** for a basic install.
Click **Next**.

Note The POS component is only necessary when connecting to a server running the POS Upgrade.

5. When the **Choose Destination Location** window opens click **Next**.
This will install Backup Viewer in the default destination folder.
6. Select the shortcuts to install, or clear all boxes for no shortcuts.
Click **Next**.
7. When the **InstallShield Wizard Complete** window appears click **Finish**.
Setup is now complete.

Loading Video from DVD or Hard Drive

1. Open the Backup Viewer program: **Start > Programs > Surveillix > Backup Viewer > Backup Viewer**.
2. Click **Open**. The **Total Backup Search** window will open.
 - For DVD-ROM data, select the appropriate DVD-ROM drive letter from the Backup Media box.
 - For hard drive data, select either an attached hard drive from the Backup Media box or select the Open Folder icon to browse to a specific directory.

Note Once selected, available video data will be displayed in the **Choose Start Hour** box.

3. Click on the desired time to select it.
4. Click **OK**. The video will now load into the Backup Viewer.

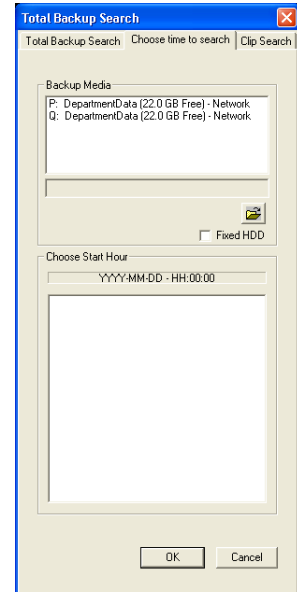

SOFTWARE UPGRADES

This chapter includes the following information:

- SCS Multi-Site Management Software Upgrade

SCS OVERVIEW

SCS software is Network DVR Management Software; a powerful utility that allows 100 or more recorders to be controlled using one computer. This software allows you to view live video, search saved video, edit and configure setup on each recorder, and import maps of buildings and other locations.

The SCS software was specifically designed as an enterprise software solution.

Highlights:

- View Live Video on most computers
- Username and Password protected
- Easy to use graphical interface

Basics:

In order to log in to the recorder server, a user account must be made for each user. This ensures that only authorized personnel are allowed to log in. In addition, each user can be assigned different privileges that allow them or deny them access to different functions.

Purchasing SCS Software Upgrade

Contact your Surveillix Sales Representative to purchase an SCS Software Upgrade. Use part number SCS-OPT.

Configuring the Server for Remote Connection

1. From the Display screen, click **Setup**.
2. Click **Network**.
3. Ensure that **Disable Remote Control** is cleared.

Note If you are using a Firewall, it may be necessary to adjust the port settings on both the recorder and the Firewall. Contact the Network Administrator for more information.

4. Click **Apply**.

Note If no additional user accounts have been created the administrator account will be the only account that can connect to the recorder remotely.

5. The recorder server is now ready to receive incoming connections from Remote Software, SCS, or MDVR.

Connecting to a Recorder

Refer to the Setup section of the SCS Manual for information on using the SCS Software.

Free Manuals Download Website

<http://myh66.com>

<http://usermanuals.us>

<http://www.somanuals.com>

<http://www.4manuals.cc>

<http://www.manual-lib.com>

<http://www.404manual.com>

<http://www.luxmanual.com>

<http://aubethermostatmanual.com>

Golf course search by state

<http://golfingnear.com>

Email search by domain

<http://emailbydomain.com>

Auto manuals search

<http://auto.somanuals.com>

TV manuals search

<http://tv.somanuals.com>