

TOSHIBA

Leading Innovation >>>

LX800 Series User's Guide

If you need assistance:

- ❖ Technical support is available online at Toshiba's Web site at support.toshiba.com. At this Web site, you will find answers for many commonly asked technical questions plus many downloadable software drivers, BIOS updates, and other downloads.

For more information, see “If Something Goes Wrong” on [page 109](#) in this guide.

Model: LX800 Series

Recordable and/or ReWritable Drive(s) and Associated Software Warranty

The computer system you purchased may include Recordable and/or ReWritable optical disc drive(s) and associated software, among the most advanced data storage technologies available. As with any new technology, you must read and follow all set-up and usage instructions in the applicable user guides and/or manuals enclosed or provided electronically. If you fail to do so, this product may not function properly and you may lose data or suffer other damage. TOSHIBA AMERICA INFORMATION SYSTEMS, INC. (“TOSHIBA”), ITS AFFILIATES AND SUPPLIERS DO NOT WARRANT THAT OPERATION OF THE PRODUCT WILL BE UNINTERRUPTED OR ERROR FREE. YOU AGREE THAT TOSHIBA, ITS AFFILIATES AND SUPPLIERS SHALL HAVE NO RESPONSIBILITY FOR DAMAGE TO OR LOSS OF ANY BUSINESS, PROFITS, PROGRAMS, DATA, NETWORK SYSTEMS OR REMOVABLE STORAGE MEDIA ARISING OUT OF OR RESULTING FROM THE USE OF THE PRODUCT, EVEN IF ADVISED OF THE POSSIBILITY THEREOF.

Protection of Stored Data

For your important data, please make periodic back-up copies of all the data stored on the hard disk or other storage devices as a precaution against possible failures, alteration, or loss of the data. **IF YOUR DATA IS ALTERED OR LOST DUE TO ANY TROUBLE, FAILURE OR MALFUNCTION OF THE HARD DISK DRIVE OR OTHER STORAGE DEVICES AND THE DATA CANNOT BE RECOVERED, TOSHIBA SHALL NOT BE LIABLE FOR ANY DAMAGE OR LOSS OF DATA, OR ANY OTHER DAMAGE RESULTING THEREFROM. WHEN COPYING OR TRANSFERRING YOUR DATA, PLEASE BE SURE TO CONFIRM WHETHER THE DATA HAS BEEN SUCCESSFULLY COPIED OR TRANSFERRED. TOSHIBA DISCLAIMS ANY LIABILITY FOR THE FAILURE TO COPY OR TRANSFER THE DATA CORRECTLY.**

Critical Applications

The computer you have purchased is not designed for any “critical applications.” “Critical applications” means life support systems, medical applications, connections to implanted medical devices, commercial transportation, nuclear facilities or systems or any other applications where product failure could lead to injury to persons or loss of life or catastrophic property damage. **ACCORDINGLY, TOSHIBA, ITS AFFILIATES AND SUPPLIERS DISCLAIM ANY AND ALL LIABILITY ARISING OUT OF THE USE OF THE COMPUTER PRODUCTS IN ANY CRITICAL APPLICATIONS. IF YOU USE THE COMPUTER PRODUCTS IN A CRITICAL APPLICATION, YOU, AND NOT TOSHIBA, ASSUME FULL RESPONSIBILITY FOR SUCH USE.**

FCC Notice “Declaration of Conformity Information”

This equipment has been tested and found to comply with the limits for a Class B digital device, pursuant to Part 15 of the FCC rules. These limits are designed to provide reasonable protection against harmful interference in a residential installation.

This equipment generates, uses and can radiate radio frequency energy and, if not installed and used in accordance with the instructions, it may cause harmful interference to radio communications. However, there is no guarantee that interference will not occur in a particular installation. If this equipment does cause harmful interference to radio or television reception, which can be determined by turning the equipment off and on, the user is encouraged to try to correct the interference by one or more of the following measures:

- ❖ Reorient or relocate the receiving antenna.
- ❖ Increase the separation between the equipment and receiver.
- ❖ Connect the equipment to an outlet on a circuit different from that to which the receiver is connected.
- ❖ Consult the dealer or an experienced radio/TV technician for help.

NOTE

Only Peripherals complying with the FCC Class B limits may be attached to this equipment. Operation with noncompliant peripherals or peripherals not recommended by Toshiba is likely to result in interference to radio and TV reception. Shielded cables must be used between the external devices and the computer's ports. Changes or modifications made to this equipment not expressly approved by Toshiba or parties authorized by Toshiba could void the user's authority to operate the equipment.

This device complies with Part 15 of the FCC Rules. Operation is subject to the following two conditions:

- ❖ This device may not cause harmful interference.
- ❖ This device must accept any interference received, including interference that may cause undesired operation.

Contact Toshiba's Support Website at support.toshiba.com.

Industry Canada Requirement

This Class B digital apparatus complies with Canadian ICES-003.

Cet appareil numérique de la classe B est conforme à la norme NMB-003 du Canada.

Wireless Interoperability

The TOSHIBA Wireless LAN Mini PCI Card products are designed to be interoperable with any wireless LAN product that is based on Direct Sequence Spread Spectrum (DSSS) radio technology, and is compliant to:

- ❖ The IEEE 802.11 Standard on Wireless LANs (Revision A/B/G), as defined and approved by the Institute of Electrical and Electronics Engineers.
- ❖ The Wireless Fidelity (Wi-Fi[®]) certification as defined by the Wi-Fi Alliance. The “Wi-Fi CERTIFIED” logo is a certification mark of the Wi-Fi Alliance.

Wireless LAN and Your Health

Wireless LAN products, like other radio devices, emit radio frequency electromagnetic energy. The level of energy emitted by Wireless LAN devices however is far much less than the electromagnetic energy emitted by wireless devices like for example mobile phones.

Because Wireless LAN products operate within the guidelines found in radio frequency safety standards and recommendations, TOSHIBA believes Wireless LAN is safe for use by consumers. These standards and recommendations reflect the consensus of the scientific community and result from deliberations of panels and committees of scientists who continually review and interpret the extensive research literature.

In some situations or environments, the use of Wireless LAN may be restricted by the proprietor of the building or responsible representatives of the organization. These situations may for example include:

- ❖ Using the Wireless LAN equipment on board airplanes, or
- ❖ In any other environment where the risk of interference to other devices or services is perceived or identified as harmful.

If you are uncertain of the policy that applies on the use of wireless devices in a specific organization or environment (e.g. airports), you are encouraged to ask for authorization to use the Wireless LAN device prior to turning on the equipment.

CAUTION

Exposure to Radio Frequency Radiation

The radiated output power of the TOSHIBA Wireless LAN Mini PCI Card is far below the FCC radio frequency exposure limits. Nevertheless, the TOSHIBA Wireless LAN Mini PCI Card shall be used in such a manner that the potential for human contact during normal operation is minimized. The antenna(s) used for this transmitter must not be co-located or operating in conjunction with any other antenna or transmitter.

Regulatory Information

The TOSHIBA Wireless LAN Mini PCI Card must be installed and used in strict accordance with the manufacturer's instructions as described in the user documentation that comes with the product. This device complies with the following radio frequency and safety standards.

Canada – Industry Canada (IC)

This device complies with RSS 210 of Industry Canada.

CAUTION

The installer of this radio equipment must ensure that the antenna is located or pointed such that it does not emit RF field in excess of Health Canada limits for the general population; consult Safety Code 6, obtainable from Health Canada's Web site www.hc-sc.gc.ca/rpb. The RF device shall not be co-located with any other transmitter that has not been tested with this device.

Operation is subject to the following two conditions: (1) this device may not cause interference, and (2) this device must accept any interference, including interference that may cause undesired operation of this device.

L' utilisation de ce dispositif est soumise aux deux conditions suivantes: (1) il ne doit pas produire de brouillage et (2) l'utilisateur du dispositif doit être prêt à accepter tout brouillage radioélectrique reçu, même s'il est susceptible de compromettre son fonctionnement.

The term "IC" before the equipment certification number only signifies that the Industry Canada technical specifications were met.

To prevent radio interference to the licensed service, this device is intended to be operated indoors and away from windows to provide maximum shielding. Equipment (or its transmit antenna) that is installed outdoors is subject to licensing.

Pour empêcher que cet appareil cause du brouillage au service faisant l'objet d'une licence, il doit être utilisé à l'intérieur et devrait être placé loin des fenêtres afin de fournir un écran de blindage maximal. Si le matériel (ou son antenne d'émission) est installé à l'extérieur, il doit faire l'objet d'une licence.

Bluetooth® Wireless Technology Interoperability

Bluetooth® Cards from TOSHIBA are designed to be interoperable with any product with Bluetooth wireless technology that is based on Frequency Hopping Spread Spectrum (FHSS) radio technology, and is compliant to:

- ❖ Bluetooth Specification as defined and approved by The Bluetooth Special Interest Group.
- ❖ Logo certification with Bluetooth wireless technology as defined by The Bluetooth Special Interest Group.

CAUTION

Always use *Bluetooth* cards from TOSHIBA in order to enable wireless networks over two or more (up to a total of seven) TOSHIBA computers using these cards. Please contact TOSHIBA computer product support on Web site <http://www.toshiba-europe.com/computers/tnt/bluetooth.htm> in Europe or support.toshiba.com in the United States for more information.

When you use *Bluetooth* cards from TOSHIBA close to 2.4 GHz Wireless LAN devices, *Bluetooth* transmissions might slow down or cause errors. If you detect certain interference while you use *Bluetooth* cards from TOSHIBA, always change the frequency, move your computer to the area outside of the interference range of 2.4 GHz Wireless LAN devices (40 meters/43.74 yards or more) or stop transmitting from your computer. Please contact TOSHIBA computer product support on Web site <http://www.toshiba-europe.com/computers/tnt/bluetooth.htm> in Europe or support.toshiba.com in the United States for more information.

Bluetooth and Wireless LAN devices operate within the same radio frequency range and may interfere with one another. If you use *Bluetooth* and Wireless LAN devices simultaneously, you may occasionally experience a less than optimal network performance or even lose your network connection. If you should experience any such problem, immediately turn off either one of your *Bluetooth* or Wireless LAN. Please contact Toshiba computer product support on Web site <http://www.toshiba-europe.com/computers/tnt/bluetooth.htm> in Europe or support.toshiba.com in the United States for more information.

Bluetooth® Wireless Technology and Your Health

The products with *Bluetooth*® wireless technology, like other radio devices, emit radio frequency electromagnetic energy. The level of energy emitted by devices with *Bluetooth* wireless technology however is much less than the electromagnetic energy emitted by wireless devices such as mobile phones.

Because products with *Bluetooth* wireless technology operate within the guidelines found in radio frequency safety standards and recommendations, TOSHIBA believes *Bluetooth* wireless technology is safe for use by consumers. These standards and recommendations reflect the consensus of the scientific community and result from deliberations of panels and committees of scientists who continually review and interpret the extensive research literature.

In some situations or environments, the use of *Bluetooth* wireless technology may be restricted by the proprietor of the building or responsible representatives of the organization. These situations may, for example, include in any other environment where the risk of interference to other devices or services is perceived or identified as harmful.

If you are uncertain of the policy that applies on the use of wireless devices in a specific organization or environment (e.g. airports), you are encouraged to ask for

authorization to use the device with *Bluetooth* wireless technology prior to turning on the equipment.

CAUTION Exposure to Radio Frequency Radiation

The radiated output power of the *Bluetooth* Card from TOSHIBA is far below the FCC radio frequency exposure limits. Nevertheless, the *Bluetooth* Card from TOSHIBA shall be used in such a manner that the potential for human contact during normal operation is minimized.

Regulatory statements

This product complies with any mandatory product specification in any country/region where the product is sold. In addition, the product complies with the following:

European Union (EU) and EFTA

This equipment complies with the R&TTE directive 1999/5/EC and has been provided with the CE mark accordingly.

Optical Disc Drive Safety Instructions

⚠ DANGER This appliance contains a laser system and is classified as a CLASS 1 LASER PRODUCT. To use this model properly, read the User's Guide carefully and keep it for your future reference.

Never attempt to disassemble, adjust or repair an optical disc drive. You could damage the drive. You would also be exposed to laser light or other safety hazards, resulting in serious injury. Always contact an authorized Toshiba service provider, if any repair or adjustment is required.

CLASS 1 LASER PRODUCT
LASERKLASSE 1

Location of the Required Label

(Sample shown below. Location of the label and manufacturing information may vary.)

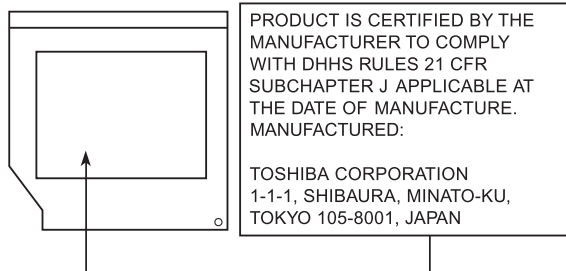

Copyright

This guide is copyrighted by Toshiba America Information Systems, Inc. with all rights reserved. Under the copyright laws, this guide cannot be reproduced in any form without the prior written permission of Toshiba. No patent liability is assumed, however, with respect to the use of the information contained herein.

©2012 by Toshiba America Information Systems, Inc. All rights reserved.

Export Administration Regulation

This document contains technical data that may be controlled under the U.S. Export Administration Regulations, and may be subject to the approval of the U.S. Department of Commerce prior to export. Any export, directly or indirectly, in contravention of the U.S. Export Administration Regulations is prohibited.

Notice

The information contained in this manual, including but not limited to any product specifications, is subject to change without notice.

TOSHIBA CORPORATION AND TOSHIBA AMERICA INFORMATION SYSTEMS, INC. (TOSHIBA) PROVIDES NO WARRANTY WITH REGARD TO THIS MANUAL OR ANY OTHER INFORMATION CONTAINED HEREIN AND HEREBY EXPRESSLY DISCLAIMS ANY IMPLIED WARRANTIES OF MERCHANTABILITY OR FITNESS FOR ANY PARTICULAR PURPOSE WITH REGARD TO ANY OF THE FOREGOING. TOSHIBA ASSUMES NO LIABILITY FOR ANY DAMAGES INCURRED DIRECTLY OR INDIRECTLY FROM ANY TECHNICAL OR TYPOGRAPHICAL ERRORS OR OMISSIONS CONTAINED HEREIN OR FOR DISCREPANCIES BETWEEN THE PRODUCT AND THE MANUAL. IN NO EVENT SHALL TOSHIBA BE LIABLE FOR ANY INCIDENTAL, CONSEQUENTIAL, SPECIAL, OR EXEMPLARY DAMAGES, WHETHER BASED ON TORT, CONTRACT OR OTHERWISE, ARISING OUT OF OR IN CONNECTION WITH THIS MANUAL OR ANY OTHER INFORMATION CONTAINED HEREIN OR THE USE THEREOF.

Trademarks

eco Utility is a trademark of Toshiba America Information Systems, Inc. and/or Toshiba Corporation.

Adobe and Photoshop are either registered trademarks or trademarks of Adobe Systems Incorporated in the United States and/or other countries.

Atheros is a registered trademark of Atheros Communications, Inc.

Blu-ray and Blu-ray Disc are trademarks of the BD Association.

Bluetooth word mark and logos are owned by the Bluetooth SIG, Inc. and any use of such marks by Toshiba is under license. Other trademarks and trade names are those of their respective owners.

HDMI, the HDMI Logo and High-Definition Multimedia Interface are trademarks or registered trademarks of HDMI Licensing, LLC.

Intel, Intel Core, Celeron, Centrino and Pentium are trademarks or registered trademarks of Intel Corporation or its subsidiaries in the United States and other countries.

Memory Stick, Memory Stick PRO, and Memory Stick PRO Duo are trademarks or registered trademarks of Sony Corporation.

Microsoft, Outlook, Windows, and Windows Media are either registered trademarks or trademarks of Microsoft Corporation in the United States and/or other countries.

MultiMediaCard and MMC are registered trademarks of MultiMediaCard Association.

Secure Digital and SD are trademarks of SD Card Association.

Wi-Fi is a registered trademark of the Wi-Fi Alliance.

All other brand and product names are trademarks or registered trademarks of their respective companies.

Licenses

This Product is licensed under the AVC, the VC-1 and the MPEG-4 Part 2 Visual patent portfolio licenses for the personal and non-commercial use of a consumer to (i) encode video in compliance with the above standards (“Video Standards”) and/or (ii) decode AVC, VC-1 and MPEG-4 Part 2 Visual that was encoded by a consumer engaged in personal and non-commercial activity or was obtained from a video provider licensed to provide such video. None of the licenses extend to any other product regardless of whether such product is included with this product in a single article. No license is granted or shall be implied for any other use. Additional information may be obtained from MPEG LA, LLC.

See www.mpegla.com.

Computer Recycling Information

As part of a commitment to people and the future, Toshiba promotes the efficient use of resources by working to achieve our zero-waste-to-landfill goal at all our production sites. In addition to our existing waste reduction and recycling policies, Toshiba is strongly committed to reducing electronic waste. In order to ensure efficient use of resources and appropriate treatment of hazardous substances, in accordance with recycling regulations in each state, country, and territory, Toshiba wants to make it easy for customers to recycle products at the end of the life cycle. To learn more about Toshiba's sustainability commitment, visit us.toshiba.com/green.

Reuse, Donation, Recycling

Functional computers can be donated to a local charity or resold through other programs. Non working Toshiba computers can be mailed-back for free recycling. For additional details, please visit us.toshiba.com/recycle.

Contents

Introduction.....	16
This guide	18
Safety icons	19
Other icons used	19
Your computer's features and specifications	20
Other documentation	20
Service options	20
Chapter 1: Getting Started.....	21
Setting up a work environment	21
Precautions.....	22
Important information on your computer's cooling fan	23
Setting up your computer	23
Connecting to a power source	24
Using the computer for the first time	26
Setting up your keyboard and mouse	26
Turning on the power	28
Setting up your software.....	29
Registering your computer with Toshiba	29

Adding optional external devices.....	29
Adding memory (optional)	30
Installing a memory module	30
Removing a memory module.....	35
Checking total memory	37
Recovering the Internal Storage Drive	38
Recovering to out-of-box state (recommended recovery method).....	39
Recovering of factory default software with user's data.....	42
Recovering without changing the internal storage drive partitions	45
Recovering to a custom size partition.....	48
Creating recovery media	50
Restoring from recovery media	52
Erasing the Internal Storage Drive	54
Checking the internal storage drive operating status	56
Installing drivers and applications.....	56
Connecting an external device.....	56
Using external display devices	57
Using the HDMI™ In port.....	57
Customizing your computer's settings.....	58
Caring for your computer.....	58
Cleaning the computer	58
Moving the computer.....	58
Using a computer lock	59
Chapter 2: Learning the Basics.....	60
Computing tips	60
Using the wireless mouse	61
Replacing the batteries	62
Using the wireless keyboard	63
Replacing the batteries	63
Keyboard functions	64
Character keys	64

Ctrl, Fn, and Alt keys	65
Function keys	65
Special Windows® keys	65
Touch screen	65
Starting a program.....	66
Starting a program using	
the Search programs and files field	66
Starting a program from the Start menu.....	67
Saving your work.....	67
Backing up your work	68
Restoring your work	68
Using the optical disc drive.....	69
Viewing Blu-ray Disc™ movies	69
Optical disc drive components.....	70
Inserting an optical disc	70
Playing an audio CD.....	72
Playing optical media.....	72
Recording optical media	73
Removing a disc with the computer on.....	73
Removing a disc with the computer off	74
Toshiba's online resources	74
Chapter 3: Computing	75
Toshiba's energy-saver design.....	75
Power management	75
Charging the RTC battery	76
Power Plans.....	76
Using the TOSHIBA eco power plan.....	78
Chapter 4: Exploring Your Computer's Features	79
Exploring the desktop	79
Finding your way around the desktop	80
Setting up for communications.....	82
Connecting your computer to a network.....	83
Exploring audio features	83
Recording sounds.....	83

Using external speakers or headphones.....	84
Using the Web Camera	85
Using the Memory card reader.....	85
Inserting memory media	86
Removing memory media	87
Toshiba remote control.....	88
Using the Toshiba remote control.....	88
Chapter 5: Utilities.....	89
TOSHIBA Assist	90
Connect.....	91
Secure.....	91
Protect & Fix	92
Optimize.....	93
TOSHIBA Application Installer.....	94
Setting passwords	95
Using a supervisor password.....	95
Using a user password	97
Deleting a user password.....	97
TOSHIBA Face Recognition Utility.....	98
TOSHIBA PC Diagnostic Tool Utility.....	99
Mouse Utility	100
TOSHIBA Hardware Setup.....	101
TOSHIBA Sleep Utility	102
Starting the TOSHIBA Sleep Utility.....	102
USB Sleep and Charge	102
Enabling/Disabling USB Sleep and Charge.....	103
Power supply mode settings.....	103
TOSHIBA Button Support.....	105
TOSHIBA Accessibility	106
TOSHIBA eco Utility™	107
TOSHIBA Service Station	107
TOSHIBA PC Health Monitor	108

Chapter 6: If Something Goes Wrong.....	109
Problems that are easy to fix	109
Problems when you turn on the computer.....	110
The Windows® operating system is not working ..	111
Using Startup options to fix problems	111
Internet problems	112
The Windows® operating system can help you	112
Fixing a problem with Device Manager	113
Checking device properties	113
Memory problems	114
Power and the battery	114
Keyboard problems.....	115
Display problems	115
Disk or storage drive problems.....	116
Error-checking	116
Optical disc drive problems.....	117
Sound system problems	119
Printer problems	120
Wireless networking problems.....	121
DVD and Blu-ray Disc™ operating problems.....	122
Develop good computing habits	123
Data and system configuration backup in the Windows® operating system.....	124
If you need further assistance	129
Contacting Toshiba	129
Other Toshiba Internet Web sites.....	129
Toshiba's worldwide offices.....	130
Appendix A: Hot Keys/TOSHIBA Cards.....	131
Hot Key Cards	131
Using the Hot Key Cards	132
Hot key functions	132
Help	132
Display brightness	133
Internet and Media Control Buttons	134

Volume Mute	135
Disabling or enabling wireless devices.....	136
Zoom (Display resolution)	137
Appendix B: Power Cord/Cable Connectors.....	138
Glossary.....	139
Index.....	154

Introduction

Welcome to the world of powerful, multimedia computing.



Your computer model may be ENERGY STAR® qualified. If the model you purchased is qualified, it is labeled with the ENERGY STAR® logo on the computer and the following information applies.

Toshiba is a partner in the Environmental Protection Agency's (EPA) ENERGY STAR® Program and has designed this computer to meet the latest ENERGY STAR® guidelines for energy efficiency.

Your computer ships with the power management options preset to a configuration that will provide the most stable operating environment and optimum system performance. To conserve energy, your computer is set to enter the low-power Sleep mode which shuts down the system and display within 15 minutes of inactivity. We recommend that you leave this and other energy saving features active, so that your computer will operate at its maximum energy efficiency. You can wake the computer from Sleep mode by pressing the power button. See the "Computing" section of the Toshiba User's Guide for more information on using power management settings to conserve energy.

When considering additions to your home office, purchase products that have earned the ENERGY STAR® for all your equipment needs, which can save you money, save energy, and help protect the climate.

Visit www.energystar.gov or www.energystar.gov/powermanagement for more information regarding the ENERGY STAR® Program

NOTE

This computer is compatible with European Union Directive 2002/95/EC, Restriction of the use of certain Hazardous Substances in electrical and electronic equipment (RoHS), which restricts use of lead, cadmium, mercury, hexavalent chromium, PBB, and PBDE. Toshiba requires its computer component suppliers to meet RoHS requirements and verifies its suppliers' commitment to meeting RoHS requirements by conducting component sampling inspections during the product design approval process.

NOTE

Certain Microsoft® software product(s) included with this computer may use technological measures for copy protection. IN SUCH EVENT, YOU WILL NOT BE ABLE TO USE THE PRODUCT IF YOU DO NOT FULLY COMPLY WITH THE PRODUCT ACTIVATION PROCEDURES. Product activation procedures and Microsoft's privacy policy will be detailed during initial launch of the product, or upon certain reinstallations of the software product(s) or reconfigurations of the computer, and may be completed by Internet or telephone (toll charges may apply).

Some software may differ from its retail version (if available), and may not include user manuals or all program functionality.

NOTE

The product specifications and configuration information are designed for a product Series. Your particular model may not have all the features and specifications listed or illustrated. For more detailed information about the features and specifications on your particular model, please visit Toshiba's Web site at support.toshiba.com.

While Toshiba has made every effort at the time of publication to ensure the accuracy of the information provided herein, product specifications, configurations, prices, system/component/options availability are all subject to change without notice. For the most up-to-date product information about your computer, or to stay current with the various computer software or hardware options, visit Toshiba's Web site at support.toshiba.com.

This guide

This guide introduces the computer's features as well as some basic procedures needed to perform tasks in Windows® 7. You can:

- ❖ Read the entire guide from beginning to end.
- ❖ Skim through and stop when a topic interests you.
- ❖ Use the table of contents and the index to find specific information.

Safety icons

This manual contains safety instructions that must be observed to avoid potential hazards that could result in personal injuries, damage to your equipment, or loss of data. These safety cautions have been classified according to the seriousness of the risk, and icons highlight these instructions as follows:

▲ DANGER

Indicates an imminently hazardous situation which, if not avoided, will result in death or serious injury.

▲ WARNING

Indicates a potentially hazardous situation which, if not avoided, could result in death or serious injury.

▲ CAUTION

Indicates a potentially hazardous situation which, if not avoided, may result in minor or moderate injury.

CAUTION

Indicates a potentially hazardous situation which, if not avoided, may result in property damage.

NOTE

Provides important information.

Other icons used

Additional icons highlight other helpful or educational information:



TECHNICAL NOTE: This icon indicates technical information about the computer.



HINT: This icon indicates helpful hints and tips.



DEFINITION: This icon indicates the definition of a term used in the text.

Your computer's features and specifications

Certain computer chassis are designed to accommodate all possible configurations for an entire product Series. Your select model may not have all the features and specifications corresponding to all of the icons or switches shown on the computer chassis, unless you have selected all those features.

This information applies to all the features and icons described in this guide.

Below are examples of some of the many possible icons used on your computer:



(Sample Illustration) System icons

Other documentation

Your computer comes with the following documentation:

- ❖ An electronic version of the User's Guide (this document)
- ❖ A Quick Start Document
- ❖ It may also contain guides for other programs that may come with your system.

For accessory information, visit Toshiba's Web site at accessories.toshiba.com.

Service options

Toshiba offers a full line of optional service programs to complement its standard limited warranty. Toshiba's standard limited warranty, extended warranty, and service upgrade terms and conditions are available at warranty.toshiba.com.

To stay current on the most recent software and hardware options for your computer, and for other product information, be sure to regularly check the Toshiba Web site at support.toshiba.com.

If you have a problem or need to contact Toshiba, see "If Something Goes Wrong" on page 109.

Chapter 1

Getting Started

This chapter provides tips for using your computer effectively, summarizes how to connect components, and explains what to do the first time you use your computer.

Please read the safety instruction information on the Quick Start document (that shipped with your computer) carefully and make sure you fully understand the instructions before you attempt to use your computer in order to avoid potential hazards that could cause bodily injury, property damage, or damage the computer.

Setting up a work environment

Place the computer on a hard flat surface that is large enough for the computer and any other items you are using, such as a printer. Leave enough space around the computer and other equipment to provide adequate ventilation.

To keep your computer in prime operating condition, protect your work area from:

- ❖ Dust, moisture, and direct sunlight.
- ❖ Equipment that generates a strong electromagnetic field, such as stereo speakers (other than speakers that are connected to the computer) or speakerphones.

- ❖ Rapid changes in temperature or humidity and sources of temperature change such as air conditioner vents or heaters.
- ❖ Extreme heat, cold, or humidity.
- ❖ Liquids and corrosive chemicals.

Precautions

Your computer is designed to provide optimum safety and ease of use. You should observe certain precautions to further reduce the risk of personal injury or damage to the computer.

▲ WARNING

Never allow any liquids to spill into any part of your computer, and never expose the computer to rain, water, seawater or moisture. Exposure to liquid or moisture can cause electric shock or fire, resulting in damage or serious injury. If any of these eventualities should accidentally occur, immediately:

1. Turn off the computer.
2. Disconnect the AC adaptor from the power plug socket and computer.

Failure to follow these instructions could result in serious injury or permanent damage to the computer.

Do not turn on the power again until you have taken the computer to an authorized service center.

- ❖ Never turn off the computer if a drive light indicates a drive is active.
Turning off the computer while it is reading from or writing to a disk/disc or flash media may damage the disk/disc or flash media, the drive, or both.
 - ❖ Keep the computer and disks away from objects that generate strong magnetic fields, such as large stereo speakers.
Information on some disks is stored magnetically. Placing a magnet too close to a disk can erase important files.
-

CAUTION

Handle discs carefully. Avoid touching the surface of the disc. Grasp it by its center hole and edge. If you handle the disc incorrectly, you could damage the disc and possibly lose data.

- ❖ Scan all new files for viruses.
This precaution is especially important for files you receive via email or download from the Internet. Occasionally, even new

programs you buy from a supplier may contain a computer virus. You need a special program to check for viruses.

Important information on your computer's cooling fan

Your computer may have a CPU cooling fan that cools the CPU by drawing outside air into the computer.

⚠ WARNING

Always make sure your computer and AC adaptor have adequate ventilation and are protected from overheating when the power is turned on or when an AC adaptor is connected to a power outlet (even if your computer is in Sleep mode). In this condition, observe the following:

- ❖ Never cover your computer or AC adaptor with any object.
- ❖ Never place your computer or AC adaptor near a heat source, such as an electric blanket or heater.
- ❖ Never cover or block the air vents including those located on the back of the computer.
- ❖ Always operate your computer on a hard flat surface.

Overheating your computer or AC adaptor could cause system failure, computer or AC adaptor damage or a fire, possibly resulting in serious injury.

Setting up your computer



TECHNICAL NOTE: You must complete all setup steps up to and including ["Setting up your software" on page 29](#) before adding external or internal components to your computer. These components include, but are not limited to a printer and memory.

NOTE

Please handle your computer carefully to avoid scratches and damage.

Connecting to a power source

Your computer requires power to operate. Use the power cord/cable and AC adaptor to connect the computer to a live electrical outlet.

▲ WARNING Never pull on a power cord/cable to remove a plug from a socket. Always grasp the plug directly. Failure to follow this instruction may damage the cord/cable, and/or result in a fire or electric shock, possibly resulting in serious injury.

▲ WARNING Always confirm that the power plug (and extension cable plug if used) has been fully inserted into the socket, to ensure a secure electrical connection. Failure to do so may result in a fire or electric shock, possibly resulting in serious injury.

Be careful if you use a multiple connector. An overload on one socket could cause a fire or electric shock, possibly resulting in serious injury.

▲ WARNING Always use the TOSHIBA AC adaptor that was provided with your computer, or use AC adaptors specified by TOSHIBA to avoid any risk of fire or other damage to the computer. Use of an incompatible AC adaptor could cause fire or damage to the computer possibly resulting in serious injury. TOSHIBA assumes no liability for any damage caused by use of an incompatible adaptor.

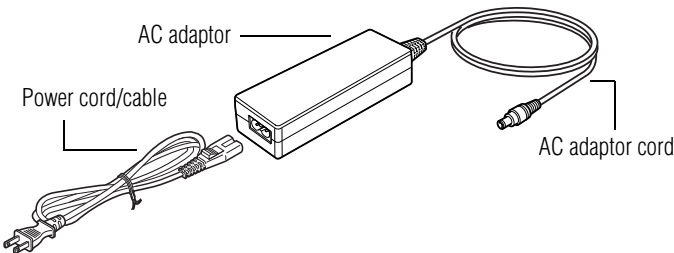

(Sample Illustration) Power cord/cable and AC adaptor

To connect AC power to the computer:

- 1 Connect the power cord/cable to the AC adaptor.

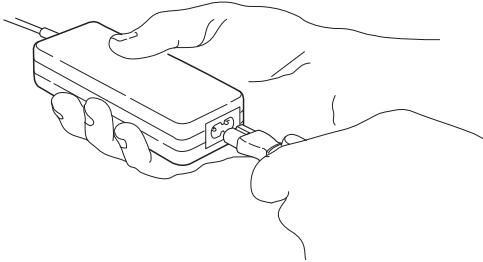

(Sample Illustration) Connecting the power cord/cable to the AC adaptor

- 2 Plug the AC adaptor cord into the DC-IN on the back of the computer.

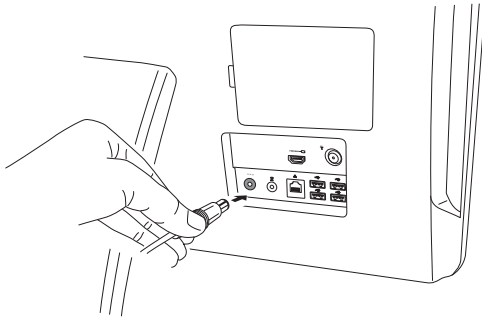

(Sample Illustration) Connecting the AC adaptor cord to the computer

- 3 Connect the power cord/cable to a live electrical outlet.

⚠ WARNING

Never attempt to connect or disconnect a power plug with wet hands. Failure to follow this instruction could result in an electric shock, possibly resulting in serious injury.

Using the computer for the first time

The computer is now ready for you to turn it on and begin using it.

Adjust the display to a comfortable viewing angle.

Small bright dots may appear on your screen display when you turn on your computer. Your display contains an extremely large number of thin-film transistors (TFT) and is manufactured using high-precision technology. Any small bright dots that may appear on your display are an intrinsic characteristic of the TFT manufacturing technology. Over a period of time, and depending on the usage of the computer, the brightness of the screen will deteriorate. This is also an intrinsic characteristic of the screen technology.

Setting up your keyboard and mouse

The keyboard and mouse may be pre-installed. Press and hold the Connect button located on the underside of both the keyboard and mouse, while turning ON the computer.

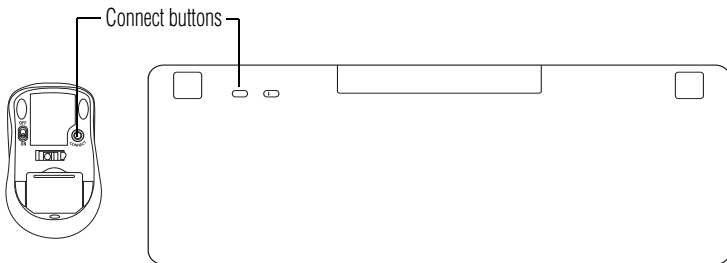

(Sample Illustration) Connecting keyboard and mouse

If your keyboard and mouse are not pre-installed, please follow these instructions:

- 1 Remove the RF mini USB dongle, Keyboard and Mouse from packaging.

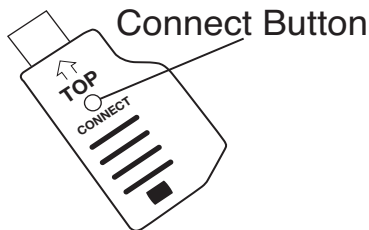

(Sample Illustration) RF mini USB dongle

- 2 Remove the RF mini USB dongle cover, located on the back of the computer on the lower left corner.

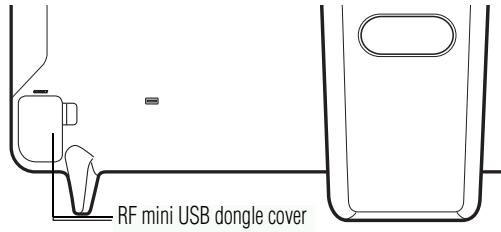

(Sample Illustration) RF mini USB dongle cover

- 3 Insert the mini USB dongle into the mini USB port.
- 4 Insert batteries in the keyboard.
- 5 Insert batteries in the mouse.
- 6 Ensure that both mouse and keyboard are switched to the "ON" position. Your wireless keyboard and mouse are now connected.

If there is no response from the wireless devices, press the connect buttons on the keyboard, mouse, and RF mini USB dongle for a few seconds, while turning ON the computer.

Please refer to the illustrations above for location of covers and buttons.

Turning on the power

To turn on the computer:

- 1 Make sure the power is properly connected and ready.
- 2 Check to ensure that all drives and slots are empty. Press and release the power button. The ON/OFF light glows white.

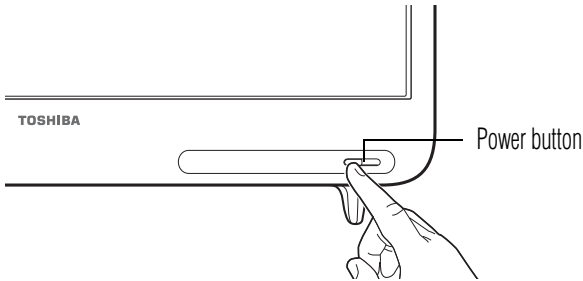

(Sample Illustration) Turning on the power

The pre-installed operating system will load automatically.

CAUTION

When you turn on the computer for the first time, do not turn off the power again until the operating system has loaded completely.

Setting up your software

NOTE The names of windows displayed, and the order in which windows appear, may vary according to your software setup choices.

The first time you turn on your computer, the Setup Wizard guides you through steps to set up your software. Follow the on-screen instructions.

Registering your computer with Toshiba

Product registration is strongly recommended, and allows Toshiba to send you periodic updates, announcements, and special offers applicable to your product. Product registration can be completed by either visiting the Toshiba Website at register.toshiba.com or by clicking the **Start** button and, in the Search field, type **Registration**. In the list that appears above, click on your selection. Failure to complete Product Registration will not diminish Customer rights under the Toshiba standard limited Warranty.

NOTE To register online, you must be connected to the Internet.

Adding optional external devices

NOTE Before adding external devices, Toshiba recommends first setting up the software.

After starting your computer for the first time you may want to:

- ❖ Add more memory (see “[Adding memory \(optional\)](#)” on page 30)
- ❖ Connecting external devices (see “[Connecting an external device](#)” on page 56)

Adding memory (optional)



HINT: To purchase additional memory modules, see the accessories information packaged with your system or visit accessories.toshiba.com.

Your computer comes with enough memory to run most of today's popular applications. You may want to increase the computer's memory if you use complex software or process large amounts of data.

NOTE

Before adding external devices, Toshiba recommends first setting up the software.

Installing a memory module

Memory modules can be installed in the memory module slots on the back of the computer. You will need a small Phillips screwdriver for this procedure.

CAUTION

If the computer has been running recently, the memory module(s) may be hot. The surrounding area may also be hot. Allow the module(s) to cool to room temperature before replacing it. Avoid touching the cover, the module(s), and the surrounding area before they have cooled. Failure to follow these directions could result in minor bodily injury.

CAUTION

To avoid damaging the computer's screws, use a small Phillips screwdriver of the correct size that is in good condition.

CAUTION

Installing a memory module with the computer's power on will damage the computer, the module, or both. Always turn the computer's power off first.

The computer has two memory slots—Slot A and Slot B. You can install one or two memory modules.

CAUTION

Before you install or remove a memory module, turn off the computer using the Start menu. If you install or remove a memory module while the computer is in Sleep or Hibernation mode, data will be lost.

NOTE

For this model, Slot A is the bottom slot. Slot B is the top slot. If only one memory module is to be installed, it must be installed in Slot A.

If the computer is on, begin at step 1; otherwise, skip to step 3.

- 1 Click **Start**.

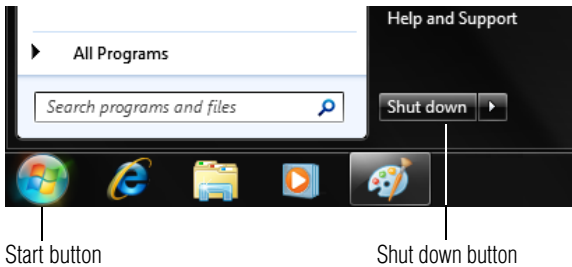

(Sample Image) Shut down button

- 2 Click the **Shut down** button in the lower-right corner of the Start menu.

The computer closes all open programs, shuts down the operating system, and then turns off.

- 3 Unplug and remove any cables connected to the computer, including the AC adaptor.

CAUTION

Do not try to remove a memory module with the computer turned on. You can damage the computer and the memory module.

Do not remove the memory module while the computer is in Sleep or Hibernation mode. The computer could hang up the next time you turn it on and data in memory will be lost. In either of the above cases, the Sleep configuration will not be saved.

- Using a small Phillips screwdriver, loosen the captive screw that secures the memory module slot cover.

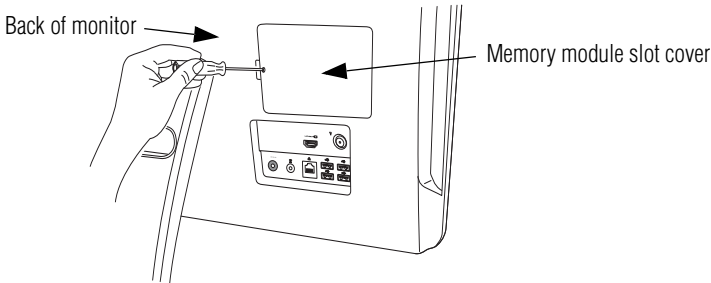

(Sample Illustration) Removing the memory module slot cover

- Remove the memory module slot cover.
- Place the screw and the cover in a safe place so that you can retrieve them later.

CAUTION

Static electricity can damage the memory module. Before you handle the module, touch a grounded metal surface to discharge any static electricity you may have built up.

CAUTION

Avoid touching the connector on the memory module or on the computer. Grease or dust on the connector may cause memory access problems.

- Carefully remove the new memory module from its antistatic packaging, without touching its connector.
- Locate an empty memory module slot on the back of the computer.

NOTE

If no memory slot is available, you must remove a module by performing steps 2-3 of [“Removing a memory module”](#) on page 35.

NOTE

If your system has the memory modules stacked on top of one another, you must remove the top module first before removing/installing the bottom module.

NOTE For this model, Slot A is the bottom slot. Slot B is the top slot. If only one memory module is to be installed, it must be installed in Slot A.

- 9** Pick up the memory module by its sides, avoiding any contact with its connector. Position the module toward the socket, aligning the connector's notch with the matching key in the socket.

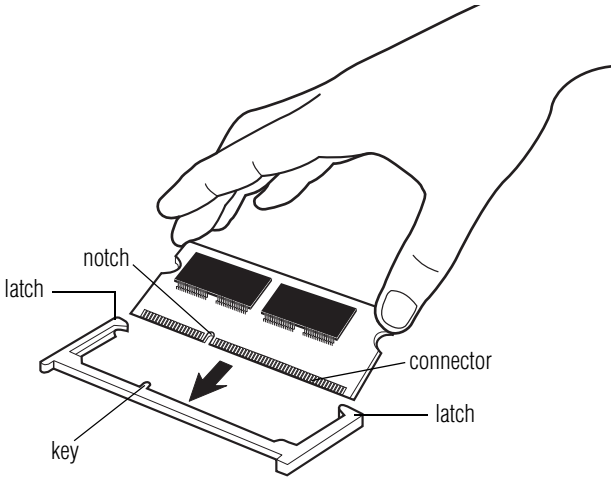

(Sample Illustration) Aligning the memory module with the socket

- 10** Firmly press the memory module into the memory slot's socket at approximately a 30-degree angle (to the horizontal surface of the computer).

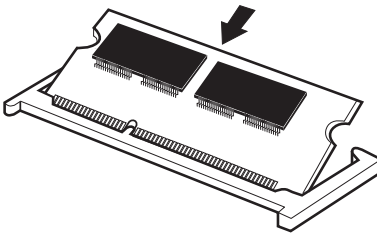

(Sample Illustration) Inserting the memory module into the socket

- 11 Once the module's connector is fully inserted into the socket, press downward on the top edge of the module to seat the module into the latches at the sides of the socket. These latches should "snap" into place securely with the corresponding cutouts in the side of the module. If the latches and cutouts do not line up correctly, repeat steps 10-11.

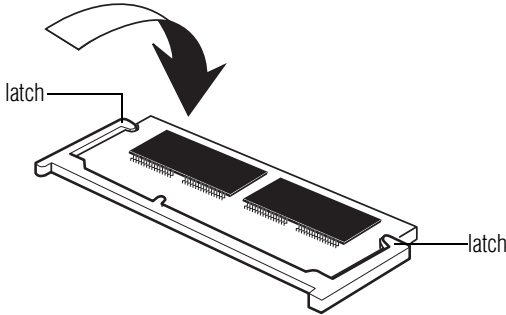

(Sample Illustration) Pressing down on the memory module

Do not force the memory module into position. The memory module should be completely inserted into the socket and level when secured in place.

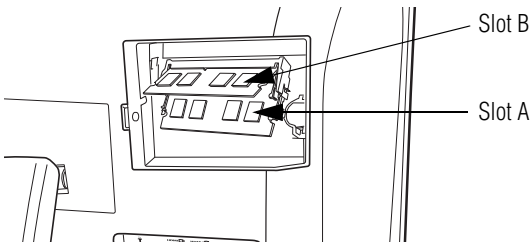

(Sample Illustration) Inserting the memory module into the slot

NOTE

For this model, Slot A is the bottom slot. Slot B is the top slot. If only one memory module is to be installed, it must be installed in Slot A.

- 12 Replace the memory module slot cover and secure it using the screw.

WARNING

Always make sure your computer and AC adaptor have adequate ventilation and are protected from overheating when the power is turned on or when an AC adaptor is connected to a power outlet (even if your computer is in Sleep mode). In this condition, observe the following:

- ❖ Never cover your computer or AC adaptor with any object.
- ❖ Never place your computer or AC adaptor near a heat source, such as an electric blanket or heater.
- ❖ Never cover or block the air vents including those located on the back of the computer.
- ❖ Always operate your computer on a hard flat surface.

Overheating your computer or AC adaptor could cause system failure, computer or AC adaptor damage or a fire, possibly resulting in serious injury.

13 Reconnect the cables.

14 Restart the computer.



TECHNICAL NOTE: You must have at least one memory module installed for the computer to work.

You can now continue setting up the computer. When the operating system has loaded, you can verify that the computer has recognized the additional memory module.

If you are adding extra memory after setting up the computer, verify that the computer has recognized it correctly as described in “Checking total memory” on page 37.

Removing a memory module

If you need to remove a memory module:

- 1** Complete steps 1–6 in “Installing a memory module” on page 30 to shut down the computer and open the memory module slot cover.

CAUTION

Do not try to remove a memory module with the computer turned on. You can damage the computer and the memory module.

Do not remove the memory module while the computer is in Sleep or Hibernation mode. The computer could hang up the next time you turn it on and data in memory will be lost. In either of the above cases, the Sleep configuration will not be saved.

NOTE

The following screen may appear when you turn on the power:

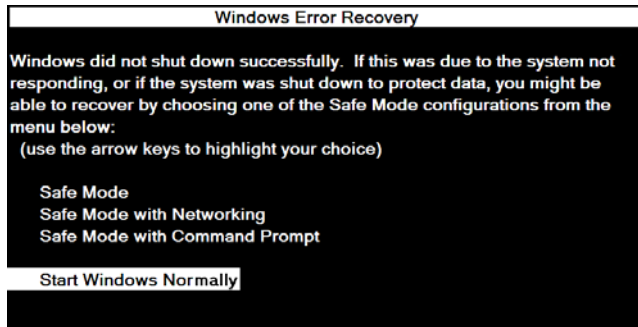

If "Start Windows® Normally" is highlighted, then press Enter.

If one of the Safe Mode options is highlighted, it is best to press Enter to go into Safe Mode, then shut down and restart the system, at which time Windows® should boot back up normally.

When Safe Mode is suggested, this could be a sign that you may need to scan your internal storage drive for errors or defragment the drive. If so, consult Windows® Help and Support.

- 2 Pull the latches away from the memory module.

The memory module pops up slightly.

NOTE

If your system has the memory modules stacked on top of one another, you must remove the top module first before removing/installing the bottom module.

- 3 Gently lift the memory module to a 30-degree angle and slide it out of the slot.

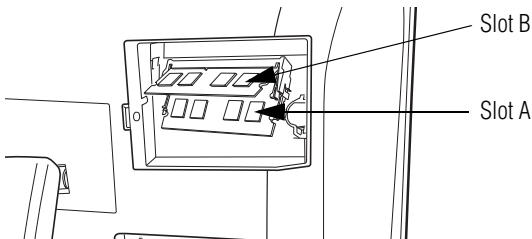

(Sample Illustration) Removing the memory module

-
- 4 Replace the memory module slot cover and secure it using the screw.

⚠ WARNING

Always make sure your computer and AC adaptor have adequate ventilation and are protected from overheating when the power is turned on or when an AC adaptor is connected to a power outlet (even if your computer is in Sleep mode). In this condition, observe the following:

- ❖ Never cover your computer or AC adaptor with any object.
- ❖ Never place your computer or AC adaptor near a heat source, such as an electric blanket or heater.
- ❖ Never cover or block the air vents including those located on the back of the computer.
- ❖ Always operate your computer on a hard flat surface.

Overheating your computer or AC adaptor could cause system failure, computer or AC adaptor damage or a fire, possibly resulting in serious injury.

- 5 Reconnect the cables.
- 6 Restart the computer.



TECHNICAL NOTE: You must have at least one memory module installed for the computer to work.

Checking total memory

When you add or remove a memory module, you can check that the computer has recognized the change. To do this:

- ❖ Click **Start, Control Panel, System and Security**, and then **System**.

The **System** window appears. **Installed memory (RAM)** is displayed below the System heading.

If the computer does not recognize the memory configuration, turn off the computer and remove the memory module slot cover (complete steps 1-6 in “Installing a memory module” on page 30), and then check that the module is inserted completely into the socket and lined up squarely with the socket latches.

NOTE From time to time, Windows® will display a pop-up that says, “Do you want to allow the following program to make changes to this computer?” This is a security feature to prevent programs or people from doing things on your computer without your permission. If you were trying to perform the action, click Continue; otherwise, click Cancel. If unsure, cancel and try again.

Recovering the Internal Storage Drive

Your computer includes recovery utilities to allow you to recover your internal storage drive if necessary.

The following internal storage drive recovery options are available:

Recovery option	Description
Recover to out-of-box state	This option restores the original factory image to your internal storage drive, returning your computer to its out-of-box state. (Recommended recovery method) See “Recovering to out-of-box state (recommended recovery method)” on page 39.
Recovery of factory default software with user’s data	This option recovers the factory default software, while the computer attempts to back up all data from C:\Users. See “Recovering of factory default software with user’s data” on page 42.
Recover without changing the internal storage drive partitions	This option recovers just your C: drive, leaving any other partitions you may have created (for example, a D: drive) intact. See “Recovering without changing the internal storage drive partitions” on page 45.
Recover to a custom size partition	This option allows you to specify a custom size for the C: partition and then restores your C: drive to its out-of-box state. Note: With this option, any changes you made to the C: drive and any other drive partitions you may have created are deleted. See “Recovering to a custom size partition” on page 48.

A recovery image of your computer is stored on the internal storage drive, and the image can be restored by running the recovery utilities directly from your internal storage drive as described in the sections below. However, it is strongly recommended that you create recovery media. If the recovery files on your internal storage drive become corrupted or are deleted, you can restore your system from your recovery media. Also, if your original internal storage drive fails, you can restore your system to a new internal storage drive from your recovery media. It is strongly recommended that you create recovery media before using your system for the first time. See [“Creating recovery media” on page 50](#) and [“Restoring from recovery media” on page 52](#).

NOTE

- ❖ The Toshiba Recovery Wizard also provides the option of erasing your internal storage drive, without restoring the information on the drive. See [“Erasing the Internal Storage Drive” on page 54](#) for more information.
 - ❖ When you restore your system, only the operating system files, applications, and drivers originally shipped with the computer are restored. Any files that you created are not restored during this process. Be sure to separately save the files you have created to external media using Windows® Backup or another backup program. For more information, see [“Backing up your work” on page 68](#).
-

Recovering to out-of-box state (recommended recovery method)

CAUTION

Recovering an internal storage drive to its out-of-box state deletes all partitions on the drive and all information stored in those partitions. Be sure to save your work to external media before executing the recovery. For more information, see [“Backing up your work” on page 68](#).

You can recover the original factory image (returning the computer to its out-of-box state) using the utilities stored on your computer’s internal storage drive or using recovery media, if you have created such media. To recover using the first method, follow the procedure below. To recover using the second method, see [“Restoring from recovery media” on page 52](#).

To recover the original factory image using the utilities on your computer's internal storage drive:

- 1 Make sure the computer is turned off.
- 2 While powering on your computer, press the F12 key when the initial TOSHIBA screen displays.

The boot menu appears.

- 3 Using the arrow keys to scroll down, select the **HDD Recovery** option, and then press the ENTER key.
- 4 A warning screen appears, stating that when the recovery is executed, all data will be deleted and rewritten unless the "Recovery of Factory Default Software with user's data" option is selected in the next step. Click **Yes** to continue.



(Sample Image) Warning screen

- When the Toshiba Recovery Wizard opens and the “Selecting a process” screen displays, select **Recovery of Factory Default Software**, and then click **Next**.

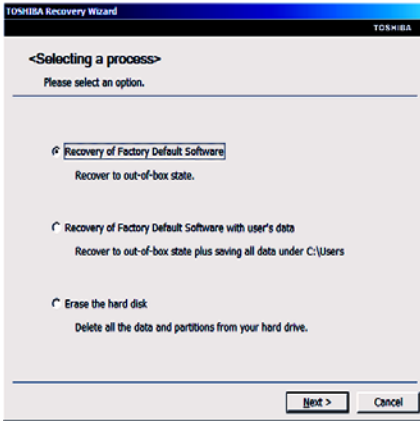

(Sample Image) Selecting a process screen

- The Recovery of Factory Default Software screen appears. Select **Recover to out-of-box state**.

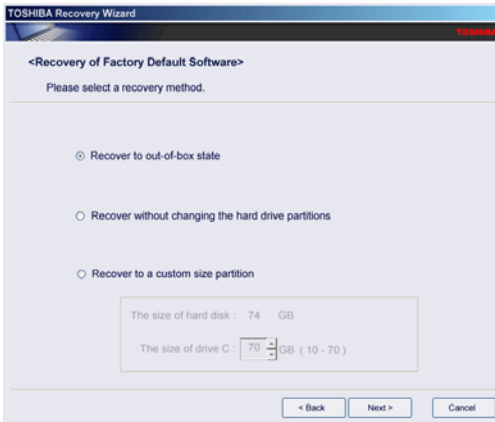

(Sample Image) Recovery of Factory Default Software screen

- Click **Next**.

A confirmation message displays reminding you that all data will be lost during the recovery process. Be sure to save your work to external media before proceeding (see “[Backing up your work](#)” on page 68).

- 8 Click **Next** to begin the recovery.

When the recovery process is complete, a message displays indicating that the internal storage drive has been recovered.

- 9 Click **Finish** to restart the computer.

Recovering of factory default software with user's data

CAUTION

Using "Recovery of Factory Default Software with user's data" recovers your internal storage drive to factory default state and attempts to save C:\Users data to C:\Backup. Toshiba does not guarantee successful data back-up. Please make a complete back up of your data to external media before executing the recovery. For more information, see "[Backing up your work](#)" on page 68.

You can recover the factory default software, while the computer will attempt to back up all of the data from the C:\Users using the utilities stored on your computer's internal storage drive:



TECHNICAL NOTE: The data from C:\Users will be copied into the C:\backup%current date% folder. The directory structure will be retained, however all of the data will be moved to this folder during the recovery process. As a result, any user can access the folders under C:\backup%current date%. To return the data to your private account, you will need to recreate a new account, and drag and drop the data into your personal folders.

- 1 Make sure the computer is turned off.
- 2 While powering on your computer, press the F12 key when the initial TOSHIBA screen displays.

The boot menu appears.

- 3 Using the arrow keys to scroll down, select the **HDD Recovery** option, and then press the ENTER key.

- 4 A warning screen appears, stating that when the recovery is executed, all data will be deleted and rewritten unless the “Recovery of Factory Default Software with user’s data” option is selected in the next step. Click **Yes** to continue.



(Sample Image) Warning screen

- 5 When the Toshiba Recovery Wizard opens and the “Selecting a process” screen displays, select **Recovery of Factory Default Software with user’s data**, and then click **Next**.

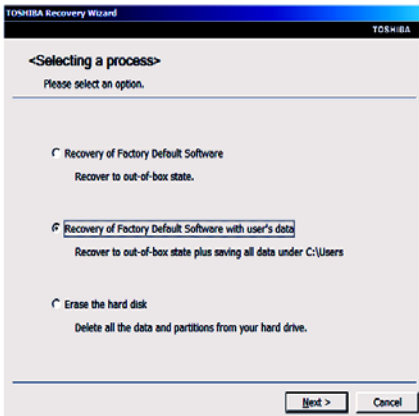

(Sample Image) Selecting a process screen

- 6 A warning screen appears, stating the Toshiba Recovery Wizard will “attempt” to save all data. There is a risk that the Toshiba Recovery Wizard may not be able to save all data during the recovery process.

CAUTION

Toshiba does not guarantee successful data back up. Be sure to save your work to external media before executing the recovery (see “Backing up your work” on page 68).

- 7 Click **Yes** to continue.

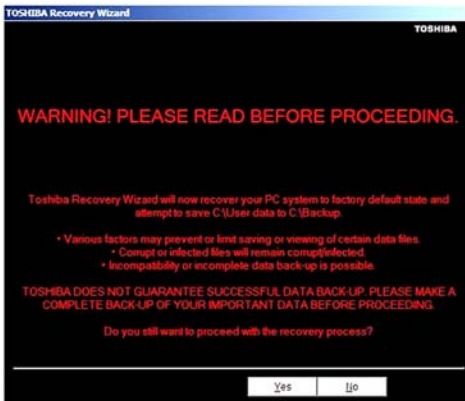

(Sample Image) Warning screen

- 8 When the recovery process is complete, the Recovery of Factory Default Software screen appears, indicating that the recovery process is complete. Click **Finish** to restart the computer.

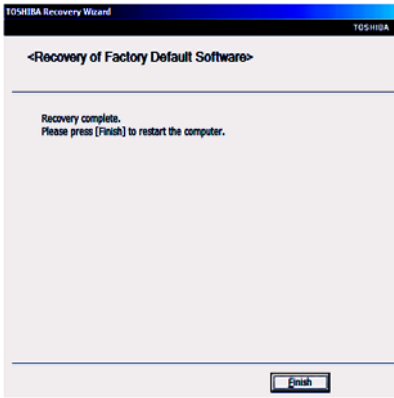

(Sample Image) Recovery of Factory Default Software - Recovery complete

Recovering without changing the internal storage drive partitions

CAUTION

Recovering without changing the internal storage drive partitions deletes all information stored on the C: drive. Be sure to save your work to external media before executing the recovery (see [“Backing up your work” on page 68](#)). If you have created other partitions (for example, a D: drive), those partitions will remain intact and any information on them will not be affected.

You can recover the C: drive without affecting other partitions by either using the utilities stored on your computer’s internal storage drive or by using recovery media, if you have created such media. To recover using the first method, follow the procedure below. To recover using the second method, see [“Restoring from recovery media” on page 52](#).

To recover using the utilities on your computer’s internal storage drive:

- 1 Make sure the computer is turned off.
- 2 While powering on your computer, press the F12 key when the initial TOSHIBA screen displays.
The boot menu appears.
- 3 Using the arrow keys to scroll down, select the **HDD Recovery** option, and then press the ENTER key.

- 4 A warning screen appears, stating that when the recovery is executed, all data will be deleted and rewritten unless the “Recovery of Factory Default Software with user’s data” option is selected in the next step. Click **Yes** to continue.



(Sample Image) Warning screen

- 5 When the Toshiba Recovery Wizard opens and the “Selecting a process” screen displays, select **Recovery of Factory Default Software**, and then click **Next**.

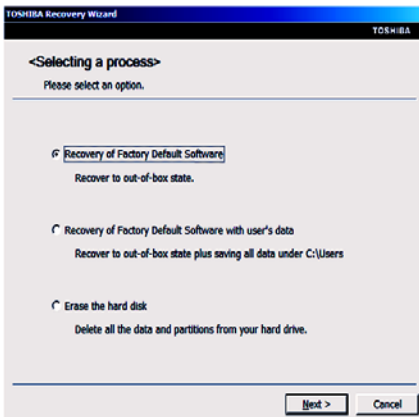

(Sample Image) Selecting a process screen

- The Recovery of Factory Default Software screen appears. Select **Recover without changing the hard drive partitions**.

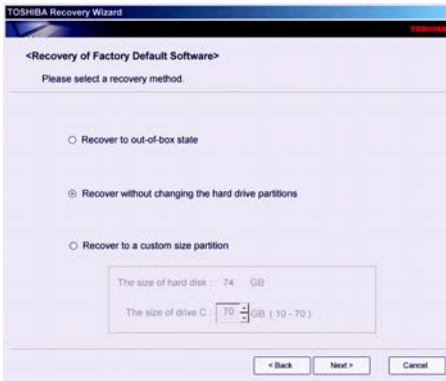

(Sample Image) Recovery of Factory Default Software screen

- Click **Next**.

A confirmation message displays reminding you that all data on the C: drive will be lost during the recovery process. Be sure to save your work to external media before proceeding (see “[Backing up your work](#)” on page 68).

- Click **Next** to begin the recovery.

When the recovery process is complete, a message displays, indicating that the C: drive has been recovered.

- Click **Finish** to restart the computer.

Recovering to a custom size partition

CAUTION

Recovering to a custom size partition deletes all partitions on the drive and all information stored in those partitions. Be sure to save your work to external media before executing the recovery. For more information, see “[Backing up your work](#)” on page 68.

The “Recover to a custom size partition” option restores your C: drive to its out-of-box state, and allows you to specify the size for the C: partition. You can resize and recover the C: drive using the utilities stored on your computer’s internal storage drive or using recovery media, if you have created such media. To recover using the first method, follow the procedure below. To recover using the second method, see “[Restoring from recovery media](#)” on page 52.

To resize and recover the C: drive using the utilities on your computer’s internal storage drive:

- 1 Make sure the computer is turned off.
- 2 While powering on your computer, press the F12 key when the initial TOSHIBA screen displays.

The boot menu appears.

- 3 Using the arrow keys to scroll down, select the **HDD Recovery** option, and then press the ENTER key.
- 4 A warning screen appears, stating that when the recovery is executed, all data will be deleted and rewritten unless the “Recovery of Factory Default Software with user’s data” option is selected in the next step. Click **Yes** to continue.



(Sample Image) Warning screen

- 5 When the Toshiba Recovery Wizard opens and the “Selecting a process” screen displays, select **Recovery of Factory Default Software**, and then click **Next**.

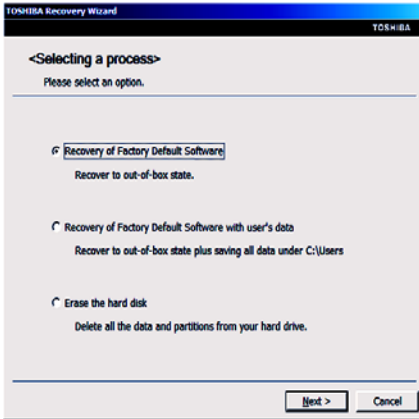

(Sample Image) Selecting a process screen

- 6 The Recovery of Factory Default Software screen appears. Select **Recover to a custom size partition**.

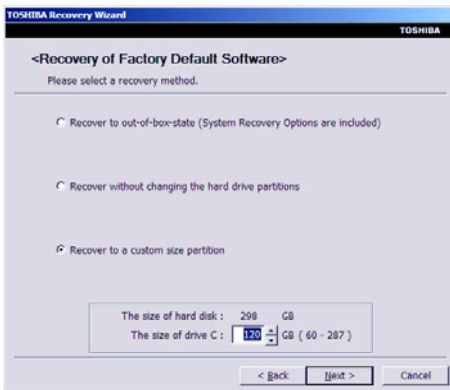

(Sample Image) Recovery of Factory Default Software screen

7 Use the on-screen arrow buttons in **The size of drive C:** field to set the partition size.

8 Click **Next**.

A confirmation message displays reminding you that all data will be lost during the recovery process. Be sure to save your work to external media before proceeding (see [“Backing up your work” on page 68](#)).

9 Click **Next** to begin the recovery.

When the recovery process is complete, a message displays indicating that the C: drive has been recovered.

10 Click **Finish** to restart the computer.

Creating recovery media

It is strongly recommended that you create recovery media. If the recovery files on your internal storage drive become corrupted or are deleted, you can restore your system from your recovery media. Also, if your original internal storage drive fails, you can restore your system to a new internal storage drive from your recovery media.

NOTE

When you create recovery media, only the operating system files, applications, and drivers originally shipped with the computer are backed up to the external media and can be restored from this media. Any files that you created are not backed up on the recovery media. You will need to separately back up the files you created; for more information, see [“Backing up your work” on page 68](#).

When you create recovery media, the system will prompt you to insert several blank DVDs or connect one or more USB flash drives of a certain minimum capacity to your computer. The amount of space required for storing the recovery files varies by computer model. Follow the procedure below to determine how much space you will need for storing your system’s recovery files.

To create recovery media:

- 1 Click the **Start** button and, in the Search field, type **Recovery Media Creator**. In the list that appears above, click on your selection.

The TOSHIBA Recovery Media Creator dialog box displays.

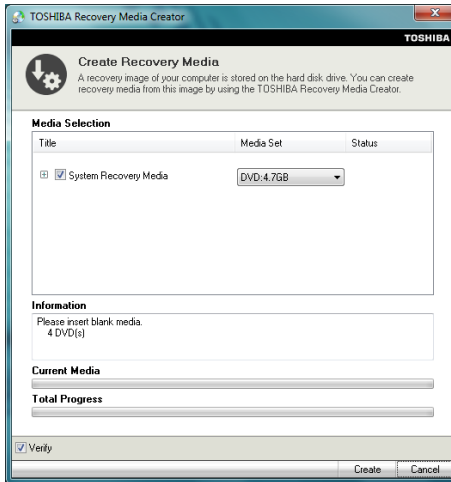

(Sample Image) TOSHIBA Recovery Media Creator dialog box

- 2 Select **DVD** or **USB Flash** from the drop-down list next to “System Recovery Media,” depending on the type of external media you want to use.
- 3 Check the **Information** area of the dialog box to determine the number of DVDs you will need and/or the minimum amount of storage space required for copying your system’s recovery files to USB flash drive(s).
- 4 Do one of the following:
 - ❖ If you are copying files to DVD, insert a blank DVD into the optical disc drive.
 - ❖ If you are copying files to a USB flash drive, connect a USB flash drive of the required minimum capacity (as specified in the TOSHIBA Recovery Media Creator utility) to your computer.

CAUTION

All information stored on your DVDs or USB flash drive(s) will be erased during the process of creating the recovery media. Be sure to save the information stored on your external media to another storage device before executing this procedure, or use blank media.

- 5 Click the **Create** button in the TOSHIBA Recovery Media Creator utility dialog box.
 - 6 Follow the on-screen prompts to complete the copy process.
-

NOTE If you are copying the recovery files to DVDs, be sure to label each DVD in the set sequentially (for example, “1 of 3,” “2 of 3,” etc.), so that you will know in which order to insert the discs during recovery.

For information on using the Recovery media you have created with the preceding steps, see [“Restoring from recovery media” on page 52](#).

Restoring from recovery media

CAUTION

The recovery process deletes information stored on the internal storage drive. Be sure to save your work to external media before executing the recovery (see [“Backing up your work” on page 68](#)).

If you have created recovery media for your system, you can restore your system from such media, if necessary. For example, if your original internal storage drive fails, you can restore your system to a new internal storage drive from your recovery media. For instructions on creating recovery media, see [“Creating recovery media” on page 50](#).

With recovery media, you can:

- ❖ Recover to out-of-box state (recommended recovery method)
- ❖ Recovery of factory default software with user’s data
- ❖ Recover without changing the internal storage drive partitions
- ❖ Recover to a custom size partition

For more information on these options, see [“Recovering the Internal Storage Drive” on page 38](#).

NOTE When you restore your system, only the operating system files, applications, and drivers originally shipped with the computer are restored. Any files that you created are not restored during this process. Be sure to separately save the files you have created to external media using Windows® Backup or another backup program. For more information, see [“Backing up your work” on page 68](#).

To recover your internal storage drive from recovery media:

- 1 Make sure your computer is turned off.
- 2 Do one of the following:
 - ❖ If your recovery files are on DVDs, insert the first recovery DVD into your optical disc drive.
 - ❖ If your recovery files are on a USB flash drive, connect the USB flash drive to your computer.
- 3 Turn on your computer. When the initial TOSHIBA screen displays, press the F12 key on your keyboard.

The boot menu displays.
- 4 Using the arrow keys, select the **DVD** option or the **USB Flash** option, depending on which type of media you are using, and then press the Enter key.
- 5 A warning screen appears, stating that when the recovery is executed all data on your internal storage drive will be deleted and rewritten unless the “Recovery of Factory Default Software with user’s data” option is selected. Click **Yes** to continue.
- 6 When the Toshiba Recovery Wizard opens and the “Selecting a process” screen displays, select **Recovery of Factory Default Software**, and then click **Next**.
- 7 Select one of the following options:
 - ❖ **Recover to out-of-box state** (recommended recovery method)—If you want to recover the original factory image
 - ❖ **Recover without changing the hard drive partitions**—If you want to recover the C: partition only, leaving other partitions you have created intact
 - ❖ **Recover to a custom size partition**—If you want to recover the C: drive to its out-of-box state and specify a custom size for the C: drive. Note: This option deletes all other partitions from the drive.
- 8 Follow the on-screen instructions to complete the recovery process.

When the recovery process is complete, a message displays indicating that the drive has been recovered.
- 9 Click **Finish** to restart the computer.

Erasing the Internal Storage Drive

CAUTION

Erasing the internal storage drive will delete all data on the drive, including the partitions. Be sure to create recovery media and back up your data to external media before erasing the internal storage drive.

NOTE

If you want to restore the internal storage drive, use one of the recovery options instead of erasing the drive. For more information, see [“Recovering the Internal Storage Drive”](#) on page 38.

To delete all data and partitions from the internal storage drive:

- 1 Access the Toshiba Recovery Wizard on your internal storage drive or on your recovery media.
 - ❖ **To access the Recovery Wizard on your internal storage drive:** While powering on your computer, press the F12 key when the initial TOSHIBA screen displays. The boot menu appears. Using the arrow keys to scroll down, select the **HDD Recovery** option, and then press the ENTER key. Read the Warning screen that displays, and then click **Yes** to continue.
 - ❖ **To access the Recovery Wizard on your recovery media:** Turn off your computer. Insert the first recovery DVD into your optical disc drive or connect the USB flash drive containing your recovery files to your computer, and then power on the computer. When the initial TOSHIBA screen displays, press F12. Using the arrow keys, select the **DVD** or **USB Flash** option on the boot menu, depending on which type of media you are using, and then press Enter. Select **Toshiba Recovery Wizard**, and then click **Next**.
- 2 Select **Erase the hard disk**, and then click **Next**.
- 3 Choose one of the following options on the Erase the hard disk screen:
 - ❖ **Delete all data and partitions from the hard disk**—This option deletes all of the data on the internal storage drive without overwriting the drive.
 - ❖ **Delete all partitions and overwrite all sectors on the hard disk**—This option deletes all data and then overwrites the entire internal storage drive for security.

purposes. This process may take several hours, depending on the size of your internal storage drive.

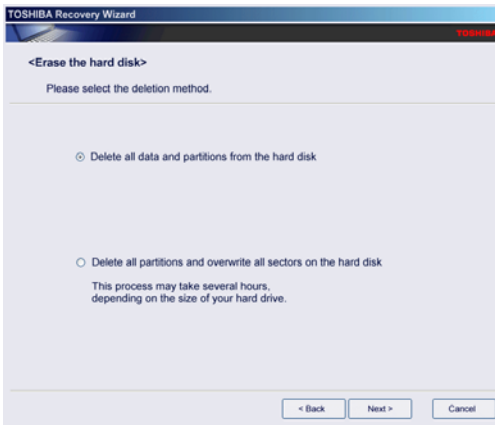

(Sample Image) Erase the hard disk screen

4 Click **Next**.

A confirmation message displays reminding you that all data on the internal storage drive will be lost. Be sure you have saved your work to external media (see [“Backing up your work” on page 68](#)) and created recovery media (see [“Creating recovery media” on page 50](#)) before proceeding.

5 Click **Next** to begin erasing the internal storage drive.

When the recovery process is complete, a message displays, indicating that the internal storage drive has been erased.

6 Click **Finish** to restart the computer.

Checking the internal storage drive operating status

After restoring your internal storage drive, you can check its status as follows:

- 1 Click **Start** button and, in the Search field, type **Computer Management**. In the list that appears above, click on your selection.
- 2 Click **Disk Management**.

Installing drivers and applications

The TOSHIBA Application Installer allows you to reinstall the drivers and applications that were originally bundled with your computer.

To reinstall drivers and applications:

- 1 Click the **Start** button and, in the Search field, type **TOSHIBA Application Installer**. In the list that appears above, click on your selection.
- 2 Click **Next**.
- 3 Click the item you want to install.
- 4 Click **Install**.
- 5 Follow the on-screen prompts to complete the installation process.

Connecting an external device

You can easily attach an external device your computer.

To do this:

- 1 Read the directions that came with the device to see if you first need to install new software.
- 2 Connect the device's video or USB cable to the port on the computer and to the device.
- 3 Connect the device's power cable to a live electrical outlet (if applicable).
- 4 Turn on the external device (if applicable).

Your computer may automatically detect the external device.

Using external display devices

Your computer comes with a built-in display, but you can also connect the following types of external display devices to the video ports described below:



Using the HDMI™ In port

Your computer comes with an HDMI™ In port, allowing you to connect to a video gaming console or DVD player.

NOTE

Locate the HDMI™ In port on the Quick Start Card that shipped with your computer.

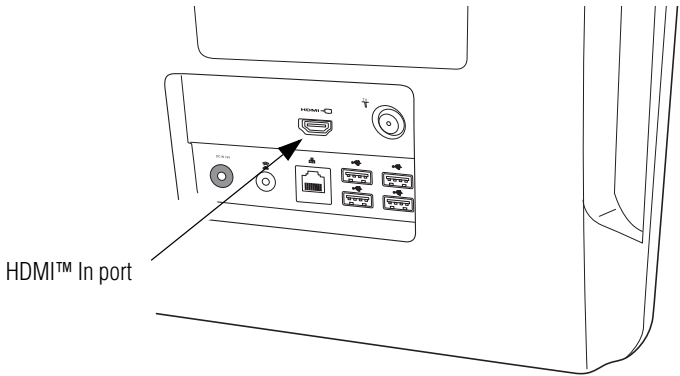

(Sample Illustration) Video ports on back of computer

Customizing your computer's settings

There are several ways in which you can customize your computer to suit your particular requirements. Refer to your operating system documentation or Help and Support for details.

You may also wish to customize your power usage settings. For more information, see “[Power Plans](#)” on page 76. There are additional custom settings you can choose. See “[Utilities](#)” on page 89.

Caring for your computer

This section gives tips on cleaning and moving your computer.

NOTE

Please handle your computer carefully to avoid scratches and damage.

Cleaning the computer

CAUTION

Keep liquids, including cleaning fluid, out of the computer's keyboard, speaker, and other openings. Never spray cleaner directly onto the computer and/or display. Never use harsh or caustic chemical products to clean the computer.

To keep your computer clean, gently wipe with a lightly dampened cloth.

Moving the computer

Before moving your computer to a new location, even across the room, make sure all drive activity has ended (the internal storage drive and optical disc drive indicator lights stop glowing) and all external peripheral cables are disconnected.

▲ WARNING

Before moving your computer, shut down the computer and disconnect the power cable/cord.

Using a computer lock

You may want to secure your computer to a heavy object such as your desk. The easiest way to do this is to purchase an optional computer lock cable. For more information on purchasing a cable lock, visit accessories.toshiba.com.

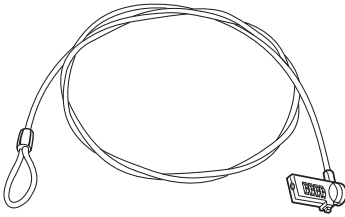

(Sample Illustration) Computer lock cable

To secure the computer:

- 1** Wrap the cable through or around some part of a heavy object. Make sure there is no way for a potential thief to slip the cable off the object.
- 2** Pass the locking end through the loop.
- 3** Insert the cable's locking end into the security lock slot on your computer, then engage the locking device.



The computer is now securely locked.

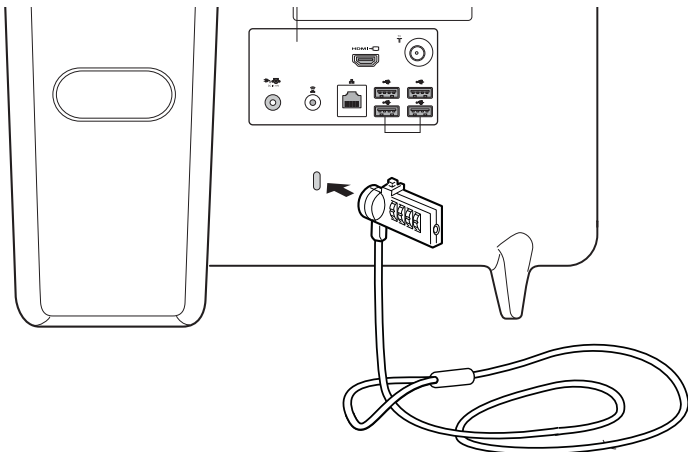

(Sample Illustration) Attaching security lock cable

Chapter 2

Learning the Basics

This chapter gives some computing tips and provides important information about basic features.

Computing tips

- ❖ Save your work frequently.

Your work stays in the computer's temporary memory until you save it to the internal storage drive. If the network you are using goes down and you must restart your computer to reconnect, you will lose all work since you last saved.

See [“Saving your work” on page 67](#) for further information.



HINT: Some programs have an automatic save feature that can be activated. This feature saves your file to the internal storage drive at preset intervals. See your software documentation for details.

- ❖ Back up your files to external media on a regular basis. Label the backup copies clearly and store them in a safe place.

It is easy to put off backing up because it takes time. However, if your internal storage drive suddenly fails, you will lose all the data on it unless you have a separate backup copy. For more information, see [“Data and system configuration backup in the Windows® operating system” on page 124](#).

- ❖ Use Error-checking and Disk Defragmenter regularly to check and optimize disk space and improve performance.
- ❖ Scan all new files for viruses.
This precaution is especially important for files you receive via external media, email, or download from the Internet.
- ❖ Take frequent breaks to avoid repetitive-motion injuries and eyestrain.
- ❖ Do not turn off the computer if a drive indicator light indicates a drive is active.
Turning off the computer while it is reading from or writing to a disk may damage the disk, the drive, or both.

NOTE The Windows® operating system records information, such as your desktop setup, during its shutdown procedure. If you do not let the Windows® operating system shut down normally, details such as new icon positions may be lost.

Using the wireless mouse

Your computer comes with a wireless mouse. The wireless receiver comes installed on your computer.

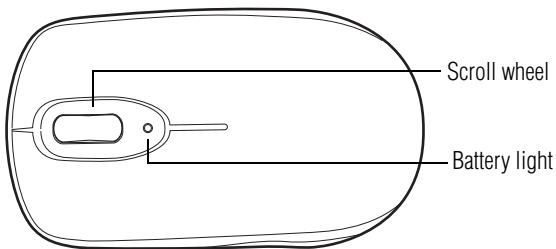

(Sample Illustration) Mouse

Replacing the batteries

Batteries are required to power the wireless mouse. The battery light glows red when the battery power is low.

To replace the batteries:

- 1 Save your work and turn the mouse upside down.

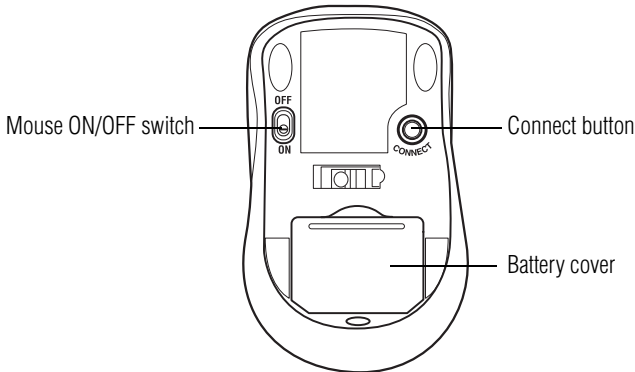

(Sample Illustration) Mouse underside

- 2 Slide the mouse ON/OFF switch on the underside to the OFF position.
- 3 Slide the Battery cover off.
- 4 Always replace both batteries at the same time with fresh ones.
- 5 Replace the battery cover.
- 6 Slide the mouse ON/OFF switch to the ON position.

⚠ WARNING

If a battery is leaking or its case is cracked, put on protective gloves to handle it, and discard it immediately. Always dispose of used battery packs in compliance with all applicable laws and regulations. Put insulating tape, such as cellophane tape, on the electrode during transportation to avoid a possible short circuit, fire or electric shock. Failure to do so could possibly result in serious injury.

Using the wireless keyboard

Your computer comes with a wireless keyboard. The wireless receiver comes installed on your computer.

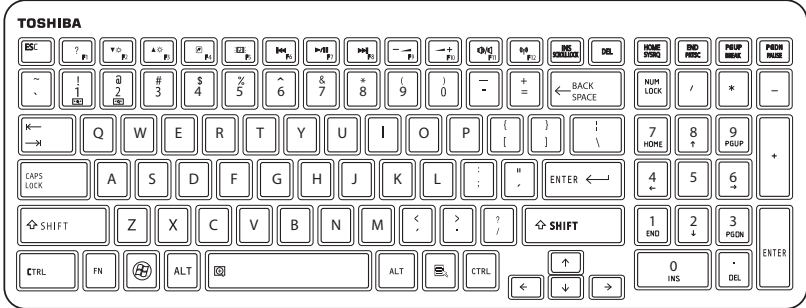

(Sample Illustration) Keyboard

Replacing the batteries

Batteries are required to power the wireless keyboard. The battery light glows red when the battery power is low.

To replace the batteries:

- 1 Save your work and turn the keyboard upside down.

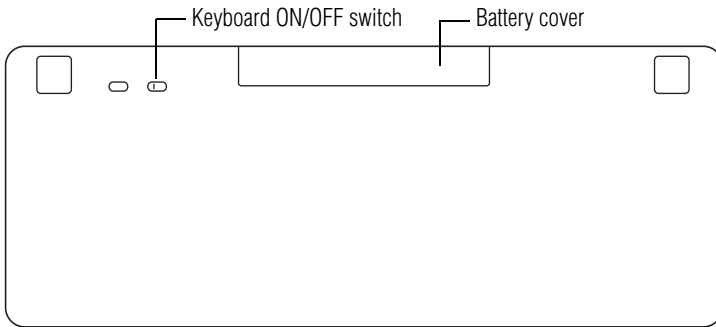

(Sample Illustration) Keyboard underside

- 2 Slide the keyboard ON/OFF switch on the underside to the OFF position.
- 3 Slide the Battery cover off.
- 4 Always replace both batteries at the same time with fresh ones.
- 5 Replace the battery cover.

- Slide the keyboard ON/OFF switch to the ON position.

⚠ WARNING

If a battery is leaking or its case is cracked, put on protective gloves to handle it, and discard it immediately. Always dispose of used battery packs in compliance with all applicable laws and regulations. Put insulating tape, such as cellophane tape, on the electrode during transportation to avoid a possible short circuit, fire or electric shock. Failure to do so could possibly result in serious injury.

Keyboard functions

Your computer's keyboard contains character keys, control keys, function keys, and special Windows® keys.

NOTE To capture a print screen of the entire screen, press the Fn + PRTSC key.

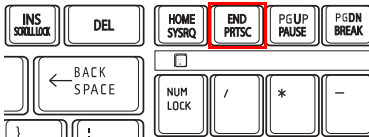

(Sample Illustration) PRTSC key on the keyboard

Character keys

Typing with the character keys is very much like typing on a typewriter, except that:

- ❖ The space bar creates a space character instead of just passing over an area of the page.
- ❖ The lowercase letter l (el) and the number 1 are not interchangeable.
- ❖ The uppercase letter O and the number 0 are not interchangeable.

Ctrl, Fn, and Alt keys



(Sample Illustration) Ctrl, Fn, and Alt keys

The Ctrl, Fn, and Alt keys do different things depending on the program you are using. For more information, see your program documentation.

Function keys

The function keys (not to be confused with the Fn key) are the 12 keys at the top of the keyboard.



(Sample Illustration) Function keys

Special Windows® keys

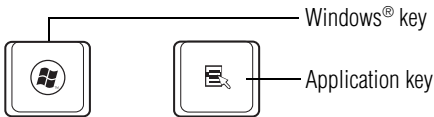

(Sample Illustration) Special Windows® keys

Your computer's keyboard has one key and one button that have special functions in Windows®:

- ❖ **Windows® key**—Opens the Start menu
- ❖ **Application key**—Has a similar function as the secondary mouse button

Touch screen

(Available on certain models.)

Your computer may be enabled with a touch screen feature.

Starting a program

The easiest way to start a program is to double-click the name of the file that contains the information you want to work on. To find the file, use the Start menu or Windows® Explorer.

If you prefer to open the program first, you have three options. You can:

- ❖ Use the Search programs and files field in the Start menu
- ❖ Double-click the icon for the program on your desktop
- ❖ Use the Start menu

The next two sections explain how to start a program from the Start menu, and the Search programs and files field.

Starting a program using the Search programs and files field

This example uses the Start menu's Search programs and files field to start WordPad:

- 1 Click **Start** to display the Start menu.

The Search programs and files field appears at the bottom of the Start menu.

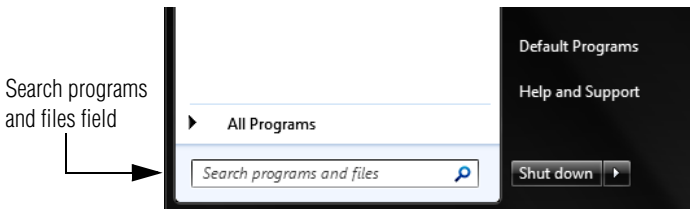

(Sample Image) Search programs and files field in Start menu

- 2 Start typing the program's name (wordpad) in the Search programs and files field.
As you type, all matching files and programs are displayed in a separate window.
- 3 In the search results window, click **WordPad** under Programs.

Starting a program from the Start menu

When you install a program, the operating system usually puts an icon in the All Programs menu. To start a program that has an icon in the All Programs menu, follow these steps, which use the Windows® WordPad program as an example:

- 1 Click **Start**, and then **All Programs**.

The Windows® operating system displays the All Programs menu, which lists programs and program groups. If your program is listed, go to step 3, otherwise, continue with step 2.

NOTE If you pause with your mouse on All Programs, it will open it up. You may need to scroll up or down to see the complete list.

- 2 Click the program group, in this example, **Accessories**.

The Accessories menu is displayed.

- 3 Click the program, in this example, **WordPad**.

WordPad opens.



To close the program, click the **Close** button in the upper-right corner of the program's window.

Saving your work

Before you turn off the computer using the Shut down command, save your work on the internal storage drive, external media, flash media, or optical disc. This is one of the most important rules of computing.

When you turn off the computer using the Sleep or Hibernate commands, your work should be there when you resume.

Many programs offer a feature that saves documents at regular intervals. Check your program's documentation to see if it has an automatic save feature.

Backing up your work

Back up all the files you create in case something happens to your computer. You can back up your files to different types of media such as CDs, DVDs, external storage media, or to a network, if available.

To back up several files at one time, use the Microsoft® Windows® Backup program preinstalled on the computer's internal storage drive. Also see [“Backing up your data or your entire computer with the Windows® operating system”](#) on page 126.



HINT: Backing up all the files on your internal storage drive may take a considerable amount of time and multiple CDs/DVDs. You may prefer to use a high-capacity backup system, such as an external hard drive.

Restoring your work

To restore information from your backup media to your internal storage drive, use the Restore option in the Windows® Backup and Restore program. Look in the online Help or your operating system documentation for information on restoring files.

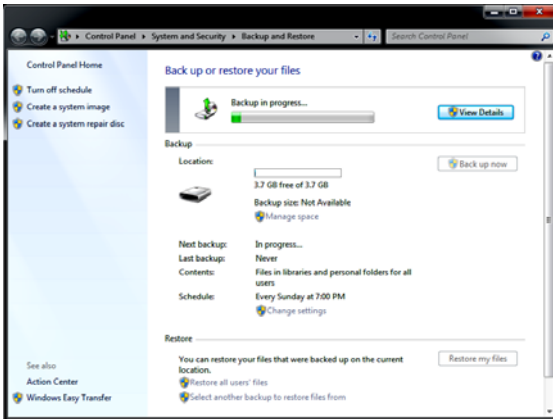

(Sample Image) Backup and Restore screen



TECHNICAL NOTE: When restoring files, the backup program prompts you if you try to overwrite a file that already exists on the internal storage drive. Make sure the backup version is the one you want before overwriting the existing file.

Using the optical disc drive

Optical storage is a popular medium for software, music, and video. Digital versatile discs or Blu-ray™ Discs provide a significant increase in data storage and support features that were not available on previous video platforms. These features include wide-screen movies, multiple language tracks, digital surround sound, multiple camera angles, and interactive menus.



TECHNICAL NOTE: Your optical disc drive is set to play region 1 (North America) for DVD-ROMs or BD-ROMs, depending on the type of drive. If you play a DVD or Blu-ray Disc™ from another region, the drive will automatically change to play in the format of the other region. The drive will allow you to change regions four times. On the fourth change, the region will be “locked in.” That is, the drive will only play DVDs and Blu-ray™ Discs from that last region. Note that changing from region 1 to region 2 and back to region 1 is counted as two changes.

NOTE

When viewing DVD and Blu-ray Disc™ movies use the DVD or Blu-ray Disc™ player software that came with your computer.

Viewing Blu-ray Disc™ movies

Your system may come with a Blu-ray Disc™ drive. Due to differences between High Definition and previous viewing capabilities, consider the following:

- ❖ Some Blu-ray Disc™ movies have online content that can be accessed from the disc. To view this content, your computer must be connected to the Internet.

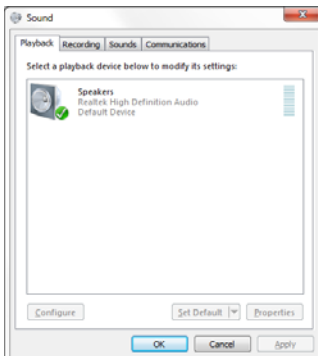

(Sample Image) Sound properties window

- ❖ If you want to use the internal speakers, click on the **Speakers** tab and click **Set Default**.
- ❖ Use the arrow keys on your keyboard to navigate within the Blu-ray Disc™ player console.

NOTE Use of a mouse is not supported within the Blu-ray Disc™ player.

Optical disc drive components

The optical disc drive is located on the side of the computer.

Your optical disc drive may look like this:

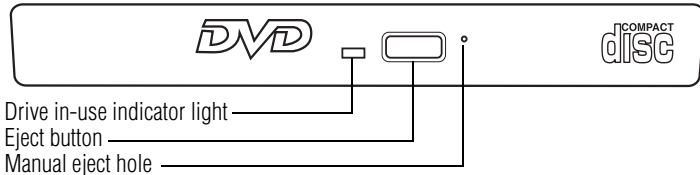

(Sample Illustration) Optical disc drive

Drive in-use indicator light—Indicates when the drive is in use.

Eject button—Press to release the disc tray.

CAUTION

Do not press the eject button or turn off the computer while the drive in-use indicator light is glowing. Doing so could damage the disc or the drive.

When the disc tray is open, be careful not to touch the lens or the area around it. Doing so could cause the drive to malfunction.

Manual eject hole—Use if you need to release the disc tray when the power is off. Use a straightened paper clip or other narrow object to press the manual eject button located inside the hole.

CAUTION

Never use a pencil to press the manual eject button. Pencil lead can break off inside the computer and damage it.

Inserting an optical disc

To insert an optical disc into the drive:

- 1 Make sure the computer is turned on.

The drive will not open if the computer's power is off.

- 2 Make sure the drive's in-use indicator light is off.
- 3 Press the drive's eject button.
The disc tray slides partially out of the drive.
- 4 Grasp the tray and pull it fully open.

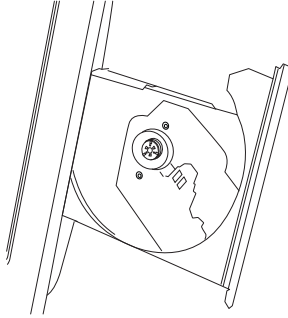

(Sample Illustration) Drive tray fully extended

- 5 Hold the disc by its edges and check that it is free of dust.
If the disc is dusty, clean it with a clean dry cloth.
- 6 Place the disc carefully in the disc tray, label side out.

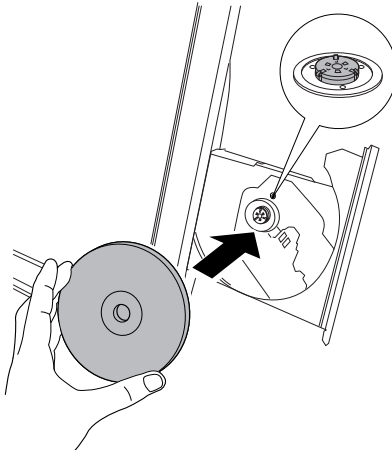

(Sample Illustration) Positioning the disc in the drive

- 7 Gently press the disc onto the center spindle until it clicks into place.

CAUTION

Handle DVDs, Blu-ray™ Discs and CDs carefully, making contact only with the center hole and edge. Do not touch the surface of the disc. Do not stack discs. If you incorrectly handle the discs, you could lose data.

- 8 Make sure the disc is completely on the spindle and is lying flat on the tray.

CAUTION

If you insert the disc incorrectly, it may jam the drive. If this happens, contact Toshiba support for assistance.

- 9 Push the disc tray in by pressing gently on the center of the tray until it clicks into place.

You are ready to use the disc.

Playing an audio CD

Insert an audio CD and close the disc tray.

If the computer is turned on, the default player opens.

- ❖ To play the CD or to pause, click the **Play/pause** button.
- ❖ To stop the CD, click the **Stop** button.

CAUTION

Before putting on headphones to listen, turn the volume down. Do not set the volume too high when using headphones. Continuous exposure to loud sound can harm your hearing.

Playing optical media

If you insert an optical disc into the optical disc drive and the Auto-Run feature does not automatically start your disc, try launching the optical disc manually. To do this, follow these steps:

- 1 Click **Start**, and then **Computer**.
- 2 Double-click the optical disc drive icon.

The drive will run the optical disc.

If your disc does not run using this method, try using an application that is associated with the media on the disc. For example, if it is a music CD, open Windows Media® Player and use it to select and then play the CD. For other types of media, use the associated software to open the files on the disc.

Recording optical media

Depending on the configuration, your computer may come with an optical disc drive that allows you to:

- ❖ Play pre-recorded and recorded optical media.
- ❖ Read/write data and multi-media files to recordable optical media.

For more information regarding supported optical media formats please refer to your computer's detailed specifications at support.toshiba.com.

NOTE

Due to manufacturing and quality variations in third party optical media (e.g., CD or DVD) or optical media players/recorders, in certain cases, your Toshiba optical disc drive may not record on certain optical media that bear the applicable logo, or play back optical media recorded by other computers or optical media recorders. Additionally, certain optical media recorded on your optical disc drive may not play back or operate properly on other computers or optical media players. These problems are not due to any defect in your Toshiba computer or optical disc drive. Please refer to your computer's product specification for listing of specific format compatibilities.

Copy protection technology may also prevent or limit recording or viewing of certain optical media.

For details on how to use the software, please refer to the respective Online Help menus.

Removing a disc with the computer on

To remove an optical disc with the computer turned on:

- 1 Press the eject button on the drive.

CAUTION

Do not press the eject button while the drive in-use indicator light is glowing. Doing so could damage the disc or the drive.

Also, if the disc is still spinning when you open the disc tray, wait for it to stop spinning before you remove it.

- 2 Pull the tray out until it is fully open, remove the disc, and place it in its protective cover.
 - 3 Gently press the tray in to close it.
-

Removing a disc with the computer off

To remove a disc with the computer turned off:

- 1 Insert a slender object, such as a straightened paper clip, into the manual eject hole.

The disc tray slides partially out of the drive.

CAUTION

Never use a pencil to press the manual eject button. Pencil lead can break off inside the computer and damage it.

- 2 Pull the tray out until it is fully open, remove the disc, and place it in its protective cover.
- 3 Gently press the tray in to close it.

Toshiba's online resources

Toshiba maintains a number of online sites to which you can connect. These sites provide information about Toshiba products, give help with technical questions and keep you up to date with future upgrades. For more information, see [“Contacting Toshiba” on page 129](#).

Chapter 3

Computing

Toshiba's energy-saver design

Your computer enters a low-power suspension mode when it is not being used, thereby conserving energy and saving money in the process. It has a number of other features that enhance its energy efficiency.

Many of these energy-saving features have been preset by Toshiba. We recommend you leave these features active, allowing your computer to operate at its maximum energy efficiency, so that you can use it for longer periods.

Power management

Your computer ships with the power management options preset to a configuration that will provide the most stable operating environment and optimum system performance.

CAUTION

Changes to these settings may result in system performance or stability issues. Users who are not completely familiar with the power management component of the system should use the preset configuration. For assistance with setup changes, contact Toshiba's Customer Support Center.

Charging the RTC battery

Your computer has an internal real-time clock (RTC) battery. The RTC battery powers the System Time Clock and BIOS memory used to store your computer's configuration settings. When fully charged, it maintains this information for up to a month when the computer is powered off.

The RTC battery may have become completely discharged while your computer was shipped, resulting in a CMOS error message during startup. The error message may vary by computer model.

NOTE Depending on your system, the RTC battery may only charge while the computer is turned on.

To recharge the RTC battery, plug the computer into a live electrical outlet and leave the computer powered on for 24 hours.

NOTE It is seldom necessary to charge the RTC battery because it charges while the computer is on. If the RTC battery is low, the real-time clock and calendar may display the incorrect time and date or stop working.

When Hibernation mode is enabled and the RTC battery is completely discharged, a warning prompts you to reset the real-time clock.

The computer can be used while the RTC battery is being charged, although the charging status of the RTC battery cannot be monitored.

Power Plans

You can choose a predefined Power Plan or select your own combination of power options. To do this:

- 1 Click the **Start** button and, in the Search field, type **Power Options**. In the list that appears above, click on your selection.

The Windows® Power Options window appears.

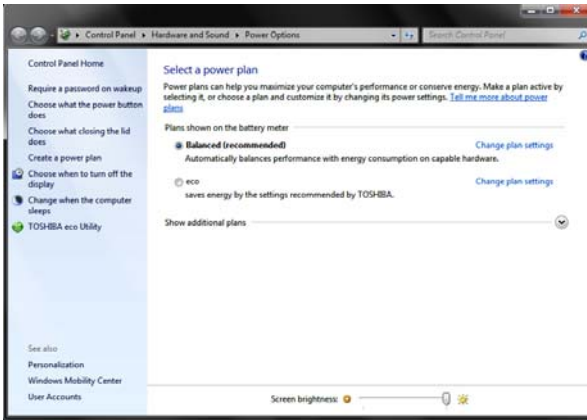

(Sample Image) Windows® Power Options window

- 2 Select an appropriate plan for your work environment or create your own custom plan.
- 3 Click **Create a power plan** in the left pane to set up a new plan.

NOTE

To edit a plan or to edit advanced settings, continue to the following steps.

- 4 Click **Change plan settings** to choose the plan you want to edit.
This screen allows you to change basic settings.
- 5 Click **Change advanced power settings** to access settings for internal storage drive power save time, etc.
You can click on the plus signs to expand each item and to see what settings are available for each item.
- 6 Click **OK** to save the plan changes you have performed.

By default the two power plans eco and Balanced are satisfactory for most people and do not need to be edited.

Using the TOSHIBA eco power plan

This computer is equipped with the TOSHIBA eco power plan. Operating the computer with this power plan enabled reduces electrical power consumption by slightly lowering system performance. For example, when this power plan is enabled, the brightness of the display is reduced and the interval before Sleep mode takes effect is shortened. To enable or disable the TOSHIBA eco power plan, see [“Power Plans” on page 76](#).

The TOSHIBA eco Utility™ monitors your power savings from using the eco power plan by tracking real-time power consumption and accumulated savings over time. To learn how to access the utility, see [“TOSHIBA eco Utility™” on page 107](#).

For more information on the TOSHIBA eco power plan, see the Help file in the TOSHIBA eco Utility™ window.

Chapter 4

Exploring Your Computer's Features

In this chapter, you will explore some of the special features of your computer.

Exploring the desktop

The desktop is the launching pad for everything you can do in the Windows® operating system. You can use its features to start programs, find documents, set up system components, and perform most other computing tasks.



HINT: The illustrated examples in this guide may appear slightly different from the screens displayed by your system. The differences are not significant and do not indicate any change in the functionality of your system.

Finding your way around the desktop

Your computer's desktop includes several standard features: icons, Start button, taskbar, notification area, and background pattern.

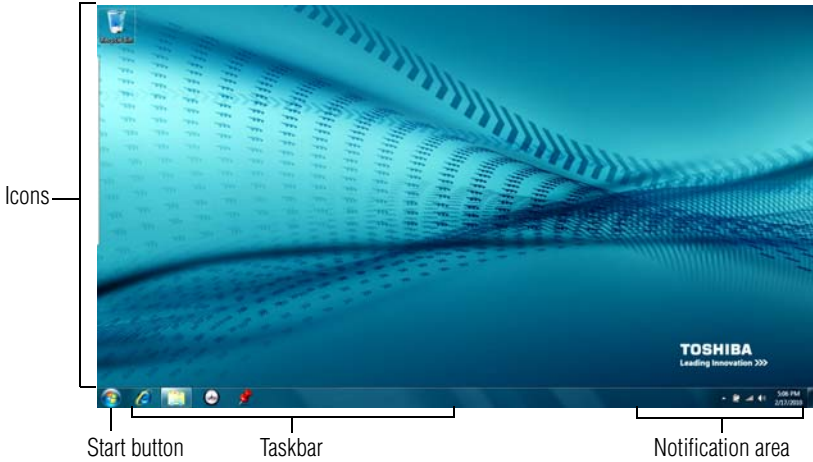

(Sample Image) Windows® operating system desktop

Icons

An icon represents a folder, file, or program that can be quickly activated by double-clicking the icon.

You can create a new desktop icon for any folder, file, or program by dragging the element's icon from its location in a window to the desktop area.

You may see various icons displayed on your system desktop, for example:



Recycle Bin—Holds files you have deleted. You may be able to retrieve these files until you empty the Recycle Bin.



- ❖ **TECHNICAL NOTE:** If you delete a large number of files or very large files from the internal storage drive, there may be insufficient space available in the Recycle Bin to hold these files. In this case, Windows® will prompt you to either permanently delete the file(s) or cancel the deletion.
- ❖ If you delete a file (of any size) from an external media or flash media, it does not go into the Recycle Bin. The file is permanently deleted.
- ❖ Permanently deleted files cannot be recovered from the Recycle Bin.
For more information on the Recycle Bin, see Windows® online Help.

NOTE

If you place the pointer over an icon, a popup description of the file contents appears.

Your desktop may contain other icons depending on your configuration. See Windows® online Help for more specific information on each icon and how to use it.

Start button



You use the Start button to:

- ❖ Start programs
- ❖ Open documents
- ❖ Adjust system settings
- ❖ Find files
- ❖ Access Windows® Help and Support
- ❖ Suspend system activity and shut down the computer

NOTE

Whenever a procedure in this User's Guide instructs you to click Start, it means that you should click the Start button.

Taskbar

Each time you open a program, a button associated with that program appears on the taskbar. With some programs, a button appears on the taskbar for each document or window you open. You can use these buttons to quickly switch between the programs or windows.

To make a program or window the currently active one, click the associated taskbar button.

Notification area

The notification area displays icons of tasks or programs that run continuously in the background and displays notifications. To learn more about each task, position the pointer over the icon for a few moments and a short description of the task appears.

Typical tasks in the notification area are Current time, Power usage mode, network connectivity status, and speaker volume.

To activate a specific task, click the appropriate notification area icon.

Setting up for communications

To connect to the Internet, use an online service, or communicate with another computer, you need:

- ❖ A browser or communications program
- ❖ An Internet Service Provider (ISP) or online service if you plan to use the Internet
- ❖ A way to connect to the ISP (for example Wi-Fi®/LAN, Broadband connection, etc.)

Using Wireless LAN connectivity

NOTE Wireless connectivity and some features may require you to purchase additional software, external hardware or services. Availability of public wireless LAN access points may be limited.

Your system may come with an optional wireless LAN module. This is a technology that expands wireless communication beyond networking equipment, and can connect many different kinds of electronic devices without the need for cables.

For information on how to set up a wireless connection, refer to your wireless networking device documentation or your network administrator.

NOTE To enable or disable wireless communication, press F12. For more information see [“Hot Keys/TOSHIBA Cards” on page 131](#).

For help with common Wi-Fi® networking problems, see [“Wireless networking problems” on page 121](#).

Connecting your computer to a network

You can connect your computer to a network to increase its capabilities and functionality using one of its communication ports.

Accessing a network

To access a network, connect an Ethernet cable to the Network port (RJ45) on your computer. For specific information about connecting to the network, consult your network administrator. Many hotels, airports, and offices offer Wi-Fi® access. If your computer has Wi-Fi®, ask for help when connecting to a Wi-Fi® network.

Exploring audio features

You can use your computer to record sounds using the computer's internal microphone (available on certain models) or an optional external microphone. You can listen to sound files or audio CDs using the built-in speakers, headphones, or external speakers.

Recording sounds

You may record sounds using the computer's internal microphone (available on certain models) or by connecting an optional external microphone.

Using a microphone



- 1 If you want to use an external microphone, connect it to the computer.
- 2 Click the **Start** button and, in the Search field, type **Sound Recorder**. In the list that appears above, click on your selection.

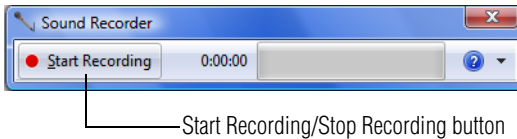

(Sample Image) *Sound Recorder screen*

- 3 Click the **Start Recording** button.
- 4 Speak normally into the microphone.
- 5 When you have finished recording, click the **Stop Recording** button.

The **Save As** dialog box appears.

- 6 To save the file, type a file name, and then click **Save**.

Using external speakers or headphones

Your computer is equipped with a full stereo sound system with internal speakers. Instead of using the internal speakers, you can connect headphones or a pair of external stereo speakers.

CAUTION

Before putting on headphones to listen, turn the volume down. Do not set the volume too high when using headphones. Continuous exposure to loud sound can harm your hearing.



TECHNICAL NOTE: When using amplified speakers, use speakers that require an external power source. Other types of speakers will be inadequate to produce sound from the computer.



To play back sound files through external speakers or headphones:

- 1 Locate the headphone jack on the computer.
- 2 Using any necessary adapters, plug the cable from the headphones or external speakers into the headphone jack.

The headphone jack requires a 16-ohm stereo mini connector.

To adjust the volume:

- ❖ For external speakers, use the volume controls on each speaker.
- ❖ For headphones, use the computer's volume control.



Using the Web Camera

(Available on certain models.)

Your computer may come with a built-in Web Camera. With this Web Camera you can do the following:

- ❖ Take pictures and record videos with your computer
- ❖ Chat with others and have them see you while using instant messaging (IM) programs
- ❖ Have video conference calls

NOTE To email, instant message or video conference, you must be connected to the Internet.

Depending on your computer model, the process of sending email, taking pictures or recording video messages may vary.

To access the Web Camera, click the **Start** button and, in the Search field, type **Web Camera**. In the list that appears above, click on your selection. The Web Camera indicator light glows when the Web Camera is active.

Using the Memory card reader

(Available on certain models.)

The Memory card reader supports the use of Secure Digital™ (SD™ / SDHC / SDXC), or MMC® (MultiMediaCard®) media. These media can be used with a variety of digital products: digital music players, cellular phones, PDAs, digital cameras, digital video camcorders, etc.

CAUTION To use a micro or mini SD™ Card, an SD™ adapter is required.

The Memory card reader may also support other types of media.

NOTE Do not use the Copy Disk function for this type of media. To copy data from one media to another, use the drag-and-drop feature of the Windows® operating system.

Inserting memory media

The following instructions apply to all types of supported media devices.

- 1 Turn the media so that the contacts (metal areas) are face down.
- 2 Push the media into the adapter until it locks in place.

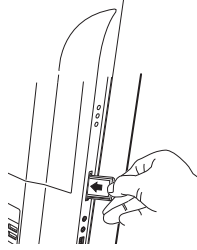

(Sample Illustration) Inserting memory media

CAUTION

When inserting memory media, do not touch the metal contacts. You could expose the storage area to static electricity, which can destroy data.

Removing memory media



- 1 Prepare the card for removal by clicking on the **Show hidden icons** button (▲), if necessary, in the notification area and then selecting the **Safely Remove Hardware and Eject Media** icon.

If the system is unable to prepare the media for safe removal, a message will tell you to try again later. If the media can be removed now, the system displays **Safe to Remove Hardware**. If the computer has a spring-loaded adapter slot, see step 2; otherwise, skip to step 3.

- 2 Gently press the card inward to release it.
The card pops out slightly.
- 3 Grasp the card and pull it straight out.

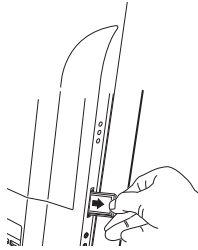

(Sample Illustration) Removing memory media

CAUTION

Do not remove memory media while data is being written or read. Even when the Windows® message “copying...” disappears, writing to the media might still be in progress and your data could be destroyed. Wait for the indicator light to go out.

Toshiba remote control

(Available on certain models.)

Your computer may have shipped with a remote control. You can use your Toshiba remote control to play music and videos, to view pictures, and to watch television programs using the Windows® Media Center.

The remote control helps you navigate media windows on your computer just as a cable TV remote control navigates cable TV options or controls the playback of a video.

Windows® Media Center allows you to:

- ❖ Watch, pause, and record live TV
- ❖ View slide shows of your photos
- ❖ Play any song in your music library, or play CDs or DVDs

Using the Toshiba remote control

To begin using your remote control:

- 1 Point the remote control at the remote control sensor. The remote control sensor is located on the front of your computer. Make sure there is nothing blocking the path between your remote control and the remote control sensor.
- 2 If your computer is powered on, turn it off or place it in Hibernation mode.
- 3 Using the Toshiba remote control, press the green **Start** button.
- 4 The first time you start Windows® Media Center, select **Continue** on the setup page, and then select **Custom**.
- 5 When you reach the page titled **Get the Most from Windows® Media Center**, select **Yes** to allow Media Center to download album cover art, DVD cover art, current TV guide listings, information from online media services, and other useful information.

Chapter 5

Utilities

Your computer includes several utilities designed to help you to reconfigure your system to best meet your individual needs. Together, these allow you to ascertain certain system details, set additional options, or change default options. These utilities are described in this chapter.

NOTE The utilities described in this chapter, and the icons shown in the sample images are applicable only if the related utility is available on your system.

- ❖ TOSHIBA Assist
- ❖ TOSHIBA Application Installer
- ❖ Supervisor password
- ❖ User password
- ❖ TOSHIBA Face Recognition Utility
- ❖ TOSHIBA PC Diagnostic Tool Utility
- ❖ Mouse Utility
- ❖ TOSHIBA Hardware Setup
- ❖ TOSHIBA Sleep Utility
- ❖ TOSHIBA Button Support

- ❖ TOSHIBA Accessibility
- ❖ TOSHIBA eco Utility™
- ❖ TOSHIBA Service Station
- ❖ TOSHIBA PC Health Monitor

TOSHIBA Assist

The TOSHIBA Assist provides quick access to computer functions and allows you to customize a range of computer settings.

To access TOSHIBA Assist, click the **Start** button and, in the Search field, type **TOSHIBA Assist**. In the list that appears above, click on your selection.

The TOSHIBA Assist window appears.

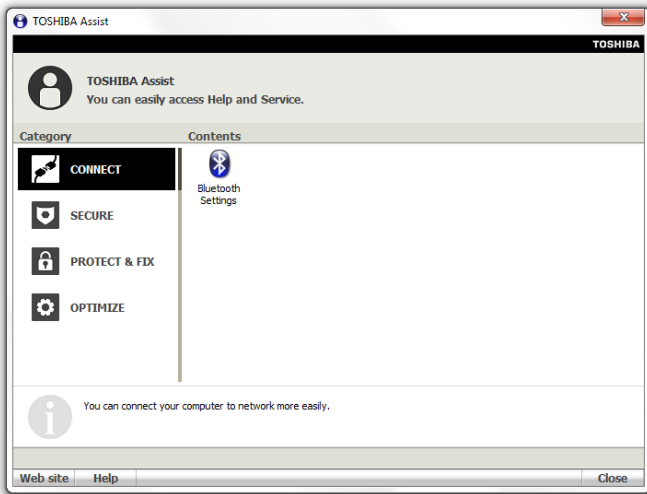

(Sample Image) TOSHIBA Assist window

The TOSHIBA Assist offers four categories of options:

- ❖ Connect
- ❖ Secure
- ❖ Protect & Fix
- ❖ Optimize

Connect

The feature available in this category is *Bluetooth*® Settings.

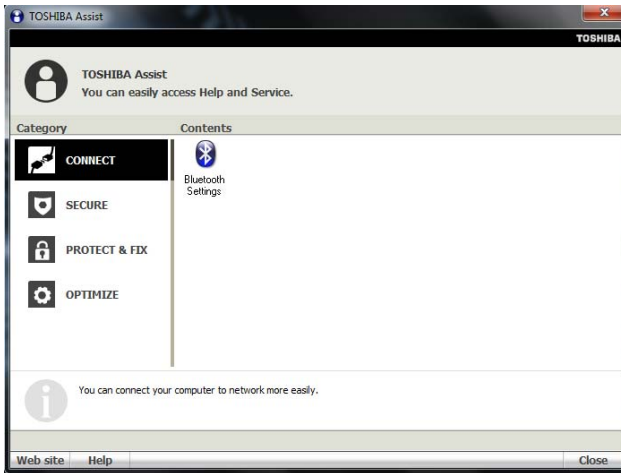

(Sample Image) TOSHIBA Assist window – Connect tab

Secure

The features available in this category are:

- ❖ Supervisor password
- ❖ User password

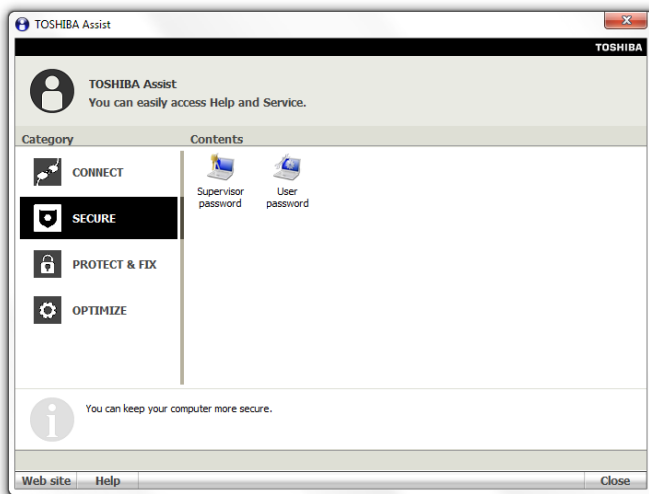

(Sample Image) TOSHIBA Assist window – Secure tab

Protect & Fix

The feature available in this category is:

- ❖ TOSHIBA PC Diagnostic Tool Utility

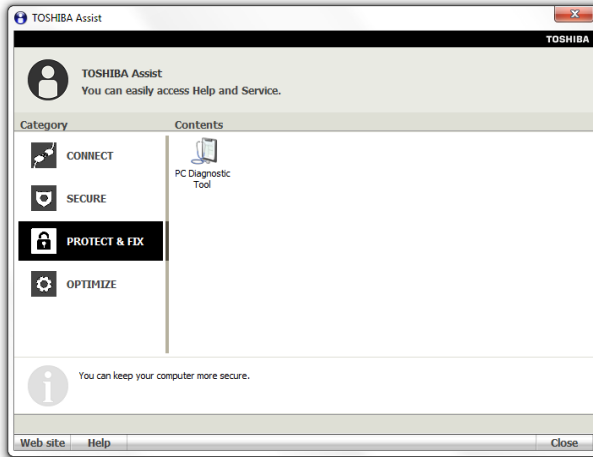

(Sample Image) TOSHIBA Assist window – Protect & Fix tab

Optimize

The features available in this category are:

- ❖ Mouse Utility
- ❖ TOSHIBA Hardware Setup (Hardware Settings)
- ❖ TOSHIBA Button Support
- ❖ TOSHIBA Accessibility
- ❖ TOSHIBA Face Recognition Utility
- ❖ TOSHIBA Sleep Utility
- ❖ TOSHIBA eco Utility™

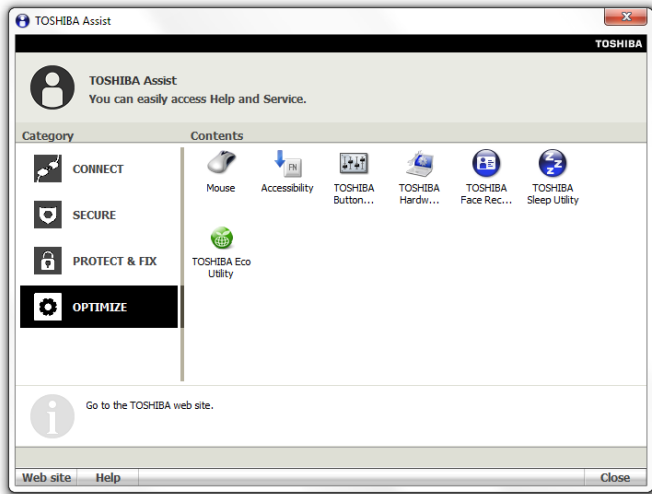

(Sample Image) TOSHIBA Assist window – Optimize tab

TOSHIBA Application Installer

The TOSHIBA Application Installer allows you to reinstall the drivers and applications that were originally bundled with your computer.

To reinstall drivers and applications:

- 1 Click the **Start** button and, in the Search field, type **TOSHIBA Application Installer**. In the list that appears above, click on your selection.
- 2 Click **Next**.



(Sample Image) TOSHIBA Application Installer screen

- 3 Click the item you want to install.

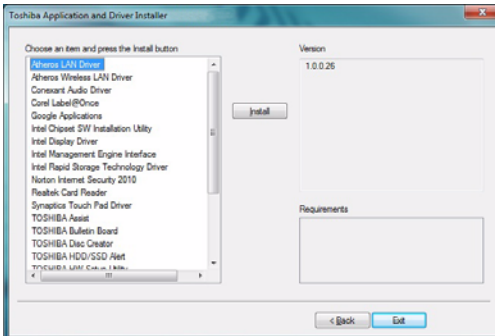

(Sample Image) TOSHIBA Application Installer selection screen

- 4 Click **Install**, then follow the on-screen prompts to complete the installation process.

Setting passwords

Setting a password lets you walk away from your computer while providing additional protection for your files. When you set a password, you must enter the password before you can work on your computer again.

TOSHIBA supports several types of passwords on your computer:

- ❖ An instant password—Secures your open programs and files when leaving the computer temporarily.

NOTE You need to have created a password for your Windows® account to use an instant password.

- ❖ A power-on password—Prevents unauthorized users from starting the computer.
- ❖ A supervisor password—Prohibits unauthorized users from accessing certain functions such as TOSHIBA Hardware Setup. This is useful if more than one person uses the computer.

When setting up passwords, keep the following in mind:

- ❖ The user password can be set up under the supervisor password.
- ❖ The supervisor password must be set before the user password, or the user password must be deleted and then re-entered after the supervisor password is set.

Using a supervisor password

A supervisor password prevents other users from changing hardware configuration options.

Setting a supervisor password

CAUTION

If you choose to set a supervisor or user password, TOSHIBA strongly recommends that you save your password in a location where you can later access it should you not remember it.

TOSHIBA is not responsible for any losses that may occur to you, your organization or others as a result of the inability to access your computer.

To set a supervisor password:

- 1 Click the **Start** button and, in the Search field, type **TOSHIBA Assist**. In the list that appears above, click on your selection.

The TOSHIBA Assist window appears.

- 2 On the left side, click the **Secure** tab.

- 3 Click the **Supervisor Password** icon.

The Supervisor Password tab of the TOSHIBA Password Utility window appears.

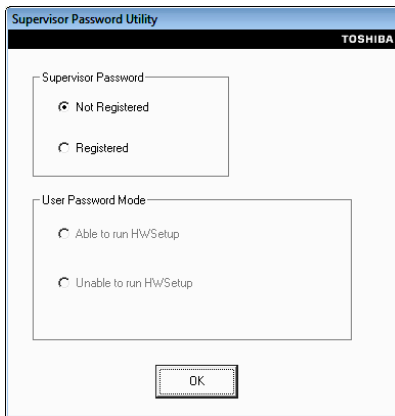

(Sample Image) Supervisor Password tab

- 4 Click **Registered**.

- 5 Enter your password, and then enter it again to verify.

- 6 Click **OK**.

The supervisor password utility dialog box appears.

- 7 Select **Able to run HWSetup** or **Unable to run HWSetup** and then Click **OK**.

- 8 Restart the system to complete the process.

Deleting a supervisor password

To delete a supervisor password:

- 1 Click the **Start** button and, in the Search field, type **TOSHIBA Assist**. In the list that appears above, click on your selection.

The TOSHIBA Assist window appears.

- 2 On the left side, click the **Secure** tab.



- 3 Click the **Supervisor Password** icon.
The Supervisor Password tab of the TOSHIBA Password Utility window appears.
- 4 Click **Not Registered**.
A pop-up screen appears asking for a password.
- 5 Enter the password, then click **OK**.
- 6 Click **OK** to exit.
- 7 Restart the system to complete the process.

Using a user password

A user password provides power-on password protection.

Setting a user password

CAUTION

If you choose to set a supervisor or user password, TOSHIBA strongly recommends that you save your password in a location where you can later access it should you not remember it.

TOSHIBA is not responsible for any losses that may occur to you, your organization or others as a result of the inability to access your computer.

To register a password for the power-on password functions:

- 1 Click the **Start** button and, in the Search field, type **TOSHIBA Assist**. In the list that appears above, click on your selection.
The TOSHIBA Assist window appears.
- 2 On the left side, click the **Secure** tab.
- 3 Click the **User Password** icon.
- 4 Click **Registered**.
- 5 Enter your password, and then enter it again to verify.
- 6 Click **OK**.
- 7 Click **OK** to exit.

Deleting a user password

To cancel the power-on password function:

- 1 Click the **Start** button and, in the Search field, type **TOSHIBA Assist**. In the list that appears above, click on your selection.
The TOSHIBA Assist window appears.

- 2 On the left side, click the **Secure** tab.
- 3 Click the **User Password** icon.
- 4 Click **Not Registered**.
- 5 Follow the on-screen instructions to remove the user password.



TOSHIBA Face Recognition Utility

Your computer may come with the TOSHIBA Face Recognition utility. This utility provides another way to log on to your computer.

NOTE

For high security purposes, TOSHIBA Face Recognition is not a suitable substitute for Windows® passwords. To ensure the security of your system use your established Windows® passwords to log on.

Please refer to the online help file to learn more about this utility and what it offers:

- ❖ Setting up a Face Recognition account
- ❖ Registering a user image
- ❖ Updating a user image
- ❖ Changing a user image
- ❖ Deleting a user image
- ❖ Configuring Settings
- ❖ Authentication Functions

Please note that some changes to the likeness of a registrant, such as hair style changes or wearing a cap or glasses, may affect the recognition rates when such changes occur after the registrant's image has been registered.

TOSHIBA Face Recognition does not guarantee the correct identification of a user and may incorrectly recognize faces that are similar to the registrant's. In addition, bright background light and or shadows may prevent a registrant from being recognized correctly. If recognition fails, log on to your computer using your Windows® password.

TOSHIBA does not guarantee that the face recognition utility technology will be completely secure or error-free. TOSHIBA does not guarantee that the face recognition utility will accurately screen out unauthorized users at all times. TOSHIBA is not liable for any failure or damage that might arise out of the use of the face recognition software or utility.

TOSHIBA PC Diagnostic Tool Utility

This utility can help diagnose problems with devices in your computer. Refer to the online Help documentation within the application for additional help.

NOTE The TOSHIBA PC Diagnostic Tool utility may show tests for features you do not have. This is normal and does not indicate a problem.

To use the TOSHIBA PC Diagnostic Tool utility:



- 1 Click the **Start** button and, in the Search field, type **PC Diagnostic Tool**. In the list that appears above, click on your selection. Or click the **PC Diagnostic Tool** icon in the **Protect & Fix** tab of **TOSHIBA Assist**.

The TOSHIBA PC Diagnostic Tool window appears.

- 2 Click the **Diagnostic Tool** tab.

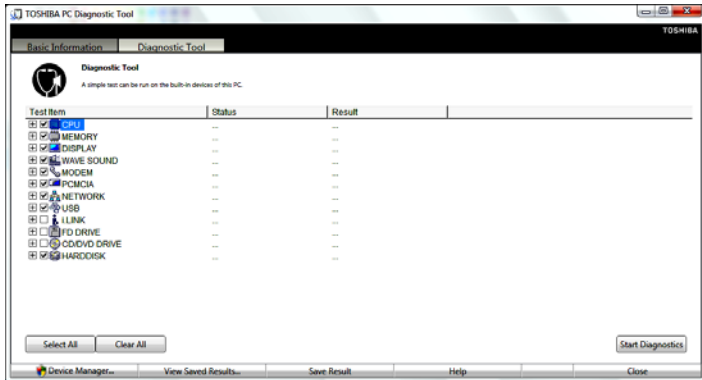

(Sample Image) TOSHIBA PC Diagnostic Tool window

- 3 Select the devices that you would like to test by clicking the check box that appears to the left of the device.

NOTE Click the + (plus) and - (minus) symbols to expand and collapse the categories.

- 4 Click **Start Diagnostics** when you are ready to begin the tests.

Mouse Utility

The Mouse utility allows you to change your pointing device or mouse settings.

To access the Mouse utility:

- 1 Click the **Start** button and, in the Search field, type **Mouse**. In the list that appears above, click on your selection, or click the **Mouse** icon in the **Optimize** tab of [TOSHIBA Assist](#).



The Mouse Properties screen appears.

The settings you can change are divided into these categories:

- ❖ Buttons
- ❖ Pointers
- ❖ Pointer Options
- ❖ Wheel
- ❖ Hardware

You may see additional categories depending on your particular pointing device.

- 2 Adjust the settings as desired, then click **OK**.

TOSHIBA Hardware Setup

TOSHIBA Hardware Setup is the TOSHIBA configuration management tool available through the Windows® operating system. To access it:

- ❖ Click the **Start** button and, in the Search field, type **HWSetup**. In the list that appears above, click on your selection. Or click the **TOSHIBA Hardware Settings** icon in the **Optimize** tab of **TOSHIBA Assist**.



The TOSHIBA HWSetup screen appears.

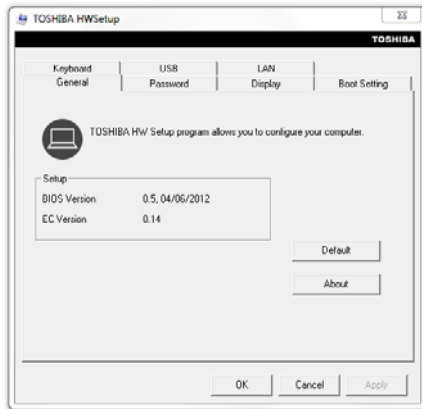

(Sample Image) TOSHIBA HWSetup screen – General tab options

The TOSHIBA HWSetup screen may have the following tabs:

- ❖ **Boot Setting**—Allows you to change the sequence in which your computer searches the drives for the operating system. You can also manually choose the Boot Priority by pressing the power button to power on the computer, then quickly pressing the F12 key. Select the boot device by pressing the arrow keys, then pressing the Enter key.
- ❖ **Boot Speed**—Reduces the time needed for the BIOS to initialize, using either the **Fast** or **Normal** settings.

NOTE

Since the system is a quick-booting system, you must press the keys immediately after pressing the power button.

- ❖ **General**—This tab allows you to view the current BIOS version or change certain settings back to their default values
- ❖ **LAN**—This tab allows you to set networking functions

- ❖ **Password**—This tab allows you to set a user password
- ❖ **Display**—This tab allows you to select the internal LCD and/or external monitor when the computer boots up.
- ❖ **Keyboard**—This tab allows you to set conditions for the keyboard.
- ❖ **USB**—This tab allows you to set conditions for USB.

TOSHIBA Sleep Utility

This utility displays whether the “USB Sleep and Charge function” is enabled or disabled and shows the position of the USB port that supports the “USB Sleep and Charge function.”

Starting the TOSHIBA Sleep Utility

Click the **Start** button and, in the Search field, type **Sleep Utility**. In the list that appears above, click on your selection.

USB Sleep and Charge

Your computer can supply USB bus power (DC 5V) to the USB port even when the computer is in Sleep mode, Hibernation mode or shutdown state (powered off).

This function can only be used for the port that supports the USB Sleep and Charge function (hereinafter called “compatible port”).

Compatible ports are USB ports that have the (⚡) symbol icon.

You can use the "USB Sleep and Charge function" to charge certain USB compatible external devices such as mobile phones or portable digital music players. However, the "USB Sleep and Charge function" may not work with certain external devices even if they are compliant with the USB specification. In those cases, power on the computer to charge the device.

NOTE

- ❖ When “USB Sleep and Charge function” is set to Enabled, USB bus power (DC 5V) will be supplied to the compatible port even when the power of the computer is turned OFF. USB bus power (DC 5V) is similarly supplied to the external devices which are connected to the compatible ports. However, some external devices cannot be charged solely by supplying USB bus power (DC 5V). As for the specifications of the external devices, please contact the device manufacturer or check the specifications of the external devices thoroughly before use.
 - ❖ Using the “USB Sleep and Charge function” to charge external devices will take longer than charging the devices with their own chargers.
 - ❖ External devices connected to the USB bus power (DC 5V) function that interfaces with the power ON/OFF of the computer may always be in an operational state.
 - ❖ When there is a current overflow of the external device connected to the compatible port, USB bus power (DC 5V) supply may be stopped for safety reasons.
-

▲ WARNING

Metal paper clips or hair pins/clips will generate heat if they come into contact with USB ports. Do not allow USB ports to come into contact with metal products.

Enabling/Disabling USB Sleep and Charge

This utility can be used to enable or disable the USB Sleep and Charge function. To enable this function, select the **Enable USB Sleep and Charge** check box in the utility. To disable this function, de-select the check box.

Power supply mode settings

Your computer may provide two different charging modes, to support various types of USB devices. If your computer provides more than one charging mode, the charging mode you should select depends on the USB device you want to charge. For example, **Auto Mode**, which is the default mode, will charge a wide variety of digital audio players. If your device does not charge in Auto Mode, try using **Alternate Mode**. To select a different charging mode, use the **Power supply mode** drop-down list in the utility.

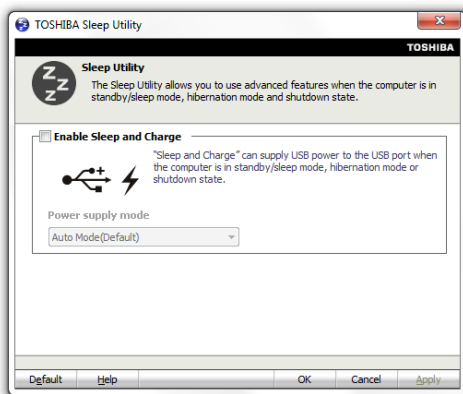

(Sample Image) TOSHIBA Sleep Utility screen

NOTE

With certain external devices, the USB Sleep and Charge function may not work no matter which charging mode you select. In those cases, disable USB Sleep and Charge in the utility and turn the computer on to charge the device, or use a different charging device.

TOSHIBA Button Support

TOSHIBA Button Support allows you to customize the eco button. This button is located on the system control panel directly above the keyboard.

To access TOSHIBA Button Support:



- 1 Click the **TOSHIBA Button Support** icon in the **Optimize** tab of **TOSHIBA Assist**.

The TOSHIBA Button Support window appears.

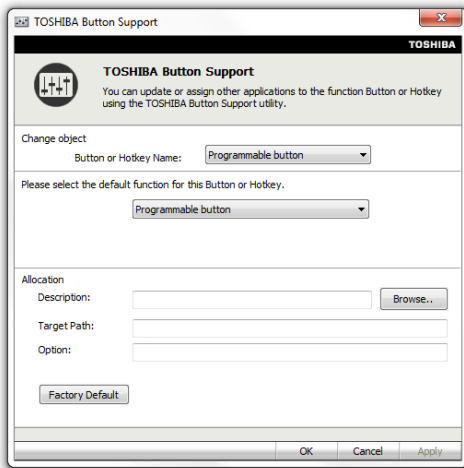

(Sample Image) TOSHIBA Button Support screen

- 2 Under **Button or Hotkey Name**, select the button whose function is to be customized.
- 3 Make the desired selections.
- 4 Click **Apply**, then **OK**.

TOSHIBA Accessibility

The TOSHIBA Accessibility utility allows you to use the Fn key to create a hot key combination with one of the function keys without pressing the two keys simultaneously as is usually required. Using Accessibility lets you make the Fn key a *sticky key*, meaning you can press it once, release it, and then press a function key to activate the hot key function.

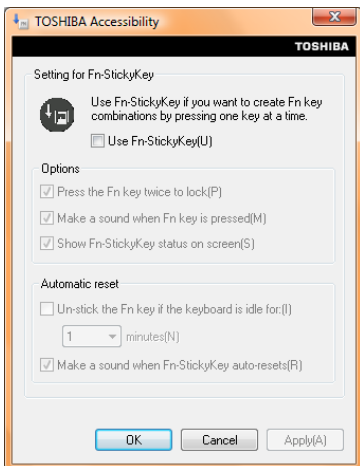

(Sample Image) TOSHIBA Accessibility window

To use TOSHIBA Accessibility:

- 1 Click the **Start** button and, in the Search field, type **Accessibility**. In the list that appears above, click on your selection. Or click the **Accessibility** icon in the **Optimize** tab of **TOSHIBA Assist**.



The TOSHIBA Accessibility window appears.

- 2 Check the **Use Fn-StickyKey** box.
- 3 Put a check mark next to the desired option.
- 4 Click **OK**.

TOSHIBA eco Utility™

The TOSHIBA eco Utility™ monitors your power savings from using the eco power plan by tracking real-time power consumption and accumulated savings over time.

To access the TOSHIBA eco Utility™, do one of the following:



- ❖ Click the **Start** button and, in the Search field, type **eco Utility**. In the list that appears above, click on your selection.
- ❖ Double-click the **TOSHIBA eco Utility** icon in the notification area.
- ❖ Right-click the **TOSHIBA eco Utility** icon in the notification area and select **Launch TOSHIBA eco Utility**.

The TOSHIBA eco Utility™ window appears.

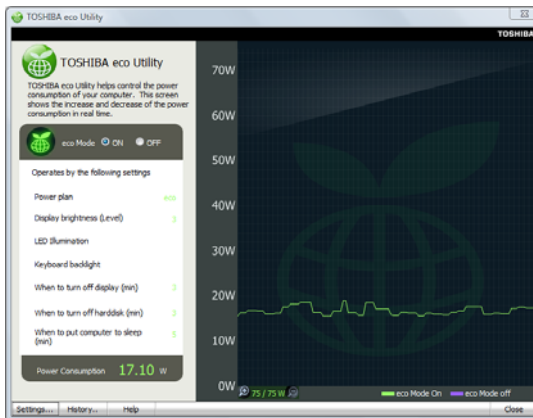

(Sample Image) TOSHIBA eco Utility™ window

To activate the TOSHIBA eco power plan, select ON in the upper-left section of the screen.

For more information on the TOSHIBA eco power plan and utility, click the **Help** button at the bottom of the window.

TOSHIBA Service Station

The TOSHIBA Service Station helps you keep your new computer running at its best by notifying you when updated software, firmware, documentation or other information is available for your computer. The TOSHIBA Service Station will alert you when updates are available, and you can then choose to install the updates if you wish.



TOSHIBA PC Health Monitor

The TOSHIBA PC Health Monitor software program monitors computer system functions such as power consumption, the cooling system and the 3D Accelerometer (available on certain models). It alerts users to specific system conditions via pop-up messages. It also tracks the usage of the computer and related devices and logs service-relevant information on the computer's internal storage drive.

The collected information includes device operation time and number of actuations or status changes (e.g.: number of power button and Fn key combination uses, AC adaptor, LCD, HDD, sound volume, and USB information), date of initial system use, and also computer and device usage (e.g.: power settings, CPU, memory, and temperatures for various devices). The collected information is not limited to the examples specified here. The stored data uses a very small portion of the total hard disk capacity (approximately 3 MB or less per year).

This information is used to identify and provide a notification of system conditions that may affect the performance of your TOSHIBA computer. It may also be used to help diagnose problems should the computer require service by TOSHIBA or TOSHIBA's authorized service providers. Additionally, TOSHIBA may use this information for quality assurance analysis.

Subject to the use restrictions above, the data logged on the internal storage drive may be transferred to entities located outside of your country or region of residence (e.g., European Union). Those countries may or may not have the same data protection laws or data protection levels as required by your home country or region.

You may disable the TOSHIBA PC Health Monitor at any time by uninstalling the software via the Windows® Control Panel. Doing so will automatically delete all collected information from the internal storage drive.

The TOSHIBA PC Health Monitor software does not extend or modify TOSHIBA's obligations under its standard limited warranty in any way. TOSHIBA's standard limited warranty terms and limitations apply.

Chapter 6

If Something Goes Wrong

Some problems you may encounter when using your computer are relatively easy to identify and solve. Others may require help from your network administrator or the manufacturer of the software program.

This chapter aims to help you solve many problems by yourself. It covers the problems you are most likely to encounter.

If all else fails, contact Toshiba. You will find information on Toshiba's support services at the end of this chapter.

Problems that are easy to fix

Your program stops responding.

If you are working with a program that suddenly freezes all operations, chances are the program has stopped responding. You can exit the failed program without shutting down the operating system or closing other programs.

To close a program that has stopped responding:

- 1 Press Ctrl, Alt, and Del simultaneously (once), then click **Start Task Manager**.

The Windows® Task Manager window appears.

- 2 Click the **Applications** tab.

If a program has stopped responding, the words “not responding” appear beside its name in the list.

- 3** Select the program you want to close, then click **End Task**.
Closing the failed program should allow you to continue working. If it does not, continue with the next step.
- 4** Close the remaining programs one by one by selecting the program name, then **End Task**.
Closing all programs should allow you to continue working. If it does not, power off your computer and then restart it.

Problems when you turn on the computer

These problems may occur when you turn on the power.

The computer will not start.

Make sure you attached the AC adaptor and power cord/cable properly.

Press and hold the power button for at least 10 seconds.

Check that the wall outlet is working by plugging in another device, such as a lamp.

Verify that the computer is on by looking at the ON/OFF indicator. If the indicator is glowing white, the computer is on. Also, try turning the computer off and then on.

Verify that the computer is receiving power from the external power source by looking at the ON/OFF light. If the indicator is glowing, the computer is connected to a live external power source.

The computer starts but when you press a key nothing happens.

Verify that the active program accepts text input. Try clicking your mouse on an area where you can type text and try typing again.

Your computer may be in Sleep mode and have a software or resource conflict. When this happens turning the power on returns you to the problem instead of restarting the system. To clear the condition, press Ctrl, Alt, and Del simultaneously. Then shut down the computer via software, or follow the steps if your program stops responding (see [“Problems that are easy to fix”](#) on page 109).

The computer displays the WARNING RESUME FAILURE/Windows Error Recovery – Windows did not shut down successfully message.

To continue, select **Start Windows normally**. If you performed a shutdown before this message was displayed, a program or driver may have prevented Windows® from shutting down.

Data stored in the computer’s memory has been lost. Data stored in the computer’s internal storage drive may not be affected.

The Windows® operating system is not working

Once you are familiar with the desktop and used to the way the operating system responds to your work routine, you can easily detect if the operating system is not working correctly. For example:

- ❖ The operating system fails to start after the initial startup appears.
- ❖ The operating system takes a long time to start.
- ❖ The operating system responds differently from the normal routine.
- ❖ The screen does not look right.

Unless a hardware device has failed, problems usually occur when you change the system in some way such as installing a new program or adding a device.

If you experience any of these problems, use the options in the Startup menu to fix the problem.

Using Startup options to fix problems

If the operating system fails to start properly, you may have to change your system's configuration or verify the startup procedure to fix the problem. To do this, use the options in the Startup menu.

To open the Startup menu:

- 1 Restart your computer.
- 2 Press F8 when your computer starts and before Windows® starts loading.

The Windows® Advanced Boot Options menu displays these options:

- ❖ Repair Your Computer
- ❖ Safe Mode
- ❖ Safe Mode with Networking
- ❖ Safe Mode with Command Prompt
- ❖ Enable Boot Logging
- ❖ Enable low-resolution video (640 x 480)
- ❖ Last Known Good Configuration (advanced)
- ❖ Directory Services Restore Mode
- ❖ Debugging Mode
- ❖ Disable automatic restart on system failure

- ❖ Disable Driver Signature Enforcement
- ❖ Start Windows® Normally

When you highlight each option using the arrow keys, Windows® displays information about each option at the bottom after

Description.

See your Windows® documentation for further explanation.

NOTE If your computer is connected to a network, the Startup menu may display different versions of Safe mode.

Internet problems

My Internet connection is very slow.

Many factors contribute to the speed with which you can surf the Internet. They include: network speed, network conditions, time of day (when everyone else is surfing, your access can be slow) and popularity of the sites you are trying to access. If accessing a particular site is very slow, try later.

My browser cannot find the URL address I typed in.

Make sure you separated the domain names of the address with the forward slash (/). Check the spelling of each name and the syntax of the address carefully. A single incorrect letter or missed character will make it impossible for your browser to locate the site.

My browser cannot find a site I bookmarked.

The World Wide Web is constantly changing. A site you bookmarked yesterday may not be available today or its server may be down for temporary repair. Try again later.

The Windows® operating system can help you

If the operating system has started properly but you still have a problem using your computer, the online Help can assist you in troubleshooting the problem.

To access the Windows® operating system Help and Support:

- 1** Click the **Start** button and, in the Search field, type **Help and Support**. In the list that appears above, click on your selection. Or press F1.
The Help and Support window appears.
- 2** Then do one or both of the following:
 - ❖ In the Search programs and files field, type in the topic for which you need help and follow the on-screen instructions.

- ❖ Click one of the options listed in the window and then follow the on-screen instructions.

You can connect to Support Online by clicking the **Ask** button and then clicking **Microsoft Customer Support** or by going to Toshiba support at support.toshiba.com.

Fixing a problem with Device Manager

Device Manager provides a way to check and change the configuration of a device.

CAUTION

Changing the default settings using Device Manager can cause other conflicts that make one or more devices unusable. Device Manager is a configuration tool for advanced users who understand configuration parameters and the ramifications of changing them.

Checking device properties

Device Manager provides a way to view the properties of a device. Properties include the name of the manufacturer, the type of device, the drivers installed, and the system resources assigned to the device.

To check a device's properties:

- 1 Click **Start, Control Panel, System and Security**, and then under **System**, click **Device Manager**.
- 2 To view the device(s) installed, double-click the device type.
- 3 To view the properties, double-click the device.

The operating system displays the device Properties dialog box, which provides an array of tabs. They may include:

- ❖ The **General** tab, which provides basic information about the device.
- ❖ The **Resources** tab, which lists resources assigned to the device. This tab does not appear if the device is not using resources.
- ❖ The **Driver** tab, which displays the drivers being used by the device. This tab also provides options for updating the driver or rolling back the driver in case the new version is causing a problem.

The tabs that appear in the dialog box vary from one device to another.

For more information about Device Manager, refer to Windows® online Help.

Memory problems

Incorrectly connected or faulty memory modules may cause errors that seem to be hardware or even software related. It is worthwhile checking for these first:

- 1 Click **Start**, and then click the **Shut down** button in the lower-right corner of the Start menu.
The computer shuts down completely.
- 2 Remove the memory module, following the instructions in “[Removing a memory module](#)” on page 35.
- 3 Reinstall the memory module, following the instructions in “[Installing a memory module](#)” on page 30, and making sure the module is seated properly.
- 4 Check for the error again.
- 5 If the error recurs, remove the memory module entirely and check for the error again.

If removing the memory module eliminates the error, the memory module may be faulty. If the error recurs without the memory module installed, the error is not caused by the memory module.



TECHNICAL NOTE: You must have at least one memory module installed for the computer to work.

NOTE

For this model, Slot A is the bottom slot. Slot B is the top slot. If only one memory module is to be installed, it must be installed in Slot A.

Power and the battery

Your computer receives its power through the AC adaptor and power cord/cable and from the real-time clock (RTC) battery. A faulty AC adaptor or power cord/cable will not power the computer.

Here are some typical problems and how to solve them:

The ON/OFF light does not come on when you plug in the AC adaptor and power cord/cable.

Make sure the AC adaptor and power cord/cable are firmly plugged into both the wall outlet and the computer.

If the ON/OFF light still does not come on, check that the wall outlet is working properly by plugging in a lamp or other appliance.

Keyboard problems

- NOTE** To capture a print screen of the entire screen, press the Fn + PRTSC key.
- To capture only the active window displayed, press Fn + ALT while simultaneously pressing the PRTSC key.
-

If, while typing, strange things happen or nothing happens, the problem may be related to the keyboard itself.

You have connected an external keyboard and the operating system displays one or more keyboard error messages.

You may need to update your keyboard driver. Refer to the documentation that came with the keyboard or to the keyboard manufacturer's Web site.

The keyboard you connected may be defective or incompatible with the computer. Try using a different make of keyboard.

Display problems

Here are some typical display problems and their solutions:

The screen is blank.

Display Auto Off may have gone into effect. Press any key to activate the screen.

You may have activated the instant password feature by pressing Fn and F1 simultaneously. If you have registered a password, press any key, type the password and press Enter. If no password is registered, press any key. The screen reactivates and allows you to continue working.

The screen does not look correct.

You can change the display settings by clicking a blank area of the desktop with the secondary control button, then clicking **Personalize**. This opens the Personalization window. Choose a theme for your desktop background, under **Colors, Sounds, and Screen Saver**, or change the settings for each of these components individually. Click **Display** and then **Change display settings** to choose the screen resolution.

For more information, see the Windows® online Help.

Small bright dots appear on your TFT display when you turn on your computer.

Small bright dots may appear on your screen display when you turn on your computer. Your display contains an extremely large number of thin-film transistors (TFT) and is manufactured using high-precision technology. Any small bright dots that may appear on your display are an intrinsic characteristic of the TFT manufacturing technology. Over a period of time, and depending on the usage of the computer, the brightness of the screen will deteriorate. This is also an intrinsic characteristic of the screen technology.

Disk or storage drive problems

Problems with the storage drive or with external media usually show up as an inability to access the drive or as sector errors. Sometimes a drive problem may cause one or more files to appear to have garbage in them. Typical problems are:

You are having trouble accessing a drive, or one or more files appear to be missing.

Make sure you are identifying the drive by its correct name (A: or C:).

Error-checking

NOTE This feature is not available for optical disc drives.

Run Error-checking, which analyzes the directories and files on the storage drive and repairs any damage it finds.

To run Error-checking:

- 1** Click **Start**, and then **Computer**.
- 2** Right-click the drive you want to check.
- 3** On the pop-up menu, click **Properties**.
The drive's Properties box appears.
- 4** Click the **Tools** tab.
- 5** Click the **Check now...** button.
The Check Disk box appears.
- 6** You can choose one or both options:
 - ❖ Automatically fix file system errors
 - ❖ Scan for and attempt recovery of bad sectors

7 Click Start.

Error-checking tests and repairs the storage drive.

Your hard disk seems very slow.

If you have been using your computer for a long time, your files may have become fragmented. Run Disk Defragmenter.

To do this, click **Start, All Programs, Accessories, System Tools,** and then **Disk Defragmenter.** After it opens, click **Defragment disk.**

Your data files are damaged or corrupted.

Refer to your software documentation for file recovery procedures. Many software packages automatically create backup files.

You may also be able to recover lost data using utility software. Consult the dealer from whom you purchased your computer and/or program. Your dealer is your best source for current information.

Some programs run correctly but others do not.

This is probably a configuration problem. If a program does not run properly, refer to its documentation and check that the hardware configuration meets its needs.

Optical disc drive problems

You cannot access a disc in the drive.

If the optical disc drive is an external drive, make sure the two USB cables or the AC adaptor cable are properly connected to the computer and refer to the documentation that came with your drive.

Make sure the tray that holds the optical disc is closed properly. Press gently until it clicks into place.

Open the tray and remove the disc. Make sure the tray is clean. Any dirt or foreign object can interfere with the laser beam.

Examine the disc to see if it is dirty. If necessary, wipe it with a clean cloth dipped in water or a neutral cleaner.

Replace the disc in the tray. Make sure that the disc is lying flat, label side out. Close the tray carefully, making sure it has shut completely.

You press the disc eject button, but the drive tray does not slide out.

Make sure the computer is connected to a power source and turned on. The optical disc drive eject mechanism requires power to operate.

Make sure a program is not accessing the drive and preventing it from ejecting.

If you need to remove a disc and cannot turn on the computer, use a narrow object, such as a straightened paper clip, to press the manual eject button. This button is in the small hole next to the optical disc drive eject button on the face of the optical disc drive tray.

CAUTION

Never use a pencil to press the manual eject button. Pencil lead can break off inside the computer and damage it.

Some discs run correctly but others do not.

Check that the type of disc you are using is compatible with your optical disc drive. For more information regarding supported optical media formats, refer to the complete detail specifications for your computer at support.toshiba.com.

If the problem is with an optical data disc, refer to the software's documentation and check that the hardware configuration meets the program's needs.

The disc will not come out of the drive when you click the eject button on the screen.

Press the button on the optical disc drive itself. For additional information see “[You press the disc eject button, but the drive tray does not slide out.](#)” on page 118.

Online content accessed through the Blu-ray Disc™ is not displaying.

Make sure you are connected to the Internet.

While viewing a Blu-ray Disc™ movie the sound is not coming from the computer's speakers.

You can change the destination of the audio signal in Sound properties in the Control Panel.

NOTE

Blu-ray Disc™ player Technology.

Compatibility and/or performance issues are possible. Certain interactive features may not be supported due to compatibility, network settings or other conditions. Advanced Access Content System (AACs) keys are integrated into your computer for copy protection purposes. Occasional renewal is required and will initially be provided at no charge. After the initial period, Corel Corporation will provide AACs key renewals pursuant to its then current terms and conditions. For more information on AACs key, visit www.aacsla.com/home.

- ❖ Depending on Blu-ray Disc™ content, you may experience "frame dropping" or lower performance.
- ❖ Blu-ray Disc™ player does not support DVD playback. Please use Windows Media® player or "TOSHIBA DVD Player" for DVD playback.
- ❖ Blu-ray Disc™ playback feature support may vary with each Blu-ray Disc™. Please contact content publisher directly with any questions.
- ❖ Do not play a Blu-ray Disc™ when recording a TV program, whether live or pre-scheduled. Doing so may cause Blu-ray Disc™ playback or television program recording errors.
- ❖ While playing a Blu-ray Disc™-J title, keyboard short-cut and resume play functions are not supported.
- ❖ Blu-ray Disc™ player does not support HD DVDs. Blu-ray™ Discs with high definition content is required for HD viewing.
- ❖ Do not place your computer in sleep or hibernate mode while the Blu-ray Disc™ player is running.
- ❖ The region code of your Blu-ray Disc™ (video) must match the region code of your Blu-ray Disc™ player. Otherwise, the Blu-ray Disc™ will not play properly. Region codes can be set from the Blu-ray Disc™ software that came with your computer.

Sound system problems

No sound is coming from the computer's speakers.

Adjust the volume control.

Try pressing Fn + Esc to see if volume mute is disabled.

Check that the volume control on the computer is turned up.

If you are using external headphones or speakers, check that they are securely connected to your computer.

The computer emits a loud, high-pitched noise.

This is feedback between the microphone and the speakers. Make sure you have connected the microphone to the microphone jack and the speakers to the headphone jack. Adjust the volume control.

Printer problems

This section lists some of the most common printer problems.

The printer will not print.

Check that the printer is connected to a working power outlet, turned on and ready (on line).

Check that the printer has plenty of paper. Some printers will not start printing when there are just two or three sheets of paper left in the tray.

Make sure the printer cable is firmly attached to the computer and the printer.

Run the printer's self-test to check for any problem with the printer itself.

Make sure you installed the proper printer drivers as shown in the instructions that came with the printer.

You may have connected the printer while the computer is on. Disable Sleep mode, turn off the computer, and turn off the printer. Turn the printer back on, make sure it is online, and then turn the computer back on.

Try printing another file. For example, you could create and attempt to print a short test file using Notepad. If a Notepad file prints correctly, the problem may be in your original file.

If you cannot resolve the problem, contact the printer's manufacturer.

The printer will not print what you see on the screen.

Many programs display information on the screen differently from the way they print it. See if your program has a print preview mode. This mode lets you see your work exactly as it will print. Contact the software manufacturer for more information.

Wireless networking problems

NOTE This section provides general troubleshooting tips for networking problems, specifically wireless (Wi-Fi®) networking. The terms and concepts used assume a basic understanding of networks, and may be for more advanced users. If you need assistance or if you are not familiar with the terminology, please see Windows® Help and Support or contact your computer technician.

- ❖ If your computer is equipped with an internal Wi-Fi® adapter, verify that the Wireless antenna is ON.
- ❖ Verify that your computer can detect access points or routers. If it can detect a Wi-Fi® access point or router then it may be a configuration issue.
- ❖ Verify that signal strength is good using the utility provided with the Wi-Fi® adapter.
- ❖ If another computer is on the same network, verify that it has network access, and can connect to the Internet. If, for example, the other computer cannot browse to a public Web site, the ISP's (Internet Service Provider) service may be disrupted.
- ❖ Verify that the Service Set Identifier (SSID), or network name, is correct - i.e., that it matches the SSID assigned to the access point you are attempting to connect through. SSIDs are case-sensitive.
- ❖ Check the Windows® Control Panel's Device Manager to verify that the Wi-Fi® adapter is recognized by the Windows® operating system, and that the driver is loaded. To access the Device Manager, click **Start, Control Panel, System and Security**, and then **System**. Carefully note any error messages - these will be very helpful if you should confer with a support technician at a later time.

NOTE To enable or disable wireless communication, press F12. For more information see "[Hot Keys/TOSHIBA Cards](#)" on page 131.

- ❖ Use IPCONFIG to verify that the computer has a useful IP address - one other than the private address of 169.254.xxx.xxx assigned by Windows®.
 - 1 Click **Start** to open the Start menu.
 - 2 Type **Cmd** in the Search programs and files field.

- 3 Enter IPCONFIG /ALL and press Enter.

The IP address for each active network adapter will be displayed.

- ❖ Connect your computer directly to your router or broadband modem, by plugging a standard CAT5 Ethernet patch cable (sold separately) into your computer's RJ45 Ethernet port. If your connection problem disappears, the problem lies in the Wi-Fi® part of your network.
- ❖ If you have enabled any security provisions (closed system, MAC address filtering, Wired Equivalent Privacy [WEP], etc.), check the access point vendor's Web site for recent firmware upgrades. Problems with WEP keys, in particular, are frequently addressed in new firmware releases.

The Windows® operating system wireless management utility does not work.

If you are using an external Wi-Fi® adapter (a USB adapter, or other variety), check if the adapter comes with its own management utility. If it does, the utility may be disabling the Windows® operating system wireless management utility, in which case you must use the adapter's management utility. If the documentation that accompanies the adapter does not provide enough information to determine if this is the case, contact that vendor's support group for further advice.

DVD and Blu-ray Disc™ operating problems

If you experience a problem playing DVDs or Blu-ray™ Discs, you may be able to fix the problem yourself.

For general problems playing a DVD or Blu-ray Disc™ title, try the following steps:

- 1 Verify that the disc is in a format that the drive supports.
- 2 Ensure that the disc is properly inserted in the drive tray.
- 3 Use the DVD or Blu-ray Disc™ player software that came with your computer to view DVD or Blu-ray Disc™ movies.
- 4 Clean the disc and try again.

A dirty drive can also cause audio problems. If you have tried several discs and all fail, consider sending your drive to an authorized service provider to get it cleaned.

- 5 Verify that your computer recognizes your optical disc drive by clicking **Start**, and then **Computer**. The optical disc drive should appear in the list.

- 6 See “[Checking device properties](#)” on page 113 for instructions on using Device Manager to view the optical disc drive properties.
- 7 Check the Toshiba Web site for new information on optical disc drives and their operation.

A blank screen appears while watching a DVD-ROM or BD-ROM movie or title.

Change the setting for when to turn off the display using the following steps:

- 1 Click the **Start** button and, in the Search field, type **Control Panel**. In the list that appears above, click on your selection.
- 2 Click **Choose when to turn off the display** in the left pane.
- 3 To turn off the display, select **Never** in the drop-down lists.
- 4 Click **Save changes**.

The screen saver runs while you are watching a movie or title.

If the screen saver is enabled, it runs on top of any movie or title you are watching. To disable the screen saver:

- 1 Right-click on the desktop and click **Personalize** in the menu.
- 2 Click **Screen Saver** in the lower-right corner of the window.
- 3 Select **None** from the **Screen saver** drop-down list.
- 4 Click **OK**.

Develop good computing habits

Save your work frequently.

You can never predict when your computer will lock, forcing you to close a program and lose unsaved changes. Many software programs build in an automatic backup, but you should not rely solely on this feature. Save your work! See “[Computing tips](#)” on page 60 for instructions.

On a regular basis, back up the information stored on your internal storage drive.

Use Windows® to back up files, or the entire computer, to an optical disc, USB drive, or external hard disk. Here are some ways you can do this:

- ❖ Use the Windows® operating system to back up files or your entire computer to an optical disc, USB drive, or external hard disk.
- ❖ Copy files to a rewritable external storage device.

- ❖ Connect your computer to the office network and copy files to your network partition.

Some people use a combination of these methods, backing up all files to tape weekly and copying critical files to external media on a daily basis.

If you have installed your own programs, you should back up these programs as well as your data files. If something goes wrong that requires you to reformat your internal storage drive and start again, reloading all your programs and data files from a backup source will save time.

Read the user's guides.

It is very difficult to provide a fail-safe set of steps you can follow every time you experience a problem with the computer. Your ability to solve problems will improve as you learn about how the computer and its software work together.

Get familiar with all the user's guides provided with your computer, as well as the manuals that come with the programs and devices you purchase.

Your local computer store or book store sells a variety of self-help books you can use to supplement the information in the manuals.

Data and system configuration backup in the Windows® operating system

The Windows® operating system offers some easy-to-use features for backing up your Windows® settings and your data – documents and other important files. Take advantage of these features to protect yourself from much more difficult and time-consuming restoration procedures, and to safeguard your valuable data from loss.

Saving system configuration with restore points

The System Restore feature of the Windows® operating system quickly creates restore points – ‘snapshots’ of your Windows® operating system configuration – and saves them for later recall. If you experience problems after installing some new hardware or software, you can easily select a previously established Control Point to ‘turn back the clock,’ restoring the Windows® operating system to the state it was in just prior to the installation. This is much easier and more effective than uninstalling the hardware or software, which often leaves behind unwanted files and settings. It is also easy to undo a restore point selection, if you change your mind.

Follow these steps to create a restore point using the System Restore utility:

- 1 Click **Start, Control Panel, System and Security**, and then **System**.
- 2 In the left pane, click **System protection**.
The System Protection tab of the System Properties window appears.
- 3 Click **Create...**
- 4 In the input field, enter a name that is descriptive enough to be easily understood in the future, such as “Before installing Brand X Accounting app.” Then click **Create**.
The Windows® operating system creates the restore point, automatically stamps it with the current date and time, and displays a message that the restore point was successfully created.
- 5 Click **Close**.

Then, at a later time, you can re-establish your Windows® configuration using the saved restore point. To do this:

- 1 Click **Start, All Programs, Accessories, System Tools**, and then **System Restore**.
- 2 Select **Recommended restore** or **Choose a different restore point**, and then click **Next**.
The timestamp and description of each restore point is displayed.

NOTE

This list may contain restore points that you did not create. Restore points labeled System Checkpoint were automatically created by the Windows® operating system. Other restore points may have been created automatically by applications when they were installed.

-
- 3 If you selected **Choose a different restore point** in step 2, select the restore point you want to use, and then click **Next**.
 - 4 Verify that the restore point you selected is the correct one. If it is not, click **Back** to return to the previous step.
 - 5 Close all programs and save all open files.
 - 6 Click **Finish**, and then **Yes** to begin the system restore.
Your Windows® operating system configuration will now be restored to the state it was in when the chosen restore point was created, and then the computer will be automatically restarted.

Backing up your data or your entire computer with the Windows® operating system

The most valuable component of your computer system is the data you create and store on its internal storage drive. Since problems with either hardware or software can make the data inaccessible or even destroy it, the next most valuable component of your computer system may be a recent backup of your data.

Fortunately, the Windows® operating system offers a convenient way to back up your computer or just your important files to optical disc drives, or hard drives. An external hard drive is recommended in case the internal storage drive fails. No additional software is required. Most of the optical disc drives built into recent Toshiba computer models can write to (or ‘burn’) as well as read from optical discs. External optical disc writers are also widely available.

Follow these steps to back up your computer or files to optical discs, or a storage drive:

- 1 Prepare your backup target by connecting it and/or inserting a blank optical disc in the drive.
- 2 Click **Start**.
- 3 Click **Control Panel**.
- 4 Click **Back up your computer** under the **System and Security** heading. Follow the on-screen instructions to back up your files.

For more help, click **Start, Help and Support**, and search for “back up files.”

General tips for installing hardware and software

Here are a few tips to help ensure safe and easy installation of new hardware (printers, pointing devices, external hard drives, optical disc drive writers, scanners, etc.) and software (applications like Microsoft® Office and Adobe® Photoshop®, or utility software such as special toolbars for your web browser).

- ❖ Create a restore point (refer to “[Saving system configuration with restore points](#)” on page 124). Before installing anything, use the System Restore utility to set a restore point (see the section titled restore points). If anything goes wrong, you will then be able to easily restore the Windows® operating system to the state it was in prior to the installation, undoing any changes that the installation process introduced.

- ❖ Back up your critical data (see “[Backing up your data or your entire computer with the Windows® operating system](#)” on page 126).
- ❖ Have your back up DVD(s) on hand in case you need any files from them.
- ❖ Do not guess - follow directions carefully! It is often necessary to run an installation utility first - before connecting a new hardware item to the computer. If the device is connected first, it may be very difficult to complete the installation successfully. Always carefully follow the installation instructions that accompany the hardware or software.
- ❖ Restart the Windows® operating system. Always restart the Windows® operating system after each installation, even if the installation utility does not prompt you to do so. This will ensure that the installation is completed, and will clean up anything that the installation utility left behind.
- ❖ Do one installation at a time. If you have several new items to add to your computer system, install just one at a time, creating restore points immediately before each successive installation. This will make it much easier to determine the origin of any new problems. For best results, follow this sequence:
 - 1 Back up critical data.
 - 2 Create a restore point.
 - 3 Install one item of hardware or software.
 - 4 Restart the Windows® operating system.
 - 5 Use the new hardware or software for a while, noting any new problems. Make sure that your critical applications (email, business applications, etc.) are working correctly, and verify that important devices are still functioning.
 - 6 For each additional hardware or software item, repeat these steps, starting at step 1 if any of your critical data has changed, or starting at step 2 if no critical data has changed.

USB Sleep and Charge is not working.

- ❖ Make sure that the device you want to charge is connected to a port that supports the USB Sleep and Charge function. Ports that support this feature are identified with the (⚡) icon.
- ❖ USB Sleep and Charge may be disabled. Open the TOSHIBA Sleep Utility to check if the feature is disabled and to enable it

if necessary. For more information, see [“Enabling/Disabling USB Sleep and Charge” on page 103](#).

- ❖ Try selecting a different charging mode in the TOSHIBA Sleep Utility, if your computer provides more than one charging mode. For more information, see [“Power supply mode settings” on page 103](#).
- ❖ The USB Sleep and Charge function may not work with certain external devices even if they are compliant with the USB specification. In those cases, power on the computer to charge the device or use a different charging device.

The “USB Wakeup function” does not work.

- ❖ When the USB Sleep and Charge function is set to Enabled the USB Wakeup function does not work for ports that support the USB Sleep and Charge function. In that case, use a USB port that does not have the USB Sleep and Charge function - compatible icon (⚡), if you have a non-Sleep and Charge USB port available, or disable the USB Sleep and Charge function. For more information, see [“TOSHIBA Sleep Utility” on page 102](#).

If you need further assistance

If you have followed the recommendations in this chapter and are still having problems, you may need additional technical assistance.

Since some problems may be related to the operating system or the program you are using, it is important to investigate other sources.

- ❖ Review the troubleshooting information in your operating system documentation.
- ❖ If the problem occurs while you are running a program, consult the program's documentation for troubleshooting suggestions. Contact the software company's technical support group for their assistance.
- ❖ Consult the dealer from whom you purchased your computer and/or program. Your dealer is your best source for current information.

For the detailed specifications for your computer, visit support.toshiba.com.

Contacting Toshiba

Toshiba's Technical Support Web site

For technical support, or to stay current on the most recent software and hardware options for your computer, and for other product information, be sure to regularly check the Toshiba Web site at support.toshiba.com.

Other Toshiba Internet Web sites

toshiba.com	Worldwide Toshiba corporate site
us.toshiba.com	Marketing and product information in the USA
accessories.toshiba.com	Accessories information in the USA
www.toshiba.ca	Canada
www.toshiba-Europe.com	Europe
www.toshiba.co.jp/index.htm	Japan
latin.toshiba.com	Mexico and all of Latin America
acclaim.toshiba.com	Toshiba USA Self-Service support web site

Toshiba's worldwide offices

Australia

Toshiba (Australia) Pty. Limited
84-92 Talavera Road
North Ryde NSW 2113
Sydney
Australia

France

Toshiba Systèmes (France) S.A.
7, Rue Ampère; B. P. 131
92800 Puteaux Cédex
France

Italy

Centro Direzionale Colleoni
Palazzo Perseo
Via Paracelso 10
20041, Agrate Brianza
Milano, Italy

Latin America and Caribbean

Toshiba America Information
Systems, Inc.
9740 Irvine Boulevard
Irvine, California 92618
United States

Spain

Toshiba Information Systems
(España) S.A.
Parque Empresarial San Fernando
Edificio Europa, 1a Planta
Escalera A
28831 (Madrid) San Fernando de
Henares
Spain

United States

Toshiba America Information
Systems, Inc.
9740 Irvine Boulevard
Irvine, California 92618
United States

Canada

Toshiba Canada Ltd.
191 McNabb Street
Markham, Ontario
L3R - 8H2
Canada

Germany

Toshiba Europe GmbH
Leibnizstraße 2
D-93055 Regensburg
Germany

Japan

Toshiba Corporation, PCO-IO
1-1, Shibaura 1-Chome
Minato-Ku, Tokyo, 105-8001
Japan

Mexico

Toshiba de México S.A. de C.V.
Sierra Candela No.111, 6to. Piso
Col. Lomas de Chapultepec.
CP 11000 Mexico, DF.

United Kingdom

Toshiba Information Systems
(U.K) Ltd.
Toshiba Court
Weybridge Business Park
Addlestone Road
Weybridge, Surrey KT15 2UL
United Kingdom

The Rest of Europe

Toshiba Europe (I.E.) GmbH
Hammfelddamm 8
D-4-1460 Neuss
Germany

For more information on additional Toshiba worldwide locations,
please visit: www.toshiba.co.jp/index.htm.

Appendix A

Hot Keys/TOSHIBA Cards

Hot keys and TOSHIBA Cards provide a quick way to modify selected system functions and to launch applications.

Hot Key Cards

The Hot Key Cards are used to set or modify the following system functions:

- ❖ Help
- ❖ Display Brightness
- ❖ Internet and Media
- ❖ Mute
- ❖ Wireless ON / OFF
- ❖ Zoom (Display resolution)

Using the Hot Key Cards

The Hot Key Cards are normally hidden from view. The Cards appear when you press the hot key associated with the desired function.

NOTE Hot keys are keys that turn system functions on and off. Hot keys have a legend on the key indicating the option or feature the key controls.

To use a Hot Key Card:

Press the hot key associated with the desired function.

The associated hot key Card appears at the top of the screen with its available options below it.

Hot key functions

Hot key functions are performed using either the Hot Key Cards or by pressing the associated hot key. This section lists the available hot key functions.

NOTE Hot keys are keys that turn system functions on and off. Hot keys have a legend on the key indicating the option or feature the key controls.

Help



This Hot key will display the help file.

Display brightness



This hot key decreases the screen brightness.



This hot key increases the screen brightness.

Selecting this Card or pressing either hot key displays the following options:



(Sample Image) Display brightness

Move the slider or press the appropriate hot key repeatedly to decrease or increase the display brightness.

Internet and Media Control Buttons



This hot key launches the default browser.



This hot key launches the Windows Media® Player.



Skip Back



Play / Pause



Skip Forward



Volume Down



Volume Up

Volume Mute



or





This TOSHIBA Card or hot key enables/disables volume mute on your computer.

When volume mute is enabled, no sound will come from the speakers or headphones.

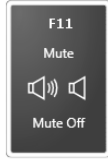
Selecting this Card or pressing the hot key displays the following options:



(Sample Image) Volume Mute options

- ❖ To enable mute, select .
- ❖ To disable mute, select .

Disabling or enabling wireless devices



or



This TOSHIBA Card or hot key enables/disables the optional wireless devices installed in your computer.



The wireless modes are:

- ❖ Wi-Fi® enabled—Enables just the Wi-Fi® module.

Selecting this Card or pressing the hot key displays the following options:



(Sample Image) Wireless communication options

- ❖ To enable Wi-Fi®, select .
- ❖ To cancel, select .

***Available on certain models.**

Zoom (Display resolution)



or

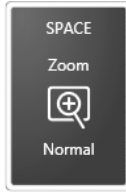

(Sample Image) Screen resolution options

Cycle through the screen resolutions, then select the desired resolution.

Appendix B

Power Cord/Cable Connectors

Your computer ships with the correct power supply for the country of purchase. This appendix shows the shapes of the typical AC power cord/cable connectors for various parts of the world.

USA



UL approved

Canada

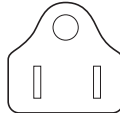

CSA approved

United Kingdom

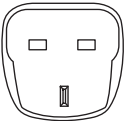

BS approved

Europe

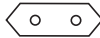

VDA approved
NEMKO approved

Australia



AS approved

Glossary



TECHNICAL NOTE: Some features defined in this glossary may not be available on your computer.

Acronyms

The following acronyms may appear in this User's Guide.

AC	Alternating Current
BIOS	Basic Input/Output System
BD-ROM	Blu-ray Disc Read-Only Memory
bps	bits per second
CD	Compact Disc
CD-ROM	Compact Disc Read-Only Memory
CD-RW	Compact Disc Rewrite Memory
CMOS	Complementary Metal-Oxide Semiconductor
COM1	communications port 1 (serial port)
COM2	communications port 2 (serial port)
CPU	Central Processing Unit
DC	Direct Current
DMA	Direct Memory Access

DIMM	Dual Inline Memory Module
DOS	Disk Operating System
DPI	Dots Per Inch
DVD	Digital Versatile (or Video) Disc
DVD-ROM	Digital Versatile (or Video) Disc Read-Only Memory
EPROM	Erasable Programmable Read-Only Memory
eSATA	external Serial Advanced Technology Attachment
FAT	File Allocation Table
FCC	Federal Communications Commission
GB	gigabyte
HDD	Hard Disk Drive
HDMI	High-Definition Multimedia Interface
HDMI-CEC	High-Definition Multimedia Interface Consumer Electronics Control
HTML	Hypertext Markup Language
IEEE	Institute of Electrical and Electronics Engineers
I/O	Input/Output
IRQ	interrupt request
ISP	Internet Service Provider
KB	kilobyte
LAN	Local Area Network
LCD	Liquid Crystal Display
LED	Light Emitting Diode
MB	megabyte
MIDI	Musical Instrument Digital Interface
PC	Personal Computer
PCI	Peripheral Component Interconnect
PCMCIA	Personal Computer Memory Card International Association
RAM	Random Access Memory
RGB	Red, Green Blue light (monitor)
RFI	Radio Frequency Interference

ROM	Read-Only Memory
RTC	Real-Time Clock
SD	Secure Digital
SDRAM	Synchronous Dynamic Random Access Memory
SSD	Solid State Drive
TFT	Thin Film Transistor
USB	Universal Serial Bus
URL	Uniform Resource Locator
WAN	Wide Area Network
www	World Wide Web

Terms

The following terms may appear in this User's Guide.

A

active-matrix display—A liquid crystal display (LCD) made from an array of liquid crystal cells using active-matrix technology. Also known as a “TFT display,” in its simplest form there is one thin film transistor (TFT) for each cell. This type of display works well with computers because of its shallow depth and high-quality color. Active-matrix displays are viewable from wider angles than most passive-matrix displays.

adapter—A device that provides a compatible connection between two units. For example, the computer's internal display adapter receives information from the software and translates it into images on the screen. An adapter can take a number of forms, from a microprocessor to a simple connector. An intelligent adapter (one that is capable of doing some processing) may also be called a controller.

Alternating Current (AC)—The type of power usually supplied to residential and commercial wall outlets. AC reverses its direction at regular intervals. Compare *Direct Current (DC)*.

application—A computer program that you use to perform tasks of a specific type. Applications include word processors, spreadsheets, and database management systems. See also *program*.

- B** **backup**—A copy of a file, usually on a removable disk, kept in case the original file is lost or damaged.
- Basic Input/Output System (BIOS)**—See *BIOS*.
- baud rate**—The speed at which a communication device, such as a printer or modem, transmits information. Baud rate is the number of signal changes per second (not necessarily the same as bits per second). See also *bits per second*.
- Blu-ray Disc (BD)**—Offering more storage capacity than DVDs, the format was developed to allow for more data storage and to enable recording and playback of high-definition video (HD).
- BIOS (Basic Input/Output System)**—Basic instructions, stored in read-only memory (ROM), containing the information the computer needs to check hardware and load the operating system when you start up the computer.
- bits per second (bps)**—A way of measuring the speed at which information is passed between two devices. This is the basic unit of measure used in modem communications, and is similar, but not identical, to the baud rate. See also *baud rate*.
- boot**—To start the computer. The term “boot” originates from bootstrap program (as in “pulling itself up by its bootstraps”), a program that loads and initializes the operating system. See also *reboot*.
- boot disk**—See *system disk*.
- boot setting (startup sequence)**—The order in which the computer accesses its internal storage drives to locate the startup files. Under the default startup sequence, the computer looks for the startup files in the external media before checking the internal storage drive.
- bus**—An electrical circuit that connects the central processing unit (CPU) with other parts of the computer, such as the video adapter, disk drives, and ports. It is the pathway through which data flows from one device to another. See also *bus speed*, *frontside bus*.
- bus speed**—The speed at which the central processing unit (CPU) communicates with the other parts of the computer.

C

- cache**—A section of very fast memory in which frequently used information is duplicated for quick access. Accessing data from cache is faster than accessing it from the computer's main memory. See also *CPU cache*, *L1 cache*, *L2 cache*.
- CD**—An individual compact disc. See also *CD-ROM*.
- CD-ROM (Compact Disc Read-Only Memory)**—A form of high-capacity storage that uses laser optics instead of magnetic means for reading data. See also *CD*. Compare *DVD-ROM*.
- Central Processing Unit (CPU)**—The chip that functions as the “brain” of the computer. It takes information from outside sources, such as memory or keyboard input, processes the information, and sends the results to another device that uses the information.
- character**—Any letter, number, or symbol you can use on the computer. Some characters are non-printing characters, such as a paragraph break in a word-processing program. A character occupies one byte of computer storage.
- chip**—A small piece of silicon containing computer logic and circuits for processing, memory, input/output, and/or control functions. Chips are mounted on printed circuit boards.
- click**—To press and release the pointing device's primary button without moving the pointing device. In the Windows® operating system, this refers to the pointing device's left button, unless otherwise stated. See also *double-click*.
- color palette**—A set of specified colors that establishes the colors that can be displayed on the screen at a particular time.
- compatibility**—The extent to which computers, programs, or devices can work together harmoniously, using the same commands, formats, or language as another.
- configuration**—(1) The collection of components that make up a single computer system. (2) How parts of the system are set up (that is, configured).
- controller**—A device that controls the transfer of data from a computer to a peripheral device and vice versa. For example, disk drives, monitors, keyboards, and printers all require controllers.
- CPU**—See *Central Processing Unit (CPU)*.

CPU cache—A section of very fast memory residing between the CPU and the computer's main memory that temporarily stores data and instructions the CPU will need to execute commands and programs. See also *cache*, *L1 cache*, *L2 cache*.

cursor—An on-screen symbol (usually a flashing vertical line) that indicates the position where characters will appear when you enter data.

D

default—The setting selected by a program when the user does not specify an alternative setting.

device—A component attached to the computer. Devices may be external (outside the computer's case) or internal (inside the computer's case). Printers, disk drives, and modems are examples of devices.

device driver—A program (called a "driver") that permits a computer to communicate with a device.

dialog box—An on-screen window displayed by the operating system or a program giving a direction or requesting input from the user.

Direct Current (DC)—The type of power usually supplied by batteries. DC flows in one direction. Compare *Alternating Current (AC)*.

Direct Memory Access (DMA)—A dedicated channel, bypassing the CPU, that enables direct data transfer between memory and a device.

directory—See *folder*.

disable—To turn a computer option off. See also *enable*.

disc—A round, flat piece of material, designed to be read from and written to by optical (laser) technology, and used in the production of optical discs, such as CDs and DVDs. Compare *disk*.

disk—A round, flat piece of material that can be magnetically influenced to hold information in digital form, and used in the production of magnetic disks, such as hard disks. Compare *disc*. See also *hard disk*.

disk drive—The device that reads and writes information and programs on external media or hard disk. It rotates the disk at high speed past one or more read/write heads.

document—Any file created with an application and, if saved to disk, given a name by which it can be retrieved. See also *file*.

double-click—To press and release the pointing device's primary button rapidly twice without moving the pointing device. In the Windows® operating system, this refers to the pointing device's left button, unless otherwise stated.

download—(1) In communications, to receive a file from another computer through a modem or network. (2) To send font data from the computer to a printer. See also *upload*.

drag—To hold down the mouse button while moving the pointer to drag a selected object. In the Windows® operating system, this refers to the left mouse button, unless otherwise stated.

driver—See *device driver*.

DVD—An individual digital versatile (or video) disc. See also *DVD-ROM*.

DVD-ROM (Digital Versatile [or Video] Disc Read-Only Memory)—A very high-capacity storage medium that uses laser optics for reading data. Each DVD-ROM can hold as much data as several CD-ROMs. Compare *CD-ROM*.

E

emulation—A technique in which a device or program imitates another device or program.

enable—To turn on a computer option. See also *disable*.

eSATA—An external device that supports hot swapping and fast data transfer. Very useful in storing and transferring large files.

executable file—A computer program that is ready to run. Application programs and batch files are examples of executable files. Names of executable files usually end with a *.bat* or *.exe* extension.

expansion device—A device that connects to a computer to expand its capabilities. Other names for an expansion device are port expander, port replicator, docking station, or network adapter.

extension—See *file extension*.

external device—See *device*.

F **file**—A collection of related information, saved on disk with a unique name. A file may be a program, information used by a program, or a document. See also *document*.

File Allocation Table (FAT)—The section of a storage drive that keeps track of the location of stored files.

file name—A set of characters that uniquely identifies a file within a particular folder. It consists of two parts: the actual name and the file name extension. See also *file extension*.

file extension—The three characters following the period (pronounced “dot”) at the end of a file name. The extension indicates the type of file. Examples are .exe for program files and .hlp for help files. See also *file name*.

folder—Also called directory. A container for organizing files saved to a disk. A folder is symbolized on screen by a graphical image (icon) of a file folder. A folder can contain files and other folders.

format—(verb) To prepare a blank disk for use with the computer’s operating system. Formatting creates a structure on the disk so the operating system can write information to the disk or read information from it.

frontside bus—The primary pathway (bus) between the CPU and the computer’s main memory. Also called “system bus.” See also *bus*.

function keys—The keys labeled F1 through F8, typically located on the keyboard. Their function is determined by the operating system and/or individual programs.

G **ground**—A conductor to which all components of an electric circuit are connected. It has a potential of zero (0) volts, is connected to the earth, and is the point of reference for voltages in the circuit.

H **hard disk**—A storage device composed of a rigid platter or platters that can be magnetically coded with data. Hard disks hold much more information than some external media and are used for long-term storage of programs and data. The primary (or only) hard disk in a computer is usually fixed, but some computers have secondary hard disks that are removable.

hardware—The physical components of a computer system. Compare *software*.

- HDMI (High-Definition Multimedia Interface)**—An interface used to transmit high quality audio and video signal via a single cable in digital format, providing better picture quality than analog signal.
- HDMI-CEC (HDMI Consumer Electronics Control)**—One A/V component can control another while using this function, if connected with HDMI cables. See also *HDMI*.
- Hibernation**—A feature of many Toshiba computers that saves to the internal storage drive the current state of your work, including all open files and programs, when you turn the computer off. When you turn on the computer again, your work is returned to the same state it was when the computer was turned off. See also *Sleep*, *Suspend*.
- hot key**—(1) A feature in which certain keys in combination with the Fn key can set system options or control system parameters, such as the battery save mode. (2) A key or combination of keys that activates a memory resident program.
- hot swapping**—The ability to add or remove devices from a computer while the computer is running and have the operating system automatically recognize the change.
- I icon**—A small image displayed on the screen that represents a function, file, or program.
- interlaced**—A method of refreshing a computer screen, in which only every other line of pixels is refreshed. Interlaced monitors take two passes to create a complete screen image. Compare *non-interlaced*.
- internal device**—See *device*.
- Internet**—The decentralized, world-wide network of computers that provides electronic mail, the World Wide Web, and other services. See also *World Wide Web*.
- K keyboard shortcut**—A key or combination of keys that you use to perform a task instead of using a pointing device such as a mouse.
- L L1 (level one) cache**—Memory cache built into the processor to help improve processing speed. See also *cache*, *CPU cache*, *L2 cache*.
- L2 (level two) cache**—Memory cache installed on the motherboard to help improve processing speed. It is slower than L1 cache and faster than main memory. See also *cache*, *CPU cache*, *L1 cache*.

LAN (Local Area Network)—A group of computers or other devices dispersed over a relatively limited area and connected by a communications link that enables any device to interact with any other on the network.

LED (Light Emitting Diode)—A solid state lamp (SSL) that uses light-emitting diodes (LEDs) as the source of light, which offers long life and high efficiency output. Multiple diodes are used together, since the light created by individual light-emitting diodes is small compared to incandescent and compact fluorescent lamps.

LCD (Liquid Crystal Display)—A type of display that uses a liquid substance between two transparent electrode panels. When an electric current passes through the electrodes, the molecules in the liquid form a crystalline pattern that polarizes the light passing through it. A filter over the electrodes permits only non-polarized light to pass to the surface of the display, creating light and dark pixels.

load—To move information from a storage device (such as a hard disk) into memory for processing.

local area network—See *LAN*.

logical drive—A section of a disk that is recognized by the operating system as a separate disk drive. A system's logical drives may differ from its physical drives. For example, a single hard disk drive may be partitioned into two or more logical drives.

M

memory—Typically refers to the computer's main memory, where programs are run and data is temporarily stored and processed. Memory can be volatile and hold data temporarily, such as RAM, or it can be nonvolatile and hold data permanently, such as ROM. A computer's main memory is RAM. See also *RAM*, *ROM*.

microprocessor—See *Central Processing Unit (CPU)*.

MIDI (Musical Instrument Digital Interface)—A standard for connecting musical instruments, synthesizers, and computers. The MIDI standard provides a way of translating music into a form computers can use, and vice versa.

modem—Short for “modulator/demodulator.” A device that converts information from digital to analog, and back to digital, enabling information to pass back and forth between digital computers and analog telephone lines.

motherboard—The computer's main circuit board that contains the processor, memory, and other primary components.

MS-DOS prompt—See *system prompt*.

multi-function drive—A DVD drive that can read and write to CD and DVD media.

multimedia—A combination of two or more media, such as sound, animation, and video in a computer program or presentation.

Musical Instrument Digital Interface—See *MIDI*.

N

network—A collection of computers and associated devices that are connected by communications facilities. A network allows you to share data and peripheral devices, such as printers, with other users and to exchange electronic mail.

non-interlaced—A method of refreshing a computer screen, in which each pixel of every line is refreshed as the electron beam scans across and down the screen. Compare *interlaced*.

non-system disk—A disk for storing programs and data that cannot be used to start the computer. Compare *system disk*.

O

online—Available through the computer. Online may refer to information being read from your own computer's internal storage drive, such as online documentation or online Help, or to information coming from another company on a company network or the Internet.

operating system—A set of programs that controls how the computer works. Examples of operating systems are the Windows Vista® Home Basic and Windows® 7 operating systems.

optical disc drive—A drive which reads plastic coated discs on which information is recorded digitally, and uses a laser to read data, music, or videos.

P

palette—See *color palette*.

parallel—Processes that occur simultaneously. In communications, it means the transmission of more than one bit of information at a time. On your computer, the parallel port provides a parallel communications interface between the computer and an appropriate device. Most modern printers are parallel. Compare *serial*.

password—A unique string of characters entered by a user to verify his or her identity to the computer or the network.

PC Card—A credit-card-sized expansion card designed to increase the capabilities of computers. PC Cards provide functions such as modem, fax/modem, hard disk drive, network adapter, sound card, or SCSI adapter.

peripheral—Any device, such as a printer or joystick, that is attached to the computer and controlled by the computer's CPU.

pixel—Short for "picture element." The smallest dot that can be produced on a screen or printer.

Plug and Play—Generally, refers to the computer's ability to automatically configure itself to work with peripheral devices. When capitalized, refers to a standard that, when followed by a device manufacturer, allows a computer to configure itself automatically to work with the device.

pointer—An icon (usually an arrow) that moves on the screen when you slide your finger across the touch pad or move a mouse. Used to point to and select/activate on-screen items, such as icons, menu items, and buttons. The shape and purpose of the pointer varies depending on the program you are using and what you are doing.

pointing device—Any device, such as the touch pad or a mouse, that enables you to move the pointer on the screen.

port—A socket on the computer where you plug in a cable for connection to a network or a peripheral device.

processor—See *Central Processing Unit (CPU)*.

program—A set of instructions that can be executed by a computer. The general classes of programs (also called software) are operating system, application, and utility. See also *operating system, application, utility*.

properties—The attributes of an object or device. For example, the properties of a file include the file's type, size, and creation date.

R

RAM (Random Access Memory)—*Volatile* memory that can be written to as well as read. *Volatile* here means that information in RAM is lost when you turn off your computer. This type of memory is used for your computer's main memory. See also *memory*. Compare *ROM*.

Random Access Memory—See *RAM*.

Read-Only Memory—See *ROM*.

reboot—See *boot, restart*.

removable disk—A disk that can be removed from a disk drive. A Flash drive is one example of a removable disk.

resolution—A measure of the sharpness of the images that can be produced by a printer or displayed on a screen. For a printer, resolution is expressed in dots per inch (dpi). For a screen, it is expressed as the number of pixels available horizontally and vertically.

restart—Synonymous with reboot. To reset the computer by reloading the operating system without turning the computer off. See also *boot*.

RGB (Red, Green, Blue) monitor—A monitor that reproduces all colors by mixing red, green, and blue light in various combinations.

RJ11 connector—A modular connector used on most U.S. telephone systems and direct-connect modems. The RJ11 connector is a 6-wire connector.

RJ45 connector—An eight-wire connector used to connect a computer to a network.

ROM (Read-Only Memory)—Non-volatile memory that can be read but not written to. *Non-volatile* here means that information in ROM remains whether or not the computer is receiving power. This type of memory is used to store your computer's BIOS, which is essential instructions the computer reads when you start it up. See also *BIOS, memory*. Compare *RAM*.

S

Secure Digital (SD)—A small, portable, non-volatile memory card used to store and transfer data between digital products, providing encryption capability for content security.

select—To highlight or otherwise specify text, data, or graphics with the intent to perform some operation on it.

serial—Processes that occur one at a time. In communications, it means the transmission of one bit at a time sequentially over a single channel. On your computer, the serial port provides a serial interface between the computer and an appropriate device. Compare *parallel*.

shortcut—See *keyboard shortcut*.

Sleep—A feature of some Windows® operating systems that allows you to turn off the computer without exiting your open applications and to continue from where you left off when you turn the computer on again.

software—See *program*. Compare *hardware*.

solid state drive—A data storage device that utilizes solid-state memory as opposed to a hard disk (see also *hard disk*). Solid state drives hold a large amount of information and are used for storage of programs and data.

Suspend—A feature of some Windows® operating systems that allows you to turn off the computer without exiting your open applications and to continue from where you left off when you turn the computer on again.

system prompt—The symbol (in the MS-DOS® operating system, generally a drive letter followed by a “greater than” sign) indicating where users are to enter commands.

T U

TFT display—See *active-matrix display*.

Universal Serial Bus (USB)—USB is a serial bus that supports data transfer. USB allows hot swapping of peripherals. See also *bus*, *hot swapping*, *serial*.

upload—To send a file to another computer through a modem or network. See also *download*.

USB—See *Universal Serial Bus (USB)*.

USB Flash drive—A small, portable flash memory card that plugs into a computer’s USB port and functions as a portable hard drive. They are smaller and more durable than an external hard drive because they do not contain any internal moving parts, but have less storage capacity. See also *Universal Serial Bus (USB)*.

utility—A computer program designed to perform a narrowly focused operation or solve a specific problem. Utilities are often related to computer system management.

W

Web—See *World Wide Web*.

Wi-Fi[®]—A registered trademark term of the Wi-Fi Alliance that stands for Wireless Fidelity, and is another term for the communication protocol to permit an Ethernet connection using wireless communication components.

World Wide Web (www)—The worldwide network of Web sites linked together over the Internet. A user of the Web can jump from site to site regardless of the location of the computer hosting the site. See also *Internet*.

Index

A

- AC adaptor 24
- AC power 75
- accessing
 - network 83
- adding
 - memory
 - check total memory 37
 - memory (optional) 30
 - optional external devices 29
- adequate ventilation
 - cooling fan 23
- audio features 83

B

- backing up files 60, 68
- battery
 - charging the real-time clock (RTC) 76
- BIOS Setup
 - see TOSHIBA Hardware Setup
- Blu-ray Disc™
 - using 69
- button
 - eject, optical disc drive 70

- power 28
- Shut down 31
- start 81

C

- caring for your computer 58
- character keys 64
- cleaning the computer 58
- communications
 - set up 82
- computer
 - caring for 58
 - cleaning 58
 - environmental precautions 21
 - moving 58
 - setting up 23
- computer lock 59
- computer will not start
 - troubleshooting 110
- computing habits
 - troubleshooting 123
- computing tips 60
- connecting
 - AC adaptor cord to (DC-IN) 25
 - computer to a network 83

- power cord/cable 25
 - connecting 24
- power source 25
- cooling fan
 - adequate ventilation 23
- customize
 - computer settings 58
- D**
- data/entire system backup
 - troubleshooting 126
- desktop
 - creating new icon 80
 - exploring the 79
 - icons 80
 - recycle bin 80
 - standard features 80
 - Windows® operating system 79
- Device Manager
 - fixing a problem 113
- display devices
 - external 57
- disposal information 9
- DVD
 - removing with computer off 74
 - removing with computer on 73
- DVD Blu-ray Disc™ player
 - troubleshooting 122
- DVDs
 - using 69
- E**
- eject button
 - optical disc drive 70
- eject, optical disc drive 70
- exploring
 - desktop 79
- F**
- files
 - backing up 60, 68
 - restore 68
 - saving 67
- function keys 65

- H**
- HDMI™ In port
 - using 57
- headphones
 - using 84
- Help and Support
 - troubleshooting 112
- hot key
 - disabling or enabling wireless devices 136
 - display brightness 133
 - Lock (Instant security) 132
 - volume mute 135
 - Zoom (Display resolution) 137
- Hot Key Cards 131
- Hot key functions 132
- I**
- icon
 - desktop 80
 - moving to desktop 80
 - recycle bin 80
 - safety 19
- installation
 - memory module 30
- installing
 - memory modules 30
- internal storage drive
 - recovery 38
- K**
- keyboard
 - Alt keys 65
 - character keys 64
 - Ctrl keys 65
 - Fn key 65
 - function keys 65
 - special Windows® keys 65
 - troubleshooting 115
- keys
 - Ctrl Fn Alt 65
 - function keys 65

L

LEDs

- system indicator lights
 - ON/OFF light 28
 - Web Camera light 85

Licenses 9

lock

- computer, using 59

M

manual eject hole

- optical disc drive 70

memory

- adding (optional) 30
- check total memory 37
- removing memory module slot cover 32

Memory card reader

- inserting memory media 86
- removing memory media 87
- using 85

memory module

- installation 30
 - inserting into socket 33
- removing 35, 36

microphone

- using 84

mouse utility 100

moving the computer 58

N

network

- accessing 83
- connecting your computer 83

networking

- wireless 82

notification area 82

O

online resources

- Toshiba 74

optical disc

- Auto-Run feature 72
- handling 72

inserting 70

playing optical media 72

positioning 71

recording optical media 73

removing with computer off 74

removing with computer on 73

optical disc drive

components 70

drive in-use indicator light 70

eject button 70

handling an optical disc 72

inserting an optical disc 70

manual eject hole 70

playing an audio CD 72

playing optical media 72

problems 117

recording optical media 73

removing a disc 73, 74

troubleshooting 117

using 69, 70

optical discs

troubleshooting 118

optical media

recording 73

optional external devices

adding 29

other documentation 20

P

password

deleting a supervisor 96

deleting a user 97

instant password 95

power-on password 95

setting 95

setting a supervisor 95

setting a user 97

supervisor password 95

user password 95

power

connecting cable to AC adaptor

25

- cord/cable 25
- cord/cable connectors 138
- energy-saving features 75
- turning on 28
- power button 28
- power management 75
 - optimum performance 75
- power plans
 - selecting power plan options 76
- precautions
 - safety 22
- printer
 - troubleshooting 120
- problem solving
 - contacting Toshiba 129
 - Startup options 111
- program, starting 66
- program, starting from Start menu 67

R

- recording sounds 83
 - recovery
 - checking internal storage drive
 - operating status 56
 - creating recovery DVDs/media 50
 - erasing internal storage drive 54
 - installing drivers and applications 56
 - internal storage drive 38
 - out-of-box state 39
 - with user's data 42
 - restoring from recovery DVDs/media 52
 - to custom size partition 48
 - without changing drive partitions 45
 - recycle bin icon 80
 - registering computer 29
 - removing
 - an optical disc with computer on 73
 - and optical disc with computer off 74
 - memory module 35
 - memory module slot cover 32
 - restore points
 - troubleshooting 124
 - restoring your work 68
- ## S
- safety
 - icons 19
 - precautions 22
 - saving files 67
 - Search programs and files field
 - starting a program 66
 - selecting
 - power plan options 76
 - setting up
 - adding memory (optional) 30
 - communications 82
 - computer 23
 - software
 - Setup Wizard 29
 - work environment 21
 - settings
 - customize computer settings 58
 - Shut down
 - button 31
 - computer 31
 - software
 - Setup Wizard 29
 - software program
 - starting 66
 - starting from Start menu 67
 - sounds
 - recording 83
 - speakers
 - using external 84
 - start button 81
 - starting a program 66
 - Search programs and files field 66
 - Windows® Start menu 67

- starting a program from Start 67
- Startup menu
 - problem solving 111
- supervisor password, deleting 96
- supervisor password, set up 95
- system indicator lights
 - drive in-use indicator 70
 - LEDs 28, 85
- T**
- taskbar 82
- tips
 - for computing 60
- Toshiba
 - online resources 74
 - registering computer
 - Toshiba Web site 29
 - worldwide offices 130
- TOSHIBA Accessibility 106
- Toshiba accessories
 - memory 30
- TOSHIBA Application Installer 94
- TOSHIBA Assist 90
 - Connect tab 91
 - Optimize tab 93
 - Protect & Fix tab 92
 - Secure tab 91
- TOSHIBA Button Support 105
- TOSHIBA eco power plan 78
- TOSHIBA eco Utility™ 107
- TOSHIBA Face Recognition Utility 98
- TOSHIBA Hardware Setup 101
- TOSHIBA PC Diagnostic Tool Utility 99
- TOSHIBA PC Health Monitor 108
- Toshiba remote control 88
 - using 88
- TOSHIBA Service Station 107
- TOSHIBA Sleep Utility 102
- troubleshooting 115
 - bookmarked site not found 112
 - checking device properties 113
 - computer will not start 110
 - corrupted/damaged data files 117
 - data/entire system backup 126
 - Device Manager 113
 - Disk Defragmenter 117
 - display problems
 - screen is blank 115
 - DVD Blu-ray Disc™ player 122
 - eject button 118
 - error message, warning resume failure 110
 - Error-checking 116
 - external keyboard 115
 - good computing habits 123
 - hard disk drive is slow 117
 - Help and Support, Windows® operating system 112
 - high-pitched noise 120
 - installing hardware/software 126
 - keyboard 115
 - keyboard will not respond 110
 - memory problems 114
 - missing files/trouble accessing a drive 116
 - online content, Blu-ray Disc™ 118
 - on-screen eject button 118
 - optical disc drive 117
 - power and battery 114
 - printer 120
 - restore points 124
 - screen does not look correct/flickers 115
 - slow Internet connection 112
 - sound system 119
 - sound, Blu-ray Disc™ 118
 - trouble running discs 118
 - trouble running programs 117
 - URL address not found 112
 - USB Sleep and Charge
 - cannot use 127, 128

-
- Windows® operating system not working 111
 - wireless networking 121
 - turning on
 - power 28
 - U**
 - USB Sleep and Charge
 - cannot use 127, 128
 - user password, deleting 97
 - user password, setting 97
 - using
 - a microphone 84
 - computer lock 59
 - DVDs 69
 - Memory card reader 85
 - optical disc drive 69
 - TOSHIBA eco power plan 78
 - Web Camera 85
 - using the wireless mouse 61
 - Utilities 89
 - W**
 - warranty
 - standard limited warranty 20
 - Web Camera
 - using 85
 - Web sites 129
 - Wi-Fi®
 - wireless networking 82
 - Windows® operating system
 - desktop 79
 - troubleshooting 111
 - Windows® Start menu
 - starting a program 67
 - wireless keyboard
 - batteries 63
 - functions 64
 - using 63
 - wireless mouse
 - batteries 62
 - using 61
 - wireless networking 82

Free Manuals Download Website

<http://myh66.com>

<http://usermanuals.us>

<http://www.somanuals.com>

<http://www.4manuals.cc>

<http://www.manual-lib.com>

<http://www.404manual.com>

<http://www.luxmanual.com>

<http://aubethermostatmanual.com>

Golf course search by state

<http://golfingnear.com>

Email search by domain

<http://emailbydomain.com>

Auto manuals search

<http://auto.somanuals.com>

TV manuals search

<http://tv.somanuals.com>