

# TOSHIBA

PRODUCT GUIDE

# Microcomputer



Toshiba offers total solutions to meet your microcomputer needs with an extensive product line-up supported by our software and development system experts.

Toshiba microcomputer development system product line-up



**TLCS-870 Family**

**8-bit**

**NEW**

- High-speed processing capability equivalent to 16-bit microcontrollers
- Address space extended to 128 Kbytes
- 5-V operation
- On-chip debug function

**TLCS-870/C1**

Minimum instruction execution time: 125 ns

• Address space extended to 1 Mbyte

**TLCS-870/X**

• Core architecture optimized for C compiler

**TLCS-870/C**

Minimum instruction execution time: 250 ns

**[New Core] TLCS-870/C1 Series**

The new 8-bit CPU core delivering high-speed processing capability and memory address space extension, while offering instruction code compatibility with TLCS-870/C

**NEW** **TMP89FS60UG/FG** Under development

General-purpose 64-pin product providing various interfaces for serial communications and a timer system



64-pin LQFP  
10mm × 10mm / 0.5mm pitch



64-pin QFP  
14mm × 14mm / 0.8mm pitch

Toshiba software IP line-up

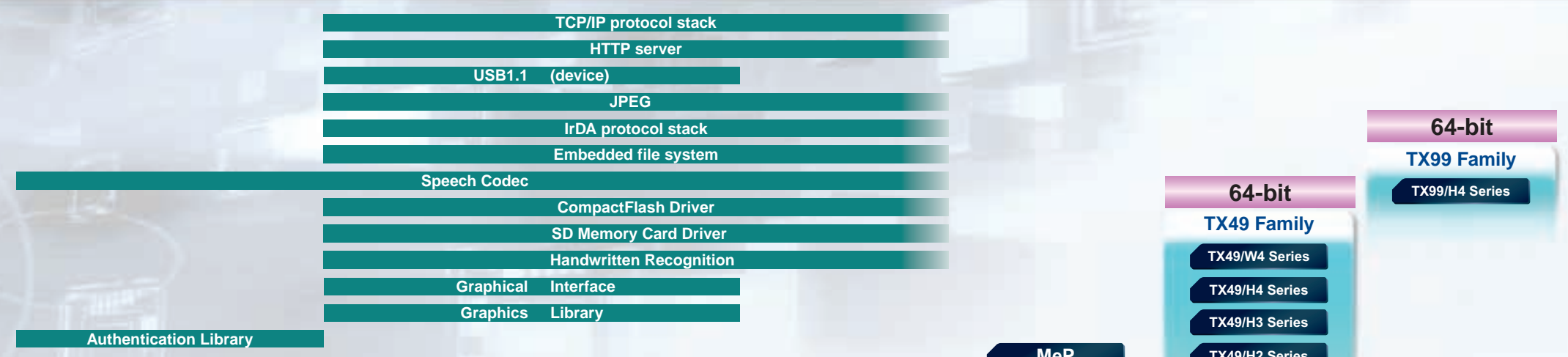

Toshiba microcomputer line-up





**NEW 8-Bit Microcontrollers**

# Toshiba Microcontrollers TLCS-870/C1 Series

Realizing processing capability equivalent to 16-bit microcontrollers and memory address space extendable up to 128 Kbytes

Toshiba has newly developed TLCS-870/C1 Series of 8-bit microcontrollers that deliver high-speed processing capability equivalent to 16-bit microcontrollers. The TLCS-870/C1 Series achieves high-speed processing capability at low internal clock frequencies by operating one instruction cycle in a single clock cycle. Toshiba's proprietary memory segment method allows addressing up to 128 Kbytes of memory address space.

## Toshiba microcontroller core line-up

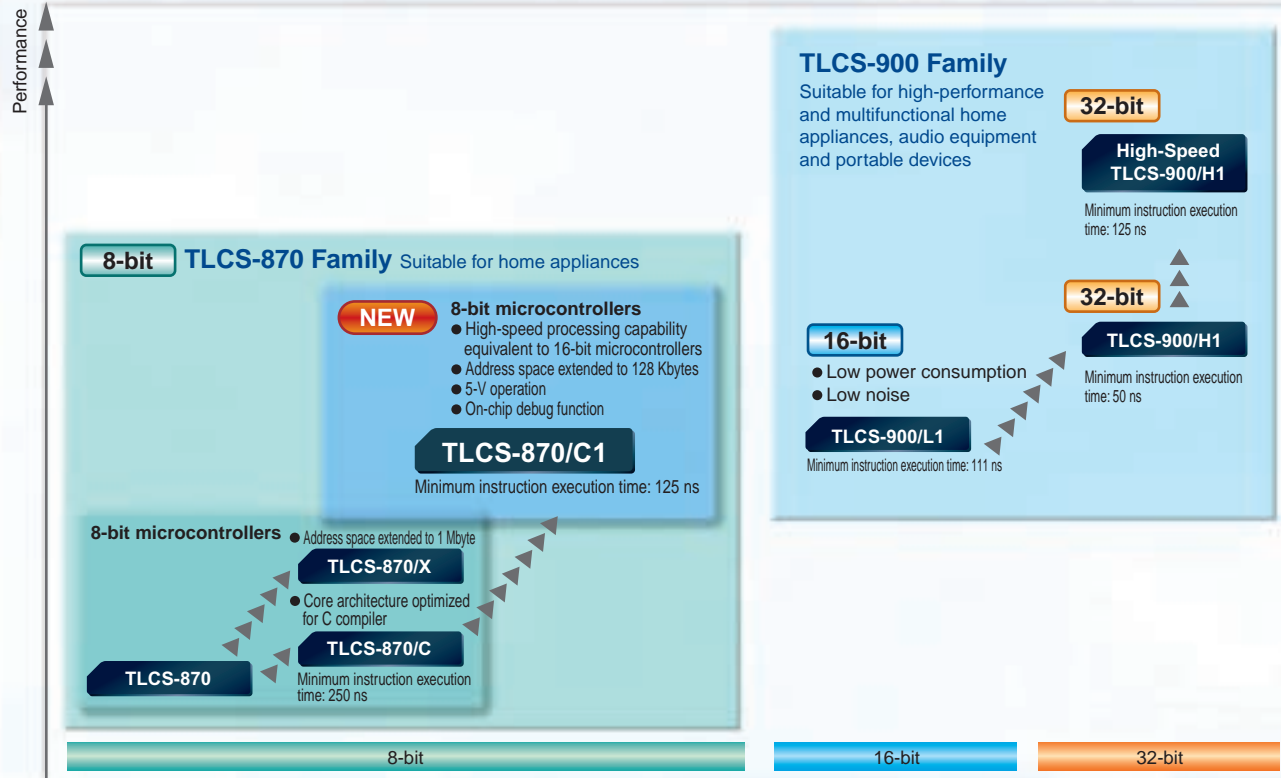

## Features of TLCS-870/C1 Series

The new 8-bit CPU core delivering high-speed processing capability and memory address space extension, while offering instruction code compatibility with TLCS-870/C

### High-speed processing at a low clock frequency

#### One instruction cycle operated in a single clock cycle

The core architecture is configured to reduce the number of clock cycles required to complete one machine cycle to a single clock cycle. This achieves processing performance four times that of TLCS-870/C Series at the same internal clock frequency.

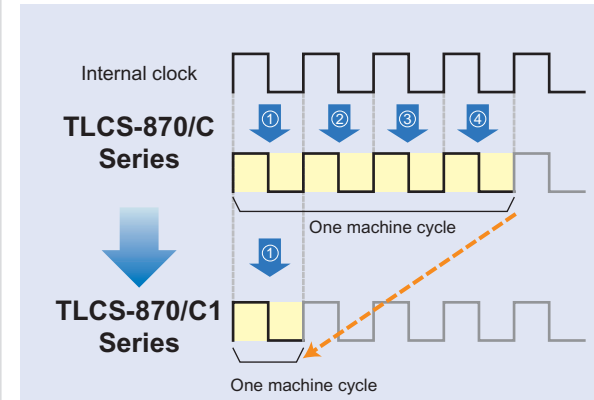

#### Advantages of low-frequency operation

- Compared to the TLCS-870/C, power consumption can be reduced at the same performance level.
- Noise generation can be reduced.

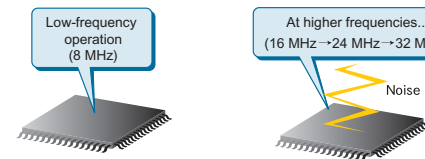

TLCS-870/C1 Series: Minimum instruction execution time of 125 ns  
 TLCS-870/C Series: Minimum instruction execution time of 250 ns  
 \*The minimum instruction execution time is reduced by half compared to TLCS-870/C.

### Address space extendable to 128 Kbytes

#### Toshiba's proprietary memory management method (segment method) **NEW**

Toshiba's proprietary memory segment method manages instruction codes and data independently in separate memory address spaces. This new method enables memory address space extension without affecting processing speed or code efficiency for small- to large-sized programs exceeding 64 Kbytes.

#### Segment method

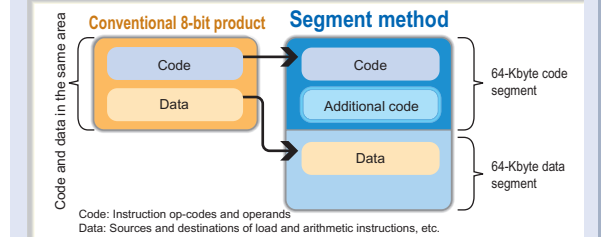

#### Compact core and object sizes

Compared to the address bus extension method, core and code sizes are reduced. The instruction set is compatible with TLCS-870/C.

#### Software design facilitated

Unlike the bank switching method, small- to large-sized programs need not be modified. Processing speed and code efficiency are unaffected even if the code size exceeds 64 Kbytes.

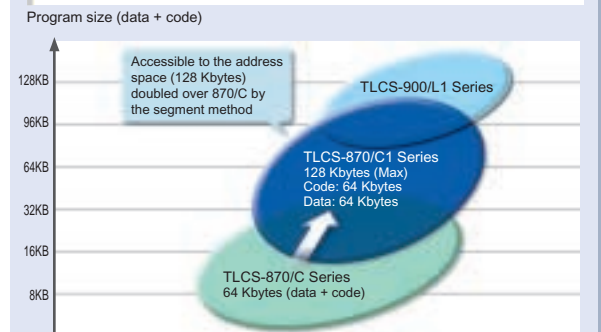

## NEW Product line-up

### 8-bit Flash microcontrollers based on TLCS-870/C1 core

#### TMP89FS60UG/FG\*\*

General-purpose 64-pin product providing various interfaces for serial communications and a timer system

#### TLCS-870/C1 Core

- Operating voltage: 4.5 to 5.5 V at 8 MHz, 2.7 to 5.5 V at 4.2 MHz
- Clock gear: 1/4, 1/2, 1/1

#### Built-In Functions

- Voltage detecting circuit** (Two voltage levels detectable, reset or interrupt selectable)
- Power-on reset circuit** (Threshold voltage: 2.4 V ± 0.2 V)
- 8-bit timer/counter**: 4 channels (Resolution: 125 ns at 8 MHz)
- 16-bit timer/counter**: 2 channels (Resolution: 250 ns at 8 MHz)
- UART/SIO\***: 2 channels (UART: 128 Kbps, SIO: 4 Mbps at 8 MHz)
- UART**: 1 channel (UART: 128 Kbps at 8 MHz)
- I<sup>2</sup>C/SIO\***: 1 channel (I<sup>2</sup>C: 400 Kbps, SIO: 4 Mbps at 8 MHz)
- \* Two SIO channels can be used simultaneously.
- 10-bit AD converter: 16 channels
- Built-in pull-up resistors
- On-chip debug function (Flash version only)

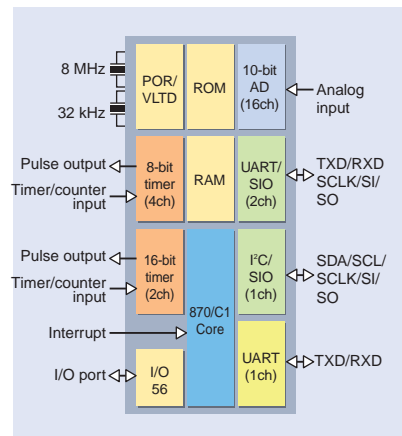

#### 870/C1 Series road map (planned)

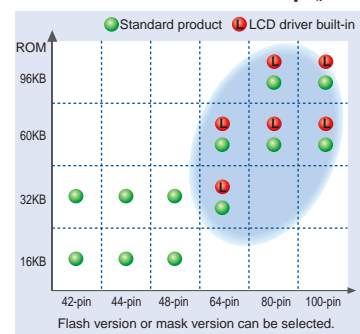

Packages:  
 UG: 64-pin LQFP (10 mm x 10 mm/0.50-mm pitch)  
 FG: 64-pin QFP (14 mm x 14 mm/0.80-mm pitch)

Part Number	ROM	RAM
TMP89CM60UG/FG**	32 KB	3.0 KB
TMP89CS60UG/FG**	60 KB	3.0 KB
TMP89FS60UG/FG**	60 KB	3.0 KB

\*\* : Under development \*\* : Under planning

## Development System

### Toshiba Integrated Development Environment (TIDE)

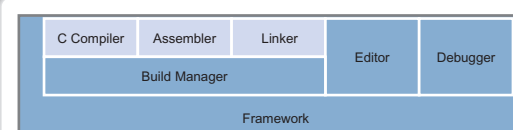

Using the Integrated Development Environment (IDE) together with C Compiler enables seamless operations of coding, building and debugging tasks which must be performed repeatedly in the software development process. Toshiba development tools offer a variety of latest functions to realize a user-friendly and highly efficient debug environment.

### Emulators

\*Under development. Specifications are subject to change without notice.

#### On-chip debug emulator

- Business-card-sized compact emulator
- No need for power supply (using USB bus power)
- Target connection via a narrow-pitched cable
- Extensive on-chip debug functions
- Break/event : 8 breakpoints/1 event
- Trace : The last two branches can be stored in real time.
- Memory access : Display/Rewrite during program execution in 1-byte units (with a wait of 1 clock cycle)
- Debug pin : Two I/O pins
- Flash programming function
- IDE included (downloadable from website)

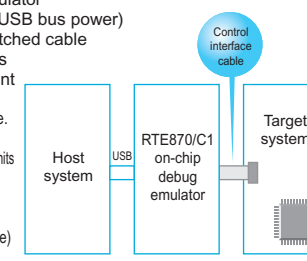

\*The target system requires a separate power supply.

#### In-circuit emulator

- Compact, low-cost, yet highly functional in-circuit emulator (compared to RTE870/C model 15)
- Various 870/C1 Series devices supported by replacing the probe
- Common probe with RTE870/C Light\*
- (\* ) Compact emulator for 870/C Series
- Connected with the host system via USB
- IDE included (downloadable from website)
- Supports on-chip debug emulation.

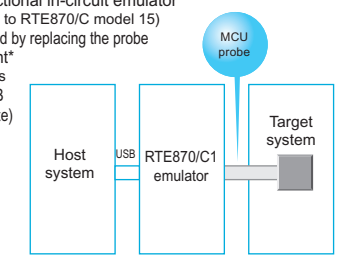

\*The target system requires a separate power supply.

# Toshiba's Flash Microcontrollers

Toshiba offers an extensive line-up of microcontrollers with on-chip Flash memory ranging from small-capacity to 2 Mbytes. You can find a wide variety of products from low-pin-count devices to high-functionality devices.

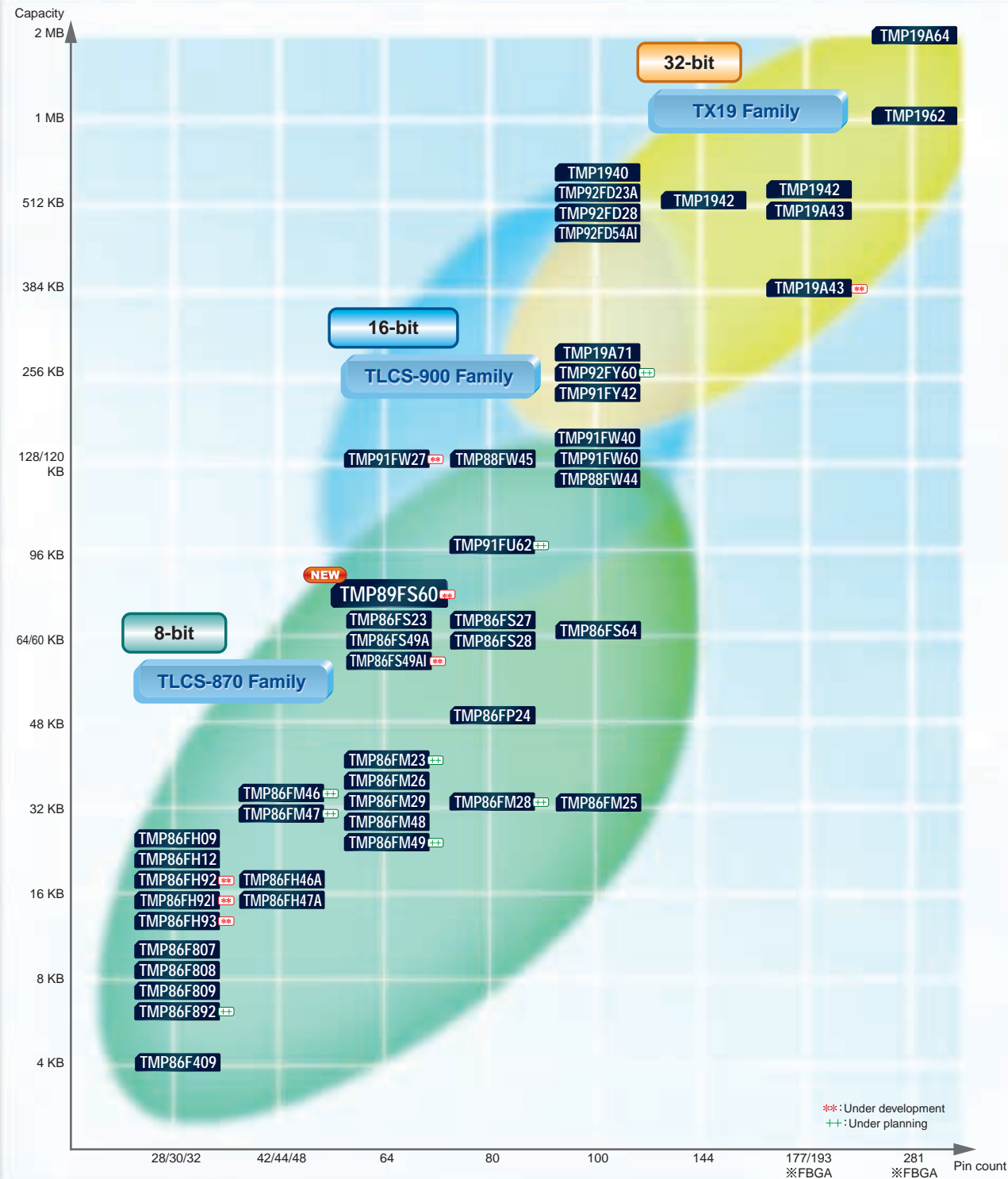

## Products with built-in LCD driver

- 8-bit TLCS-870 Family**
    - TMP86FM23++
    - TMP86F27
    - TMP86FP24
    - TMP86FM25
    - TMP86FM26
  - 16-bit TLCS-900 Family**
    - TMP91FW40
- ++: Under planning

## Products in low-pin-count packages

- 8-bit TLCS-870 Family**
    - TMP86F409
    - TMP86F807
    - TMP86F808
    - TMP86F809
    - TMP86F892++
    - TMP86FH12
    - TMP86FH109
    - TMP86FH46A
  - 8-bit TLCS-870 Family**
    - TMP86FM46++
    - TMP86F27
    - TMP86FM47++
    - TMP86F28
    - TMP86FM28
    - TMP86FM25
    - TMP86FM23
    - TMP86FM26
    - TMP86FM29
    - TMP86FM48
    - TMP86FM49
    - TMP86F807
    - TMP86F808
    - TMP86F809
    - TMP86F892
    - TMP86FH09
    - TMP86FH12
    - TMP86FH92
    - TMP86FH921
    - TMP86FH93
    - TMP86FH46A
    - TMP86FH47A
- ++: Under planning

## NEW

- 8-bit microcontroller**
    - TMP89FS60\*\*

General-purpose 64-pin product providing various interfaces for serial communications and a timer system
  - 16-bit microcontroller**
    - TMP91FY42

100-pin product featuring large-capacity Flash memory (256 Kbytes)
  - 32-bit microcontroller**
    - TMP92FD28

100-pin product incorporating a USB host controller
- \*\* : Under development

## Features of Toshiba's Flash microcontrollers

- High-speed programming**  
NANO FLASH™ allows 0.5 Mbytes of data to be programmed in 2 seconds.
- A wide range of operating voltages**  
Operating voltages ranging from 2.7 V to 5 V are supported.
- A wide variety of peripheral functions**  
The line-up includes products with various application-specific functions, such as an LCD driver, an inverter motor control function (PMD), or an IGBT control timer, as well as general-purpose products.
- Enhanced security function**  
Up to 255 bytes of password protection can be implemented to prevent illegal read accesses.
- Various Flash programming methods**  
In addition to serial mode and parallel mode, ISP (In System Programming) is supported.
- Low power consumption**  
NANO FLASH™ realizes the same level of low power consumption compared with mask ROM products.
- Quick programming service**  
Flash programming service is available to enable QTAT (quick turnaround time).
- On-chip debug function incorporated**  
The on-chip debug function improves development efficiency by allowing debugging on mass-production boards.

## Full support system for Toshiba's Flash microcontrollers

- Flash programming service**  
Flash programming service enables QTAT (quick turnaround time), allowing customers to achieve shorter time-to-market.

- QTAT**..... Quick Flash programming service is available. (Note)
- Quality assurance**..... The same level of quality as that of mask ROM products is assured.
- Marking**..... Custom marking is possible.
- Support**..... In addition to programming at Toshiba, customers can use our partner programming houses.

Note:  
Delivery time varies with various conditions such as quantity, order acceptance time, factory operation schedule, and product type. For details, please contact your local Toshiba sales representative.

**Toshiba Semiconductor website**  
<http://www.semicon.toshiba.co.jp/eng/index.html>  
Information on the entire spectrum of Toshiba semiconductor products is available here.



- Solution**  
You can access latest information for each of system applications.
- Product information**  
You can access a wide range of new-product information, presentation data material and other data.

## Various programming tools

Toshiba offers a wide variety of programming tools to meet various needs of customers from development to mass production. Programming services are also available.

Category	Tool type	Tool vendor	Phase		
			Development	Mass production	Maintenance
Off-board programming (Note 1)	Programming adapter	Toshiba Corporation	●	● (Note 5)	
	Single-device programmer	Flash Support Group, Inc. HI-LO System Research Co., Ltd. MINATO ELECTRONICS INC. Shanghai Gengyan Electric Technology Co., Ltd T.S ELECTRONICS CO., LTD**	●	●	
	Gang programmer	Flash Support Group, Inc. HI-LO System Research Co., Ltd. MINATO ELECTRONICS INC. Shanghai Gengyan Electric Technology Co., Ltd		●	
On-board programming (Note 2)	In-circuit programmer	Sophia Systems Co., Ltd. Flash Support Group, Inc. (Note 3) Yokogawa Digital Computer Corporation	●	●	●
Programming services (Note 4)		Toshiba Corporation		●	
		MICROTEK Inc.		●	

Note 1: Off-board programming is a method to program a Flash device before it is mounted on the system board.  
Note 2: On-board programming is a method to program a Flash device after it has been mounted on the system board.  
Note 3: The in-circuit programmer from Flash Support Group allows off-board single-device programming by connecting an optional adapter.  
Note 4: Programming services are also available from some of the other programming tool vendors in this table apart from Toshiba and MICROTEK.  
Note 5: Some limitations apply when the programming adapter is used for mass production. For details, contact your local Toshiba sales representative.

## Toshiba's Flash programming tool Flash adapter

The Flash adapter is a programming adapter supporting Toshiba's microcontrollers with on-chip Flash memory. Connecting the Flash adapter with your PC allows you to program, erase and verify on-chip Flash memory. The Flash adapter is provided for each package type.



Connection example

\* The user is required to connect write signals and mount oscillators as appropriate to each device.



## Reliable, User-Friendly Development Systems for Toshiba Microcomputers

Toshiba offers a complete lineup of reliable, user-friendly development tools to support customers in each phase of program development from design to evaluation.

### Compact ICE for TLCS-870/C Series

#### RTE870/C Light emulator

The RTE870/C Light emulator is comprised of the minimum functions required for debugging, and comes in three types to support all MCUs in the TLCS-870/C Series (excluding the TMP86x24FG).

#### ● The price is "Light".

- Integration of the RTE controller and pod system makes the emulator more affordable.
- Comes with a free debugger download.

#### ● The connection is "Light".

- The host interface is through USB.
- Can be easily connected to a notebook PC.

#### ● The size is "Light".

- A new system configuration succeeded in integrating the system on a single board.
- A smaller probe tip takes less space on the target board.

#### RTE870/C Light debugger

- Exclusively for RTE870/C Light system
- The same GUI as RTE87/C model15 debugger

Downloadable from our development system website

(User registration is required.)



#### Product components:

- RTE870/C Light emulator
- AC power adapter

#### Other required items:

- Probe set
- Emulation chip
- Language tool
- Host system (PC)
- USB cable (USB standard A to B)

\* For the detailed specifications of the RTE870/C Light emulator, see "Outline of TLCS-870 Family Development System on page 58."

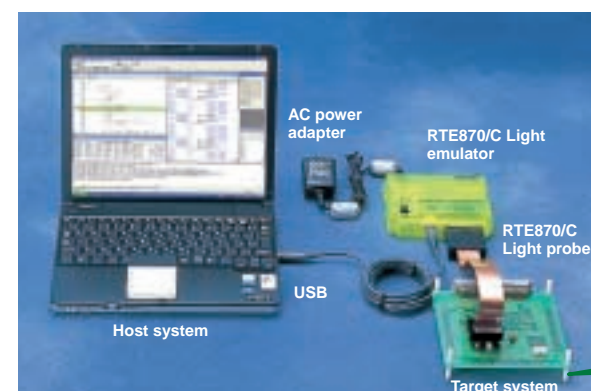

\*The target system requires a separate power supply.

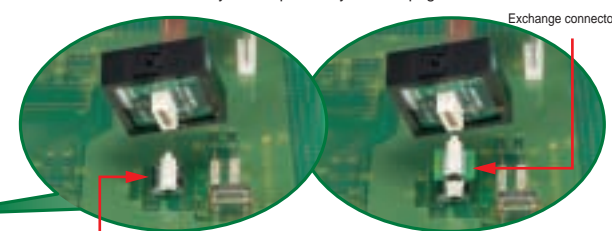

Target connector

[Usage example]

#### Probe set

The probe set is available for each package pin count or package type of supported MCUs.

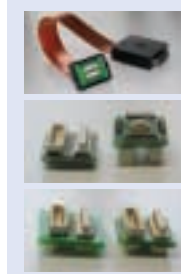

#### Set components:

- **RTE870/C Light probe**  
Used to connect the emulator and target system.
- **Target connector**  
Used to connect the probe to the target system.
- **Exchange connector**  
Required with some MCUs.

#### Option

##### ● Stacking connector

The stacking connector is used between the probe and the target connector to raise height so that the target system can be connected easily when there is not enough space around the target connector.

##### ● MCU mounting adapter for RTE870/C Light «Bump socket»

The bump socket is used together with the target connector to mount an MCU on the target system.

##### ● M15-Light connection exchange cable

The M15-Light connection exchange cable allows you to connect the RTE870/C Light system to a target system that has been debugged with the RTE870/C model 15 system. (The target connecting board used with the RTE870/C model 15 system is required.)

The probe set and options are manufactured by ADLINKS Co., Ltd. These products are distributed by Daimaru Kogyo K.K.

<http://www.adlinks.co.jp/>

## Toshiba Software IP

As product development becomes sophisticated and increasingly offers technical advantages, high-performance and large-scale development becomes required in software development, and the development cycle has turned longer. To address this situation, Toshiba aims to faster time to market, realize functions with software, and improve quality by producing software components.

#### Features of the Software IP

1. Full supports for microcomputers from 8 to 32 bits.
2. Optimized design concept for Toshiba microcomputers.
3. Pursuit of flexible designs and interfaces not limiting application types.
4. Flexible response to any development environments and platforms.



## Toshiba's MCU Plus Software IP Platform

#### Operation check and evaluation with a demonstration board and application.

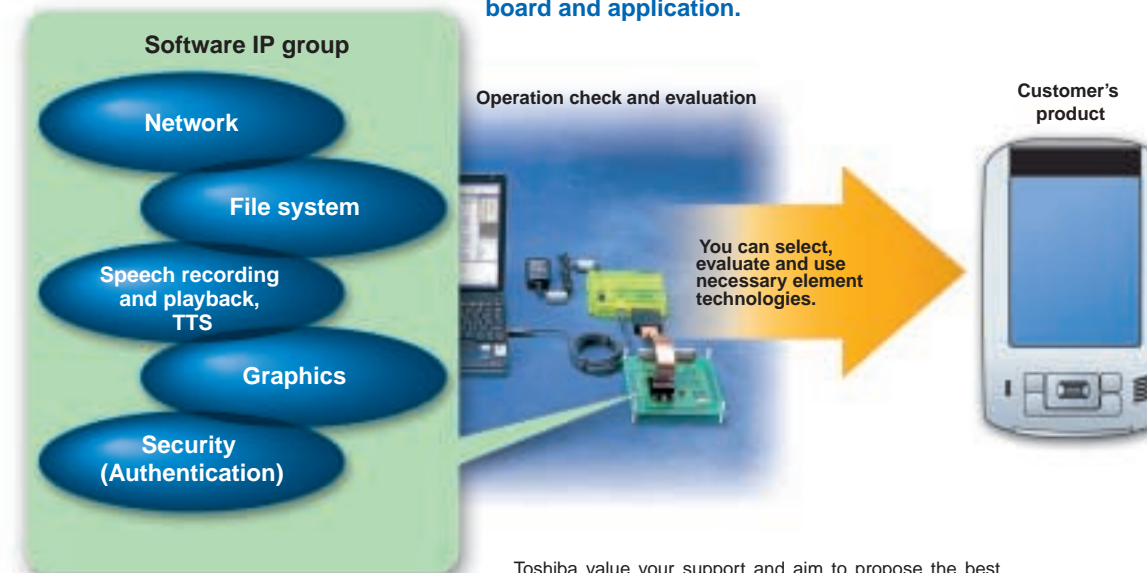

## System Support

- Software IPs
  - Reference application software
  - Reference models
- We offer a variety of software and solution to speed up your development time.

#### Evaluation board for software IP (SWIP)



#### Evaluation board for portable devices



#### Reference model for LCD TV



\* For details of software IPs, see the page 61 of this product guide.

\* The outlines of microcomputer development systems can be found on page 53 onward.



## Toshiba is committed to supporting our customers in system development.

### Development support

Toshiba utilizes global networking to provide powerful support for system development by our customers around the world. We provide support for microcomputer development including development systems, middleware, application software and all types of software IP for software development. We also have an organization for providing needed information to our customers in a timely fashion, through channels such as Web services.

### On-site support

Toshiba provides extensive local support to satisfy customer needs varying from region to region.

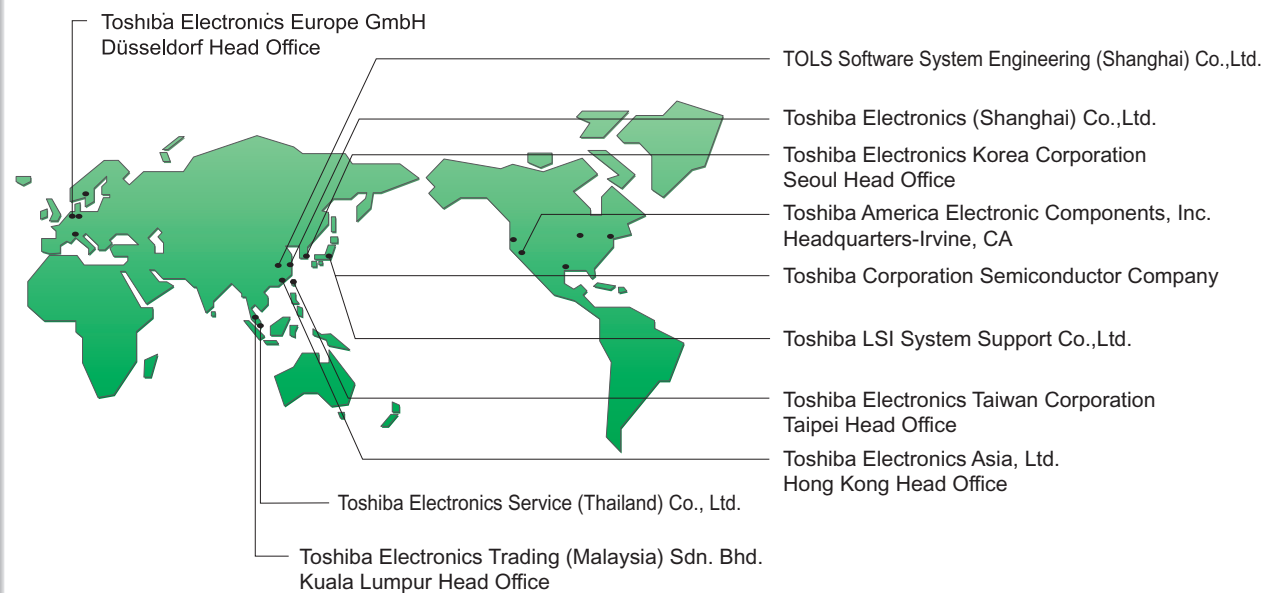

### Web support

Toshiba Semiconductor Website

<http://www.semicon.toshiba.co.jp/eng/>

Toshiba provides technical information through our website, with the aim of supplying information to customers as early as possible to improve their satisfaction.



### System support

#### Software IPs

#### Reference application software

#### Reference models

We provide a wide range of software development support for customers so that they can reduce the time required for development.

#### Evaluation board for software IP (SWIP)

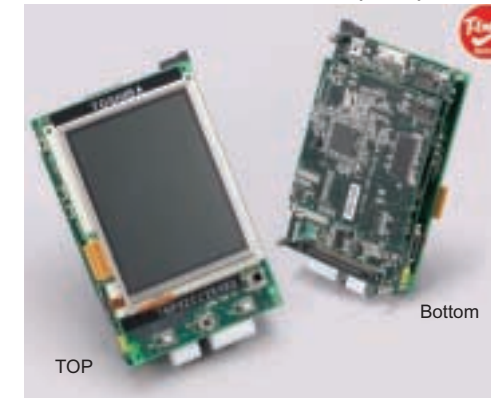

#### Evaluation board for portable devices



- Allows direct connection to Toshiba's emulation pod.
- Supports on-board Flash programming.

#### Evaluation board for inverter lighting equipment

- Fluorescent lamp lighting by high-frequency half-bridge inverter control using IGBT control timer.
- Dimmer function by frequency and duty adjustment.



#### Evaluation board for PMD microcontrollers



- Supports both sensorless and sensed brushless DC motors.
- Equipped with software for square wave and sine wave drive.

## CONTENTS

### Microcontrollers Listed by Function/Application

Microcontrollers with motor control circuit (PMD)	12
Microcontrollers with LCD controller	13
Microcontrollers with LCD driver	14
Microcontrollers with fluorescent display tube driver	16
General-purpose microcontrollers in compact packages	17
Microcontrollers with AD converters	20
Microcontrollers for personal equipment	24
Microcontrollers for televisions	25
Microprocessors for digital equipment	26
Microcomputers for automotive applications	27
Microcontrollers for automotive motor control	29
Microcontrollers for inverter electric appliances	30
Microcontrollers for digital single-lens reflex cameras (DSLRs)	31
Microcontrollers for digital video cameras (DVCs)	31
Microcontrollers for audio (CD-MP3 control MCUs)	32
Microcontrollers for audio (Main control MCUs)	32

64-Bit Superscalar TX System RISC TX99 Family	34
64-Bit TX System RISC TX49 Family	35
Companion Chip	39
32-Bit TX System RISC TX39 Family	39
MeP (Media embedded Processor)	40
32-bit TX System RISC TX19 Family	41

16/32-bit Microcontrollers TLCS-900 Family	44
8-bit Microcontrollers TLCS-870 Family	47

4-Bit / 8 -Bit LL Microcontroller T4X Series / T6H Series	51
--	----

Development System	53
Outline of TX19 Family Development System	54
Outline of TLCS-900 Family Development System	56
Outline of TLCS-870 Family Development System	58
Programming tools / Accessories	60

Software Development Support	61
Introducing the Latest Software IP	62
Guide to Websites	63
Package List	64



## Microcontrollers with motor control circuit (PMD)

These microcontrollers with a motor control circuit incorporate an inverter control function for 3-phase DC and AC motors. The motor control circuit supports hardware configuration where motor drive signals are linked with feedback signals from the motor, thus controlling the motor with less load imposed on the CPU. The line-up includes a variety of microcontrollers supporting 120-degree commutation and vector control.

### Main functions

- Sine wave drive
- Rotor position detection function
- Motor control timer and timer capture
- PWM waveform generation function
- Overload protection function
- Abnormality protection function
- Automatic commutation start and automatic position detection start
- AD converter trigger generation function

## 8-bit microcontrollers with motor control circuit (PMD)

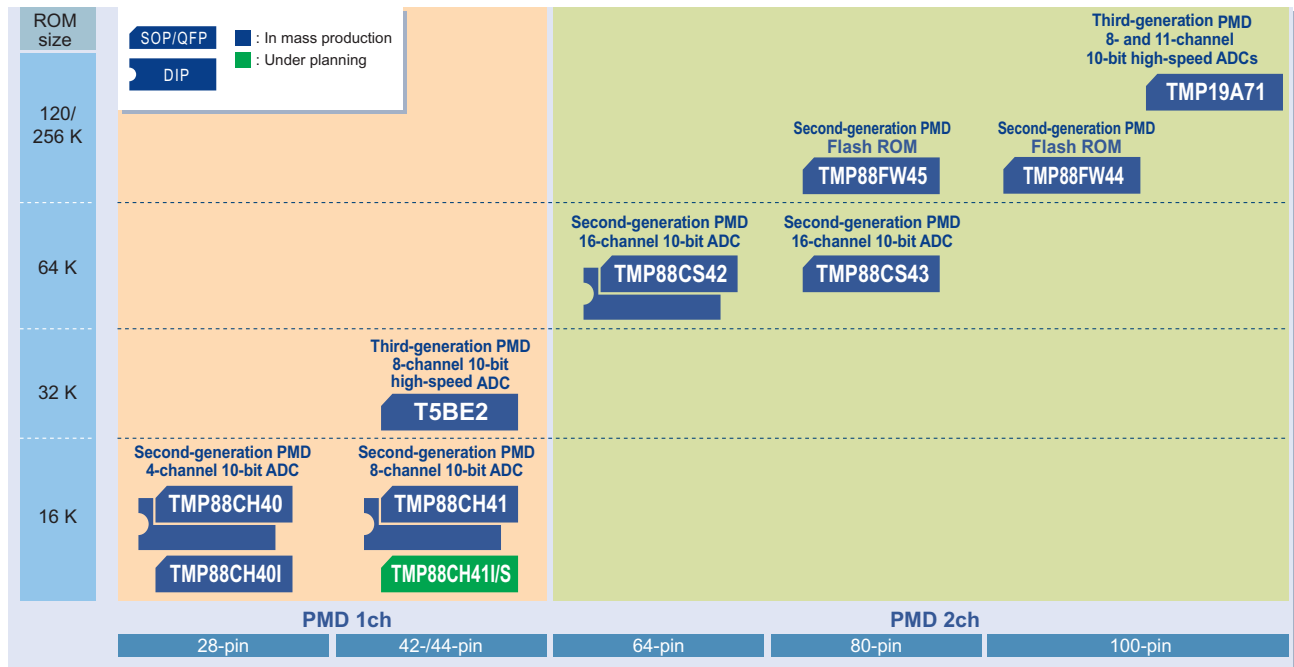

\* PMD : Programmable Motor Driver

## Product line-up

Series Name	Part Number	Flash	ROM (bytes)	RAM (bytes)	I/O	PMD (channel)	Additional Functions	Supply Voltage (V)	Version with OTP/Flash	Package
870/X	TMP88CH40NG/MG		16 K	512	19	1	● 10-bit AD converter ● UART ● SIO	4.5 to 5.5	TMP88PH40NG/MG	SDIP28/SOP28
	TMP88CH40IMG								TMP88PH40MG	SOP28
	TMP88CH41NG/UG				33				TMP88PH41NG/UG	SDIP42/LQFP44(10 × 10mm)
	TMP88CH41IUG++/SUG++								TMP88PH41IUG	LQFP44(10 × 10mm)
	TMP88CS42NG/FG		64 K	2K	55	2	● 10-bit AD converter ● UART ● SIO ● PWM	4.5 to 5.5	TMP88PS42NG/FG	SDIP64/QFP64 (14 × 20mm)
	TMP88CS43FG								TMP88PS43FG	QFP80(14 × 20mm)
	TMP88FW44FG	●	120K	4K	91	2	● 10-bit AD converter ● UART ● SIO ● PWM	4.5 to 5.5	-	QFP100(14 × 20mm)
	TMP88FW45FG	●							71	2
DSP	T5BE2		32K	1K	22	1	● 10-bit AD converter ● UART/SIO ● PWM ● Encoder input	3.0 to 3.6	T5BE1	LQFP44(10 × 10mm)
TX19A	TMP19A71CYUG/FG		256 K	10K	75	2	● 10-bit AD converter ● UART/SIO ● PWM ● Encoder input	3.0 to 3.6	TMP19A71FYUG/FG	LQFP100(14 × 14mm)/ QFP100(14 × 20mm)

\* For details of the products listed above, see the "Part Number List".

++: Under planning

\* Some of the flash memories use the SuperFlash® technology under the license of Silicon Storage Technology, Inc. SuperFlash® is a registered trademark of Silicon Storage Technology, Inc.

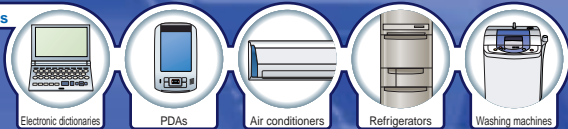

## Microcontrollers with LCD controller

The following microcontrollers contain LCD controller circuitry that supports monochrome and color STN/TFT. The line-up thus supports a wide range of LCDs with different sizes.

- Main functions**

  - Monochrome/Gray/Color LCD controller
  - Memory interface: SDRAM, NAND Flash, SD card
  - Large-capacity memory access MMU
  - Touch Screen interface

### 16-/32-bit microcontrollers with LCD controller

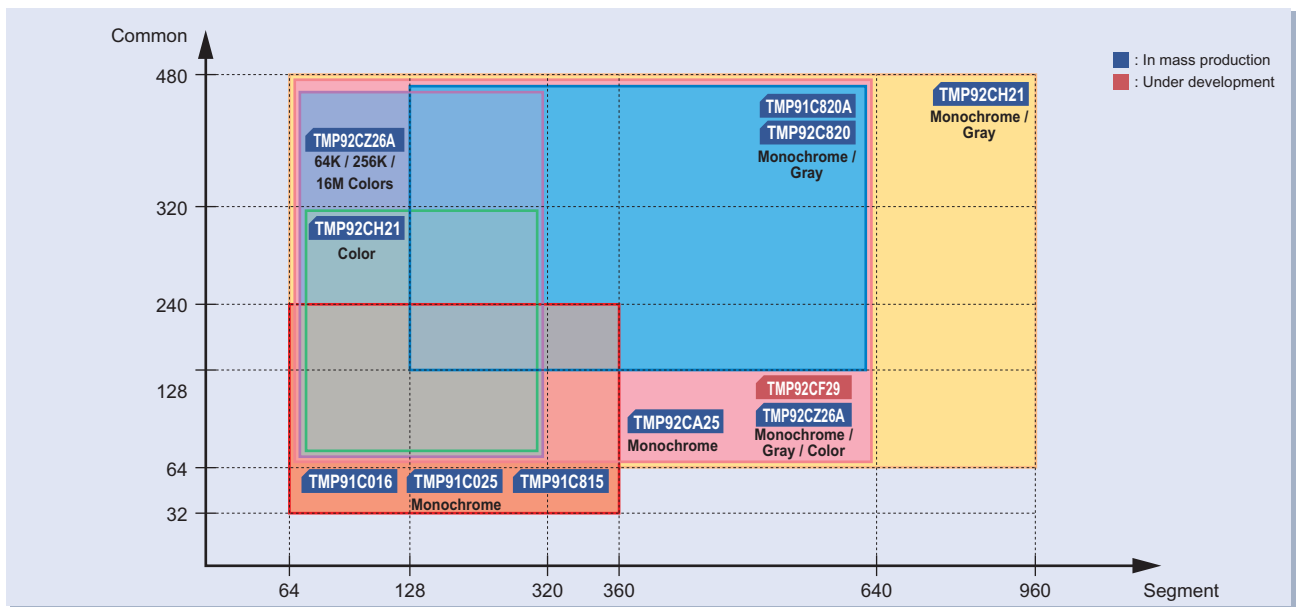

### Product line-up

Part Number	ROM (bytes)	RAM (bytes)	I/O	LCD-CTRL		Additional Functions	Supply Voltage (V)	Package
				Color	Display Size			
TMP91C016FG	-	-	31	W/B	64seg. x 32com. to 360seg. x 240com.	<ul style="list-style-type: none"> <li>MMU (105MB)</li> <li>DRAM controller</li> <li>Display data X/Y axis conversion circuit (8 x 8)</li> </ul>	1.8 to 3.6	LQFP100 (14 x 14mm)
TMP91C025FG	-	-	38			<ul style="list-style-type: none"> <li>MMU (72MB)</li> <li>Touch Screen interface</li> </ul>	2.4 to 3.6	
TMP91C815FG	-	8K	61			<ul style="list-style-type: none"> <li>MMU (136MB)</li> </ul>	1.8 to 3.6	
TMP91C820AFG	8K	8K	77	16 Gray	128seg. x 128com. to 640seg. x 480com.	<ul style="list-style-type: none"> <li>MMU (136MB)</li> <li>SDRAM controller</li> </ul>	2.7 to 3.6	LQFP144 (16 x 16mm)
TMP92C820FG	-	8K	83			<ul style="list-style-type: none"> <li>MMU (136MB)</li> <li>SDRAM controller</li> </ul>	3.0 to 3.6	
TMP92CH21FG	8K (Boot)	16K	82	Gray/Color	64seg. x 64com. to 320seg. x 320com. Gray: 960seg. x 480com.	<ul style="list-style-type: none"> <li>MMU (512MB)</li> <li>SDRAM controller</li> <li>NAND Flash interface</li> <li>Touch Screen interface</li> <li>USB1.1 interface</li> </ul>	2.7 to 3.6	
TMP92CA25FG	-	10K	92	W/B	64seg. x 64com. to 640seg. x 480com.	<ul style="list-style-type: none"> <li>MMU (512MB)</li> <li>SDRAM controller</li> <li>NAND Flash interface</li> <li>Touch Screen interface</li> <li>SPI interface</li> </ul>	2.7 to 3.6	
TMP92CZ26AXBG	8K (Boot)	288K	136	Gray/Color	64seg. x 64com. to 64K or more colors: 320seg. x 480com. 4K or fewer colors: 640seg. x 480com. Gray	<ul style="list-style-type: none"> <li>MMU (3.1GB)</li> <li>SDRAM controller</li> <li>MLC NAND Flash interface</li> <li>USB1.1 interface</li> <li>SPI interface</li> </ul>	1.4 to 1.6 3.0 to 3.6 (Two power supplies)	FBGA228 (15 x 15mm, 0.8-mm pitch)
TMP92CF29FG**	8K (Boot)	144K	92	Gray/Color	64seg. x 64com. to 64K or more colors: 320seg. x 480com. 4K or fewer colors: 640seg. x 480com. Gray	<ul style="list-style-type: none"> <li>MMU (2.1GB)</li> <li>SDRAM controller</li> <li>MLC NAND Flash interface</li> <li>USB1.1 interface</li> <li>SPI interface</li> </ul>	1.4 to 1.6 3.0 to 3.6 (Two power supplies)	LQFP176 (20 x 20mm)

\* For details of the products listed above, see the "Part Number List".

\*\* : Under development



# Microcontrollers Listed by Function / Application

## Microcontrollers with LCD driver

The following microcontrollers contain LCD driver circuitry. Some products also incorporate a voltage booster, enabling stable LCD display even at low operating voltages and realizing low power consumption.

### 8-/16-bit microcontrollers with LCD driver

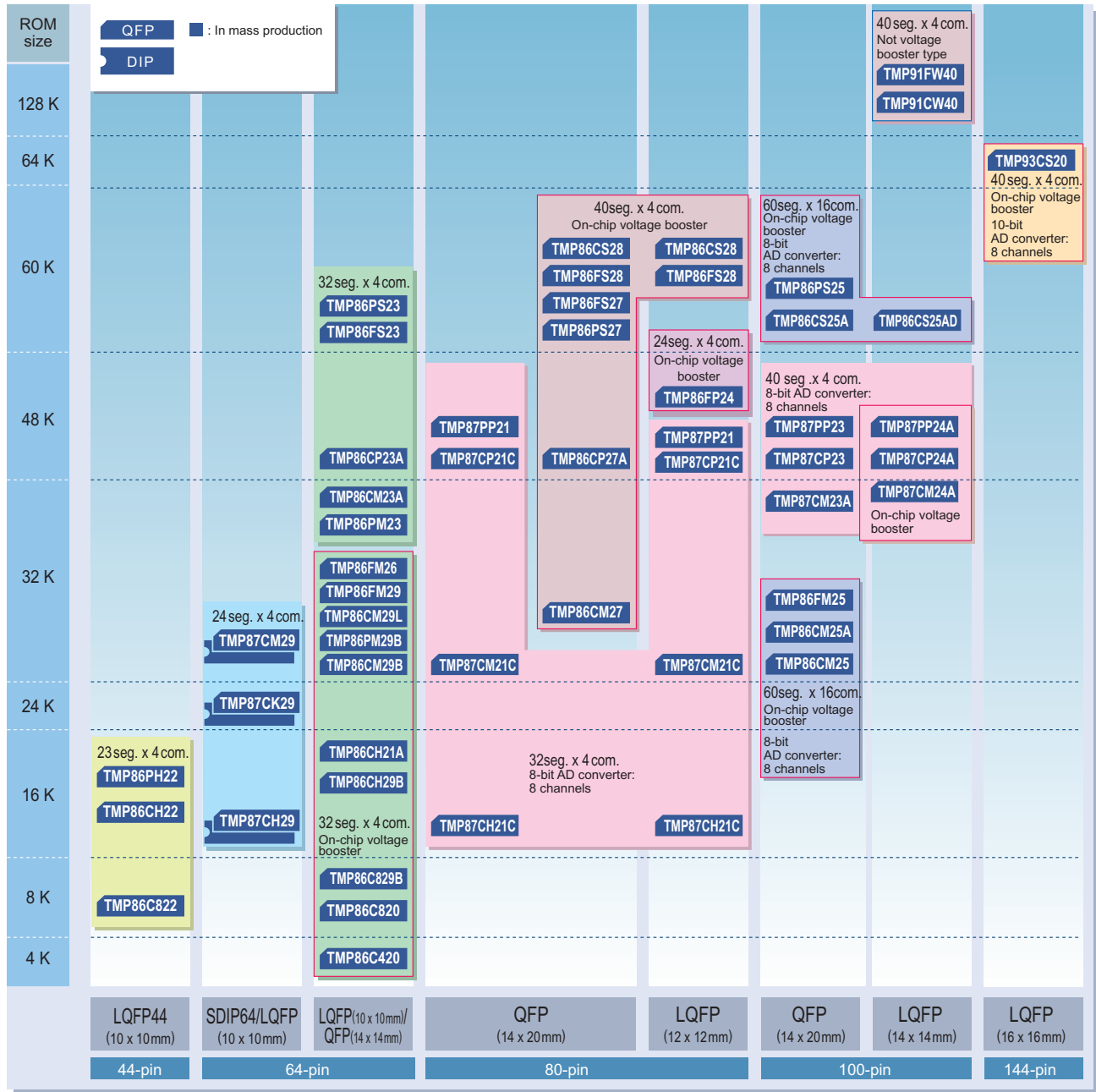

### 4-bit microcontrollers with LCD driver

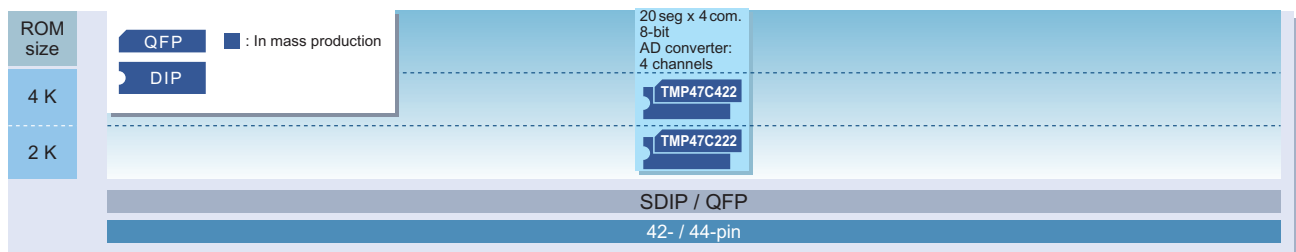



## 16-bit microcontrollers with LCD driver

Series Name	Part Number	ROM (bytes)	RAM (bytes)	I/O	LCD Driver	Additional Functions	Power Voltage (V)	Package
900/L	TMP93CS20FG	64K	2K	88	40 seg. x 4 com. (On-chip voltage booster)	<ul style="list-style-type: none"> <li>Serial interface: 3 channels</li> <li>10-bit AD converter: 8 channels</li> <li>16-bit timer/counter: 4 channels, 8-bit timer/counter: 4 channels</li> </ul>	5V ± 10% 3V ± 10%	LQFP144 (16 x 16 mm)
900/L1	TMP91CW40FG	128K	4K	61	40 seg. x 4 com. (Not voltage booster type)	<ul style="list-style-type: none"> <li>Serial interface: 4 channels</li> <li>10-bit AD converter: 12 channels</li> <li>16-bit timer/counter: 3 channels, 8-bit timer/counter: 4 channels</li> </ul>	2.7 to 3.6	LQFP100 (14 x 14 mm)
	TMP91FW40FG							

## 8-bit microcontrollers with LCD driver

Series Name	Part Number	ROM (bytes)	RAM (bytes)	I/O	LCD Driver	Additional Functions	Power Voltage (V)	Package		
870	TMP87CH21CFG/CDFG	16K	1K	52	32 seg. X 4 com.	<ul style="list-style-type: none"> <li>8-bit AD converter: 8 channels</li> <li>8-bit SIO: 2 channels</li> <li>16-bit timer/counter: 2 channels, 8-bit timer/counter: 2 channels</li> </ul>	2.7 to 5.5	QFP80 (14 X 20mm)/ LQFP80 (12 X 12mm)		
	TMP87CM21CFG/CDFG	32K								
	TMP87CP21CFG/CDFG	48K								
	TMP87CM23AFG	32K	1K	70	40 seg. X 4 com.		<ul style="list-style-type: none"> <li>8-bit AD converter: 5 channels</li> <li>8-bit UART: 1 channel</li> <li>18-bit timer/counter: 1 channel, 8-bit timer/counter: 4 channels</li> </ul>	2.2 to 5.5	LQFP100 (14 X 14mm)	
	TMP87CP23FG	48K								
	TMP87CM24AFG	32K								
	TMP87CP24AFG	48K	2K	69	40 seg. X 4 com. (On-chip voltage booster)			<ul style="list-style-type: none"> <li>8-bit AD converter: 8 channels</li> <li>8-bit SIO: 1 channel</li> <li>18-bit timer/counter: 1 channel, 8-bit timer/counter: 2 channels</li> </ul>	1.8 to 5.5	LQFP44 (10 X 10mm)
	TMP87CH29NG/UG	16K								
	TMP87CK29NG/UG	24K								
TMP87CM29NG/UG	32K	1K	43	24 seg. X 4 com.	<ul style="list-style-type: none"> <li>8-bit AD converter: 8 channels</li> <li>8-bit SIO: 1 channel</li> <li>18-bit timer/counter: 1 channel, 8-bit timer/counter: 2 channels</li> </ul>	1.8 to 5.5			LQFP64 (14 X 14mm)/ QFP64 (14 X 14mm)	
TMP86CH22UG	16K									
TMP86C822UG	8K									
TMP86C420UG/FG	4K	256	39	32 seg. X 4 com. (On-chip voltage booster)		<ul style="list-style-type: none"> <li>8-bit AD converter: 8 channels</li> <li>8-bit SIO: 1 channel</li> <li>18-bit timer/counter: 1 channel, 8-bit timer/counter: 2 channels</li> </ul>	1.8 to 5.5		LQFP64 (10 X 10mm)/ QFP64 (14 X 14mm)	
TMP86C820UG/FG	8K									
TMP86CH21FG	16K									
TMP86CH21AUG	16K	512	51	23 seg. X 4 com.			<ul style="list-style-type: none"> <li>8-bit AD converter: 8 channels</li> <li>8-bit SIO: 1 channel</li> <li>18-bit timer/counter: 1 channel, 8-bit timer/counter: 2 channels</li> </ul>	1.8 to 3.6	LQFP64 (10 X 10mm)	
TMP86FM26UG	32K									
TMP86C829BUG/BFG	8K									
TMP86CH29BUG/BFG	16K	512	51	32 seg. X 4 com. (On-chip voltage booster)	<ul style="list-style-type: none"> <li>8-bit AD converter: 8 channels</li> <li>8-bit SIO: 1 channel</li> <li>18-bit timer/counter: 1 channel, 8-bit timer/counter: 2 channels</li> </ul>			1.8 to 5.5	LQFP64 (10 X 10mm)/ QFP64 (14 X 14mm)	
TMP86CM29BUG/BFG	16K									
TMP86CM29LUG	32K									
TMP86FM29UG/FG	32K	1.5K	39	32 seg. X 4 com. (On-chip voltage booster)		<ul style="list-style-type: none"> <li>10-bit AD converter: 8 channels</li> <li>8-bit SIO/UART: 1 channel</li> <li>18-bit timer/counter: 1 channel, 8-bit timer/counter: 4 channels</li> </ul>		1.8 to 3.6	LQFP64 (10 X 10mm)/ QFP64 (14 X 14mm)	
TMP86CM23AUG	1.5K									
TMP86CP23AUG	48K									
TMP86FS23UG	60K	2K	48	32 seg. X 4 com.			<ul style="list-style-type: none"> <li>10-bit AD converter: 8 channels</li> <li>8-bit SIO: 1 channel, 8-bit UART: 1 channel</li> <li>18-bit timer/counter: 1 channel, 8-bit timer/counter: 4 channels</li> <li>Multiply-accumulate calculator (MAC)</li> </ul>	2.7 to 5.5	LQFP64 (10 X 10mm)	
TMP86FP24FG	48K									
TMP86CM27FG	32K									
TMP86CP27AFG	48K	1K	55	40 seg. X 4 com. (On-chip voltage booster)	<ul style="list-style-type: none"> <li>10-bit AD converter: 8 channels</li> <li>8-bit SIO: 1 channel, 8-bit SIO/UART: 1 channel</li> <li>16-bit timer/counter: 2 channels, 8-bit timer/counter: 2 channels</li> <li>Program patch logic</li> </ul>			1.8 to 3.6	LQFP80 (12 X 12mm)	
TMP86FS27FG	60K									
TMP86CM25FG	32K									
TMP86CM25AFG	32K	42	42	60 seg. X 16 com. (On-chip voltage booster)		<ul style="list-style-type: none"> <li>8-bit AD converter: 8 channels</li> <li>8-bit SIO/UART: 1 channel, 8-bit SIO: 1 channel</li> <li>18-bit timer/counter: 1 channel, 8-bit timer/counter: 4 channels</li> </ul>		1.8 to 5.5	QFP100 (14 X 20mm)	
TMP86CS25AFG	60K									
TMP86CS25ADFG	60K									
TMP86CS28FG/DFG	60K	2K	62	40 seg. X 4 com. (On-chip voltage booster)			<ul style="list-style-type: none"> <li>10-bit AD converter: 8 channels</li> <li>8-bit SIO/UART: 1 channel, 8-bit UART: 1 channel</li> <li>16-bit timer/counter: 2 channels, 8-bit timer/counter: 4 channels</li> </ul>	2.7 to 5.5	QFP80 (14 X 20mm)/ LQFP80 (12 X 12mm)	
TMP86FS28FG/DFG	60K									
TMP86FS28FG/DFG	60K									

◇: Guaranteed over the ambient temperature (T<sub>opr</sub>) range of -20°C to 85°C at 1.8 V to 2.0 V.

△: Guaranteed over the ambient temperature (T<sub>opr</sub>) range of -20°C to 85°C at 2.7 V to 3.0 V.

## 4-bit microcontrollers with LCD driver

Series Name	Part Number	ROM (bytes)	RAM (bytes)	I/O	LCD Driver	Additional Functions	Power Voltage (V)	Package
47E	TMP47C222N/F/U	2K	192	22	20 seg. x 4 com.	<ul style="list-style-type: none"> <li>8-bit AD converter: 4 channels</li> <li>8-bit SIO: 1 channel</li> <li>Pulse output: remote control transmission carrier</li> </ul>	2.5 to 5.5	SDIP42/ QFP44 (14 x 14 mm)/
	TMP47C422N/F/U	4K	256					QFP44 (10 x 10 mm)

\* For details of the products listed above, see the "Part Number List".

\* Some of the flash memories use the SuperFlash<sup>®</sup> technology under the license of Silicon Storage Technology, Inc. SuperFlash<sup>®</sup> is a registered trademark of Silicon Storage Technology, Inc.



# Microcontrollers Listed by Function / Application

Applications



## Microcontrollers with fluorescent display tube driver

The following microcontrollers incorporate high breakdown voltage output for directly driving a fluorescent display tube and a display circuit for automatically transferring display data to a port. In addition to existing products, such as a VFT driver circuit which can display digits on a segmented display, Toshiba offers a line-up of products which support automatic display on universal-grid display tubes.

### 8-/16-bit microcontrollers with fluorescent display tube driver

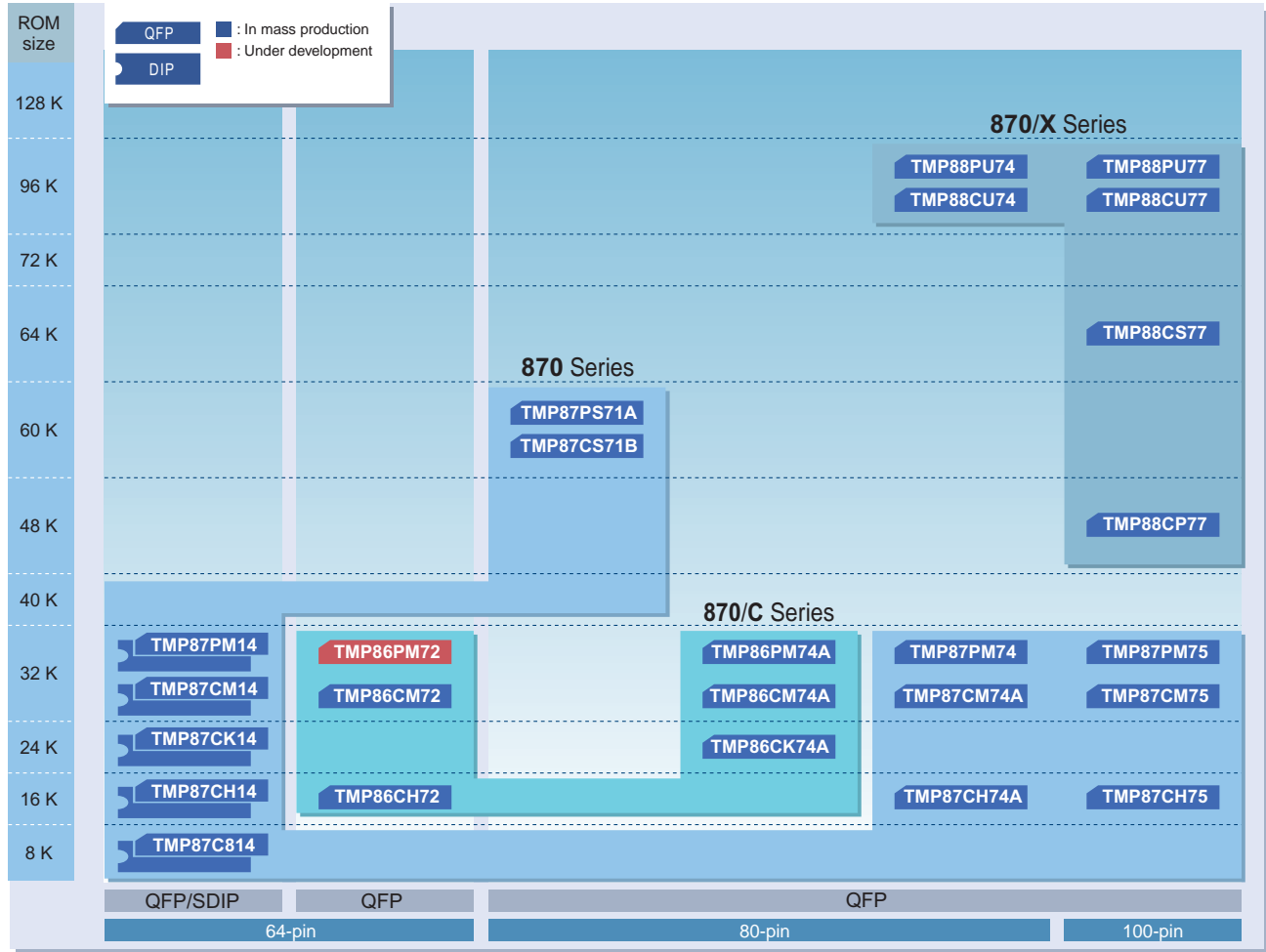

### 8-bit microcontrollers with fluorescent display tube driver

Series Name	Part Number	ROM (bytes)	RAM (bytes)	I/O	VFT Driver(Fluorescent Tube Driver)	Additional Functions	Package
870	TMP87C814NG/FG	8 K	512	55	Maximum breakdown voltage: 40 V on each of 24 pins	<ul style="list-style-type: none"> <li>8-bit AD converter: 8 channels</li> <li>8-bit SIO: 1 channel</li> <li>16-bit timer/counter: 2 channels,</li> <li>8-bit timer/counter: 2 channels</li> </ul>	SDIP64/ QFP64 (14 x 20mm)
	TMP87CH14NG/FG	16 K	1 K				
	TMP87CK14NG/FG	24 K	1 K				
	TMP87CM14NG/FG	32 K	1 K				
	TMP87CS71BFG	60 K	2 K	73	16 seg. x 16 dig.	<ul style="list-style-type: none"> <li>AD converter input: 6 channels</li> <li>8-bit SIO: 1 channel</li> <li>High-speed serial output</li> </ul>	QFP80 (14 x 20mm)
	TMP87CH74AFG	16 K	512	71	Maximum breakdown voltage: 40 V on each of 37 pins Programmable grid scan output	<ul style="list-style-type: none"> <li>8-bit AD converter: 12 channels</li> <li>8-bit SIO: 2 channels</li> <li>16-bit timer/counter: 2 channels,</li> <li>8-bit timer/counter: 2 channels</li> </ul>	QFP100 (14 x 20mm)
	TMP87CM74AFG	32 K	1 K	89	Maximum breakdown voltage: 40 V on each of 51 pins Programmable grid scan output	<ul style="list-style-type: none"> <li>8-bit AD converter: 12 channels</li> <li>8-bit SIO: 2 channels</li> <li>16-bit timer/counter: 2 channels,</li> <li>8-bit timer/counter: 2 channels</li> </ul>	QFP100 (14 x 20mm)
TMP87CH75FG	16 K	512					
TMP87CM75FG	32 K	1 K					
870/C	TMP86CK74AFG	24 K	1 K	70	Maximum breakdown voltage: 41 V on each of 37 pins Programmable grid scan output	<ul style="list-style-type: none"> <li>8-bit AD converter: 8 channels</li> <li>8-bit SIO: 1 channel</li> <li>16-bit timer/counter: 2 channels,</li> <li>8-bit timer/counter: 2 channels</li> </ul>	QFP80 (14 x 20mm)
	TMP86CM74AFG	32 K	2 K	54	Maximum breakdown voltage: 41 V on each of 32 pins Programmable grid scan output	<ul style="list-style-type: none"> <li>8-bit AD converter: 6 channels</li> <li>8-bit SIO: 1 channel</li> <li>16-bit timer/counter: 1 channel,</li> <li>8-bit timer/counter: 2 channels</li> <li>IFC bus: 1 channel</li> </ul>	QFP64 (14 x 14mm)
	TMP86CH72FG	16 K	1 K				
	TMP86CM72FG	32 K	1 K				
870/X	TMP88CU74FG	96 K	2 K	71	Maximum breakdown voltage: 40 V on each of 37 pins Programmable grid scan output	<ul style="list-style-type: none"> <li>8-bit SIO: 1 channel</li> <li>16-bit timer/counter: 2 channels,</li> <li>8-bit timer/counter: 2 channels</li> </ul>	QFP80 (14 x 20mm)
	TMP88CP77FG	48 K	1 K	88	Maximum breakdown voltage: 40 V on each of 53 pins Programmable grid scan output	<ul style="list-style-type: none"> <li>8-bit AD converter: 12 channels</li> <li>8-bit SIO: 2 channels</li> <li>16-bit timer/counter: 3 channels,</li> <li>8-bit timer/counter: 1 channel</li> </ul>	QFP100 (14 x 20mm)
	TMP88CS77FG	64 K	2 K				
	TMP88CU77FG	96 K	3 K				

\* For details of the products listed above, see the "Part Number List".



## General-purpose microcontrollers in compact packages

This comprehensive product line comes in compact packages, including SOPs, SSOPs and 7 mm x 7 mm 48-pin flat packages.

### General-purpose microcontrollers in compact packages

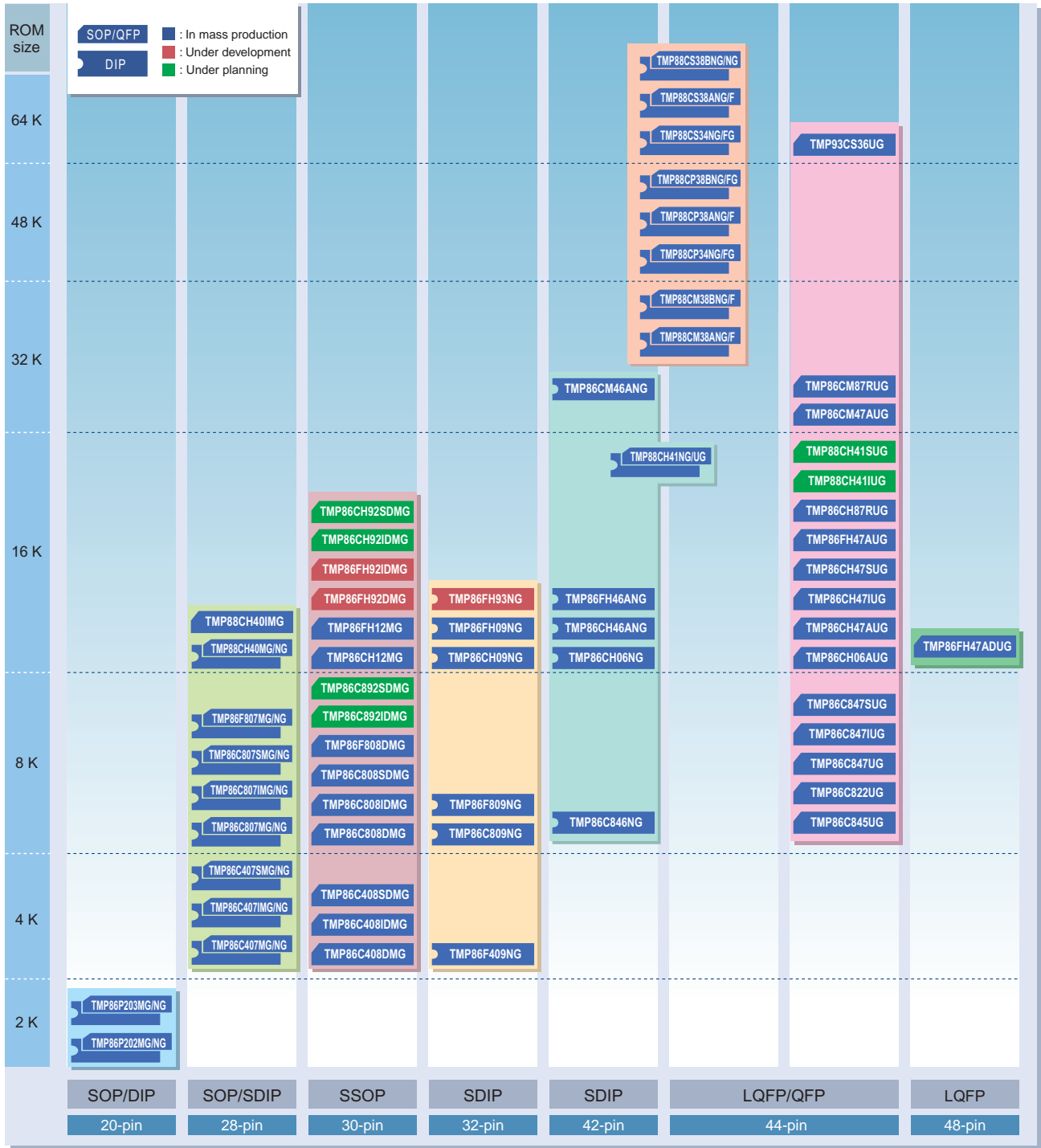



# Microcontrollers Listed by Function / Application

## 8-bit microcontrollers (TLCS-870/C Series)

Series Name	Part Number	Flash	ROM (bytes)	RAM (bytes)	I/O	Compact Package	Additional Functions	Supply Voltage (V)	Version with OTP/Flash
870/C	TMP86P202MG					SOP20	<ul style="list-style-type: none"> <li>8-bit AD converter: 4 channels</li> <li>8-bit timer/counter: 2 channels</li> </ul>	3.3 to 5.5	—
	TMP86P202PG		2 K	128	14	DIP20			
	TMP86P203MG					SOP20			
	TMP86P203PG					DIP20			
	TMP86CH06NG					SDIP42	<ul style="list-style-type: none"> <li>8-bit SIO/UART (switchable): 1 channel</li> <li>UART: 1 channel</li> <li>16-bit timer/counter: 1 channel, 8-bit timer/counter: 2 channels</li> </ul>	1.8 to 5.5	TMP86PH06NG
	TMP86CH06AUG ◇		16 K	512	35	LQFP44 (10 x 10mm)			TMP86PH06UG
	TMP86C407MG					SOP28	<ul style="list-style-type: none"> <li>SEI</li> <li>UART: 1 channel</li> <li>8-bit AD converter: 6 channels</li> <li>16-bit timer/counter: 1 channel, 8-bit timer/counter: 2 channels</li> </ul>	2.7 to 5.5	TMP86P807MG TMP86F807MG
	TMP86C407NG					SDIP28			TMP86P807NG TMP86F807NG
	TMP86C407IMG		4 K			SOP28			TMP86P807MG
	TMP86C407ING					SDIP28			TMP86P807NG
	TMP86C407SMG ☆					SOP28			TMP86P807MG
	TMP86C407SNG ☆					SDIP28			TMP86P807NG
	TMP86C807MG					SOP28			TMP86P807MG TMP86F807MG
	TMP86C807NG					SDIP28			TMP86P807NG TMP86F807NG
	TMP86C807IMG			8 K	256	SOP28			TMP86P807MG
	TMP86C807ING					SDIP28			TMP86P807NG
	TMP86C807SMG ☆					SOP28			TMP86P807MG
	TMP86C807SNG ☆					SDIP28			TMP86P807NG
	TMP86F807MG	●				SOP28	—		
	TMP86F807NG	●				SDIP28	—		
	TMP86C408DMG					SSOP30	<ul style="list-style-type: none"> <li>SEI</li> <li>UART: 1 channel</li> <li>8-bit AD converter: 6 channels</li> <li>16-bit timer/counter: 1 channel, 8-bit timer/counter: 2 channels</li> </ul>	2.7 to 5.5	TMP86P808DMG TMP86F808DMG
	TMP86C408IDMG		4 K						TMP86P808DMG
	TMP86C408SDMG ☆								TMP86P808DMG TMP86F808DMG
	TMP86C808DMG								TMP86P808DMG
	TMP86C808IDMG			8 K		SSOP30	<ul style="list-style-type: none"> <li>SEI</li> <li>UART: 1 channel</li> <li>10-bit AD converter: 6 channels</li> <li>16-bit timer/counter: 1 channel, 8-bit timer/counter: 2 channels</li> </ul>	2.7 to 5.5	—
	TMP86C808SDMG ☆								—
	TMP86F808DMG	●							TMP86FH09NG △ TMP86F809NG △
	TMP86F409NG △	●	4 K						—
	TMP86C809NG					SDIP32	<ul style="list-style-type: none"> <li>SEI</li> <li>UART: 1 channel</li> <li>10-bit AD converter: 6 channels</li> <li>16-bit timer/counter: 1 channel, 8-bit timer/counter: 2 channels</li> </ul>	2.7 to 5.5	TMP86FH09NG △ TMP86F809NG △
	TMP86F809NG △	●	8 K						—
	TMP86CH09NG								TMP86FH09NG △
	TMP86FH09NG △	●							—
	TMP86CH12MG					SSOP30	<ul style="list-style-type: none"> <li>8-bit SIO: 1 channel</li> <li>UART: 1 channel</li> <li>10-bit AD converter: 8 channels</li> <li>16-bit timer/counter: 1 channel, 10-bit timer/counter: 1 channel, 8-bit timer/counter: 2 channels</li> </ul>	2.7 to 5.5	TMP86FH12MG △
	TMP86FH12MG △	●	16 K	512	24				—
	TMP86C822UG ◇					LQFP44 (10 x 10mm)	<ul style="list-style-type: none"> <li>LCD</li> <li>8-bit SIO: 1 channel</li> <li>UART: 1 channel</li> <li>10-bit AD converter: 4 channels</li> <li>18-bit timer/counter: 1 channel, 8-bit timer/counter: 2 channels</li> </ul>	1.8 to 5.5	TMP86PH22UG ◇
	TMP86CH22UG ◇		16 K		33				—
	TMP86C845UG			8 K	256	35	LQFP44 (10 x 10mm)	2.7 to 5.5	TMP86PM47AUG TMP86PH47UG TMP86FH47AUG △
	TMP86C846NG								—
	TMP86CH46ANG ◇			16 K	512	33	SDIP42	1.8 to 5.5	TMP86PH46NG ◇ TMP86PM46NG TMP86FH46ANG △
	TMP86FH46ANG △	●				—			
TMP86CM46ANG		32 K	1 K			LQFP44 (10 x 10mm)	1.8 to 5.5	TMP86PM46NG	
TMP86C847UG								—	
TMP86C847IUG			8 K			LQFP44 (10 x 10mm)	2.7 to 5.5	TMP86PM47AUG TMP86PH47UG ◇ TMP86FH47AUG △	
TMP86C847SUG ☆				512	35			—	
TMP86CH47AUG ◇			16 K			LQFP44 (10 x 10mm)	1.8 to 5.5	TMP86PM47AUG TMP86PH47UG ◇ TMP86FH47AUG △ TMP86FH47ADUG △	
								—	

◇: Guaranteed over the ambient temperature (T<sub>opr</sub>) range of -20°C to 85°C at 1.8 V to 2.0 V.  
 △: Guaranteed over the ambient temperature (T<sub>opr</sub>) range of -20°C to 85°C at 2.7 V to 3.0 V.  
 ☆: Guaranteed over the ambient temperature (T<sub>opr</sub>) range of -40°C to 125°C.



## 8-bit microcontrollers (TLCS-870/C Series, TLCS-870/X Series)

Series Name	Part Number	Flash	ROM (bytes)	RAM (bytes)	I/O	Compact Package	Additional Functions	Supply Voltage (V)	Version with OTP/Flash	
870/C	TMP86CH47IUG		16 K	512	35	LQFP44 (10 x 10mm)	<ul style="list-style-type: none"> <li>8-bit SIO: 1 channel</li> <li>UART: 1 channel</li> <li>10-bit AD converter: 8 channels</li> <li>16-bit timer/counter: 1 channel, 8-bit timer/counter: 2 channels</li> </ul>	2.7 to 5.5	TMP86PM47AUG TMP86PH47UG TMP86FH47AUG	
	TMP86CH47SUG ☆								—	
	TMP86FH47AUG △	●				LQFP48 (7 x 7mm)		1.8 to 5.5	TMP86PM47AUG	
	TMP86FH47ADUG △	●								
	TMP86CM47AUG		32 K	1 K		LQFP44 (10 x 10mm)	<ul style="list-style-type: none"> <li>CAN</li> <li>SEI</li> <li>UART: 1 channel</li> <li>10-bit AD converter: 14 channels</li> <li>16-bit timer/counter: 1 channel, 8-bit timer/counter: 2 channels</li> </ul>	4.5 to 5.5	TMP86PM87RUG	
	TMP86CH87RUG		16 K							
	TMP86CM87RUG		32 K							
	TMP86C892IDMG++		8 K	512	24	SSOP30	<ul style="list-style-type: none"> <li>SEI</li> <li>UART: 1 channel</li> <li>I<sup>2</sup>C/UART (switchable)</li> <li>10-bit AD converter: 6 channels</li> <li>16-bit timer/counter: 1 channel, 8-bit timer/counter: 2 channels</li> </ul>	2.7 to 5.5	TMP86FH92IDMG**	
	TMP86C892SDMG++☆									
	TMP86CH92IDMG++		16 K						3.0 to 5.5	—
	TMP86CH92SDMG++☆									
	TMP86FH92IDMG**	●								
	TMP86FH92IDMG**	●								
TMP86FH93NG**	●				26	SDIP32		2.7 to 5.5		
870/X	TMP88CP34FG		48 K			QFP44 (14 x 14mm)	<ul style="list-style-type: none"> <li>I<sup>2</sup>C: 1 channel</li> <li>PWM: 4 channels</li> <li>8-bit AD converter: 6 channels</li> <li>16-bit timer/counter: 2 channels, 8-bit timer/counter: 2 channels</li> <li>Remote control detection</li> <li>Program patch logic</li> </ul>		TMP88PS34FG	
	TMP88CP34NG					SDIP42				TMP88PS34NG
	TMP88CS34FG		64 K			QFP44 (14 x 14mm)			TMP88PS34FG	
	TMP88CS34NG					SDIP42				TMP88PS34NG
	TMP88CM38AF		32 K	1.5 K		QFP44 (14 x 14mm)			TMP88PS38FG	
	TMP88CM38ANG					SDIP42				TMP88PS38NG
	TMP88CM38BFG					QFP44 (14 x 14mm)			TMP88PS38BFG	
	TMP88CM38BNG					SDIP42			TMP88PS38BNG	
	TMP88CP38AF		48 K			QFP44 (14 x 14mm)	<ul style="list-style-type: none"> <li>I<sup>2</sup>C: 1 channels</li> <li>PWM: 10 channels</li> <li>8-bit AD converter: 6 channels</li> <li>16-bit timer/counter: 2 channels, 8-bit timer/counter: 2 channels</li> <li>Remote control detection</li> <li>Program patch logic</li> </ul>		TMP88PS38FG	
	TMP88CP38ANG					SDIP42				TMP88PS38NG
	TMP88CP38BFG					QFP44 (14 x 14mm)			TMP88PS38BFG	
	TMP88CP38BNG					SDIP42			TMP88PS38BNG	
	TMP88CS38FG		64 K	2 K		QFP44 (14 x 14mm)			TMP88PS38FG	
	TMP88CS38NG					SDIP42				TMP88PS38NG
	TMP88CS38BFG					QFP44 (14 x 14mm)			TMP88PS38BFG	
	TMP88CS38BNG					SDIP42			TMP88PS38BNG	
	TMP88CH40MG					SOP28	<ul style="list-style-type: none"> <li>8-bit SIO: 1 channel</li> <li>UART: 1 channel</li> <li>10-bit AD converter: 4 channels</li> <li>16-bit timer/counter: 1 channel, 8-bit timer/counter: 2 channels</li> <li>Motor control</li> </ul>		TMP88PH40MG	
	TMP88CH40NG					SDIP28				TMP88PH40NG
	TMP88CH40IMG		16 K	512	19	SOP28			TMP88PH40MG	
	TMP88CH41UG									
TMP88CH41NG					LQFP44 (10 x 10mm)	<ul style="list-style-type: none"> <li>8-bit SIO: 1 channel</li> <li>UART: 1 channel</li> <li>10-bit AD converter: 8 channels</li> <li>16-bit timer/counter: 2 channels, 8-bit timer/counter: 2 channels</li> <li>Motor control</li> </ul>		TMP88PH41UG		
TMP88CH41IUG++					SDIP42			TMP88PH41NG		
TMP88CH41SUG++					LQFP44 (10 x 10mm)			TMP88PH41UG		

◇: Guaranteed over the ambient temperature (T<sub>opr</sub>) range of -20°C to 85°C at 1.8 V to 2.0 V.  
 △: Guaranteed over the ambient temperature (T<sub>opr</sub>) range of -20°C to 85°C at 2.7 V to 3.0 V.  
 ☆: Guaranteed over the ambient temperature (T<sub>opr</sub>) range of -40°C to 125°C.

\*\* : Under development  
 ++ : Under planning

## 16-bit microcontrollers (TLCS-900/L Series)

Series Name	Part Number	ROM (bytes)	RAM (bytes)	I/O	Compact Package	Additional Functions	Supply Voltage (V)	Version with OTP/Flash
900/L	TMP93CS36UG	64 K	2 K	33	LQFP44 (10 x 10mm)	<ul style="list-style-type: none"> <li>SIO/UART: 2 channels</li> <li>10-bit AD converter: 4 channels</li> <li>16-bit timer/counter: 2 channels, 8-bit timer/counter: 4 channels</li> <li>Clock gear</li> </ul>	5V ± 10%	—



# Microcontrollers Listed by Function / Application

## Microcontrollers with AD converters

### 8-bit microcontrollers with AD converters

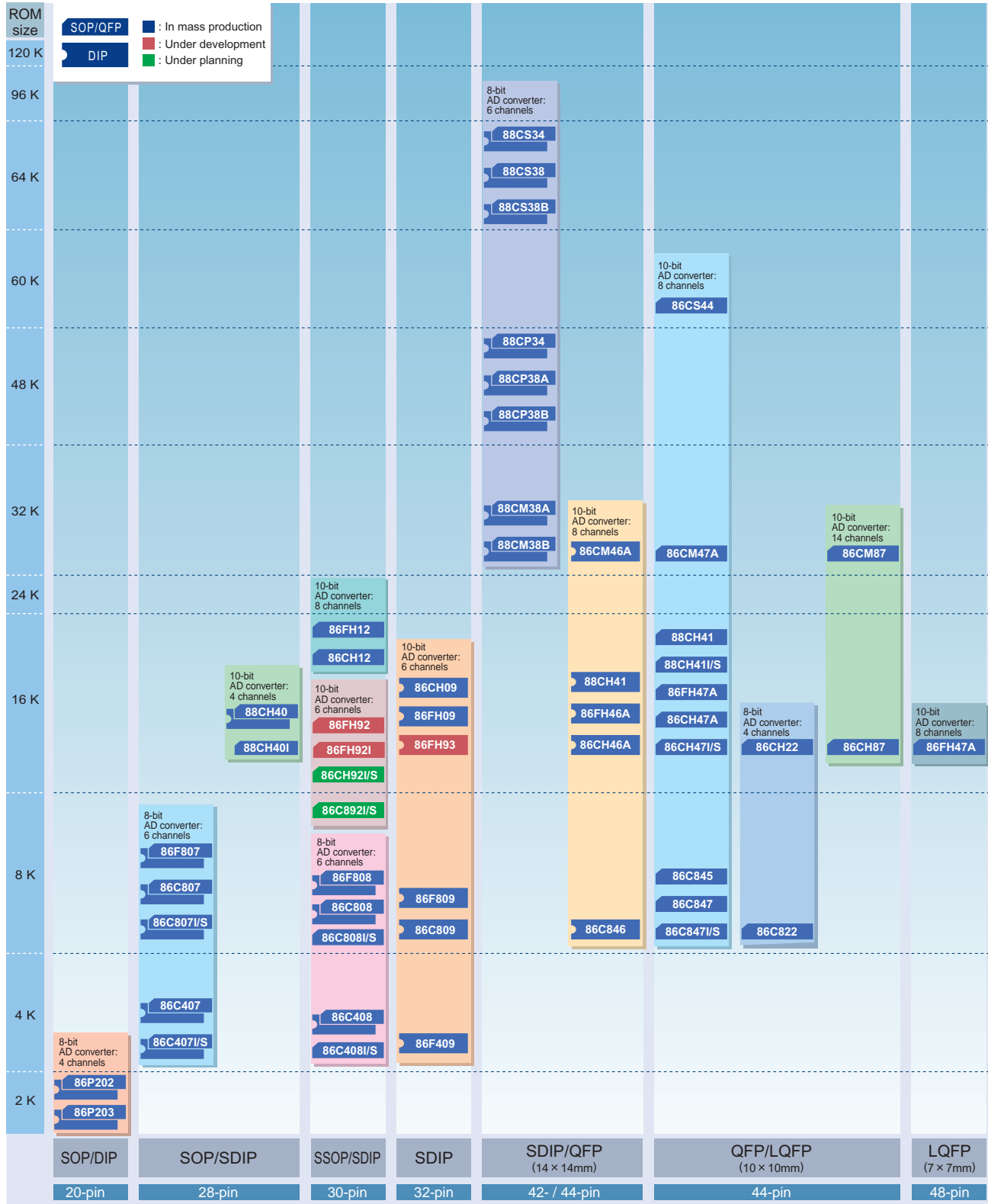

\* For details of the products listed above, see the "Part Number List".

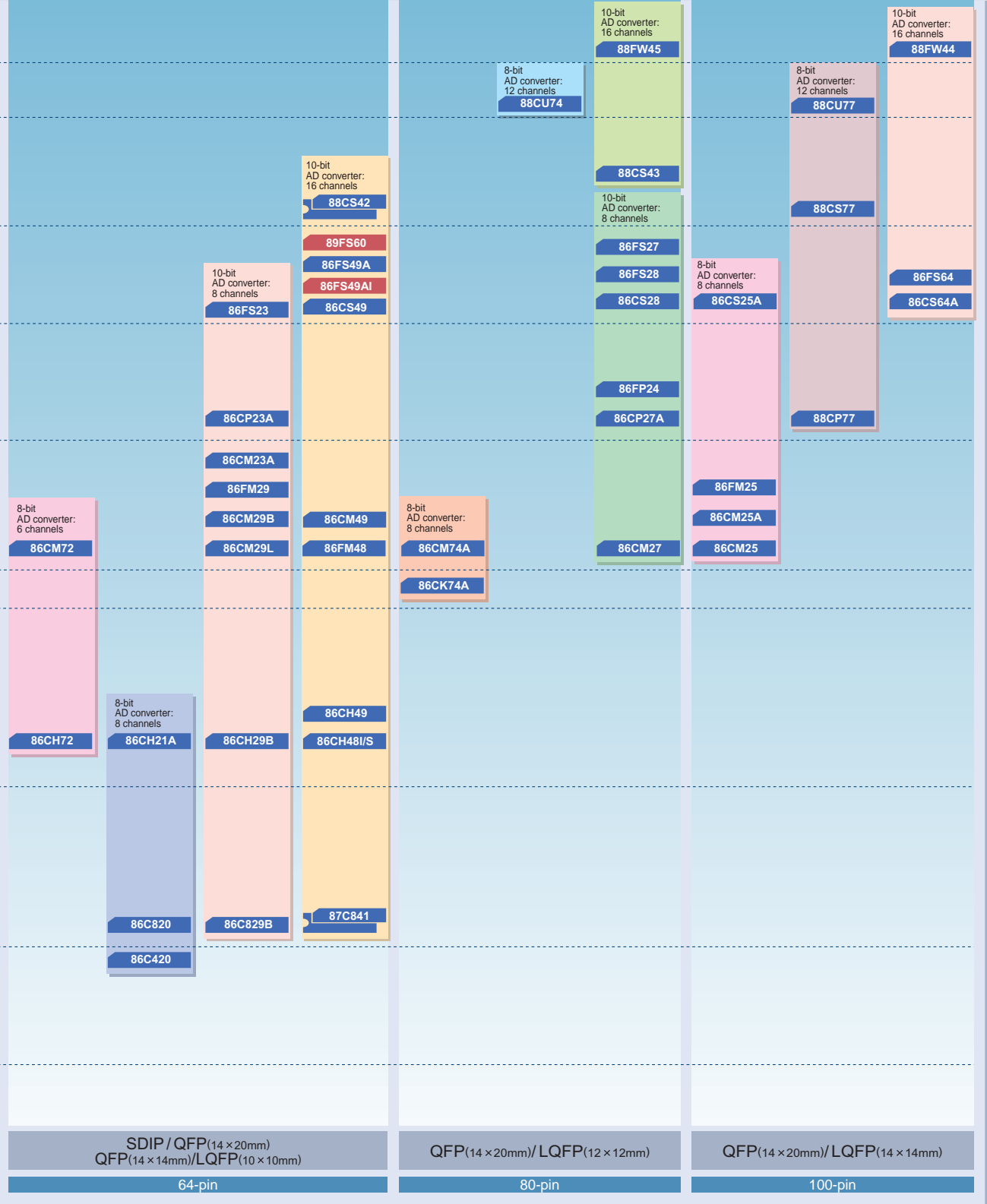

\* Some of the flash memories use the SuperFlash® technology under the license of Silicon Storage Technology, Inc. SuperFlash® is a registered trademark of Silicon Storage Technology, Inc.

# Microcontrollers Listed by Function / Application

## 16-/32-bit microcontrollers with AD converters

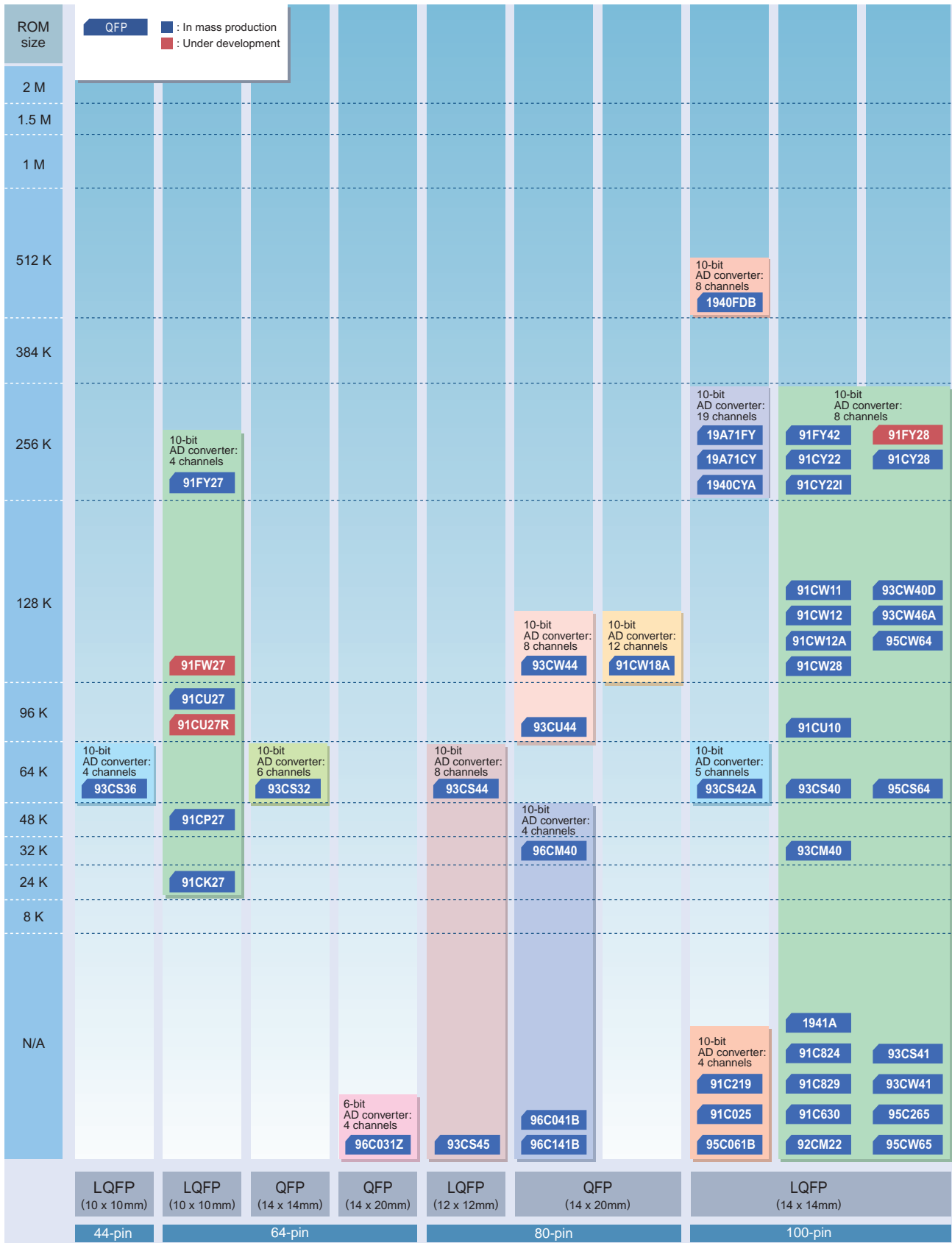

\* For details of the products listed above, see the "Part Number List".





										10-bit AD converter: 24 channels <b>19A64F20B</b> <b>19A64C1D</b> <b>1962F10A</b> <b>1962C10B</b>
	10-bit AD converter: 12 channels <b>92FD54AI</b> <b>92CD54I</b> <b>92FD23A</b> <b>92CD23A</b>	10-bit AD converter: 12 channels <b>92FD23A</b> <b>92CD23A</b>		10-bit AD converter: 16 channels <b>1942FD</b>  <b>1942CZ</b>  <b>1942CY</b>				10-bit AD converter: 16 channels <b>19A43FD</b> <b>19A43CD</b>  <b>19A43FZ</b> <b>19A43CZ</b>		
	10-bit AD converter: 16 channels <b>91FW60</b> <b>91CW60</b>	10-bit AD converter: 16 channels <b>91FW60</b> <b>91CW60</b>								
	10-bit AD converter: 4 channels <b>91FW40</b> <b>91CW40</b>									
	10-bit AD converter: 12 channels <b>91CP82T</b>		10-bit AD converter: 8 channels <b>93CS20</b>  <b>91C820A</b>							
			10-bit AD converter: 12 channels <b>92CM27</b>  10-bit AD converter: 4 channels <b>92CA25</b> <b>92CH21</b>	10-bit AD converter: 8 channels <b>94C251A</b> <b>95C063</b>	10-bit AD converter: 8 channels <b>94C241C</b>	10-bit AD converter: 6 channels <b>92CF29</b>		10-bit AD converter: 6 channels <b>92CF26A</b> <b>92CZ26A</b>		
		10-bit AD converter: 8 channels <b>91C815</b>	10-bit AD converter: 5 channels <b>92C820</b>							
LQFP (14 x 14mm)	QFP (14 x 20mm)	TQFP (14 x 14mm)	LQFP (16 x 16mm)	LQFP (20 x 20mm)	QFP (28 x 28mm)	LQFP (20 x 20mm)	FBGA (12 x 12mm)	FBGA (15 x 15mm)	FBGA (13 x 13mm)	
100-pin		128-pin	144-pin		160-pin	176-pin	193-pin	228-pin	281-pin	

\* Some of the flash memories use the SuperFlash® technology under the license of Silicon Storage Technology, Inc. SuperFlash® is a registered trademark of Silicon Storage Technology, Inc.



## Microcontrollers for personal equipment

With built-in devices such as LCD driver controllers, Memory Management Units and RTC, these microcontrollers are ideal for personal equipment. We also offer products with a built-in touch panel I/F, AD converter and power supply detection circuit; and products with a built-in SDRAM controller and NAND-type flash memory I/F featuring outstanding bit unit cost.

### Main functions

- LCD driver controller (monochrome to 16M colors)
- SDRAM controller
- Large-capacity memory access MMU
- 10-bit AD converter
- Shift to high-performance 32-bit 900/H1 core

### System block diagram

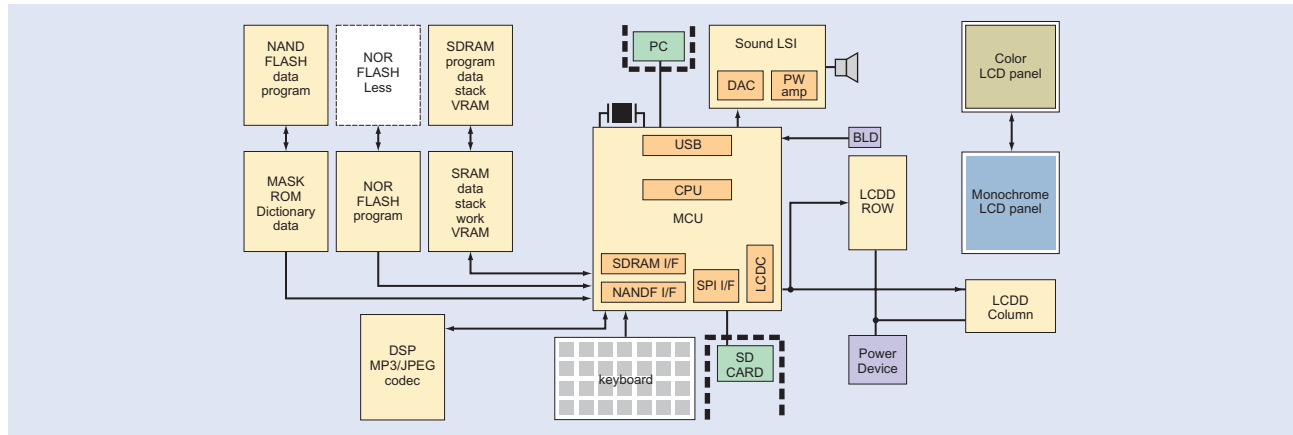

### Product outline

#### LCD display

- TFT (16M colors)/STN color (262K colors)  
TMP92CZ26A  
TMP92CF29\*\*
- TFT/STN color (4096 colors)  
TMP92CH21
- Monochrome  
16 gray levels  
TMP92C820  
TMP91C820A, etc.
- Monochrome  
TMP92CA25  
TMP91C815  
TMP91C016  
TMP91C025, etc.

#### PC interface

- USB circuit  
TMP92CZ26A  
TMP92CF29\*\*  
TMP92CH21
- UART  
TMP91C815, etc.  
All products

#### Clock with calendar

- RTC circuit  
TMP91C815, etc.  
All products

#### Keyboard matrix & Key-on wake-up

TMP91C815, etc. All products

#### Touch panel interface

- AD circuit  
TMP92CZ26A  
TMP92CF29\*\*  
TMP92CA25  
TMP92CH21  
TMP91C025

#### Memory access with low bit unit cost

- SPI interface  
TMP92CZ26A  
TMP92CF29\*\*  
TMP92CA25
- NANDF interface  
TMP92CZ26A  
TMP92CA25  
TMP92CH21
- SDRAM controller  
TMP92CZ26A  
TMP92CF29\*\*  
TMP92CA25  
TMP92CH21  
TMP92C820  
TMP91C820A

\*\* : Under development

### Product line-up for personal equipment

Part Number	TMP91C824FG	TMP91C016FG	TMP91C025FG	TMP91C815FG	TMP91C820AFG	TMP92C820FG	TMP92CH21FG	TMP92CA25FG	TMP92CZ26AXBG	TMP92CF29FG**
LCD-CTRL	-	W/B	W/B	W/B	16Gray	16Gray	Gray/Color	W/B	Gray/Color	Gray/Color
10-bit ADC	8ch	-	4ch	8ch	8ch	5ch	4ch	4ch	6ch	6ch
ROM (bytes)	-	-	-	-	8K	-	8K(Boot)	-	8K(Boot)	8K(Boot)
RAM (bytes)	8K	-	-	8K	8K	8K	16K	10K	288K	144K
DRAM-CTRL	-	EDO	-	-	SDRAM	SDRAM	SDRAM Program execute	SDRAM Program execute	SDRAM Program execute	SDRAM Program execute
UART/SIO	1ch	1ch	1ch	1ch	2ch	3ch	2ch	1ch	1ch	2ch
SIO/IrDA1.0	1ch	1ch	1ch	1ch	1ch	1ch	1ch	1ch	-	-
SBI/I <sup>2</sup> C BUS	1ch	-	-	1ch	1ch	1ch	-	1ch	1ch	1ch
SPI	-	-	-	-	-	-	-	1ch	1ch	1ch
MMU	106MBmax	105MBmax	72MBmax	136MBmax	136MBmax	136MBmax	512MBmax	512MBmax	3.1GBmax	2.1GBmax
Min Instruction CLK(internal)	121ns 16.5MHz/2.7V	148ns 13.5MHz/2.7V	112ns 18MHz/3.0V	148ns 13.5MHz/2.7V	112ns 18MHz/3.0V	50ns 20MHz/3.0V	50ns 20MHz/3.0V	50ns 20MHz/3.0V	12.5ns 80MHz/3.0V,1.4V (Two power supplies)	12.5ns 80MHz/3.0V,1.4V (Two power supplies)
8-bit timer	4ch	4ch	4ch	4ch	4ch	4ch	4ch	4ch	8ch	8ch
16-bit timer	-	-	-	-	1ch	1ch	1ch	1ch	2ch	2ch
USB-CTRL	-	-	-	-	-	-	USB Device	-	USB Device	USB Device
NANDF-I/F	-	-	-	-	-	-	2ch	2ch	2ch(MLC/SLC)	2ch(MLC/SLC)
DMA-CTRL	-	-	-	-	-	-	-	-	6ch	6ch
MAC	-	-	-	-	-	-	-	-	1ch	1ch
Package	LQFP100	LQFP100	LQFP100	TQFP128	LQFP144	LQFP144	LQFP144	LQFP144	FBGA228	LQFP176

\* For details of the products listed above, see the "Part Number List".

\*\* : Under development



## Microcontrollers for televisions

For color TV applications Toshiba offers a line-up of 8-bit microcontrollers with an OSD function and an I<sup>2</sup>C bus interface circuit.

- Main functions**
- High-functionality 8-bit core (870/X Series)
  - High ROM and RAM capacity
  - High-speed operation, low power consumption
  - Serial interface: I<sup>2</sup>C bus

### CRT TV System block diagram

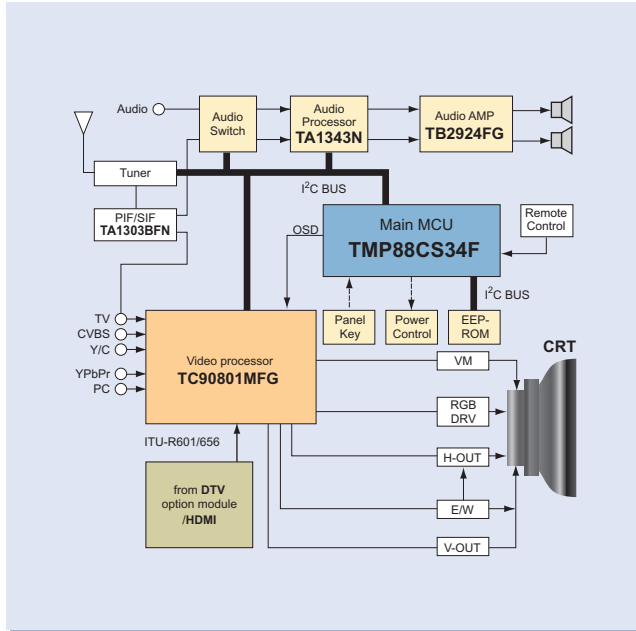

### LCD TV System block diagram

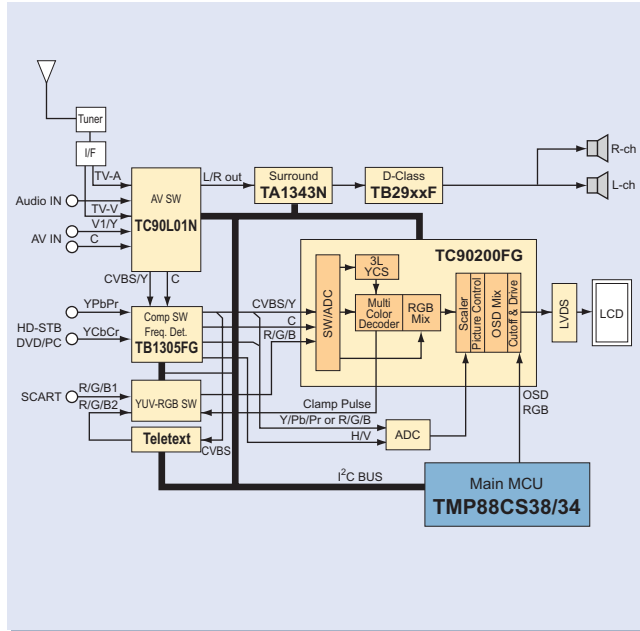

### Product outline

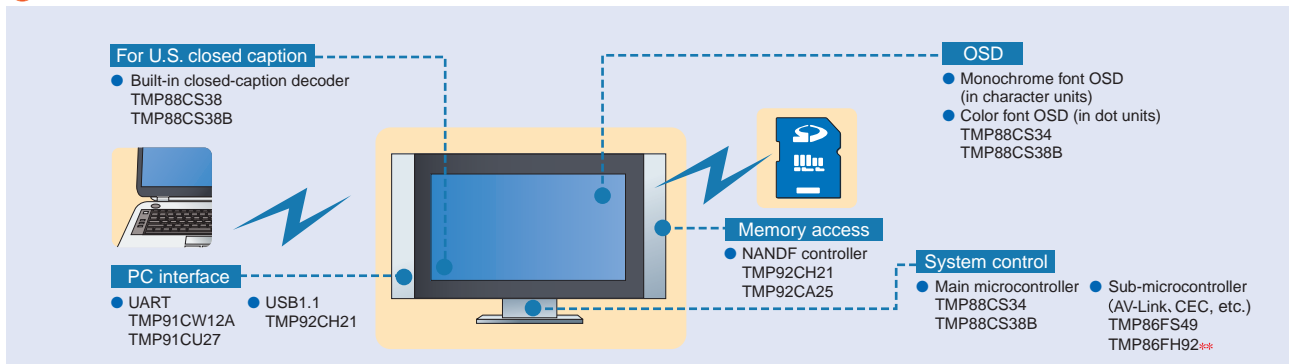

\*\* : Under development

### Product line-up

Part Number	TMP88CP34NG/FG	TMP88CS34NG/FG	TMP88CM38ANG/AF	TMP88CP38ANG/AF	TMP88CS38NG/FG	TMP88CM38BNG/BFG	TMP88CP38BNG/BFG	TMP88CS38BNG/BFG
ROM (bytes)	48K	64K	32K	48K	64K	32K	48K	64K
RAM (bytes)	1.5K		2K		1.5K		2K	
PWM	14-bit x 2ch, 12-bit x 2ch,		14-bit x 2ch, 12-bit x 2ch, 7-bit x 6ch					
I/O	33							
AD Converter	8-bit x 6ch							
I <sup>2</sup> C Interface	1ch>Note 1)							
On Screen Display	Dot coloring character 32-digit x 12-line display		For U.S. closed caption 32-digit x 12-line display					
OSD clock	External LC oscillation circuit		Internal oscillation circuit			External LC oscillation circuit		
Version with OTP	TMP88PS34NG/FG		TMP88PS38NG/FG			TMP88PS38BNG/BFG		
Packages	SDIP42/QFP44 (14 x 14 mm)							

\* For details of the products listed above, see the "Part Number List".  
Note: Although there is only one channel, the circuit has two sets of input/output lines, which can be selected.





## Microprocessors for digital equipment

These 32- and 64-bit microprocessors are ideal for use as the main controller in digital equipment, such as printers and network equipment. The units with a built-in PCI bus interface are outstanding for peripheral equipment expandability. These microprocessors are also useful in other applications.

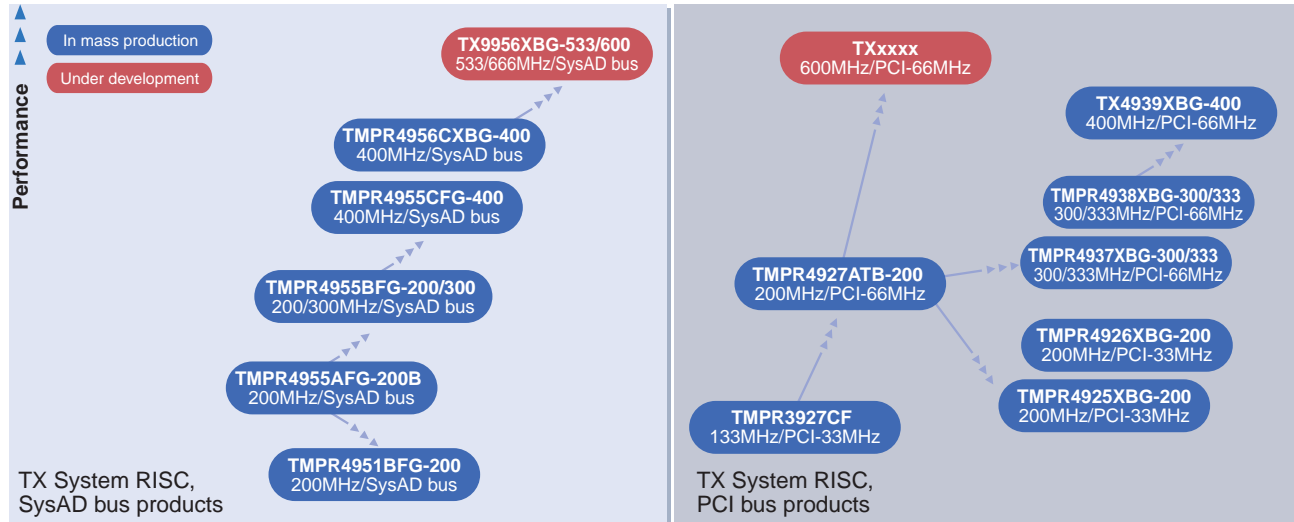

## 32-/64-bit RISC processors

Part Number	Package	Additional functions
<b>**TX9956XBG-533/600</b>	PBGA272	<ul style="list-style-type: none"> <li>64-bit Superscalar RISC processor</li> <li>Built-in instruction cache 32 Kbytes, data cache 32 Kbytes</li> <li>256 Kbyte level 2 cache</li> <li>Built-in FPU conforming to IEEE754 (single precision/double precision)</li> <li>Employs 32-bit/64-bit SysAD Bus interface</li> <li>Power supply voltage (I/O 2.5 V or 3.3 V, internal 1.25 V)</li> <li>Operating frequency 533 MHz/600 MHz</li> </ul>
<b>TMPR4956CXBG-400</b> <b>TMPR4955CFG-400</b> <b>TMPR4955BFG-200/300</b>	QFP160 (4955) PFBGA217 (4956)	<ul style="list-style-type: none"> <li>64-bit RISC processor</li> <li>Built-in instruction cache 32 Kbytes, data cache 32 Kbytes</li> <li>Built-in FPU conforming to IEEE754 (single precision/double precision)</li> <li>Employs 32-bit (TMPR4955B/C)/64-bit (TMPR4956) SysAD Bus interface</li> <li>Power supply voltage (I/O 3.3 V, internal 1.5 V; TMPR4955B), (I/O 2.5 V or 3.3 V, internal 1.25 V; TMPR4955C, TMPR4956)</li> <li>Operating frequency 200 MHz/300 MHz (TMPR4955B), 400 MHz (TMPR4955C, TMPR4956)</li> </ul>
<b>TMPR4951BFG-200</b>	LQFP100	<ul style="list-style-type: none"> <li>64-bit RISC processor</li> <li>Built-in instruction cache 16 Kbytes, data cache 8 Kbytes</li> <li>No FPU</li> <li>Employs 32-bit SysAD Bus interface</li> <li>Power supply voltage (I/O 2.5 V or 3.3 V, internal 1.5 V)</li> <li>Operating frequency: 200 MHz</li> </ul>
<b>TX4939XBG-400</b>	PBGA456	<ul style="list-style-type: none"> <li>64-bit RISC processor</li> <li>Built-in instruction cache 32 Kbytes, data cache 32 Kbytes</li> <li>Built-in FPU conforming to IEEE754 (single precision/double precision)</li> <li>Encryption engine (DES, 3DES, AES etc.), DDR-SDRAM controller, AC-Link, 10/100 BASE-T EtherMAC (2 channels), ATA-100 (2 channels), ITU656 video output port, PCI controller, etc.</li> <li>Power supply voltage (I/O 3.3 V, Internal 1.25 V, DDR-SDRAM 2.5 V (333 MHz or less)/2.6 V (400 MHz))</li> <li>Operating frequency 400 MHz</li> </ul>
<b>TMPR4937XBG-300/333</b> <b>TMPR4938XBG-300/333</b>	PBGA484	<ul style="list-style-type: none"> <li>64-bit RISC processor</li> <li>Built-in instruction cache 32 Kbytes, data cache 32 Kbytes</li> <li>Built-in FPU conforming to IEEE754 (single precision/double precision)</li> <li>Memory controller, DMA controller, timer, serial, AC-link, Ether MAC (TMPR4938), etc.</li> <li>Power supply voltage (I/O 3.3 V, internal 1.5 V)</li> <li>Operating frequency 300 MHz/333 MHz</li> </ul>
<b>TMPR4925XBG-200</b> <b>TMPR4926XBG-200</b>	PBGA256	<ul style="list-style-type: none"> <li>64-bit RISC processor</li> <li>Built-in instruction cache 16 Kbytes, data cache 16 Kbytes</li> <li>Built-in FPU conforming to IEEE754 (single precision/double precision)</li> <li>NAND Flash controller, PCI controller, DMA controller, memory controller, timer, serial, AC-link, Data Encryption Standard (TMPR4926), etc.</li> <li>Power supply voltage (I/O 3.3 V, internal 1.5 V)</li> <li>Operating frequency 200 MHz</li> </ul>
<b>TMPR3927CF</b>	QFP240	<ul style="list-style-type: none"> <li>32-bit RISC processor</li> <li>Built-in instruction cache 8 Kbytes, data cache 4 Kbytes</li> <li>PCI controller, memory controller, DMA controller, timer, serial, etc.</li> <li>Power supply voltage (I/O 3.3 V, internal 2.5 V)</li> <li>Operating frequency 133 MHz</li> </ul>

\* For details of the products listed above, see the "Part Number List".

\*\* : Under development

## PCI Connectuon companion chip

Part Number	Package	Additional functions
<b>TC86C001FG (GOKU-S)</b>	LQFP144	<ul style="list-style-type: none"> <li>PCI/IF (32-bit, 33 MHz)</li> <li>ATA/ATAPI host controller, Ultra DMA transfer (mode 4), maximum transfer rate 66 Mbytes/s</li> <li>USB1.1 host, controller 2 ports (OpenHCI 1.0a supported)</li> <li>USB device controller 1 port</li> <li>I<sup>2</sup>C bus/SIO</li> <li>Power supply voltage (I/O 3.3 V, internal 1.5 V)</li> </ul>

\* For details of the products listed above, see the "Part Number List".



## Microcomputers for automotive applications

Toshiba offers a wide selection of automotive microcontrollers with various communications functions such as CAN and SEI. These microcontrollers are manufactured to Toshiba's exacting automotive grade standards<sup>Note)</sup> to ensure high quality in a wide range of operating temperatures.

**Main functions**

- CAN
- SEI

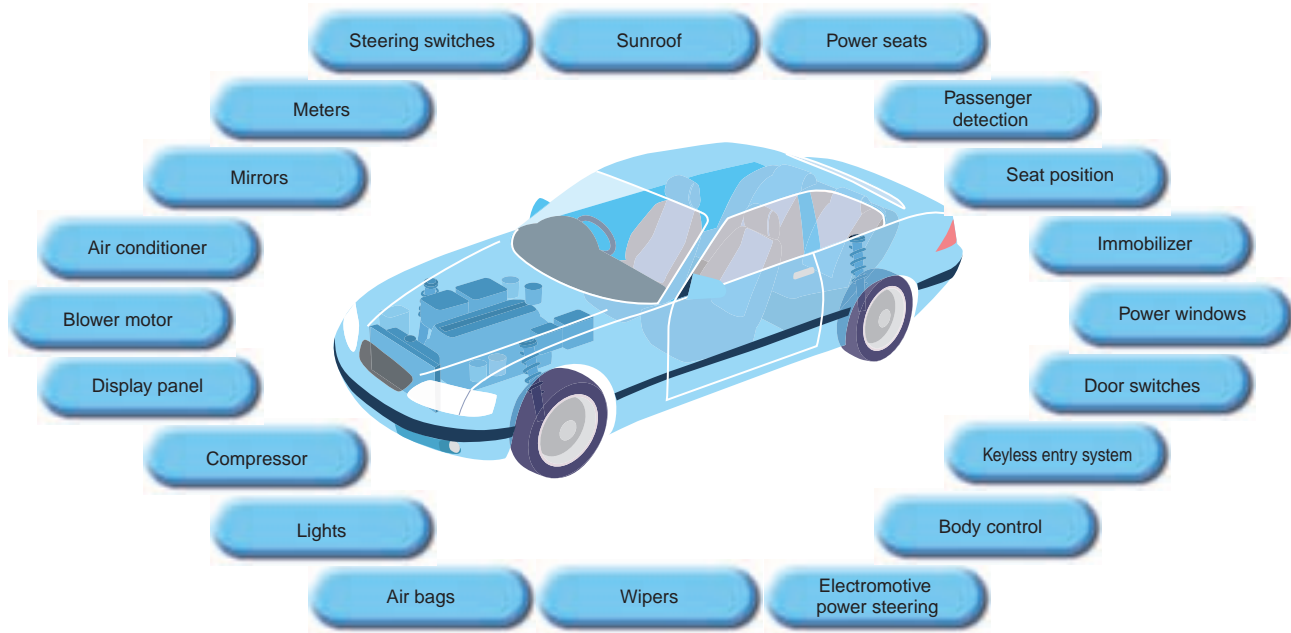

Note: For details about the automotive grade products, please contact your local Toshiba sales representative.

## Product line-up for automotive

ROM size	Legend				32-bit	
	SOP/QFP	DIP	In mass production	Under development		
512 K					92FD54AI <sub>CAN</sub> 92CD54I <sub>CAN</sub>	
256 K					16-bit 91CY22I	
96 K					91CU27R	
60/64 K	8-bit				86FS49AI	
48 K					PWM 91CP82T <sub>CAN</sub>	
32 K					86CM87R <sub>CAN</sub>	
16 K	PMD 88CH40I		86FH92I	PMD 88CH41I/S	86CH87R <sub>CAN</sub>	
			86CH92I/S	86CH47I/S	87CH48I/S	
8 K	86C807I/S		86C892I/S			
			86C808I/S	86C847I/S		
4 K	86C407I/S		86C408I/S			
	SOP/SDIP/SSOP		LQFP44(10 X 10mm)		LQFP(10 X 10mm)/QFP(14 X 14mm)	LQFP(14 X 14mm)
	28-/30-pin		44-pin		64-pin	100-pin



# Microcontrollers Listed by Function / Application

## 8-bit microcontrollers for automotive

Part Number	TMP86C407I/S TMP86C807I/S	TMP86C408I/S TMP86C808I/S	TMP86C847I/S TMP86CH47I/S	TMP86CH87R TMP86CM87R
ROM (bytes)	4/8	4/8	8/16	16/32
RAM (bytes)	256	256	512	1K
I/O	22	24	35	35
CAN	-	-	-	1ch
SEI	1ch	1ch	-	1ch
SIO	-	-	1ch	-
UART	1ch	1ch	1ch	1ch
I <sup>2</sup> C	-	-	-	-
AD converter	8-bit x 6ch	8-bit x 6ch	10-bit x 8ch	10-bit x 14ch
8-bit timer counter	2ch	2ch	2ch	2ch
16-bit timer counter	1ch	1ch	1ch	1ch
Watchdog timer	●	●	●	●
Dual Clocks	●	●	●	●
OTP/Flash Version	TMP86P807	TMP86P808	TMP86PM47A/PH47/FH47A	TMP86PM87R
Package	SOP28/SDIP28	SSOP30	LQFP44(10 x 10mm)	LQFP44(10 x 10mm)

Part Number	TMP86C892I/S++ TMP86CH92I/S++	TMP88CH40I	TMP88CH41I/S++	TMP86FS49AI**
ROM (bytes)	8/16	16	16	60
RAM (bytes)	512	512	512	2K
I/O	24	19	19/33	56
CAN(4 mail boxes)	-	-	-	-
SEI	1ch	-	-	-
SIO	-	1ch	1ch	2ch
UART	1ch	1ch	1ch	2ch
I <sup>2</sup> C/UART	1ch	-	-	-
I <sup>2</sup> C	-	-	-	1ch
AD converter	10-bit x 6ch	10-bit x 4ch	10-bit x 8ch	10-bit x 16ch
8-bit timer counter	2ch	2ch	2ch	4ch
16-bit timer counter	1ch	1ch	2ch	2ch
Motor controller	-	1ch	1ch	-
Watchdog timer	●	●	●	●
Dual Clocks	●	-	-	●
OTP/Flash Version	TMP86FH92I**	TMP88PH40	TMP88PH41	-
Package	SSOP30	SOP28	LQFP44(10 x 10mm)	LQFP64(10 x 10mm)/QFP64(14 x 14mm)

\*\*: Under development

++: Under planning

## 16-bit microcontrollers for automotive

Part Number	TMP91CP82T	TMP91CU27R**	TMP91CY22I	TMP92CD54I
ROM (bytes)	48	96	256	512
RAM (bytes)	2K	10K	16K	32K
I/O	80	53	81	68
CAN(16 mail boxes)	1ch	-	-	1ch
SEI	1ch	-	-	1ch
SIO/UART	2ch	2ch	2ch	2ch
I <sup>2</sup> C	-	1ch	1ch	3ch
AD converter	10-bit x 12ch	10-bit x 4ch	10-bit x 8ch	10-bit x 12ch
8-bit timer counter	4ch	6ch	8ch	8ch
16-bit timer counter	2ch	1ch	2ch	2ch
32-kHz timer (for S/W RTC)	-	●	●	-
H/W RTC	-	-	-	●
16-bit PWM timer	4ch	-	-	-
PDC	1ch	-	-	-
CS/WAIT controller	-	3ch	4ch	1ch
Watchdog timer	-	●	●	●
Dual Clocks	-	●	●	-
OTP/Flash Version	TMP91PP82T	TMP91FY27	TMP91FY42	TMP92FD54AI
Package	LQFP100(14 x 14mm)	LQFP64(10 x 10mm)	LQFP100(14 x 14mm)	LQFP100(14 x 14mm)

\*\*: Under development

## 32-bit microcontrollers for automotive





## Microcontrollers for automotive motor control

These microcontrollers incorporate an inverter control function for sensorless/sensor-equipped 3-phase DC and AC motors and a sine wave drive circuit for supporting high reliability and high temperature operation. The sine wave drive circuit enables easy sine wave drive suited to high efficiency and low noise.

- Main functions**
- Sine wave drive circuit
  - Rotor position detection function
  - Motor control timer and timer capture
  - PWM waveform generation function
  - Overload protection function
  - Abnormality protection function
  - Automatic commutation start and automatic position detection start

### Achieved intelligent, high value-added automotive motors!

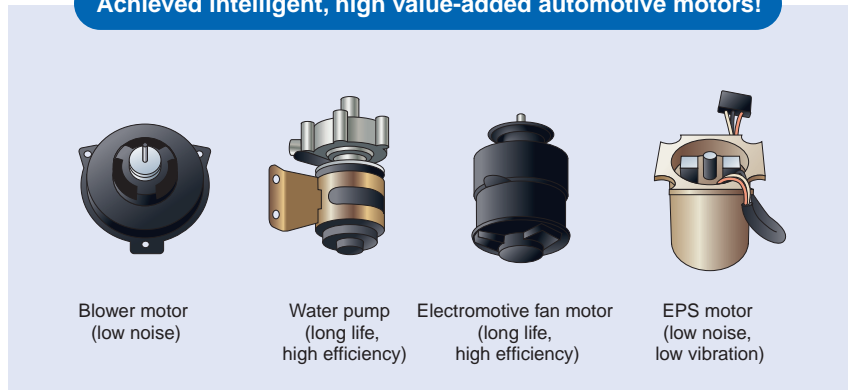

## Automotive motor system block diagram

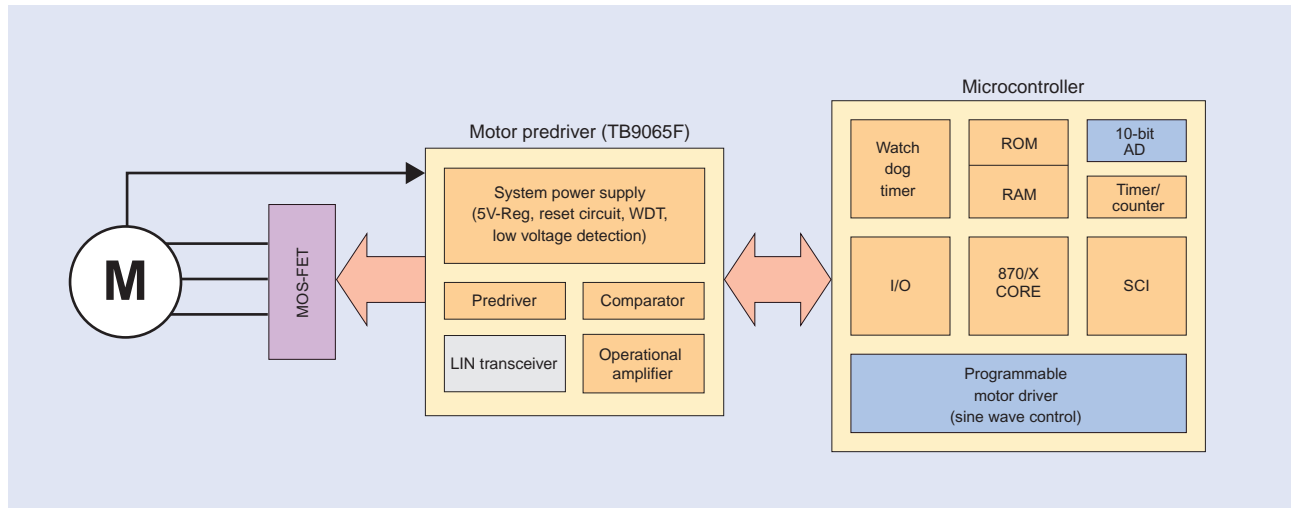

## Product line-up

### Microcontrollers

Part Number	TMP88CH40IMG	TMP88CH41UG <sup>(Note2)</sup>
Series name	870/X	870/X
Motor control circuit (PMD) <sup>(Note1)</sup>	1ch	1ch
AD converter	10-bit x 4ch	10-bit x 8ch
Memory (ROM/RAM)	16KB/512B	16KB/512B
Package	SOP28	QFP44
OTP product <sup>(Note3)</sup>	TMP88PH40MG	TMP88PH41UG

### DSP

Part Number	TMP77CM70TUG**
DSP	16-bit fixed-point
Motor control circuit (PMD) <sup>(Note1)</sup>	1ch
AD converter	10-bit x 8ch
Memory (ROM/RAM)	32KB/1KB
Package	LQFP64

\*\* : Under development

Note 1: Programmable Motor Driver

Note 2: Automotive-grade products under consideration

Note 3: Standard grade

\* For details of the products listed above, see the "Part Number List".

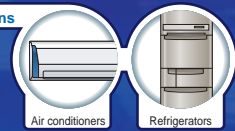

# Microcontrollers Listed by Function / Application

## Microcontrollers for inverter electric appliances

The following microcontrollers incorporate various functions suitable for electric appliances that require user interfaces, sensor inputs, actuator control, and communications.

- Main functions**
- AD converter
  - Serial communication
  - Motor control circuit
  - LCD driver

### Air conditioner system block diagram

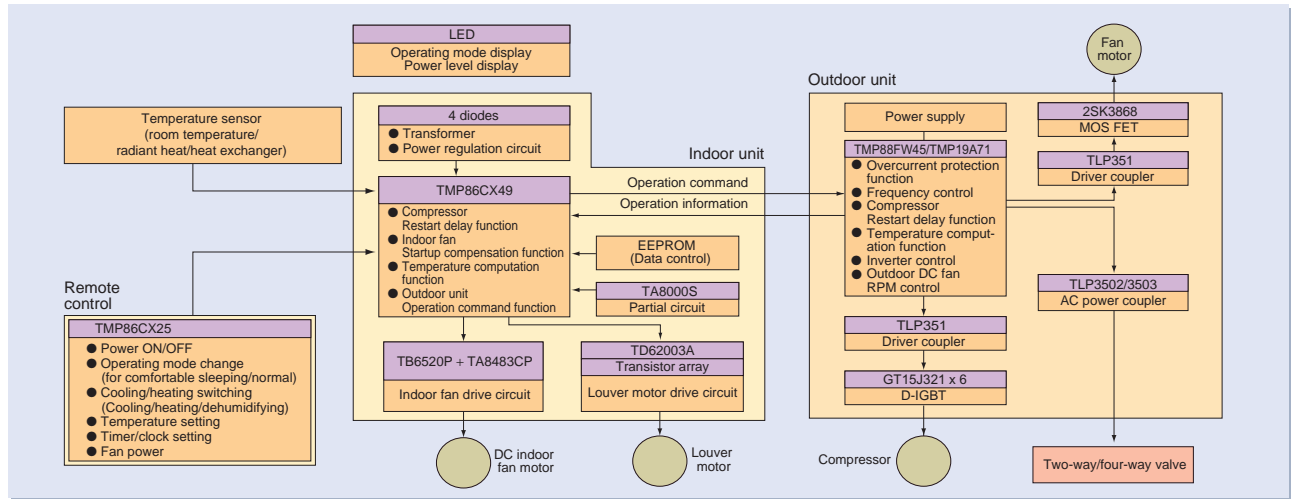

### Refrigerator system block diagram

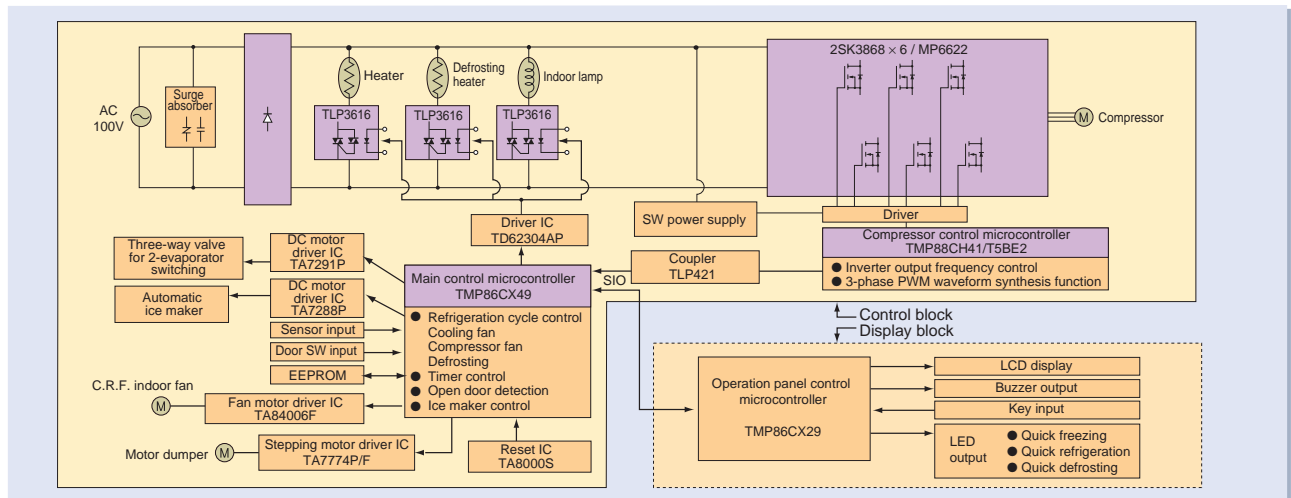

### Product outline

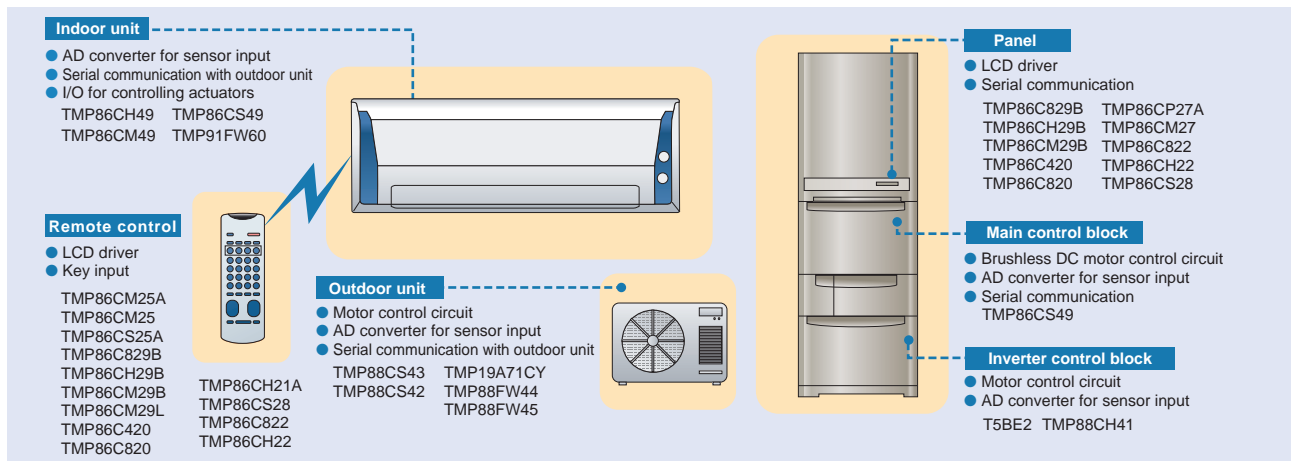

\* Some of the flash memories use the SuperFlash® technology under the license of Silicon Storage Technology, Inc. SuperFlash® is a registered trademark of Silicon Storage Technology, Inc.



## Microcontrollers for digital single-lens reflex cameras (DSLRs)

These microcontrollers incorporate high-speed AD converters to support AF/AE control (computation), dial input, and other features suitable for the main controller of a single-lens reflex camera.

## Microcontrollers for digital video cameras (DVCs)

These microcontrollers, responsible for controlling the camera and tape deck sections, contain large-capacity ROM to help minimizing the product size and support various features suitable for main DVC control.

**Main functions**

- AF/AE control (high-speed AD/multidigit operation)
- Dial input control
- Shutter control
- Tape control
- LCD display control

### DVC system block diagram

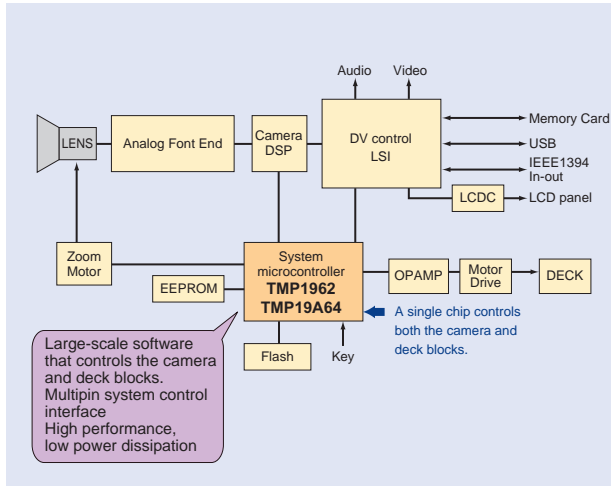

### DSLR system block diagram

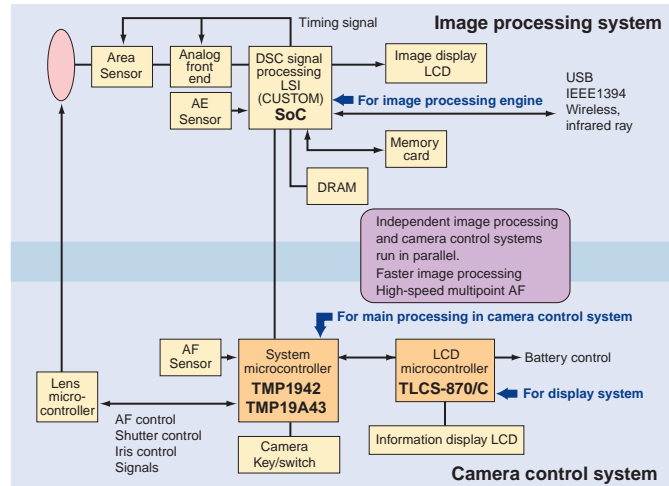

### Product outline

<p><b>Camera control/Shutter control AF control/Tape control</b></p> <p>TMP1962C10BXB TMP19A64F20BXB TMP19A64C1DXB</p>	<p><b>LCD display</b></p> <p>TMP86C420    TMP86FM26 TMP86C820    TMP86CP23A TMP86C822    TMP86FP24 TMP86C829B    TMP86CS25A TMP86CH21A    TMP86CS28 TMP86CH22    TMP86FS28 TMP86CH29B TMP86CM23A TMP86CM29 TMP86CM25</p>	<p><b>AF control (computation), AE control (computation) Built-in strobe control Dial input, shutter control</b></p> <p>TMP1942CYU    TMP19A43FDXB TMP1942CZU    TMP19A43FZXB** TMP1942CZXB    TMP19A43CDXB                           TMP19A43CZXB</p>
--	--	--

\*\* : Under development

### Product line-up

Part Number	TMP1942CYUG/CZUG/CZXBG	TMP1962C10BXBG	TMP19A43FDXBG/CDXBG	TMP19A43FZXBG**/CZXBG	TMP19A64F20BXBG/C1DXBG
Maximum operating frequency (MHz)	32	40.5	40	40	54
Supply voltage (V)	2.7 to 3.6	1.35 to 1.65 I/O: 1.65 to 3.3 2.3 to 3.3 AD: 2.7 to 3.5	1.35 to 1.65 I/O, AD: 2.7 to 3.6 DA: 2.3 to 2.7	1.35 to 1.65 I/O, AD: 2.7 to 3.6 DA: 2.3 to 2.7	1.35 to 1.65 I/O: 1.65 to 3.3
Internal bus width	32	32	32	32	32
External bus width	16 (address/data multiplexed)	16 (multiplexed or separate selectable)	16 (multiplexed or separate selectable)	16 (multiplexed or separate selectable)	16 (multiplexed or separate selectable)
Internal ROM (bytes)	256/384K	1024K	512K	384K	2048K/1536K
Internal RAM (bytes)	16K	40K	24K	20K	64K/56K
AD converter	16ch (conversion time: 2μs)	24ch	16ch (conversion time: 1.15μs)	16ch (conversion time: 1.15μs)	24ch
DMAC channels	4ch	8ch	8ch	8ch	8ch
I/O ports	108	202	143	143	209
Serial interface	6ch	8ch	7ch	7ch	8ch
Timer channels	28ch	18ch	17ch	17ch	12ch
External interrupt pins	29	25	48	48	20
Dual clock	●	-	●	●	●
Debug support unit	● (Flash product only)	●	●	●	●
Package	LQFP144(16 x 16mm)/ FBGA177(13 x 13mm)	FBGA281(13 x 13mm)	FBGA193(12 x 12mm)	FBGA193(12 x 12mm)	FBGA281(13 x 13mm)
Others	10-bit DA converter x 3 channels ROM correction 2-phase pulse input counter Dynamic pull-up 5 V capable ports (x 15)	ROM correction 2-phase pulse input counter	8-bit DA converter x 2 channels ROM correction 2-phase pulse input counter Dynamic pull-up	8-bit DA converter x 2 channels ROM correction 2-phase pulse input counter Dynamic pull-up	Built-in back-up block ROM correction 2-phase pulse input counter

\* For details of the products listed above, see the "Part Number List".

\*\* : Under development



## Microcontrollers for audio (CD-MP3 control MCUs)

Toshiba's extensive line-up of microcontrollers for audio applications includes 16-bit products ideal for controlling CD-MP3 decoder ICs, and 32-bit products incorporating a USB host controller which are software-compatible with the 16-bit products.

### Main functions

- Controlling CD servo and CD-MP3 decoder ICs
- Memory variations
- Pin count variations

### Sample application: CD-MP3/USB/SD system

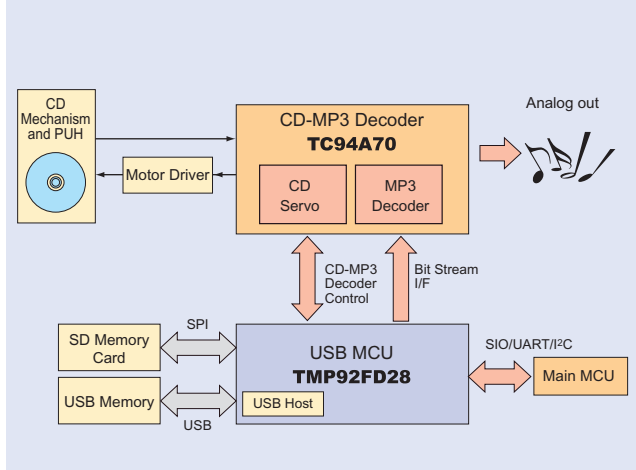

\* MP3 and WMA are trademarks or registered trademarks of their respective holders.

### Roadmap for audio MCUs

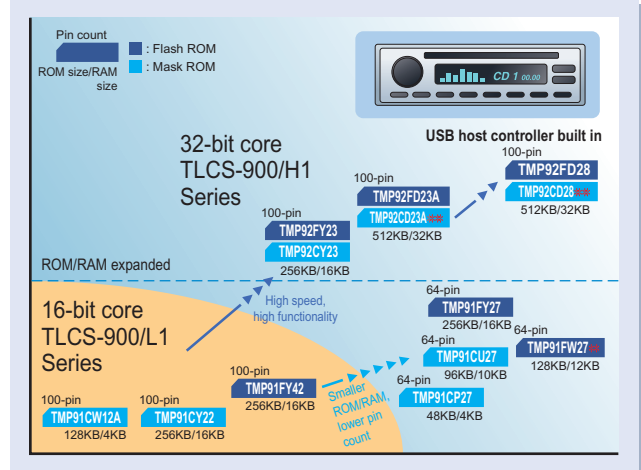

\*\* : Under development

## Microcontrollers for audio (Main control MCUs)

These 32-bit microcontrollers incorporate large-capacity memory and a wide range of serial interfaces, hence they are suitable for main control, for example, in car audio. The series also includes products that contain CAN controllers.

### Main functions

- High performance
- Large-capacity memory
- Range of serial interfaces
- Peripheral unit control

### Sample application : Main control system

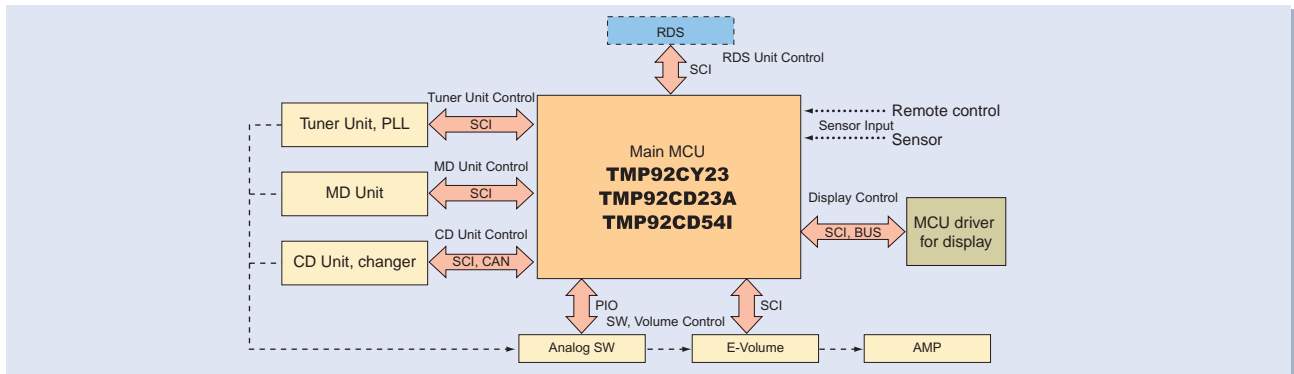

### Product line-up

#### CD-MP3 control MCU

Part Number	TMP91CP27UG/ TMP91CU27UG	TMP91CW12AFG/ TMP91CY22FG	TMP92CY23FG/DFG TMP92CD23AFG/DFG**	TMP92CD28FG/ TMP92CD28DFG**
Series name	900/L1	900/L1	900/H1	900/H1
ROM(bytes)	48KB/96KB	128KB/256KB	256KB/512KB	512KB
RAM(bytes)	4KB/10KB	4KB/16KB	16KB/32KB	32KB
I/O port	53	81	84	72
10-bit AD converter(ch)	4ch	8ch	12ch	-
UART/SIO (ch)	2ch	2ch	3ch	2ch
I <sup>2</sup> C bus/SIO (ch)	1ch	1ch	2ch	2ch
USB HOST controller	-	-	-	1ch
Package	LQFP64	LQFP100	LQFP100/QFP100	LQFP100/QFP100

\*\* : Under development

#### Main control MCU

Part Number	TMP92CY23FG/DFG	TMP92CD23AFG/DFG**	TMP92CD54IFG
Series name	900/H1	900/H1	900/H1
ROM(bytes)	256KB	512KB	512KB
RAM(bytes)	16KB	32KB	32KB
I/O port	84	84	68
10-bit AD converter(ch)	12ch	12ch	12ch
UART/SIO (ch)	3ch	3ch	2ch
I <sup>2</sup> C bus/SIO (ch)	2ch	2ch	3ch
CAN	-	-	1ch
Package	LQFP100/QFP100	LQFP100/QFP100	QFP100

\*\* : Under development

\* Some of the flash memories use the SuperFlash® technology under the license of Silicon Storage Technology, Inc. SuperFlash® is a registered trademark of Silicon Storage Technology, Inc.





**RISC** stands for **Reduced Instruction Set Computer**. The smaller, fixed-length instruction set of a RISC processor allows fast program execution. Compared to the conventional **CISC (Complex Instruction Set Computer)**, the RISC processor's simplified circuit structure offers attractive features such as increased execution speed and reduced power consumption.

Toshiba has adopted the **RISC** processor technology developed by MIPS Technologies, Inc. In addition to the 32-bit processor **TX39** Family for embedded use, Toshiba has also developed the **TX19** Family of processors, featuring an additional 16-bit instruction set, and the 64-bit **TX49** and **TX99** Family of processors for embedded use. The **TX19**, **TX39**, **TX49** and **TX99** families serve as CPU cores, which, together with megacells for peripherals, offer solutions for the implementation of ASICs.

**Seamless core**  
TX System RISC line-up

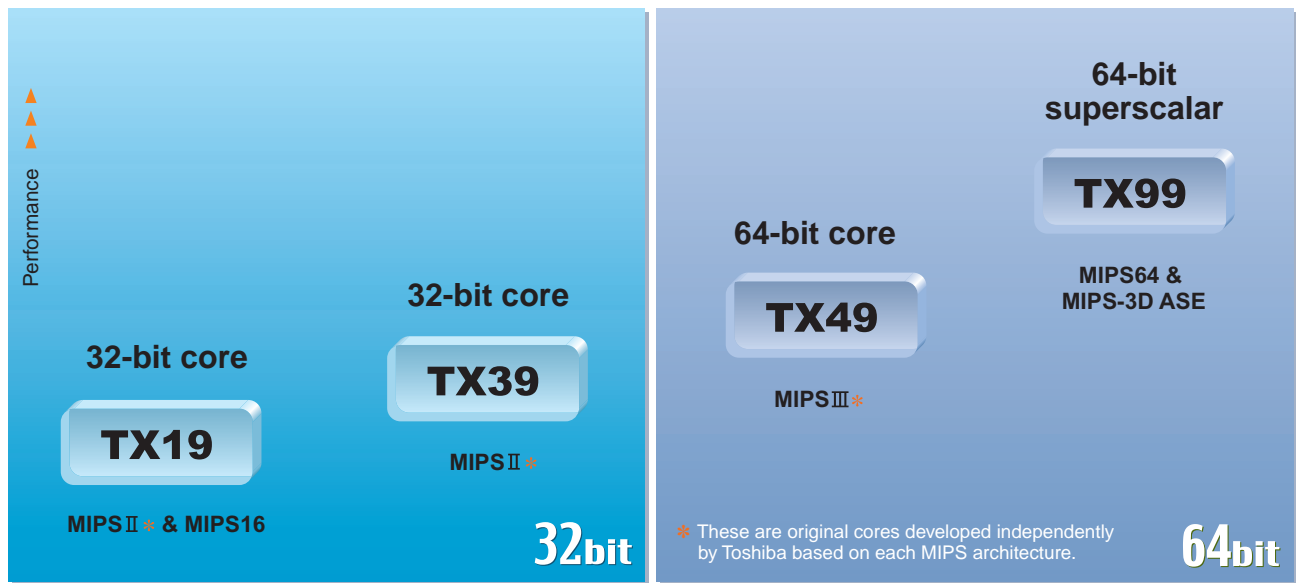

**A complete line-up of products, ranging from low-power-consumption devices to high-speed-processing devices, to suit a wide variety of applications**

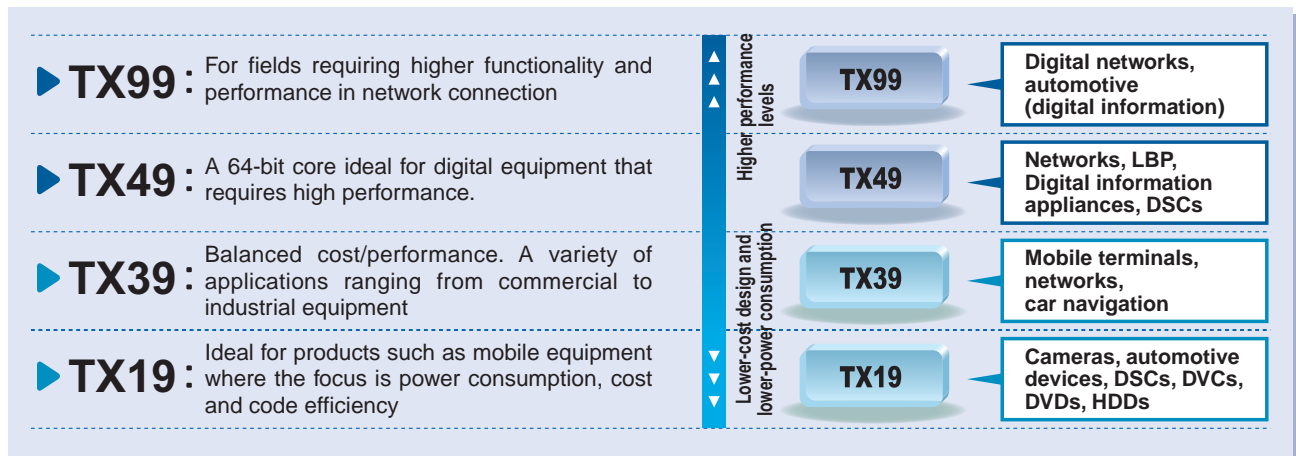

# TX99 Family

The **TX99** Family of **RISC** microprocessors is based on the MIPS64™ microarchitecture of MIPS Technologies, Inc. (U.S.A.) These microprocessors have a 64-bit superscalar architecture developed jointly by MIPS and Toshiba. MIPS64™ has the highest performance in the industry, enabling simultaneous execution of two instructions. By using this architecture in semiconductors and systems, it is possible to achieve high-speed data processing in fields such as automotive (digital information), OA, home servers, digital information appliances and networks where cost and power consumption are the top priority.

## TX99 Processor Core Features

- Based on MIPS 25Kf high-end RISC core
  - Instruction set: MIPS 64™ with MIPS-3D™ ASE
- Employs dual issue superscalar pipeline (7-stage)
- Core operation frequency: 533 MHz/600 MHz
- Equipped with 32-Kbyte instruction cache and 32-Kbyte data cache
  - employs 4-way set-associative system
- Level 2 cache of up to 256 Kbytes can be installed (optional)
- Built-in single/double precision floating point coprocessor
- SOC I/F with a high bus band width (12.8 Gbytes/s)
  - with numerous bus frequency division ratios for core vs. SOC I/F

## Can be used as a CPU core for custom SoC

- **TX99/H4**: 90-nm process technology
- Complete development environment

### Superscalar Architecture

## TX9956XBG-533/600

Under development

## 64-bit RISC microprocessor using a Superscalar architecture

The **TX9956XBG** is equipped with a **TX99/H4** core that uses a 90 nm process to enable 533 or 600 MHz operation. This processor has a built-in floating-point unit (FPU) and SysAD bus interface, and is useful in a wide range of applications areas including LBPs and set-top boxes. It contains 32-Kbyte instruction cache and 32-Kbyte data cache, as well as large secondary cache of 256 Kbytes.

- 64-bit Superscalar equipped with **TX99/H4** core
- On-chip caching
  - Four-way set-associative caches
  - Instruction cache: 32 Kbytes
  - Data cache: 32 Kbytes
  - Level 2 cache: 256 Kbytes
- External bus (SysAD bus) 64-/32-bit
- Single-/double-precision FPU
- Clock generator (CG)
- Low power consumption mode
- Built-in debug support unit (DSU)
- Maximum operating frequency:
  - Core: 533 MHz/600 MHz
  - External bus: 133 MHz
- I/O operating voltage: 2.5 V or 3.3 V
  - Internal operating voltage: 1.25 V
- Package:
  - 272-pin PBGA, 27 mm x 27 mm, 1.27-mm pitch (with 16 thermal balls)

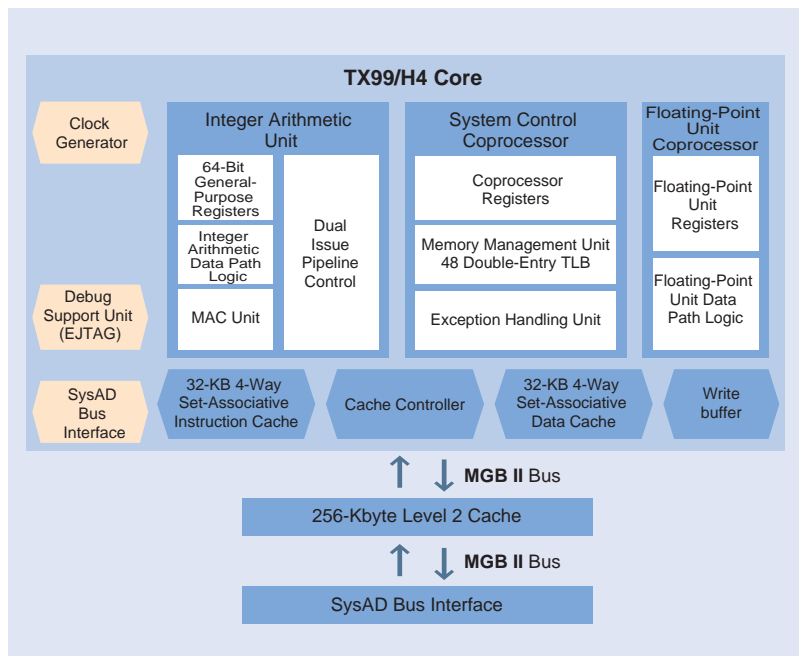

# TX49 Family

The **TX49** Family of **RISC** microprocessors for embedded use is an original Toshiba 64-bit processor family and is based on the **RISC** architecture designed by MIPS Technologies, Inc. The customer can implement a custom SoC using the **TX49 Family** cores in conjunction with general-purpose ASSP products.

## 64-bit RISC architecture

- R4000A architecture
  - Upward-compatible instruction set including MIPS I, MIPS II and MIPS III instruction set architectures (ISAs)
- **TX49/H2**: Internal operating frequency: 200 MHz
- **TX49/H3**: Internal operating frequency: 300 MHz/333 MHz
- **TX49/H4**: Internal operating frequency: 400 MHz
- **TX49/L3**: Internal operating frequency: 200 MHz
- **TX49/L4**: Internal operating frequency: 333 MHz (Under development)
- **TX49/W4**: Internal operating frequency: 400 MHz (Under development)
- Level 2 cache of up to 256 Kbytes can be installed (optional)
- Non-blocking load function
  - The instructions which follow the instruction currently being executed are executed while the cache is being refilled.
- DSP function
- Thirty-two 64-bit general-purpose registers
- Optimized 5-stage pipelining
- Single- or double-precision floating-point unit (FPU) (TX49/H2, TX49/H3, TX49/H4 and TX49/W4 core)
- Debug support unit (DSU)
  - Supports EJTAG.

## Low-power consumption design

- Low-power consumption modes (Doze/Halt)

## Built-in high-capacity primary cache

- Instruction cache: 32 Kbytes
  - 4-way set-associative
  - Lock function supported
- Data cache: 32 Kbytes
  - 4-way set-associative
  - Lock function supported
  - Write-back/write-through (every page)

## Can be used as a CPU core for custom SoC

- **TX49/H2**: 0.18- $\mu$ m process technology
- **TX49/H3, TX49/L3**: 0.13- $\mu$ m process technology
- **TX49/H4, TX49/L4, TX49/W4**: 90-nm process technology
- Complete development environment

### First product incorporating the TX49/L3 core

## TMPR4951BFG-200

### 64-bit RISC microprocessor offering excellent cost performance

The **TMPR4951BFG** incorporates a 0.13- $\mu$ m process **TX49/L3** core, and by minimizing the built-in functions and external interfaces, it offers the industry's highest cost-performance ratio in the 200 MHz class and low-power consumption, all encapsulated in a compact package. Moreover, the SysAD bus interface adopted for this microprocessor enables diverted use of existing resources and facilitates system development. These and other features make it an ideal controller for low-end LBPs, networks, and settop boxes.

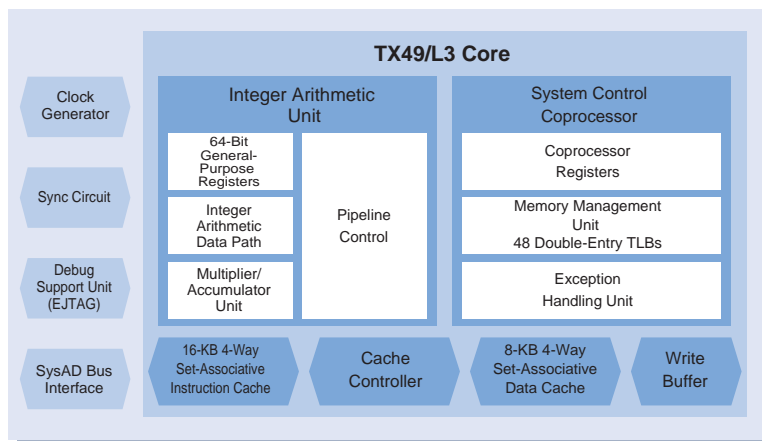

- **TX49/L3** 64-bit RISC core
- Five-stage pipeline
- On-chip caching
  - 4-way set-associative caches
  - Instruction cache: 16 Kbytes built in
  - Data cache: 8 Kbytes built in
  - Cache lock function
- 48 double-entry
- External bus (32-bit SysAD bus)
- Low-power consumption mode
- Debug support unit (DSU) built in (execution control only)
- Maximum operating frequency:
  - Core: 200 MHz
  - External bus: 100 MHz
- I/O supply voltage: 2.5 V or 3.3 V
- Internal supply voltage: 1.5 V
- Package: 100-pin LQFP (14 mm x 14 mm, 0.5-mm pitch)

# TX49 Family

This highly functional, high-performance family contains an encoder, and is well adapted to digital information equipment.

## TX4939XBG-400

### 64-bit RISC microcontroller with encoder, DDR-SDRAM controller, EtherMAC, and ATA100

The **TX4939XBG-400** is based on a **TX49/H4** core, and contains an encoder, a DDR-SDRAM controller, an ATA100, an EtherMAC, a PCI controller and other peripherals. It is a highly functional, high-performance, 64-bit RISC microcomputer optimally applicable to digital information appliances. The processor operates at a frequency of 400 MHz, while the PCI bus runs at a frequency of 33/66 MHz.

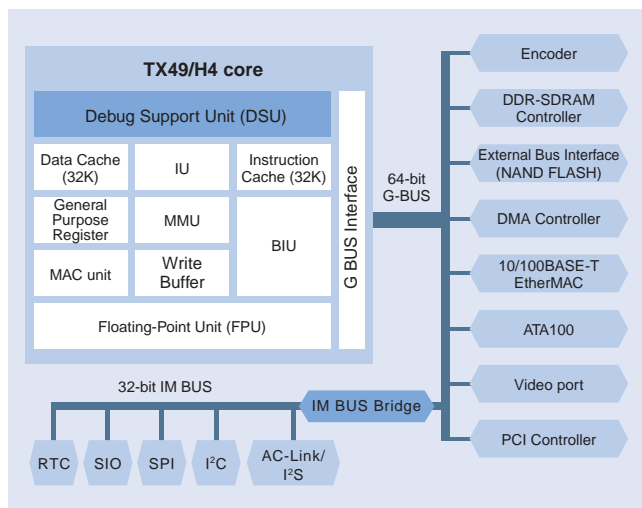

- **TX49/H4** 64-bit RISC core
- On-chip caching
  - 4-way set-associative caches
  - Instruction cache: 32 Kbytes
  - Data cache: 32 Kbytes
  - Cache lock function
- Memory management unit
- Memory controller: DDR-SDRAM (32-bit, 400 MHz)
  - Supports NAND Flash, SRAM, ROM and NOR Flash
- Encoder: Supports DES, 3DES, AES, MD5, SHA1 and Modular Exponentiation Operation Coprocessor
- DMA controller: 8 channels
- 10/100BASE-T EtherMAC: 2 channels
- ATA100: 2 channels
- Video port: 1-parallel I/O, 3-serial in
- PCI controller: 33/66 MHz
- AC-Link
- I²S
- SIO: 4 channels
- SPI
- I²C
- Interrupt controller
- Maximum operating frequency: 400 MHz
- I/O supply voltage: 3.3 V
  - Internal supply voltage: 1.25 V
- I/O (DDR 400): 2.6 V
  - I/O (less or equal to DDR 333): 2.5 V
- Package: 456-pin PBGA (with 36-pin thermal balls)

### TX4939 reference board

This board consists of a CPU module and a base board.

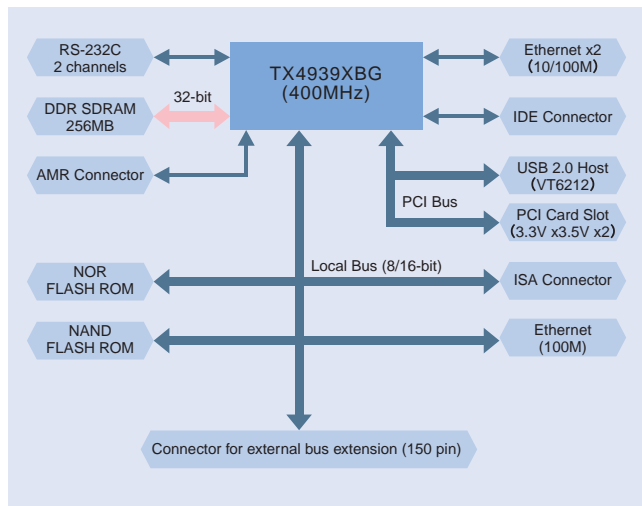

#### CPU module

- **TX4939XBG-400**
- Contains four 512 M-bit DDR-SDRAMs suitable for the DDR400 in the standard configuration sized totally at 256 MB.
- Contains a power supply necessary to drive the DDR memory.
- Supports an EJTAG interface that allows data to be read and written.
- Supports a DIP switch used for boot setting.
- Provided with the CPU around which reset, clock and RTC circuits are installed.

#### Base board

- The **TX4939** contains two channels of Ethernet controllers each of which consists of a 10/100M Ethernet MAC and an external PHY.
- Supports a NOR flash ROM (x 16 bits) consisting of 32 MB of a user ROM and 8 MB of a monitor ROM.
- Contains 32 MB of a NAND flash ROM (x 8 bits).
- Supports two channels of ATA (IDE) interfaces.
- Contains an AUDIO (AC-link/I²S) interface.
- Supports five channels of PCI slots.
- Provided with a USB 2.0 host.
- Supports four channels of RS-232C interfaces.
- Contains a 100 Base-TX Ethernet controller used for debugging.
- Equipped with a ROM emulator connector.
- Supports two ISA slots.
- Contains a connector for external bus extension.
- Provided with an I/O controller.
- Contains a power supply.
- Full size: ATX size
- The model ID required for ordering TX4939 reference board is RBHMA4700 (CE).



Built-in PCI controllers, Ether MAC

## TMPR4938XBG-300/333

### 64-bit RISC microprocessor with built-in PCI controller and Ether MAC

The **TMPR4938XBG** is a 64-bit RISC microprocessor ideal for networks and digital consumer applications. It is based on the **TX49/H3** core and has a variety of built-in functions, including PCI controller, Ether MAC, DMA controller, NAND Flash controller, memory controller, UART and timers. The processor runs at 33/66 MHz, and the PCI bus at 300/333 MHz.

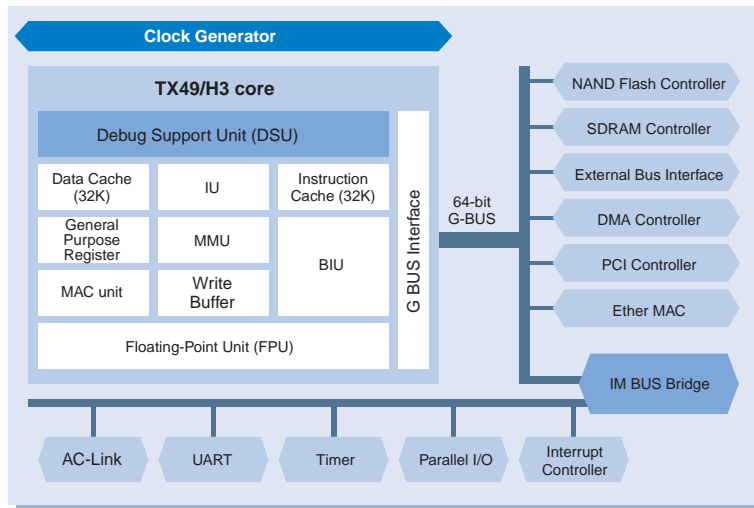

- 64-bit RISC equipped with **TX49/H3** core
- On-chip caching
  - Four-way set-associative caches
  - Instruction cache: 32 Kbytes built in
  - Data cache: 32 Kbytes built in
  - Cache lock function
- Memory management unit (TLB): 64 entries  
4 K / 16 K / 64 K / 256 K / 1 M / 4 Mbyte pages
- Memory controller: SDRAM (64-bit, 133 MHz)  
Supports NAND Flash, SRAM, ROM, NOR Flash and I/O
- Interrupt controller: 6 external sources
- 32-bit timer: 3 channels
- UART: 2 channels
- PCI controller (32-bit, 33/66 MHz)
- DMA controller: 8 channels
- AC-Link (AC97 interface)
- Ether MAC: 2 channels
- I/O ports: 16-bit
- Maximum operating frequency: 300/333 MHz
- I/O supply voltage: 3.3 V  
Internal supply voltage: 1.5 V
- Package: 484-pin PBGA  
(with 64-pin thermal balls)

Achieves 400 MHz operation

## TMPR4955CFG-400 TMPR4956CXBG-400

### 64-bit RISC microprocessors that can easily be enhanced with desired functions

The **TMPR4955CFG** and **TMPR4956CXBG** are equipped with a **TX49/H4** core that uses a 90-nm process to enable 400 MHz operation. These processors have a built-in floating point unit (FPU) and SysAD bus interface, and are useful in a wide range of application areas including LBP, networks and set-top boxes. A debug support unit (DSU) is also built in, and this enables real-time PC tracing and various types of execution control.

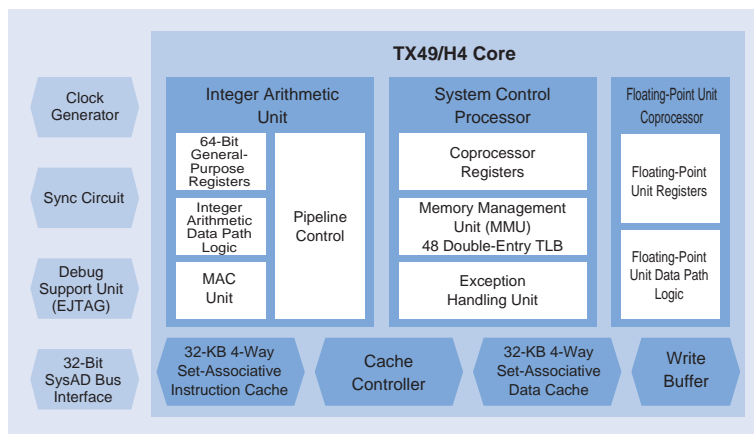

- 64-bit RISC equipped with **TX49/H4** core
- Five-stage pipeline
- On-chip caching
  - 4-way set-associative caches
  - Instruction cache: 32 Kbytes built in
  - Data cache: 32 Kbytes built in
  - Cache lock function
- 48 double-entry TLB
- External bus (SysAD bus):  
32-bit (**TMPR4955CFG**)  
64-/32-bit (**TMPR4956CXBG**)
- Single-/double-precision FPU
- Low power consumption mode
- Built-in debug support unit (DSU)
- Maximum operating frequency:  
Core: 400 MHz  
External bus: 133 MHz
- I/O supply voltage: 2.5 V or 3.3 V  
Internal supply voltage: 1.25 V
- Package:  
160-pin QFP (**TMPR4955CFG**)  
217-pin PFBGA (**TMPR4956CXBG**)

# TX49 Family

## Built-in PCI controllers

### TMPR4937XBG-300/333

#### 64-bit RISC microprocessor with built-in PCI controller

The **TMPR4937XBG** is based on a **TX49/H3** core, and contains a PCI controller, a DMA controller, a memory controller, a UART, a timer and other peripherals. It is a 64-bit RISC microcomputer well adapted to networks and digital information appliances. The processor operates at frequencies of 300 MHz and 333 MHz, while the PCI bus runs at a frequency of 33/66 MHz.

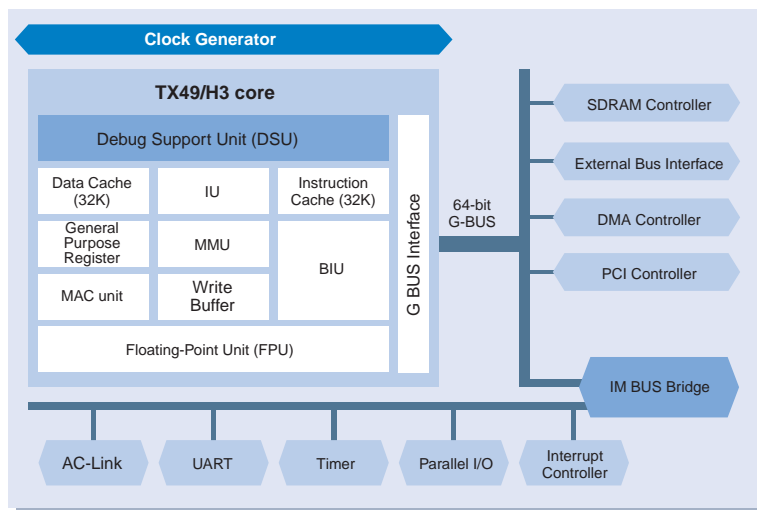

- **TX49/H3** 64-bit RISC core
- On-chip caching
  - Four-way set-associative caches
  - Instruction cache: 32 Kbytes
  - Data cache: 32 Kbytes
  - Cache lock function
- Memory management unit (TLB): 64 entries  
4 K / 16 K / 64 K / 256 K / 1 M / 4 Mbyte pages
- Memory controller: SDRAM (64-bit, 133 MHz)  
SRAM, ROM, NOR Flash and I/O
- Interrupt controller: 6 external sources
- 32-bit timer: 3 channels
- UART: 2 channels
- PCI controller (32-bit, 33/66 MHz)
- DMA controller: 8 channels
- AC-Link (AC97 interface)
- I/O ports: 16-bit
- Maximum operating frequency: 300/333 MHz
- I/O supply voltage: 3.3 V  
Internal supply voltage: 1.5 V
- Package: 484-pin PBGA  
(with 64-pin thermal balls)

## Built-in PCI controller, Encoder (DES) and NAND Flash controller

### TMPR4926XB-200

#### General-purpose 64-bit RISC microprocessor with NAND Flash controller, PCI, DMA and DES

The **TMPR4926XB-200** is a 64-bit RISC microcomputer that is based on a **TX49/H2** processor core and contains a NAND flash controller, a PCI controller, a memory controller, a UART, a timer, a DES and other peripherals. It supports a **TX49/H2** core suitable for high-speed mode. The processor operates at a frequency of 200 MHz, while the PCI bus runs at a frequency of 33 MHz.

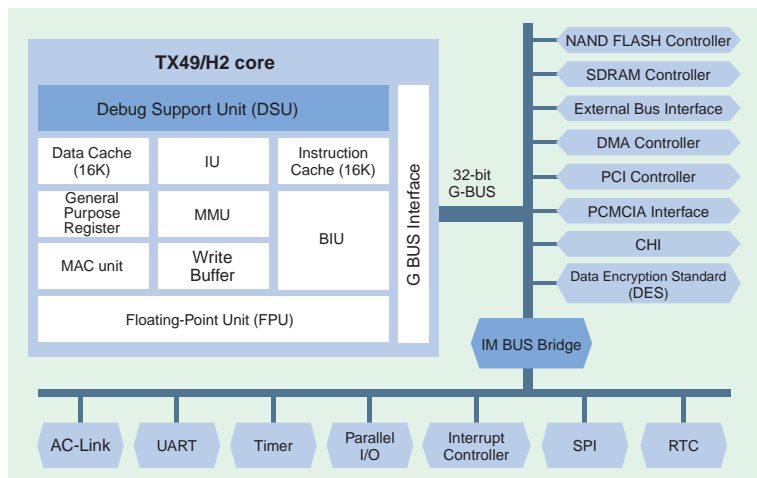

- Instruction cache: 16 Kbytes  
(4-way set-associative caches)
- Data cache: 16 Kbytes  
(4-way set-associative caches)
- MAC: Multiply-accumulate
- Memory management unit (TLB):  
48 double entries (odd/even)  
Joint TLB, 4 K/16 K/64 K/256 K/1 M/4 M bytes pages
- Memory controller:  
Supports NAND Flash, SDRAM (32-bit, 80 MHz),  
SRAM, ROM, NOR Flash and I/O
- Interrupt controller: 8 external sources
- 32-bit timer: 3 channels
- UART: 2 channels
- SPI
- PCI controller (32-bit, 33 MHz)
- DMA controller: 4 channels
- PCMCIA: 2 slots
- AC-Link (AC97 interface)
- Real-time clock
- CHI
- DES/3DES (Data Encryption Standard: Encoder)
- I/O port: 32-bit
- RF (Reduced Frequency) function
- Maximum operating frequency: 200 MHz
- I/O supply voltage: 3.3 V  
Internal supply voltage: 1.5 V
- Package: 256-pin PBGA (27 x 27 mm)

# Companion Chip

PCI-connected companion chip

## TC86C001FG (Goku-S)

### Companion chip with built-in ATA and USB interfaces

The **TC86C001FG (GOKU-S)** is a highly integrated, high-performance interface LSI chip that supports a widely used five interfaces. It incorporates a PCI interface, ATA/ATAPI host controller, USB host controller, USB device controller, I<sup>2</sup>C bus, and serial I/O controller. The GOKU-S facilitates designing a wide range of digital products, including set-top boxes, PVR, information equipment, and multifunction printers.

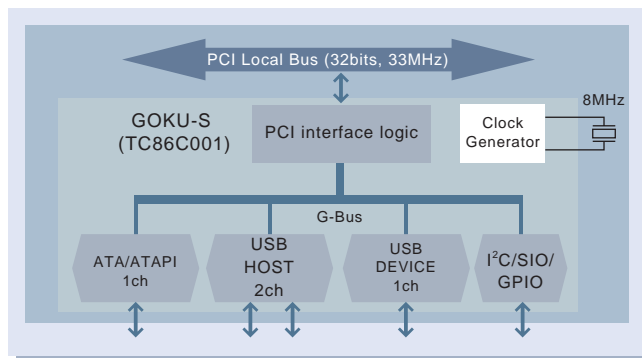

- PCI interface
  - 32-bit PCI bus (33 MHz)
  - PCI Rev. 2.2 compatible
- ATA/ATAPI host controller
  - Single channel: Can connect up to two systems
  - Ultra ATA/66: Supports 66 Mbytes/s
  - PIO modes 0 to 4, multiword DMA modes 0, 1, 2
- USB 1.1 host controller
  - OpenHCI 1.0a compliant
  - 2 ports: 12 Mbits/s or 1.5 Mbits/s
  - Built-in overcurrent protection circuit (for each port)
- USB device controller
  - 1 port: 12 Mbits/s
- I<sup>2</sup>C bus/SIO controller
  - I<sup>2</sup>C master/slave mode
  - UART
- GPIO: 1 or 5 ports
- Core operating voltage: 1.5 V
- Peripheral I/O operating voltage: 3.3 V
- 144-pin LQFP package (20 mm x 20 mm)

32-Bit TX System RISC

## TX39 Family



The **TX39** Family of **RISC** microprocessors for embedded use was developed by Toshiba based on the R3000A architecture designed by MIPS Technologies, Inc. It is an original Toshiba 32-bit processor family. Using the **TX39/H** or the high-speed **TX39/H2**, **TX39/H3** as the CPU core for gate arrays and cell-based ICs, you can accomplish a high level of integration in your system.

### High-performance RISC technology

- R3000A architecture
- Internal operating frequency
  - TX39/H**: 92 MHz, **TX39/H2**, **H3**: 133 MHz
- Built-in cache memory
- Non-blocking load function
  - The instructions which follow the instruction currently being executed are executed while the cache is being refilled.
- DSP function
  - 32-bit multiply-accumulate (MAC) operations take only one clock cycle to execute.

### Low power consumption

- Low power consumption modes
- Clock stop function

### Functions suitable for embedded applications

- Reduced code size and improved performance
  - Use of branch-likely instructions
  - Hardware interlock function
- Increased real-time capability
  - Cache lock function
- Real-time debugger system connection
  - Real-time debugging is possible while cache is on.

### Ideal as CPU core in embedded arrays/cell-based ICs

- **TX39/H2**: 0.25  $\mu$ m process technology
- **TX39/H3**: 0.18  $\mu$ m process technology
- Complete development environment

# MeP

**Media embedded Processor (MeP)** is a processor for media processing based on Toshiba's original architecture. Given its flexible configuration and extensibility, MeP can be customized for targeted applications.

\* For more information, please visit <http://www.MePcore.com/>.

## Overview of the MeP Core

MeP core is a configurable and extensible processor core.

- 32-bit RISC architecture
- High code efficiency due to 32-bit/16-bit variable length instructions
- Supports optional instructions and other configuration items
- Supports interface for hardware extensions
- Fully-synthesizable design not dependent on process technology
- High performance and low power consumption

## Configuration Items

It is possible to set up the optimum configuration by selecting the optional instructions or cache memory size required for media processing.

- Optional instructions
  - 32-bit multiplication/division, bit manipulation, zero detection, differential absolute value, and others
- Memory configuration
  - Instruction cache: 0 to 16 Kbytes (Direct-mapped or 2-way)
  - Data cache: 0 to 16 Kbytes (Direct-mapped or 2-way)
  - Instruction RAM: 0 to 32 Kbytes
  - Data RAM: 0 to 128 Kbytes
- Interrupt controller: 1 to 32 interrupt sources and 1, 3, 7, or 15 priority levels
- Timer/counter: 0 to 4 channels
- Debug support function
- Bus width: 32 or 64 bits

## Hardware Extensions

Application-specific extensions can be connected to the MeP core for high-performance processing.

- User-customized instruction (UCI) unit
  - Customized instructions for single-cycle arithmetic operations.
- DSP unit
  - Customized instructions for multi-cycle arithmetic operations.
  - Can access Internal data RAM of MeP core.
  - Simultaneous two-bank access to data RAM of MeP core.
- VLIW coprocessor
  - Works as a 2-way or 3-way VLIW processor with the MeP core.
- Hardware engines
  - Extensible control registers (up to 4K words for each)

## Development Environment

Third-party vendors provide the software development environments that support the configuration items and hardware extensions described here.

- MeP integrator
- Language tools (C/C++ compiler, assembler, and linker)
- Simulator
- Debugger
- Evaluation board

## MeP Module

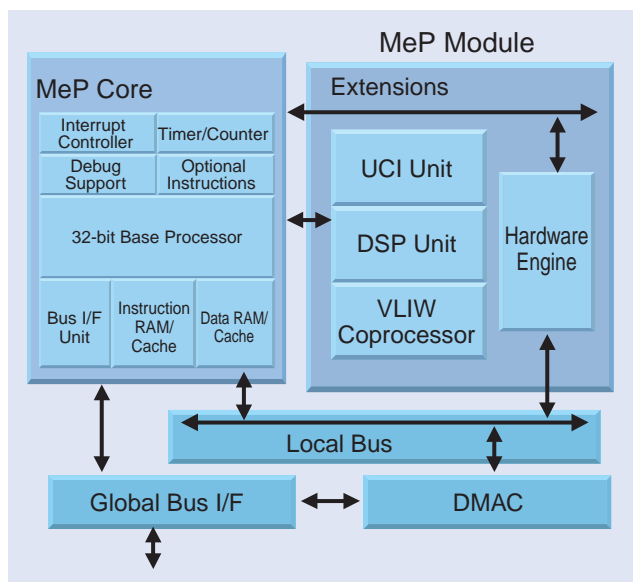

The MeP module is a processor module customized for specific applications.

- MeP core
  - Configurable processor core
- Extensions
  - Four kinds of hardware extensions
  - Multiple extensions
- Local bus
  - Internal data bus in MeP module
  - Hierarchical bus structure for higher transfer efficiency
- DMAC
  - Transfers data between the global bus and MeP core or extensions.
- Global bus I/F
  - Provides a bus bridge for connection to on-chip bus.



# TX19 Family

## Features of TX19 Family

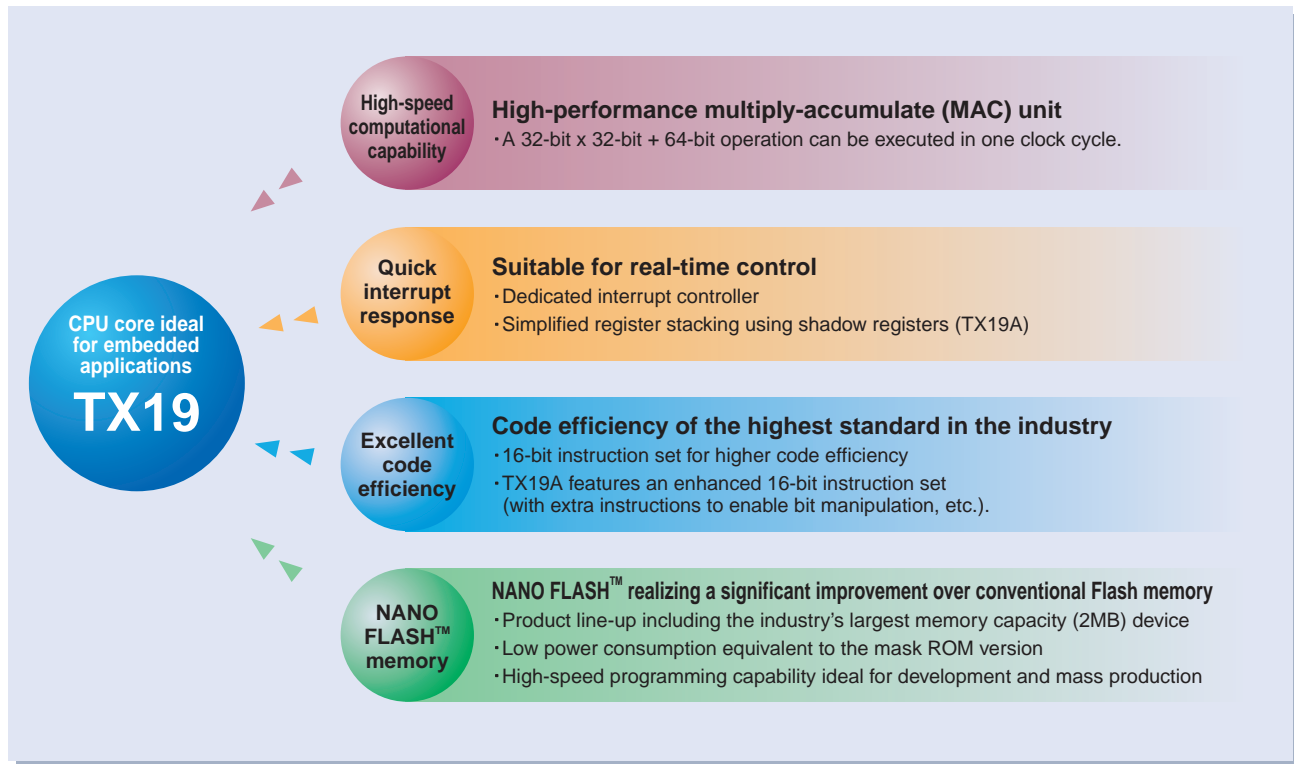

## High-speed computational capability

🔹 The high-performance MAC unit enables a 32-bit x 32-bit + 64-bit operation to be executed in one clock cycle.

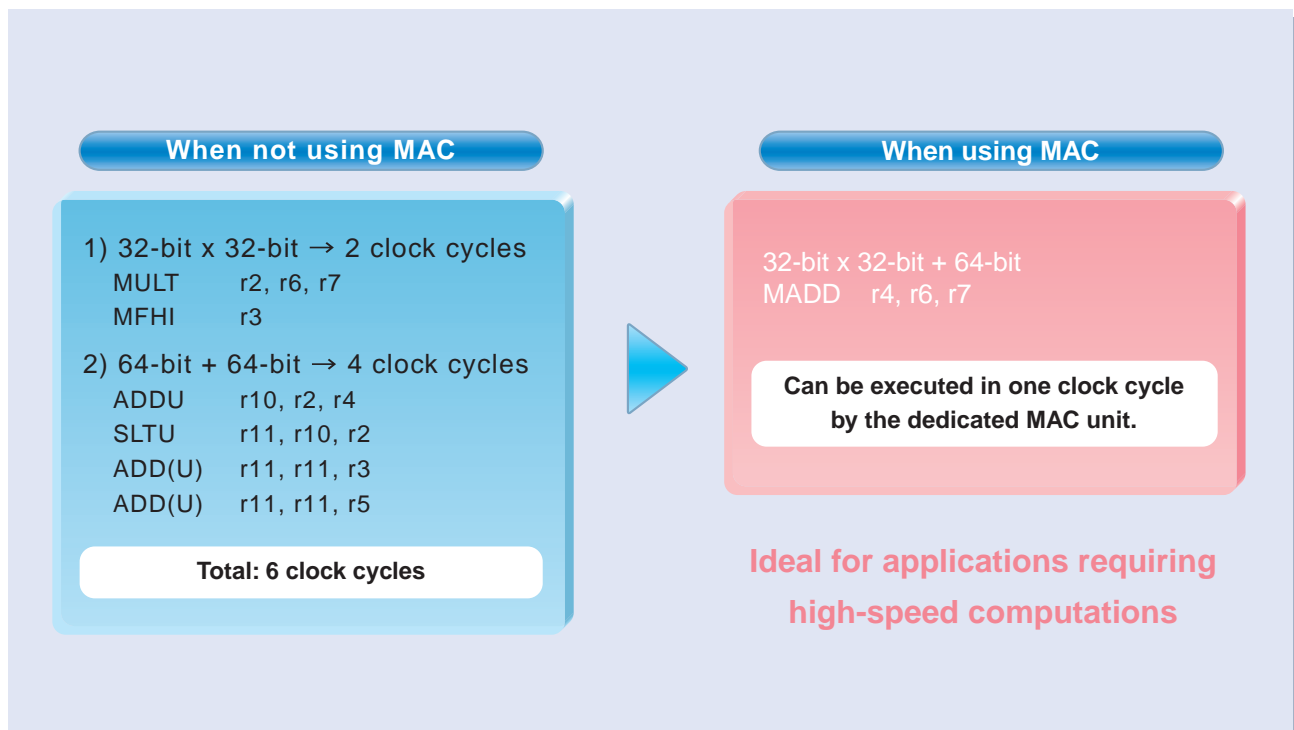

# TX19 Family

## Quick interrupt response

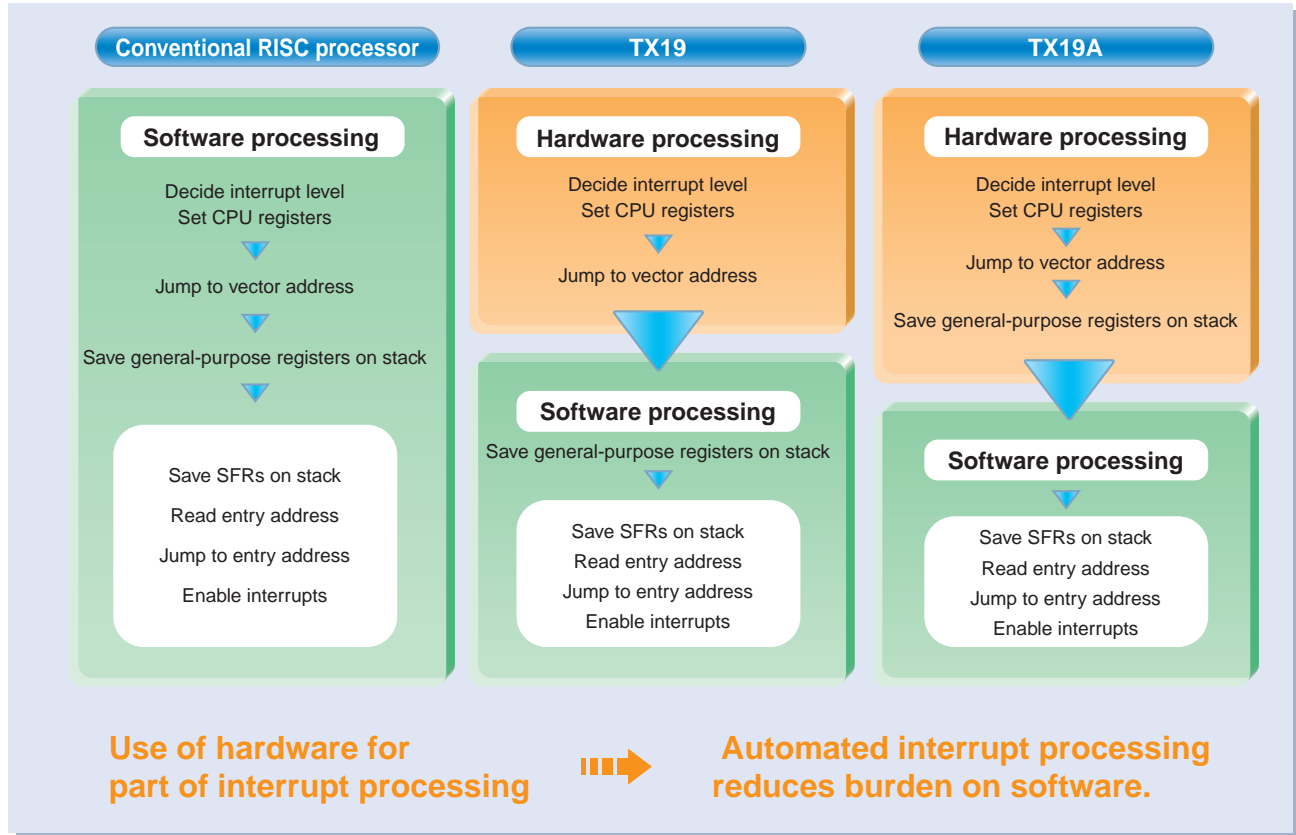

## Excellent code efficiency

The TX19A core features the MIPS16e-TX architecture that realizes enhanced code efficiency and performance.

### MIPS16e-TX

MIPS16e™  
16-/32-bit

Toshiba-defined  
extended instructions  
16-/32-bit

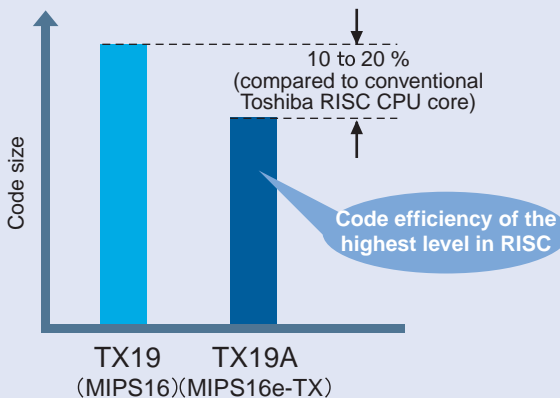

#### Architecture

- New instructions are added to enable bit manipulation, format conversion, and saving/restoring multiple registers.
- Addition of CP0 instructions allows all processing to be performed with only MIPS16e-TX.
- Shadow registers

#### Compiler

- The compiler tailored to TX19A is provided.

Displays outstanding efficiency in control programs heavy with bit operations.

## TX19 Series single-chip microcontroller with NANO FLASH™

# TMP19A43FZXBG

Under development

### Single-chip 32-bit RISC microcontroller for real-time control

The **TMP19A43** is a 32-bit RISC microcontroller based on the **TX19A** core and containing NANO FLASH™, a high-speed AD converter, a large number of external interrupts, and timer/counters. The microcontroller features low-voltage and low-power-consumption operation, making it ideal for battery-driven applications such as portable information equipment for personal use.

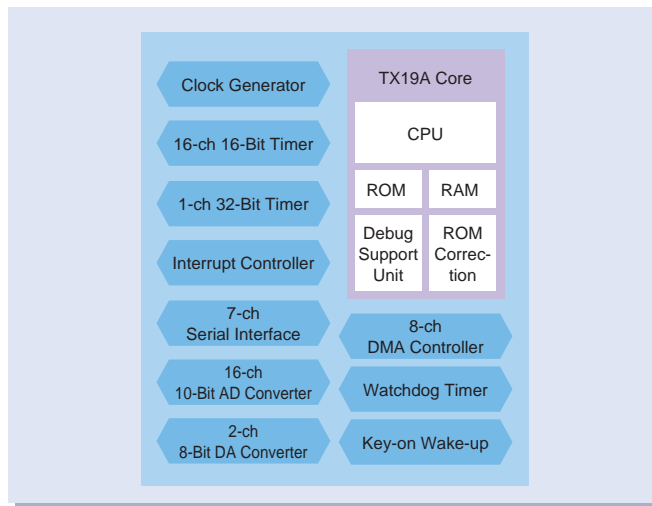

- Internal ROM: Flash 384 Kbytes
- Internal RAM: 20 Kbytes
- Sequential conversion type 10-bit AD converter: 16 channels (conversion time 1.15  $\mu$ s)
- 8-bit DA converter: 2 channels (2.5 V)
- 32-bit timer counter: 1 channel
- Output compare register: 8 channels
- Input capture register: 4 channels
- 16-bit timer counter: 16 channels (Four of the 16 channels are used for a dual-phase pulse input counter)
- UART/SIO: 4 channels (One of the four channels is used for I<sup>2</sup>C/SIO)
- UART/HSIO: 3 channels (10 Mbps)
- DMAC: 8 channels
- ROM correction: 1 word x 8 blocks  
8 words x 4 blocks
- Key-on wake-up: 32 channels
- External interrupt: 48 channels
- Operating temperature: -20 to 85°C
- Maximum operating frequency: 40 MHz (PLL multiplication)
- Internal supply voltage: 1.35 to 1.65 V
- ADC, I/O supply voltage: 2.7 to 3.6 V
- Package: 193-pin FBGA (12 x 12 mm, 0.65-mm pitch, 1.2-mm thick)

## TX19 Series single-chip microcontroller with ROM/RAM

# TMP19A71

Under development

### Single-chip 32-bit RISC microcontroller for inverter control

The **TMP19A71** is a single-chip 32-bit RISC microcontroller, which integrates major features for controlling home electric appliances, including motor control. It is based on the **TX19A** core, an enhanced version of the **TX19** core, which incorporates high-speed ROM and RAM. The **TMP19A71** is ideal for controlling home electric appliances that require energy saving or low vibration/noise.

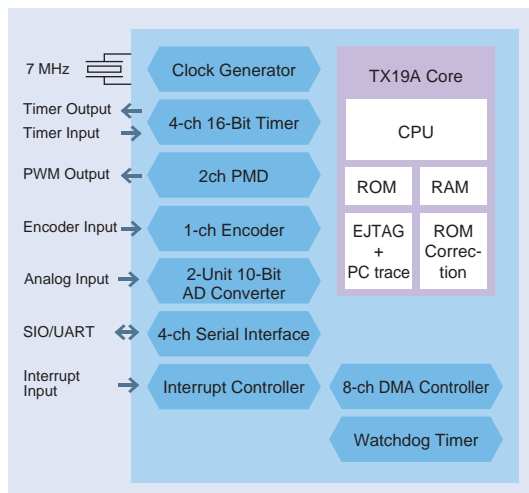

- Internal ROM  
**TMP19A71CYUG/FG:** Mask ROM, 256 Kbytes  
**TMP19A71FYUG/FG:** Flash EEPROM, 256 Kbytes
- Internal RAM: 10 Kbytes
- 3-phase PWM output: 2 channels  
Resolution: 35.7 ns (16 bits)  
Dead time insertion  
Output stop on failure
- Incremental encoder input: 1 channel
- 10-bit AD converter: 2 units  
Analog input: 8 channels + 11 channels  
Conversion time: 2.36  $\mu$ s/channel  
Start synchronization with PWM cycle or timer
- DMA controller: 8 channels
- Interrupt controller: 10 external sources
- 16-bit timer/counter: 4 channels
- Serial interface  
UART: 2 channels  
UART/SIO: 2 channels
- Watchdog timer
- I/O ports: 75 pins
- ROM correction: 8 areas
- Maximum operating frequency: 56 MHz
- Supply voltages:  
**TMP19A71CYUG/FG:** Internal 1.35 to 1.65 V  
I/O 3.0 to 3.6 V  
**TMP19A71FYUG/FG:** Internal 2.3 to 2.7 V  
I/O 3.0 to 3.6 V
- Package: 100-pin QFP  
**TMP19A71CYUG/FYUG:** 14 x 14 mm, 0.5-mm pitch  
**TMP19A71CYUG/FYFG:** 14 x 20 mm, 0.65-mm pitch

# TLCS-900 Family

Suitable for high-performance and multifunctional home appliances, audio equipment and portable devices

The **TLCS-900** Family of 16-bit and 32-bit microcontrollers provides solutions in every application field by offering a wide variety of built-in peripheral functions that can be used in combination with our software IP products. The instruction code compatibility within the **900** Family which ensures a smooth migration from the **TLCS-900/L1** 16-bit to **TLCS-900/H1** 32-bit systems enhances the product line-up strategies.

## TLCS-900 Family core line-up

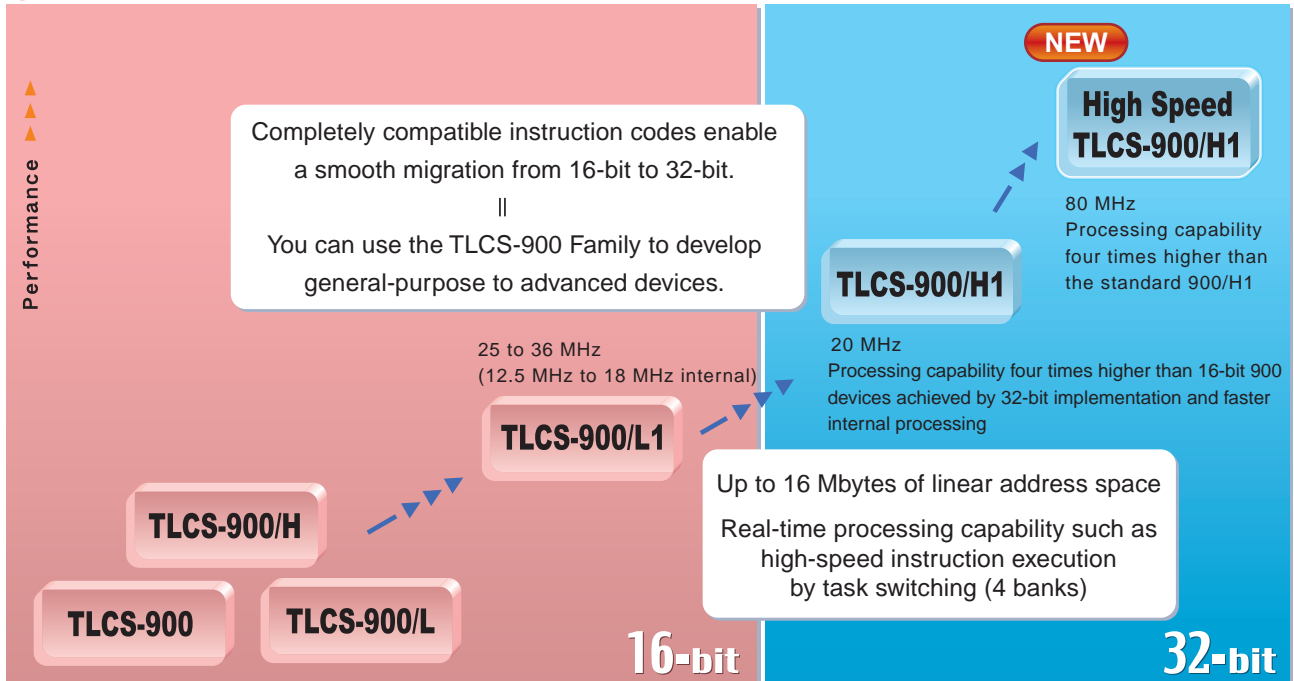

## Processor core features

	900/L Series	900/H Series	900/L1 Series	900/H1 Series	
Maximum internal operating frequency <sup>Note 1)</sup>	10 MHz	12.5 MHz	18 MHz	20 MHz	80 MHz
Minimum instruction execution time	200 ns	160 ns	111 ns	50 ns	12.5 ns
Address space	Up to 16 Mbytes of linear address space (for program and data)				
Data transfer rate (micro DMA)	1.6 μs/2 bytes @20 MHz	0.64 μs/2 bytes @25 MHz	0.44 μs/2 bytes @36 MHz	0.25 μs/4 bytes @20 MHz internal	62.5 ns/4 bytes @80 MHz internal
Operating voltage	5 V/3 V		5 V/3 V/2 V	5 V/3 V	3.3 V, 1.5 V (two power supplies)
Multiplication instruction execution time (16-bit operands, 32-bit result)	2.6 μs	960 ns	666 ns	400 ns	134 ns
Dynamic bus sizing	8-/16-bit			8-/16-/32-bit	

Note 1) Maximum operating frequency varies depending on the product, so please see the "Part Number List" for details.

## Features of TLCS-900 Family

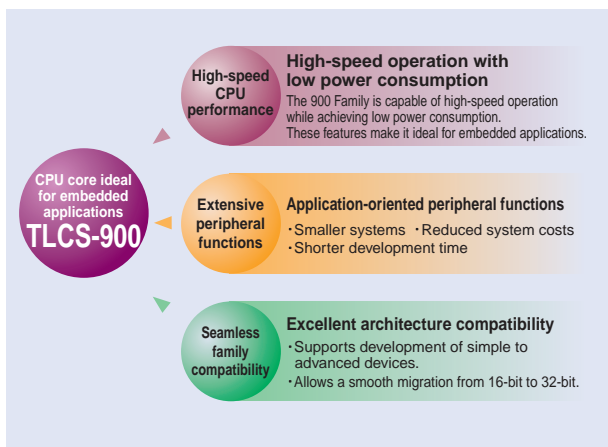

Toshiba offers total solutions including hardware, systems and software.

### Application examples

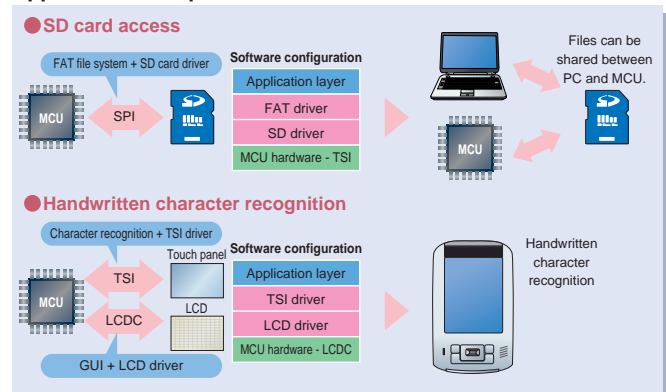



## TLCS-900/H1 Series

# TMP92CY23FG/DFG **NEW** TMP92CD23AFG/DFG Under development

## Single-chip 32-bit microcontrollers with a wide range of built-in I/O functions

The **TMP92CY23** and **TMP92CD23A** are single-chip 32-bit microcontrollers containing a wide range of I/O functions based on the **900/H1** core.

- Internal ROM: **TMP92CY23** 256 Kbytes  
**TMP92CD23A** 512 Kbytes
- Internal RAM: **TMP92CY23** 16 Kbytes  
**TMP92CD23A** 32 Kbytes
- Operating voltage: 3.0 to 3.6 V
- Minimum instruction execution time: 50 ns (internal: 20 MHz)
- SIO/UART: 3 channels\*
- SIO/I<sup>2</sup>C: 2 channels
- 16-bit timer: 2 channels
- 8-bit timer: 6 channels
- 10-bit AD converter: 12 channels
- Key-on-wakeup: 8 channels
- Program patch logic: 8 banks
- Package: **TMP92CY23FG/CD23AFG**: 100-pin LQFP (14 x 14 mm, 0.5-mm pitch)  
**TMP92CY23DFG/CD23ADFG**: 100-pin QFP (14 x 20 mm, 0.65-mm pitch)
- Flash version:  
**TMP92CY23FG/DFG**: **TMP92FY23FG/DFG**  
**TMP92CD23AFG/DFG**: **TMP92FD23AFG/DFG** (Under development)

\*One of the channels in the TMP92CD23A can operate as a high-speed SIO.

This product uses the SuperFlash<sup>®</sup> technology under the license of Silicon Storage Technology, Inc. SuperFlash<sup>®</sup> is a registered trademark of Silicon Storage Technology, Inc.

## High-speed TLCS-900/H1 Series

# TMP92CF29FG Under development

## Highly functional 32-bit microcontroller with color LCD controller, capable of operating at 80 MHz

The **TMP92CF29** is a 32-bit microcontroller incorporating large-capacity RAM (144 Kbytes) housed in a 176-pin LQFP.

- Internal ROM: 8 Kbytes (Boot)
- Internal RAM: 144 Kbytes
- Operating voltage  
Internal : 1.4 to 1.6 V  
I/O : 3.0 to 3.6 V
- Minimum instruction execution time: 12.5 ns (internal: 80 MHz)
- USB device: 1 channel
- Memory management unit: 2.1 GB (max)
- SDRAM controller: 512 Mbits (max)
- Color LCD controller: 65K colors (TFT)/ 262K colors (STN)
- MLC/SLC NAND Flash interface: 2 channels
- DMA controller: 6 channels
- Multiply-accumulate (MAC): 1 channel (32 x 32 + 64 = 64)
- SD card interface: 1 channel (SPI mode)
- I<sup>2</sup>S interface: 1 channel
- SIO/UART: 1 channel
- I<sup>2</sup>C bus: 1 channel
- 8-bit timer/counter: 8 channels
- 16-bit timer/counter: 2 channels
- 10-bit AD converter: 6 channels
- RTC: 1 channel
- Touch screen interface: 1 channel
- Package: 176-pin LQFP (20 x 20 mm, 0.4-mm pitch)

### TLCS-900/H1 Series

## TMP92FD28FG/DFG

NEW

## TMP92CD28FG/DFG

Under development

### Highly functional 32-bit microcontrollers with a USB host controller

The **TMP92FD28** and **TMP92CD28** are 32-bit microcontrollers containing a USB host controller based on the **900/H1** core.

- Internal ROM: 512 Kbytes
- Internal RAM: 32 Kbytes
- Operating voltage: 3.0 to 3.6 V
- Minimum instruction execution time: 50 ns (internal: 20 MHz)
- USB host controller
- UART/SIO: 2 channels
- SBI: 2 channels
- HSIO: 1 channel
- SPI controller: 1 channel
- 8-bit timer: 6 channels
- 16-bit timer: 2 channels
- Key-on wake-up: 4 channels
- Program patch logic: 8 banks
- Package:
  - TMP92FD28FG/TMP92CD28FG:**  
100-pin LQFP (14 x 14 mm, 0.5-mm pitch)
  - TMP92FD28DFG/TMP92CD28DFG:**  
100-pin QFP (14 x 20 mm, 0.65-mm pitch)

This product uses the SuperFlash® technology under the license of Silicon Storage Technology, Inc. SuperFlash® is a registered trademark of Silicon Storage Technology, Inc.

### TLCS-900/L1 Series

## TMP91FW60FG/DFG

NEW

## TMP91CW60FG/DFG

Under development

### 16-bit microcontrollers supporting 5-V operation and a wide range of I/O functions on a single chip

The **TMP91FW60** and **TMP91CW60** are 16-bit microcontrollers that support 5-V operation and incorporate a wide variety of I/O functions on a single chip.

- Internal ROM: 128 Kbytes
- Internal RAM: 8 Kbytes
- Operating voltage: 4.5 to 5.5 V
- Minimum instruction execution time: 200 ns (internal: 20 MHz)
- SIO/UART: 3 channels
- I<sup>2</sup>C/SIO: 2 channels
- 8-bit timer/counter: 6 channels
- 16-bit timer/counter: 5 channels
- 10-bit AD converter: 16 channels
- Program patch logic: 6 banks
- Package:
  - TMP91FW60FG/TMP91CW60FG:**  
100-pin LQFP (14 x 14 mm, 0.5-mm pitch)
  - TMP91FW60DFG/TMP91CW60DFG:**  
100-pin QFP (14 x 20 mm, 0.65-mm pitch)

This product uses the SuperFlash® technology under the license of Silicon Storage Technology, Inc. SuperFlash® is a registered trademark of Silicon Storage Technology, Inc.

# TLCS-870 Family

## 8-bit microcontrollers suitable for a wide range of consumer products such as home appliances, communications devices and inverter-controlled equipment

The **TLCS-870** Family consists of 8-bit microcontrollers developed for consumer applications such as home appliances, TVs, audio equipment, tele-phones, motor control and lighting devices. The product line-up includes microcontrollers incorporating various functions to suit these applications, including an AD converter, LCD driver, UART, on-screen display circuit, IGBT controller and PMD circuit. The **870** Family also offers products featuring low-voltage, low-power-consumption and low-noise operation that are suitable for portable equipment and many other applications. The **870** Family has been reinforced by the **TLCS-870/C1** Series which delivers enhanced processing capability and upgraded low-voltage and low-power-consumption features such as on-chip Flash memory, a voltage detecting circuit and a power-on reset circuit.

### Toshiba microcomputer core line-up

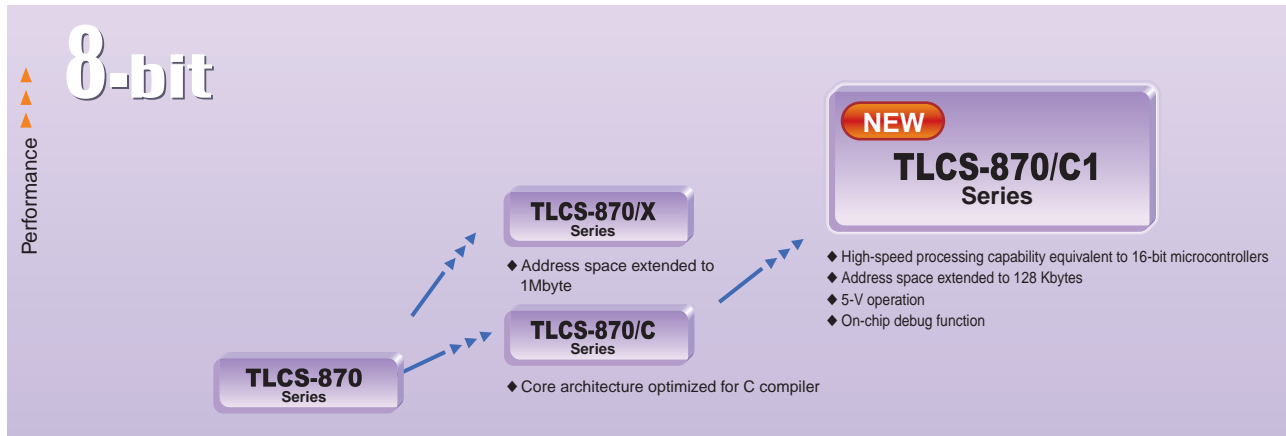

### Processor core features

	870/C Series	870/X Series	870 Series	870/C1 Series
Maximum operating frequency	16 MHz	20 MHz	8 MHz	8 MHz
Minimum instruction execution time	0.25 μs/0.167 μs	0.2 μs	0.5 μs	0.125 μs
Address space	64 Kbytes	1 Mbyte	64 Kbytes	128 Kbytes
Interrupt vector (max)	31	63	15	52
Instruction set	731 instructions	842 instructions	412 instructions	732 instructions
Operating voltage range (typ.)	1.8 to 5.5 V	2.7 to 5.5 V	2.7 to 5.5 V/6.0 V	2.7 to 5.5 V

## Features of TLCS-870 Family

### Register configuration NEW

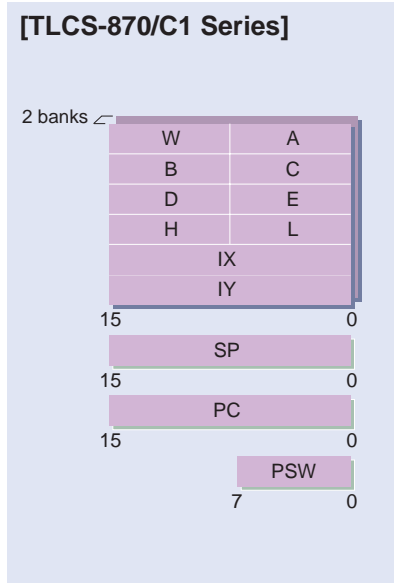

### Memory management method (segment method) NEW [TLCS-870/C1 Series]

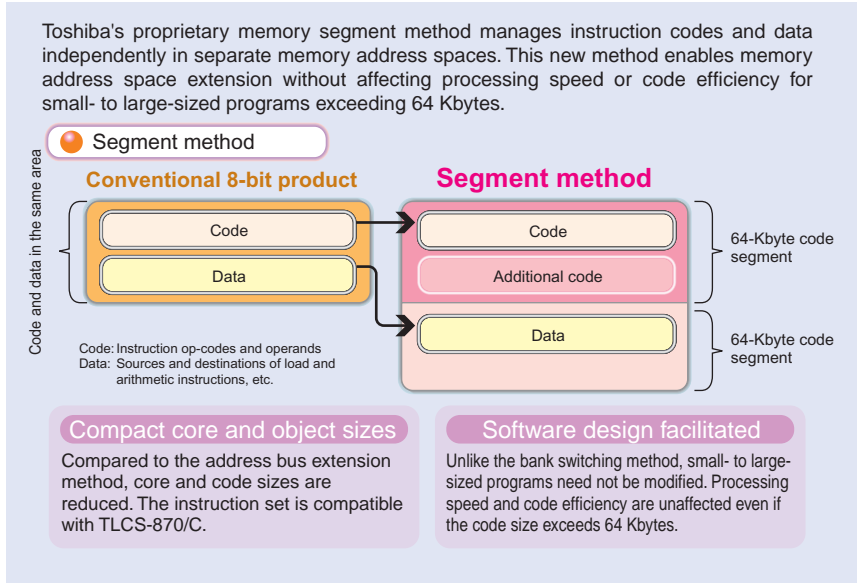

# TLCS-870 Family

## One instruction cycle operated in a single clock cycle NEW [TLCS-870/C1 Series]

The core architecture is configured to reduce the number of clock cycles required to complete one machine cycle to a single clock cycle. This achieves processing performance four times that of TLCS-870/C Series at the same internal clock frequency.

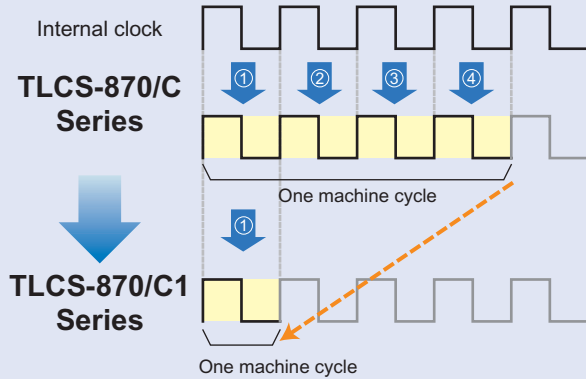

TLCS-870/C1 Series: Minimum instruction execution time of 125 ns  
 TLCS-870/C Series: Minimum instruction execution time of 250 ns  
 \*The minimum instruction execution time is reduced by half compared to TLCS-870/C.

## 870/C1 Series road map (planned) NEW

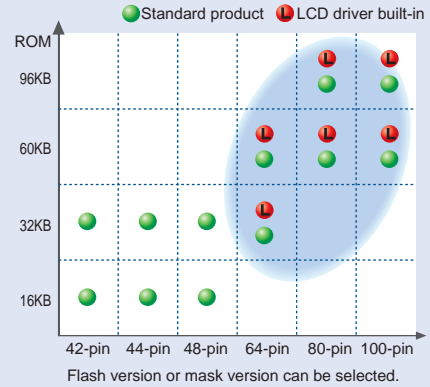

Packages:

UG: 64-pin LQFP (10 mm x 10 mm/0.50-mm pitch)  
 FG: 64-pin QFP (14 mm x 14 mm/0.80-mm pitch)

Part Number	ROM	RAM
<b>TMP89CM60UG/FG<sup>++</sup></b>	32 KB	3.0 KB
<b>TMP89CS60UG/FG<sup>++</sup></b>	60 KB	3.0 KB
<b>TMP89FS60UG/FG<sup>**</sup></b>	60 KB	3.0 KB

\*\* : Under development    ++ : Under planning

## Noise reduction measures

The TLCS-870 Family implements various measures for improving noise immunity.

### Separate power supplies

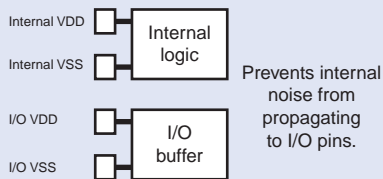

- Separate power supplies are used for internal logic and I/O.
- Internal EMI noise can be prevented from propagating to I/O pins.

### Decoupling capacitor

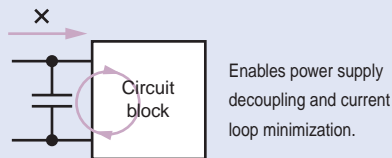

- A decoupling capacitor is attached to the noise source.
- High-frequency currents directly flowing to power supply lines can be reduced.
- Spurious noise can be suppressed by minimizing current loops created by circuit operations.

### Optimized pin layout

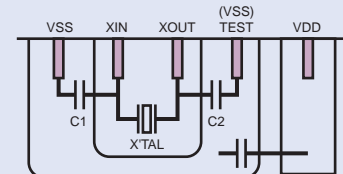

- Oscillator pins are guarded by GND pins.
- Spurious noise from oscillator pins can be suppressed.

### Oscillator protection

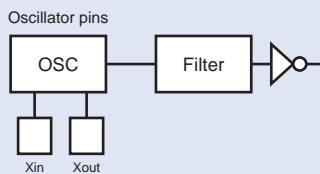

- High-frequency noise can be eliminated by placing a noise filter.

### Noise filter

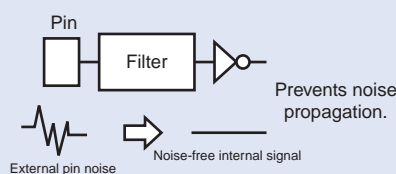

- Spike noise can be eliminated.



## TLCS-870/C1 Series

# TMP89FS60UG/FG

Under development

### 8-bit microcontroller based on the new 870/C1 core realizing enhanced functionality and performance

The **TMP86FS60** is an 8-bit microcontroller based on the new **870/C1** core that achieves processing capability four times higher than our popular high-performance **870/C** Series (at the same internal clock frequency). This new microcontroller contains large-capacity Flash memory, a voltage detecting circuit, a power-on reset circuit, various serial interfaces and timer/counters. In addition to the standard real-time emulator, the **TMP86FS60** also supports on-board debugging to enhance development efficiency and product quality.

- Internal ROM: 60 Kbytes (Flash)
- Internal RAM: 3 Kbytes
- I/O ports: 56 pins
- Operating voltage: 2.7 to 5.5 V
- Minimum instruction execution time:
  - 0.125  $\mu$ s (8 MHz/4.5 to 5.5 V)
  - 0.24  $\mu$ s (4.2 MHz/2.7 to 5.5 V)
  - 122  $\mu$ s (32.768 kHz/2.7 to 5.5 V)
- 10-bit AD converter: 16 channels
- Serial interface
  - UART/SIO: 2 channels
  - I<sup>2</sup>C/SIO: 1 channel
  - UART: 1 channel

\* Up to two SIO channels can be used simultaneously.
- Timer/counter
  - 16-bit: 2 channels
  - 8-bit: 4 channels
- Voltage detecting circuit (two voltage levels detectable)
- Power-on reset circuit
- Key-on wake-up: 8 channels
- Package:
  - TMP89FS60UG: 64-pin LQFP** (10 x 10 mm, 0.50-mm pitch)
  - TMP89FS60FG: 64-pin QFP** (14 x 14 mm, 0.80-mm pitch)

This product uses the SuperFlash<sup>®</sup> technology under the license of Silicon Storage Technology, Inc. SuperFlash<sup>®</sup> is a registered trademark of Silicon Storage Technology, Inc.

## TLCS-870/C Series

# TMP86FH09NG/809NG/409NG

NEW

### 8-bit Flash microcontroller in a compact package suitable for home appliances and control equipment

The **TMP86FH09**, **TMP86F809** and **TMP86F409** are follow-up products to our popular **TMP86C807/808**. These new microcontrollers offer enhanced usability by incorporating a 10-bit AD converter and Flash memory.

- Internal ROM: 16 K/8 K/4 Kbytes (Flash)
- Internal RAM: 512 Kbytes
- I/O ports: 26 pins
- Operating voltage: 2.7 to 5.5 V
- Minimum instruction execution time:
  - 0.25  $\mu$ s (16 MHz/4.5 to 5.5 V)
  - 0.50  $\mu$ s (8 MHz/2.7 to 5.5 V)
  - 122  $\mu$ s (32.768 kHz/2.7 to 5.5 V)
- 10-bit AD converter: 6 channels
- Serial interface
  - 8-bit SEI: 1 channel
  - UART: 1 channel
- Timer/counter
  - 16-bit: 1 channel
  - 8-bit: 2 channels
- Key-on wake-up: 4 channels
- Package: 32-pin SDIP

This product uses the SuperFlash<sup>®</sup> technology under the license of Silicon Storage Technology, Inc. SuperFlash<sup>®</sup> is a registered trademark of Silicon Storage Technology, Inc.

# TLCS-870 Family

TLCS-870/C Series device with power-on reset and voltage detecting circuits

## TMP86FH92IDMG

Under development

### 8-bit microcontroller incorporating a power-on reset circuit and a voltage detecting circuit

The **TMP86FH92I** is an 8-bit microcontroller that incorporates synchronous and asynchronous serial interfaces, a power-on reset circuit and a voltage detecting circuit. The mask ROM version is also being planned.

- Internal ROM: 16 Kbytes
- Internal RAM: 512 bytes
- Minimum instruction execution time:
  - 0.25  $\mu$ s (16 MHz/4.0 to 5.5 V)
  - 0.50  $\mu$ s (8 MHz/3.0 to 5.5 V)
- Operating voltage: 4.5 to 5.5 V (16 MHz)  
3.0 to 5.5 V (8 MHz)
- UART: 1 channel
- I<sup>2</sup>C/SIO: 1 channel
- SEI: 1 channel
- 10-bit AD converter: 6 channels
- Package: 30-pin SSOP
- Power-on reset circuit
- Voltage detecting circuit (two voltage levels detectable)

This product uses the SuperFlash<sup>®</sup> technology under the license of Silicon Storage Technology, Inc. SuperFlash<sup>®</sup> is a registered trademark of Silicon Storage Technology, Inc.

# T4X Series / T6H Series

## Application for personal usage

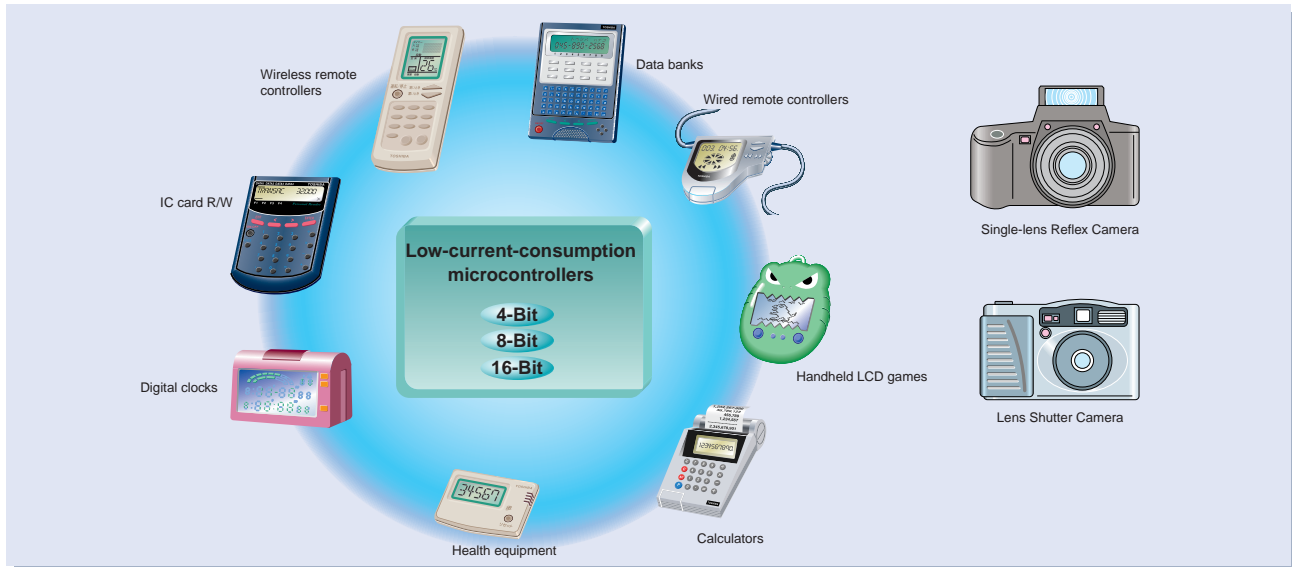

## T4X Series

### Reduce development time and total cost down

Target system: Battery usage product with LCD

(Calculator, Watch, Health equipment, Remote controller, LCD game and Toys etc.)

- High performance CPU: T4X CPU built-in special architecture that means 2 clocks needs to 1 execute instruction.
- Low power consumption: T4X's low power consumption make possible long time operation of the equipment run on battery.
- Low voltage operation: Memory, LCD driver, I/O and the other peripheral circuits required for hand held equipment are integrated on 1 chip.
- Dice form: All T4X family can be supplied in dice form.

### T4X Series Line-up

	TMP04030	TMP04070	TMP04081	TMP04100	T6F36	T6F42
CPU	T4X	T4X	T4X	T4X	T4X	T4X
ROM	32 KW	16 KW	32 KW	64 KW	24 KW	52 KW
Work RAM	4 K bits	2 K bits	2 K bits	4 K bits	4 K bits	4 K bits
Data RAM	4 K bits	6 K bits	16 K bits	4 K bits	-	-
I/O port	18 ch	17 ch	17 ch	20 ch	18 ch	18 ch
LCD driver (Built-in regulator)	64SEG x 16COM	60SEG x 8COM 58SEG x 10COM	60SEG x 8COM 60SEG x 10COM	60SEG x 16COM	50SEG x 15COM	50SEG x 15COM
Timer/Counter	8 bit x 2 ch or 16 bit x 1 ch	8 bit x 2 ch or 16 bit x 1 ch	8 bit x 2 ch or 16 bit x 1 ch	8 bit x 2 ch or 16 bit x 1 ch	8 bit x 2 ch	8 bit x 2 ch
Buzzer circuit	-	1 ch	1 ch	-	1 ch	1 ch
Melody circuit	1 ch	-	-	1 ch	-	-
SIO	1 ch	-	-	-	-	-
UART	-	-	-	-	1 ch	1 ch
USB	-	-	-	○(ver1.1)	-	-
External SRAM I/F	-	-	-	○	○	○
External LCDD I/F	-	-	-	○	○	○
Operating voltage	2.5 to 3.5 V	1.2 to 1.8 V or 2.4 to 3.6 V	1.2 to 1.8 V	2.5 to 3.5 V	1.8 to 3.5 V	1.8 to 3.5 V
Package	Dice (117 pad)	QFP100pin Dice	Dice (102-pin)	Dice (121-pin)	Dice (132-pin)	Dice (132-pin)

# T4X Series / T6H Series

## T6H Series

### Reduce development time and total cost down

Target system: Battery usage product with LCD

(Compact camera, Health equipment, Home appliance, Remote controller, Toys etc.)

- **Low voltage & Low power consumption for battery use application**
  - Operation voltage: 1.8 to 5.5V
  - Low power consumption: IQD < 15  $\mu$ A (@V<sub>DD</sub> = 5.0 V, LCD display ON)
  - Low power oscillator: Low speed clock 32.768 kHz
  - Low power regulator (Regulator for LCD driver, regulator for oscillator)
- **Built-in logic circuits to reduce software development time**
  - Blinking operation for LCD, External interrupt ports for SW with sampling detection
- **Built-in analog circuits for actuator control**
  - 8-bit AD Converter, 8-bit DA Converter
  - Comparator with variable detected level
  - Motor drive control with pre-drives

### T6H Series Line-up

	T6H82C	T6H87
CPU	TLCS-870/C	TLCS-870/C
ROM	32 KB	24 KB
RAM	1 KB	1 KB
I/O port	64	44
LCD driver (Built-in regulator/Charge-pump)	40SEG x 4COM	24SEG x 4COM
8-bit ADC	Input 8 ch (Internal 1 ch)	Input 8 ch (Internal 1 ch)
8-bit DAC	Output 2 ch (Internal 2 ch)	Output 2 ch (Internal 2 ch)
16-bit timer/counter	1 ch	1 ch
8-bit timer/counter	4 ch	4 ch
SIO	1 ch	1 ch
UART	1 ch	1 ch
External interrupt	12 ch	8 ch
Motor pre-driver	1.5 ch (P-ch/N-ch open drain x 3 ch)	1.5 ch (P-ch/N-ch open drain x 3 ch)
Operating voltage	1.8 to 5.5 V	1.8 to 5.5 V
Package	TQFP100pin Dice	LQFP80pin Dice
None volatile (NV) type	EEPROM (T6H83C)	EEPROM (T6H88)



# Development System

## Toshiba Semiconductor Website

<http://www.semicon.toshiba.co.jp/eng/index.html>

Information on the entire spectrum of Toshiba semiconductor products is available here.



## Toshiba Microcomputer Website

<http://www.semicon.toshiba.co.jp/eng/prd/micro/index.html>

A line-up of Toshiba microcomputer products and the latest technical information on products are presented here.



## Toshiba Microcomputer Development System Product Website

This website provides the latest information on Toshiba microcomputer development system products. To suit the different aims of visitors, the website includes the pages for examining customers and current users.

### Page for Examining Customers

- A system developed for each Family and Series of products is available.
- A list of third-party tools supported for each vendor can be viewed.

### User Registration

Once you have completed user registration on our New User Registration page, you will be issued with a user ID and password for accessing the user page.

### Page for Users

- You can see new product information and receive updates to the products you currently use.
- You can access technical information and helpful information on product usage.
- You can download the following latest data and resources:
  - Software product
  - Instruction manual PDF files
  - Operation manual PDF files
  - Firmware



# Outline of TX19 Family Development System

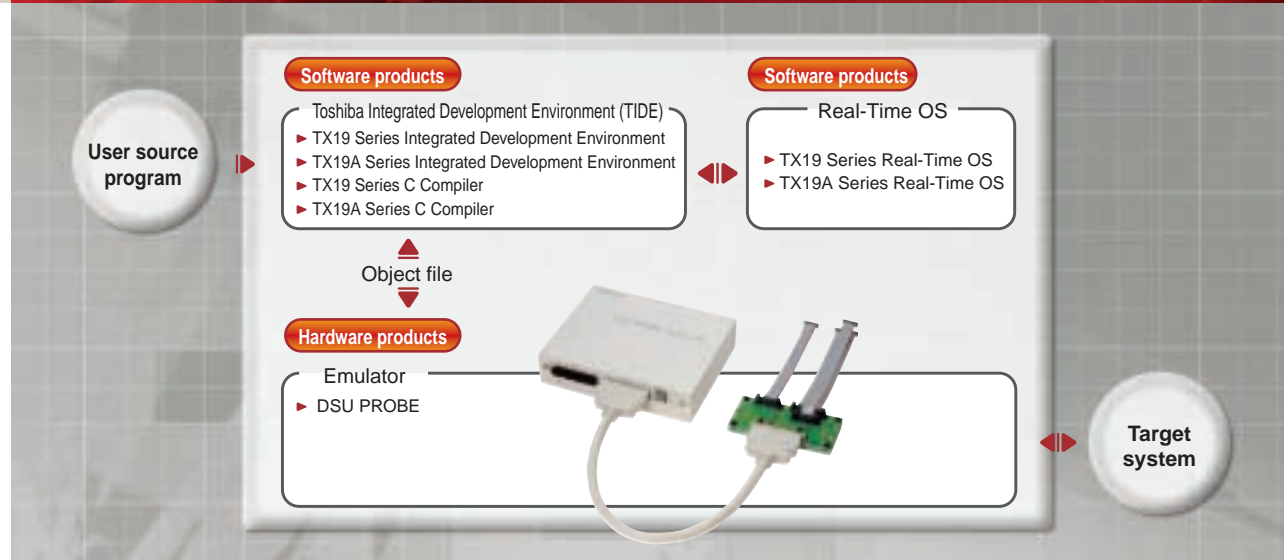

## Toshiba Integrated Development Environment (TIDE)

\* The term "Toshiba Integrated Development Environment (TIDE)" refers collectively to the TX19 Family Integrated Development Environment and the TX19 Family C-Compiler.

### 【TX19 Family Integrated Development Environment】

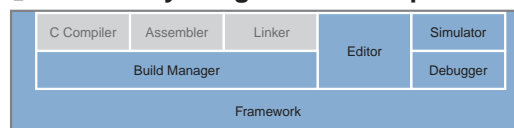

With individual development tools such as Editor, Build Manager, Compiler and Debugger integrated into one, the Integrated Development Environment enables seamless operations of coding, building and debugging tasks which must be performed repeatedly in the software development process. It also contains a simulator for simulating MCU operations for logical debugging, and a debug function supporting real-time OS. TX19 Series version and TX19A Series version are available.

### 【TLCS-900 Family C Compiler】

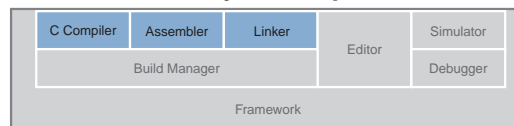

The C Compiler package containing C Compiler, Assembler and Linker allows you to generate object files such as HEX files from source code written in C or assembly language. It conforms to the ANSI C standard and offers excellent descriptiveness and portability. A wide range of options are provided to improve code efficiency and RAM utilization. This product is used in combination with the TX19 Family Integrated Development Environment. TX19 Series version and TX19A Series version are available.

## Real-Time OS

Software used to control multitasking in embedded systems.

- Conforms to  $\mu$ ITRON specifications.
- Ample system calls required for embedded systems.
- Use of the configuration tool facilitates data setting of timer, task, etc.
- Offered in two versions: object version and object & source version. The object & source version allows users to modify the source programs.

	TX19 Series		TX19A Series	
	Object version	Object & source version	Object version	Object & source version
$\mu$ ITRON specifications	$\mu$ ITRON 3.0 specifications		$\mu$ ITRON 4.0 specifications	
Source programs	Not included	Included	Not included	Included
Configuration tool	TR Configurator		TRcEditor	

## Emulator

DSU PROBE is an on-board emulator that enables efficient debugging. It provides emulation and debugging features that are useful for developing application programs by being connected to the target system and operated from the debugger on a PC.



TX19 Series emulator  
**DSU PROBE for N-WIRE**  
Includes a debugger specifically tailored to the TMP1940/42. For development work using other MCUs, you need to purchase the TX19 Series Integrated Development Environment.



TX19A Series emulator  
**DSU PROBE model 110/120**  
model 120 is a higher-end product to model 110. Includes the TX19A Series Integrated Development Environment without simulator function (downloadable from our website).

## Development system configuration examples

The basic development system environment for the TX19 Family is summarized below. The specified values are the recommended values for comfortable use. For the minimum operating environment, check with the product manual of each development system product.

**【Host machine】**

- OS: Windows 2000/XP
- Host machine CPU: Pentium 4 1 GHz or faster (recommended)
- Memory: 512 MB or larger (recommended)
- Display resolution: 1280 x 1024 or higher
- Extended I/O port: 1 port (RS-232C) (TX19A only)
- Expansion slots: 1 port (for LAN card)

**【Hub】**

- Ethernet hub
- Support for 10BASE-T
- Conformance to IEEE 802.3 Ethernet standard

**【LAN expansion card for PC】**

- Ethernet network interface card
- Support for 10BASE-T
- Conformance to IEEE 802.3 Ethernet standard

**【LAN cable】**

- Twisted-pair cable

**【Connection example】**  
An appropriate connector with DSU PROBE must be soldered on the target board.

**TX19 series**

DSU PROBE for N-Wire system

**Products required for minimal system**  
【Toshiba Integrated Development Environment (TIDE)】

- TX19 Series Integrated Development Environment .....1
- TX19 Series C Compiler .....1

【Emulator】

- DSU PROBE for N-WIRE .....1

**Other required products**

- Windows PC .....1
- LAN expansion card for PC .....1
- Hub .....1
- RS-232C cross cable .....1
- LAN cable .....2

**Target connectors**

- 20-pin half-pitch plug 104068-1 from AMP .....1
- 20-pin half-pitch plug FTSH-110-01-F-D-K from SAMTEC .....1

**TX19A series**

DSU PROBE model 110 system

**Products required for minimal system**  
【Toshiba Integrated Development Environment (TIDE)】

- TX19A Series Integrated Development Environment .....1
- TX19A Series C Compiler .....1

【Emulator】

- DSU PROBE model 110 .....1

**Other required products**

- Windows PC .....1
- LAN expansion card for PC .....1
- Hub .....1
- RS-232C cross cable .....1
- LAN cable .....2

**Target connectors**

- 20-pin half-pitch plug FTSH-110-01-F-D-K from SAMTEC .....1
- 34-pin half-pitch plug FTSH-117-01-F-D-K from SAMTEC .....1

**TX19A series**

DSU PROBE model 120 system

**Products required for minimal system**  
【Toshiba Integrated Development Environment (TIDE)】

- TX19A Series Integrated Development Environment .....1
- TX19A Series C Compiler .....1

【Emulator】

- DSU PROBE model 120 .....1

**Other required products**

- Windows PC .....1
- LAN expansion card for PC .....1
- Hub .....1
- RS-232C cross cable .....1
- LAN cable .....2

**Target connectors**

- 20-pin half-pitch plug FTSH-110-01-F-D-K from SAMTEC .....2
- 34-pin half-pitch plug FTSH-117-01-F-D-K from SAMTEC .....1

\* For part numbers, see "PART NUMBER LIST" or our Development System website.

## Basic performance

System name	TX19 Series		TX19A Series	
	DSU PROBE for N-Wire system		DSU PROBE model 110 system	DSU PROBE model 120 system
<b>Host interface</b>	Ethernet, RS-232C		Ethernet, RS-232C	
<b>Events</b>	<b>Number of points</b>	Instruction: 4 points, Data: 1 point <sup>(Note 1)</sup>	Instruction: 8 points, Data: 4 point	
	<b>Comparison items</b>	Address, data, status, external input	Address, data, status, external input	
	<b>Comparison conditions</b>	Match	Match	
	<b>Pass count</b>	Once	Once	1 to 256 times
	<b>Event trigger actions</b>	Break, trace control, timer control, external trigger output	Break, trace control, timer control, external trigger output, external pulse output, memory write	OR, sequential
<b>Break</b>	<b>Hardware break</b>	4 points <sup>(Note 1)</sup>	8 points	
	<b>Software break</b>	256 points (settable only on RAM)	256 points (settable only on RAM)	
<b>Trace memory</b>	<b>Capacity</b>	4K frames	4K frames	128K frames
	<b>Trace modes</b>	Free trace, trigger trace, overflow stop	Free trace, trigger trace, overflow stop	
	<b>Trace items</b>	PC address, status, tag timer	PC address, status, tag timer	PC address, data address, data value, status, tag timer
<b>External output</b>	4 lines			
<b>Timer measurement</b>	Run timer: 1 channel	Lap timer: 1 channel	Run timer: 1 channel	Lap timer: 1 channel Lap timer: 4 channels (max., min., average, count)
<b>Memory access</b>	Memory display during program execution Memory rewrite during program execution		Variables: 16-byte area x 32, Memory: Up to 1024 bytes 4 bytes x 4 blocks can be written simultaneously.	
<b>Program variables</b>	<b>Display</b>	Binary, octal, decimal or hexadecimal display can be selected for each variable.		
	<b>Registration</b>	Variables, arrays, structures and unions can be registered by the elements.		
<b>Source display</b>	<ul style="list-style-type: none"> <li>● Source</li> <li>● Source + assembler code</li> <li>● Source + assembler code + machine language</li> </ul>			
<b>Flash programming/security feature</b>	Internal/external Flash memory can be programmed during debugging. <sup>(Note 2)</sup>			
<b>External input</b>	1 line			

Note 1: Varies with the MCU to be used. Note 2: Some MCUs do not support this feature.



# Outline of TLCS-900 Family Development System

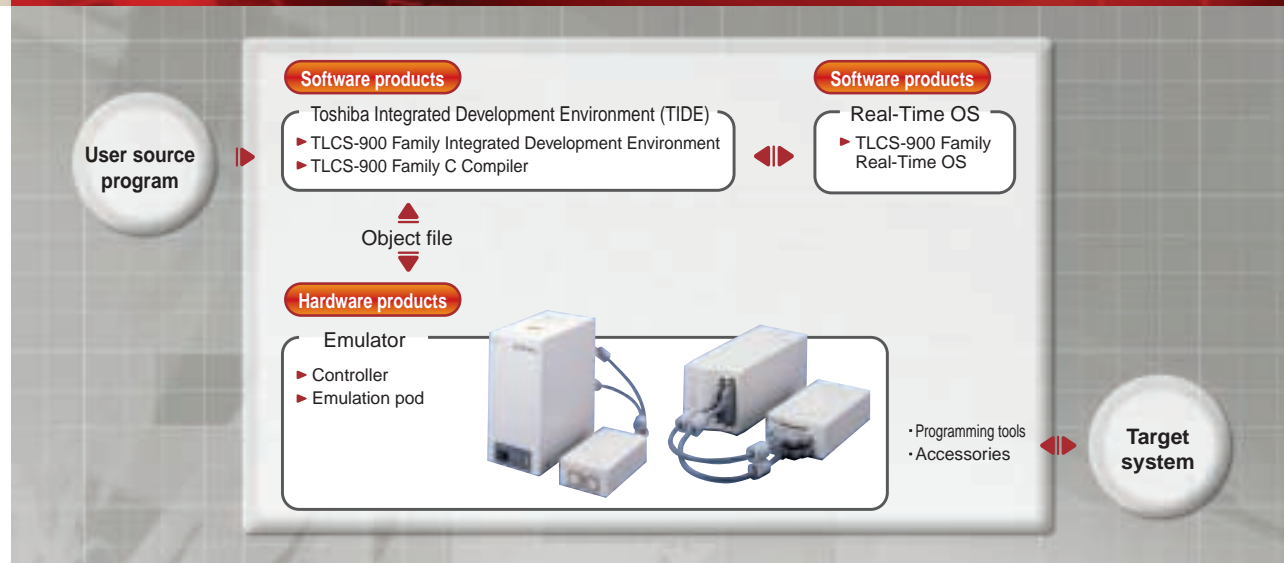

## Toshiba Integrated Development Environment (TIDE)

\* The term "Toshiba Integrated Development Environment (TIDE)" refers collectively to the TLCS-900 Family Integrated Development Environment and the TLCS-900 Family C Compiler.

### 【TLCS-900 Family Integrated Development Environment】

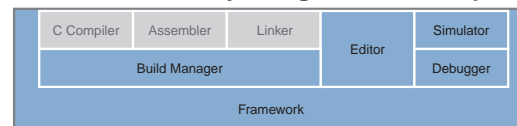

With individual development tools such as Editor, Build Manager, Compiler and Debugger integrated into one, the Integrated Development Environment enables seamless operations of coding, building and debugging tasks which must be performed repeatedly in the software development process. It also contains a simulator function for simulating MCU operations for logical debugging, and a debug function supporting real-time OS.

### 【TLCS-900 Family C Compiler】

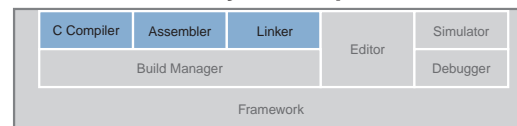

The C Compiler package containing C Compiler, Assembler and Linker allows you to generate object files such as HEX files from source code written in C or assembly language. It conforms to the ANSI C standard and offers excellent descriptiveness and portability. A wide range of options are provided to improve code efficiency and RAM utilization. This product is used in combination with the TLCS-900 Family Integrated Development Environment.

## Real-Time OS

Software used to control multitasking in embedded systems.

- Conforms to  $\mu$ ITRON specifications.
- Ample system calls required for embedded systems.
- Use of the TR Configurator facilitates data setting of timer, task, etc.
- The TR Editor can be used to describe task operations graphically and to generate program outlines.
- Offered in two versions: object version and object & source version. The object & source version allows users to modify the source programs.

### TLCS-900 Family Real-Time OS $\mu$ ITRON 3.0 specifications

Object version		Object & source version	
Object code	Object code	Object code	Object code
Source programs	Source programs	Source programs	Source programs
TR Configurator	TR Configurator	TR Configurator	TR Configurator
TR Editor	TR Editor	TR Editor	TR Editor

## Emulator

### 【RTE900 model 15 system】

The model 15 system is a low-cost version of the model 25 system that is realized by offering the minimum functionality required for development work and an extensive use of gate arrays.

### 【RTE900 model 25 system】

The model 25 system features enhanced hardware that enables faster processing to support high-speed and high-functionality MCUs and provide advanced debug capability such as performance analysis.



RTE900 model 25 system

RTE900 model 15 system

\* A combination of the model 25 controller and the model 15 emulation pod is also possible.

## Development system configuration examples

The basic development system environment for the TLCS-900 Family is summarized below. The specified values are the recommended values for comfortable use. For the minimum operating environment, check with the product manual of each development system product.

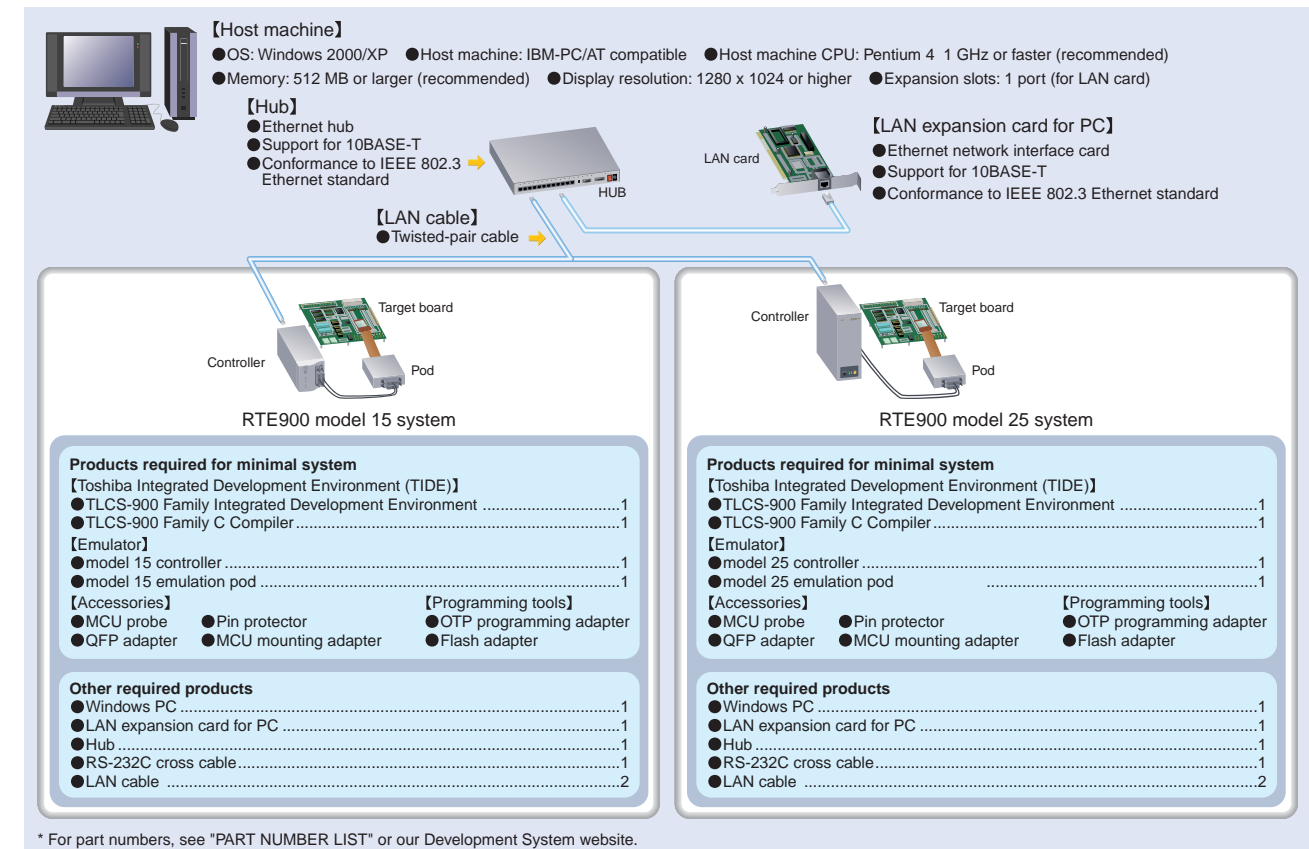

\* For part numbers, see "PART NUMBER LIST" or our Development System website.

## Basic performance

System name	TLCS-900/H1 Series <sup>(Note 1)</sup>		TLCS-900, 900/H, 900/L, 900/L1 Series	
	model 15 system	model 25 system	model 15 system	model 25 system
<b>Host interface</b>	Ethernet, RS-232C			
<b>Emulation memory</b>	<b>Capacity</b>		1 Mbytes	4 Mbytes
	<b>Number of points</b>		8 points	
<b>Events</b>	<b>Comparison items</b>		Address, data, status	Address, data, status, external input
	<b>Comparison conditions</b>		Match, unmatched, within scope	
	<b>Pass count</b>		1 to 65535 times	
	<b>Event trigger actions</b>		Break, trace control, timer control, external trigger output	
<b>Break</b>	<b>Event combinations</b>		AND, OR, sequential	
	<b>Hardware break</b>	4 points	3 points	
<b>Trace memory</b>	<b>Software break</b>	1024 points	1024 points	
	<b>Capacity</b>	8K frames	8K frames	
<b>Trace modes</b>	Free trace, trigger trace, sampling trace, overflow stop			
	<b>Trace items</b>	PC address, data address, data value, status, external output, external input, tag timer, event		PC address, data address, data value, status, external input, tag timer, event
<b>External output</b>				
Timer measurement				
<b>Memory access</b>	Run timer: 1 channel, Lap timer: 1 channel		Run timer: 1 channel, Lap timer: 1 channel	
	<b>Memory display during program execution</b>	128 bytes	32 bytes	
<b>Program variables</b>	<b>Display</b>		Binary, octal, decimal or hexadecimal display can be selected for each variable.	
	<b>Registration</b>		Variables, arrays, structures and unions can be registered by the elements.	
<b>Source display</b>				
<b>External input</b>	● Source		● Source	
	● Source + assembler code		● Source + assembler code	
<b>Performance analysis</b>	● Source + assembler code + machine language		● Source + assembler code + machine language	
	<b>Time measurement per module</b>		1 line	16 line
<b>Coverage measurement</b>	Max., min, average, count, dispersion		Max., min, average, count, dispersion	
	C0 coverage		C0 coverage	

Note 1: When you are using a device whose part number starts with TMP92.

# Outline of TLCS-870 Family Development System

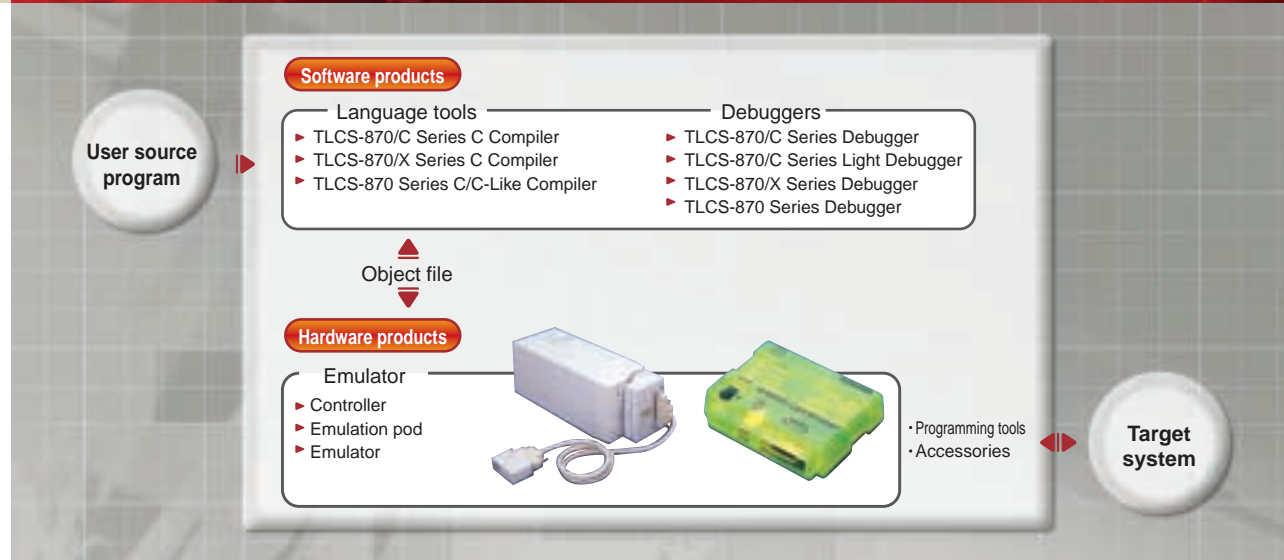

## 【Language Tools】

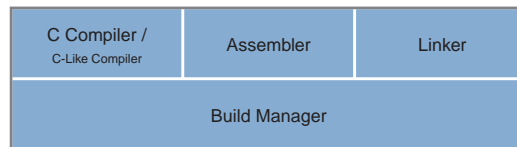

These software tools containing C Compiler, Assembler and Linker allow you to generate object files such as HEX files from source code written in C, C-Like(\*) or assembly language.

(\*) Supported only with the TLCS-870 Series.

- Build Manager with user-friendly GUI is included.
- C Compiler conforming to the ANSI C standard offers excellent descriptiveness and portability.

## 【Debugger】

- The emulator system for a TLCS-870 Family MCU can be configured by an appropriate combination of a debugger and an emulation pod.
- A wide variety of debug functions are available including various types of break settings and real-time trace.

## Basic performance

System name	TLCS-870 Series	TLCS-870/C Series		TLCS-870/X Series	
	model 10 system	Light system	model 15 system	model 15 system	model 25 system model 15 pod model 25 pod (Note 1)
Host interface	RS-232C	USB2.0 Full-speed	Ethernet, RS-232C	Ethernet, RS-232C	
Emulation memory	Capacity	64 Kbytes	64 Kbytes	1 Mbyte	
	Number of points	4 points	4 points	8 points	
Events	Comparison items	Address, data, status, external input	Address, data, status	Address, data, status	Address, data, status, external input
	Comparison conditions	Match, unmatched, within scope	Match, unmatched, within scope	Match, unmatched, within scope	
	Pass count	1 to 65535 times	1 to 65535 times	1 to 65535 times	
	Event trigger actions	Break, trace control, timer control, external trigger output	Break	Break, trace control, timer control, external trigger output	Break, trace control, timer control, external trigger output
Break	Event combinations	OR, sequential	OR, sequential	AND, OR, sequential	
	Hardware break	4 points	2000 points	2000 points	3 points
Trace memory	Software break	-	2000 points	2000 points	
	Capacity	4K frames	1K frames	8K frames	8K frames
	Trace modes	Overflow stop	Overflow stop	Free trace, trigger trace, sampling trace, overflow stop	Free trace, trigger trace, sampling trace, overflow stop
External output	Trace items	PC address, data address, data value, status, external input	PC address, data address, data value, status	PC address, data address, data value, status	PC address, data address, data value, status, external input, tag timer
	External output	1 line	-	1 line	1 line
Timer measurement	Run timer or Lap timer: 1 channel	Run timer: 1 channel	Run timer: 1 channel	Run timer: 1 channel	Lap timer: 1 channel
	Memory display during program execution	-	-	32 bytes	32 bytes
Memory access	Memory display during program execution	-	2 bytes	2 bytes (Note 2)	-
	Memory rewrite during program execution	-	-	-	-
Program variables	Display	Binary, octal, decimal or hexadecimal display can be selected for each variable.	Binary, octal, decimal or hexadecimal display can be selected for each variable.	Binary, octal, decimal or hexadecimal display can be selected for each variable.	
	Registration	Variables, arrays, structures and unions can be registered by the elements.	Variables, arrays, structures and unions can be registered by the elements.	Variables, arrays, structures and unions can be registered by the elements.	
Source display	Registration	Variables, arrays, structures and unions can be registered by the elements.	Variables, arrays, structures and unions can be registered by the elements.	Variables, arrays, structures and unions can be registered by the elements.	
	Source display	● Source ● Source + assembler code ● Source + assembler code + machine language	● Source ● Source + assembler code ● Source + assembler code + machine language	● Source ● Source + assembler code ● Source + assembler code + machine language	
External input	External input	8 lines	-	-	16 lines
	Performance analysis	Time measurement per module	-	-	Max., min., average, count, dispersion
Performance analysis	Coverage measurement	-	-	-	C0 coverage

Note 1: model 25 pod: BM88CM49N0A, BM88CU74F0A, BM88CP77F0A, BM88C060F0A  
Note 2: This function is not supported with the BM88CM49NOB-M15.

## Development system configuration examples

The basic MCU-dependent development system environment for the TLCS-870 Family is summarized below. The specified values are the recommended values for comfortable use. For the minimum operating environment, check with the product manual of each development system product.

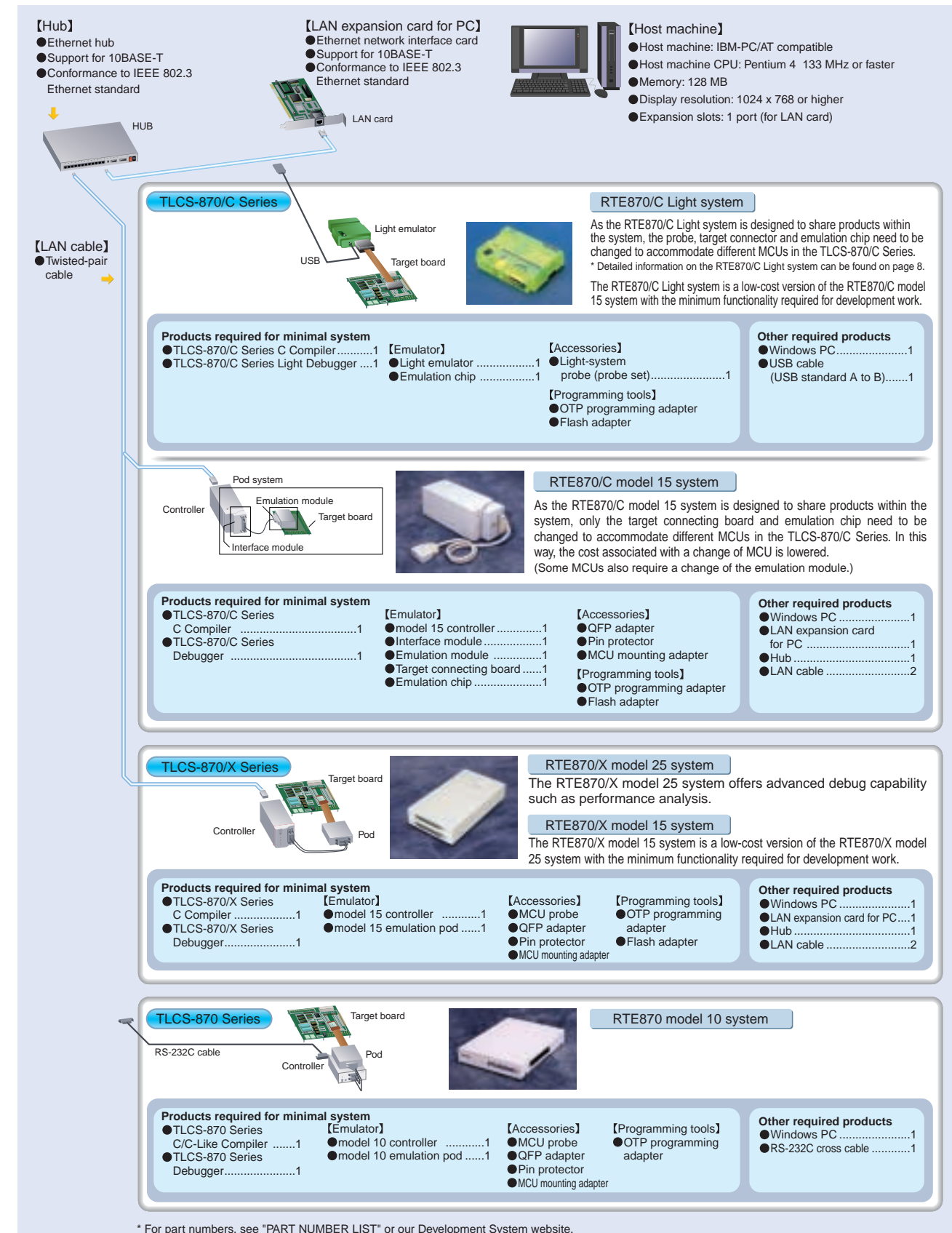

\* For part numbers, see "PART NUMBER LIST" or our Development System website.



## Programming tools

### Flash adapter

The Flash adapter is provided for each package type of Toshiba's microcontrollers with on-chip Flash memory. Connecting the Flash adapter with a host system allows you to program, erase, and verify on-chip Flash memory. Although this tool can be used both for product development and mass production, some limitations apply when it is used for mass production. For details, visit Toshiba's Microcomputer website. The website provides various support information for the Flash adapter including its control software upgrades to flexibly support newly developed devices.

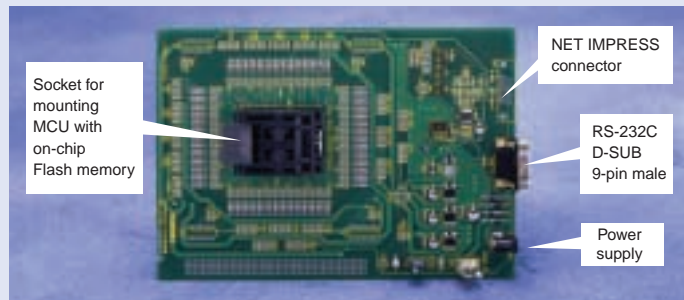

- Enables Toshiba's Flash microcontrollers to be programmed on a stand-alone basis.
- Can be used with Toshiba's Flash microcontrollers of any Family or Series in the same package. (\*The user is required to connect write signals and mount oscillators as appropriate to each device.)
- Comes with "Flash Programmer"-programming control software controllable on a PC.
- Ensures ease of operation through the GUI-based control software.
- Allows programmed data to be compared on a byte basis.
- Yokogawa Digital Computer's programmer (NET IMPRESS) can be used as a host system.

### OTP programming adapter

This is an adapter for converting the pinout of an OTP microcontroller to that of a general-purpose EPROM. The OTP programming adapter enables an OTP microcontroller to be programmed and verified by an off-the-shelf EPROM programmer. This adapter is provided for each OTP microcontroller type.

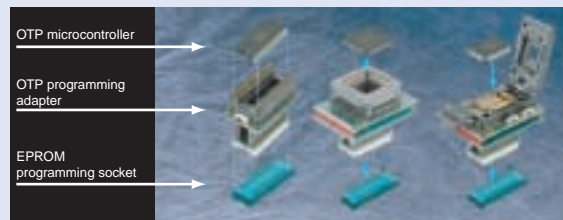

## Accessories

### MCU probe

The MCU probe is used to connect a target system and an emulation pod, and is provided for each package type. The MCU probe used for a flat package comes with a QFP adapter and a pin protector.

\* The RTE870/C Light system requires a probe specifically tailored to the Light system. For details, see page 8.

### Pin protector

The pin protector is a protective socket for an MCU probe and a QFP adapter. Be sure to use the pin protector to prevent MCU probe's joint from losing its spring after repeated attachments and detachments.

\* We recommend replacing the pin protector after 100 attach-detach cycles.

### QFP adapter

The QFP adapter is used to connect an emulation pod or an emulation module to a target system designed for a QFP-type microcontroller. It is soldered onto the foot pattern on the target system board.

\* Once soldered, the QFP adapter cannot be reused.

\* The pin protector and QFP adapter of the same specifications are also available from Tokyo Eletech Corporation.

### MCU mounting adapter

The MCU mounting adapter is used together with the QFP adapter to mount a microcontroller on the target system.

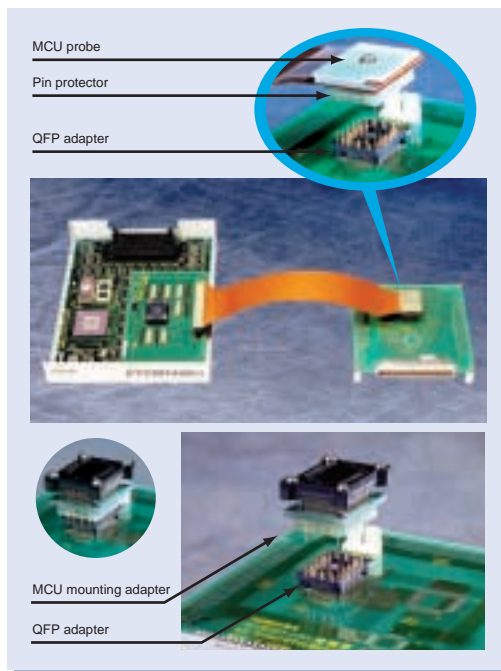

For part numbers and tool combinations, see "PART NUMBER LIST" or Development System website.

# Software Development Support

Toshiba provides a variety of reference software for supporting system development. At customer request, we can also develop application software for embedding in microcontroller units (MCUs).

## Toshiba software IP line-up

We have a comprehensive software IP set for customers using (or considering using) Toshiba MCU products. The software IP and its user support are offered on certain terms and conditions. In addition, you are required to make an agreement separately in order to use this software IP.

Software IP	MCU/Series	Features	Status
TCP/IP protocol stack	TLCS-900/L1, H1	Ideal for network appliances and network audio products etc. Conforms to RFC and supports TCP, UDP, IP, ICMP, and ARP.	Available
HTTP server	TLCS-900/L1, H1	Supports HTTP 1.0/1.1. Application product control, data gathering, and monitoring from an external PC or other device are readily achievable.	Available
USB1.1 (device)	TMP92CH21FG TMP92CZ26A TMP92CF26A TMP92CF29	Exchange of various data is readily achievable by connecting to PC. Supports standard request, various types of class request, and vendor commands.	Available
JPEG	TLCS-900/L1, H1	Software decoder that conforms to ISO/IEC10918-1. The maximum size of an image is QVGA.	Available
IrDA protocol stack	TLCS-900/L1, H1	Communication with other infrared application devices is feasible. Supports IrPHY, IrLAP, IrLMP, IrTTP, and IrOBEX.	Available
Embedded file system	TLCS-900/L1, H1	File system for embedding. Supports FAT12/16/32 and VFAT, and can perform file sharing with PC.	Available
Speech codec	TLCS-870/C TLCS-900/L1, H1	Toshiba original compression algorithm. The CPU load and memory usage are optimized to enable also the control of peripheral devices with embedded state in single-chip microcontroller. Speech codec application development environment and evaluation board are available.	Available
CompactFlash Driver	TLCS-900/L1, H1	Driver Software for reading from and writing to CompactFlash card. Can transfer files to and from a PC, being incorporated in an embedded file system.	Available
SD Memory Card Driver	TLCS-900/L1, H1	Driver Software for reading and writing SD card with MCU. Can transfer files to and from a PC, being incorporated in an embedded file system.	Available
Handwritten Recognition	TLCS-900/L1, H1	Software that recognizes handwritten characters on a LCD panel with a touchscreen. An embedded device incorporating this software can realize a user-friendly input interface without any exclusive input device such as key board.	Available
Graphical Interface	TLCS-900/L1, H1	Software for embedded devices with LCD panel. Has functions of various controls, preset interface and display for PDA. Setting several data makes it possible to display menus and control them.	Available
Graphics Library	TLCS-900/L1, H1	Software that draws figure/text and processes them. It has become also capable of expressing many colors in fewer colors with its dithering function.	Available
Animation Library	TLCS-900/L1, H1	Combining multiple still images, can play them dynamically. Encoded on PC, and decoded on embedded device.	Available
Authentication Library	TLCS-870/C	8-bit microcontroller-mountable small size program. Software for authentication of high safety. Authentic method based on ISO/IEC9798-2. Key length is selective from 96 to 256 bits and shall be activated by function call.	Available
Text To Speech (TTS)	TMP92CZ26A TMP92CF26A TMP92CF29	Text To Speech is a means of conversion from text data to speech data. Compared to Speech Codec, it dramatically saves a storage area when reading various input text data. Moreover, the speech data is changeable only by replacing it by new one.	Available

Some of the above software IPs require a separate real-time OS (Toshiba's TR900).

Display the following URL for the overviews of these software IPs.

<http://www.semicon.toshiba.co.jp/eng/prd/micro/swip/index.html>

## Reference application software (RAS)

RAS is software for driving an entire system, whose specifications have been created by Toshiba. RAS is developed for reference with the aim of reducing customer software development time, so it is used and evaluated by customers themselves.

System name	FTS-171	FTS-172 (Under development)	FTS-151	CTS-777	CTS-851
Application	Multi-system color LCD TVs	Multi-system color LCD TVs supporting HDMI with CEC function	FS channel tuning for NTSC color LCD-TV with support for North American CCD and V-Chip	VS channel tuning for multi-system color TVs	FS channel tuning for NTSC color TVs with support for North American CCD and V-Chip
Display	VGA/WXGA	VGA	VGA/WXGA	CRT	CRT
MCU	TMP88CS34FG TMP88CS38BFG	TMP88CS34FG	TMP88CS34FG TMP88CS38BFG	TMP88CP34NG/FG	TMP88CS38NG/FG
Sub MCU	-	TMP86FS49AUG (HDMI Receiver LSI:TC90704MFG)	-	-	-
Chip IC for color TVs	TC90200FG	TC90200FG	TC90200FG	TB1261ANG	TB1263NG
Channels in memory	200	200	US181CH	100/200	US181CH
Sound multiplexing	NICAM/IGR	NICAM/IGR	Sound multiplexing for US	NICAM/IGR	Sound multiplexing for US

A separate contract is necessary to use RAS. Please consult with us about modifying software to suit customer systems and specifications.

## Handwritten Character Input Solution

We offer a comfortable solution of handwritten character input achieved by the interaction between the handwritten character recognition and Kana-Kanji conversion.

In addition to the input continued at an uninterrupted pace that was succeeded by Toshiba's original technology of overwritten character recognition, the cooperation with an advanced Kana-Kanji prediction and conversion technology has achieved costless input, which made the input of long sentences stressless. This software is the best thing for wide range of applications that use LCD and touch panel such as PDA (Personal Digital Assistant), electric dictionary, home electric appliances.

As for MCU to use, our TLCS-900/H1 series is recommended.

### Example of Application

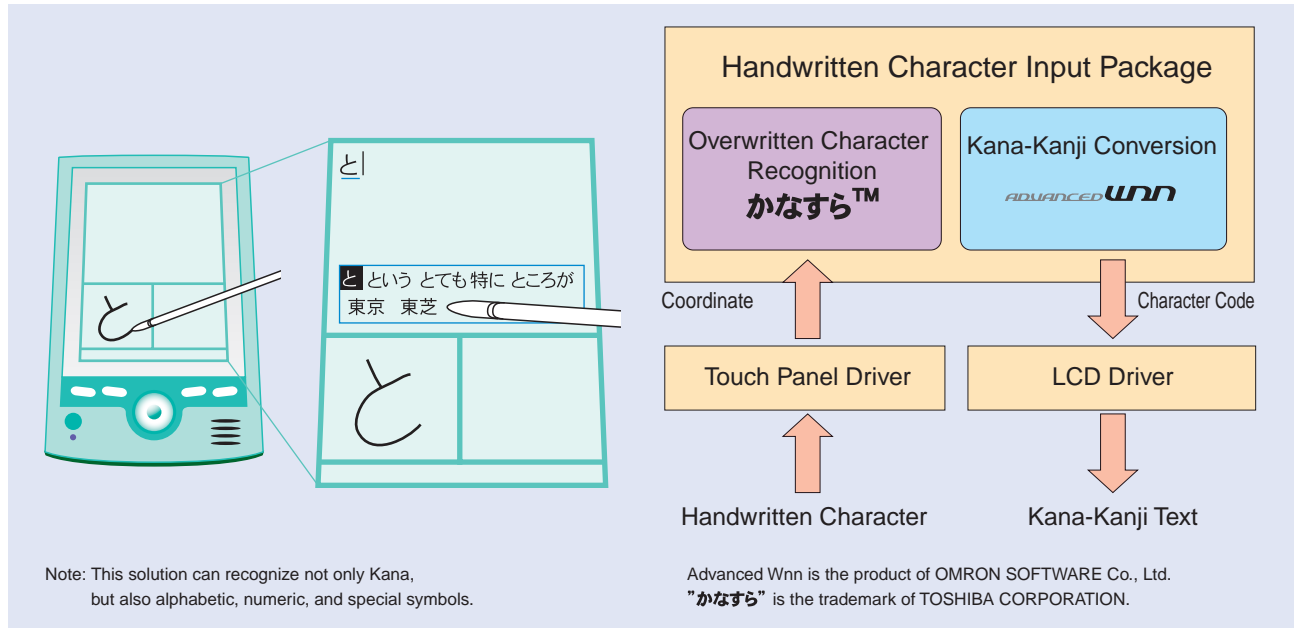

### Start of Web download services

## Application Notes

▶ <http://www.semicon.toshiba.co.jp/eng/index.html>

An application note is a sample software product offered by Toshiba to help customers understand Toshiba microcontrollers and learn how to create programs when developing new products. To access a download page, go to "Application Notes" from the above URL through "Microcomputer." If you accept and agree to the terms and conditions for usage, you will see an application notes list displayed. The application notes for Toshiba **870/X** and **900/H** Series are released first, and those for other MCUs will also be released sequentially.

TLCS-870/X	TLCS-900/H
Creating TOD Clock Using TBT Interrupts	Generating Interrupts at Regular Intervals Using 8-bit Timer
Detecting Keys Using a Timer	Generating Interrupts at Regular Intervals Using Cascaded 8-bit
Detecting Keys Using an A/D Converter	Outputting 50%-Duty Pulses Using 8-bit Timer
RS-232C Communication Using UART	Outputting PWM Waveform Using 8-bit Timer
Generating Tone Using PDO	Outputting PPG Waveform Using 8-bit Timer
Inter-CPU Communication (Transmission + Reception) Using SIO	Outputting Single-Shot Pulse Using External Trigger Pulse
Inter-CPU Communication (Simultaneous Transmission/Reception) Using SIO	Counting Events Using 16-bit Timer
Measuring AC Frequency Using Pulse Width Measurement Mode	Measuring Frequency Using 16-bit Timer
⋮	⋮

## Toshiba Semiconductor Website

<http://www.semicon.toshiba.co.jp/eng/index.html>

Information on the entire spectrum of Toshiba semiconductor products is available here.

### Solution

You can access latest information for each of system applications.

### Product information

You can access a wide range of new-product information, presentation data material and other data.



## Toshiba Microcomputer Website

<http://www.semicon.toshiba.co.jp/eng/prd/micro/index.html>

A line-up of Toshiba microcomputer products and the latest technical information on products are presented here.

### Topics

Regularly presents information on Toshiba microcomputers.

### Software IP

Provides information about a wide range of software IPs.

### Family introduction

Introduces microcomputer families ranging from 4-bit to 64-bit.

### Reference Model/Evaluation board

Provides a PDF summary of reference models and evaluation boards.

### Datasheet/Catalog download

Publishes microcomputer datasheets and catalogs in PDF format.

### Application Notes

Application notes are sample software provided to help the customer understand Toshiba microcontrollers and program their own applications. The customer can download application notes from this section.



## Toshiba Microcomputer Development System Product Website

This website provides the latest information on Toshiba microcomputer development system products. To suit the different aims of visitors, the website includes the pages for examining customers and current users.





## Microcomputer package summary

To meet customers' needs Toshiba provides a wide range of highly reliable packages for high-density mounting. In particular, Toshiba's miniature packages for portable applications offer extensive choices ranging to products as compact as 144-pin and 0.4-mm pitch.

### SDIP/SOP/SSOP/QFP/FBGA packages for 4-/8-/16-/32-bit microcontrollers

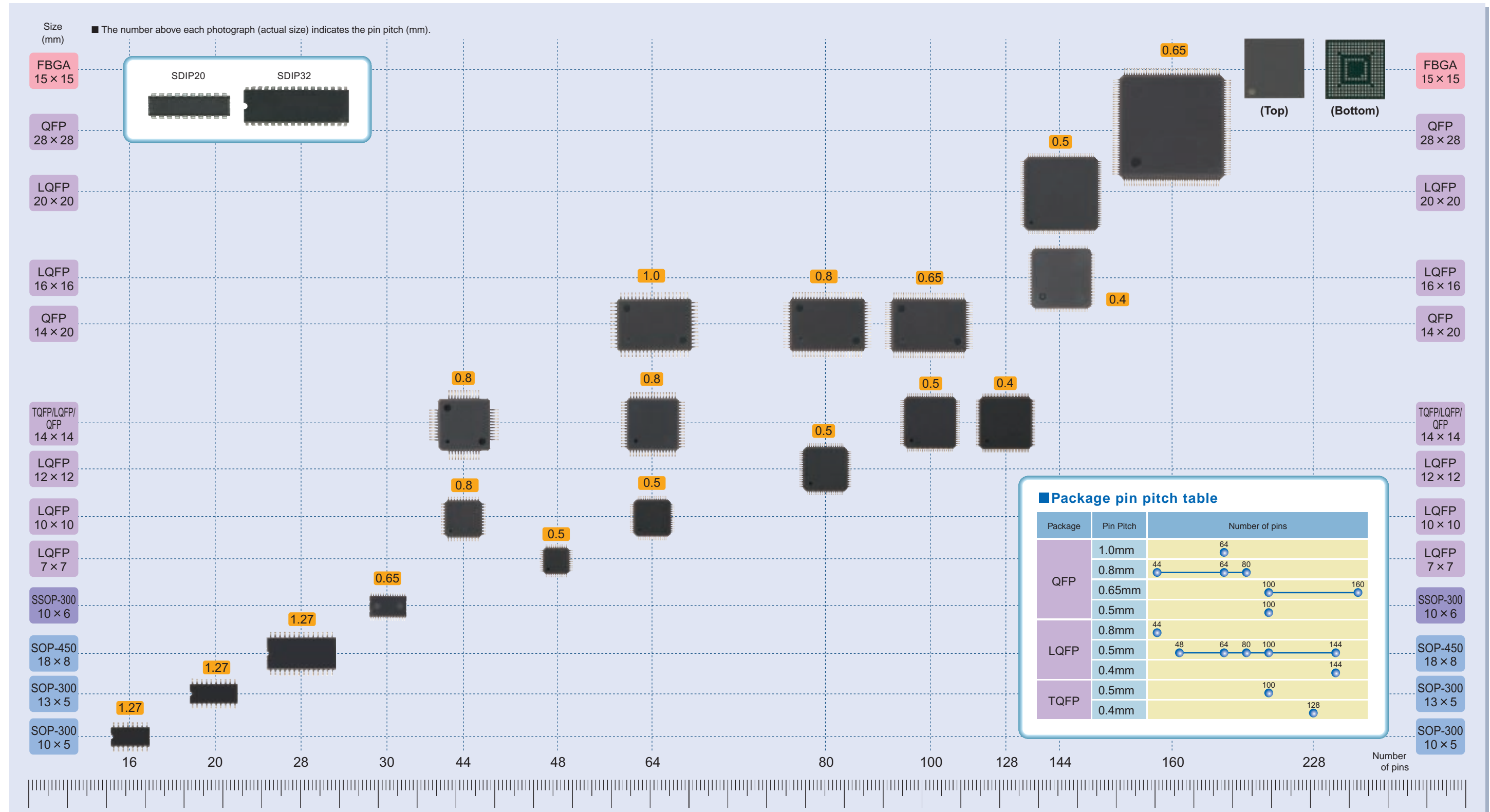

## TX System RISC Packages (Actual Size)

### TX99 :

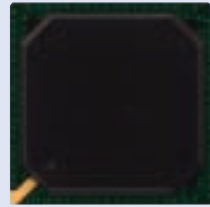

TX9956XBG(Top)

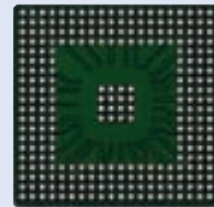

TX9956XBG (Bottom)

### TX39 :

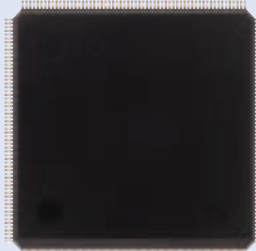

TMPR3927CF



TMPR3916F



TMPR3911BU



TMPR3912AUG-92



TMPR3911BxB



TMPR3912XB-92

### TX19 :



TMP1940CYAFG  
TMP1940FDBFG  
TMP1941AFG  
TMP19A71CYUG  
TMP19A71FYUG

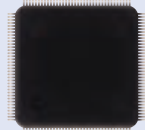

TMP1942CYU  
TMP1942CZUE  
TMP1942FDU



TMP1942CZXBG  
TMP1942FDXBG

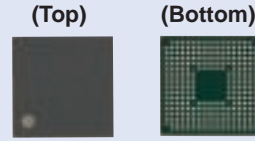

TMP1962C10BxBG  
TMP1962F10AxBG  
TMP19A64C1DXBG  
TMP19A64F20BxBG

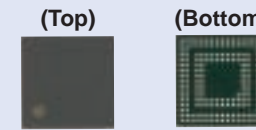

TMP19A43FDXBG  
TMP19A43FZXBG  
TMP19A43CDXBG  
TMP19A43CZXBG

### TX49 :

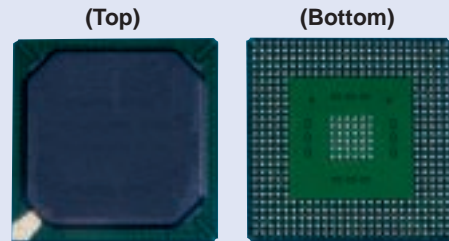

TX4939XBG

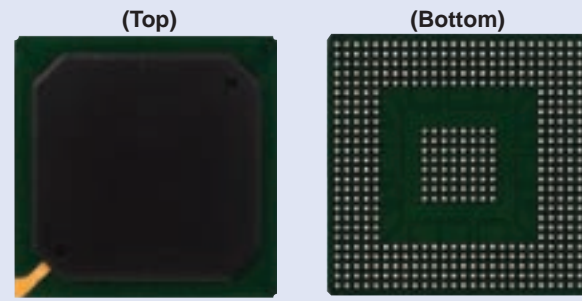

TMPR4937XBG  
TMPR4938XBG

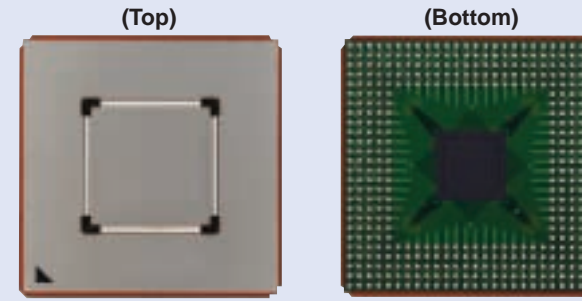

TMPR4927ATBG

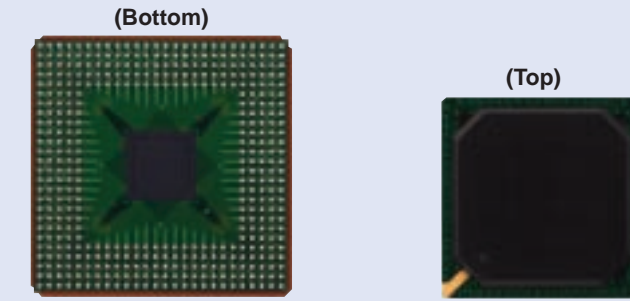

TMPR4925XBG  
TMPR4926XBG

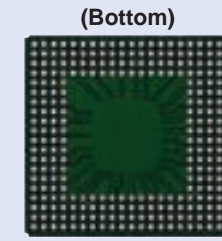

TMPR4925XBG  
TMPR4926XBG



TMPR4956CXBG



TMPR4951BFG



TC86C001FG

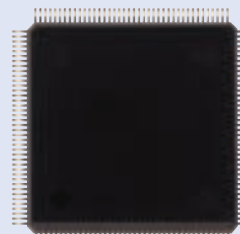

TMPR4955AFG  
TMPR4955BFG  
TMPR4955CFG

**Toshiba America Electronic Components, Inc.**

**Headquarters-Irvine, CA**  
19900 MacArthur Boulevard,  
Suite 400, Irvine, CA 92612, U.S.A.  
Tel: (949)623-2900 Fax: (949)474-1330

**Boulder, CO (Denver)**  
3100 Arapahoe #500,  
Boulder, CO 80303, U.S.A.  
Tel: (303)442-3801 Fax: (303)442-7216

**Buffalo Grove (Chicago)**  
2150 E. Lake Cook Road, Suite 310,  
Buffalo Grove, IL 60089, U.S.A.  
Tel: (847)484-2400 Fax: (847)541-7287

**Duluth, GA (Atlanta)**  
3700 Crestwood Pkwy, #160,  
Duluth, GA 30096, U.S.A.  
Tel: (770)931-3363 Fax: (770)931-7602

**Portland, OR**  
2560 NW 141st Place Portland,  
OR 97229, U.S.A.  
Tel: (503)784-8879 Fax: (503)466-9729

**Raleigh, NC**  
3120 Highwoods Blvd., #108, Raleigh,  
NC 27604, U.S.A.  
Tel: (919)859-2800 Fax: (919)859-2898

**Richardson, TX (Dallas)**  
777 East Campbell Rd., #650, Richardson,  
TX 75081, U.S.A.  
Tel: (972)480-0470 Fax: (972)235-4114

**San Jose Engineering Center, CA**  
2590 Orchard Parkway San Jose,  
CA 95131, U.S.A.  
Tel: (408)526-2400 Fax: (408)526-2410

**Wakefield, MA (Boston)**  
401 Edgewater Place, #360, Wakefield,  
MA 01880-6229, U.S.A.  
Tel: (781)224-0074 Fax: (781)224-1095

**Wixom (Detroit)**  
48679 Alpha Drive, Suite 100, Wixom,  
MI 48393 U.S.A.  
Tel: (248)449-6165 Fax: (248)449-8430

**Toshiba Electronics do Brasil Ltda.**  
Rua Afonso Celso, 552-8 andar, C.J. 81  
Vila Mariana Cep 04119-002 São Paulo SP, Brasil  
Tel: (011)5576-6619 Fax: (011)5576-6607

**Toshiba India Private Ltd.**  
6F DR. Gopal Das Bhawan 28,  
Barakhamba Road, New Delhi, 110001, India  
Tel: (011)2331-8422 Fax: (011)2371-4603

**Toshiba Electronics Europe GmbH**

**Düsseldorf Head Office**  
Hansaallee 181, D-40549 Düsseldorf,  
Germany  
Tel: (0211)5296-0 Fax: (0211)5296-400

**München Office**  
Büro München Hofmannstrasse 52,  
D-81379, München, Germany  
Tel: (089)748595-0 Fax: (089)748595-42

**France Branch**  
Les Jardins du Golf 6 rue de Rome F-93561,  
Rosny-Sous-Bois, Cedex, France  
Tel: (1)48-12-48-12 Fax: (1)48-94-51-15

**Italy Branch**  
Centro Direzionale Colleoni,  
Palazzo Perseo 3,  
I-20041 Agrate Brianza, (Milan), Italy  
Tel: (039)68701 Fax: (039)6870205

**Spain Branch**  
Parque Empresarial, San Fernando, Edificio Europa,  
1ª Planta, E-28831 Madrid, Spain  
Tel: (91)660-6798 Fax: (91)660-6799

**U.K. Branch**  
Riverside Way, Camberley Surrey,  
GU15 3YA, U.K.  
Tel: (01276)69-4600 Fax: (01276)69-4800

**Sweden Branch**  
Gustavslundsvägen 18, 5th Floor,  
S-167 15 Bromma, Sweden  
Tel: (08)704-0900 Fax: (08)80-8459

**Toshiba Electronics Asia (Singapore) Pte. Ltd.**  
438B Alexandra Road, #06-08/12 Alexandra  
Technopark, Singapore 119968  
Tel: (6278)5252 Fax: (6271)5155

**Toshiba Electronics Service (Thailand) Co., Ltd.**  
135 Moo 5, Bangkadi Industrial Park, Tivanon Road,  
Pathumthani, 12000, Thailand  
Tel: (02)501-1635 Fax: (02)501-1638

**Toshiba Electronics Trading (Malaysia) Sdn. Bhd.**

**Kuala Lumpur Head Office**  
Suite W1203, Wisma Consplant, No.2,  
Jalan SS 16/4, Subang Jaya, 47500 Petaling Jaya,  
Selangor Darul Ehsan, Malaysia  
Tel: (03)5631-6311 Fax: (03)5631-6307

**Penang Office**  
Suite 13-1, 13th Floor, Menara Penang Garden,  
42-A, Jalan Sultan Ahmad Shah,  
10050 Penang, Malaysia  
Tel: (04)226-8523 Fax: (04)226-8515

**Toshiba Electronics Philippines, Inc.**  
26th Floor, Citibank Tower, Valero Street, Makati,  
Manila, Philippines  
Tel: (02)750-5510 Fax: (02)750-5511

**Toshiba Electronics Asia, Ltd.**

**Hong Kong Head Office**  
Level 11, Tower 2, Grand Century Place, No.193,  
Prince Edward Road West, Mongkok, Kowloon, Hong Kong  
Tel: 2375-6111 Fax: 2375-0969

**Beijing Office**  
Room 714, Beijing Fortune Building, No.5 Dong San Huan Bei-Lu,  
Chao Yang District, Beijing, 100004, China  
Tel: (010)6590-8796 Fax: (010)6590-8791

**Chengdu Office**  
Room 2508A, 2 Zongfu Street, Times Plaza,  
Chengdu 610016 Sichuan, China  
Tel: (028)8675-1773 Fax: (028)8675-1065

**Qingdao Office**  
Room 4(D-E), 24F, International Financial Center,  
59 Xiang Gang Zhong Road, Qingdao, Shandong, China  
Tel: (0532)579-3328 Fax: (0532)579-3329

**Toshiba Electronics Shenzhen Co., Ltd.**  
Room 2601-2609, 2616, Office Tower Shun Hing Square,  
Di Wang Commercial Center, 5002 Shennan Road East,  
Shenzhen, 518008, China  
Tel: (0755)2583-0810 Fax: (0755)8246-1581

**Toshiba Electronics (Shanghai) Co., Ltd.**

**Shanghai Head Office**  
11F, HSBC Tower, 1000 Lujiazui Ring Road,  
Pudong New Area, Shanghai 200120, China  
Tel: (021)6841-0666 Fax: (021)6841-5002

**Hangzhou Office**  
502 JiaHua International Business Center,  
No.28 HangDa Road, Hangzhou, 310007, China  
Tel: (0571)8717-5004 Fax: (0571)8717-5013

**Nanjing Office**  
23F Shangmao Century Plaza,  
No.49 Zhong Shan South Road, Nanjing, 210005, China  
Tel: (025)8689-0070 Fax: (025)8689-0125

**Toshiba Electronics (Dalian) Co., Ltd.**

14/F, Senmao Building, 147, Zhongshan Road,  
Xigang Dist., Dalian, 116011, China  
Tel: (0411)8368-6882 Fax: (0411)8369-0822

**Tsurong Xiamen Xiangyu Trading Co., Ltd.**  
14G, International Bank BLDG., No.8 Lujiang Road,  
Xiamen, 361001, China  
Tel: (0592)226-1398 Fax: (0592)226-1399

**Toshiba Electronics Korea Corporation**

**Seoul Head Office**  
891, Samsung Life Insurance Daechi Tower 20F, Daechi-dong,  
Gangnam-gu, Seoul, 135-738, Korea  
Tel: (02)3484-4334 Fax: (02)3484-4302

**Gumi Office**  
6F, Goodmorning Securities Building, 56 Songjung-dong,  
Gumi-shi, Gyeongbuk, 730-090, Korea  
Tel: (054)456-7613 Fax: (054)456-7617

**Toshiba Electronics Taiwan Corporation**

**Taipei Head Office**  
17F, Union Enterprise Plaza Building, 109  
Min Sheng East Road, Section 3, Taipei, 10544, Taiwan  
Tel: (02)2514-9988 Fax: (02)2514-7892

**Kaohsiung Office**  
16F-A, Chung-Cheng Building, 2, Chung-Cheng 3Road,  
Kaohsiung, 80027, Taiwan  
Tel: (07)237-0826 Fax: (07)236-0046

The information contained herein is subject to change without notice. 021023\_D

TOSHIBA is continually working to improve the quality and reliability of its products. Nevertheless, semiconductor devices in general can malfunction or fail due to their inherent electrical sensitivity and vulnerability to physical stress. It is the responsibility of the buyer, when utilizing TOSHIBA products, to comply with the standards of safety in making a safe design for the entire system, and to avoid situations in which a malfunction or failure of such TOSHIBA products could cause loss of human life, bodily injury or damage to property. In developing your designs, please ensure that TOSHIBA products are used within specified operating ranges as set forth in the most recent TOSHIBA products specifications. Also, please keep in mind the precautions and conditions set forth in the "Handling Guide for Semiconductor Devices," or "TOSHIBA Semiconductor Reliability Handbook" etc. 021023\_A

The TOSHIBA products listed in this document are intended for usage in general electronics applications (computer, personal equipment, office equipment, measuring equipment, industrial robotics, domestic appliances, etc.). These TOSHIBA products are neither intended nor warranted for usage in equipment that requires extraordinarily high quality and/or reliability or a malfunction or failure of which may cause loss of human life or bodily injury ("Unintended Usage"). Unintended Usage include atomic energy control instruments, airplane or spaceship instruments, transportation instruments, traffic signal instruments, combustion control instruments, medical instruments, all types of safety devices, etc. Unintended Usage of TOSHIBA products listed in this document shall be made at the customer's own risk. 021023\_B

The products described in this document shall not be used or embedded to any downstream products of which manufacture, use and/or sale are prohibited under any applicable laws and regulations. 060106\_Q

The information contained herein is presented only as a guide for the applications of our products. No responsibility is assumed by TOSHIBA for any infringements of patents or other rights of the third parties which may result from its use. No license is granted by implication or otherwise under any patent or patent rights of TOSHIBA or others. 021023\_C

Please contact your sales representative for product-by-product details in this document regarding RoHS compatibility. Please use these products in this document in compliance with all applicable laws and regulations that regulate the inclusion or use of controlled substances. Toshiba assumes no liability for damage or losses occurring as a result of noncompliance with applicable laws and regulations. 060819\_Z

The products described in this document may include products subject to the foreign exchange and foreign trade laws. 021023\_F

The products described in this document contain components made in the United States and subject to export control of the U.S. authorities. Diversion contrary to the U.S. law is prohibited. 021023\_G

TOSHIBA has made this document deliberately in order to make its contents as accurate as possible. Nevertheless, if any trouble should occur due to any error contained in this document, TOSHIBA shall not have any liability therefore. Also, please keep in mind the precautions and conditions set forth in the "Instruction Manual or Operation Manual of TOSHIBA Products," or "The Precautions or Procedure Files described in the Installation Disk such as Floppy Disk or CD-ROM etc." Please constantly pay attention to the latest information on the TOSHIBA products which is to be released through the web page of TOSHIBA microcomputer development system. (<http://www.semicon.toshiba.co.jp/eng>) 060824\_N

# TOSHIBA

**TOSHIBA CORPORATION**  
Semiconductor Company

Website: <http://www.semicon.toshiba.co.jp/eng>

## Free Manuals Download Website

<http://myh66.com>

<http://usermanuals.us>

<http://www.somanuals.com>

<http://www.4manuals.cc>

<http://www.manual-lib.com>

<http://www.404manual.com>

<http://www.luxmanual.com>

<http://aubethermostatmanual.com>

Golf course search by state

<http://golfingnear.com>

Email search by domain

<http://emailbydomain.com>

Auto manuals search

<http://auto.somanuals.com>

TV manuals search

<http://tv.somanuals.com>