

TOSHIBA

UNINTERRUPTIBLE POWER SYSTEM (UPS)

G8000 SERIES

INSTALLATION and
OPERATION MANUAL

480/480 V 100/150/225/300 kW



Document: 61001-001
July 2012

UNINTERRUPTIBLE POWER SYSTEM (UPS)

G8000 SERIES

INSTALLATION and OPERATION MANUAL

480/480 V 100/150/225/300 kW

Document: 61001-001

July 2012



The Toshiba products listed in this document are intended for usage in general electronics applications (computer, personal equipment, office equipment, measuring equipment, industrial robotics, domestic appliances, etc.). These Toshiba products are neither intended nor warranted for usage in equipment that requires extraordinarily high quality and/or reliability; nor are they intended to be used in equipment that, if a malfunction or failure occurs, may result in loss of human life or bodily injury (collectively referred to as "Unintended Usage"). Unintended Usage includes atomic energy control instruments, airplane or spaceship instruments, transportation instruments, traffic signal instruments, combustion control instruments, life support equipment, all types of safety devices, etc. Unintended Usage of Toshiba products listed in this document shall be made at the customer's own risk.

NOTICE

PLEASE INFORM TOSHIBA INTERNATIONAL CORPORATION OR AUTHORIZED REPRESENTATIVE IN CASE OF INCONSISTENCIES, OMISSIONS, OR QUESTIONS.

The instructions contained in this manual are not intended to cover all of the details or variations in equipment, nor to provide for every possible contingency concerning installation, operation, or maintenance. Should further information be required or if problems arise which are not covered sufficiently contact your Toshiba sales office.

The contents of this instruction manual shall not become a part of or modify any prior or existing agreement, commitment, or relationship. The sales contract contains the entire obligation of Toshiba International Corporation's UPS Division. The warranty contained in the contract between the parties is the sole warranty of Toshiba International Corporation's UPS Division and any statements contained herein DO NOT create new warranties or modify the existing warranty.

Any electrical or mechanical modifications to this equipment without prior written consent of Toshiba International Corporation will void all warranties and may void the UL/CUL listing. Unauthorized modifications can also result in personal injury, death, or destruction of the equipment.

QUALIFIED PERSONNEL ONLY

Qualified Personnel is one that has the skills and knowledge relating to the construction, installation, operation, and maintenance of the electrical equipment and has received safety training on the hazards involved (Refer to the latest edition of NFPA 70E for additional safety requirements).

UNINTERRUPTIBLE POWER SYSTEM (UPS)

Please complete the following information and retain for your records.

Unless otherwise specified, the warranty period for the UPS or UPS part is 12 months from the shipment date (see Toshiba International Corporation bill of lading).

Unless otherwise specified, the warranty period for a UPS battery is 36 months from the shipment date (see Toshiba International Corporation Bill of Lading for shipping date).

JOB NUMBER	_____
MODEL NUMBER	_____
SERIAL NUMBER	_____
APPLICATION	_____
SHIPMENT DATE	_____
INSTALLATION DATE	_____
INSPECTED BY	_____

Purpose

This manual provides information on how to safely install and operate your Toshiba International Corporation power electronics product. This manual includes a section of general safety instructions that describes the warning labels and symbols that are used throughout the manual. Read the manual completely before installing, operating, or performing maintenance on this equipment.

This manual and the accompanying drawings should be considered a permanent part of the equipment and should be readily available for reference and review. Dimensions shown in the manual are in metric and/or the English customary equivalent.

Toshiba International Corporation reserves the right, without prior notice, to update information, make product changes, or discontinue any product or service identified in this publication.

Toshiba is a registered trademark of the Toshiba Corporation. All other product or trade references appearing in this manual are registered trademarks of their respective owners.

Toshiba International Corporation shall not be liable for direct, indirect, special, or consequential damages resulting from the use of the information contained within this manual.

This manual is copyrighted. No part of this manual may be photocopied or reproduced in any form without the prior written consent of Toshiba International Corporation.

© Copyright 2008 Toshiba International Corporation
All rights reserved.
Printed in the U.S.A.

Toshiba's Customer Support Center

Contact the Toshiba Customer Support Center for assistance with application information or for any problems that you may experience with your Uninterruptible Power System (UPS).

Toshiba Customer Support Center

8 a.m. to 5 p.m. (CST) - Monday through Friday
USA Toll Free (877) 867-8773
Tel (713) 466-0277
Fax (713) 896-5212

You may also contact Toshiba by writing to:

Toshiba International Corporation

13131 West Little York Road
Houston, Texas 77041-9990
Attn: UPS Product Manager

For further information on Toshiba's products and services, please visit our website at:

www.toshiba.com/ind

Table of Contents

1	Introduction	1
2	General Safety Instructions	2
2.1	Symbols	2
2.2	Signal Words.....	3
2.3	Qualified Personnel.....	3
2.4	Factory Authorized Personnel.....	4
3	Important Safety Instructions	4
4	Safety Precautions	5
4.1	Disclaimer	5
4.2	General Maintenance.....	6
4.3	Transporting/Unpacking	6
4.4	Inspection/Storage	8
5	Installation Precautions	9
5.1	Wiring/Connection.....	13
6	Warning Labels	14
6.1	Warning Label Locations.....	15
7	Weight and Dimensions	17
8	Transporting	19
8.1	Transporting By Crane	20
8.2	Transporting By Forklift.....	21
9	Storage/Operating Environment	22
9.1	Operating Precautions	22
9.2	Maintenance Precautions	24
9.3	Disposal	25
10	Installation	26
10.1	Unpacking	27
10.2	UPS Clearance	27
10.3	Anchor Bolts.....	28
11	UPS Wiring	29
11.1	100 kVA Terminal Blocks and Power Cables.....	30
11.2	150, 225, and 300 kVA Buss Strip Terminals and Power Cables	31
11.3	UPS Power Cable Knockout Plates	34

11.4	External Breakers.....	36
11.5	Grounding Wire.....	36
11.6	Control Wires.....	38
11.7	Grounding Configuration.....	40
12	UPS Specifications.....	43
12.1	General Specification.....	43
12.2	Mechanical Specification.....	43
12.3	Electrical Specification.....	45
13	Operator Interface.....	46
13.1	Key-Switch and Buttons.....	47
13.2	LCD/LED Indicators.....	48
13.3	LCD Indicators.....	49
13.4	Normal Display.....	50
13.5	Fault Display.....	52
13.6	LCD Scroll.....	53
14	Operating the UPS.....	54
14.1	Operation Types.....	55
14.2	Pre-operational Check.....	55
14.3	Startup Procedures.....	56
14.4	Switch Power Supply (UPS→Bypass).....	58
14.5	Stop.....	59
14.6	Complete Shutdown.....	60
14.7	Changing Between Float Charge and Equalize Charge.....	61
14.8	Changing to Float Charge from Protection Charge (If applicable).....	62
14.9	Emergency Power Off (EPO).....	63
15	Troubleshooting.....	63
15.1	Types of Errors.....	63
15.2	Faults and Warnings Data Screen.....	64
15.3	LCD Fault & Warning Displays.....	65
15.4	Fault Messages.....	66
15.5	LCD Scroll (w/ faults or warnings).....	68
15.6	Restoring UPS Operation.....	69

1 Introduction

This manual provides information on how to safely operate your G8000 Series Uninterruptible Power System (UPS). This manual includes a section of general safety instructions that describes the warning labels and symbols that are used throughout the manual. Read the manual completely before installing, operating, or performing maintenance on this equipment.

Qualified personnel should read this manual carefully before transporting, installing and wiring the UPS. In addition have a thorough understanding of the information provided in the chapters titled:

- General Safety Instructions
- Important Safety Instructions
- Safety Precautions
- Installation Precautions

Please read the G8000 Series Operation Manual for important instructions on operating the UPS. This manual and the accompanying drawings should be considered a permanent part of the equipment and should be readily available for reference and review. Dimensions shown in the manual are in metric and/or the English customary equivalent.

Keep the Installation Manual and the Operation Manual near the UPS for necessary reference.

SAVE THESE INSTRUCTIONS

2 General Safety Instructions

DO NOT attempt to transport, install, operate, maintain or dispose of this equipment until you have read and understood all of the product safety information provided in this manual.

2.1 Symbols

The symbols listed below are used throughout this manual. When symbols are used in this manual they will include important safety information that must be carefully followed.



Safety Alert Symbol indicates that a potential personal injury hazard exists.



Prohibited Symbol indicates **DO NOT** take action.



Mandatory Symbol indicates that the following instruction is required.



Ground Symbol indicates the location of the equipment grounding conductor.



Electrical - Voltage & Shock Hazard Symbol indicates parts inside may cause electric shock.



Explosion Hazard Symbol indicates parts may explode.

2.2 Signal Words

The signal words listed below are used throughout this manual. When the words DANGER, WARNING, CAUTION and ATTENTION are used in this manual they will include important safety information that must be carefully followed.



DANGER

The word **DANGER** in capital letters preceded by the safety alert symbol indicates that an **imminently hazardous** situation exists, if not avoided, **will result in death or serious injury to personnel**.



WARNING

The word **WARNING** in capital letters preceded by the safety alert symbol indicates that a **potentially hazardous** situation exists, if not avoided, **could result in death or serious injury to personnel**.



CAUTION

The word **CAUTION** in capital letters preceded by the safety alert symbol indicates that a **potentially hazardous** situation exists, if not avoided, **may result in minor or moderate injury**.

CAUTION

The word **CAUTION** in capital letters without the safety alert symbol indicates a **potentially hazardous** situation exists, if not avoided, **may result in equipment and property damage**.

ATTENTION

The word **ATTENTION** in capital letters without the safety alert symbol indicates a **potentially hazardous** situation exists, if not avoided, **may result in equipment and property damage**.

2.3 Qualified Personnel

Installation, operation, and maintenance shall be performed by Qualified Personnel Only. A Qualified Person is one that has the skills and knowledge relating to the construction, installation, operation, and maintenance of the electrical equipment and has received safety training on the hazards involved (Refer to the latest edition of NFPA 70E for additional safety requirements).

Qualified Personnel shall:

- Have read the entire operation manual.
- Be familiar with the construction and function of the UPS, the equipment being driven, and the hazards involved.
- Able to recognize and properly address hazards associated with the application of motor-driven equipment.
- Be trained and authorized to safely energize, de-energize, ground, lockout/tagout circuits and equipment, and clear faults in accordance with established safety practices.
- Be trained in the proper care and use of protective equipment such as safety shoes, rubber gloves, hard hats, safety glasses, face shields, flash clothing, etc., in accordance with established safety practices.

- Be trained in rendering first aid.

For further information on workplace safety visit www.osha.gov.

2.4 Factory Authorized Personnel

Factory authorized personnel have been factory trained and certified to install, service, and repair the UPS. Contact the Toshiba Customer Support Center for assistance in locating the factory authorized personnel nearest you.

3 Important Safety Instructions

The following contains important instructions that should be followed during the installation, operation, and maintenance of the G8000 Series UPS.

Please refer to the battery manufacturer's instructions for details on operating, maintaining and/or replacing the batteries for each system. Keep unauthorized personnel from batteries. Only a certified service representative with battery experience should perform service on batteries.

CAUTION

Misuse of this equipment could result in personal injury and/or equipment damage. In no event will Toshiba Corporation be responsible or liable for either indirect or consequential damage or injury that may come from the use of this equipment.

The UPS system input and output is NOT equipped with an over-current protection device, or an output disconnection at the AC output. The user should provide circuit breakers between the UPS AC input (or Bypass input) and the power sources and between the UPS output and the critical load input. The minimum device ratings are listed in Table 3.1.

TABLE 3.1 UPS MINIMUM DEVICE RATINGS

CAPACITY	RATED OUTPUT	INPUT BREAKER RATING	OUTPUT BREAKER RATING
100 kVA	480 V/277 V	480 V-200 A	480 V-150 A
150 kVA	480 V/277 V	480 V-300 A	480 V-225 A
225 kVA	480 V/277 V	480 V-450 A	480 V-350 A
300 kVA	480 V/277 V	480 V-500 A	480 V-450 A

The maximum operating ambient temperature is 86 °F (30 °C) at 1.0 PF, and 104 °F (40 °C) at 0.8 PF. If the UPS is exposed to the same ambient temperature as the battery system, the maximum operating ambient temperature is 86 °F (30 °C) at 1.0 PF, 90 °F (32 °C) at 0.8 PF. Table 3.2 lists the nominal battery voltage.

TABLE 3.2 UPS NOMINAL BATTERY VOLTAGE

CAPACITY	NOMINAL VOLTAGE	FLOAT VOLTAGE
100 kVA	360 Vdc	405 V
150 kVA	360 Vdc	405 V
225 kVA	360 Vdc	405 V
300 kVA	360 Vdc	405 V

4 Safety Precautions

The Toshiba products listed in this document are intended for usage in general electronics applications (computer, personal equipment, office equipment, measuring equipment, industrial robotics, domestic appliances, etc.). These Toshiba products are neither intended nor warranted for use in equipment that, if a malfunction or failure occurs, may result in loss of human life or bodily injury (collectively referred to as “Unintended Usage”). Unintended Usage includes atomic energy control instruments, airplane or spaceship instruments, transportation instruments, traffic signal instruments, combustion control instruments, medical operating room or life support equipment, all types of safety devices, etc. Unintended Usage of Toshiba products listed in this document shall be made at the customer’s own risk.





The application of the UPS without special consideration for equipment that supports human safety and/or maintain public services may cause serious accidents.

4.1 Disclaimer



IN NO EVENT WILL TOSHIBA CORPORATION BE RESPONSIBLE OR LIABLE FOR EITHER INDIRECT OR CONSEQUENTIAL DAMAGE OR INJURY THAT MAY COME FROM THE USE OF THIS EQUIPMENT. ANY MODIFICATIONS WITHOUT AUTHORIZATION BY TOSHIBA COULD RESULT IN PERSONAL INJURIES, DEATH OR DESTRUCTION OF THE UPS.

TOSHIBA RESERVES THE RIGHT TO MAKE CHANGES WITHOUT FURTHER NOTICE TO ANY PRODUCTS HEREIN TO IMPROVE RELIABILITY, FUNCTION OR DESIGN. TOSHIBA DOES NOT ASSUME ANY LIABILITY ARISING OUT OF THE APPLICATION OR USE OF ANY PRODUCT OR UPS DESCRIBED HEREIN; NEITHER DOES IT CONVEY ANY LICENSE UNDER ITS PATENT RIGHTS, NOR THE RIGHTS OF OTHERS.

4.2 General Maintenance

 WARNING	
	<p>DO NOT remove the rear/side panels, or any sheet metla not designed to be removed.</p> <p>Removing rear/side panels may result in electric shock, burns, personal injuries or UPS failure.</p>
	<p>Keep the area arround the UPS clean.</p> <p>Use a vacuum cleaner to clean the UPS.</p>
	<p>Only factory authorized personnel sould perform internal general maintenance on the UPS.</p>
	<p>Contact the authorized Toshiba Customer Support Center or an authorized Toshiba representative for informaton on proper disposal of UPS components.</p> <p>It is illegal to dispose of certain components without conforming to environmental regulations for indusrial/commercial waste.</p>

4.3 Transporting/Unpacking

 WARNING	
<p>When transporting the UPS by crane, follow the SPECIFIED WORK PROCEDURE. The suspension wire angle should be less than 60°.</p> <p>The UPS falling or overturning may cause crushing, trapping or other personal injuries.</p> <p><i>See Installation Manual: Chapter 8 - Transporting</i></p>	
	<p>DO NOT tilt the UPS more than 10° from upright position.</p> <p>Tilting the UPS more than 10° may cause crushing, trapping or other personal injuries.</p>





 CAUTION	
	<p>DO NOT transport, move, store, or place the UPS on its side. Forces due to heavy components inside may damage the UPS.</p>
	<p>Avoid vibration or shock exceeding 0.5G. Failing to observe this precaution may cause damage to the UPS.</p>
	<p>DO NOT allow the UPS to suffer shock or impact when unpacking. Tools used to remove packaging materials may cause damage to the UPS.</p>
	<p>DO NOT push or pull on the sides of the packaging or the UPS to move it. Always use a crane, forklift, or pallet jack for transporting and positioning the UPS. Pushing/pulling on the sides of the unit to move it may result in damage to the UPS. See Figure 4.1 Exterior Handling label.</p>

Fig. 4.1 Exterior Handling label



4.4 Inspection/Storage

Inspection

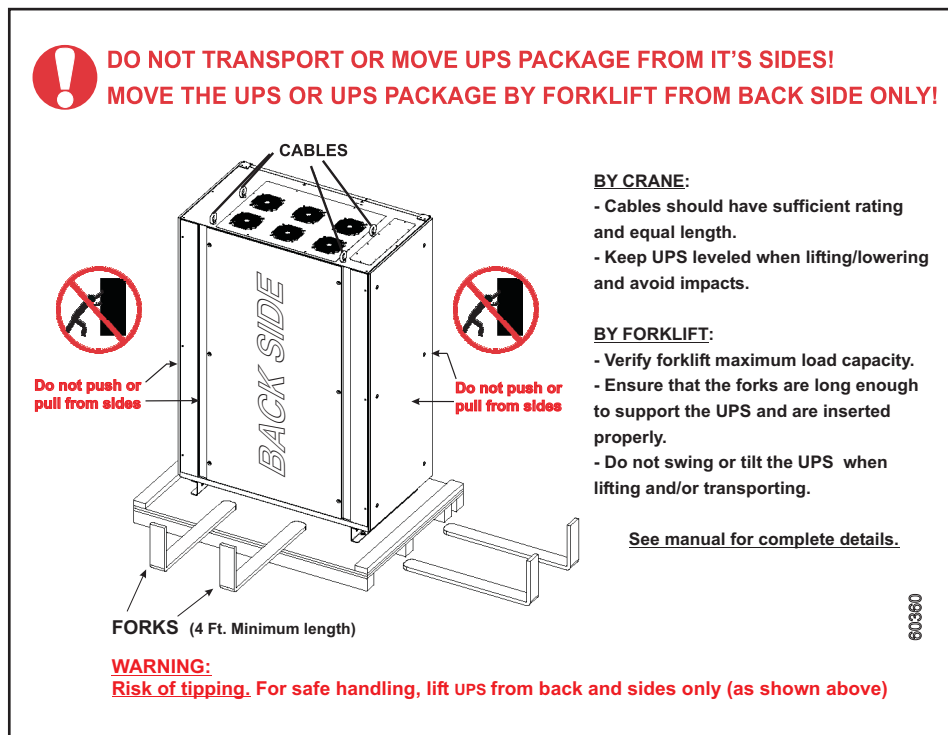
Upon receipt of the UPS, an inspection for shipping damage should be performed. Use caution when removing the unit from the pallet. Refer to labels or documentation attached to packing material.

Unpacking

Check the unit for loose, broken, bent or otherwise damaged parts. If damage has occurred during shipping, keep all original crating and packing materials for return to the shipping agent.

NOTE: The factory warranty does not apply to damage incurred during shipping!

Ensure that the rated capacity and the model number specified on the nameplate conform to the order specifications.

Storage

During periods of non-use, the following guidelines are recommended for storage.

Storage Preparation

- 1) Power up the UPS and allow it to operate with no load for 24 hours to fully charge the batteries.
- 2) Stop the unit.
- 3) Place the Main Circuit Breaker switch in the "OFF" position.







Storage Conditions



- For best results, store the UPS in the original shipping container and place on a wood or metal pallet
- Storage temperature range: -4 to 104 °F (-20 to 40 °C)
- The optimum storage temperature is 70 °F (21 °C). A higher ambient temperature will require recharging more frequently during storage

Avoid the following storage locations:

- Locations that are subject to extreme temperature changes or high humidity
- Locations that are subject to high levels of dust or metal particles
- Locations that are subject to excessive vibration
- Inclined floor surfaces

5 Installation Precautions

 CAUTION	
	<p>Install the UPS in a controlled environment.</p> <p>Improper storage and installation environment may deteriorate insulation, shorten component life and cause malfunctions.</p> <p><i>See Table 5.1 - UPS Installation Environment Standards</i></p>
	<p>DO NOT tilt the UPS more than 10° from upright position.</p> <p>Tilting the UPS more than 10° may cause crushing, trapping or other personal injuries and cause physical damage to internal components.</p>
 WARNING	
	<p>Keep the SPECIFIED CLEARANCE around the UPS.</p> <p>Inadequate space around the UPS makes it difficult to perform maintenance/inspections, will lead to insufficient ventilation, and/or cause malfunctions.</p>
	<p>Install anchor bolts to secure the UPS to the installation floor.</p> <p>The UPS may fall during an earthquake if the anchor bolts are not installed and secured.</p>
	<p>Only factory authorized personnel should relocate, modify, or replace parts in the UPS after initial installation.</p> <p>Electrical shock, injury or UPS failure may occur if non-authorized technicians attempt to modify or relocate the UPS.</p> <p>Please contact Toshiba Customer Support Center if you plan to move or make modifications to the UPS</p>

	<p>DO NOT block air vents. Blocking the vents will increase the internal temperatures and may result in UPS failure or fire.</p>
	<p>DO NOT install the UPS where water may fall on it. Water may cause electrical shock, personal injury or UPS failure.</p>
	<p>DO NOT use floor wax that contains silicon in the UPS storage area and/or nearby rooms. Floor wax that contains silicon may cause static electricity.</p>



 WARNING	
	<p>The UPS should be installed per local and/or national electric codes by qualified personnel. Faults or improper operation may occur if the UPS is not installed properly.</p>
	<p>When an external maintenance bypass is installed for the UPS, before switching to external bypass, ensure that the UPS unit is switched to AC Bypass mode and the UPS control panel display verifies the unit is Bypass mode. Switching to the external bypass while the unit is in UPS mode may damage the UPS.</p>

TABLE 5.1 - UPS INSTALLATION ENVIRONMENT STANDARDS

Item	Environment standard	
Installation Location	Indoors	
Ambient Temperature	Minimum operating temperature: 32 °F (0 °C).	
	Maximum operating temperature: 86 °F (30 °C) at 1.0 PF (UPS with/without battery system).	
	Maximum operating temperature: 90 °F (32 °C) at 0.8 PF (UPS with battery system).	
	Maximum operating temperature: 104 °F (40 °C) at 0.8 PF (UPS only).	
	Average 24-hour operating temperature: 86 °F (30 °C) at 1.0 PF and 41 – 95 °F (5 – 35 °C) at 0.8 PF.	
Relative Humidity	The relative humidity must be between 30 and 90% noncondensing due to temperature changes.	
Altitude	These specifications are for altitudes up to 3240 ft. (1000 m) above sea level. Consult with the factory to determine the derating factor for installations above 3240 ft. (1000 m).	
Vibration and Mechanical Shock	Installation environment must not have vibration frequencies 10 Hz – 20 Hz.	
	The acceleration due to vibrations less than 10 Hz must not exceed 0.5 G.	
	The acceleration due to vibrations 20 Hz – 50 Hz must not exceed 0.5 G.	
	The total amplitude due to vibrations 50 Hz – 100 Hz must not exceed 0.1 mm.	
Dust	Dust must not exceed normal atmospheric levels and must not include conductive particles, silicone or oils.	
Flammable Gas	No flammable and/or explosive gas.	
	Hydrogen sulfide (H ₂ S)	Less than or equal to 0.0001 PPM
	Sulfurous acid gas (SO ₂)	Less than or equal to 0.05 PPM
	Chlorine gas (Cl ₂)	Less than or equal to 0.002 PPM
	Ammonia gas (NH ₃)	Less than or equal to 0.1 PPM
	Nitrous acid gas (NO ₂)	Less than or equal to 0.02 PPM
	Nitrous oxides (NO _x)	Less than or equal to 0.02 PPM
	Ozone (O ₃)	Less than or equal to 0.002 PPM
Hydrochloric acid mist (HCl)	Less than or equal to 0.1 mg/m ³	

Installation Precautions

- 1) Install the unit in a stable, level and upright position that is free of excessive vibration.
- 2) Install the unit where the ambient temperature is within the specified range.
- 3) DO NOT install the UPS in areas that are subject to high humidity.
- 4) DO NOT install the UPS in areas that allow exposure to direct sunlight.
- 5) DO NOT install the UPS in areas that allow exposure to high levels of airborne dust, metal particles, or flammable gases.
- 6) DO NOT install the UPS in areas near sources of electrical noise. Ensuring a proper earth ground will reduce the effects of electrical noise and will reduce the potential for electrical shock.

- 7) The UPS generates and can radiate radio-frequency energy during operation. Although RFI noise filters are installed inside of the unit, there is no guarantee that the UPS will not influence some sensitive devices that are operating near by. If such interference is experienced, the UPS should be installed further away from the affected equipment and/or powered from a different source than that of the installed equipment.
- 8) The user should provide over-current protection for hardwired UPS systems between the UPS output and the load input.
- 9) After ensuring that all power sources are turned "OFF" and isolated in accordance with established lockout/tagout procedures, connect the power source wiring of the correct voltage to the input terminals of the UPS.

NOTE: Ensure the input phasing is connected in clockwise rotation (CW). UPS internal circuitry is designed to disable further UPS operation if the input phasing is installed in counter-clockwise rotation (CCW).

- 10) Connect the output terminals of the UPS to the load (refer to NEC Article 300 - Wiring Methods and Article 310 - Conductors For General Wiring). Size the branch circuit conductors in accordance with NEC Table 310.16 as published 9/2007.

	
WARNING	
	METAL CONDUIT IS NOT AN ACCEPTABLE GROUND.

Conductor Routing and Grounding

- 1) Use separate metal conduits for routing the input power, output power, and control circuits.
- 2) Follow the wire size and tightening torque specifications.
- 3) Always ground the unit to reduce the potential for electrical shock and to help reduce electrical noise.
- 4) A separate ground cable should be run inside the conduit with the input power, output power, and control circuits.

5.1 Wiring/Connection

 WARNING	
	<p>Perform wiring and connections with correct polarity.</p> <p>Be careful when connecting the UPS to the battery system. A wrong connection may cause damage to the UPS, battery, or charger.</p>
	<p>Connect ONLY one (1) ground wire to the earth ground terminal.</p> <p>A missing ground wire may cause an electrical shock hazard. Connecting to more than one ground may cause a ground loop.</p> <p><i>See Chapter 8 - UPS Wiring</i></p>
	<p>DO NOT force, bend, or pull wires. DO NOT damage wire insulation. DO NOT place heavy objects on top of UPS.</p> <p>Observe the above precautions when making wire connections or handling the wires. Failing to observe these precautions may damage the insulation of the wires or may cause a fire or an electric shock hazard.</p>
	
ATTENTION	
<p>Follow the torque criteria for tightening screws.</p> <p>Loose connections may cause fire due to heating.</p> <p><i>See Chapter 11 - UPS Wiring</i></p>	

6 Warning Labels

Below are representative warning labels and their location on the UPS. Exterior Handling labels shown in section 4.3, Transporting/Unpacking, are in the manual packet, and attached to the UPS shipping covering and shipping pallet.

ATTENTION

Make sure all the warning labels are installed in the appropriate locations.

If a label is missing or illegible, contact Toshiba Customer Support Center or an authorized representative.

(A) 48082

DANGER

AC VOLTAGE

This UPS receives power from more than one source. Disconnect all AC sources before performing any service or testing inside this unit

48082

(B) 40308

DANGER

HAZARDOUS VOLTAGES

Hazardous voltages are used in the operation of this equipment and could cause severe personal injury or loss of life. The following precautions should be observed to reduce the risk of injury or death.

Only qualified technicians familiar with this equipment and the information supplied with it should be permitted to install and operate this equipment.

Installation of electrical equipment must be done in accordance with National Electrical Code and any other state or local codes. Proper grounding and conductor sizing must be installed for safe operation.

During operation, keep all covers in place and cabinet doors shut.

When performing visual inspections and maintenance, if possible, be sure the UPS is turned off and the incoming AC feed is turned off and locked out.

The UPS and Battery Cabinet will have hazardous voltages present even after the AC feed is turned off.

If it is necessary to make measurements with the power on, do not touch any electrical connection points. Remove all jewelry from wrists and fingers. Make sure test equipment is in good, safe operating condition.

While servicing, stand on some type of insulation, and be sure not to be grounded.

Follow the safety instructions given in the equipment manual carefully and observe all danger, warning and caution notices.

40308

(C) 56875 FOR 100, 150, 225KVA

USE COPPER CONDUCTORS ONLY!
REFER TO INSTRUCTION MANUAL FOR WIRE SIZE AND TIGHTENING TORQUE

1	2	3	4	5	6	7	8	9	10	11	12	13
U	V	W	U	V	W	N	U	V	W	N	-	+

480 V
AC INPUT

480 V
BYPASS INPUT

480 V
AC OUTPUT

400 V
BATTERY

(C) 58708 FOR 300KVA

USE COPPER CONDUCTORS ONLY!
REFER TO INSTRUCTION MANUAL FOR WIRE SIZE AND TIGHTENING TORQUE

1	2	3	4	5	6	7	8	9	10	11	12
U	V	W	-	+	U	V	W	N	U	V	W

480 V
AC INPUT

400 V
BATTERY

480 V
BYPASS INPUT

480 V
AC OUTPUT

(D) 40830

WARNING

CRITICAL FUSE SIZING

Incorrect fuse replacement size may result in fire or inadequate equipment protection.

Replace only with same type and rating of fuse.

PN 40830

(E) 39561

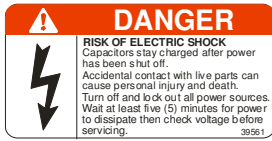

(F) 58705 SERIAL LABEL

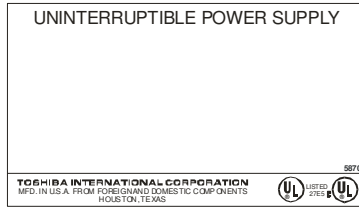

(G) 57055



(I) 40831

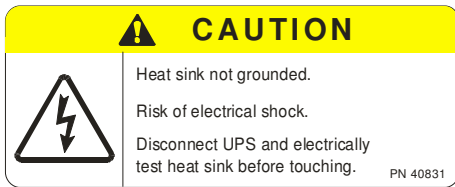

(J) 57053

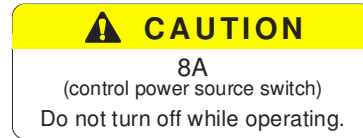

6.1 Warning Label Locations

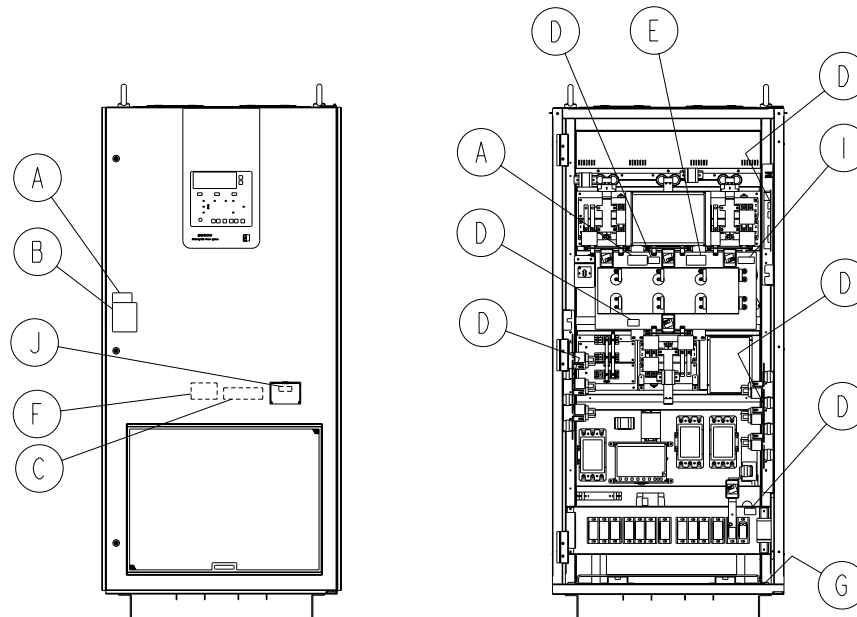

FIGURE 6.2 – 100 KVA UPS WARNING LABELS

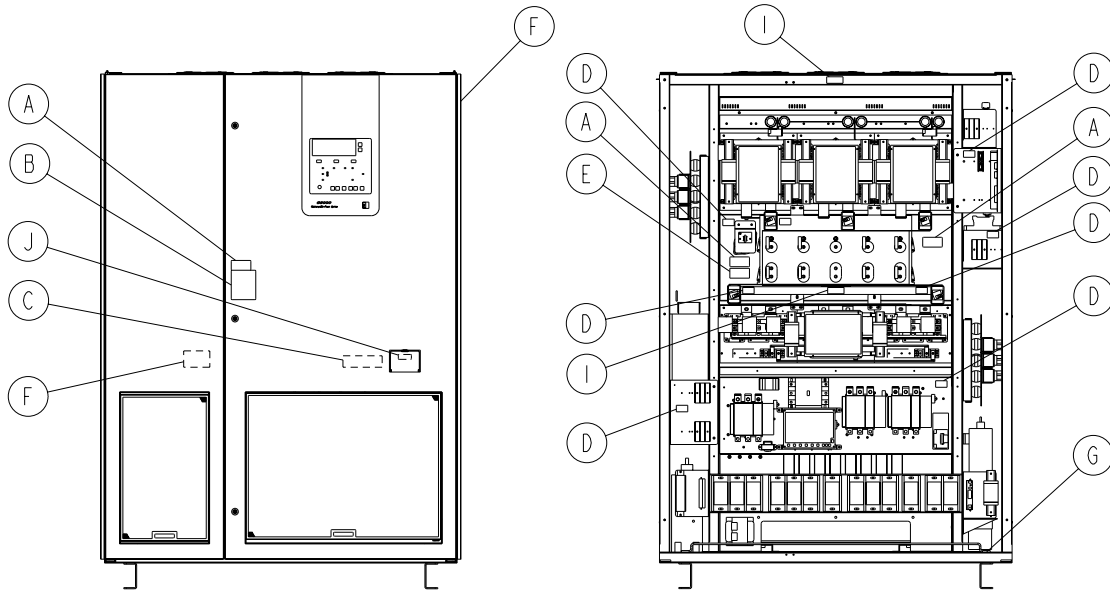

FIGURE 6.3 – 150/225 KVA UPS WARNING LABELS

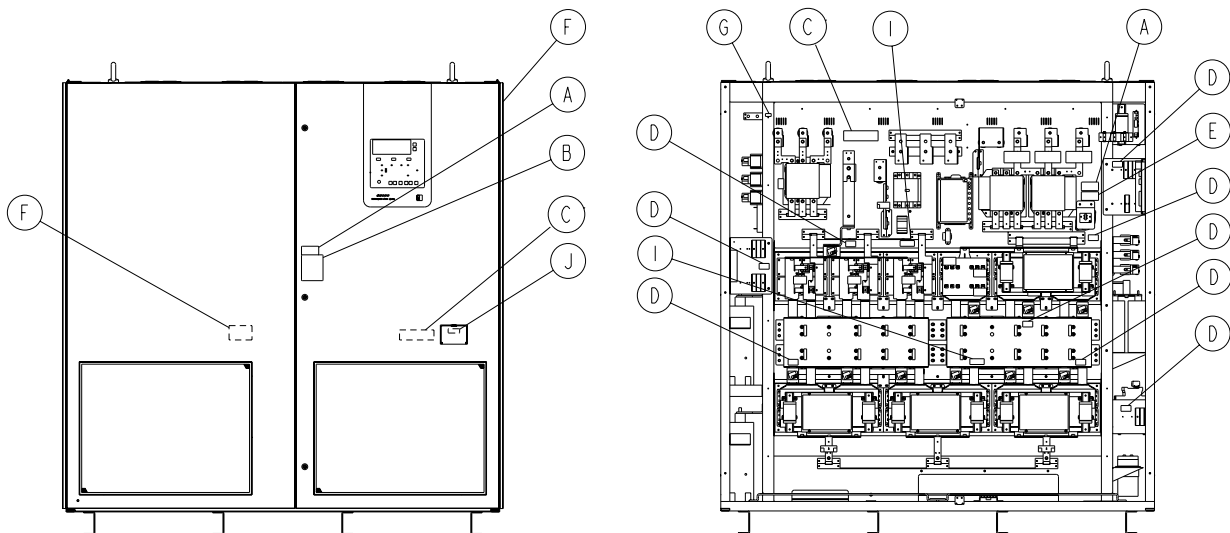

FIGURE 6.4 - 300 KVA UPS WARNING LABELS

7 Weight and Dimensions

Table 7.1 lists the unit and shipping weights for G8000 UPS models illustrated in Figures 7.1 – 7.3.

TABLE 7.1 G8000 UPS UNIT AND SHIPPING WEIGHTS

Model	Unit	Shipping
100 kVA	1740 lb. (789 kg)	1790 lb. (812 kg)
150 kVA	2467 lb. (1119 kg)	2556 lb. (1159 kg)
225 kVA	2980 lb. (1352 kg)	3069 lb. (1392 kg)
300 kVA	4575 lb. (2075 kg)	4725 lb. (2143 kg)

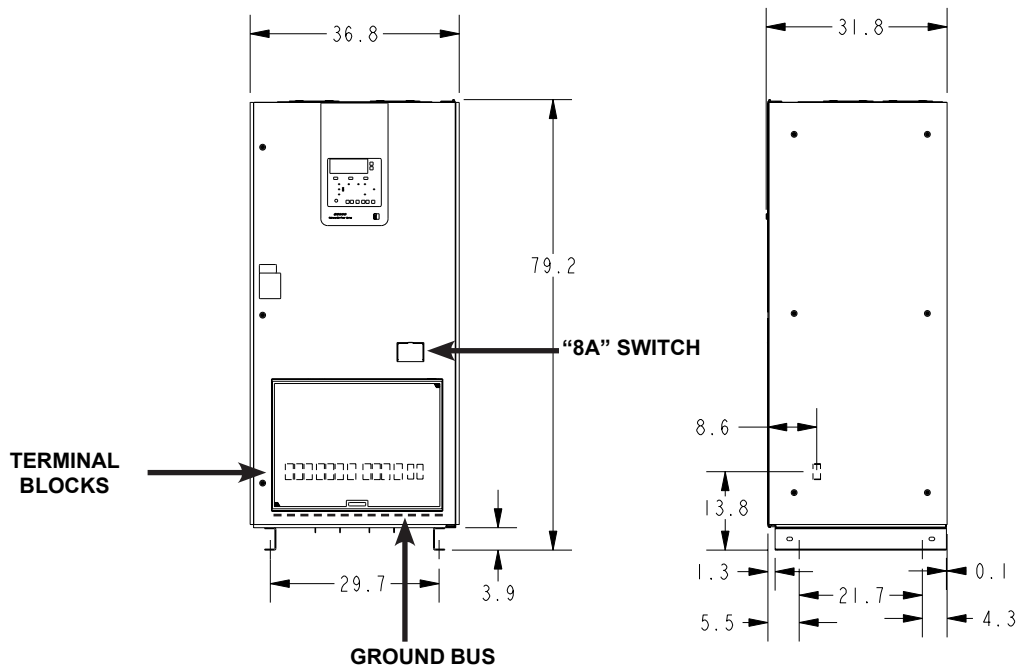

FIGURE 7.1 – 100 KVA UPS EXTERIOR DIMENSIONS (INCHES)

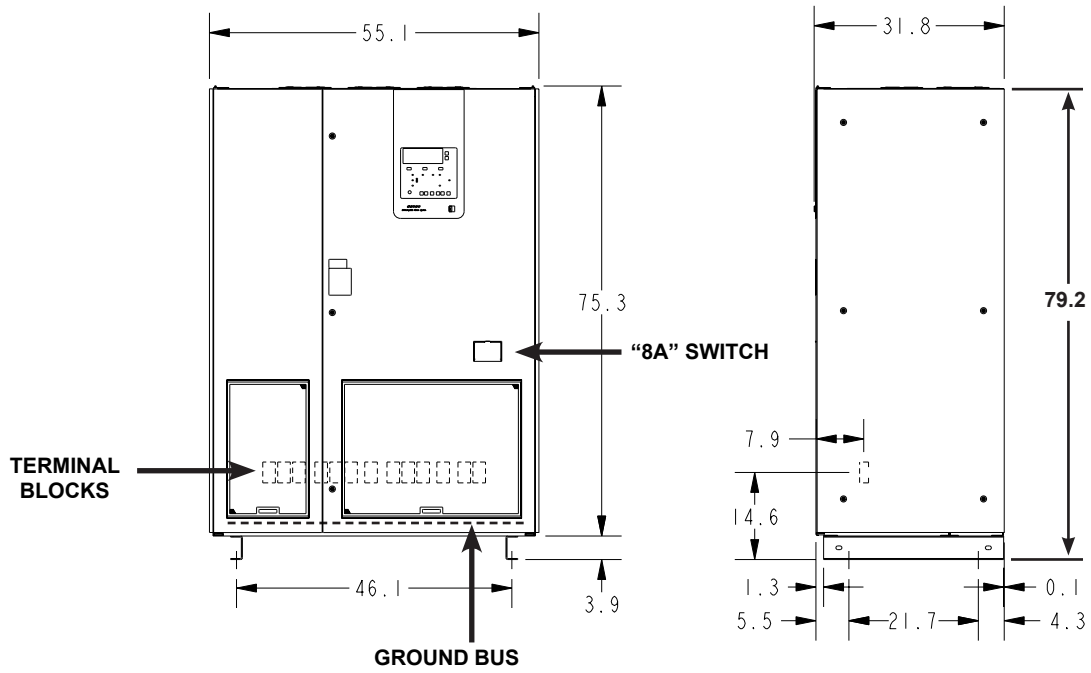

FIGURE 7.2 - 150/225 KVA UPS EXTERIOR DIMENSIONS (INCHES)

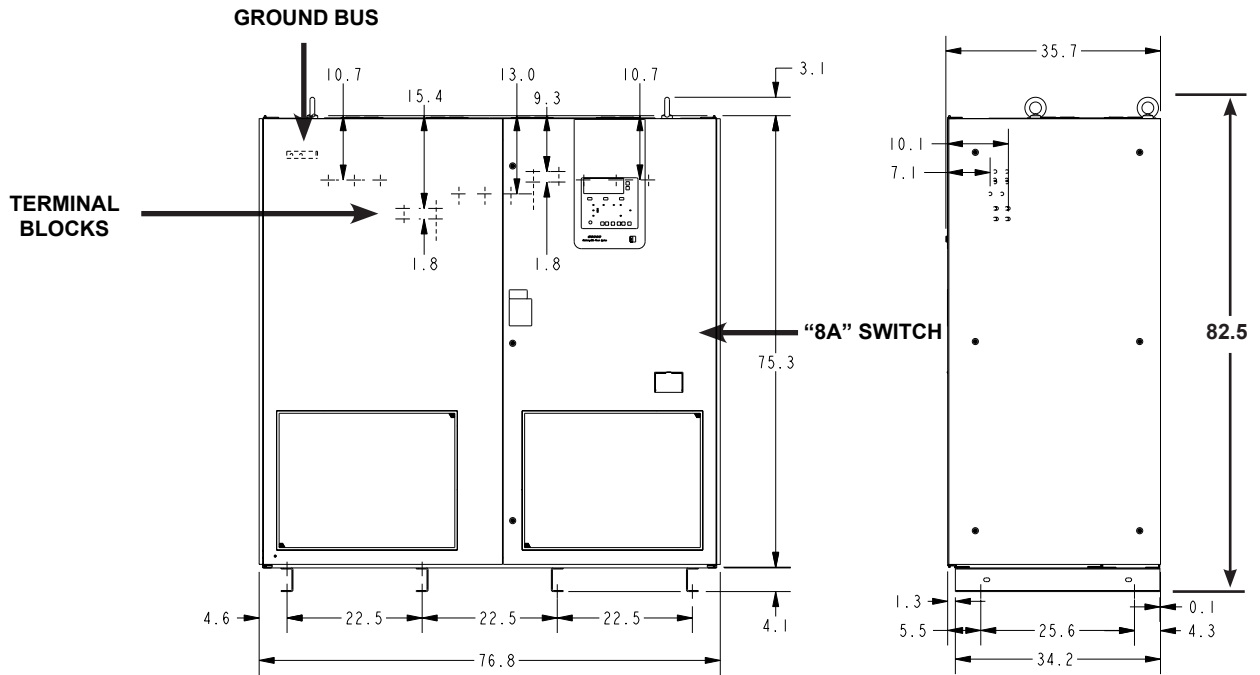







FIGURE 7.3 - 300 KVA UPS EXTERIOR DIMENSIONS (INCHES)

8 Transporting

WARNING	
<p>When transporting the UPS by crane, follow the SPECIFIED WORK PROCEDURE. The suspension wire angle should be less than 60°.</p> <p>The UPS falling or overturning may cause crushing, trapping or other personal injuries.</p>	
	<p>DO NOT tilt the UPS more than 10° from upright position.</p> <p>Tilting the UPS more than 10° may cause crushing, trapping or other personal injuries.</p>
CAUTION	
	<p>DO NOT transport, move, store, or place the UPS on its side.</p> <p>Excessive force applied from heavy components inside may damage the UPS.</p>
	<p>Avoid vibration or shock exceeding 0.5G.</p> <p>Failing to observe this precaution may cause damage to the UPS.</p>
	<p>DO NOT allow the UPS to suffer shock or impact when unpacking.</p> <p>Tools used to remove packaging materials may cause damage to the UPS.</p>
	<p>DO NOT install the UPS where water may fall on it.</p> <p>Water may cause electrical shock, personal injury or UPS failure.</p>
	<p>DO NOT push or pull on the sides of the packaging, or the UPS to move it. Always use a crane, forklift, or pallet jack for transporting and positioning the UPS.</p> <p>Pushing/pulling on the sides of the unit to move it may result in damage to the UPS. (See Figure 4.1 Exterior Handling label.)</p>

The UPS may be packed in a crate for extra protection during transportation. Avoid impact or vibration against the UPS during transportation. DO NOT expose the UPS directly to water.

8.1 Transporting By Crane

Cables should have sufficient ratings and be of the same length. Make sure the suspension cables are hooked at eyebolts. See Figure 8.1. Keep the angle less than 60° between cables.

Refer to Chapter 7 - Weight and Dimension for UPS cabinet weight.

Keep UPS leveled when lifting. DO NOT swing or tilt the UPS. Minimize the impact when lowering the UPS to the floor. Figure 8.2 and 8.3 indicate unacceptable lifting.

Figure 8.4 and 8.5 show examples of acceptable and unacceptable operations.

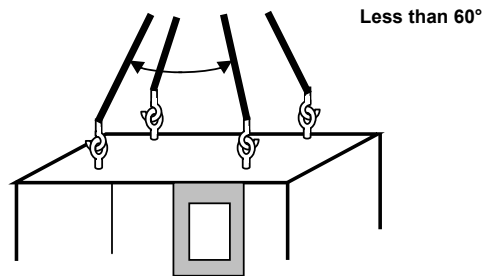

FIGURE 8.1 - CABLES AND EYEBOLTS TO LIFT THE UPS

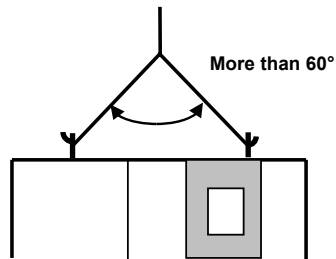

FIGURE 8.2 - ANGLE MORE THAN 60°

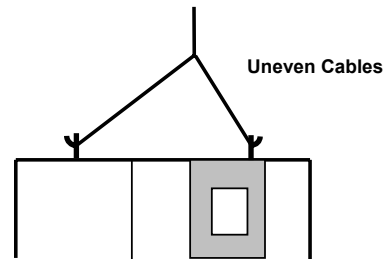

FIGURE 8.3 - UNEVEN CABLES

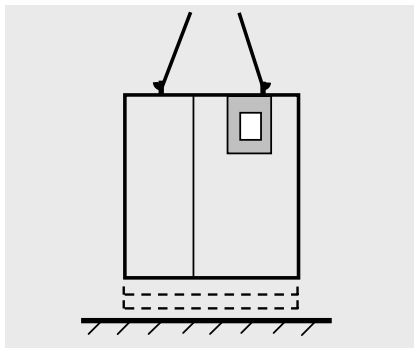

FIGURE 8.4 - ACCEPTABLE OPERATION

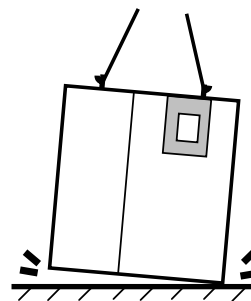

FIGURE 8.5 - UNACCEPTABLE OPERATION

8.2 Transporting By Forklift

Refer to Chapter 7 - Weight and Dimensions.

Verify forklift maximum load capacity and ensure that the forks are long enough to properly support the UPS. Insert the forks into the space shown in Figure 8.6. Spaces for the forks are provided underneath the UPS.

DO NOT swing or tilt UPS when lifting and/or transporting. Minimize the impact when lowering the UPS to the floor.

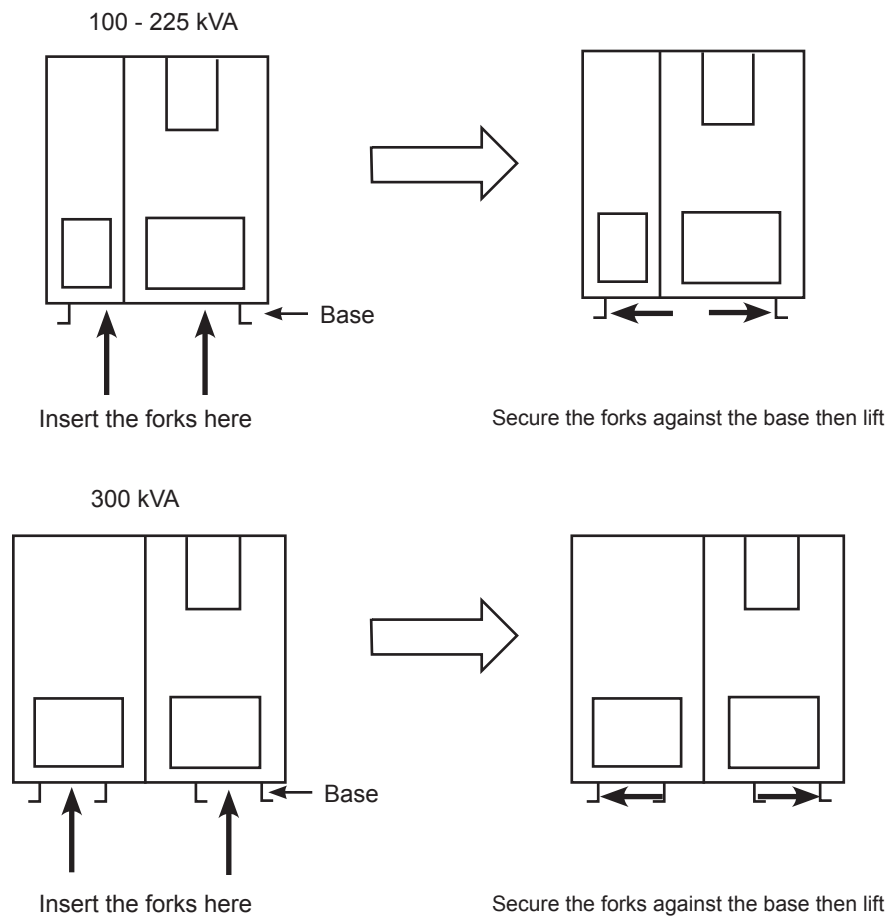

FIGURE 8.6 -TRANSPORTING UPS BY FORKLIFT

9 Storage/Operating Environment

Observe the following when storing the UPS.

- Store UPS indoors.
- Maximum storage time for the UPS between powered operation cycles is three years. If the UPS has been stored for a period exceeding 36 months, contact your factory authorized representative of guidance in starting the unit.
- Temperature fluctuations should be minimized.
- The optimal storage temperature range is 68 – 77 °F (20 – 25° C).
- A maximum temperature range of 32 – 104 °F (0 – 40 °C) should be observed.
- The optimal relative humidity at the storage location should be between 50 – 60%.
- Humidity must not exceed 90%.
- Avoid locations where UPS may be exposed to corrosive gas.
- Avoid locations with dirt and/or dust.

TABLE 9.1 - UPS STORAGE/OPERATING ENVIRONMENT STANDARDS



Item	Environment standard	
Storage Location	Indoors	
Ambient Temperature	Minimum storage temperature: 32 °F (0 °C)	
	Maximum storage temperature: 104 °F (40 °C)	
Relative Humidity	The relative humidity must be between 30 and 90% and without condensation due to temperature changes.	
Altitude	This equipment is rated for installations up to 3240 ft. (1000m) above sea level. Consult with the factory to determine the derating factor for installations above 3240 ft. (1000m).	
Dust	Dust must not exceed normal atmospheric levels and must not include conductive particles, silicone or oils.	
Flammable Gas	No flammable and/or explosive gas.	
	Hydrogen sulfide (H ₂ S)	Less than or equal to 0.0001 PPM
	Sulfurous acid gas (SO ₂)	Less than or equal to 0.05 PPM
	Chlorine gas (Cl ₂)	Less than or equal to 0.002 PPM
	Ammonia gas (NH ₃)	Less than or equal to 0.1 PPM
	Nitrous acid gas (NO ₂)	Less than or equal to 0.02 PPM
	Nitrous oxides (NO _x)	Less than or equal to 0.02 PPM
	Ozone (O ₃)	Less than or equal to 0.002 PPM
	Hydrochloric acid mist (HCl)	Less than or equal to 0.1 mg/m ³



9.1 Operating Precautions

Initial startup/comisioning of the UPS should be performed by factory authorized personnel.

- 1) The UPS should not be powered up until the entire operation manual has been read.
- 2) The voltage of the input power source must be within the rated input voltage range. The input frequency range must be within the rated input frequency range.

- 3) The UPS should not be used with a load that has a rated input that is greater than the rated output of the UPS.
- 4) If using the UPS to provide power to motors that require high starting current or with motors that require a long starting time, call Toshiba support for guidance in over sizing the UPS for lock rotor current.
- 5) DO NOT insert metal objects or combustible materials in the ventilation slots of the UPS.
- 6) DO NOT place, hang, or paste any objects on the exterior surfaces of the UPS.
- 7) The capacitors in the UPS maintain a residual charge for a while after turning the UPS off. The required discharge time for each UPS typeform is provided via a cabinet label and a **CHARGE LED**. Wait for at least the minimum time indicated on the label and ensure that the **CHARGE LED** has gone out before opening the door of the UPS once the UPS power has been turned off.
- 8) DO NOT attempt to disassemble, modify, or repair the UPS. Call your Toshiba sales representative for repair information.
- 9) Turn the power on only after installing **ALL** of the covers.
- 10) DO NOT remove any covers of the UPS when power is on.
- 11) If the UPS should emit smoke or an unusual odor or sound, turn the power off immediately.
- 12) Warning signs should be placed on or near the load as a notification that the load is being powered by the UPS.
- 13) Additional warnings and notifications shall be posted at the equipment installation location as deemed required by **Qualified Personnel**.

 WARNING	
	<p>While operating in the inverter mode, placing the input breaker in the “OFF” position will switch the UPS to the battery backup mode.</p> <p>The output of the UPS will continue uninterrupted to the load. The unit must be in the bypass mode at the time that the breaker is placed in the “OFF” position for the UPS to shutdown power to the load.</p>

 CAUTION	
	<p>After an Emergency Power Off (EPO), DO NOT reset the breaker until the UPS internal circuits have been fully discharged.</p> <p>The UPS could be damaged if the unit is not fully discharged before the breaker is reset.</p>

9.2 Maintenance Precautions

All internal maintenance should be performed by factory authorized personnel.

- 1) Turn off, lockout, and tagout ALL power sources before connecting the power wiring to the equipment or when performing maintenance.
- 2) Hardwire type UPS units are not equipped with an over-current protection device, nor do they have an output disconnect for the AC output. A user-installed circuit breaker should be provided between the UPS output and the load input.
- 3) The maximum ambient operating temperature is 86 °F (30 °C) at 1.0 PF, and 104 °F (40 °C) at 0.8 PF.
- 4) Only factory authorized personnel should service the UPS. Contact Toshiba for the nearest authorized service center.
- 5) Battery servicing should be performed by factory authorized personnel only. Contact your nearest factory authorized service center for battery replacement.



Qualified Personnel ONLY!





Qualified Personnel have the skills and knowledge relating to the construction, installation, operation, and maintenance of the electrical equipment and has received safety training on the hazards involved (Refer to the latest edition of NFPA 70E for additional safety requirements).

Qualified Personnel shall:

- 1) Have read the entire operation manual.
- 2) Be trained and authorized to safely energize, de-energize, ground, lockout and tag circuits and equipment, and clear faults in accordance with established safety practices.
- 3) Be trained in the proper use and care of protective equipment such as safety shoes, rubber gloves, hard hats, safety glasses, face shields, flash clothing, etc., in accordance with established safety practices.
- 4) Be trained in rendering first aid.
- 5) Be knowledgeable of batteries and the required handling and maintenance precautions.

For further information on workplace safety visit www.osha.gov.

 WARNING	
	<p>Misuse of equipment could result in injury and equipment damage.</p> <p>In no event will Toshiba Corporation be responsible or liable for either indirect or consequential damage or injury that may result from the misuse of this equipment.</p>

 CAUTION	
	DO NOT dispose of the batteries in a fire. The batteries may explode.
	DO NOT open or mutilate the batteries. Released electrolyte is harmful to the eyes and skin and could also be toxic.
 DANGER	
	A battery can present a risk of electrical shock and high short circuit current.







9.3 Disposal

Please contact your local or state environmental agency for details on disposal of electrical components and packaging in your particular area.

It is illegal to dump lead-acid batteries in landfills or dispose of them improperly.

Please help protect the Earth by contacting the environmental protection agencies in your area, the battery manufacturer, or call Toshiba toll-free at (877) 867-8773 for more information about recycling batteries.

10 Installation

WARNING	
	<p>Keep the SPECIFIED CLEARANCE around the UPS.</p> <p>Inadequate space around the UPS makes it difficult to perform maintenance/inspections, lead to insufficient ventilation, and/or will cause malfunctions.</p> <p><i>See Figure 10.1 - UPS Clearance</i></p>
	<p>DO NOT tilt the UPS more than 10° from upright position.</p> <p>Tilting the UPS more than 10° may cause crushing, trapping or other personal injuries.</p>
	<p>Install anchor bolts to secure the UPS to the installation floor.</p> <p>The UPS may fall during an earthquake if the anchor bolts are not installed and secured.</p>
	<p>DO NOT transport, move, store, or place the UPS on its side.</p> <p>Forces due to heavy components inside may damage the UPS.</p>
	<p>DO NOT allow the UPS to suffer shock or impact when unpacking.</p> <p>Tools used to remove packaging materials may cause damage to the UPS.</p>
	<p>DO NOT push or pull on the sides of the packaging or the UPS to move it. Always use a crane, forklift, or pallet jack for transporting and positioning the UPS.</p> <p>Pushing/pulling on the sides of the unit to move it may result in damage to the UPS. See Figure 4.1 Exterior Handling label.</p>

10.1 Unpacking

Unpack the UPS indoors on a paved floor. The UPS should be as close as possible to its final storage location. Overhead traveling cranes should be used to unpack any G8000 Series UPS. If an overhead traveling crane is not available, allow enough space for forklift operations to unpack the UPS crate. Then remove the crate.

Points to observe

- Retain all small articles during unpacking and installation.
- Make sure that exterior paint is not scratched and that the UPS cabinet is not damaged.
- DO NOT damage the UPS when using tools to remove packaging materials.
- If provided, DO NOT remove the plastic sheet cover, until installation.
- Do not remove the fan covers until UPS start up. The fan covers should be removed by factory authorized personnel. Packing materials should be disposed by the appropriate means.
- Immediately report any abnormalities to Toshiba Customer Support Center or an authorized representative.

10.2 UPS Clearance

Maintain the indicated clearance during installation. See Figure 10.1. Ensure that the front and top air vents are NOT blocked.

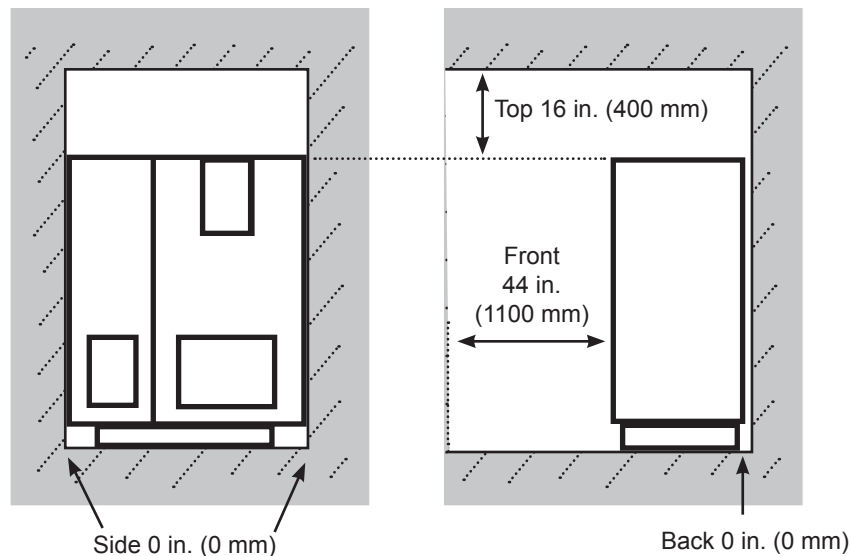

FIGURE 10.1 - UPS CLEARANCE

10.3 Anchor Bolts

Install the anchor bolts to secure the UPS on the floor. See Figure 10.2 for anchor bolt installation detail. Use 12mm (1/2") diameter anchor bolts. There are 16mm (5/8") diameter holes provided in the UPS base. See Figure 10.3 for the hole locations and dimensions for the specified UPS models.

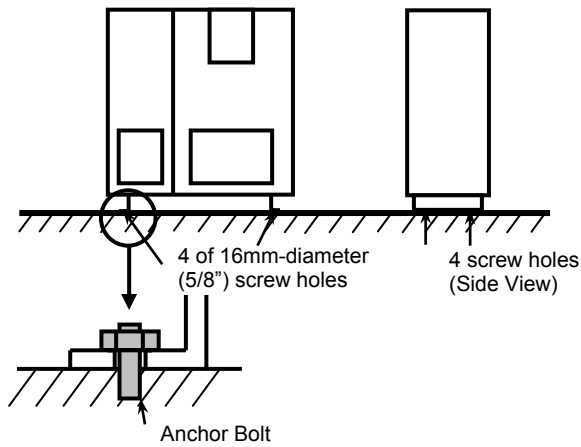

FIGURE 10.2
ANCHOR BOLT INSTALLATION DETAIL

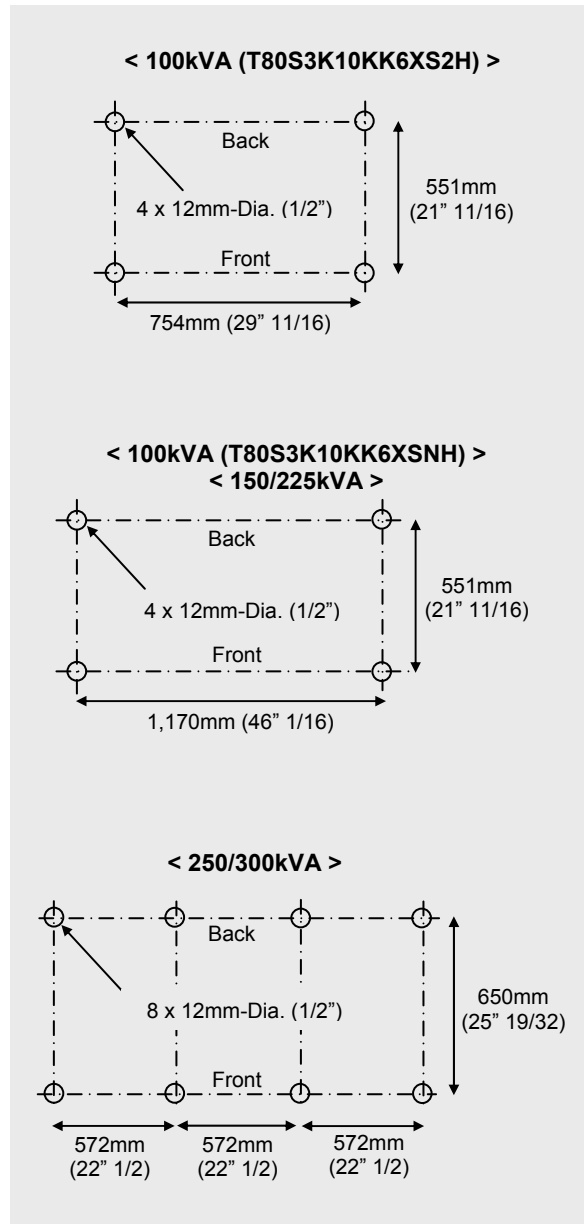

FIGURE 10.3
HOLE LOCATIONS/DIMENSIONS
ON BOTTOM OF UPS

11 UPS Wiring

Note: Always consult your local and NEC electrical codes for wiring, cabling, and circuit protection device requirements.

Figure 11.1 illustrates the external wiring of the G8000 UPS. See corresponding section to each wiring term.

- Power cable connection at terminal blocks/buses and external breaker provision for the AC input/output, Bypass Input and DC input.
- Earth ground wire at grounding terminal.
- Control wire terminal TB1 (battery cabinet and bypass breaker)

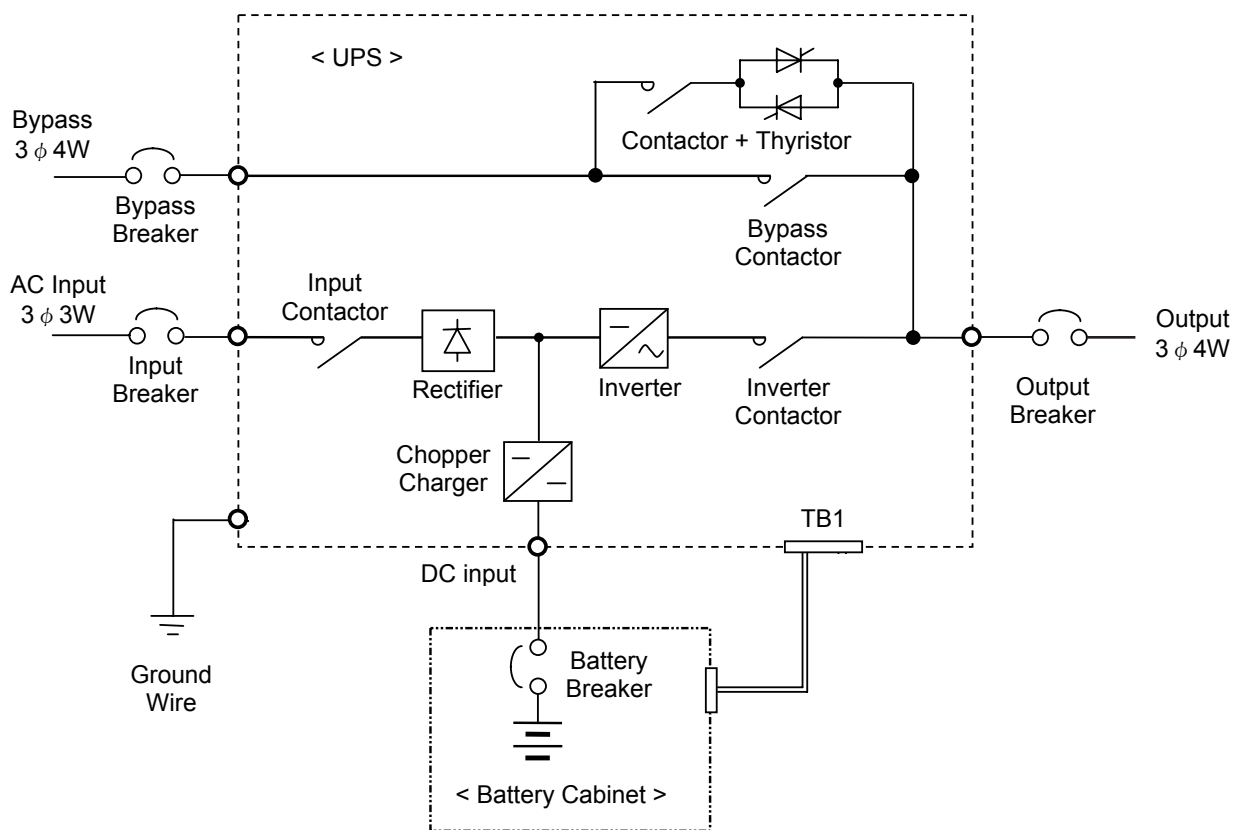

FIGURE 11.1 - EXTERNAL WIRING DIAGRAM

An external maintenance bypass may be installed in parallel with the UPS to allow servicing of the G8000 while maintaining power to the UPS load. Contact the Toshiba Customer Service for further information.

11.1 100 kVA Terminal Blocks and Power Cables

Note: Always consult your site specific, local, state, and NEC electrical codes for wiring, cabling, and circuit protection device requirements.

The terminal blocks for the 100 kVA UPS are shown in Figure 11.2.

Recommended external cable size and tightening torque for a single battery string are listed in Table 11.3–11.5. For two or more battery strings consult with Toshiba Technical Support. Ensure that your installation adheres to local and NEC electrical codes.

Use only copper wires for external cables.

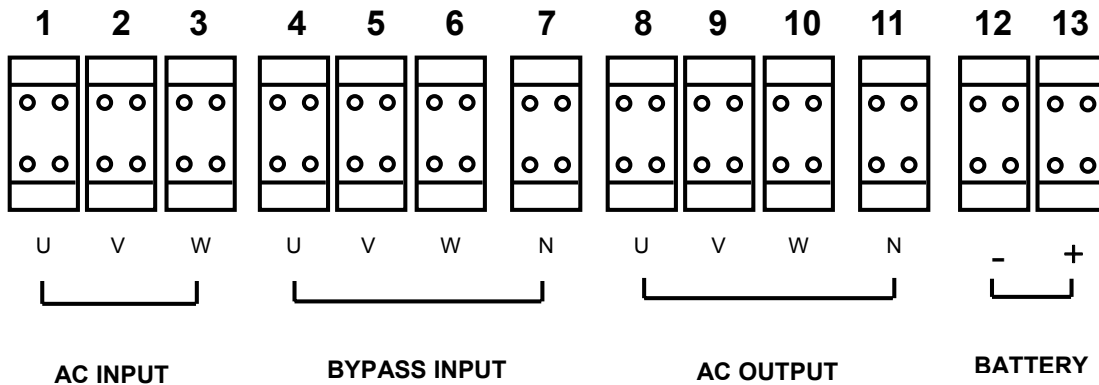

FIGURE 11.2 - TERMINAL BLOCKS FOR 100 KVA UPS

TABLE 11.1 RECOMMENDED CABLE SIZE & TIGHTENING TORQUE FOR 100 KVA UPS

Block Number	Cable Size**	Tightening Torque
1	AWG 1/0 or larger	275 in.-lb. (3.2 kg-m)
2	AWG 1/0 or larger	275 in.-lb. (3.2 kg-m)
3	AWG 1/0 or larger	275 in.-lb. (3.2 kg-m)
4	AWG 1/0 or larger	275 in.-lb. (3.2 kg-m)
5	AWG 1/0 or larger	275 in.-lb. (3.2 kg-m)
6	AWG 1/0 or larger	275 in.-lb. (3.2 kg-m)
7	AWG 1/0 or larger	275 in.-lb. (3.2 kg-m)
8	AWG 1/0 or larger	275 in.-lb. (3.2 kg-m)
9	AWG 1/0 or larger	275 in.-lb. (3.2 kg-m)
10	AWG 1/0 or larger	275 in.-lb. (3.2 kg-m)
11	AWG 1/0 or larger	275 in.-lb. (3.2 kg-m)
*12	Two AWG 2/0	275 in.-lb. (3.2 kg-m)
*13	Two AWG 2/0	275 in.-lb. (3.2 kg-m)

* One battery string. (Consult factory if using more than one battery string.)

** Maximum cable size is AWG 2/0

11.2 150, 225, and 300 kVA Buss Strip Terminals and Power Cables

Note: Always consult your site specific, local, state, and NEC electrical codes for wiring, cabling, and circuit protection device requirements.

The 150, 225, and 300 kVA UPS units have buss strip power terminals. Figure 11.3 is a typical buss strip for a 150/225 kVA UPS.

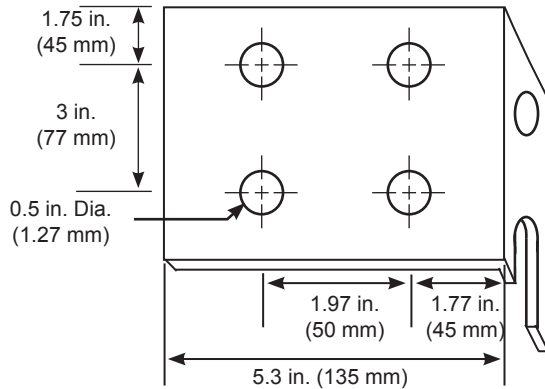

FIGURE 11.3 - TERMINAL BUS DETAIL

Figure 11.4 shows the arrangement of the terminal buss strips for the 150 and 225 kVA UPS units. The terminal buss strips are located inside, at the bottom of the UPS. The dashed line indicates the side view of the bolt holes. Use 1/2 inch bolts to attach the lugs.

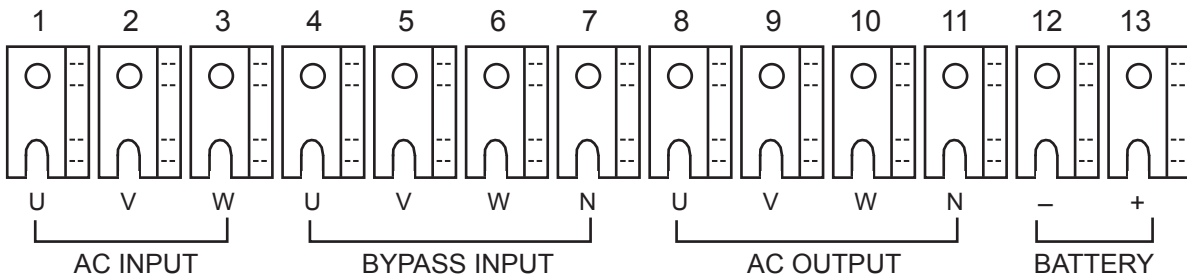

FIGURE 11.4 - TERMINAL BUSS ARRANGEMENT FOR 150 AND 225 KVA UPS

Figure 11.5 shows the arrangement of the terminal buss strips for the 300 kVA UPS. The buss strips are located inside at the top of the unit.

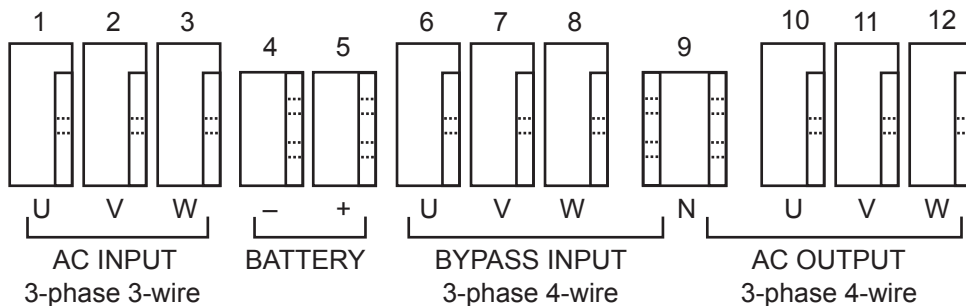

FIGURE 11.5 - TERMINAL BUSS ARRANGEMENT FOR 300 KVA UPS

For UPS' equipped with buss strip terminals for the A/C INPUT, BYPASS INPUT, A/C OUTPUT and BATTERY connections, Toshiba recommends using the compression lugs listed in Table 11.2, or their equivalent, for cable terminations to be mounted on the bus strips.

See Table 11.3 – Table 11.5 for recommended cable sizes for the 150, 225, and 300 kVA UPS.

TABLE 11.2 RECOMMENDED CRIMP TYPE COMPRESSION LUGS FOR BUS STRIP TERMINALS

Wire Size	Wire Strand Class	Recommendation		Crimp tool Required Burndy type Y35 or Y46	
		Vendor	Cat. No.	Color Key	Die Index
1/0	B	Burndy	YA25	Pink	12 / 348
	I	IlSCO	CRA-1/OL	Pink	12 / 348
	B	Burndy	YA25-LB	Black	13
2/0	B	Burndy	YA26	Black	13
	I	IlSCO	CRA-2/OL	Black	13
	B	Burndy	YA27-LB	Orange	14 / 101
3/0	B	Burndy	YA-27	Orange	14 / 101
	I	IlSCO	CRB-3/OL	Orange	14 / 101
	B	Burndy	YA28-LB	Purple	15
4/0	B	Burndy	YA28	Purple	15
	I	IlSCO	CRB-4/OL	Purple	15
	B	Burndy	YA29-LB	Yellow	16
300 MCM	B	Burndy	YA30	White	17 / 298
	I	IlSCO	CRA-30OL	White	17 / 298
	B	Burndy	YA32-LB	Red	18 / 324
350 MCM	B	Burndy	YA31L	Red	18
	I	IlSCO	CRA-350	Red	18
600 MCM	B	Burndy	YA36L	Green	22
	I	IlSCO	CRA-600	Green	22

TABLE 11.3 RECOMMENDED CABLE SIZE AND FASTENER TORQUE FOR 150 KVA UNIT

Block Number	Cable Size	Recommended Fastener Torque **
1	AWG 4/0 or larger	540 in.-lb. (6.2 kg-m)
2	AWG 4/0 or larger	540 in.-lb. (6.2 kg-m)
3	AWG 4/0 or larger	540 in.-lb. (6.2 kg-m)
4	AWG 4/0 or larger	540 in.-lb. (6.2 kg-m)
5	AWG 4/0 or larger	540 in.-lb. (6.2 kg-m)
6	AWG 4/0 or larger	540 in.-lb. (6.2 kg-m)
7	AWG 4/0 or larger	540 in.-lb. (6.2 kg-m)
8	AWG 4/0 or larger	540 in.-lb. (6.2 kg-m)
9	AWG 4/0 or larger	540 in.-lb. (6.2 kg-m)
10	AWG 4/0 or larger	540 in.-lb. (6.2 kg-m)
11	AWG 4/0 or larger	540 in.-lb. (6.2 kg-m)
*12	Two 300 MCM or larger	540 in.-lb. (6.2 kg-m)
*13	Two 300 MCM or larger	540 in.-lb. (6.2 kg-m)

* One battery string. (Consult factory if using more than one battery string.)

** Fastener torque specified for: 1/2 in. diameter grade 5 steel bolt.

TABLE 11.4 RECOMMENDED CABLE SIZE AND FASTENER TORQUE FOR 225 KVA UNIT

Block Number	Cable Size	Recommended Fastener Torque **
1	Two AWG 2/0 or larger	540 in.-lb. (6.2 kg-m)
2	Two AWG 2/0 or larger	540 in.-lb. (6.2 kg-m)
3	Two AWG 2/0 or larger	540 in.-lb. (6.2 kg-m)
4	Two AWG 2/0 or larger	540 in.-lb. (6.2 kg-m)
5	Two AWG 2/0 or larger	540 in.-lb. (6.2 kg-m)
6	Two AWG 2/0 or larger	540 in.-lb. (6.2 kg-m)
7	Two AWG 2/0 or larger	540 in.-lb. (6.2 kg-m)
8	Two AWG 2/0 or larger	540 in.-lb. (6.2 kg-m)
9	Two AWG 2/0 or larger	540 in.-lb. (6.2 kg-m)
10	Two AWG 2/0 or larger	540 in.-lb. (6.2 kg-m)
11	Two AWG 2/0 or larger	540 in.-lb. (6.2 kg-m)
*12	Three AWG 4/0 or larger	540 in.-lb. (6.2 kg-m)
*13	Three AWG 4/0 or larger	540 in.-lb. (6.2 kg-m)

* One battery string. (Consult factory if using more than one battery string.)

** Fastener torque specified for: 1/2 in. diameter grade 5 steel bolt.

TABLE 11.5 RECOMMENDED CABLE SIZE AND FASTENER TORQUE FOR 300 KVA UPS

Bus Number	Cable Size	Recommended Fastener Torque **
1	Two AWG 4/0 or larger	540 in.-lb. (6.2 kg-m)
2	Two AWG 4/0 or larger	540 in.-lb. (6.2 kg-m)
3	Two AWG 4/0 or larger	540 in.-lb. (6.2 kg-m)
*4	Three 350 MCM or larger	540 in.-lb. (6.2 kg-m)
*5	Three 350 MCM or larger	540 in.-lb. (6.2 kg-m)
6	Two AWG 4/0 or larger	540 in.-lb. (6.2 kg-m)
7	Two AWG 4/0 or larger	540 in.-lb. (6.2 kg-m)
8	Two AWG 4/0 or larger	540 in.-lb. (6.2 kg-m)
9	Two AWG 4/0 or larger	540 in.-lb. (6.2 kg-m)
10	Two AWG 4/0 or larger	540 in.-lb. (6.2 kg-m)
11	Two AWG 4/0 or larger	540 in.-lb. (6.2 kg-m)
12	Two AWG 4/0 or larger	540 in.-lb. (6.2 kg-m)

* One battery string. (Consult factory if using more than one battery string.)

** Fastener torque specified for: 1/2 in. diameter grade 5 steel bolt.

11.3 UPS Power Cable Knockout Plates

Cable knockout plates are provided at the bottom of the 100 kVA UPS, and at the top and bottom of the 150/225 kVA UPS. (Older models of the G8000 150/225 kVA UPS do not come equipped with an upper knockout plate.) The recommended hole locations are illustrated in Figure 11.6, 11.7, and 11.8.

The five (5) holes must be punched during installation. The dashed rectangle indicates the UPS opening behind the knockout plates.

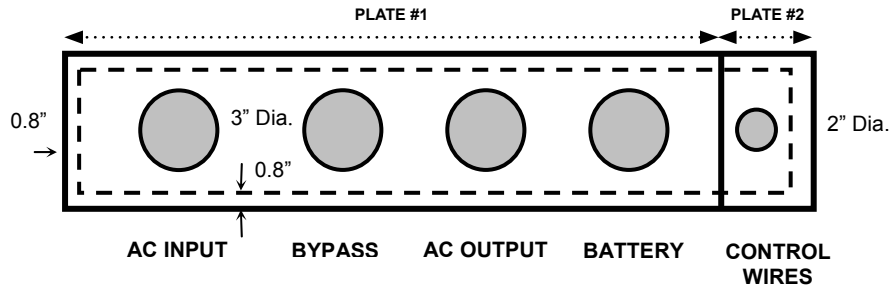

FIGURE 11.6 - BOTTOM CABLE KNOCKOUT PLATES FOR 100 KVA (T80S3K10KK6XS2H)

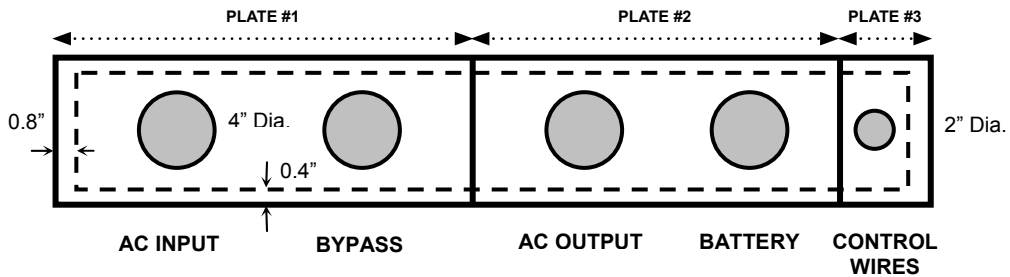

FIGURE 11.7 - BOTTOM CABLE KNOCKOUT PLATES 100 KVA (T80S3K10KK6XSNH); 150/225 KVA

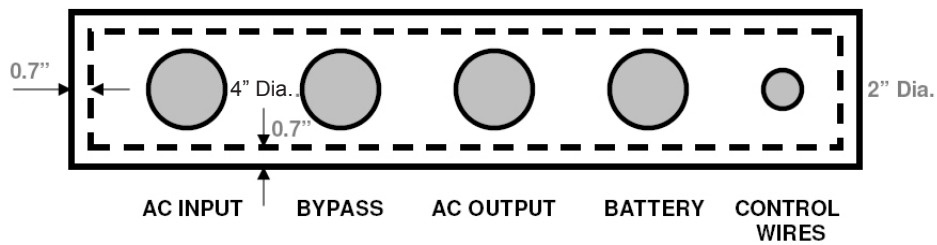

FIGURE 11.8 - TOP ACCESS KNOCKOUT PLATE (IF AVAILABLE - 150 AND 225 KVA ONLY)

Figure 11.9 shows the four (4) cable knockout plates provided at the top of the 300 kVA UPS. Seven (7) holes must be punched during installation. The dashed rectangle indicates the UPS opening behind the knockout plates.

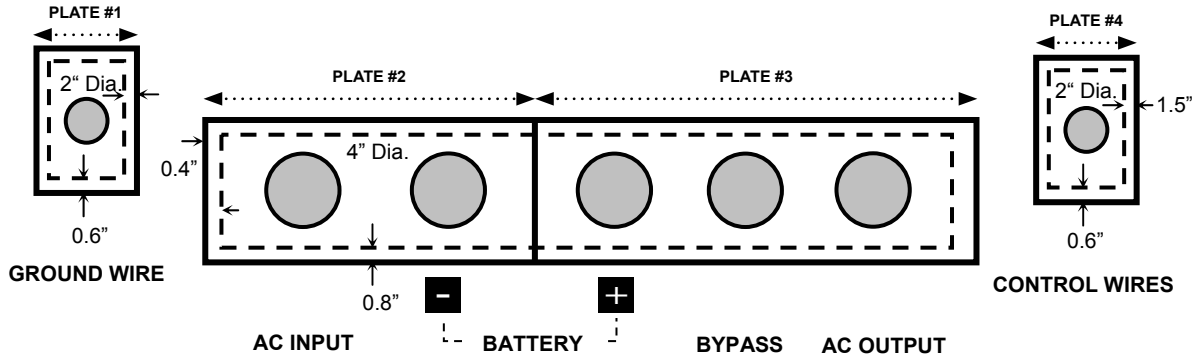

FIGURE 11.9 - TERMINAL KNOCKOUT PLATES FOR THE 300 KVA UPS

11.4 External Breakers

The G8000 UPS units are not equipped with circuit breakers. Qualified personnel should provide the external breakers for the AC input/output, bypass input and DC input.



See Figure 11.1 – External Wiring Diagram, for the circuit position of the breakers.

Table 11.6 shows the G8000 UPS minimum external breaker rating for each capacity. The bypass input and the AC output require 3-pole breakers.

TABLE 11.6 EXTERNAL BREAKER RATING

Capacity	AC Input / Bypass Input / AC Output Minimum Breaker Rating	DC Input Minimum Breaker Rating
100 kVA	480 V - 200 A	500 VDC – 500 A
150 kVA	480 V - 300 A	500 VDC – 700 A
225 kVA	480 V - 450 A	500 VDC – 1100 A
300 kVA	480 V - 500 A	500 VDC – 1500 A

11.5 Grounding Wire

 WARNING	
	<p>Be sure to ground the UPS as specified.</p> <p>Using the UPS without a proper ground will deteriorate the insulation, cause leakage of currents and electric shock. The resistance to ground should be less than or equal to 10 ohms.</p>

The 100/150/225kVA earth grounding bus is located inside, at the bottom-front of the unit. The 300 kVA earth grounding bus is located inside, at the top-left of the unit.

Use a AWG 2 (or 38 mm²) or larger cable for the grounding wire. Run the grounding wire through the opening at the bottom, or through a hole in the top knockout plate (if available). See Figure 11.10. Connect either the top or bottom earth ground bus, but not both, to the grounding wire.

The ground wire must have a crimp terminal with a 1/2 in. (12 mm) diameter bolt hole. The ground bus has 33/64 in. (13 mm) bolt hole. The connect the crimp terminal and ground bus together using a 7/16 in. (10 mm) diameter bolt.

G8000 - 100 kVA

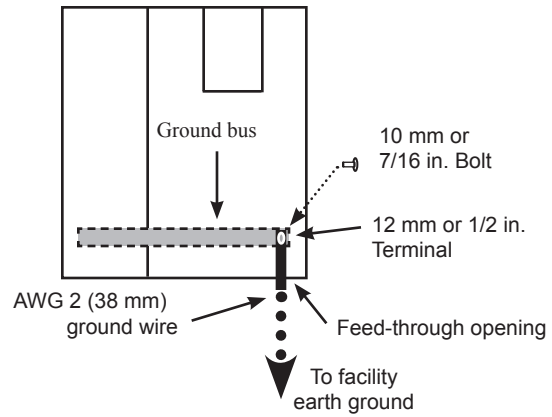

G8000 - 150/225 kVA

Facility earth ground.
Alternate ground wire routing
through top knockout plate.

Note: Use either the top or the
bottom access for the ground
wire to connect to the ground
buss, but use only one ground
wire..

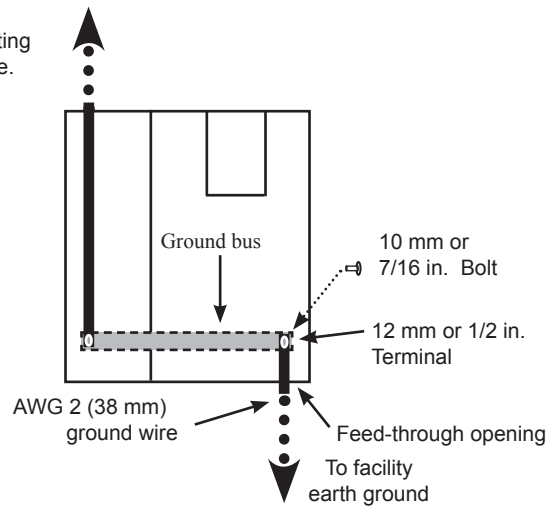

G8000 - 300 kVA

Facility earth ground.
Ground wire routing through
top knockout plate.

Note: Use either the top or the
bottom grounding point, but not
both. Doing so may degrade the
performance of the unit.

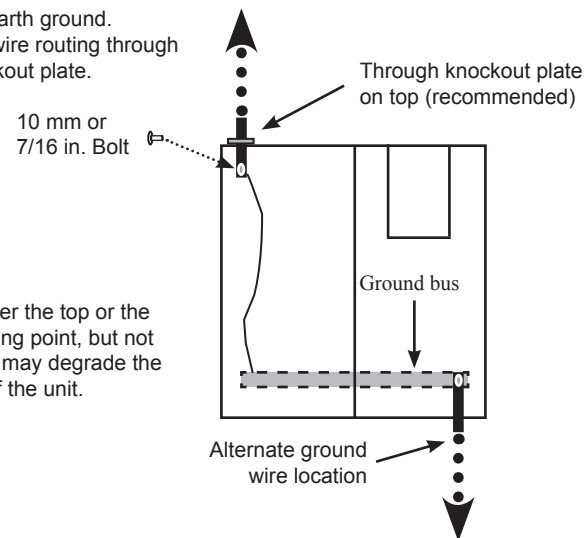

FIGURE 11.10 - EARTH GROUND WIRE

11.6 Control Wires

The control wires terminal layouts at TB1 (terminal bus 1) are shown below in Table 11.8.

TABLE 11.8 EXTERNAL CONNECTIONS

No.	I/O	Signal Name	Operation
1	Output	Low Battery	Closed at Low Battery
2	Output	Backup Operation	Closed during Backup Operation
3	Output	Fault	Closed if Faults present
4	Output	Inverter Supply	Closed during Normal Operation
5	Output	Warning	Closed if Warnings present
6	Input	P24 Remote Run	Close to run UPS
7	Input		
8	Input	P24 Remote Stop	Close to stop UPS
9	Input		
10	Output	Bypass Supply	Close during Bypass Operation
11	Output	Output Signal Ground	(Ground for pin #1 – 5 & #10)
12	Input	P24 Battery Overheat	Battery's Overheat B-contact
13	Input		
14	Output	52C Trip Signal	Bypass Breaker Shunt Trip Signal by EPO
15	Output		
16	Output	72B Trip Signal	Battery Breaker shunt trip by EPO or Battery shutdown
17	Output		
18	Output	72B Aux. Contact	Battery breaker's Auxiliary A-contact
19	Output		
20			
21	Output	External EPO	Ext EPO (Customer) N.O. Contacts
22	Output		

Note: All control wiring should be #18 AWG (0.823 mm²) or larger.

The UPS battery cabinet and bypass breaker should be wired as shown below in Figure 11.11.

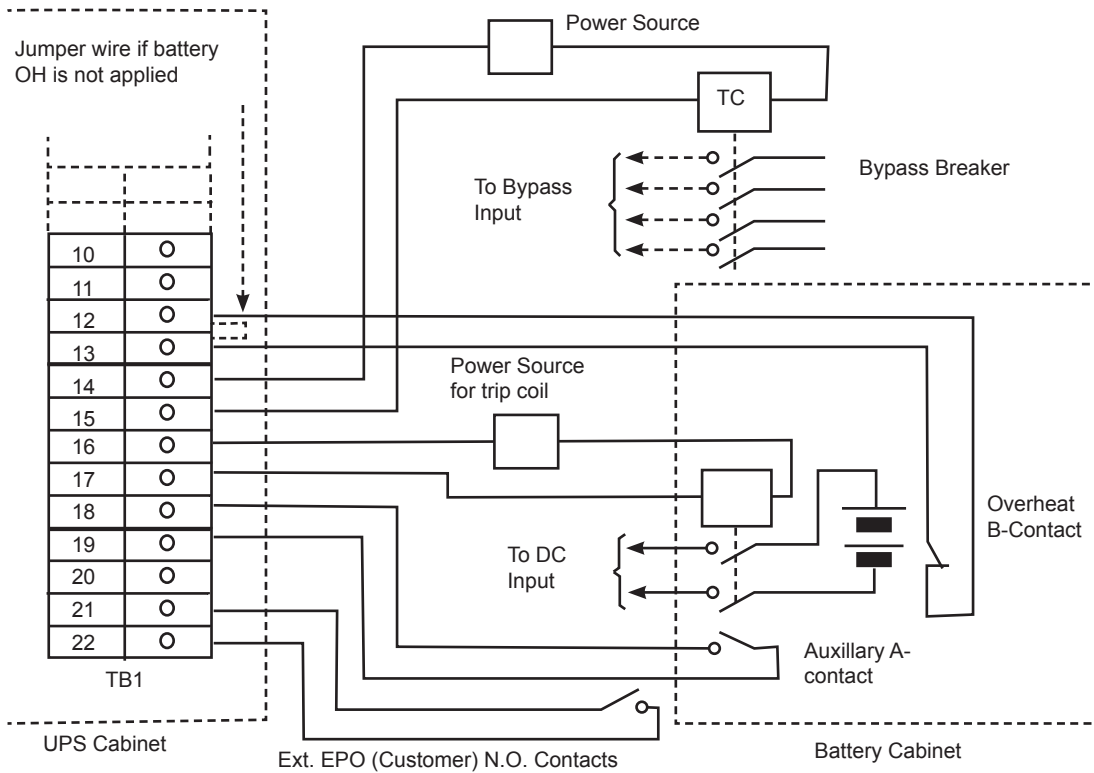

FIGURE 11.11 - CONNECTION BETWEEN UPS, BATTERY CABINET & BYPASS BREAKER

11.7 Grounding Configuration

This section describes the grounding configuration to be used with various AC service entrance configurations. Inadequate grounding will cause problems at start-up. Connections for the ground line and the neutral line must be made appropriately according to the system configuration.

11.7.1 Recommended configuration (for 4 wire input with Input Neutral grounded)

Figure 11.12 shows recommended grounding configuration when the input neutral is grounded. The neutral line at the input source is usually grounded. The neutral terminal in the UPS cabinet should be disconnected from the ground bus. The neutral connection for the UPS bypass input should be grounded.

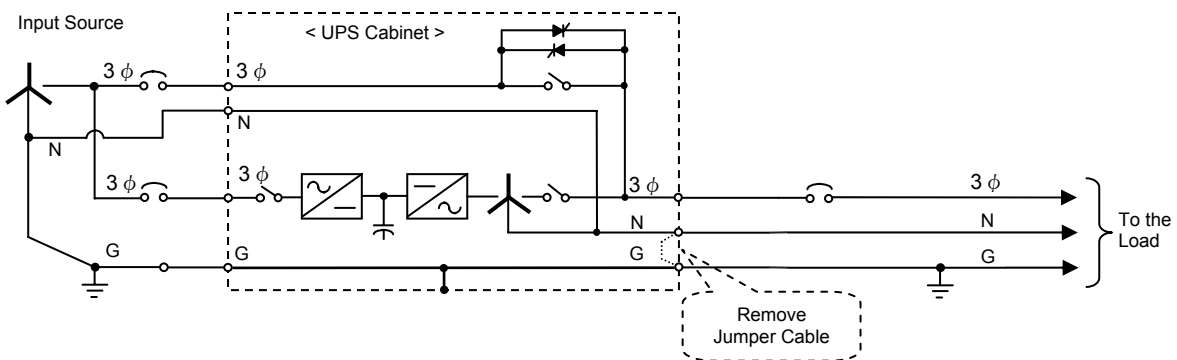

FIGURE 11.12 - GROUNDING CONFIGURATION WITH INPUT NEUTRAL GROUNDED

A 2 AWG (or 38 mm²) jumper cable is provided between the neutral terminal and ground bus in the UPS cabinet. The qualified personnel should remove the jumper cable in this configuration. The jumper cable location is illustrated below.

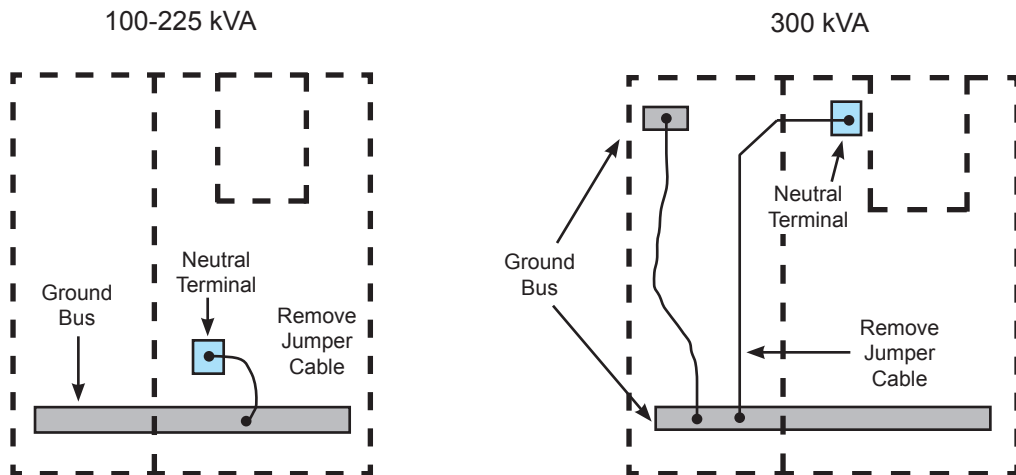

FIGURE 11.13 - JUMPER CABLE BETWEEN THE NEUTRAL TERMINAL & GROUND BUS

11.7.2 Grounding Configuration (without input neutral)

When the input source is wye-connected, the neutral line out to the bypass input should be left open. The UPS is grounded by connecting the neutral terminal to the ground bus with the internal jumper cable. See Figure 11.14.

The jumper cable should stay in place. See Figure 11.13 for the jumper cable location.

If a ground fault interrupter is installed, the UPS is likely to trip the interrupter during transferring to/from the bypass circuit. It is recommended that the ground fault interrupter be set to a minimum delay of 0.5 seconds.

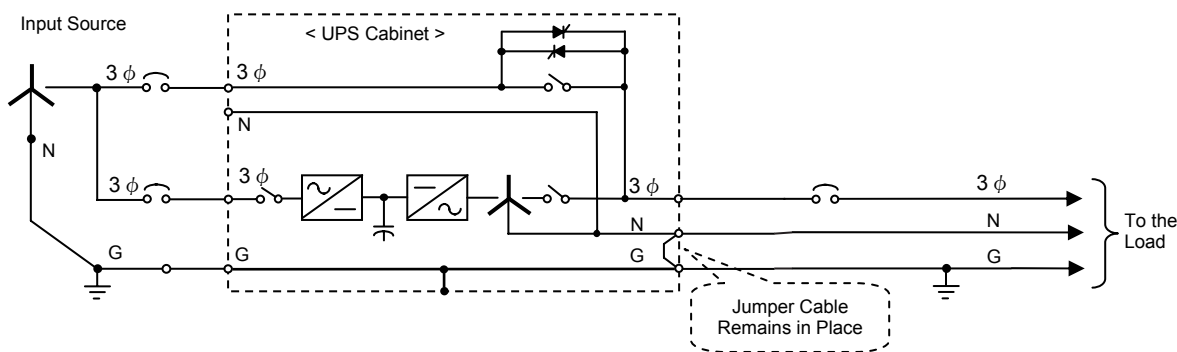

FIGURE 11.14 - GROUNDING CONFIGURATION WITHOUT INPUT NEUTRAL

11.7.3 Recommended Configuration (for delta-input)

If the input source is a delta-connection (3-phase 3-wire) without ground, the neutral terminal in the UPS cabinet must be connected to the ground bus with the internal jumper cable as shown in Figure 11.15.

The jumper cable should stay in place. See Figure 11.13 for the jumper cable location.

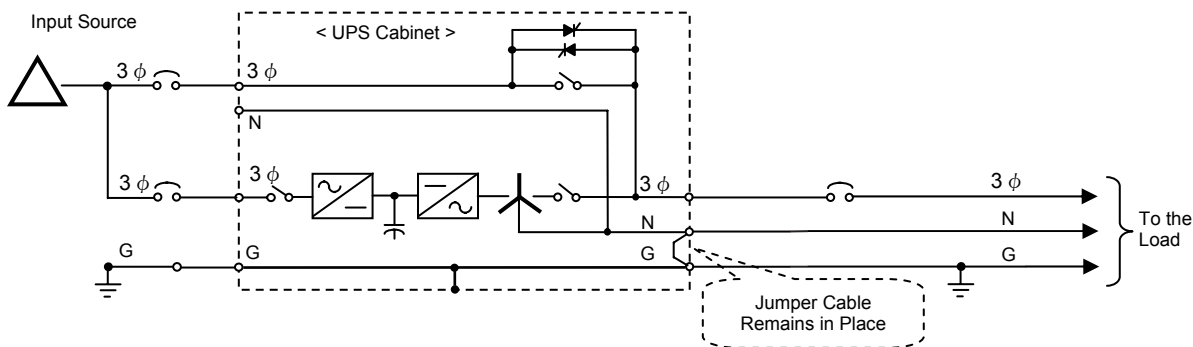

FIGURE 11.15 - GROUNDING CONFIGURATION FOR NON-GROUNDED DELTA-INPUT

11.7.4 Grounding Configuration (with corner-grounded delta-input)

If one phase of delta-input source is grounded (B-phase for example), the ground bus in the UPS cabinet should NOT be connected to the neutral terminal of UPS output.

The jumper cable should be removed see Figure 11.13 for the jumper cable location.

During normal operation the UPS output is floating relative to the ground. An isolation transformer is recommended at output distribution as shown in Figure 11.16.

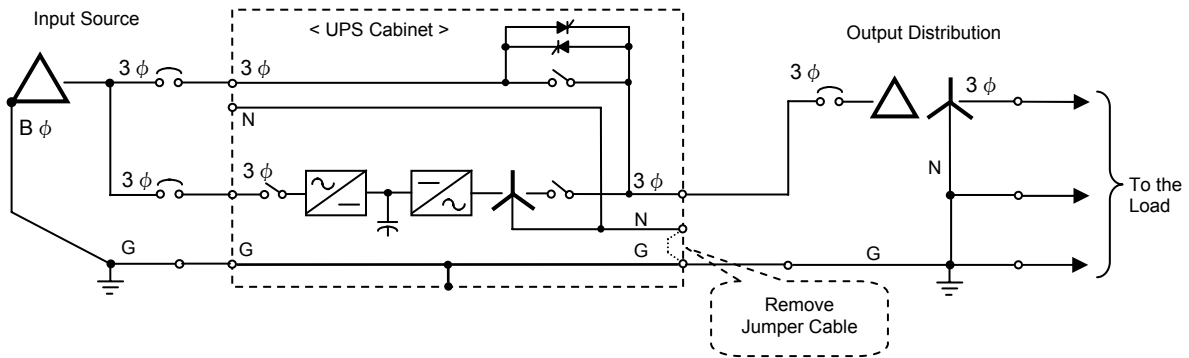

FIGURE 11.16 - GROUNDING CONFIGURATION WITH CORNER-GROUNDED DELTA-INPUT.

12 UPS Specifications

12.1 General Specification

Terms	Specification	Remarks
Conforming Standard	UL1778-2001	UL, cUL
Ambient Temperature	PF = 1.0: 32 – 86 °F (0 – 30 °C) PF = 0.8: 86 – 104 °F (30 – 40 °C)	
Relative Humidity	30% – 90%	Non-condensing
Altitude	< 3280 ft. (< 1000 m)	Contact Toshiba Technical Support for installation above 3280 ft. (1000 m)
Audible Noise	68 dB (100/150/225 kVA), 72 dB (300 kVA)	39 in. (1m) away from front
Insulation Resistance	3 MΩ	With 500V-Megger
Insulation Breakdown	AC 2 kV – 1 min.	Main Circuit
	AC 1.5 kV – 1 min.	External Interface
	AC 500 V – 1 min.	Control Circuit

12.2 Mechanical Specification

Nominal Capacity	100 kW: T80S3K10KK6XS2H
Cabinet Protection Conformity	IEC298 IP20*
Exterior Paint	Sherwin Williams, HHT2-7055, 079 Beige Texture
Panel Thickness	FRONT: 1.6 mm (1/16 in.) BACK/SIDE/TOP: 1.2 mm (3/64 in.) BOTTOM: 3.2 mm (1/8 in.)
Input/Output Cabling Entrance	BOTTOM
Ground/Control Wiring Entrance	BOTTOM
Outline Dimension	W: 36.8 in. (935 mm) D: 31.8 in. (808 mm) H: 79.2 in. (2012 mm)
Unit Weight	1740 lb. (789 kg)
Shipping Weight	1790 lb. (812 kg)
Floor Loading Per Footprint	2180 lb./ft. ² (10,644 kg/m ²)
Clearance	FRONT: 43 7/16 in. (1100 mm) BACK/SIDE: 0 in. (0 mm) TOP: 15 3/4 in. (400 mm)
Heat Rejection	34,121 BTU/h (8598 kcal/h)



*IP20: Foreign objects that are 12 mm (15/32") or larger are prevented from entering the enclosure of the UPS.

12.2 Mechanical Specification (cont.)

Nominal Capacity	150 kW	225 kW	300 kW
Cabinet Protection Conformity	IEC298 IP20*		
Exterior Paint	Sherwin Williams, HHT2-7055, 079 Beige Texture		
Panel Thickness	FRONT: 1/16 in. (1.6 mm) BACK/SIDE/TOP: 3/64 in. (1.2 mm) BOTTOM: 1/8 in. (3.2 mm)		
Input/Output Cabling Entrance	TOP and BOTTOM		TOP
Ground/Control Wiring Entrance	TOP and BOTTOM		TOP
Outline Dimension	W: 55.1 in. (1400 mm) D: 31.8 in. (808 mm) H: 79.2 in. (2012 mm)		W: 76.8 in. (1951 mm) D: 31.8 in. (808 mm) H: 79.4 in. (2017 mm)
Unit Weight	2467 lbs (1119 kg)	2980 lbs (1352 kg)	4575 lbs (2075 kg)
Shipping Weight	2556 lbs (1159 kg)	3069 lbs (1392 kg)	4725 lbs (2143 kg)
Floor Loading Per Footprint	3280 lbs/ft ² (16,014 kg/m ²)	3733 lbs/ft ² (18,226 kg/m ²)	2460 lbs/ft ² (12,011 kg/m ²)
Clearance	FRONT: 43 7/16 in. (1100 mm) BACK/SIDE: 0 in. (0 mm) TOP: 15 3/4 in. (400 mm)		
Heat Rejection	51,182 BTU/h (12,897 kcal/h)	68,243 BTU/h (17,197 kcal/h)	68,243 BTU/h (17,197 kcal/h)

*IP20: Foreign objects that are 12 mm (15/32 in.) or larger are prevented from entering the enclosure of the UPS.

12.3 Electrical Specification

 WARNING	
	<p>DO NOT open the front cover.</p> <p>Electric shock, burns or other personal injuries may occur if untrained personnel open the front cover.</p>

Nominal Capacity	100 kW	150 kW	225 kW	300 kW
AC Input Rated Capacity*	110 kW (120 kW)	165 kW (180 kW)	245 kW (270 kW)	320 kW (320 kW)
Input Voltage	480 V (+10% to -15%), 3-Phase 3-Wire			
Input Frequency	60 Hz ±5%			
Input Power Factor	0.95 – 1.00 Lagging (at 100% Load)			
Current Harmonic Distortion	4% Maximum (at 100% Load)			
Input Capacity Required*	111 kVA (124 kVA)	166 kVA (184 kVA)	250 kVA (274 kVA)	327 kVA (332 kVA)
Circuit Breaker Rating At 480 V Input	200 A Trip	300 A Trip	450 A Trip	500 A Trip

* Capacity: Normal Mode (Recharge Mode)

Nominal Capacity	100 kW	150 kW	225 kW	300 kW
DC Input Voltage Window	288 – 414 VDC			
Recharge Voltage Regulation	± 1.5%			

Nominal Capacity	100 kW	150 kW	225 kW	300 kW
AC Output Rated Capacity*	100 kVA (100 kW)	150 kVA (150 kW)	225 kVA (225 kW)	300 kVA (300 kW)
Output Voltage	480/277 V ± 1%, 3-Phase 4-Wire			
Output Power Factor	1.0 PF: 32 – 86 °F (0 – 30 °C) 0.8 PF: 86 – 104 °F (30 – 40 °C)			
Voltage Distortion	3% with 100% Linear Load / 5% with Non-Linear Load			
Transient Voltage Regulation	< ± 2%			
Transient Settling Time	< 50 ms			
Crest Factor	2.0			
Output Frequency	60 Hz ± 0.01% (at Free-running Mode)			
Synchronous Window To Utility Line	59 Hz – 61 Hz			
Frequency Slew Rate	1 Hz/Sec			
Over Load Rating	100% – Continuous / 125% – 10 min. / 150% – 1 min.			

* Capacity: Normal Mode (Recharge Mode)

13 Operator Interface

Table 13.1 shows the functions of the operating buttons on the graphic display panel.

ATTENTION

Press an operating button for at least 0.5 seconds to change UPS modes. Press the reset button for at least 5 seconds to reset the UPS.

The UPS may not respond if the button press is too short.

TABLE 13.1 BUTTON AND INDICATOR FUNCTIONS (See fig. 13.1 and 13.2)

#	Name	Function
1	OPERATION LOCK	Enables/disables the buttons RUN, STOP, UPS, BYPASS, FLOAT/EQUAL, and RESET.
2	STOP BUTTON	Stops the UPS. Transfers to bypass power if available.
3	RUN BUTTON	Starts the UPS. Transfers the unit from bypass to UPS power.
4	FLOAT/EQUAL BUTTON	Changes recharge mode between float charge and equalize charge.
5	SCROLL UP BUTTON	Scrolls the LCD screens up.
6	SCROLL DOWN BUTTON	Scrolls the LCD screens down.
7	RESET BUTTON	Reset UPS faults and warnings shown on the LCD. (See Section 13.5)
8	UPS BUTTON	Transfers from bypass operation to normal operation.
9	BYPASS BUTTON	Transfers from normal operation to bypass operation.
10	EPO BUTTON	“ON” during Bypass Supply.
11	LCD DISPLAY	Displays the operational, status, and warning/fault messages.
12	UPS SUPPLY LED	“FLASHES” during START or STOP sequence “ON” when operating in inverter mode.
13	CONVERTER LED	“ON” after DC bus capacitors are fully charged through the converter.
14	AC INPUT LED	“ON” with nominal AC input. “FLASHES” with AC input under-voltage (85%).
15	FLOAT CHARGE LED	“ON” during float charge.
16	EQUALIZE CHARGE LED	“ON” during equalize charge or protection charge while battery OH contact open.
17	BATTERY LED	“ON” when battery is connected. (aux-contact on)
18	DISCHARGE LED	“ON” during battery discharge.
19	BYPASS INPUT LED	“ON” with nominal bypass input. “FLASHES” when bypass is under-voltage (85%).
20	WARNING LED	Normally “OFF”. “ON” when warning displayed on LCD. “FLASHES” when AC input is abnormal.
21	FAULT LED	Normally “OFF”. “ON” when faults occur.
22	INVERTER LED	Lamp “FLASHES” during START or STOP sequence. “ON” when inverter is operating.
23	UPS LED	“ON” when the inverter output is connected to the UPS output.
24	AC OUTPUT LED	“ON” with AC output connected to the bypass/inverter sources.
25	BYPASS LED	“ON” when the bypass power supplies the load

13.1 Key-Switch and Buttons

The key-switch and operating buttons on the graphic display panel are shown in Figure 13.1. See the sections titled “Key-switch” and “Operating buttons” for each function.

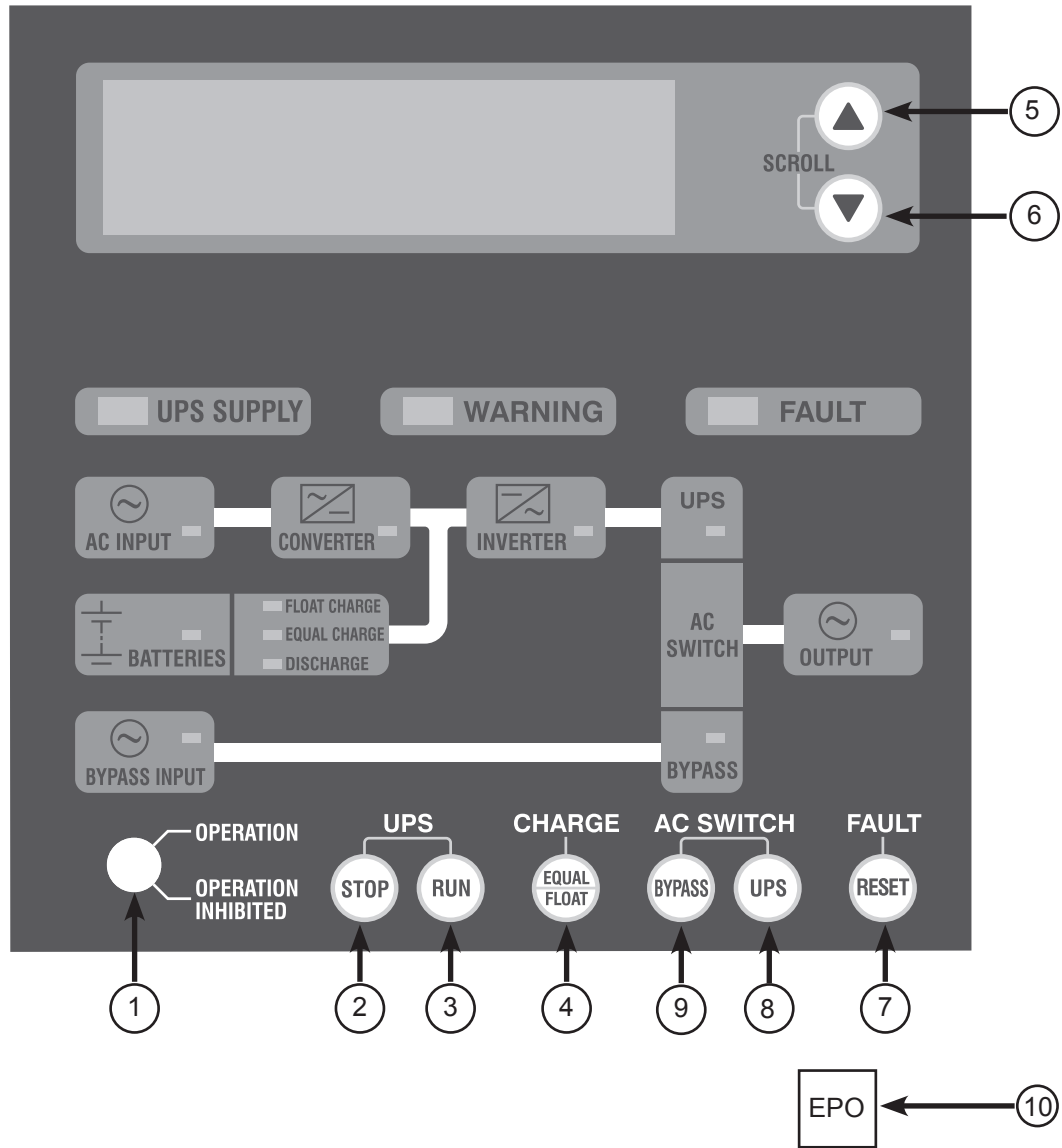

FIGURE 13.1 – GRAPHIC DISPLAY PANEL KEY-SWITCH/OPERATING BUTTONS

13.2 LCD/LED Indicators

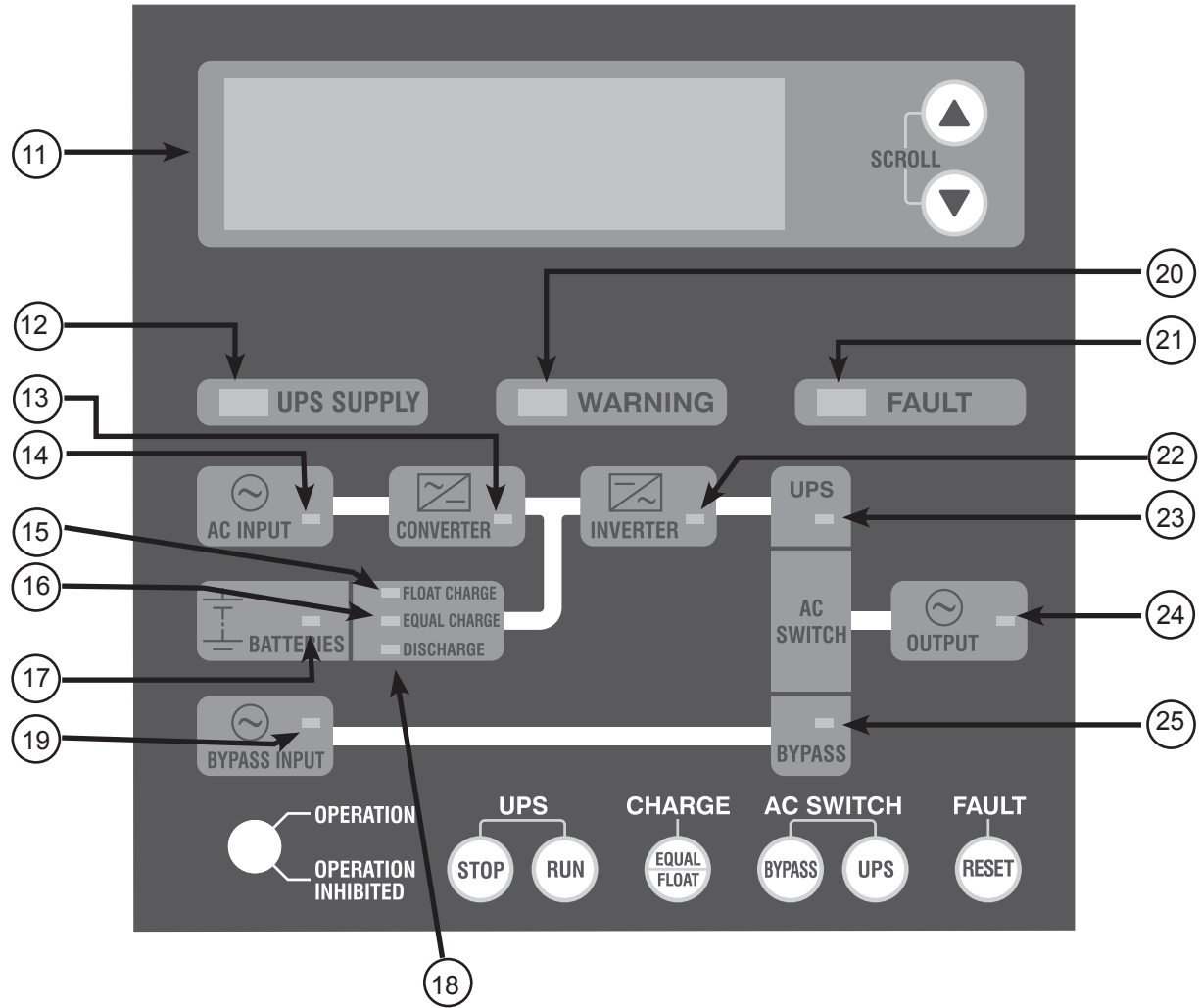

FIGURE 13.2 – GRAPHIC DISPLAY PANEL LCD/LED INDICATORS

13.3 LCD Indicators

The operator can scroll through the following LCD display screens using the scroll buttons.

TABLE 13.1 - LCD DISPLAY SCREENS

Name	Description
Normal Display	Displays operational status, operational guidance, and measured data.
Fault Display	Displays detailed data when a fault occurs.
Warning Display	Displays detailed data when a warning occurs.

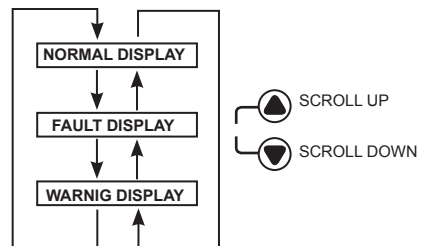

FIGURE 13.3 - CHANGING SCREENS WITH SCROLL BUTTONS

13.4 Normal Display

The Normal Display screen indicates the UPS operational status and provides various screens: an operation guidance screens, mode screens and measured data screens. Table 13.2 shows these screens page by page and illustrates the UPS Normal Display operational status screens.

TABLE 13.2 - NORMAL DISPLAY SCREEN EXAMPLES

OPERATIONAL STATUS SCREENS



Shows the UPS status at the top and guidance message or measured data underneath.

Shows a guidance message at start up.

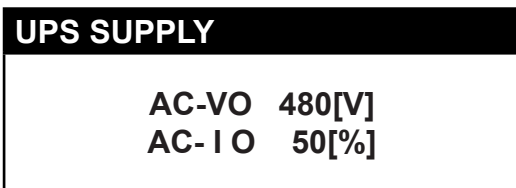

Shows the output voltage and current after start up.

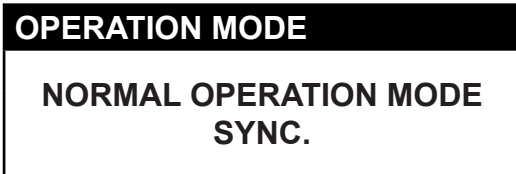

Shows the UPS Operation mode.

MEASUREMENT SCREENS

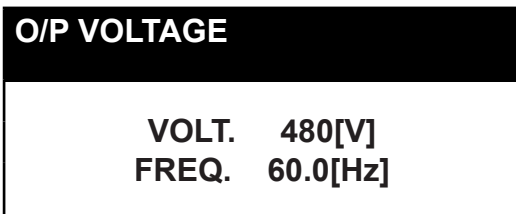

Output Voltage: Shows the output line-to-line output voltage.

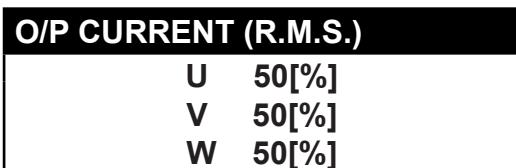

Output Current: Shows the RMS output current (%) for each phase..

TABLE 13.2 - CONTINUED

MEASUREMENT SCREENS

O/P CURRENT (PEAK)	
U	50[%]
V	50[%]
W	50[%]

Shows the peak output current peak (%) for each phase.

$$\frac{\text{Peak value of output current}}{\text{RMS value for rated current} \times 1.41} \times 100 [\%]$$

AC INPUT	
AC I/P-V	480[V]
FREQ.	60.0[Hz]

Shows the AC Input Voltage (line-to-line) and frequency.

BYPASS INPUT	
BYP I/P-V	480[V]
FREQ.	60.0[Hz]

Shows the Bypass Input Voltage (line-to-line voltage) and frequency.

BATTERY	
BACK-UP RATING	10[MIN]
DISCHARGING	15[MIN]

Shows the remaining battery backup time with rated load and cumulative discharged time.

DC INPUT	
DC-V	632[V]
BATT-V	400[V]
BATT-I	0[A]

Shows the internal DC bus voltage, battery voltage and battery current.

The battery current value displayed is negative during recharge and positive during discharge.

MODE COUNT	
UPS	35[H]
BATTERY	56[MIN]
	32[TIM]

Shows the cumulative UPS operation time, the cumulative battery backup time and the number of battery backup operations.

CLOCK	
TIME	03-24-06 13:58

The current time is displayed if there are no faults recorded, or after the reset button is pressed.

Date is displayed in the mm-ddyyy format. The unit does not calculate daylight savings time.

Time is displayed in the 24-hour format (e.g. 1:58 P.M. = 1358 Hrs.)

13.5 Fault Display

The Fault Display screen displays the fault records until they are reset. The Warning Display screen displays the warning records until they are reset. The fault records will remain in the memory until the reset button is pressed for at least 5 seconds, even after the actual cause of the fault has been resolved. Note that the fault records are not deleted when the UPS is turned off.

If the UPS is RESET while the system is in normal or bypass mode, the fault history is cleared and operation continues.

If the UPS is RESET while the system is on backup mode, the system will power down, re-initialize, and restart.

TABLE 13.3 FAULT & WARNING DISPLAY SCREEN EXAMPLES

FAULTS & WARNINGS 1 FUSE BLOWN 09-09-06 08:05:30 ↓ ANOTHER ITEM	A fault record is shown with time stamp. An arrow indicates that another record can be displayed by pressing the up/down buttons.
FAULTS & WARNINGS 1 UPS OVERLOAD 09-09-06 08:05:30 ↓ ANOTHER ITEM	A warning record is shown with time stamp. An arrow indicates that another record can be displayed by pressing the up/down buttons.
FAULTS & WARNINGS NO ALARM NO WARNING	This screen is displayed if there are no warnings recorded, or after the reset button is pressed.

13.6 LCD Scroll

Scroll through the LCD display screens (see Figure 13.4), in sequence, using the “SCROLL UP” and “SCROLL DOWN” buttons on the graphic display panel.

- **SCROLL UP** - Moves back to the previous screen
- **SCROLL DOWN** - Moves forward to the next screen

TABLE 13.4 DISPLAY SCREEN SCROLL SEQUENCE

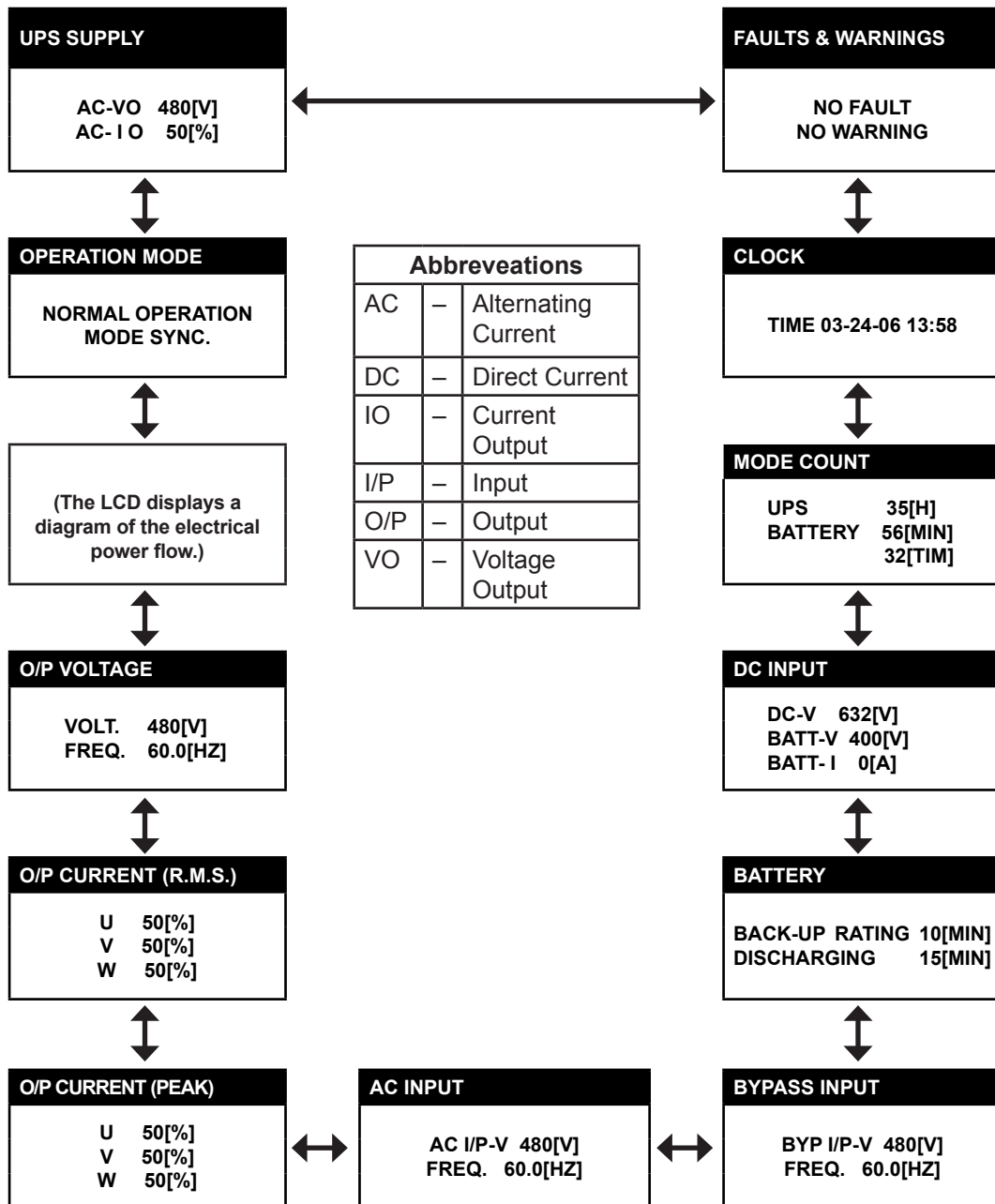

14 Operating the UPS

This section describes the basic procedures to operate the UPS. Figure 14.1 shows the location and functions of the operating switches to operate the UPS.



 WARNING	
	<p>If the UPS produces smoke or smells strange, immediately turn off all AC and DC input circuit breakers.</p> <p>Continued operation may result in fire. Contact Toshiba or Authorized representatives.</p>
	<p>DO NOT turn off the control power supply switch (8A) during UPS operation.</p> <p>This may result in UPS faults.</p>



FIGURE 14.1 - EPO AND CONTROL POWER SUPPLY OPERATING SWITCHES

14.1 Operation Types

The operation types are summarized below.

TABLE 14.1 OPERATION TYPES

Operation	Description
Complete Shutdown	Turn off the control power supply. Shut down the UPS completely.
Float / Equalize Charge	Changing the battery recharge mode between float charge and equalize charge.
Protection Charge	Automatic recharge mode transition from protection charge to float charge.
Startup	Starting up and operating the UPS.
Stop	Stop the inverter and chopper/charger.
Switch Power Supply	Switching power supply source between UPS and Bypass.

14.2 Pre-operational Check

CAUTION

Perform the pre-operational check before operating the UPS.

Before operating the UPS:

1. Make sure all covers/panels are in place and secured.
2. Make sure the temperature in the UPS/Battery room is within specified limits.
3. Before starting the UPS, check the power source to make sure AC input power is on.
4. Make sure battery breaker's auxiliary A-contact is connected to the terminal block TB1.

14.3 Startup Procedures

The procedure to start the UPS is shown in Steps 1-5.

LED Key
 □ - LED Off
 ■ - LED On
 ✦ - LED Flash

STEP 1

Turn on the control power supply switch. (Figure 14.1) and ensure the operation lock is set to OPERATION. (Figure 13.1 - 1)

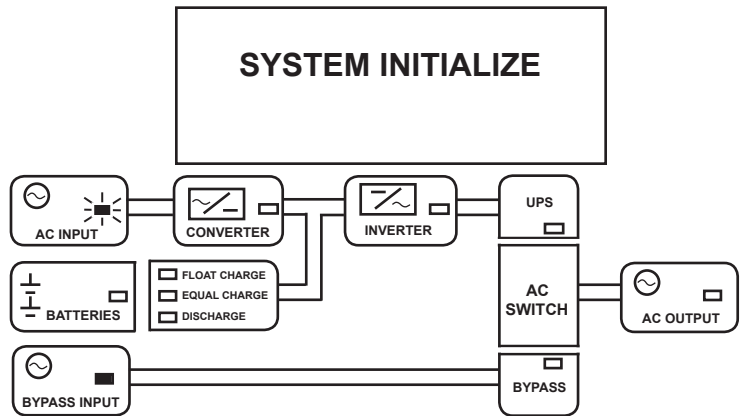

STEP 2

Wait for a few seconds.

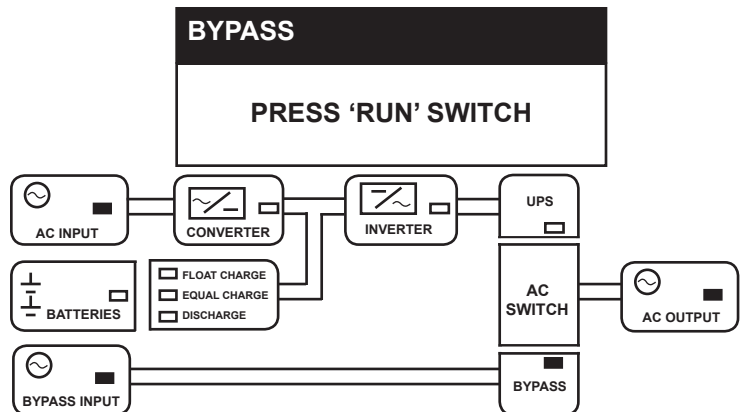

STEP 3

Press the "RUN" button for at least 0.5 seconds.

CONVERTER LED is "ON" and INVERTER LED flashes.

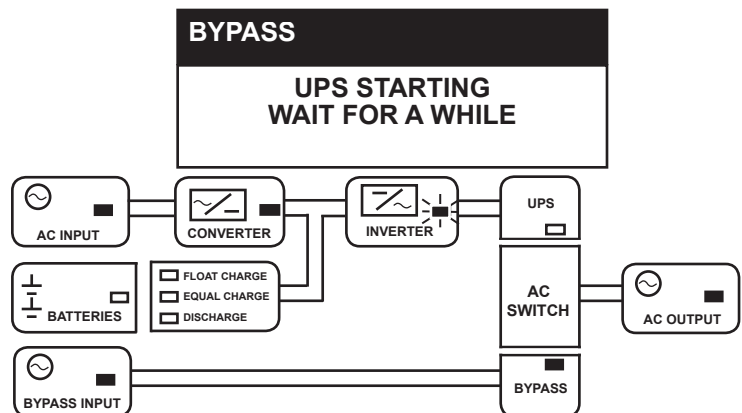

Step 4-5 continues the procedure to start the UPS.

LED Key
 - LED Off
 - LED On
 - LED Flash

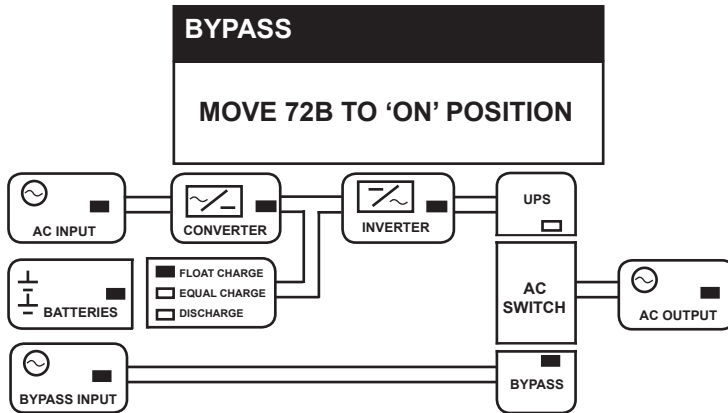

STEP 4

Turn on the DC Input Breaker (72B) on the external battery cabinet.

BATTERIES LED is "ON".

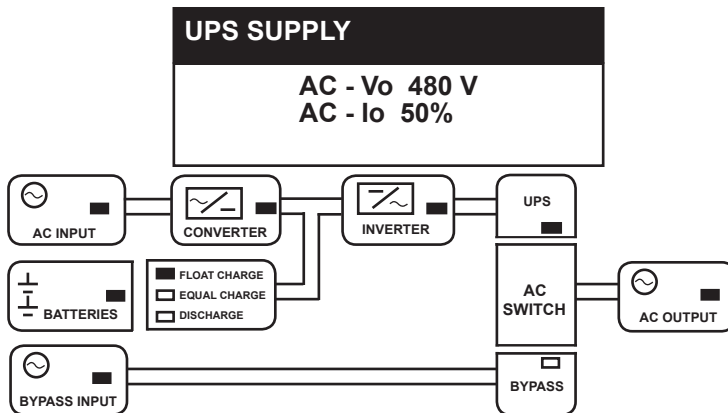

STEP 5

*Press the "UPS" button for at least 0.5 seconds. This completes UPS startup procedure

BYPASS LED is "OFF".

UPS LED is "ON".

NOTE

*If the AC switch does not function, contact Toshiba or authorized representatives.

If the bypass power source is out of specification, this operation will be inhibited. In order to switch manually, press the "UPS" button for 5 seconds or more.

14.4 Switch Power Supply (UPS→Bypass)

The procedure to transfer between the UPS supply and the bypass supply is shown in Steps 1-3

LED Key
 □ - LED Off
 ■ - LED On
 ✖ - LED Flash

STEP 1

Check AC INPUT LED and BYPASS LED are on to make sure power is being delivered to the UPS.

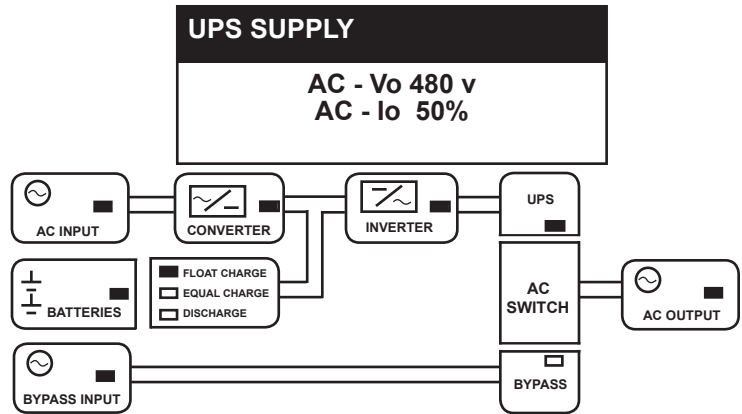

STEP 2

Press the "BYPASS" button for at least 0.5 seconds.

UPS LED is "OFF".

BYPASS LED is "ON".

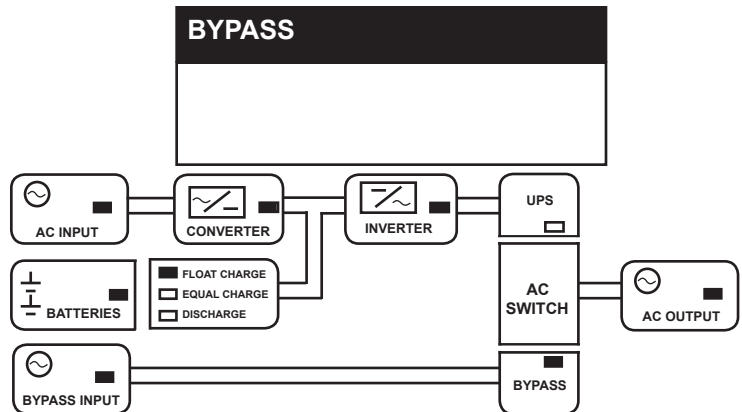

STEP 3

Please wait until procedure is completed.

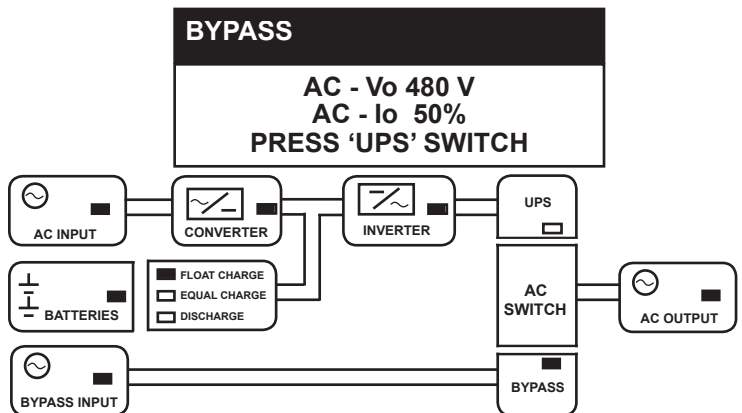

NOTE

To change from Bypass to UPS supply, follow the **Startup Procedures - STEP 5**.

If the AC switch does not function, contact Toshiba or authorized representatives.

14.5 Stop

The procedure to stop the UPS is shown in Steps 1-3.

LED Key
 □ - LED Off
 ■ - LED On
 ✖ - LED Flash

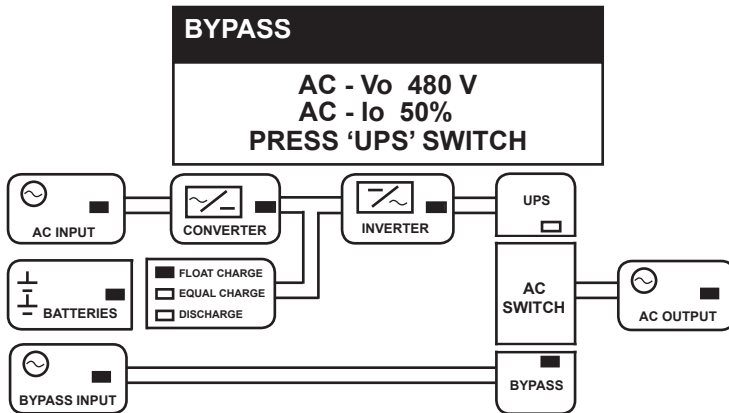

STEP 1

Transfer to Bypass supply as described in **Switch Power Supply**.

UPS LED is "OFF".

BYPASS LED is "ON".

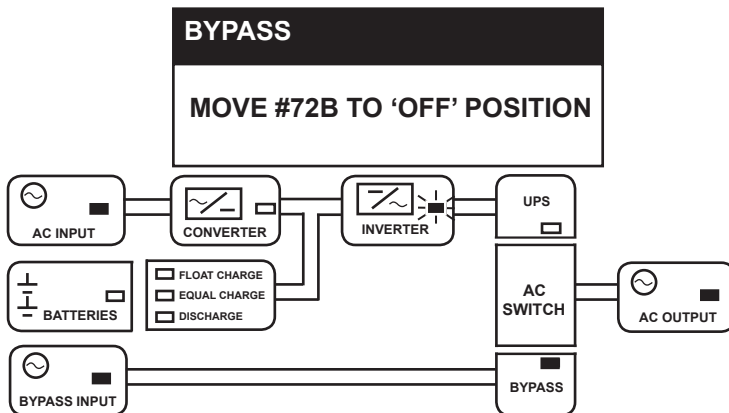

STEP 2

Turn off the DC Input Breaker (72B) on the external battery cabinet, and, press the G8000 "STOP" button for at least 0.5 seconds.

BATTERIES LED is "OFF".

INVERTER LED flashes then "OFF".

FLOAT CHARGE LED and CONVERTER LED are "OFF".

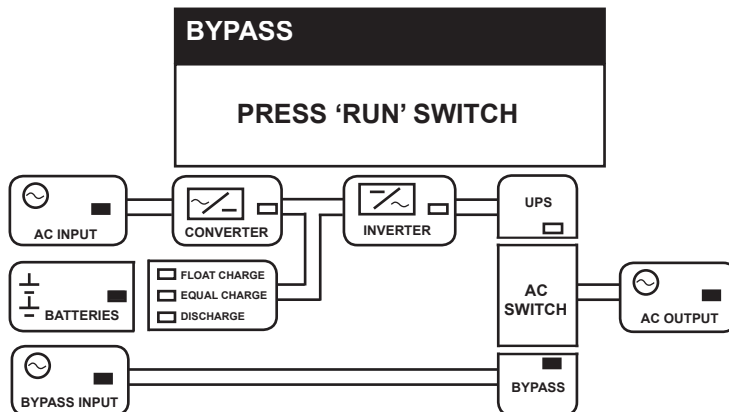

STEP 3

Wait until procedure is completed.

14.6 Complete Shutdown

The procedure to turn off the control power and shut down the UPS completely is shown in Steps 1-6.

STEP 1

Transfer to Bypass supply as described in **Switch Power Supply**.

UPS LED is "OFF".

BYPASS LED is "ON".

BYPASS	
DC-V	0 [V]
BATT-V	0 [V]
BATT-I	0 [A]

STEP 2

Turn off the DC input breaker, and, press the "STOP" button for at least 0.5 sec.

BATTERIES LED is "OFF".

INVERTER LED flashes then "OFF".

FLOAT CHARGE LED and CONVERTER LED are "OFF".

STEP 3

Please wait until procedure is completed.

STEP 4

Scroll the LCD screen to see the DC INPUT and make sure DC bus voltage is 0V.

STEP 5

*Turn off the control power supply switch (8A).

Nothing is displayed on the LCD.

All LED's are "OFF".

STEP 6

Turn off all breakers at AC output, Bypass Input and AC Output.

Shutdown is completed and UPS is isolated.

ATTENTION

**STEP 5 - This operation is different from the instructions displayed on the screen.*

Be sure to perform the procedure as specified in this manual.

14.7 Changing Between Float Charge and Equalize Charge

The procedure to change the recharge mode between float charge and equalize charge is shown in Steps 1-3.

See the Note below for an explanation of Float and Equalize charge modes.

LED Key
 □ - LED Off
 ■ - LED On
 ✖ - LED Flash

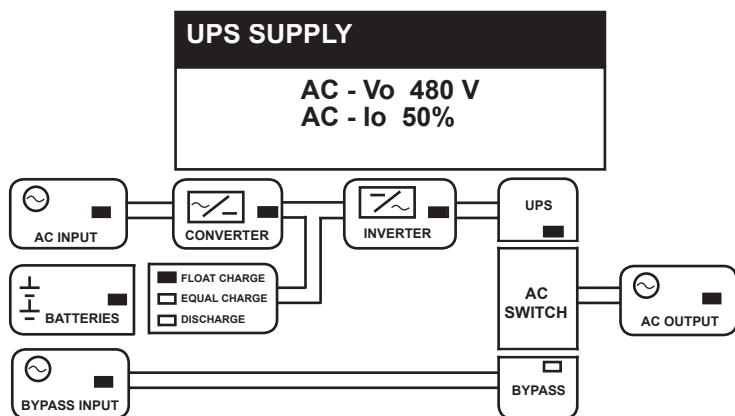

STEP 1

Make sure that the FLOAT CHARGE LED is "ON".

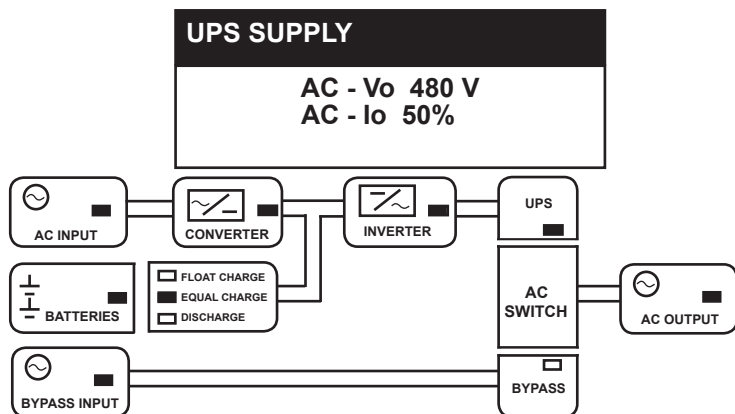

STEP 2

Press FLOAT/EQUAL button for at least 0.5 sec.

Change completed.

EQUAL CHARGE LED is "ON".

FLOAT CHARGE LED is "OFF"

STEP 3

Please wait until procedure is completed.

NOTE

In equalize charge mode, the battery is charged for a programmed period at a specified voltage (depending on the battery spec), rather than the float charge, in order to prevent voltage deviations among battery cells. This should be done once every six months if possible.

The G8000 UPS will automatically perform the equalize recharge after battery backup operation.

14.8 Changing to Float Charge from Protection Charge (If applicable)

The manual procedure to change from protection charge to float charge is shown in Step 1-3. This operation applies to batteries after they have experienced over temperature condition.

See the Note below for an explanation of float charge and protection charge.

LED Key
 □ - LED Off
 ■ - LED On
 ✖ - LED Flash

STEP 1

Make sure that the EQUAL CHARGE LED is "ON".

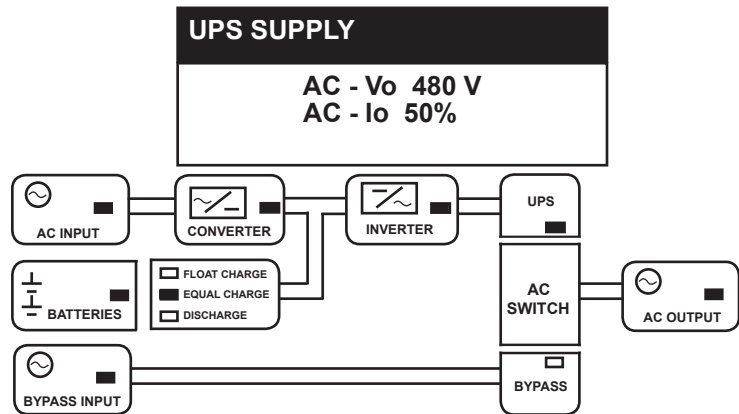

STEP 2

Make sure that the "BATT FAULT1" warning goes away.

STEP 3

Press "FLOAT/EQUAL" button for at least 0.5 seconds.

Procedure completed.

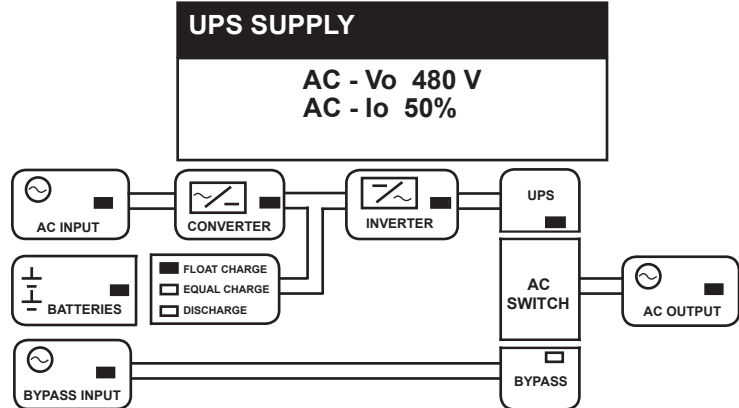

NOTE

The battery is normally being charged at float charge mode. To prevent thermal runaway of the battery, this mode will automatically be changed to protection charge when a "BATT FAULT1" (Battery over temperature) warning occurs.

In protection charge mode, the battery is automatically charged at a voltage about 5% lower than float charge.

If the "BATT FAULT1" warning message goes away and a programmed duration is elapsed (about 24 hours), this mode will automatically be changed back to float charge. Thus, it is not usually required to change the recharge mode manually back to the float charge.

14.9 Emergency Power Off (EPO)

Press the EPO switch for immediate shutdown of all power through the UPS. The signal from the EPO is processed as a “hard fault” by the UPS and results in gate-blocks on the transistors and opens all the internal contactors.

To Reset the UPS after triggering the EPO, do the following:

1. Shut Down the UPS as described in section 14.6.
2. Restart the UPS as described in section 14.3.

15 Troubleshooting

When an error occurs in the UPS, error data is displayed on the LCD screen. This section will describe the types of errors, the error messages displayed on the LCD screen and the procedures to correct the errors.

15.1 Types of Errors

The following types of errors may occur in the UPS:

TABLE 15.1 OPERATION TYPES

	Name	Description
Fault	Fault (Trip)	The UPS has been tripped and has stopped operating. The UPS is in Bypass mode.
Warning	Warning-1 (Input Power Failure)	Power is supplied from the battery. When the warning is corrected, power will automatically be supplied from the AC input.
	Warning-2 (Stop and Restart)	The UPS transfers to Bypass supply and the UPS stops operating. When the warning is corrected, the UPS will automatically be restarted and revert to UPS supply.
	Warning (Operation Control)	An error or a phenomena related to an error occurred. Since this problem does not directly affect operation, the system switches to synchronized mode.
	(Guidance)	An error or indication of an error has occurred, but operation was not affected.

15.2 Faults and Warnings Data Screen

This screen appears when a trip error is detected. Up to 10 screens of fault data can be displayed. Figure 15.1 and Table 15.2 show a sample screen and describe the data shown in the screen.

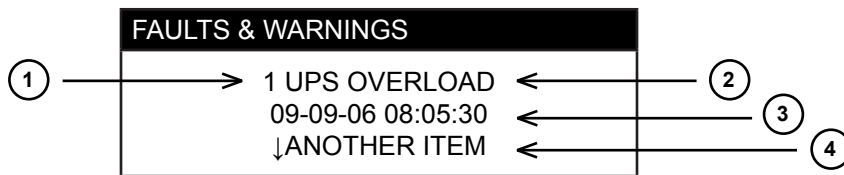

FIGURE 15.1 - SAMPLE FAULT DATA SCREEN

TABLE 15.2 - FAULT AND WARNING DATA SCREEN DESCRIPTIONS

#	Name	Description
1	Number	The number of the message in the order that it was detected (1 - 10). (Up to 10 screens of fault data can be displayed.)
2	Message	Shows the type of the fault or warning message.
3	Time	The date (mm-dd-yy) and time (in 24-hour format) the fault was detected.
4	Scroll Indicator	Indicates whether there is a fault screen before or after this screen.
		Indicates there is a fault screen before this screen.
		↓ Indicates there is a fault screen after this screen.
		↓ ↓ Indicates there are fault screens before and after this screen.

15.3 LCD Fault & Warning Displays

When a fault occurs, a screen is shown as in Figure 15.2. When a warning occurs, a screen is shown as in Figure 15.3. Select the desired fault or warning data to be displayed using the scroll buttons.

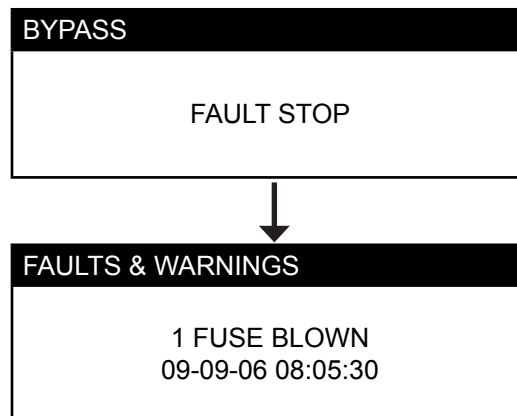

FIGURE 15.2 - FAULT DISPLAY

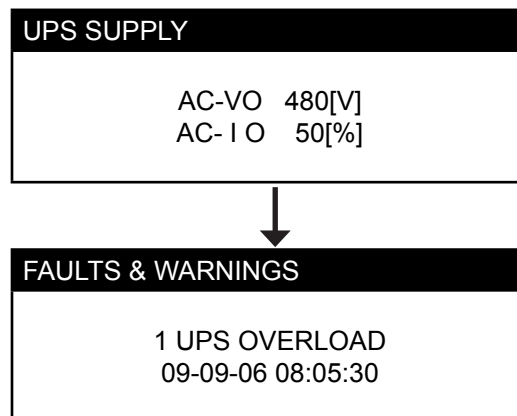

FIGURE 15.3 - WARNING DISPLAY

15.4 Fault Messages

Figure 15.4 show the locations for fault detection. Tables 15.3 through 15.7 gives details for the fault and warning messages referred to in section “Fault Data Screen.” The “item” code associated with each fault or warning message may be used to determine the physical location of the fault or warning by referring to Figure 15.4. The UPS unit may be shipped with different protective configurations from the standard shown in Figure 15.4, if specified by the customer. See the protective configuration indicated on the single line diagram for each UPS.

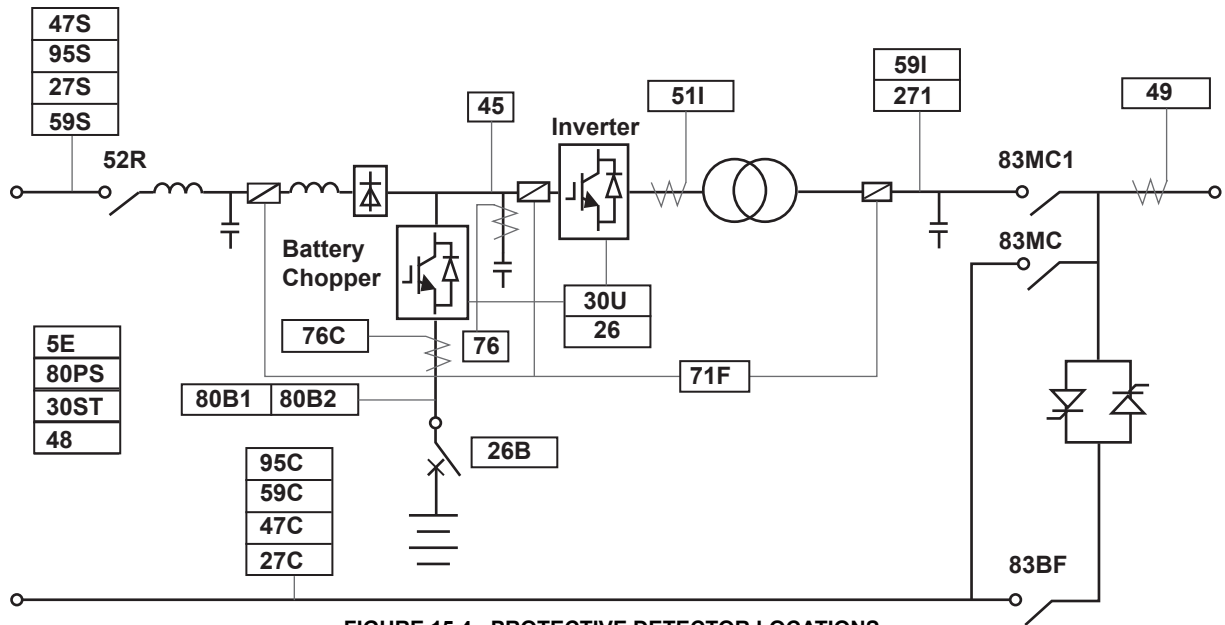

FIGURE 15.4 - PROTECTIVE DETECTOR LOCATIONS

TABLE 15.3 - FAULT (TRIP)

ITEM	LCD MESSAGE INDICATION	DESCRIPTION
26	OVER HEAT	HIGH TEMP IN THE CABINET.
30ST	(NO INDICATION)	AN ERROR OCCURRED IN THE MAIN CONTROL MICROPROCESSOR (CPU).
48	STARTUP ERR	STARTUP WAS NOT COMPLETED WITHIN THE NORMAL TIME FRAME.
5E	EMG.STOP	AN EMERGENCY STOP WAS ACTIVATED VIA THE EXTERNAL CONTACT.
71F	FUSE BLOWN	RECTIFIER, DC, OR INVERTER MAIN CIRCUIT FUSE BLOWN.
76	DC OC	DC OVER-CURRENT - EXCESSIVE CURRENT IN DC CIRCUIT.
80B2	BATT. UV	BATTERY VOLTAGE IS BELOW CUTOFF VOLTAGE.
80PS	CONT. PS. ERR	THE CONTROL POWER SUPPLY VOLTAGE FAILED.

TABLE 15.4 - WARNING – 1 (CONVERTER STOP/INPUT POWER ERROR)

ITEM	LCD MESSAGE INDICATION	DESCRIPTION
27S	AC I/P UV	AC INPUT UNDERVOLTAGE - AC INPUT VOLTAGE IS TOO LOW.
47S	AC PHASE ERR	AC INPUT PHASE ROTATION ERROR.
59S	AC I/P OV	AC INPUT OVERVOLTAGE - AC INPUT VOLTAGE IS TOO HIGH.
95S	I/P FREQ. ERR	AC INPUT FREQUENCY ERROR.

TABLE 15.5 - WARNING - 2 (STOP AND RESTART)

Item	LCD Message Indication	Description
27I	AC O/P UV	AC output voltage is low.
30U	UNIT FAULT	IGBT Stack Failure.
45	DC OV	Over-voltage in DC circuit.
49	AC O/P OL	Output overload
51I	INV. OC	Inverter over-current.
59I	AC O/P OV	AC output voltage is high.
76C	BATT. OC	Over-current in Battery section.

TABLE 15.6 - WARNING (OPERATION CONTROL)

Item	LCD Message Indication	Description
27C	BYPASS UV	Bypass input voltage is low.
47C	BYPASS ERR.	Bypass input phase rotation error.
59C	BYPASS OV	Bypass input voltage is high.
95C	BYPASS ASY.	Bypass input frequency error.

TABLE 15.7 - WARNING (GUIDANCE)

Item	LCD Message Indication	Description
26B	BATT. OVER HEAT	Battery temperature is too high.
80B1	BATT. UV (ALM)	Battery voltage is near cutoff voltage.

15.5 LCD Scroll (w/ faults or warnings)

This section describes how to scroll through the LCD screens when a fault has occurred (when Fault Data screens exist).

Figure 15.5 shows the locations of the buttons to scroll the LCD screens. See Table 15.8 for details of the scroll buttons and how they are used for screen scrolling.

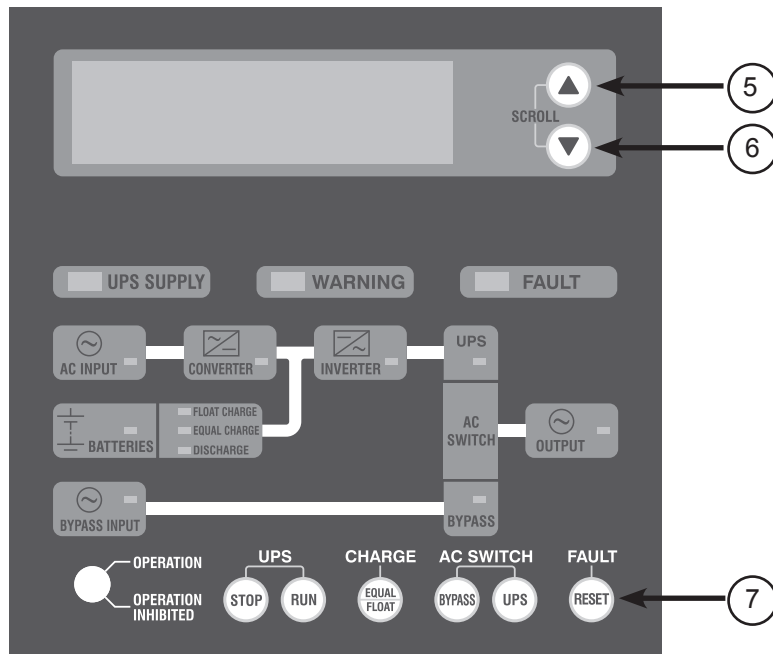





FIGURE 15.5 - POSITION OF SCROLL AND RESET BUTTONS

TABLE 15.8 - BUTTON FUNCTIONS

#	Name	Function
5	SCROLL UP	Scrolls to the previous screen.
6	SCROLL DOWN	Scrolls to the following screen.
7	RESET	Resets the UPS faults and warnings shown on the LCD and deletes fault history data stored in memory.

15.6 Restoring UPS Operation

 WARNING	
	<p>Contact Toshiba in the event of malfunction or fault.</p> <p>This UPS should be repaired only by factory authorized personnel. Servicing by untrained personnel may extend the fault or result in electric shock or personal injury.</p>
	<p>Do NOT attempt to modify or relocate the UPS.</p> <p>Electric shock, personal injury or fault may result if unauthorized personnel attempt to modify or relocate the UPS. Be sure to contact toshiba customer service if you need to modify or relocate the UPS.</p>
	<p>Do not open the front and/or rear panels.</p> <p>The parts inside carry energy-high current. Touching them may result in electric shock, burns or fault.</p>

The procedure to restore UPS operation is shown in Steps 1-2. The example shows the UPS restored after a trip fault occurred on inverter over current with the message “INV. OC.”

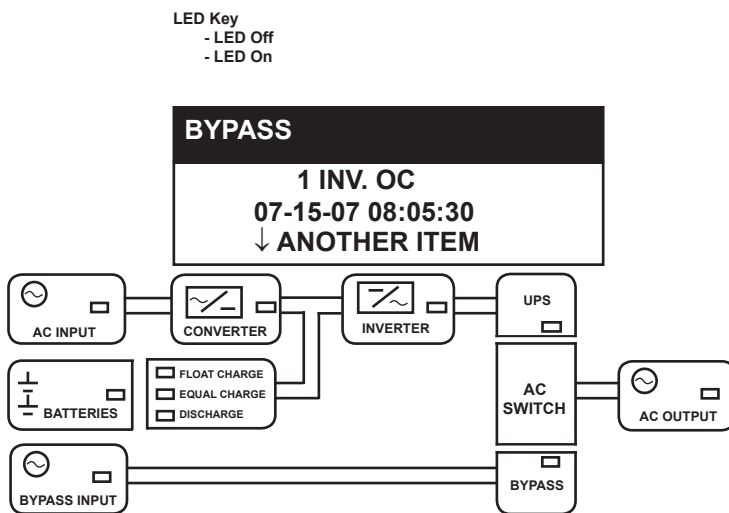

STEP 1

Check the LCD screen.

Also check other fault data screens with scroll buttons graphic panel.

STEP 2

Contact Toshiba Customer Support and follow the directions given by the service personnel.

TOSHIBA

TOSHIBA INTERNATIONAL CORPORATION

INDUSTRIAL DIVISION

13131 West Little Your road, Houston, Texas 77041

Tel (713) 466-0277 Fax (713) 466-8773

U.S. (877) 867-8773 Canada (800) 872-2192 Mexico 01/800/527-1204

www.toshiba.com/ind

Printed in the U.S.A.

Free Manuals Download Website

<http://myh66.com>

<http://usermanuals.us>

<http://www.somanuals.com>

<http://www.4manuals.cc>

<http://www.manual-lib.com>

<http://www.404manual.com>

<http://www.luxmanual.com>

<http://aubethermostatmanual.com>

Golf course search by state

<http://golfingnear.com>

Email search by domain

<http://emailbydomain.com>

Auto manuals search

<http://auto.somanuals.com>

TV manuals search

<http://tv.somanuals.com>