

# TOSHIBA

# OWNER'S MANUAL

## Projection Television

**16:9**  
WIDE

COLOR STREAM™

SRS™  
by SRS (●)®

42H81  
50H81  
57H81  
65H81

### Owner's Record

The model number and serial number are on the back of your TV. Record these numbers in the spaces below. Refer to these numbers whenever you communicate with your Toshiba dealer about this TV.

Model number:

Serial number:

Introduction

Connecting  
your TV

Using the  
Remote Control

Setting up  
your TV

Using the TV's  
Features

Appendix

Index

# Important Information

## WARNING

**TO REDUCE THE RISK OF FIRE OR ELECTRIC SHOCK, DO NOT EXPOSE THIS APPLIANCE TO RAIN OR MOISTURE.**

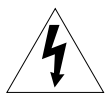
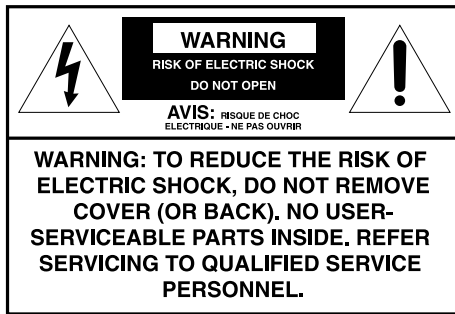

The lightning symbol in the triangle tells you that the voltage inside this product may be strong enough to cause an electric shock. **DO NOT TRY TO SERVICE THIS PRODUCT YOURSELF.**



The exclamation mark in the triangle tells you that important operating and maintenance instructions follow this symbol.

## CAUTION

TO PREVENT ELECTRIC SHOCK, DO NOT USE THIS POLARIZED PLUG WITH AN EXTENSION CORD RECEPTACLE OR OTHER OUTLET UNLESS THE PRONGS CAN BE FULLY INSERTED INTO THE OUTLET TO PREVENT ANY EXPOSURE OF THE PRONGS ON THE POLARIZED PLUG.

## ATTENTION

POUR PRÉVENIR LES CHOCs ÉLECTRIQUES NE PAS UTILISER CETTE FICHE POLARISÉE AVEC UN PROLONGATEUR, UNE PRISE DE COURANT OU UNE AUTRE SORTIE DE COURANT, SAUF SI LES LAMES PEUVENT ÊTRE INSÉRÉS À FOND SANS EN LAISSER AUCUNE PARTIE À DÉCOUVERT.

## CAUTION

The plug has one prong wider than the other and will fit only one way into a standard electrical outlet (120 volt AC, 60 Hz). If the plug does not fit into the outlet, try turning it around. If the plug still does not fit, the outlet is probably non-standard and must be replaced by a qualified electrician. Do not tamper with the plug or try to force it into a non-standard outlet.

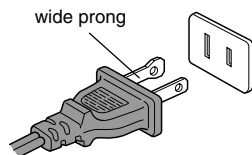

### *Note to CATV system installers in the USA*

This reminder is provided to call the CATV system installer's attention to Article 820-40 of the NEC, which provides guidelines for proper grounding, and, in particular, specifies that the cable ground shall be connected to the grounding system of the building, as close to the point of cable entry as practical.

# Precautions

## Installing your TV

- Place the TV on the floor or on a sturdy platform. The mounting surface should be flat and steady. If you install the TV on a soft floor, make sure that the floor is not damaged by the weight of the TV.
- Place the TV far enough away from the walls to allow proper ventilation. This will prevent the TV from overheating and avoid possible damage to the TV. Avoid dusty areas too.
- Damage may occur if you leave the TV in direct sunlight or near a heater. Avoid areas subject to extremely high temperatures or humidity, and temperatures of 41°F(5°C) or lower.

## Using your TV

- Do not stand or climb on the TV.
- Do not put any heavy object on top of the TV.
- Do not place containers with liquids such as drinks or cosmetics on the TV. If any foreign material or water leaks into the TV, unplug the AC cord and contact your dealer.
- If the room temperature suddenly rises, condensation may occur on the lenses resulting in picture distortion or color fading. In such a case, simply wait a while (with the power on) and the condensation will evaporate.
- Avoid displaying stationary images on your TV screen for extended periods of time. Stationary patterns generated by a picture-out-picture (POP) display, computer displays, video games, stock market reports, etc., can become permanently engrained on the picture tube. This damage is not protected by your warranty because it is the result of misuse. If you wish to use your TV to display still images, reduce brightness and contrast settings. Never leave a POP, computer, or video game display unattended.
- Sit approximately 10-25 feet away from the TV. Sitting too far to the left or right of the screen will cause the picture to appear dull as will direct sunlight and room lights. Turn the TV off to check for reflections on the screen. Then remove the source of any reflections while viewing.

## Cleaning your TV

- Clean the TV with a soft, dry cloth. Never use strong solvents such as thinner or benzene which might damage the finish of the cabinet. If the cabinet is very dirty, use a damp cloth to wipe the cabinet clean, then finish with a dry cloth.

<b>Introduction .....</b>	<b>4</b>	Using the favorite channel search function .....	30
Welcome to Toshiba .....	4	Using the LOCKS menu .....	31
Exploring your new TV .....	4	Entering the PIN code .....	31
<b>Connecting your TV .....</b>	<b>5</b>	Using the V-CHIP menu .....	32
Connecting a VCR .....	5	ENABLE BLOCKING .....	32
Connecting a cable converter box .....	6	TV RATING (Independent rating system for broadcasters) .....	32
Connecting a cable converter box and VCR.....	6	MPAA RATING (Independent rating system for movies) .....	33
Connecting a DVD player or satellite receiver and a VCR.....	7	BLOCKING OPTION .....	33
Connecting a DVD player (with or without ColorStream™) and a VCR.....	8	Unlocking programs temporarily .....	34
Connecting a DTV receiver/set-top box (with or without ColorStream™) and a VCR.....	9	Locking channels .....	34
Connecting two VCRs .....	10	Locking video inputs .....	35
Connecting a camcorder .....	10	Using the front panel lock feature .....	36
Connecting an audio system .....	11	Changing the PIN code .....	36
Connecting an A/V receiver .....	11	Adjusting the picture .....	37
<b>Using the remote control .....</b>	<b>12</b>	Selecting the picture mode .....	37
Preparing the remote control for use .....	12	Adjusting the picture quality .....	37
Installing the remote control batteries .....	12	Saving new preference .....	38
Using the remote control with a Toshiba VCR or cable TV converter .....	12	Using the ALS (Automatic Light Sensor) feature .....	38
Programming the remote control for use with a non-Toshiba VCR or cable TV converter .....	13	Using the flesh tone feature .....	38
VCR code table .....	14	Selecting the cinema mode .....	39
Cable TV converter code table .....	15	Using the Digital Noise Reduction (DNR) feature .....	39
Learning about the remote control .....	16	Selecting the color temperature .....	40
<b>Setting up your TV .....</b>	<b>17</b>	Resetting picture adjustments .....	40
Learning about the menu system .....	17	Selecting the video input source .....	41
Changing the on-screen display language .....	18	Labeling the video input sources .....	41
Selecting the antenna input .....	18	Using the closed caption feature .....	42
Using the TV/VIDEO button to select the antenna input .....	18	Setting the sleep timer .....	43
Adding channels to the TV's memory .....	19	Setting the clock .....	43
Programming channels automatically .....	19	Adjusting the sound .....	44
Adding and erasing channels manually .....	20	Muting the sound .....	44
Changing channels .....	20	Selecting stereo/SAP broadcasts .....	44
Adjusting the color convergence .....	21	Using the SRS 3D surround sound feature .....	45
<b>Using the TV's features .....</b>	<b>23</b>	Adjusting the sound quality .....	45
Adjusting the channel settings .....	23	Resetting audio adjustments .....	46
Switching between two channels .....	23	Using the sub-bass system (SBS) .....	46
Programming your favorite channels .....	23	Turning off the built-in speakers .....	47
Labeling channels .....	24	Selecting the Audio OUT sound .....	47
Viewing the wide-screen picture formats .....	26	Using the StableSound™ feature .....	48
Selecting the picture size .....	26	Selecting the background of the menu display .....	48
Normal .....	26	Displaying on-screen information .....	48
Full .....	26	Viewing the demonstration mode .....	49
Theater Wide 1, 2, 3 .....	27	Understanding the auto power off feature .....	49
Scrolling the Theater Wide picture (Theater Wide 2 and 3 only) .....	28	Understanding the last mode memory feature .....	49
Using the POP double-window feature .....	29	<b>Appendix .....</b>	<b>50</b>
Switching the main and POP pictures .....	30	Specifications .....	50
Freezing the POP picture .....	30	Troubleshooting .....	51
		Limited United States Warranty .....	52
		<b>Index .....</b>	<b>53</b>

## Introduction

### Welcome to Toshiba

Congratulations! You have purchased one of the finest projection TVs on the market. The goal of this manual is to guide you through setting up and operating your Toshiba TV as quickly as possible.

This manual applies to models 42H81, 50H81, 57H81, and 65H81. Before you start reading, check the model number on the back of the TV.

Instructions in this manual are based on using the remote control. You can also use the controls on the TV if they have the same name as those on the remote control.

Please read all the safety and operating instructions carefully, and keep the manual for future reference.

### Please Note

*On some models, the SET UP menu automatically appears on-screen the first time the TV is turned on.*

*To change the menu settings, see "Setting Up Your TV" on page 17.*

*To close the menu, either press EXIT or turn off the TV.*

### Exploring your new TV

You can operate your TV using the buttons on the front panel or the remote control. The back panel and front panel (behind the door) provide all the terminal connections you will need to connect other equipment to your TV. See "Connecting your TV" on page 5.

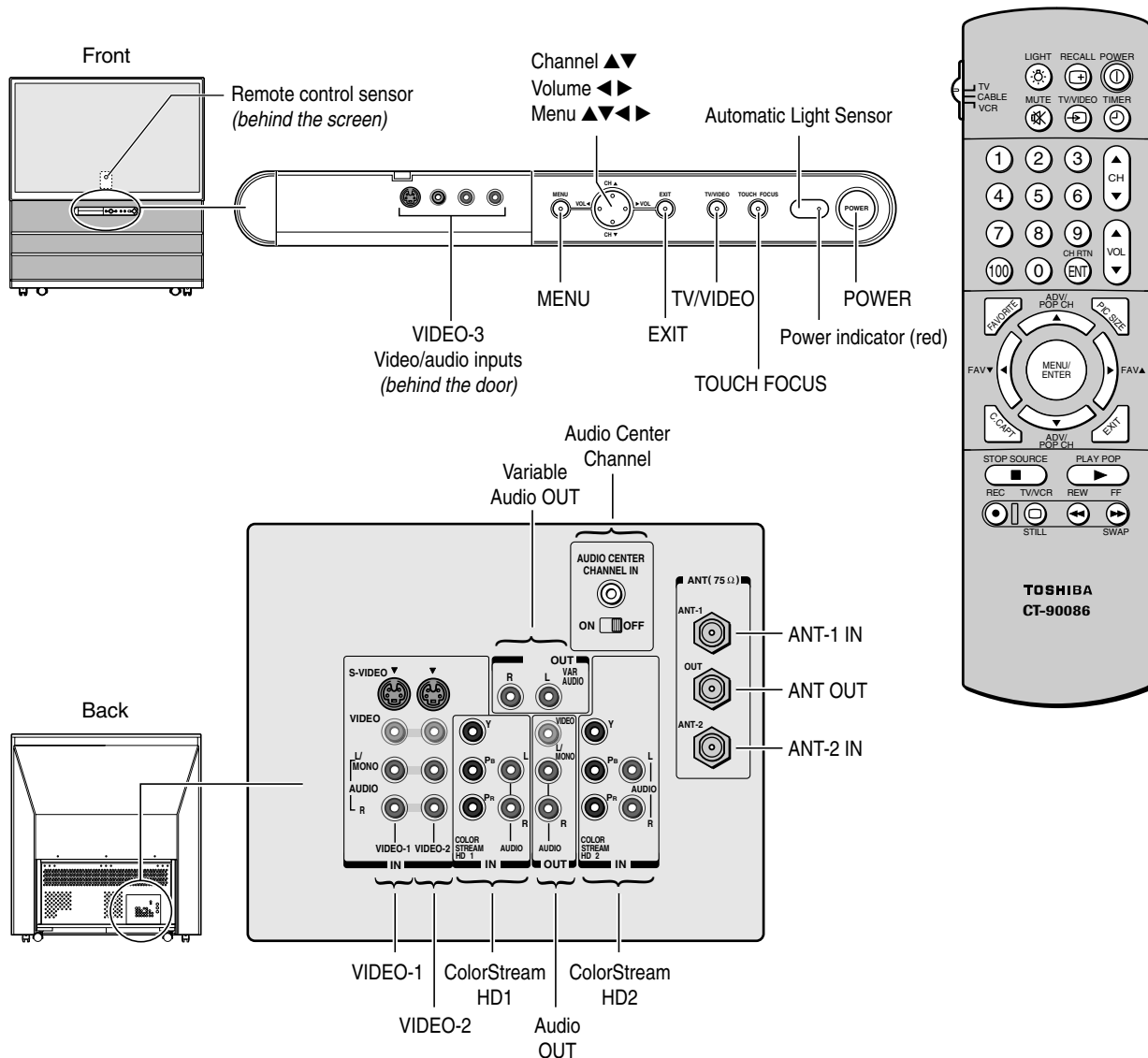

## Connecting your TV

If you have not connected electronic equipment before, or you have been frustrated in the past, you may wish to read this section. (Cables are not supplied.)

- A coaxial cable is the standard cable that comes in from your antenna or cable converter box. Coaxial cables use "F" connectors.
- Audio and video cables are usually color-coded according to use: yellow for video, and red and white for audio. The red audio cable is for the stereo right channel, and the white audio cable is for the stereo (or mono) left channel. On the rear panel of the TV, the terminals are color-coded in the same manner as the cables.
- S-video cables provide better picture performance. S-video cables can only be used with S-video compatible components.
- ColorStream™ cables come in sets of three and provide the best picture performance. ColorStream cables can only be used with ColorStream compatible components.

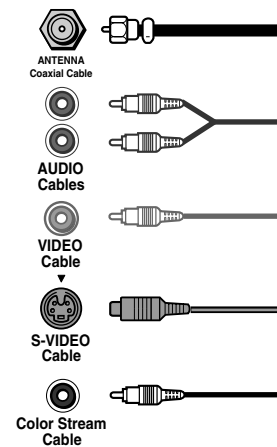

### Caution:

Do not plug the TV in until you have finished connecting all of your equipment.

## Connecting a VCR

This connection allows you to watch local channels and video programs, play or record on the VCR while watching TV, and record from one channel while watching another channel.

You will need:

- one coaxial cable
- one pair of audio cables (one single audio cable for a mono VCR)
- one video cable (one S-video cable for an S-VHS VCR)

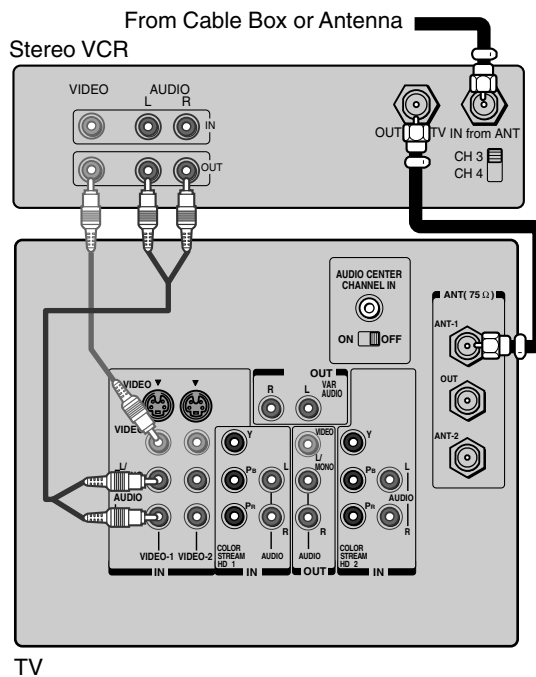

### Note:

If you have a mono VCR, connect L/Mono to VCR Audio OUT using only one audio cable.

If you have an S-VHS VCR, use an S-video cable (in the S-video jacks) instead of the regular video cable.

Do not connect a regular video cable and an S-video cable to Video-1 (or Video-2) at the same time.

## Connecting a cable converter box

This connection allows you to watch basic and premium cable channels.

To use the TV's features, select ANT-1. To view premium channels, select ANT-2, tune the TV to channel 3 or 4 (whichever channel is vacant in your area), and use the converter box to change channels.

You will need:

- two coaxial cables

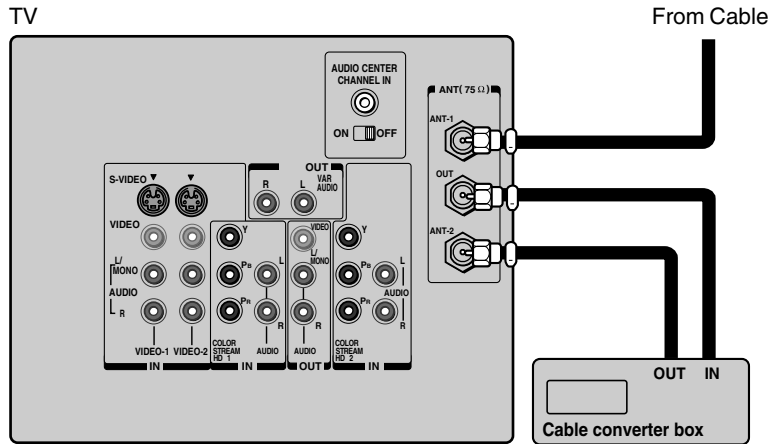

**Note:**

When you use a converter box with your TV, the remote control will not operate some features, such as programming your favorite channels, labeling channels, and locking channels.

## Connecting a cable converter box and VCR

This connection allows you to watch and record basic and premium cable channels, watch videotapes, and record one channel while watching another channel. To use the TV's features, select ANT-1.

To view premium channels or record with the VCR, select ANT-2, tune the TV to channel 3 or 4 (whichever channel is vacant in your area), and use the converter box to change channels.

You will need:

- three coaxial cables
- one pair of audio cables (one single audio cable for a mono VCR)
- one video cable (one S-video cable for an S-VHS VCR)

**Note:**

If you have a mono VCR, connect L/Mono to VCR Audio OUT using only one audio cable.

If you have an S-VHS VCR, use an S-video cable (in the S-video jacks) instead of a regular video cable. Do not connect a regular video cable and an S-video cable to Video-1 (or Video-2) at the same time.

When you use a converter box with your TV, the remote control will not operate some features, such as programming your favorite channels, labeling channels, and locking channels.

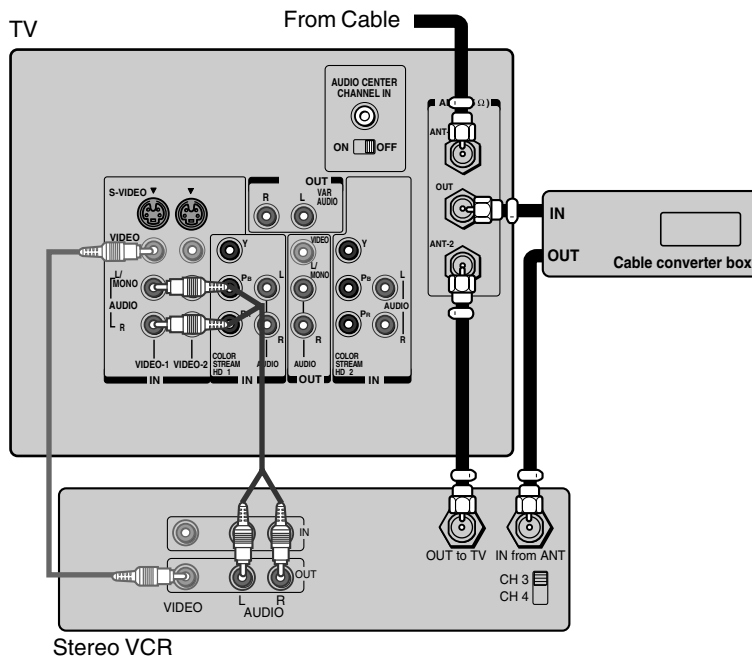

## Connecting a DVD player or satellite receiver and a VCR

This connection allows you to watch DVD/satellite, VCR, and TV programs, and record one TV channel while watching another channel.

You will need:

- one coaxial cable
- two pairs of audio cables (one single and one pair of audio cables for a mono VCR)
- one video cable (between the TV and VCR)
- one S-video cable (between the TV and DVD player/satellite receiver)

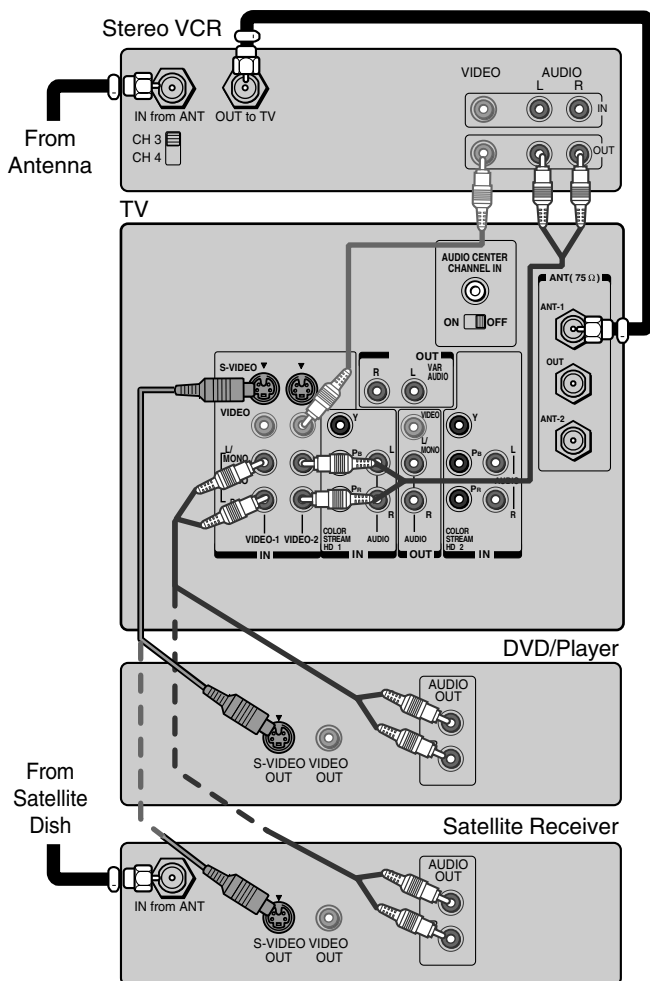

### Note:

For the highest possible picture quality from a non-ColorStream DVD player/satellite receiver, use an S-video cable between the TV and DVD player/satellite receiver. (If your DVD player or satellite receiver is ColorStream-compatible, see page 8).

Do not connect both an S-video cable and a regular video cable between the TV and DVD player/satellite receiver at the same time. Doing so will distort the picture.

Do not connect the DVD player/satellite receiver and VCR to the same video channel on the TV. (See the illustrations, which show the DVD player/satellite receiver connected to Video-1 on the TV, and the VCR connected to Video-2 on the TV.)

### Caution:

The unauthorized recording of television programs, videotapes, and other materials may infringe upon the provisions of copyright laws.

## Connecting a DVD player (with or without ColorStream™) and a VCR

This connection allows you to watch DVD, VCR, and TV programs, and record DVD and TV programs. You can record from one source while watching a program from another source.

Your TV has ColorStream (component video) inputs. Connecting your TV to a ColorStream-compatible DVD player (such as a Toshiba ColorStream-equipped DVD player) can greatly enhance picture quality and realism.

You will need:

- one coaxial cable
- three pairs of audio cables (two single and one pair of audio cables for a mono VCR)
- two video cables
- one set of ColorStream video cables (one S-video cable for a non-ColorStream DVD player; see notes at right)

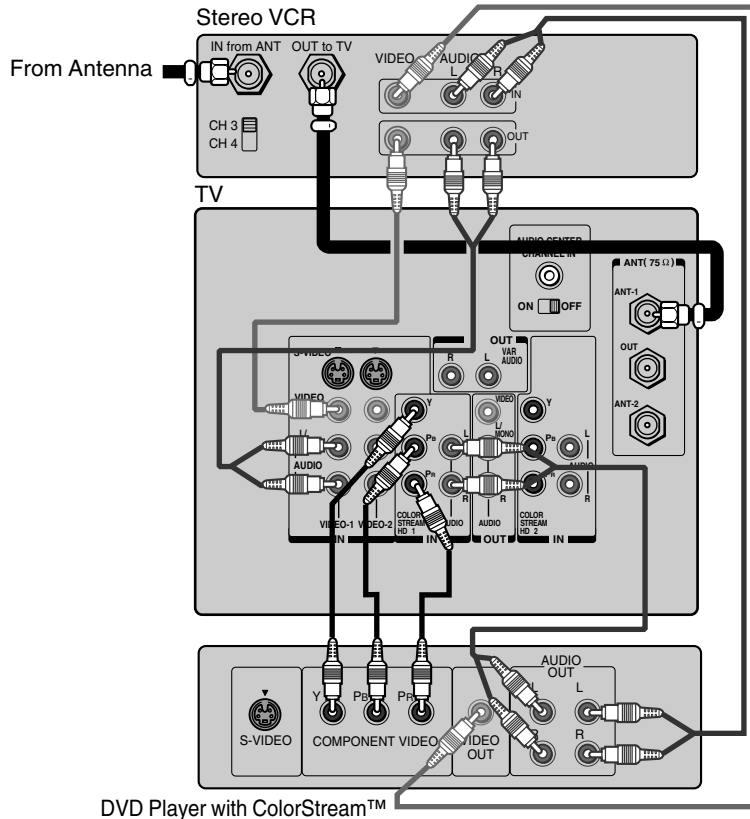

### Note:

For the highest possible picture quality, use ColorStream video cables between the TV and DVD player. You can connect the ColorStream cables from the DVD player to either ColorStream jack on the TV (HD1 or HD2).

The ColorStream HD1 and HD2 jacks can be used with Progressive (480p) and Interlace (480i, 1080i) scan systems.

If your DVD player is not ColorStream-compatible, use the S-video connections (both audio and video) instead of the ColorStream connections. Do not connect both S-Video and ColorStream cables between the TV and DVD player at the same time.

To record from the DVD player, set the VCR to Line IN. To monitor recording from the DVD player, set the VCR to Line IN, and set the TV to Video-1.

### Caution:

The unauthorized recording of television programs, videotapes, and other materials may infringe upon the provisions of copyright laws.



## Connecting a DTV receiver/set-top box (with or without ColorStream™) and a VCR

This connection allows you to watch DTV (digital TV broadcast), VCR, and TV programs, and record DTV and TV programs. You can record from one source while watching a program from another source.

Your TV has ColorStream (component video) inputs. Connecting your TV to a ColorStream-compatible DTV receiver can greatly enhance picture quality and realism.

You will need:

- one coaxial cable
- three pairs of audio cables (two single and one pair of audio cables for a mono VCR)
- two video cables
- one set of ColorStream video cables (one S-video cable for a non-ColorStream DTV receiver; see notes at right)

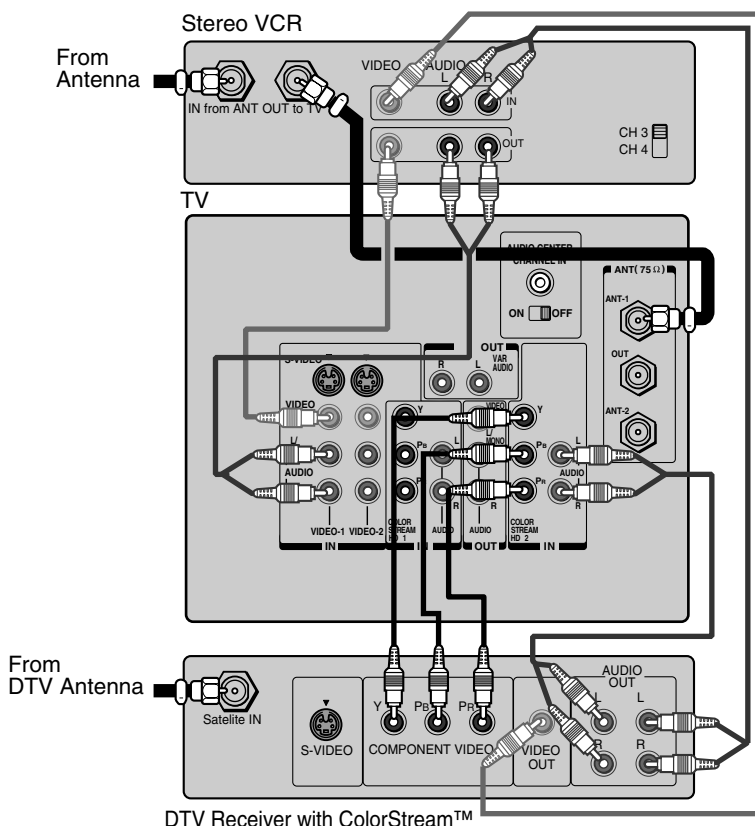

### Note:

For the highest possible picture quality, use ColorStream video cables between the TV and DTV receiver. You can connect the ColorStream cables from the DTV receiver to either ColorStream jack on the TV (HD1 or HD2).

The ColorStream HD1 and HD2 jacks can be used with Progressive (480p) and Interlace (480i, 1080i) scan systems.

If your DTV receiver is not ColorStream-compatible, use the S-video connections (both audio and video) instead of the ColorStream connections. Do not connect both S-Video and ColorStream cables between the TV and DTV receiver at the same time.

To record from the DTV receiver, set the VCR to Line IN. To monitor recording from the DTV receiver, set the VCR to Line IN, and set the TV to Video-1.

### Caution:

The unauthorized recording of television programs, videotapes, and other materials may infringe upon the provisions of copyright laws.

## Connecting two VCRs

This connection allows you to record (dub/edit) from one VCR to another VCR while watching a videotape. You can also record from one TV channel while watching another TV channel.

You will need:

- one coaxial cable
- two pairs of audio cables (two single audio cables for mono VCRs)
- two video cables (two S-video cables for S-VHS VCRs)

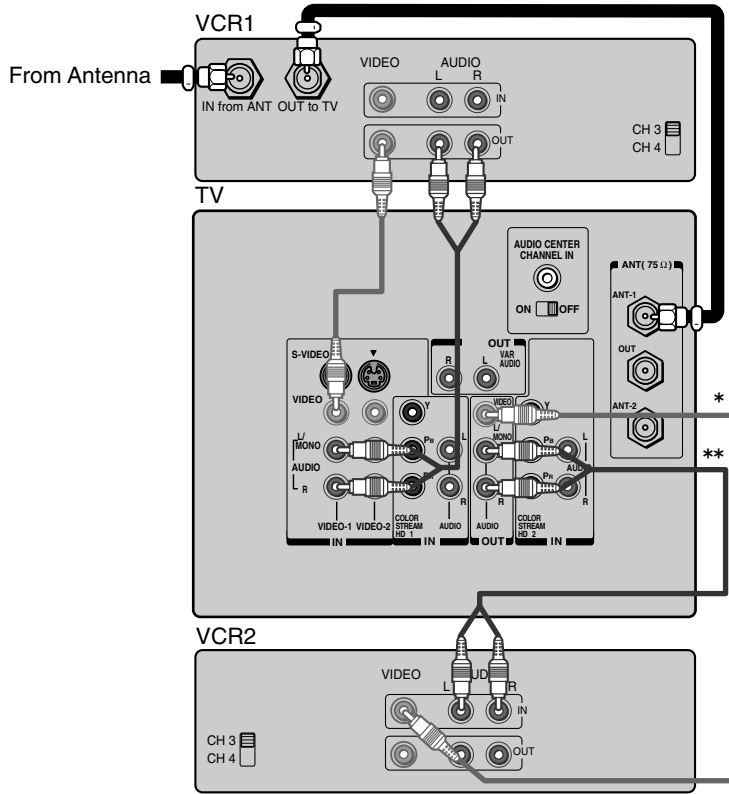

### Caution:

The unauthorized recording of television programs, videotapes, and other materials may infringe upon the provisions of copyright laws.

### Note:

If you have S-VHS VCRs, use S-video cables instead of regular video cables. Do not connect both a regular video cable and an S-video cable to Video-1 or Video-2 at the same time.

Do not connect the same VCR to the output and input jacks on the TV at the same time.

To dub or edit, VCR 2 must select Line IN, and the TV must select Video-1.

\* The Video OUT jack does not output the POP picture.

\*\* The Audio OUT jacks can output the sound of either the Main or POP picture (see "Selecting the Audio OUT sound" on page 47).

## Connecting a camcorder

This connection allows you to watch video materials recorded on a camcorder.

You will need:

- one pair of audio cables
- one video cable (one S-video cable for an S-VHS camcorder)

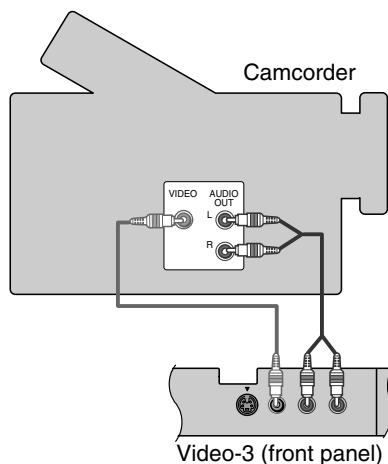

### Caution:

If you have an S-VHS camcorder, use an S-video cable between the S-video jacks on the camcorder and TV. Do not connect both a regular video cable and an S-video cable at the same time.

## Connecting an audio system

This connection allows you to use an audio amplifier to adjust the audio level. This also allows you to use external speakers.

To control the audio, turn on the TV and the stereo amplifier, and turn off the built-in speakers (see “Turning off the built-in speakers” on page 47).

You will need:

- one pair of audio cables

### Note:

To hear sound when using an external audio amplifier, the volume of both the TV and the amplifier must be set above 0 (zero).

For example, if the volume of the TV is set to 0, you will not be able to hear any sound, even the volume of the amplifier is at its highest level.

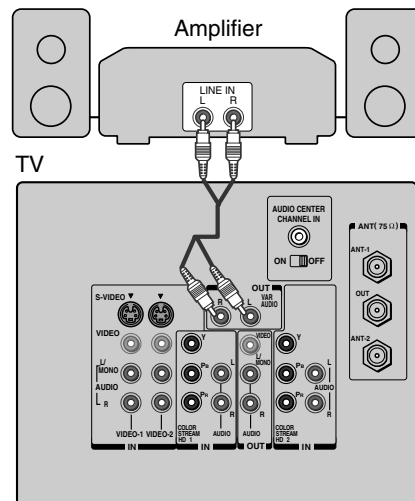

## Connecting an A/V receiver

This connection allows you to use an audio/video (A/V) receiver to enhance your TV's sound.

If you have a system with Dolby Pro Logic® surround sound, you can add to the realism of the sound by using the TV's internal speakers as center channel speakers.

You will need:

- one pair of audio cables
- one single audio cable for the audio center channel
- one video cable

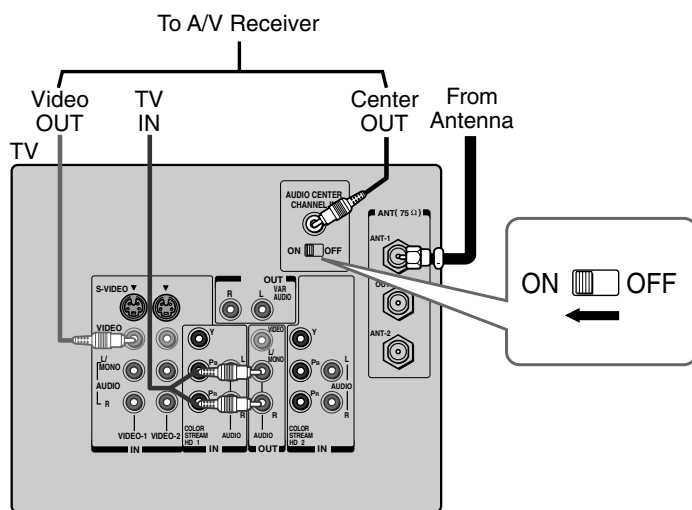

### Note:

Refer to the instructions provided with your A/V receiver for details about your surround sound system.

When the Audio Center Channel ON/OFF switch is in the ON position, the TV speakers will function only as center channel speakers.

Adjust the volume for the center channel speakers using the center level control on the A/V receiver.

To use the TV speakers as normal speakers, set the Audio Center Channel ON/OFF switch to the OFF position.

### Caution:

To avoid damaging the speakers, turn the TV off before connecting or disconnecting the Audio Center Channel audio cable.

### Dolby Pro Logic\* surround sound system connection example

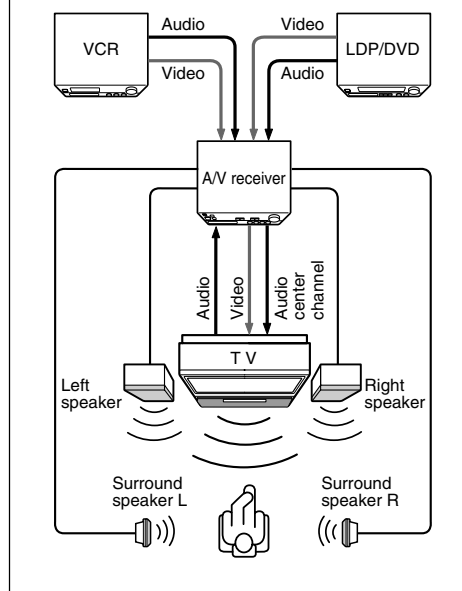

\* Dolby Pro Logic is a registered trademark of Dolby Laboratories Licensing Corporation.

## Using the remote control

### Preparing the remote control for use

With the remote control, you can operate your TV, most VCR models, and cable TV converters together, even if they are different brands. If you will be using your TV with a Toshiba VCR or cable TV converter, your remote control is already programmed and ready to use. If you own different brands of VCRs and/or converters, you must program the remote control. (See “Programming the remote control for use with a non-Toshiba VCR or a cable TV converter” on page 13.)

### Installing the remote control batteries

To install the batteries:

1. Slide the battery cover off the back of the remote control.

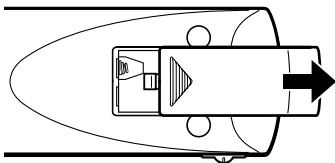

2. Install two “AA” size alkaline batteries. Match the + and - signs on the batteries to the signs on the battery compartment.

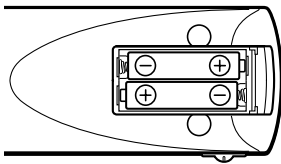

3. Slide the battery cover back on to the remote control until the lock snaps.

### Using the remote control with a Toshiba VCR or cable TV converter

To control a Toshiba VCR:

Set the TV/CABLE/VCR switch to the VCR position. The shaded buttons shown at right will then control the VCR. The unshaded buttons will operate the TV as usual.

If you own different brands of VCRs, program the remote control to recognize the brand of your VCR. (See “Programming the remote control for use with a non-Toshiba VCR or a cable TV converter” on page 13.)

To control a Toshiba cable TV converter:

Set the TV/CABLE/VCR switch to the CABLE position. The shaded buttons shown at right will control the cable TV converter.

#### Note:

Your TV's remote control may not operate certain features on your VCR, cable TV converter, or other electronic device.

Refer to the owner's manuals for your other devices to determine their available features.

If your TV's remote control does not operate a specific feature on a device, use the remote control that came with the device.

#### Caution:

- Dispose of batteries in a designated disposal area. Do not throw batteries into a fire.
- Do not mix battery types or combine used batteries with new ones.
- If the batteries are dead or if you will not use the remote control for a long time, remove the batteries to prevent battery acid from leaking into the battery compartment.

#### Note:

- Battery life expectancy is about one year with normal use.

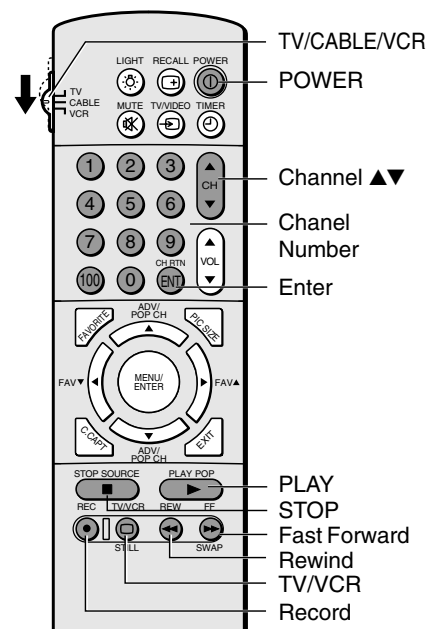

## Programming the remote control for use with a non-Toshiba VCR or cable TV converter

The TV remote control is pre-programmed to operate Toshiba VCRs and cable TV converters. To use the remote control to operate a non-Toshiba VCR or cable TV converter, follow the steps below to program the remote control.

1. Refer to the “VCR code table” or “Cable TV converter code table” on pages 14–15 to find the corresponding code for your VCR or cable TV converter brand.  
If more than one code is listed, try each one separately until you find the one that works.
2. If you are reprogramming the remote control to operate your:
  - **VCR:** Set the TV/CABLE/VCR switch on the remote control to VCR.
  - **Cable TV converter:** Set the TV/CABLE/VCR switch on the remote control to CABLE.
3. While holding down the RECALL button, press the Number buttons (0-9) to enter the three-digit code for your VCR or cable TV converter.
4. Point the remote control at the VCR or converter and press POWER to test the code.  
If the VCR responds, you have entered the correct code.  
If the VCR or converter does not respond, you may have entered the wrong code. Repeat steps 1–4 using another code.
5. Reset the TV/CABLE/VCR switch to TV to control the TV.

For future reference, write down the code(s) you used:

VCR code \_\_\_\_\_

Cable TV converter code \_\_\_\_\_

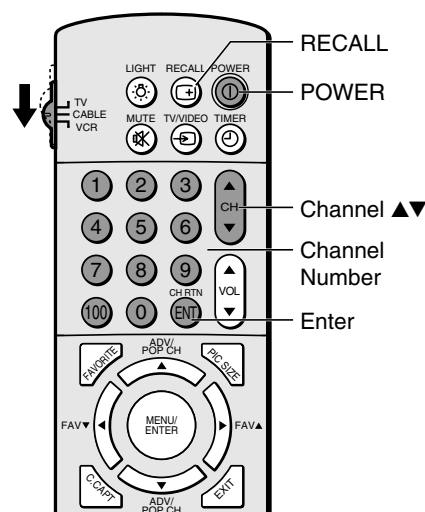

### Note:

- Each time you replace the batteries, you must reprogram the remote control.
- Some newer VCRs are capable of working on either of two remote codes. These VCRs have a switch labeled “VCR1/VCR2.” If your VCR has this kind of switch and does not respond to any of the codes for your VCR brand, set the switch to the other position (VCR1 or VCR2) and reprogram the remote control.

## VCR code table

Brand name	Code number				
Adventura	019	Jensen	060	Quasar	054,096
Aiko	297	JVC	027,060,086	Radio Shack	019,056,344
Aiwa	019	Kenwood	057,060,086	Radix	056
Akai	060,068,080,125, 261	KLH	091	Randex	056
American High	054	Kodak	054,056	RCA	061,079,084,096, 124,125,168,221
Asha	259	Lloyd	019	Realistic	019,054,056,065, 066,067,081,085, 123,259
Audiovox	056	Lloyd's	227	Ricoh	053
Beaumarck	259	Logik	091	Runco	058
Bell & Howell	123	LXI	056	Samsung	064,259
Brandt	206	Magnavox	054,058,100,129, 168	Sanky	058,067
Broksonic	140,203,230,314, 380	Magnin	259	Sansui	060,086
Calix	056	Marantz	054,100	Sanyo	065,066,123,259
Canon	054	Marta	056	Scott	062,064,140,203, 229,230,231
Capehart	039	Masushita	054	Sears	054,056,061,065, 066,073,085,123, 124
Carver	100	MEI	054	Sharp	067,081
CCE	091,297	Memorex	019,054,056,058, 065,066,067,123, 259	Shintom	091
Citizen	056,297	MGA	062,080	Shogun	259
Colt	091	MGN Technology	259	Singer	091
Craig	056,066,091,259	Minolta	061,124	Sony	051,052,053,054
Curtis Mathes	054,060,079	Mitsubishi	062,080,086,094, 192,233,261	STS	061
Cybernex	259	Motorola	054,067	Sylvania	019,054,062,100, 129
Daewoo	039,064,297	MTC	019,259	Symphonic	019,344
Daytron	039	Multitech	019,091	Tatung	060
Dynatech	019	Nad	077	Teac	019,060
Electrohome	056	NEC	057,059,060,069, 086	Technics	054,181
Electroponic	056	Nikko	056	Teknika	019,054,056,071
Emerex	051	Noblex	259	Telefunken	060,206
Emerson	019,021,056,062, 080,087,140,203, 227,228,230,231, 297,313,314,380, 498	Olympus	054	TMK	227,259
Fisher	066,073,085,123	Optimus	056,067,077,123	Toshiba	062,064,085,229, 231,385
Fuji	052,054	Optonica	081	Totevision	056,259
Funai	019,344	Orion	498	Unitech	259
Garrard	019,344	Panasonic	054,096,181,244	Vector	064
GE	054,079,084,221	Penney	054,056,057,059, 061,073,259	Vector Research	057,059
Go Video	251,298	Pentax	061,084,124	Video Concepts	059,064,080
Goldstar	037,056,057	Philco	054	Videosonic	259
Gradiente	019	Philips	054,081,100,129	Wards	019,054,061,066, 067,081,091,168, 231,259
Harley Davidson	019	Pilot	056	XR-1000	019,054,091
Harman/Kardon	057,094	Pioneer	077,086	Yamaha	057
Harwood	087,091	Portland	039	Zenith	052,053,058
Headquarter	065	Protec	091		
HI-Q	066	Pulsar	058		
Hitachi	060,061,084,124, 254	Quarter	065		
		Quartz	065		

## Cable TV converter code table

Brand name	Code number		
ABC	020,022,026,027,	Samsung	059,163
	030,032,033,036,	Scientific Atlanta	025,027,036,296
	066	Signal	034,059
Antronix	041	Signature	030
Archer	041,058,172	SL Marx	059
Belcor	075	Sprucer	040
Cable Star	075	Standard	
Cabletenna	041	Components	174
Cableview	041	Starcom	022,034,066
Century	172	Stargate	034,059
Citizen	172	Starquest	034
Colour Voice	044,050	Sylvania	020
Comtronics	059,079	Teleview	059
Contec	038	Texscan	020
Dae Ryung	027	Tocom	031,032,078
Eastern	021	Toshiba	019
Focus	419	Tusa	034
Garrard	172	Unika	041,172
GC Electronics	035,075	United Artists	026
Gemini	034,089	United Cable	022
General Instrument	030,295	Universal	041,058,075,096,
GoldStar	059,163		172,210
Hamlin	028,039,053,278,	Viewstar	046,079,230
	292	Zenith	019
Hitachi	030	Zentek	419
Hytex	026		
Jasco	172		
Jerrold	022,030,031,033,		
	034,043,066,295		
Macom	052		
Magnavox	046		
Memorex	019		
Movie Time	175		
NSC	089,175		
Oak	026,038,267		
Panasonic	019,040,126		
Paragon	019		
Philips	044,046,047,048,		
	049,050,172		
Pioneer	042,163,552		
Popular Mechanics	419		
Pulsar	019		
RCA	040		
Recoton	419		
Regal	039,278,292		
Regency	021		
Rembrandt	030,089		
Runco	019		

## Learning about the remote control

**POWER** turns the TV on and off

**RECALL** displays information on-screen (page 48)

**LIGHT** illuminates the keypad for five seconds

**TIMER** sets the TV to turn off at a specific time (page 43)

**TV/VIDEO** selects the video input source (page 41)

**MUTE** mutes the sound (page 44)

**TV/CABLE/VCR** switches between TV, Cable and VCR (pages 12-13)

**Channel ▲ ▼** cycles through programmed channels (page 20)

**Channel Numbers** allow direct access to channels (page 20)

**VOL ▲ ▼** adjusts the volume level

**CH RTN** returns to the last viewed channel (page 23)

**MENU** accesses on-screen programming menus (page 17)

**ENTER** sets programmed menu information (page 17)

**▲ ▼ ◀ ▶** select or adjust programming menus (page 17)

**POP CH ▲ ▼** select the POP (picture-out-picture) channel (page 29)

**FAV ◀ ▶** cycle through favorite channels (page 23)

**FAVORITE** accesses the favorite channel search function (page 30)

**PIC SIZE** cycles through the five picture sizes: Normal; Theater Wide 1, 2, 3; and Full (page 26)

**C.CAPT** cycles through closed caption settings (page 42)

**EXIT** closes programming menus (page 17)

**POP** turns the POP feature on and off (page 29)

**SOURCE** selects the POP picture source (page 29)

**STILL** freezes the POP picture (page 30)

**SWAP** switches the main and POP pictures (page 30)

**VCR Functions** allow access to VCR functions (page 12)

**STOP** stops a videotape

**REC** starts recording a videotape

**PLAY** plays a videotape

**FF** fast forwards a videotape

**REW** rewinds a videotape

**TV/VCR** toggles between TV and VCR when viewing while recording

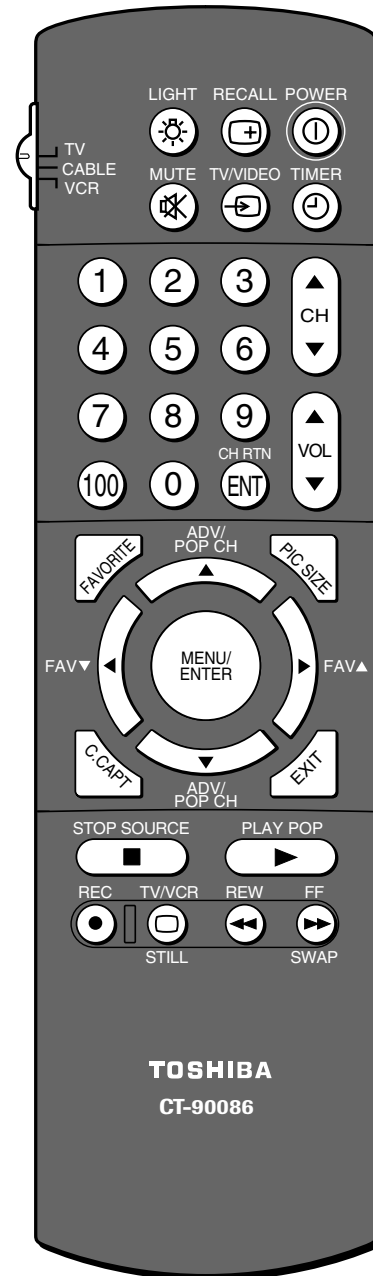

**Note:**

The error message "Not Available" will appear if you press a key for a function that is not available.



# Setting up your TV

## Learning about the menu system

After you have installed the batteries and programmed the remote control, you will need to set some preferences on the TV using the menu system. You can access the menus using the buttons on your TV or remote control.

1. Press MENU to display the menu system.
2. Press ◀ or ▶ to select a menu.
3. Press ▲ or ▼ select an item.
4. Press ◀ or ▶ to select or adjust a setting.

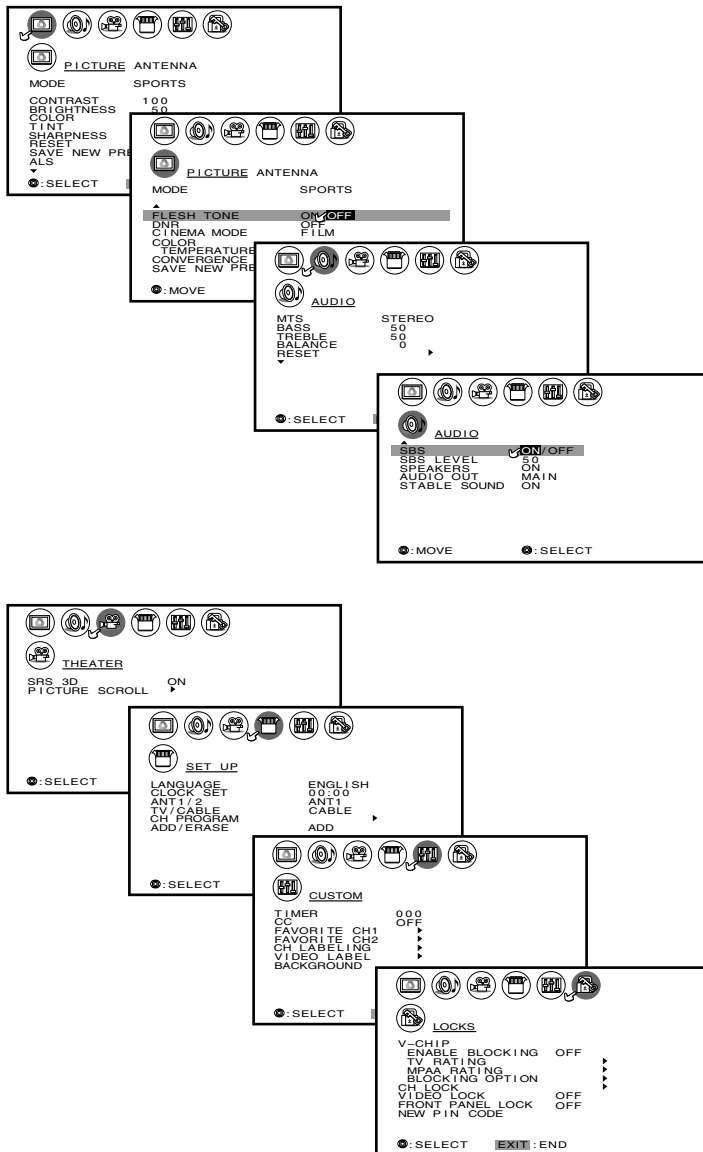

- Press ENTER to activate the function settings in the SET UP menu.
- If you do not make a selection within 15 seconds, the main menus close automatically; the other menus close automatically within 6 seconds (except the Convergence menu, which will remain until a button is pressed).
- If you want to close an on-screen menu instantly, press EXIT.

TV Front Panel

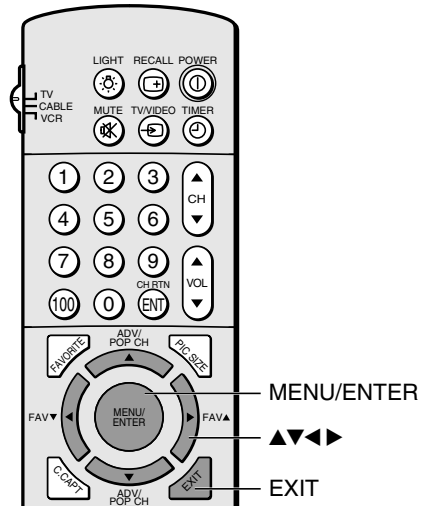
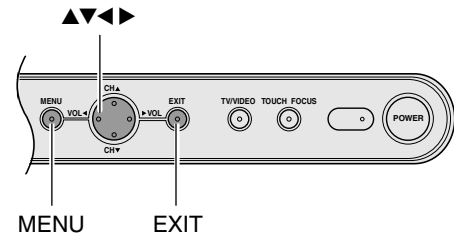

**Note:**

- The menu illustrations on the following pages have been distorted for easy reference.
- You can change the background of the menu. See page 48 for details.

## Changing the on-screen display language

Choose from three different languages (English, French and Spanish) for the on-screen display of adjustment menus and messages.

To select a language:

1. Press MENU, and then press ◀ or ▶ until the SET UP menu appears.
2. Press ▲ or ▼ to highlight LANGUAGE.

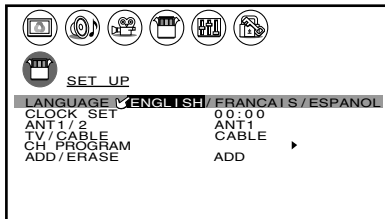

3. Press ◀ or ▶ to highlight the desired language.

## Selecting the antenna input

You can connect to two different antenna input sources (ANT 1 or ANT 2).

To select the antenna input using the menu system:

1. Press MENU, and then press ◀ or ▶ to highlight the SET UP menu.
2. Press ▲ or ▼ to highlight ANT 1/2.

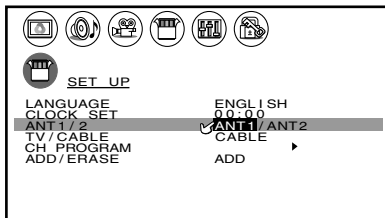

3. Press ◀ or ▶ to highlight either ANT 1 or ANT 2, depending on the antenna terminal you wish to use.

## Using the TV/VIDEO button to select the antenna input

To select the antenna input using the TV/VIDEO button:

1. Press the TV/VIDEO button on the remote control or TV (see illustrations below). The current signal source displays in purple.
2. Continue pressing the TV/VIDEO button to select ANT 1 or ANT 2.

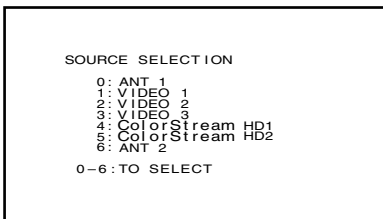

Pressing TV/VIDEO on the remote control displays the current signal source (press TV/VIDEO again or 0-6 to change)

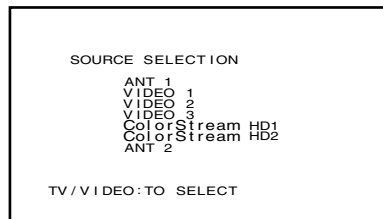

Pressing TV/VIDEO on the TV changes the current signal source

TV Front Panel

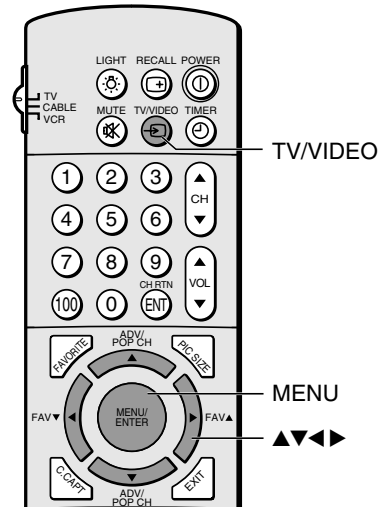
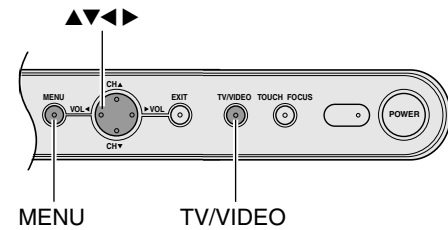

## Adding channels to the TV's memory

When you press Channel ▲ or ▼, your TV will select only the channels stored in the TV's channel memory.

Follow the steps below and on the next page to program all active channels into the TV's memory.

### Programming channels automatically

Your TV can automatically detect all active channels in your area and store them in its memory. After the channels are stored automatically, you can manually add or erase individual channels (see page 20).

If you use both ANT-1 and ANT-2 terminals, you must program channels for each input source.

To program channels automatically:

1. Press MENU, and then press ◀ or ▶ until the SET UP menu appears.
2. Press ▲ or ▼ until TV/CABLE is highlighted.
3. Press ◀ or ▶ to highlight either TV or CABLE, depending on which you use. If you use an antenna, highlight TV; if you use cable, highlight CABLE.

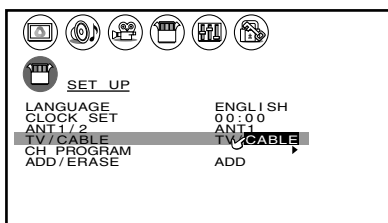

4. Press ▼ to select CH PROGRAM.

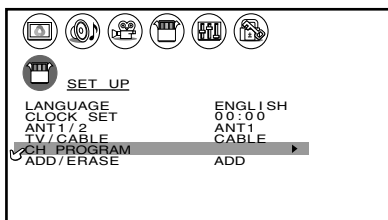

5. Press ◀ or ▶ to start channel programming. The TV will automatically cycle through all the TV or Cable channels (depending on which you selected), and store all active channels in the channel memory.

While the TV is cycling through the channels, the message "Programming Now—Please Wait" appears.

6. When channel programming is complete, the message "Completed" appears.
7. Press Channel ▲ or ▼ to view the programmed channels.

### Note:

To tune the TV to a channel not programmed in the channel memory, use the Channel Number buttons on the remote control.

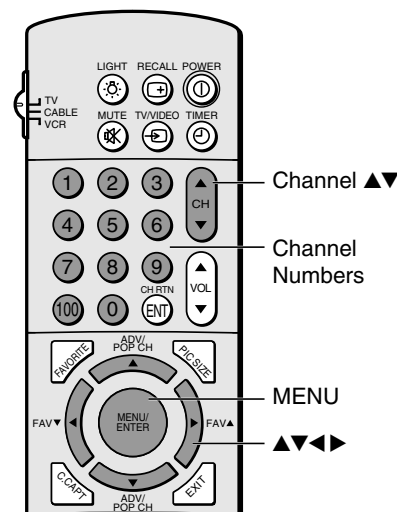

## Adding and erasing channels manually

After you have programmed the channels automatically, you can manually add or erase specific channels.

To add or erase channels:

1. Select the channel you want to add or erase. If you are adding a channel, you must select the channel using the Channel Number buttons.
2. Press MENU, and then press ◀ or ▶ until the SET UP menu appears.
3. Press ▲ or ▼ to highlight ADD/ERASE.

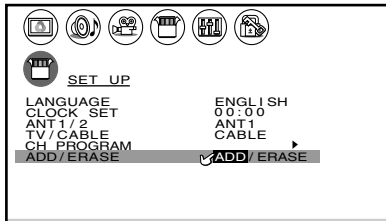

4. Press ◀ or ▶ to select ADD or ERASE, depending on which function you want to perform.
5. Press ▼ to add (or erase) the channel.
6. Repeat steps 1–5 for other channels you want to add or erase.

## Changing channels

To change to the next programmed channel:

Press Channel ▲ or ▼ on the TV or remote control.

To change to a specific programmed channel:

Press and hold Channel ▲ or ▼ for about one second. The TV will enter the channel surf mode.

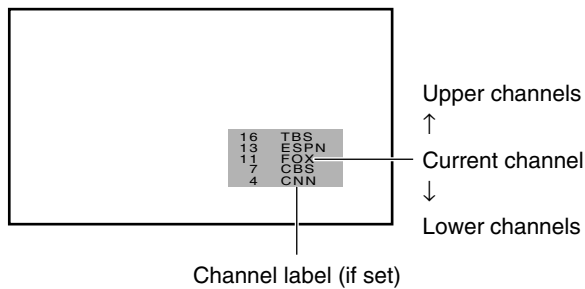

Repeatedly press or hold Channel ▲ or ▼ while the channel surf mode is on-screen to scroll the channel list. Release the button to display the highlighted channel.

To change to a specific channel (programmed or unprogrammed):

Press the Channel Number buttons (0–9 and 100).

For channels 100 and higher, press the 100 button, and then the next two numbers. For example, to select channel 125, press 100, 2, 5.

TV Front Panel

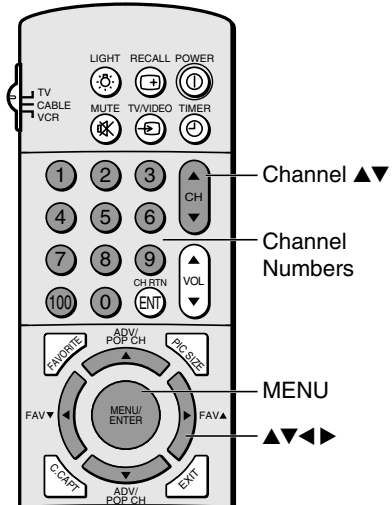
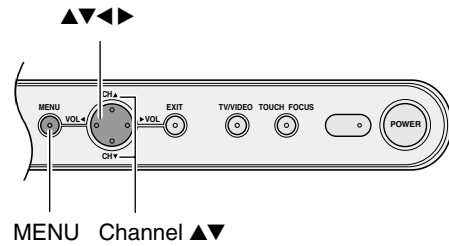

# Adjusting the color convergence

This projection TV uses three separate TV tubes: red, green, and blue. The red, green, and blue images are projected onto the screen where they converge to form a full-color picture. You can see a clear picture only when the three images converge correctly. Convergence may drift over time or if you move the TV. If you can see clear images on your TV screen, skip this procedure.

Make this adjustment after the TV has been on for at least 30 minutes.

To use the TOUCH FOCUS (auto convergence) button:

Press TOUCH FOCUS on the TV once. The TV will enter the auto convergence mode and correctly adjust convergence automatically.

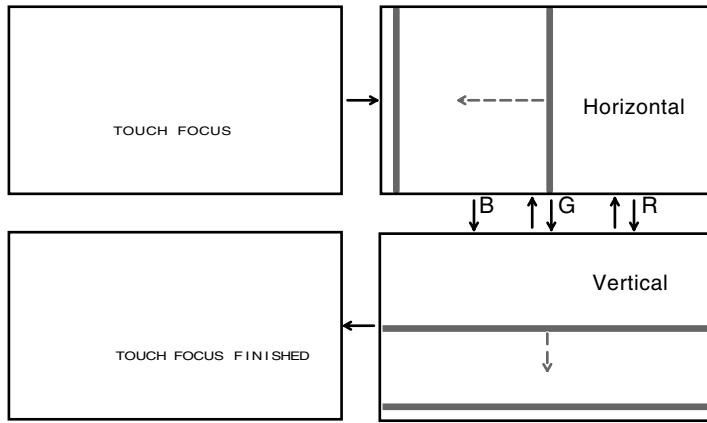

When the adjustment is complete, the normal picture reappears. If the error message "Touch Focus Error" appears, retry the TOUCH FOCUS adjustment or adjust the convergence manually, as described below.

To check and adjust the color convergence manually:

1. Press MENU, and then press ◀ or ▶ until the PICTURE menu appears.
2. Press ▲ or ▼ to highlight CONVERGENCE.

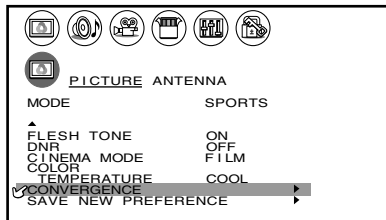

(Continued on next page)

TV Front Panel

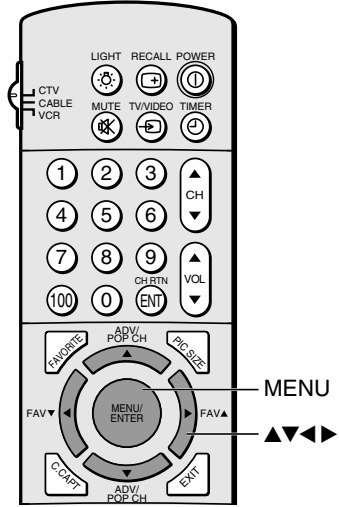
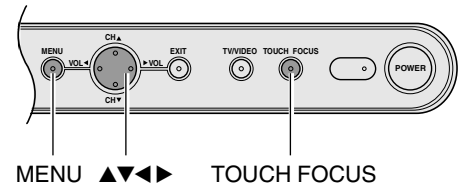

- Press ◀ or ▶ to display the Center Convergence menu.

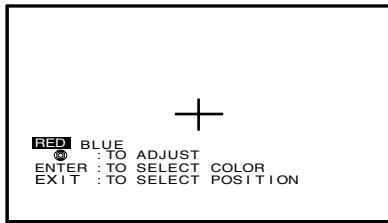

If you see separate red, blue, or green crossed lines (or red or blue shadows next to white lines), you need to adjust the convergence.

- Press ENTER to highlight RED or BLUE, depending on which color needs adjusting. If both red and blue need adjusting, you will need to perform steps 4 and 5 twice.
- Press ▲ (up), ▼ (down), ◀ (left), or ▶ (right) on the remote control to converge the red or blue line into the green line, which will turn completely white when correctly adjusted. When color convergence is correctly adjusted, you will see two single crossed white lines.
- Press EXIT to display the Circumference Convergence menu.
- Press the corresponding Number button (1–4 and 6–9) to select the area you want to adjust.

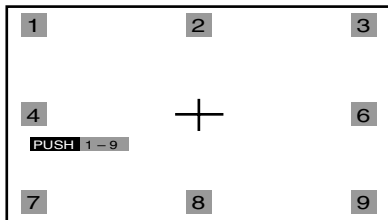

- Press ENTER to highlight RED or BLUE, depending on which color needs adjusting. If both red and blue need adjusting, you will need to perform steps 8 and 9 twice for the selected area.

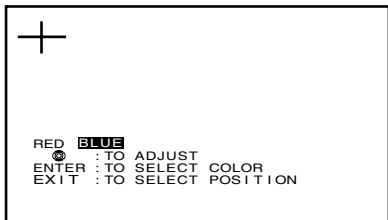

- Press ▲▼◀▶ to converge the red or blue line into the green line, which will turn completely white when correctly adjusted. Repeat steps 8 and 9 until you see two single crossed white lines.
- Press EXIT once to select another area to adjust, and then repeat steps 7–9.
- Press EXIT twice to close the Convergence menu.

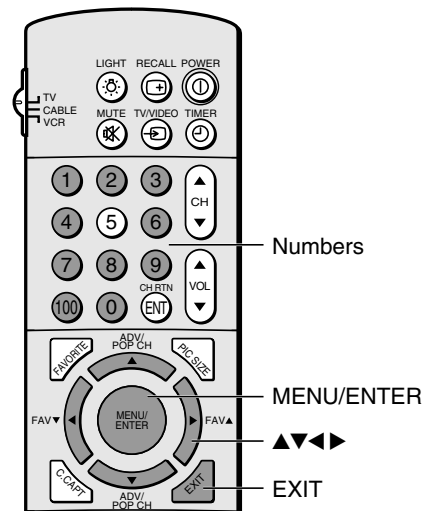

# Using the TV's features

## Adjusting the channel settings

### Switching between two channels

You can switch between two channels without entering an actual channel number each time.

To switch between two channels:

1. Select the first channel you want to view.
2. Select a second channel with the Channel Number buttons (0-9, 100).
3. Press CH RTN. The previous channel will be displayed.

Each time you press CH RTN, the TV will switch back and forth between the two channels.

### Programming your favorite channels

You can preset up to 9 of your favorite channels each for the FAVORITE CH1 and FAVORITE CH2 modes using the Favorite Channel Programming feature. Because this feature scans through only your favorite channels, it allows you to skip other channels you do not normally watch.

To program your favorite channels:

1. Press MENU, and then press ◀ or ▶ until the CUSTOM menu appears.
2. Press ▲ or ▼ to highlight FAVORITE CH1 or FAVORITE CH2.

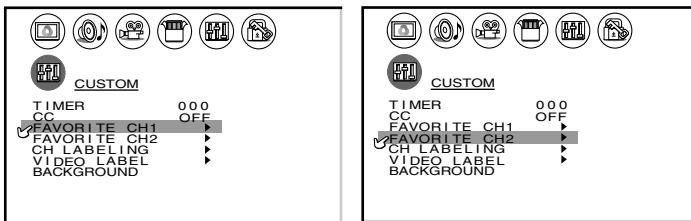

3. Press ◀ or ▶ to display the FAVORITE CH1 menu, for example. CH INPUT will be highlighted.

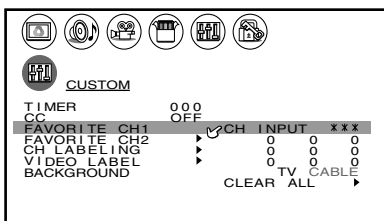

4. Press the Channel Number buttons to enter one of your favorite channels.
5. Press ENTER.
6. Repeat steps 4 and 5 for other channels.

To select your favorite channels:

Press FAV ▼ or ▲.

To quickly scan through your favorite channels in a 9-picture multi-window:

Press FAVORITE (see page 30).

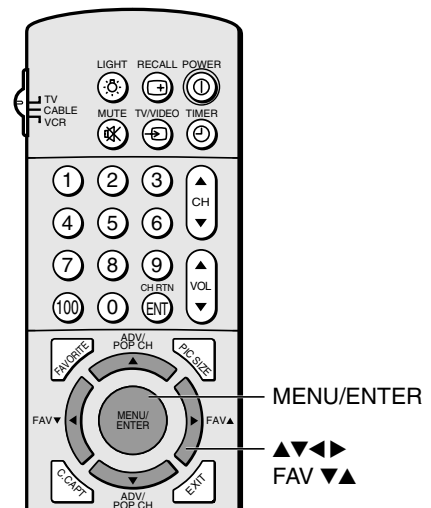
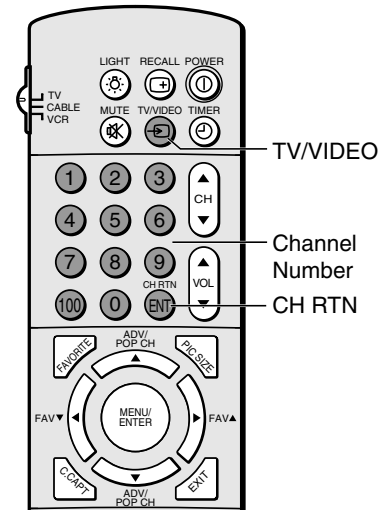

**Note:**

- The FAV ▼▲ buttons operate as MENU ◀▶ buttons when a menu is on-screen.
- The favorite channel feature is not available in ANT2 mode.

To clear a favorite channel:

1. Press MENU, and then press ◀ or ▶ until the CUSTOM menu appears.
2. Press ▲ or ▼ to highlight FAVORITE CH2, for example.
3. Press ◀ or ▶ to display the FAVORITE CH2 menu.

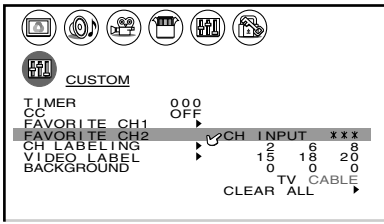

4. Press ▲▼◀▶ to highlight the channel you want to clear, then press ENTER.

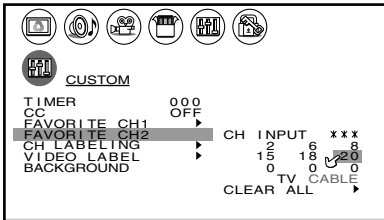

5. Repeat step 4 for other channels.

To clear all favorite channels at once:

- Press ▲ or ▼ to highlight CLEAR ALL in step 4 above, and then press ▶ or ◀.

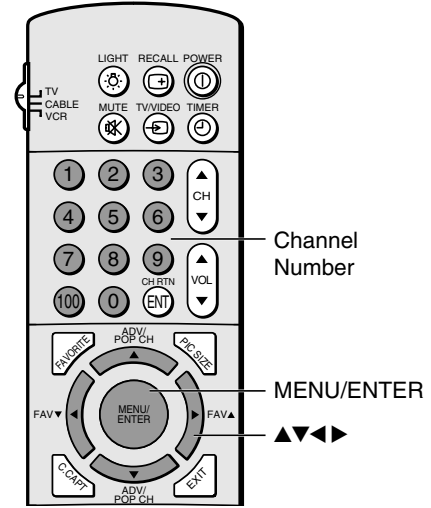
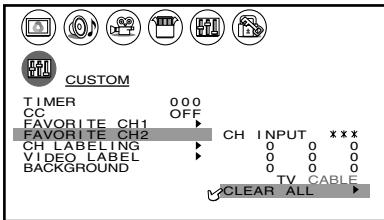

## Labeling channels

Channel labels appear above the on-screen channel number each time you turn on the TV, change the channel, or press RECALL. You can choose any four characters to identify a channel.

To create channel labels:

1. Press MENU, and then press ◀ or ▶ until the CUSTOM menu appears.
2. Press ▲ or ▼ to highlight CH LABELING.
3. Press ◀ or ▶ to display the CH LABELING menu.  
CH INPUT will be highlighted.

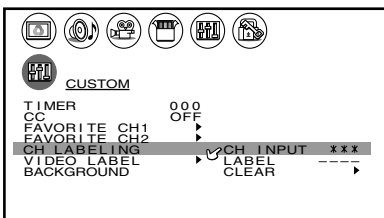



- Press the Channel Number buttons to select a channel you want to label.

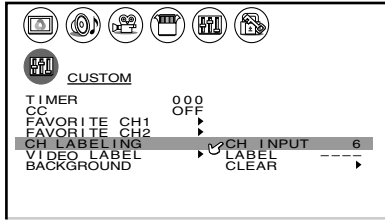

- Press ▼ to highlight LABEL.
- Press ◀ or ▶ repeatedly to select a character for the first space, and then press ENTER.

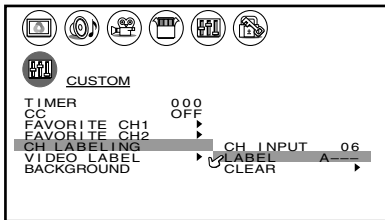

- Repeat step 6 to enter the rest of the characters.  
If you would like a blank space in the label name, you must choose an empty space from the list of characters. Otherwise, a dash “-” will appear in that space.
- Repeat steps 4–6 for other channels. You can assign labels to a maximum of 32 channels.

To erase channel labels:

- Press MENU, and then press ◀ or ▶ until the CUSTOM menu appears.
- Press ▲ or ▼ to highlight CH LABELING.
- Press ◀ or ▶ to display the CH LABELING menu.
- Press ▼ to highlight CH INPUT, then select the channel you want to clear with the Channel Number buttons.
- Press ▼ to highlight CLEAR.

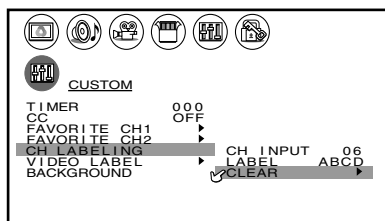

- Press ◀ or ▶ to erase the channel label.
- Repeat steps 4–6 to erase other channel labels.

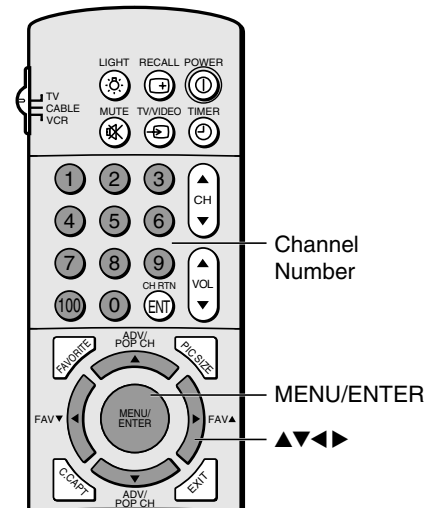

## Viewing the wide-screen picture formats

You can view programs that have the conventional TV picture format (4:3 aspect ratio) and the wide-screen format (16:9 aspect ratio) in a variety of picture sizes.

### Selecting the picture size

Repeatedly press PIC SIZE to select either Normal, Theater Wide 1, Theater Wide 2, Theater Wide 3, or Full picture size, as described below.

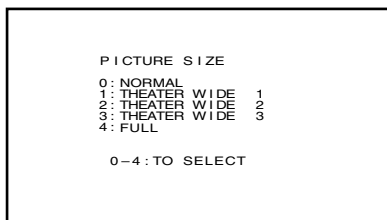

While the above menu is on-screen, select the desired picture size by pressing the corresponding number button (0–4).

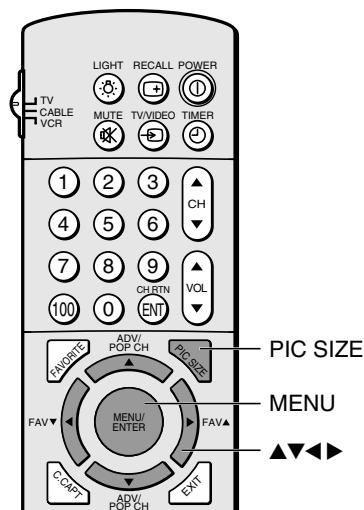

### Normal

The Normal picture size displays the picture in the conventional 4:3 aspect ratio, with bars at the left and right.

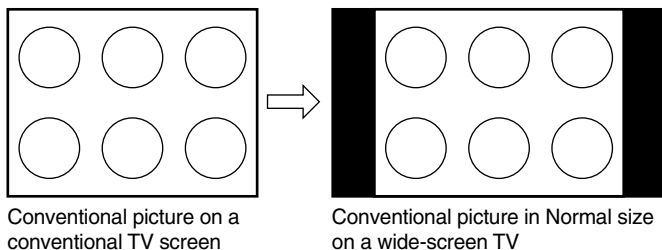

### Note:

If you select the Theater Wide picture size for conventional size programs, parts of the picture at the top and bottom of the screen may be hidden. You can adjust the height of the picture or scroll the picture (see "Theater Wide 1, 2, 3" on page 27 and "Scrolling the Theater Wide picture" on page 28.)

### Full

Full picture size stretches the picture to fill the screen width (distorts the picture).

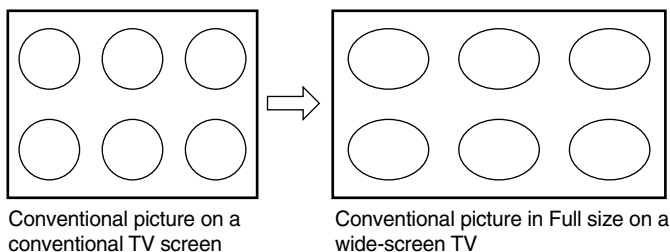

## Theater Wide 1, 2, 3

The Theater Wide picture size enlarges the picture to fill the screen (see note at right).

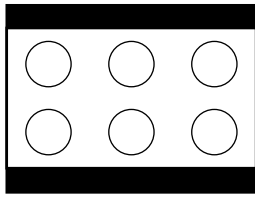

Wide-screen picture on conventional TV screen (also known as “letter box” format, with bars at top and bottom)

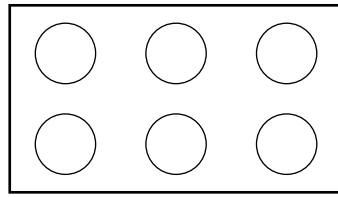

Wide-screen picture in Theater Wide size on wide-screen TV

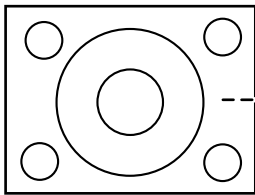

Conventional picture on conventional TV screen

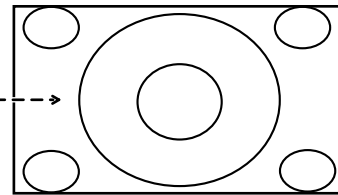

Theater Wide 1

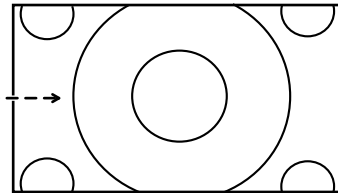

Theater Wide 2

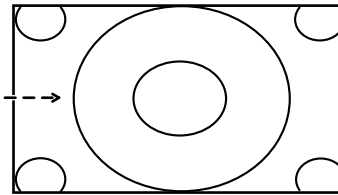

Theater Wide 3

### Theater Wide 1 (recommended mode):

- The picture is non-uniformly enlarged—the center of the picture remains close to its true proportion, but the left and right edges are stretched wider to fill the screen.
- None of the picture is hidden.

### Theater Wide 2:

- The entire picture is uniformly enlarged—it is stretched the same amount both wider and taller (retains its true proportion).
- Part of the picture (top and bottom) is hidden. To view the hidden areas, see “Scrolling the Theater Wide picture” on page 28.

### Theater Wide 3:

- The picture is non-uniformly enlarged—it is stretched wider to fill the width of the screen, but only slightly stretched taller.
- A small part of the picture (top and bottom) is hidden. To view the hidden areas, see “Scrolling the Theater Wide picture” on page 28.

## Scrolling the Theater Wide picture (Theater Wide 2 and 3 only)

1. Press PIC SIZE to select the Theater Wide 2 or 3 mode.
2. Press MENU, and then press ◀ or ▶ until THEATER menu appears.
3. Press ▲ or ▼ to highlight PICTURE SCROLL.

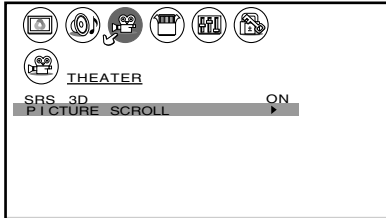

4. Press ◀ or ▶ to display the Scroll Adjustment mode.

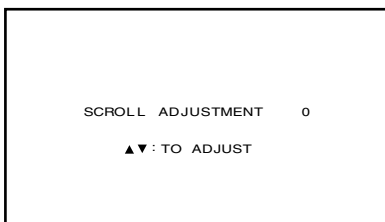

5. Press ▲ or ▼ to adjust the vertical position of the picture.
  - Normal (center) position

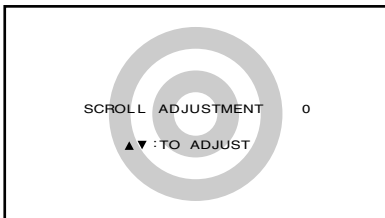

- To raise the picture, press ▲.

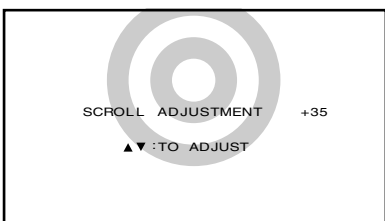

- To lower the picture, press ▼.

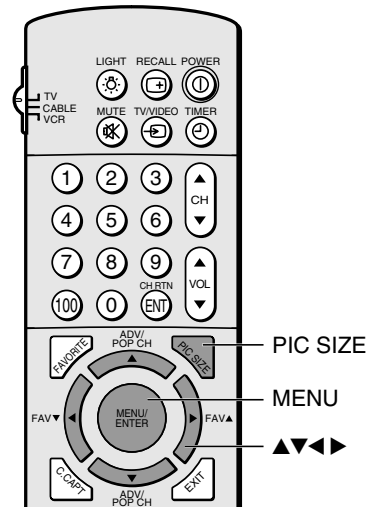
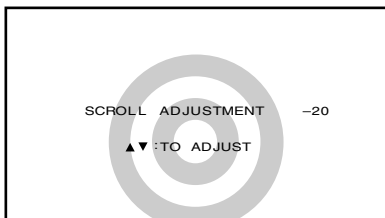

### Note:

You can scroll the picture in Theater Wide 2 and Theater Wide 3 only. The scroll amounts are as follows:

- 480i signal source:
  - Wide 1: Not adjustable
  - Wide 2: +45 to -20
  - Wide 3: +45 to -20
- 480p signal source:
  - Wide 1: Not adjustable
  - Wide 2: +30 to -20
  - Wide 3: +30 to -20

## Using the POP double-window feature

The POP (picture-out-picture) feature splits the screen into a double window that allows you to watch two programs at the same time. The POP program can come from a TV broadcast or an external source, such as a VCR.

To display a TV broadcast in the POP window:

1. Press POP to display the POP window.

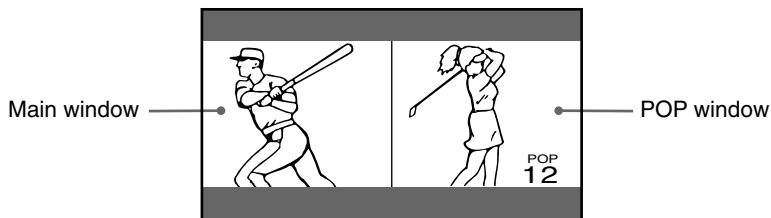

2. Press POP CH ▲▼ to change the channel of the POP window. If the V-CHIP feature is active and you try to watch a TV program that exceeds the set rating limits, the program will be blocked (see “Using the V-CHIP menu” on page 32).

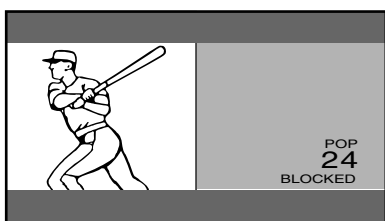

To display a picture from an external source in the POP window:

1. Connect the external source equipment (see “Connecting your TV” on page 5).
2. Select the TV program you want to watch in the main window.
3. Press POP to display the POP window.
4. Repeatedly press SOURCE to select the input source for the POP window (VIDEO 1, VIDEO 2, or VIDEO 3 only; you cannot select ColorStream in POP mode). The current source will display in purple.
5. You can play a tape as the POP picture, or select a channel for the POP window using the VCR’s channel keys.

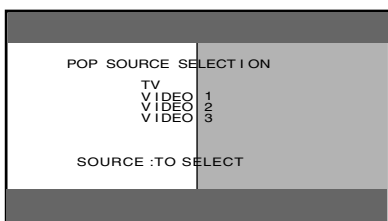

To close the POP window:

Press POP again.

### Note:

- The POP buttons on the remote control operate the TV’s POP features.
- You cannot access POP features when viewing ColorStream HD1 or HD2 input.
- You cannot display the ANT-2 signal source in the POP window.
- You can choose to hear the sound of either the main or POP program (see “Selecting the Audio OUT sound” on page 47).

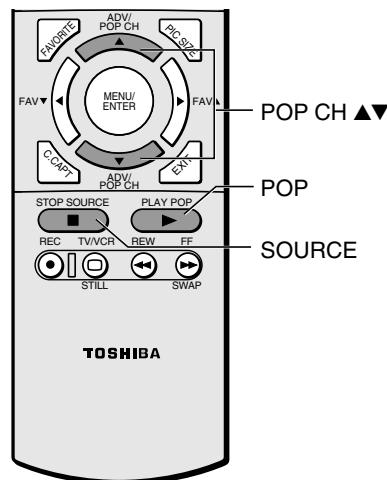

## Switching the main and POP pictures

Press SWAP while you are using the POP feature to switch the main and POP pictures.

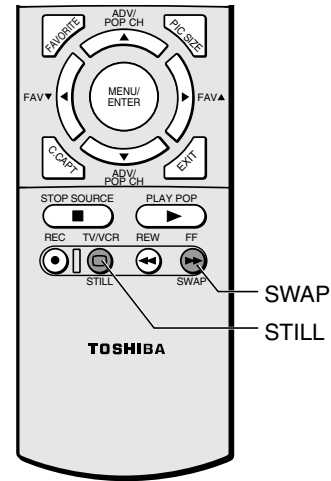
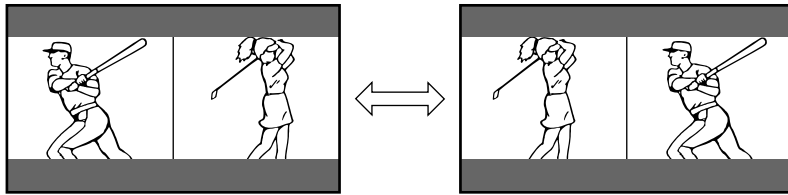

## Freezing the POP picture

Press STILL while you are using the POP feature. The POP picture will become a still picture. To return to the moving picture, press STILL again.

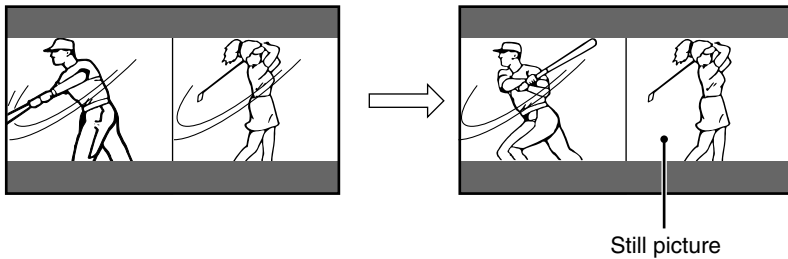

## Using the favorite channel search function

You can use the favorite channel search function to quickly scan your favorite channels (see "Programming your favorite channels" on page 23).

1. Press FAVORITE.  
The TV automatically enters POP mode, and begins a nine-picture scan of your favorite channels in the POP window. The first window will display as a moving picture.

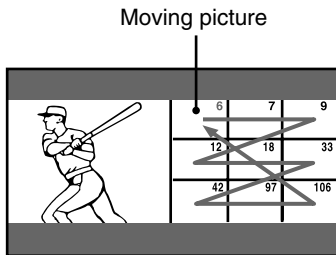

2. Press ▲▼◀▶ to select one of the nine pictures (becomes a moving picture).
3. Press ENTER to display the channel you selected in step 2 as a normal picture.

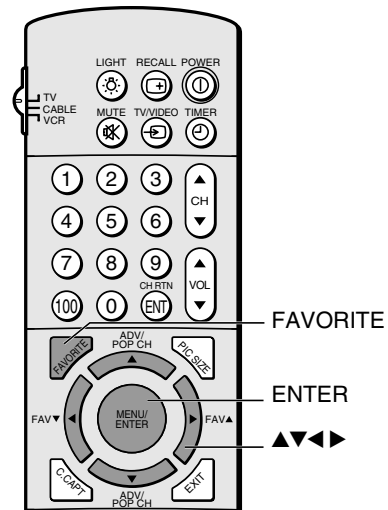
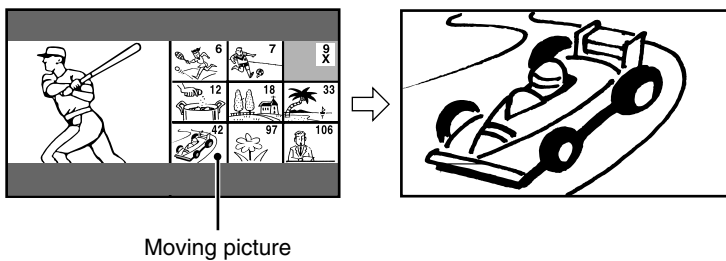

Every time you press FAVORITE, the POP window scans your favorite channels in the following order:

FAVORITE CH1 — FAVORITE CH2 — Off

## Using the LOCKS menu

The LOCKS menu includes the V-Chip, CH Lock, Video Lock, and New PIN Code functions. You can use these functions after entering the correct PIN code.

### Entering the PIN code

1. Press MENU, and then press ◀ or ▶ until the LOCKS menu appears.

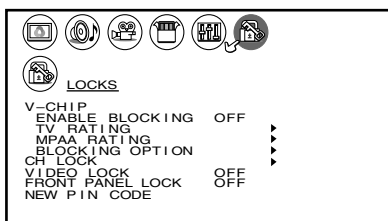

2. Press ▲ or ▼ to display the PIN code entering mode.

- Blocking Reset status: Set your 4-digit code by pressing the Number buttons (0-9), and then press ENTER.
- When the PIN code is already stored: Press the Number buttons (0-9) to enter the 4-digit PIN code used for blocking channels, and then press ENTER.



If the wrong PIN code is entered, the message “Incorrect” appears. Enter the code again, and then press ENTER.

If you cannot remember the PIN code, while in the PIN code entering mode, press the RECALL button four times within five seconds. The PIN code will be released (Blocking Reset status restored).

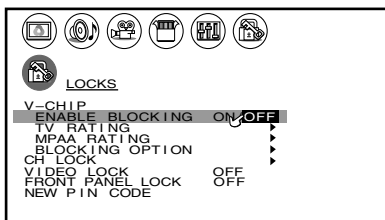

Continue to set each item following the steps on the next page.

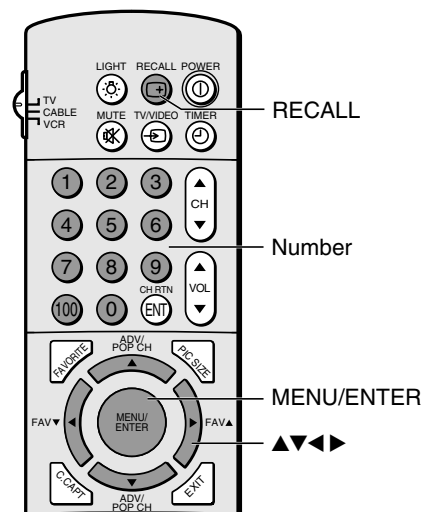

## Using the V-CHIP menu

Some TV programs and movies include signals that classify the content of the program (violence, sex, dialog, language). The V-CHIP control feature in this TV detects the signals and blocks the programs according to your selections. To use this feature, perform the following setup.

### ENABLE BLOCKING

1. From the LOCKS menu, select ENABLE BLOCKING.
2. Press ◀ or ▶ to select ON or OFF.  
ON : To enable your setting (Lock)  
OFF: To release your setting (Unlock)

**Note:** The CH LOCK function is not affected with this selection.

### TV RATING (Independent rating system for broadcasters)

1. From the LOCKS menu, select TV RATING.
2. Press ◀ or ▶ to display the TV RATING menu.
3. Press ▼ or ▲ to select item.
4. Press ▶ to lock (display “X”)  
Press ◀ to unlock (display “✓”)
5. Repeat steps 3 and 4 to set the next item.

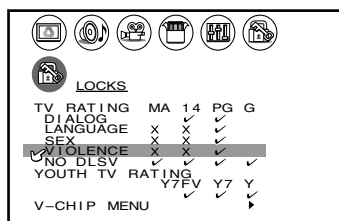

The TV age-based ratings and content themes that can be blocked are listed in the table below.

Ratings	Description and Content themes
MA	Mature Audience Only (This program is specifically designed to be viewed by adults and therefore may be unsuitable for children under 17.) <b>L) Crude or indecent language S) Explicit sexual activity V) Graphic violence</b>
14	Parents Strongly Cautioned (This program contains some material that many parents would find unsuitable for children under 14 years of age.) <b>D) Intensely suggestive dialog L) Strong, coarse language S) Intense sexual situations V) Intense violence</b>
PG	Parental Guidances Suggested (This program contains material that parents may find unsuitable for younger children.) <b>D) Some suggestive dialog L) Infrequent coarse language S) Some sexual situations V) Moderate violence</b>
G	General Audience (Most parents would find this program suitable for all ages.)
Y7, Y7FV	Directed to Older Children (This program is designed for children age 7 and above. Note: Programs in which fantasy violence may be more intense or more combative than other programs in this category are designated Y7FV.)
Y	All Children (This program is designed to be appropriate for all children)

### LOCKS menu

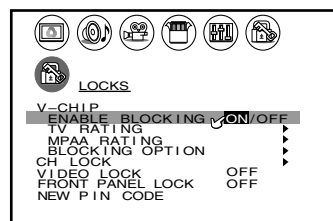

To select each item:

Press ▼ or ▲.

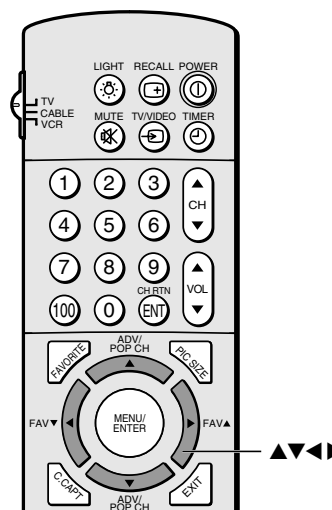

Press RECALL to display the rating of the TV program you are currently watching.

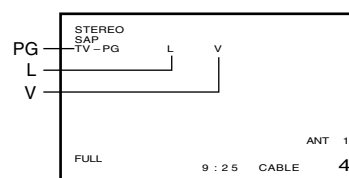



## MPAA RATING (Independent rating system for movies)

1. From the LOCKS menu, select MPAA RATING.
2. Press ◀ or ▶ to display the MPAA RATING menu, then press ▼ or ▲ to highlight MPAA RATING.
3. Press ◀ or ▶ to display the MPAA RATING menu.

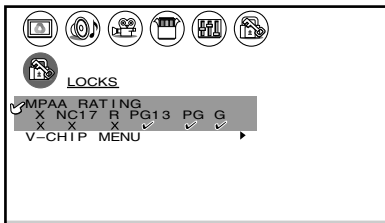

4. Press ▶ to lock ("X") or press ◀ to unlock ("✓").

The movie ratings you can lock are described as follows:

- X : X-rated (For adults only)
- NC17: Not intended for anyone 17 and under
- R : Restricted (Under 17 requires accompanying parent or adult guardian.)
- PG13 : Parents Strongly Cautioned (Some material may be inappropriate for children under 13)
- PG : Parental Guidance Suggested (Some material may not be suitable for children)
- G : General Audience (Appropriate for all ages)

## BLOCKING OPTION

1. From the LOCKS menu, select BLOCKING OPTION.
2. Press ◀ or ▶ to display the BLOCKING OPTION menu, then press ▲ or ▼ to select item.

MPAA UNRATED:

Press ◀ or ▶ to select ON (Lock) or OFF (Unlock) for unrated programs in the MPAA rating system.

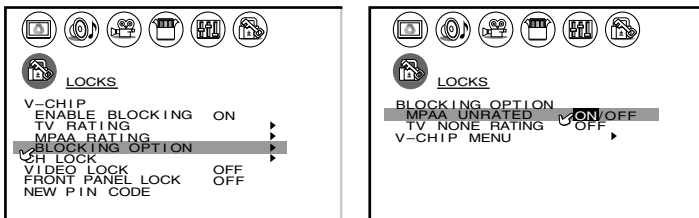

TV NONE RATING

Press ◀ or ▶ to select ON (Lock) or OFF (Unlock) for programs rated NONE in the TV PARENTAL GUIDELINES.

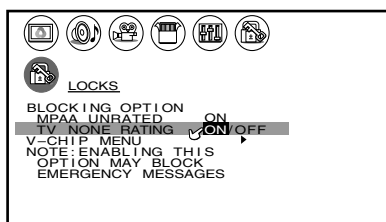

V-CHIP MENU:

Press ◀ or ▶ to return to the LOCKS menu.

## LOCKS menu

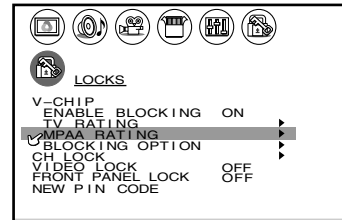

To select each item:

Press ▼ or ▲.

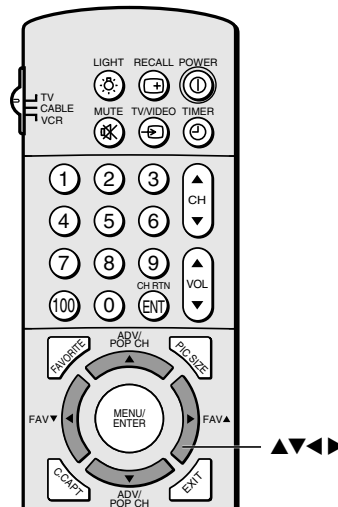

## Caution

Be aware that setting the TV None Rating to ON may block the broadcast of emergency information. The menu will display the note, "Enabling this option may block emergency messages" to warn you of this possibility.

## Note

The POP feature is not locked even if TV None Rating is set to ON (locked).

## Unlocking programs temporarily

1. If you try to watch a TV program that exceeds the set rating limits, the TV enters program lock mode. After 4 seconds, the TV starts the favorite channel search function (see page 30). You can either unlock the program temporarily (see steps 2-4) or select a non-locked program to watch.

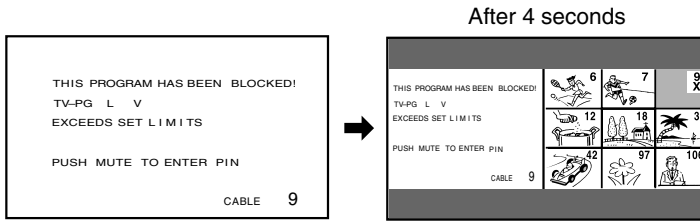

2. To temporarily unlock the program, press MUTE.
3. Press the Number buttons (0-9) to enter your 4-digit PIN code.

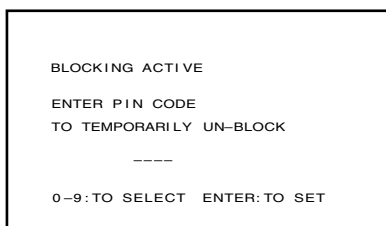

4. Press ENTER.  
If the correct code is entered, the program lock mode is released and the normal picture appears.  
All locking is disabled until the TV is turned off, and will be enabled when the TV is turned on again.

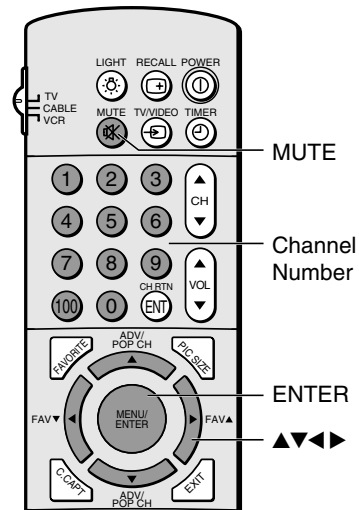

## Locking channels

With the CH LOCK feature, you can lock specific channels. The TV will not be able to tune locked channels with the Channel  $\blacktriangle$   $\blacktriangledown$  buttons or Channel Number buttons unless you clear the setting.

You can lock a maximum of nine channels.

To lock channels:

1. From the LOCKS menu, select CH LOCK. CH INPUT will be highlighted.
2. Press  $\blacktriangleleft$  or  $\blacktriangleright$  to display the CH LOCK menu.
3. Press the Channel Number buttons to enter the channel you want to lock. (The channel you are currently watching cannot be locked.)
4. Press ENTER.

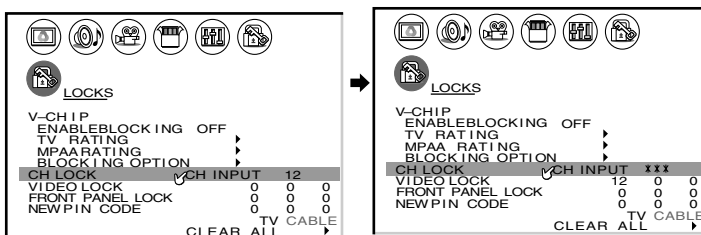

5. Repeat steps 3 and 4 for other channels.

### LOCKS menu

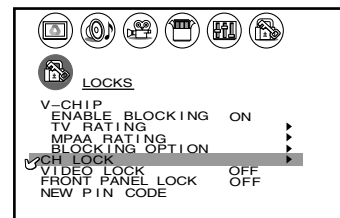

To select each item:

Press  $\blacktriangledown$  or  $\blacktriangle$ .

To unlock channels:

1. From the LOCKS menu, select CH LOCK.
2. Press ◀ or ▶ to display the CH LOCK menu.
3. Press ▲▼◀▶ to highlight the channel you want to unlock, then press ENTER.

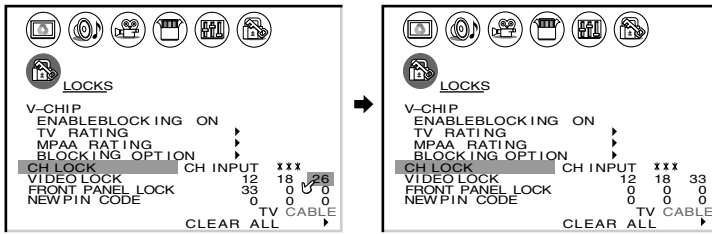

4. Repeat step 3 for other channels.

To clear all locked channels at once:

1. Press ▲ or ▼ to highlight CLEAR ALL, and then press ▶ or ◀.

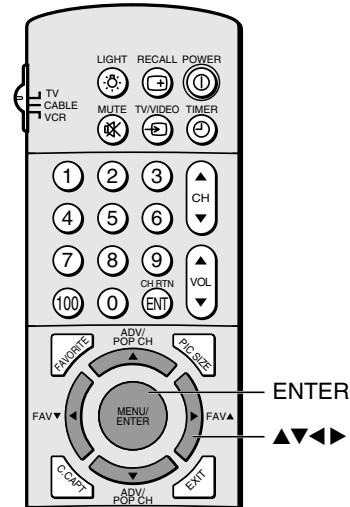
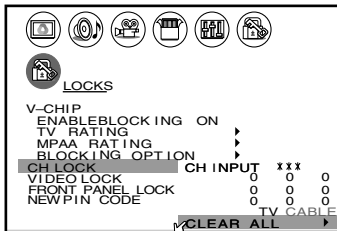

## Locking video inputs

With the VIDEO LOCK feature, you can lock out the input sources (Video 1, Video 2, Video 3, ColorStream HD1, ColorStream HD2) and channels 3 and 4.

You will not be able to select the input sources with the TV/VIDEO button or Channel buttons unless you clear the setting.

To set up the video lock:

1. From the LOCKS menu, select VIDEO LOCK.
2. Press ◀ or ▶ to highlight the level of video locking you want (Video, Video+, or Off), as follows:
  - VIDEO : Locks Video 1, Video 2, Video 3, ColorStream HD1 and HD2.
  - VIDEO+ : Locks Video 1, Video 2, Video 3, ColorStream, HD1/HD2, and channels 3 and 4. This option should be used if you use the antenna terminal to play a video tape.
  - Note:** Make sure the POP is not on channel 3 or 4.
  - OFF : Unlocks all video input sources.

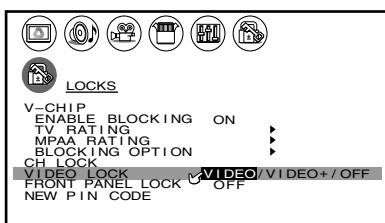

## Using the front panel lock feature

Lock the front panel buttons to prevent the buttons from being pressed accidentally (by children, for example). When the front panel lock is in ON mode, all control buttons on the TV front panel (except POWER) do not operate.

To lock the front panel:

1. From the LOCKS menu, select FRONT PANEL LOCK.
2. Press ◀ or ▶ to highlight ON.

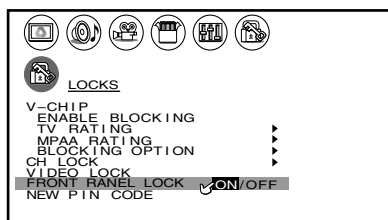

If a button on the front panel is pressed, the message “Not Available” appears.

To unlock the front panel:

Highlight OFF in step 2 above.

## Changing the PIN code

1. From the LOCKS menu, select NEW PIN CODE.
2. Press the Number buttons (0-9) to enter a 4-digit code. The numbers you enter will replace the dashes in the display.

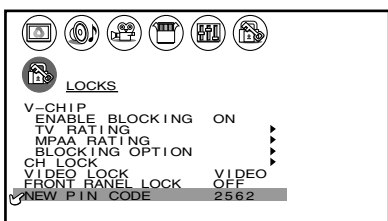

3. Press ENTER. The new PIN code is now active.

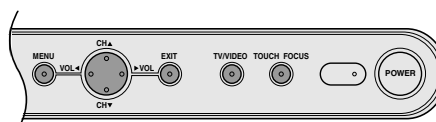

Buttons to be locked

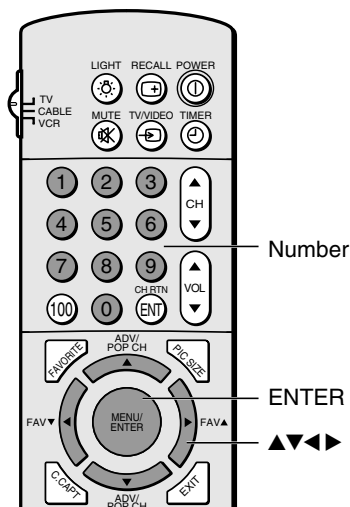

## Adjusting the picture

### Selecting the picture mode

Select the desired picture type from four picture modes: Sports, Standard, Movie, and Preference.

Mode	Picture Quality
Sports	Bright and dynamic picture (factory setting)
Standard	Standard picture setting (factory setting)
Movie	Movie-like picture setting (factory setting)
Preference	Your personal preference*

\*(see “Saving new preference” on page 38.)

To select the picture mode:

1. Press MENU, and then press ◀ or ▶ until the PICTURE menu appears.
2. Press ▼ or ▲ to select MODE.
3. Press ◀ or ▶ to highlight the mode you prefer.

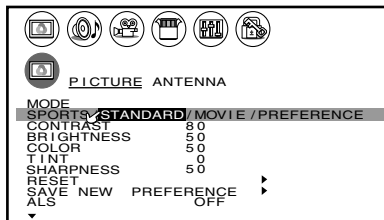

### Adjusting the picture quality

You can adjust the picture quality to your personal preferences, including the contrast, brightness, color, tint, sharpness, flesh tone, noise reduction and color temperature.

Selection	◀ Pressing ▶	
contrast	lower	higher
brightness	darker	lighter
color	paler	deeper
tint	reddish	greenish
sharpness	softer	sharper

To adjust the picture quality:

1. Press MENU, and then press ◀ or ▶ until the PICTURE menu appears.
2. Press ▼ or ▲ until the item you want to adjust is highlighted.
3. Press ◀ or ▶ to adjust the level.

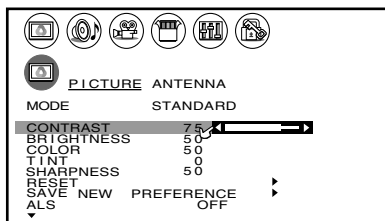

The PICTURE qualities you adjusted can be saved in the TV's memory with the SAVE NEW PREFERENCE feature (see page 38). You can keep these settings or choose factory set options, as described under “Selecting the picture mode” above.

#### Note:

If you select one of the factory-set picture modes (SPORTS, STANDARDS, or MOVIE) and then change a picture quality setting (for example, increase the contrast), the picture mode automatically changes to PREFERENCE in the Picture menu.

To save your new picture quality settings, you must select SAVE NEW PREFERENCE (see page 38) before closing the Picture menu or the TV will return to the previous picture mode.

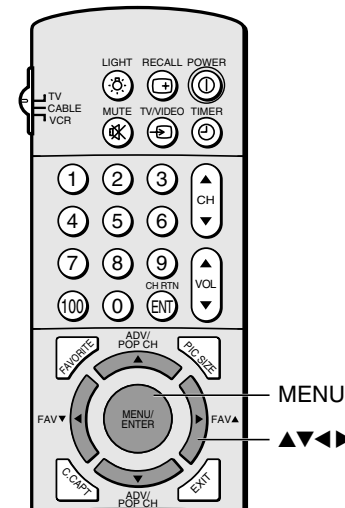
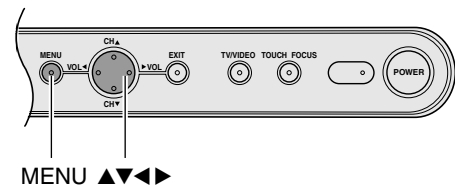

## Saving new preference

You can save the PICTURE qualities (contrast, brightness, color, tint, and sharpness) you adjusted in the picture preference mode.

To save your new preferences:

1. Press MENU, and then press ◀ or ▶ until the PICTURE menu appears.
2. Press ▲ or ▼ to highlight SAVE NEW PREFERENCE.
3. Press ◀ or ▶. When complete, the menu displays “DONE.”

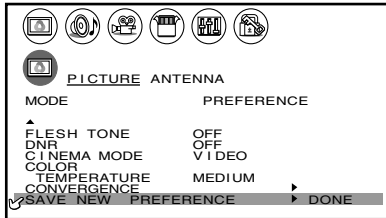

The mode automatically changes to PREFERENCE (see “Selecting the picture mode” on page 37).

## Using the ALS (Automatic Light Sensor) feature

ALS senses the room ambient light and automatically adjusts the picture contrast for varying light conditions. For example, when the room is dark, the ALS will automatically reduce the contrast (which reduces eye strain). ALS is energized when the ALS menu is set to ON.

To activate the ALS:

1. Press MENU, and then press ◀ or ▶ until the PICTURE menu appears.
2. Press ▲ or ▼ to highlight ALS.
3. Press ◀ or ▶ to highlight ON. The CONTRAST setting changes to AUTO, and is not adjustable while the ALS feature is on.

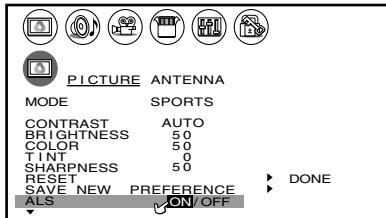

To deactivate the ALS:

Highlight OFF in step 3 above.

## Using the flesh tone feature

This feature displays natural flesh tones by correcting the tint.

To turn on the flesh tone feature:

1. Press MENU, and then press ◀ or ▶ until the PICTURE menu appears.
2. Press ▲ or ▼ to highlight FLESH TONE.
3. Press ◀ or ▶ to highlight ON.

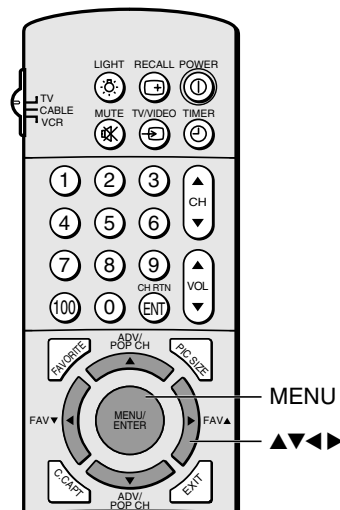
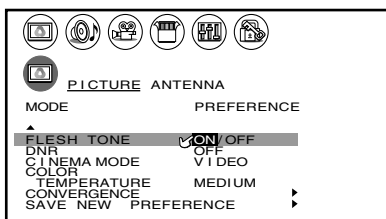

### Note:

Do not cover the ALS sensor on the front panel of the TV.

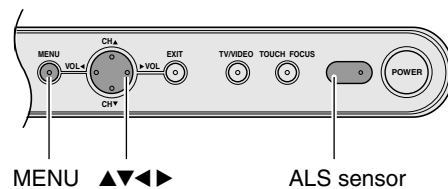

## Selecting the cinema mode

When you view a DVD movie (3-2 pulldown processed) from a DVD player connected to the ColorStream (component video) inputs on the TV, smoother and more natural motion can be obtained by setting the CINEMA MODE to FILM (auto).

To set the CINEMA MODE to FILM (auto):

1. Press MENU, and then press ◀ or ▶ until the PICTURE menu appears.
2. Press ▲ or ▼ to highlight CINEMA MODE.
3. Press ◀ or ▶ to select FILM.

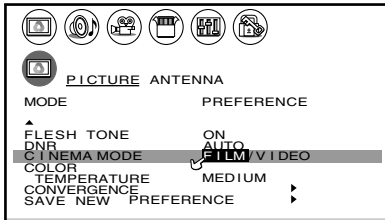

To set the CINEMA MODE to VIDEO (off):

Press ◀ or ▶ to select VIDEO in step 3 above.

## Using the Digital Noise Reduction (DNR) feature

This feature allows you to reduce visible interference in your TV picture. This is useful when receiving a broadcast with a weak signal or playing back a video cassette or disc damaged by repeated use.

To turn on the DNR feature:

1. Press MENU, and then press ◀ or ▶ until the PICTURE menu appears.
2. Press ▲ or ▼ to highlight DNR.
3. Press ◀ or ▶ to highlight AUTO.

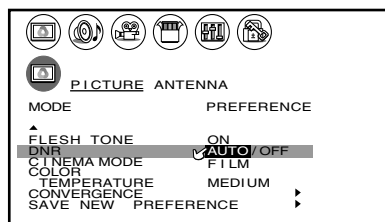

To turn off the DNR feature:

Highlight OFF in step 3 above.

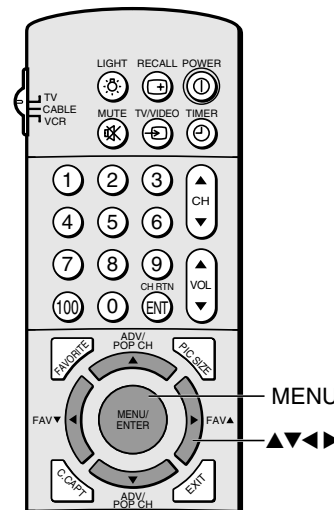

## Selecting the color temperature

You can change the quality of the picture by selecting from three preset color temperatures: cool, medium, and warm.

Mode	Picture Quality
cool	blueish
medium	neutral
warm	reddish

To select the color temperature:

1. Press MENU, and then press ◀ or ▶ until the PICTURE menu appears.
2. Press ▲ or ▼ to highlight COLOR TEMPERATURE.
3. Press ◀ or ▶ to highlight the mode you prefer.

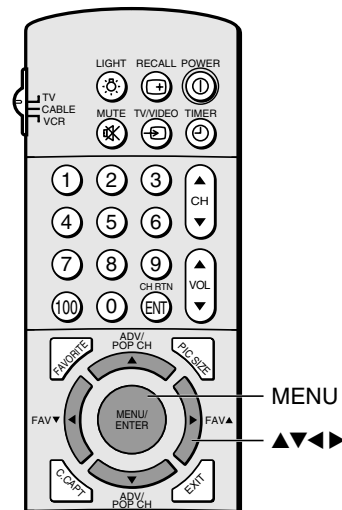
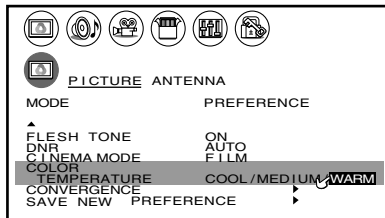

## Resetting picture adjustments

The RESET function adjusts the picture qualities to the following factory settings:

Contrast .....	max (100)	Color temperature .....	cool
Brightness .....	center (50)	DNR .....	auto
Color .....	center (50)	Mode .....	sports
Tint .....	center (0)		
Sharpness .....	center (50)		

To reset the picture adjustments:

1. Press MENU, and then press ◀ or ▶ until the PICTURE menu appears.
2. Press ▲ or ▼ to highlight RESET.
3. Press ◀ or ▶. The menu displays “DONE.”

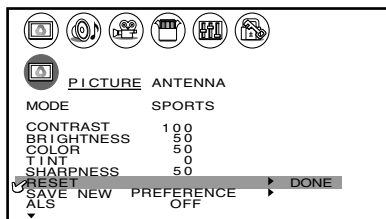



## Selecting the video input source

Press the TV/VIDEO button on the remote control or TV to view a signal coming from another device connected to your TV, such as a VCR or video disc player (see illustrations below). You can select ANT 1, VIDEO 1, VIDEO 2, VIDEO 3, ColorStream HD1, ColorStream HD2, or ANT 2, depending on which input jacks are used for connecting the devices (see “Connecting your TV” on page 5).

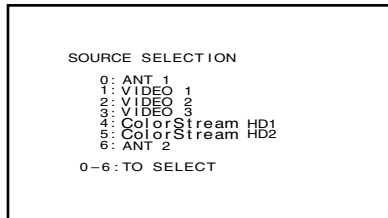

Pressing TV/VIDEO on the remote control displays the current signal source (press TV/VIDEO again or 0-6 to change)

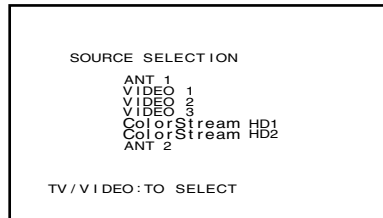

Pressing TV/VIDEO on the TV changes the current signal source

### Note:

- When ColorStream HD 1 or HD 2 is selected, the video OUT jack does not output a signal. To receive a video OUT signal, use a video or S-video IN connection instead of a ColorStream connection.
- If you select ColorStream HD1 or HD2 while the POP picture is active, the POP window will close.

## Labeling the video input sources

The video label feature allows you to label each input source for your TV from the following preset list of labels:

- : Uses the default label name
- VCR : Video cassette recorder
- DVD : DVD video
- DTV : Digital TV set-top box
- SAT : Satellite box
- CBL : Cable box

To label the video input sources:

- Press MENU, and then press ◀ or ▶ until the CUSTOM menu appears.
- Press ▲ or ▼ to highlight VIDEO LABEL.

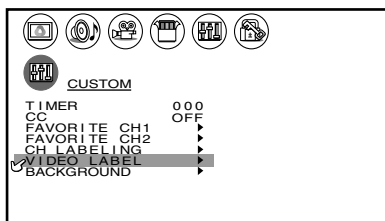

- Press ◀ or ▶ to display the VIDEO LABEL menu.
- Press ▲ or ▼ to highlight the video source you want to label.
- Press ◀ or ▶ to select the desired label for that input source.

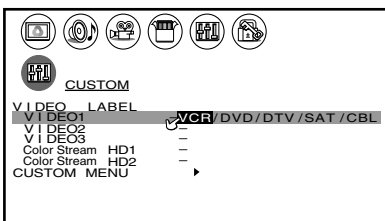

- Finish labeling the other video sources as desired. To return to the previous menu, press ▲ or ▼ to highlight CUSTOM MENU, and then press ◀ or ▶.
- To exit the menu, press EXIT.

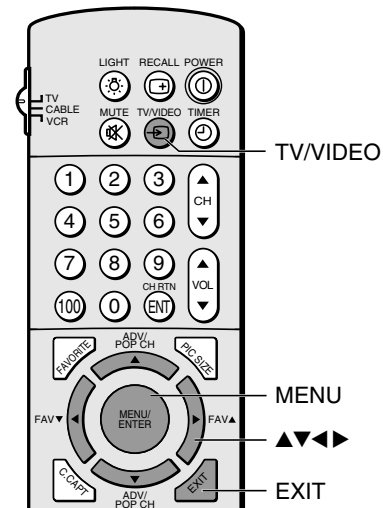
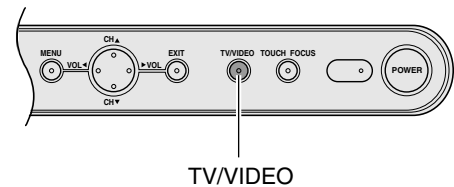

## Using the closed caption feature

The closed caption feature has two options:

- Captions—An on-screen display of the dialogue, narration, and sound effects of TV programs and videos that are closed captioned (usually marked as “CC” in TV listings).
- Text—An on-screen display of information not related to the current program, such as weather or stock data (when provided by individual stations).

To view captions or text:

1. Tune the TV to the desired program.
2. Press C.CAPT to select a closed caption mode (C1 through C4, T1 through T4, or OFF).

**Note:** Every time C.CAPT is pressed, the closed caption mode will change.

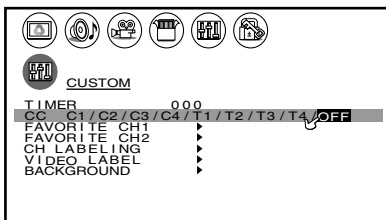

- To view captions, highlight C1, C2, C3, or C4 (C1 displays translation of the primary language in your area).

**Note:** If the program or video you selected is not closed captioned, no captions will display on the screen.



- To view text, highlight T1, T2, T3, or T4.

**Note:** If text is not available in your area, a black rectangle may appear on your screen. If this happens, turn the Closed Caption feature OFF.

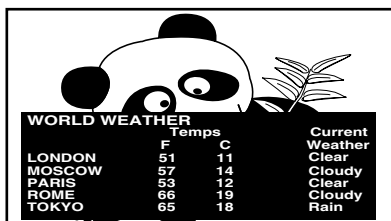

- To turn off the Closed Caption feature: Highlight OFF in step 3.

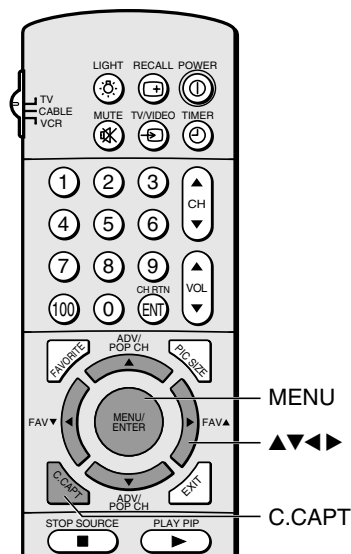

**Note:**

A closed caption signal may not display in the following situations:

- when a videotape has been dubbed
- when the signal reception is weak
- when the signal reception is nonstandard

## Setting the sleep timer

To set the sleep timer to turn the TV off automatically:

1. Press TIMER to set the length of time until the TV turns off.



Every time you press the button, the time display will increase by 10 minutes, up to 180 minutes.

10 → 20 → 30 → 40 → 50 → 60 → 70 → 80 → 90 → 100 → 110 → 120 → 130 → 140 → 150 → 160 → 170 → 180 → 0 → 10 MIN.

To cancel the sleep timer:

Press TIMER until it is set to 0.

The timer can also be set using the on-screen menu:

1. Press MENU, and then press ◀ or ▶ until the SETUP menu appears.
2. Press ▲ or ▼ to highlight TIMER.
3. After the number position starts to blink, press the Channel Number buttons (0-9) to enter the length of time until the TV turns off automatically.
4. Press ENTER to start the timer.

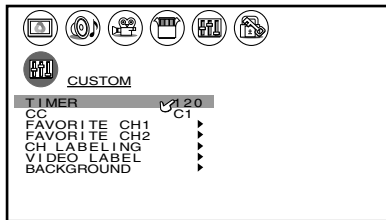

## Setting the clock

To set the clock:

1. Press MENU, and then press ◀ or ▶ until the SET UP menu appears.
2. Press ▲ or ▼ to highlight CLOCK SET.
3. After the number position starts to blink, press the Channel Number buttons (0-9) to enter the correct time. The clock operates on a 12-hour cycle.
4. Press ENTER to start the clock.

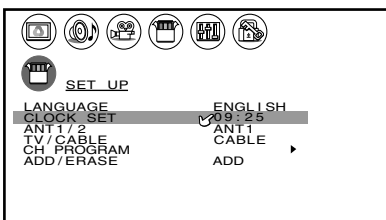

To display the time on-screen:

Press RECALL.

### Note :

To display the amount of time left until the TV turns off automatically, press TIMER once.

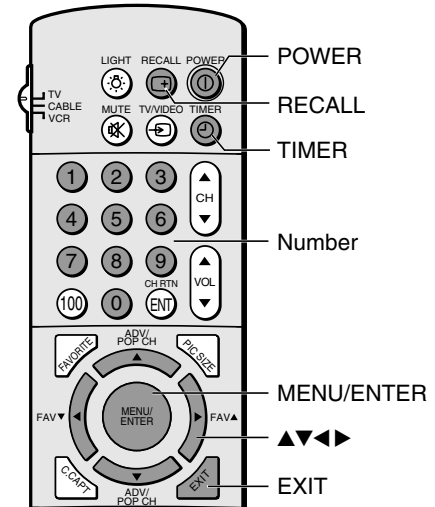

## Adjusting the sound

### Muting the sound

Press MUTE to temporarily turn off the sound. While the sound is off, the screen will display the word “1/2 MUTE” or “MUTE” in the lower right corner. Every time you press the button, the mute mode will change in the following order.

→ Normal → 1/2 MUTE → MUTE →

When you select “MUTE” mode, the closed caption feature is automatically activated. To deactivate this feature, press MUTE again. This feature works only when the closed caption mode is set to OFF. See “Using the closed caption feature” on page 42 for more information.

### Selecting stereo/SAP broadcasts

The multi-channel TV sound (MTS) feature allows you to listen to high-fidelity stereo sound while watching TV. MTS can also transmit a second audio program (SAP) containing a second language, music, or other audio information (when provided by individual stations).

When the TV receives a stereo or SAP broadcast, the word STEREO or SAP appears on-screen every time the TV is turned on, the channel is changed, or the RECALL button is pressed.

The MTS feature is not available when the TV is in VIDEO mode.

To listen to stereo sound:

1. Press MENU, and then press ◀ or ▶ until the AUDIO menu appears.
2. Press ▲ or ▼ to highlight MTS.
3. Press ◀ or ▶ to highlight STEREO.

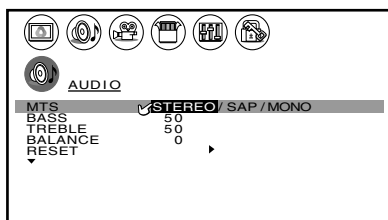

You can leave your TV in STEREO mode because it will automatically output the type of sound being broadcast (stereo or monaural). The word “STEREO” or “SAP” displays in yellow in the menu when the TV receives the signal.

If the stereo sound is noisy, select MONO to reduce the noise.

To listen to SAP (if available):

1. Press MENU, and then press ◀ or ▶ until the AUDIO menu appears.
2. Press ▲ or ▼ to highlight MTS.
3. Press ◀ or ▶ to highlight SAP. You will hear the station's second audio program (if available) from the speakers, while viewing the original program's picture (see note at right).

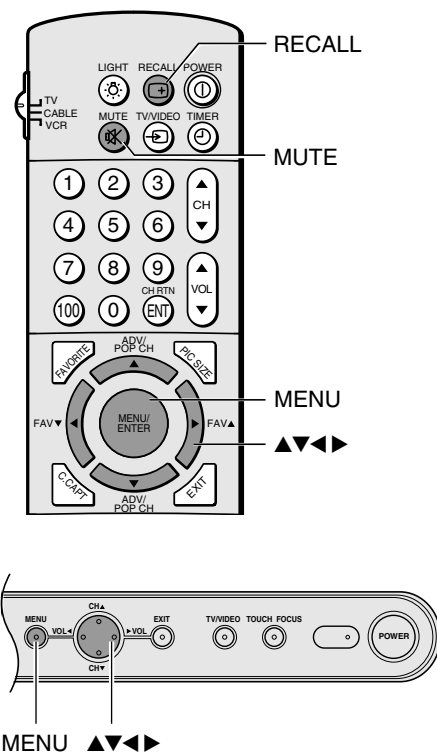

#### Note :

A second audio program (SAP) can be heard only on those TV stations that offer it.

For example, a station might broadcast music as a second audio program. If you have SAP on, you will see the current program on the screen but hear music instead of the program's normal audio.

However, if you have SAP on, and the station you are watching is not currently broadcasting a second audio program, you will see the picture but not hear any sound. If this happens, put the TV in STEREO mode so you can hear the station's normal audio.

## Using the SRS 3D surround sound feature

The SRS 3D surround sound feature expands the audio listening field wider and deeper to create exceptional sound quality from the TV's speakers. The feature uses stereo signals from a TV broadcast or video input.

To turn on the SRS 3D surround:

1. Select STEREO mode (see "Selecting stereo/SAP broadcasts" on page 44).
2. Press MENU, and then press ◀ or ▶ until the THEATER menu appears.
3. Press ▲ or ▼ to highlight SRS 3D.
4. Press ◀ or ▶ to highlight ON.

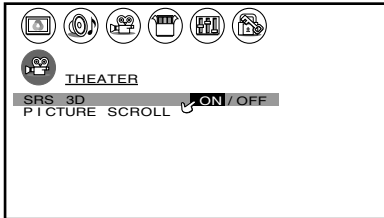

To turn off the SRS 3D surround:

Highlight OFF in step 4 above.

In general, you can leave your TV in ON mode because it will automatically produce the type of sound being broadcast (surround stereo or monaural).

## Adjusting the sound quality

You can change the quality of your TV's sound by adjusting the bass, treble, and balance.

To adjust the sound quality:

1. Press MENU, and then press ◀ or ▶ until the AUDIO menu appears.
2. Press ▲ or ▼ to highlight the item to adjust.

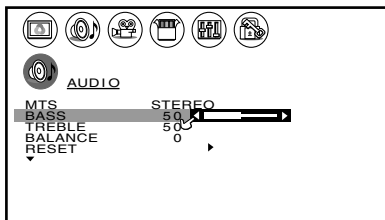

3. Press ◀ or ▶ to adjust the level.
  - ◀ makes the sound quality weaker or decreases the balance in the right channel, depending on the item selected.
  - ▶ makes the sound quality stronger or decreases the balance in the left channel, depending on the item selected.

### Note:

When the SRS 3D surround sound feature is selected, the StableSound™ feature is automatically turned off (see page 48).

If the broadcast is monaural, the SRS 3D effect does not work.

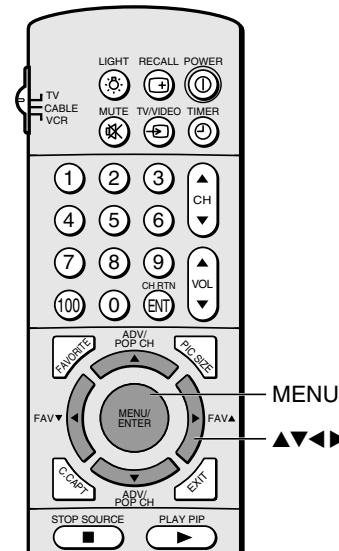

## Resetting audio adjustments

The RESET function returns the audio adjustments to the following factory settings:

- Bass ..... center (50)
- Treble ..... center (50)
- Balance ..... center (0)

To reset the audio adjustments:

1. Press MENU, and then press ◀ or ▶ until the AUDIO menu appears.
2. Press ▲ or ▼ to highlight RESET.
3. Press ◀ or ▶. The menu displays “DONE.”

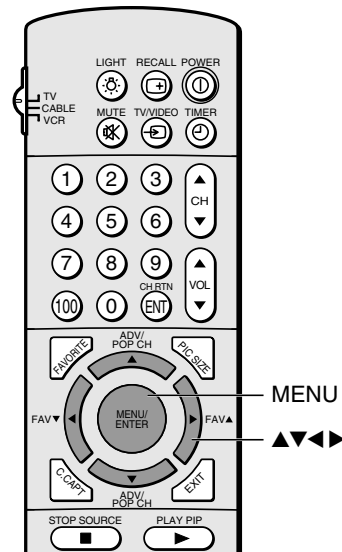
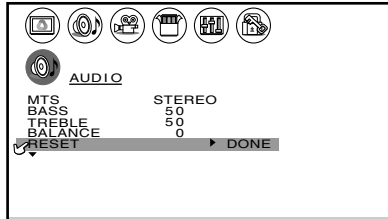

## Using the sub-bass system (SBS)

The sub-bass system allows you to enhance bass performance, even when the volume is low.

To turn on the SBS:

1. Press MENU, and then press ◀ or ▶ until the AUDIO menu appears.
2. Press ▲ or ▼ to highlight SBS.
3. Press ◀ or ▶ to highlight ON.

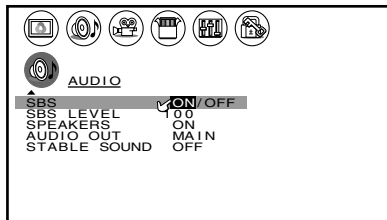

To adjust the SBS level:

4. Press ▲ or ▼ to highlight SBS LEVEL.
5. Press ◀ or ▶ to adjust the SBS level.

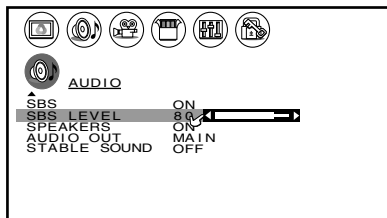

To turn off the SBS:

Highlight OFF in step 3 above.

### Note:

- The SBS signal does not pass through the “Variable Audio OUT” jacks (see “Connecting an audio system” on page 11); however, the AUDIO menu will appear when the buttons are pressed.

## Turning off the built-in speakers

Use this feature to turn the TV speakers off when you connect an audio system (see “Connecting an audio system” on page 11).

To turn off the built-in speakers:

1. Press MENU, then press ◀ or ▶ until AUDIO menu appears.
2. Press ▲ or ▼ to highlight SPEAKERS.
3. Press ◀ or ▶ to highlight OFF.

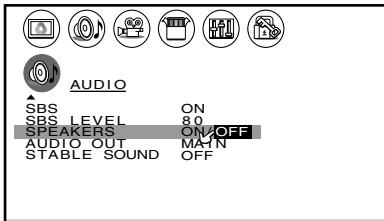

To turn on the built-in speakers:

Highlight ON in step 3 above.

## Selecting the Audio OUT sound

This feature allows you to select the sound source (MAIN or POP) that is output from the Audio OUT jacks.

This is useful when amplifying or recording the POP sound with external equipment while hearing the sound of the main picture through the built-in speakers.

To select the Audio OUT sound:

1. Press MENU, and then press ◀ or ▶ until the AUDIO menu appears.
2. Press ▲ or ▼ to highlight AUDIO OUT.
3. Press ◀ or ▶ to select MAIN or POP.

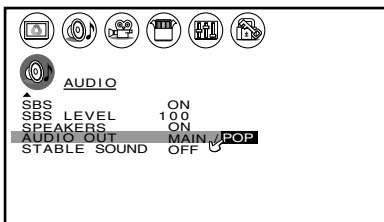

- MAIN: Outputs the sound of the main program.
- POP : Outputs the sound of the POP program.

### Note:

Make sure the volume control of your audio amplifier is set to a moderate listening level.

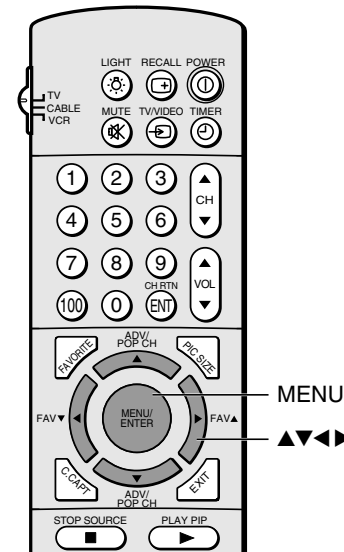

## Using the StableSound™ feature

When the signal source is changed, the StableSound feature limits the high volume level to prevent extreme changes in volume (for example, to prevent the sudden increase in volume that often happens when a TV program switches to a commercial).

To turn on the StableSound feature:

1. Press MENU, and then press ◀ or ▶ until the AUDIO menu appears.
2. Press ▲ or ▼ to highlight STABLE SOUND.
3. Press ◀ or ▶ to select ON.

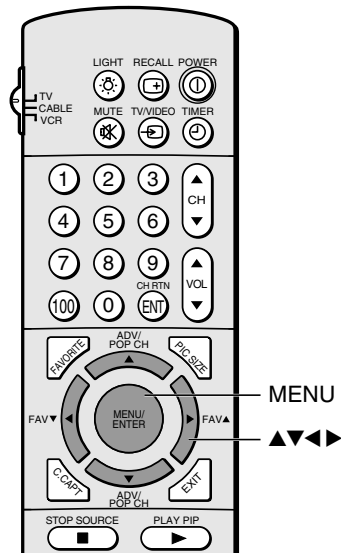
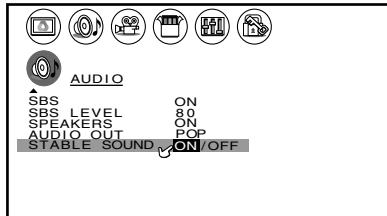

## Selecting the background of the menu display

You can change the background of the menu display by selecting from two preset types: shaded and solid (gray).

To select the background:

1. Press MENU, and then press ◀ or ▶ until the CUSTOM menu appears.
2. Press ▲ or ▼ to highlight BACKGROUND.
3. Press ◀ or ▶ to select either a SHADED or SOLID background.

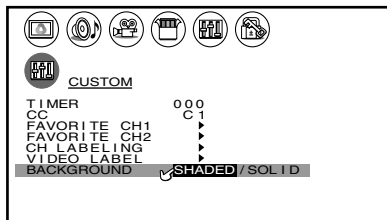

### Note:

When the StableSound feature is turned on, the SRS 3D surround sound feature is automatically turned off (see page 45).

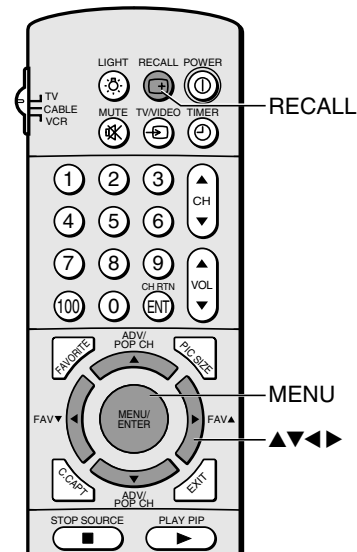

## Displaying on-screen information

Press RECALL to display the following information on-screen:

- Antenna mode (when in TV mode)
- Channel number or VIDEO mode selected
- Time (if set)
- Channel label (if set)
- Stereo or SAP audio status
- V-CHIP rating status
- Picture size

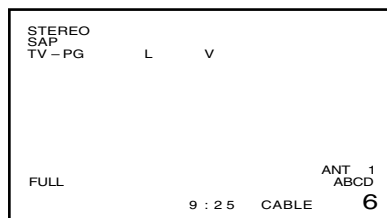



## Viewing the demonstration mode

The demonstration mode is an option available in the MENU button on the TV front panel that will demonstrate several of your TV's features.

To start the demo:

Press and hold the MENU button on the TV front panel for 4 seconds.

To stop the demo:

Press RECALL, EXIT, or POWER.

## Understanding the auto power off feature

The TV will automatically turn itself off after approximately 15 minutes if it is tuned to a vacant channel or a station that completes its broadcast for the day. This feature does not work in VIDEO mode.

## Understanding the last mode memory feature

If the power is cut off while you are viewing the TV, the Last Mode Memory feature turns the TV on automatically when the power is resupplied.

If the power is going to be off for a long time and you are going to be away from the TV, unplug the power cord to prevent the TV from turning on in your absence.

# Appendix

## Specifications

### Television System

NTSC standard

### Channel Coverage

VHF: 2 through 13

UHF: 14 through 69

Cable TV: Mid band (A-8 through A-1, A through I)

Super band (J through W)

Hyper band (AA through ZZ, AAA, BBB)

Ultra band (65 through 94, 100 through 125)

### Power Source

120 V AC, 60 Hz

### Power Consumption

42H81: 192 W (average)

50H81: 189 W (average)

57H81: 189 W (average)

65H81: 189 W (average)

### Audio Power

15 W + 15 W

### Speaker Type

42H81: Two 4-3/4 inches (12 cm) round

50H81: Two 6-5/16 inches (16 cm) round

57H81: Two 6-5/16 inches (16 cm) round

65H81: Two 6-5/16 inches (16 cm) round

### Video/Audio Terminals

#### S-VIDEO INPUT

Y : 1 V(p-p), 75 ohm, negative sync.

C : 0.286 V(p-p) (burst signal), 75 ohm

#### VIDEO/AUDIO INPUT

VIDEO: 1 V(p-p), 75 ohm, negative sync.

AUDIO: 150 mV(rms) (30% modulation equivalent, 47 kohm)

#### ColorStream™ (component video) INPUT

Y : 1V(p-p), 75 ohm

PR: 0.7 V(p-p), 75 ohm

PB: 0.7 V(p-p), 75 ohm

AUDIO: 150 mV(rms), 47 kohm

#### VIDEO/AUDIO OUTPUT

VIDEO: 1 V(p-p), 75 ohm, negative sync.

AUDIO: 150 mV(rms) (30% modulation equivalent, 4.7 kohm)

#### VARIABLE AUDIO OUTPUT

0–300 mV(rms) (30% modulation equivalent, 4.7 kohm)

#### AUDIO CENTER CHANNEL INPUT

300 mV(rms) (30% modulation equivalent, 10 kohm)

### Dimensions

42H81: Width 39-5/16 inches (998 mm)

Height 46-9/16 inches (1183 mm)

Depth 18-1/8 inches (460 mm)

50H81: Width 46-3/16 inches (1173 mm)

Height 50-3/8 inches (1280 mm)

Depth 21-7/8 inches (556 mm)

57H81: Width 52-3/16 inches (1325 mm)

Height 55-3/4 inches (1416 mm)

Depth 23-5/8 inches (600 mm)

65H81: Width 60-7/8 inches (1540 mm)

Height 59-5/16 inches (1510 mm)

Depth 26 inches (660 mm)

### Mass

42H81: 130 lbs (60 kg)

50H81: 240 lbs (109 kg)

57H81: 254 lbs (115 kg)

65H81: 260 lbs (120 kg)

### Supplied Accessories

Remote Control with 2 size “AA” alkaline batteries

Design and specifications are subject to change without notice.

## Troubleshooting

Before calling a service technician, please check the following table for a possible cause of the problem and some solutions.

<b>Problem</b>	<b>Solution</b>
TV will not turn on	<ul style="list-style-type: none"> <li>• Make sure the power cord is plugged in, and then press POWER.</li> <li>• The remote control batteries may be dead. Replace the batteries.</li> </ul>
No picture, no sound	<ul style="list-style-type: none"> <li>• Check the antenna/cable connections.</li> </ul>
No sound, picture OK	<ul style="list-style-type: none"> <li>• The sound may be muted. Press VOLUME.</li> <li>• The station may have broadcast difficulties. Try another channel.</li> <li>• Check that the SPEAKERS function in AUDIO menu is set properly.</li> </ul>
Poor picture, sound OK	<ul style="list-style-type: none"> <li>• Check the antenna connections.</li> <li>• The station may have broadcast difficulties. Try another channel.</li> <li>• Adjust the PICTURE menu.</li> </ul>
Poor reception of broadcast channels	<ul style="list-style-type: none"> <li>• The station may have broadcast difficulties. Try another channel.</li> <li>• Check the antenna connections.</li> <li>• If you are using a VCR, make sure the TV/VCR button is set correctly.</li> </ul>
Cannot receive above channel 13	<ul style="list-style-type: none"> <li>• Make sure the TV/CABLE switch is set to the mode that corresponds with the signal source type (cable company or outside antenna).</li> </ul>
Black box appears on the screen	<ul style="list-style-type: none"> <li>• The closed caption feature may be set to one of the Text modes (T1, T2, T3, or T4). Turn closed captioning OFF.</li> </ul>
Unable to select a certain channel	<ul style="list-style-type: none"> <li>• The channel may be locked out with the CH LOCK feature, or erased with the ADD/ERASE feature.</li> </ul>
Multiple images	<ul style="list-style-type: none"> <li>• The station may have broadcast difficulties. Try another channel.</li> <li>• Antenna reception may be poor. Use a highly directional outdoor antenna.</li> </ul>
Poor color or no color	<ul style="list-style-type: none"> <li>• The station may have broadcast difficulties. Try another channel.</li> <li>• Adjust the TINT and/or COLOR in the PICTURE menu.</li> </ul>
No stereo or SAP sound from a known MTS broadcast	<ul style="list-style-type: none"> <li>• Make sure the MTS feature is set properly.</li> </ul>
The front panel buttons do not operate	<ul style="list-style-type: none"> <li>• Check the FRONT PANEL LOCK feature.</li> </ul>
The remote control does not operate	<ul style="list-style-type: none"> <li>• Make sure the TV/CABLE/VCR switch is set properly.</li> <li>• Remove all obstructions between the remote control and the remote control sensor in the TV.</li> <li>• The remote control batteries may be dead. Replace the batteries.</li> </ul>
Cannot access signal input sources (Video1, Video2, Video3, ColorStream HD1/HD2) and/or Channels 3 and 4.	<ul style="list-style-type: none"> <li>• Check the VIDEO LOCK feature.</li> </ul>

## Limited United States Warranty

Toshiba America Consumer Products, Inc. ("TACP") and Toshiba Hawaii Inc. ("THI") make the following limited warranties. These limited warranties extend to the original consumer purchaser or any person receiving this set as a gift from the original consumer purchaser and to no other purchaser or transferee.

### Limited One (1) Year Warranty

TACP and THI warrant this product and its parts against defects in materials or workmanship for a period of one (1) year after the date of original retail purchase. During this period, TACP and THI will repair or replace a defective part, at their option, with a new or refurbished part, without charge to you. TACP/THI Authorized Service Station personnel will come to your home when warranty service is required. Depending on the type of repair required, the service will either be performed in your home or the set will be taken to the TACP/THI authorized service station for repair and returned to your home at no cost to you.

### Limited Two (2) Year Warranty of Picture Tube

TACP and THI further warrant the picture tube in this product against defects in materials or workmanship for a period of two (2) years after the date of original retail purchase. During this period, TACP and THI will repair or replace a defective picture tube at their option, with a new or refurbished picture tube, without charge to you, except that if a defective picture tube is replaced after one (1) year from the date of the original retail purchase, you pay labor charges involved in the replacement.

### Rental Units

The warranty for rental units begins with the first rental or thirty (30) days from the date of shipment to the rental firm, whichever comes first.

### Commercial Units

Products sold and used for commercial use have a limited ninety (90) day warranty for all parts, labor and picture tube.

### Owner's Manual and Demographic Card

You should read this owner's manual thoroughly before operating this product. You should complete and mail the enclosed Demographic card within ten days after you, or the person who has given you this product as a gift, purchased this product. This is one way to enable TACP/THI to provide you with better customer service and improved products. Failure to return the Demographic card will not affect your rights under this warranty.

### Your Responsibility

The above warranties are subject to the following conditions;

- (1) You must retain your bill of sale or provide other proof of purchase.
- (2) All warranty servicing of this product must be made by an Authorized TACP/THI Service Station.
- (3) These warranties are effective only if the product is purchased and operated in the U.S.A. or Puerto Rico.
- (4) Labor service charges for set installation, set up, adjustment of customer controls and installation or repair of antenna systems are not covered by this warranty. Reception problems caused by inadequate antenna systems are your responsibility.
- (5) Warranties extend only to defects in materials or workmanship as limited above and do not extend to any product or parts which have been lost or discarded by you or to damage to products or parts caused by misuse, accident, damage caused by Acts of God, such as lightning or fluctuations in electric power, improper installation, improper maintenance or use in violation of instructions furnished by us; or to units which have been modified or had the serial number removed, altered, defaced or rendered illegible.

## How to Obtain Warranty Service

If after following all of the operating instructions in this manual and checking the "Troubleshooting" section, you find that service is needed:

- (1) Call the TACP toll-free number 1-800-631-3811 to find the nearest TOSHIBA Authorized Service Station. In Hawaii, contact Toshiba Hawaii, Inc. 327 Kamakee Street, Honolulu, Hawaii 96814 (808) 591-9281
- (2) Present your bill of sale or other proof to the Authorized Service Station. "Authorized TACP/THI service station personnel will come to your home when warranty service is required. Depending on the type of repair required, the service will either be performed in your home or the set will be taken to the TACP/THI Authorized service station for repair and returned to your home at no cost to you."

**For additional information,  
visit our web site:  
[www.toshiba.com](http://www.toshiba.com)**

All warranties implied by state law, including the implied warranties of merchantability and fitness for a particular purpose, are expressly limited to the duration of the limited warranties set forth above. With the exception of any warranties implied by state law as hereby limited, the foregoing warranty is exclusive and in lieu of all other warranties, guarantees, agreements and similar obligations of manufacturer or seller with respect to the repair or replacement of any parts. In no event shall TACP or THI be liable for consequential or incidental damages.

No person, agent, distributor, dealer or company is authorized to change, modify or extend the terms of these warranties in any manner whatsoever. The time within which action must be commenced to enforce any obligation of TACP or THI arising under this warranty or under any state, or law of the United States or any state thereof, is hereby limited to 90 days from the date you discover or should have discovered, the defect. This limitation does not apply to implied warranties arising under state law.

This warranty gives you specific legal rights and you may also have other rights which may vary from state to state. Some states do not allow limitation on how long an implied warranty lasts, when an action may be brought, or the exclusion or limitation of incidental or consequential damages, so the above provisions may not apply to you.



### ATTENTION CANADIAN CONSUMERS:

Canadian consumers are requested to complete the special Canadian "Warranty Registration Form" enclosed, and forward this completed form with a copy of bill of sale to TOSHIBA OF CANADA to "Register and Validate" their warranty.

Products purchased in the U.S.A. and used in Canada are not covered by these warranties.

Products Purchased in Canada and used in the U.S.A. are not covered by these warranties.

REV. 09-01

# Index

## A

A/V receiver connection .....	11
ANT 1/2 .....	18
Antenna cables .....	5
Audio cables .....	5
AUDIO OUT sound, selecting .....	47
Audio system connection .....	11
Auto convergence .....	21
Auto power off .....	49
Automatic light sensor (ALS) .....	38

## B

BACKGROUND selection .....	48
Back of the TV .....	4

## C

Cable converter box connection .....	6
Camcorder connection .....	10
CH ▲▼ buttons .....	20
Channel surf mode .....	20
CH LABEL .....	24
CH LOCK .....	34
CH RTN button .....	23
Channel Number buttons .....	20
Channel programming	
ADD/ERASE .....	20
Automatic programming .....	19
TV/CABLE selection .....	19
Cinema mode .....	39
Clock, setting .....	43
Closed caption .....	42
Color temperature .....	40
ColorStream cables .....	5
Convergence adjustment .....	21

## D

Demonstration mode .....	49
Double-window (“POP”) feature .....	29
DNR (Digital Noise Reduction) .....	39
DTV receiver connection .....	9
DVD connection .....	7, 8

## F

FAV ▼▲ buttons .....	23
FAVORITE button .....	30
Favorite channels .....	23
Front of the TV .....	4
Front panel lock .....	36

## L M

Labeling channels .....	24
Labeling video inputs .....	41
Language selection .....	18
Last mode memory .....	49
Locking channels .....	34
Locking video inputs .....	35
Locks menu .....	31
Menu system .....	17
MTS feature .....	44
MUTE button .....	44

## P

Picture adjustments	
COLOR TEMPERATURE .....	40
FLESH TONE .....	38
Picture mode .....	37
Picture quality .....	37
Picture-out-picture (POP)	
POP button .....	29
POP CH ▲▼ buttons .....	29
SOURCE button .....	29
STILL button .....	30
SWAP button .....	30
Picture scroll .....	28
Picture size selection .....	26
POP (also see “Picture-out-picture”) .....	29

## R

RECALL button .....	48
Remote control	
Battery installation .....	12
Learning about the buttons .....	16
Programming .....	13
RESET .....	40, 46

## S

SAP sound .....	44
Satellite receiver connection .....	7
Scrolling the Theater Wide picture .....	28
Set-top box connection .....	9
Sleep timer .....	43
Sound quality adjustments .....	45
SPEAKERS on/off .....	47
Specifications .....	50
SRS 3D surround .....	45
STABLE SOUND .....	48
Stereo sound .....	44
Sub-bass system (SBS) .....	46
S-video cables .....	5

## T

Theater wide picture .....	27
TIMER button .....	43
TOUCH FOCUS .....	21
Troubleshooting .....	51
TV/VIDEO button .....	18, 41

## V

V-CHI P	
BLOCKING OPTION .....	33
ENABLE BLOCKING .....	32
MPAA RATING .....	33
NEW PIN CODE .....	36
TV RATING .....	32
Unlocking programs temporarily .....	34
VCR connection .....	5–10
Video cables .....	5
VIDEO LABEL .....	41
VIDEO LOCK .....	35

## W

Warranty .....	52
----------------	----

## **TOSHIBA AMERICA CONSUMER PRODUCTS, INC.**

HEAD OFFICE/82 TOTOWA ROAD, WAYNE, NEW JERSEY 07470  
NATIONAL SERVICE DIVISION:1420B TOSHIBA DRIVE, LEBANON, TN. 37087

## **TOSHIBA HAWAII, INC.**

HEAD OFFICE/327 KAMAKEE STREET, HONOLULU, HAWAII 96814, U.S.A. TEL: (808) 591-9281

## **TOSHIBA OF CANADA LTD.**

HEAD OFFICE/191 McNABB STREET MARKHAM, ONTARIO L3R 8H2, CANADA TEL: (905) 470-5400  
SERVICE CENTERS/TORONTO: 191 McNABB STREET MARKHAM, ONTARIO L3R 8H2, CANADA TEL: (905) 470- 5400  
MONTREAL: 1643, NORTH SERVICE RD., TRANS-CANADA HIGHWAY, DORVAL QUEBEC, H9P 1J1, CANADA  
TEL: (514) 856-4100  
VANCOUVER: 22171 FRASERWOOD WAY, RICHMOND, B.C. V6W 1J5, CANADA TEL: (604) 303-2500

MANUFACTURED BY  
**TOSHIBA AMERICA CONSUMER PRODUCTS, INC.**

ColorStream is a registered trademark of Toshiba Corporation. StableSound is a trademark of Toshiba America Consumer Products, Inc.  
SRS and the ● symbol are trademarks of SRS Labs, Inc. SRS technology is incorporated under license from SRS Labs, Inc.

PRINTED IN USA  
(01-06)R

42/50/57/65H81(E)

# **TOSHIBA**

23565268

## Free Manuals Download Website

<http://myh66.com>

<http://usermanuals.us>

<http://www.somanuals.com>

<http://www.4manuals.cc>

<http://www.manual-lib.com>

<http://www.404manual.com>

<http://www.luxmanual.com>

<http://aubethermostatmanual.com>

Golf course search by state

<http://golfingnear.com>

Email search by domain

<http://emailbydomain.com>

Auto manuals search

<http://auto.somanuals.com>

TV manuals search

<http://tv.somanuals.com>