

TOSHIBA

For an overview of steps for installing, setting up, and using your new TV, see page 8.

OWNER'S MANUAL

Projection Television

16:9 WIDE COLORSTREAM® TouchFocus™

DOLBY DIGITAL

WOW
by SRS

TV
GUIDE
ON SCREEN

51H93
57H93
65H93



Owner's Record

The model number and serial number are on the back of your TV. Record these numbers in the spaces below. Refer to these numbers whenever you communicate with your Toshiba dealer about this TV.

Model number:

Serial number:

Dear Customer,

Thank you for purchasing this Toshiba TV. This manual will help you use the many exciting features of your new TV.

Before operating the TV, please read this manual completely, and keep it nearby for future reference.

Safety Precautions

WARNING

TO REDUCE THE RISK OF FIRE OR ELECTRIC SHOCK, DO NOT EXPOSE THIS APPLIANCE TO RAIN OR MOISTURE.

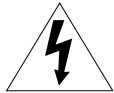

WARNING
RISK OF ELECTRIC SHOCK
DO NOT OPEN



WARNING: TO REDUCE THE RISK OF ELECTRIC SHOCK, DO NOT REMOVE COVER (OR BACK). NO USER-SERVICEABLE PARTS INSIDE. REFER SERVICING TO QUALIFIED SERVICE PERSONNEL.



The lightning symbol in the triangle tells you that the voltage inside this product may be strong enough to cause an electric shock. **DO NOT TRY TO SERVICE THIS PRODUCT YOURSELF.**



The exclamation mark in the triangle tells you that important operating and maintenance instructions follow this symbol.

NOTE TO CATV INSTALLERS IN THE USA

This is a reminder to call the CATV system installer's attention to Article 820-40 of the NEC, which provides guidelines for proper grounding and, in particular, specifies that the cable ground shall be connected to the grounding system of the building, as close to the point of cable entry as practical. For additional antenna grounding information, see items 25 and 26 on page 4.

NOTICE OF POSSIBLE TV STAND INSTABILITY



DANGER: RISK OF SERIOUS PERSONAL

INJURY OR DEATH! Use this TV with

the TOSHIBA TV stand recommended in the

"Specifications" section only. Use with other stands may result in instability, causing possible injury or death.

NOTICE OF POSSIBLE ADVERSE EFFECTS ON TV PICTURE TUBE

If a fixed (non-moving) pattern remains on the TV screen for long periods of time, the image can become permanently engrained in the picture tube. **This type of damage is NOT COVERED BY YOUR WARRANTY.** See item 33 on page 4.

Child Safety

It Makes A Difference Where Your TV Stands



Congratulations on your purchase! As you enjoy your new TV, keep these safety tips in mind:

The Issue

- If you are like most consumers, you have a TV in your home. Many homes, in fact, have more than one TV.
- The home theater entertainment experience is a growing trend, and larger TVs are popular purchases; however, they are not always supported on the proper TV stands.
- Sometimes TVs are improperly secured or inappropriately situated on dressers, bookcases, shelves, desks, audio speakers, chests, or carts. As a result, TVs may fall over, causing unnecessary injury.

Toshiba Cares!

- The consumer electronics industry is committed to making home entertainment enjoyable and safe.
- The Consumer Electronics Association formed the Home Entertainment Support Safety Committee, comprised of TV and consumer electronics furniture manufacturers, to advocate children's safety and educate consumers and their families about television safety.

Tune Into Safety

- One size does NOT fit all! Use appropriate furniture large enough to support the weight of your TV (and other electronic components).
- Use appropriate angle braces, straps, and anchors to secure your furniture to the wall (but never screw anything directly into the TV).
- Carefully read and understand the other enclosed instructions for proper use of this product.
- Do not allow children to climb on or play with furniture and TVs.
- Avoid placing any item on top of your TV (such as a VCR, remote control, or toy) that a curious child may reach for.
- Remember that children can become excited while watching a program and can potentially push or pull a TV over.
- Share our safety message about this hidden hazard of the home with your family and friends. Thank you!



2500 Wilson Blvd.
Arlington, VA 22201 U.S.A.
Tel. 703-907-7600 Fax 703-907-7690
www.CE.org

CEA is the Sponsor, Producer and Manager of the International CES®

0303

Important Safety Instructions

- 1) **Read these instructions.**
- 2) **Keep these instructions.**
- 3) **Heed all warnings.**
- 4) **Follow all instructions.**



- 5) **Do not use this apparatus near water.**



- 6) **Clean only with a dry cloth.**

- 7) **Do not block any ventilation openings.** Install in accordance with the manufacturer's instructions.

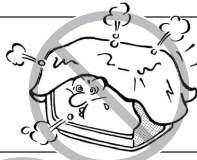

- 8) **Do not install near any heat sources** such as radiators, heat registers, stoves, or other apparatus (including amplifiers) that produce heat.



- 9) **Do not defeat the safety purpose of the polarized or grounding type plug.** A polarized plug has two blades with one wider than the other. A grounding type plug has two blades and a third grounding prong. The wide blade or the third prong are provided for your safety. If the provided plug does not fit into your outlet, consult an electrician for replacement of the obsolete outlet.

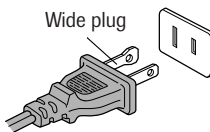

- 10) **Protect the power cord** from being walked on or pinched, particularly at plugs, convenience receptacles, and the point where it exits the apparatus.

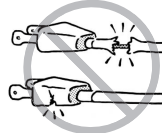

- 11) **Only use attachments/accessories specified by the manufacturer.**

- 12) **Use only with the cart, stand, tripod, bracket, or table specified by the manufacturer, or sold with the apparatus.** When a cart is used, use caution when moving the cart/apparatus combination to avoid injury from tip-over.



- 13) **Unplug this apparatus during lightning storms or when unused for long periods of time.**



- 14) **Refer all servicing to qualified service personnel.**

Service is required when the apparatus has been damaged in any way, such as power supply cord or plug is damaged, liquid has been spilled or objects have fallen into the apparatus, the apparatus has been exposed to rain or moisture, does not operate normally, or has been dropped.



- 15) **CAUTION:** To reduce the risk of electric shock, do not use the polarized plug with an extension cord, receptacle, or other outlet unless the blades can be inserted completely to prevent blade exposure.

Installation, Care, and Service

Installation

Follow these recommendations and precautions and heed all warnings when installing your TV:

- 16) Never modify this equipment. Changes or modifications may void: a) the warranty, and b) the user's authority to operate this equipment under the rules of the Federal Communications Commission.

- 17) **DANGER: RISK OF SERIOUS PERSONAL INJURY, DEATH, OR EQUIPMENT DAMAGE!** Never place the TV on an unstable cart, stand, or table. The TV may fall, causing serious personal injury, death, or serious damage to the TV.



- 18) Never place or store the TV in direct sunlight; hot, humid areas; areas subject to excessive dust or vibration; or locations with temperatures at or below 41°F (5°C).

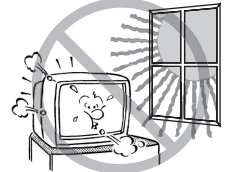

- 19) Always place the TV on the floor or a sturdy, level, stable surface that can support the weight of the unit.



- 20) Never place items such as vases, aquariums, or candles on top of the TV.



- 21) Never block or cover the slots or openings in the TV cabinet back, bottom, and sides. Never place the TV:
 - on a bed, sofa, rug, or similar surface;
 - too close to drapes, curtains, or walls; or
 - in a confined space such as a bookcase, built-in cabinet, or any other place with poor ventilation.



The slots and openings are provided to protect the TV from overheating and to help maintain reliable operation of the TV.

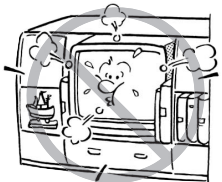

- 22) Never allow anything to rest on or roll over the power cord, and never place the TV where the power cord is subject to wear or abuse.

- 23) Never overload wall outlets and extension cords.



- 24) Always operate this equipment from a 120 VAC, 60 Hz power source only.



- 25) Always make sure the antenna system is properly grounded to provide adequate protection against voltage surges and built-up static charges (see Section 810 of the National Electric Code).

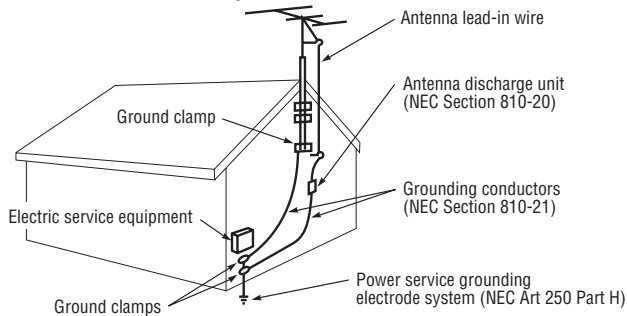

- 26) **! DANGER: RISK OF SERIOUS PERSONAL INJURY OR DEATH!**
- Use extreme care to make sure you are never in a position where your body (or any item you are in contact with, such as a ladder or screwdriver) can accidentally touch overhead power lines. Never locate the antenna near overhead power lines or other electrical circuits.
 - Never attempt to install any of the following during lightning activity:
 - a) an antenna system; or b) cables, wires, or any home theater component connected to an antenna or phone system.

Care

For better performance and safer operation of your TOSHIBA TV, follow these recommendations and precautions:

- 27) Always sit approximately 10–25 feet away from the TV and as directly in front of it as possible. The picture can appear dull if you sit too far to the left or right of the TV, or if sunlight or room lights reflect on the screen. Turn the TV off to check for reflections on the screen, and then remove the source of reflections while viewing the TV.

- 28) Always unplug the TV before cleaning. Never use liquid or aerosol cleaners.

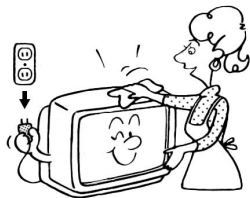

- 29) **! WARNING: RISK OF ELECTRIC SHOCK!** Never spill liquids or push objects of any kind into the TV cabinet slots.

- 30) [This item applies to projection TVs only.] If the air temperature rises suddenly (for example, when the TV is first delivered), condensation may form on the lenses. This can make the picture appear distorted or the color appear faded. If this happens, turn off the TV for 6 to 7 hours to allow the condensation to evaporate.

- 31) For added protection of your TV from lightning and power surges, always unplug the power cord and disconnect the antenna from the TV if you leave the TV unattended or unused for long periods of time.

- 32) During normal use, the TV may make occasional snapping or popping sounds. This is normal, especially when the unit is being turned on or off. If these sounds become frequent or continuous, unplug the power cord and contact a Toshiba Authorized Service Center.

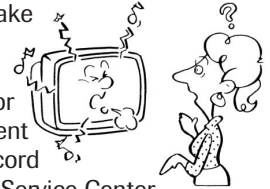

- 33) **Possible Adverse Effects on TV Picture Tube:** If a fixed (non-moving) pattern remains on the TV screen for long periods of time, the image can become permanently engrained in the picture tube and cause subtle but permanent ghost images. **This type of damage is NOT COVERED BY YOUR WARRANTY.** Never leave your TV on for long periods of time while it is displaying the following formats or images:

- **Fixed Images**, such as PIP/POP windows, stock tickers, video game patterns, TV station logos, and websites.
- **Special Formats** that do not use the entire screen. For example, viewing letterbox style (16:9) media on a normal (4:3) display (gray bars at top and bottom of screen); or viewing normal style (4:3) media on a widescreen (16:9) display (gray bars on left and right sides of screen).

Service

- 34) **! WARNING: RISK OF ELECTRIC SHOCK!** Never attempt to service the TV yourself. Opening and removing the covers may expose you to dangerous voltage or other hazards. Refer all servicing to a Toshiba Authorized Service Center.

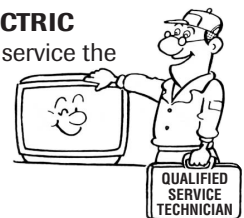

- 35) If you have the TV serviced:

- Ask the service technician to use only replacement parts specified by the manufacturer.
- Upon completion of service, ask the service technician to perform routine safety checks to determine that the TV is in safe operating condition.

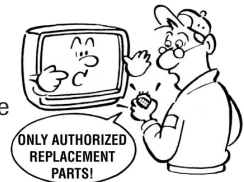

- 36) When the TV reaches the end of its useful life, ask a qualified service technician to properly dispose of the TV. Improper disposal may result in a picture tube implosion and possible personal injury.

Important Safety Precautions for Split Cabinet Feature

(Models 57H93 and 65H93 only)

Toshiba TV models 57H93 and 65H93 have a split cabinet feature that allows disassembly of the cabinet into two sections during installation.

For details, please refer to the insert titled "Disassembly/ Reassembly Instructions for Split Cabinet Feature" that accompanied this owner's manual in the accessory pack. If you do not have the insert, you can download a copy of it from our Web site (www.toshiba.com/tacp in the U.S.A. or www.toshiba.ca in Canada). If you do not have access to the Internet, call 1-800-631-3811 in the U.S.A. or 1-800-268-3404 in Canada.



WARNING: If you split the cabinet for any purpose, NEVER energize the bottom section until it is completely and properly installed.

Energizing the disassembled bottom section and subjecting it to intentional misuse (for example, exposing it to a foreign object) creates the potential for an electrical shock hazard that could result in death or serious injury.

CAUTION: If you use the split cabinet feature, ALWAYS handle and treat the top section of the TV cabinet, which contains a glass mirror, with great care. If subjected to excessive mechanical abuse (for example, if bumped or dropped), the mirror may break, creating exposed glass fragments with sharp edges. Contact with these glass fragments may result in injury.

Installation, Care, and Service

CAUTION: The split cabinet feature allows disassembly of the cabinet into two sections during installation. If you use the split cabinet feature, follow these precautions while the two sections of the TV cabinet are disassembled:

- 1) Always handle and treat the top section of the TV cabinet (with the viewing screen), which contains a glass mirror, with great care. If subjected to excessive mechanical abuse (for example, if bumped or dropped), the mirror may break, creating exposed glass fragments with sharp edges. Contact with these glass fragments may result in injury.
- 2) Never temporarily locate the disassembled bottom section in an area where it may be exposed to foreign objects or abuse (for example, areas where children may be playing, where items may fall on top of the unit, or where liquids may spill into the unit). Failure to follow this instruction may result in damage to the optic components of the TV. SUCH DAMAGE IS NOT COVERED UNDER THE TOSHIBA LIMITED WARRANTY.
- 3) Always keep the top and bottom sections of the TV cabinet in an upright position while disassembled. Failure to follow this instruction may result in damage to the TV, including but not limited to the optic components, cabinet, bezel, and glass mirror. SUCH DAMAGE IS NOT COVERED UNDER THE TOSHIBA LIMITED WARRANTY.
- 4) **Never energize the bottom section of the TV cabinet while disassembled. Failure to follow this instruction could result in death or serious injury.**
- 5) Never place anything on top of the bottom section of the TV cabinet. Failure to follow this instruction may result in damage to the optic components. SUCH DAMAGE IS NOT COVERED UNDER THE TOSHIBA LIMITED WARRANTY.
- 6) Never store or transport the unit while it is disassembled. Failure to follow this instruction may result in damage to the TV, including but not limited to the optic components, cabinet, bezel, and glass mirror. SUCH DAMAGE IS NOT COVERED UNDER THE TOSHIBA LIMITED WARRANTY.

Contents

Important Safety Information	2-5
Chapter 1: Introduction	7
Welcome to Toshiba	7
Features of your new TV	7
Note regarding the Quick Connect Guide	7
Overview of steps for installing, setting up, and using your new TV	8
Chapter 2: Connecting your TV	9
TV front panel controls and connections	9
TV back panel connections	10
Overview of cable types	11
About the connections illustrations	12
Connecting a VCR and antenna or Cable TV (no Cable box)	12
Connecting a VCR and Cable box	13
Connecting a VCR and satellite receiver	14
Connecting a DVD player S-video video and a VCR	15
Connecting a DVD player with component video and a VCR	16
Connecting two VCRs	17
Connecting a VCR to the REC OUT jacks	17
Connecting a DVI/HDCP device	18

Connecting a camcorder	18
Connecting a digital audio system	19
Connecting an analog audio system	19
Connecting an A/V receiver	20
Controlling infrared remote-controlled devices through the TV (IR pass-through)	21
Connecting IEEE-1394 (Firewire™) video devices	22
G-LINK™ connection	25
Chapter 3: Using the remote control	26
Learning about the remote control	26
Installing the remote control batteries	27
Using the remote control MODE button to control other devices	27
Remote Control functional key chart	28
Programming the remote control to operate your other devices	30
Multi-brand remote control device codes	32
Chapter 4: Menu layout and navigation	34
Main menu layout	34
Setup/installation menu layout	35
Navigating the menu system	35

(Continued)

Contents *(continued from previous page)*

Chapter 5: Quick Connect Guide & TV Guide

On Screen™ setup 36

- Starting the Quick Connect Guide assisted setup 36
- Setting up the TV Guide On Screen system 37
- Completing the Quick Setup Guide assisted setup 40

Chapter 6: Setting up your TV 41

- Selecting the menu language 41
- Configuring the antenna input sources 41
- Programming channels into the TV's channel memory .. 42
 - Programming channels automatically 42
 - Manually adding and deleting channels in the channel memory 43
- Programming your favorite channels 44
- Setting up and using TheaterNet on-screen device control 45
 - Setting up TheaterNet 45
 - Using the TheaterNet control icons 46
 - TheaterNet IR device codes 47
- Adjusting the color convergence 50
- Setting the time and date 51
- Viewing the digital signal meter 52
- Checking system status 52

Chapter 7: Using the TV Guide On Screen™

interactive program guide 53

- Setting up the TV Guide On Screen™ system 53
- About the TV Guide On Screen™ menus 54
- Navigating the TV Guide On Screen™ system 55
- LISTINGS menu 56
 - Viewing program listings and descriptions 56
 - INFO windows 56
 - Direct tuning 57
 - Video Window 57
 - Setting programs as favorites 57
 - One-touch and VCR Plus+® recording 57
 - Viewing panel ads and channel ads 58
 - Using the Menu Bar to access other menus 58
- SORT menu 58
- SCHEDULE menu 59
 - Favorites schedule 59
 - Record schedule 59
- SETUP menu 59
 - Change system settings 59
 - Change channel display 59
 - Review options (change the auto display setting) 59
- PROMOTIONS menu 60
- MESSAGES menu 60

Chapter 8: Using the TV's features 61

- Selecting the video input source to view 61
- Using the digital tuner hold 61
- Labeling the video input sources 62
- Tuning channels 63
 - Tuning to the next programmed channel 63
 - Using SpeedSurf to change to a specific programmed channel 63
 - Tuning to a specific channel (programmed or unprogrammed) 63
 - Switching between two channels using Channel Return 63
- Selecting the picture size 64
 - Natural picture size 65
 - Theater Wide 1 picture size 65
 - Theater Wide 2 picture size 65

- Theater Wide 3 picture size 65
- Full picture size 65
- Scrolling the Theater Wide picture 66
- Using the auto aspect feature (480i signals only) 66
- Selecting the cinema mode 67
- Selecting the display format (480p signals only) 67
- Using the POP features 68
 - Using the POP double-window feature 68
 - Switching the main and POP pictures 69
 - Freezing the main picture in the POP double-window 69
 - Adjusting the size of the main and POP pictures 69
 - POP double-window aspect ratio 70
 - Using the programmed channel scan feature 70
 - Using the favorite channel search feature 71
- Adjusting the picture 72
 - Selecting the picture mode 72
 - Adjusting the picture quality 72
 - Resetting the picture settings 72
 - Using the ALS (ambient light sensor) 73
 - Using the flesh tone feature 73
 - Using CableClear™ DNR (digital noise reduction) . 74
 - Selecting the color temperature 74
 - Resetting the advanced picture settings 74
- Using the closed caption mode 75
 - Advanced closed captions 75
- Adjusting the audio 76
 - Muting the sound 76
 - Selecting stereo/SAP broadcasts 76
 - Adjusting the audio quality 77
 - Using the sub-bass system (SBS) 77
 - Using the StableSound™ feature 78
 - Using the SRS WOW™ surround sound feature 78
 - Turning off the built-in speakers 79
 - Selecting the optical audio output format 79
 - Selecting the AUDIO OUT sound 79
- Using the SmartMedia™ memory card picture viewer 80
 - Memory card specifications 80
 - Viewing digital photos on your TV 80
 - Memory card care and handling 81
- Setting the ON/OFF timer 82
- Setting the sleep timer 82
- Displaying TV setting information on-screen 83
- Viewing the demo mode 83
- Understanding the auto power off feature 83
- Understanding the last mode memory feature 83

Chapter 9: Using the Locks menu 84

- Entering the PIN code 84
- If you cannot remember your PIN code 84
- Changing your PIN code 84
- Blocking TV programs and movies by rating (V-Chip) 85
- Blocking channels 86
- Unlocking programs temporarily 86
- Locking video inputs 86
- Using the game timer 87
- Using the front panel lock feature 87

Chapter 10: Troubleshooting 88

- General troubleshooting 88
- TV Guide On Screen FAQs 90

Chapter 11: Appendix 93

- Specifications 93
- Limited United States Warranty 94
- Limited Canada Warranty 95

Index 96

1 Introduction

Welcome to Toshiba

Thank you for purchasing this Toshiba TV, one of the most innovative projection TVs on the market. The goal of this manual is to guide you through setting up and operating your TV as quickly as possible.

- This manual applies to models 51H93, 57H93, and 65H93. Before you start reading, check the model number on the back of your TV.
- Instructions in this manual are based on using the remote control. You also can use the controls on the TV front panel if they have the same name as those referred to on the remote control.
- The front panel (behind the door) and back panel provide all the terminal connections you will need to connect other equipment to your TV. See page 9 for front panel details. See page 10 for back panel details. See pages 11–25 for instructions on connecting other devices to your TV.
- Model 57H93 is used in this manual for illustration purposes.
- **Please read all safety and operating instructions in this manual carefully, and keep this manual for future reference.**

Note regarding the Quick Connect Guide

The Quick Connect Guide automatically appears the first time the TV is turned on. This feature provides on-screen instructions for configuring your TV's settings, including setting up the TV Guide On Screen™ interactive program guide.

See page 36 for details.

To stop the Quick Connect Guide, press EXIT or POWER.

Features of your new TV

The following are just a few of the many exciting features of your new Toshiba widescreen projection TV:

- **Integrated digital tuning (8VSB ATSC and QAM)** eliminates the need for a separate digital converter set-top box
- **TV Guide On Screen™** no-fee interactive program guide (page 37)
- **SD SmartMedia™** multi-card memory card slot for viewing JPEG format photos as a “slide show” on your TV (page 80)
- **TheaterNet™** on-screen icons for control of external **IR** and **IEEE-1394** devices (page 45)
- **Two IEEE-1394 ports (DTVLink)** for multi-device connection and control (page 24)
- **DVI/HDCP** high-definition digital device input (page 18)
- **Two sets of ColorStream® HD** high-resolution component video inputs (page 14, 16)
- **Dolby Digital*** (page 19), **SRS® WOW** (page 78), and **SBS** (page 77) audio technologies
- **Digital Audio Out** optical audio connection (page 19)
- **TouchFocus™** automatic color convergence (page 50)
- **CrystalScan HDSC** (all-time 1080i) with user-selectable 540p
- **CableClear DNR™** (page 74)
- Multi-format, double-window **POP** features (page 68)

**To get started, see
“Overview of steps for
installing, setting up,
and using your new TV”
on page 8.**

In the United States, TV GUIDE and other related marks are registered marks of Gemstar-TV Guide International, Inc. and/or one of its affiliates. In Canada, TV GUIDE is a registered mark of Transcontinental Inc., and is used under license by Gemstar-TV Guide International, Inc. TV Guide On Screen, G-LINK, VCR Plus+ and PlusCode are registered trademarks of Gemstar-TV Guide International and/or one of its affiliates. The TV Guide On Screen and VCR Plus+ systems are manufactured under license from Gemstar-TV Guide International, Inc. and/or one of its affiliates.

GEMSTAR-TV GUIDE INTERNATIONAL, INC., AND/OR ITS RELATED AFFILIATES, AND/OR TOSHIBA AMERICA CONSUMER PRODUCTS ARE NOT IN ANY WAY LIABLE FOR THE ACCURACY OF THE PROGRAM SCHEDULE INFORMATION PROVIDED BY THE TV GUIDE ON SCREEN SYSTEM. IN NO EVENT SHALL GEMSTAR-TV GUIDE INTERNATIONAL, INC., AND/OR ITS RELATED AFFILIATES, AND/OR TOSHIBA AMERICA CONSUMER PRODUCTS BE LIABLE FOR ANY AMOUNTS REPRESENTING LOSS OF PROFITS, LOSS OF BUSINESS, OR INDIRECT, SPECIAL, OR CONSEQUENTIAL DAMAGES IN CONNECTION WITH THE PROVISION OR USE OF ANY INFORMATION, EQUIPMENT, OR SERVICES RELATING TO THE TV GUIDE ON SCREEN SYSTEM.

The TV Guide On Screen system is protected by one or more issued United States patents such as 6,331,877; 6,239,794; 6,154,203; 5,940,073; 4,908,713; 4,751,578; 4,706,121. The TV Guide On Screen and VCR Plus+ systems are protected by one or more issued United States patents such as 6,331,877; 6,239,794; 6,154,203; 5,940,073; 4,908,713; 4,751,578; 4,706,121; 6,466,734; 6,430,359; 6,091,882; 6,049,652; 5,335,079; 5,307,173.

A recording device is required for recording. Over-the-air or cable access to stations carrying TV Guide On Screen data is required for the TV Guide On Screen system to operate. TV Guide On Screen data is not provided by Toshiba America Consumer Products, Inc. The provider of the data may elect to discontinue the service or it may cease to be (or never be) available in your area. In any of these circumstances, the TV Guide On Screen feature will not function.

SRS WOW, SRS and the (●) symbol are trademarks of SRS Labs, Inc. SRS WOW technology is incorporated under license from SRS Labs, Inc.

*Manufactured under license from Dolby Laboratories. “Dolby,” “Pro Logic,” and the double-D symbol are trademarks of Dolby Laboratories.

Overview of steps for installing, setting up, and using your new TV

Follow these steps to set up your TV and begin using its many exciting features.

- Carefully read the important safety, installation, care, and service information on pages 2–4. Keep this manual for future reference.**
 - Do not plug in any power cords** until AFTER you have connected all cables and devices to your TV.
 - If you need to split your TV** into two sections during moving or installation, read the “Important Safety Precautions for Split Cabinet Feature” on page 5.
 - Consider the following when selecting a location for your TV:**
 - Place the TV on the floor only.
 - Place the TV in a location where light does not reflect on the screen.
 - Place the TV far enough from walls and other objects to allow proper ventilation. Inadequate ventilation may cause overheating, which will damage the TV. THIS TYPE OF DAMAGE IS NOT COVERED UNDER THE TOSHIBA WARRANTY BECAUSE IT IS A RESULT OF MISUSE.
 - Read “Installation” on pages 3–4.
 - Remove the demo pin from the G-LINK jack on the back of the TV** (see illustration below).
- TV back panel

DEMO PIN
This Demo Pin automatically activates the TV Guide On Screen demo.

RETAILERS:
Do not remove this Demo Pin. Removal will disable the automatic demo.

CONSUMERS:
Remove this Demo Pin and insert the IR blaster cable here before using your TV.
- BEFORE connecting cables or devices to the TV, learn the functions** of the TV's connections and controls (page 10).
 - Connect your other electronic device(s) to the TV** (pages 12–25).
 - Connect the G-LINK cable** (either one of the enclosed IR blaster cables) from your VCR and/or Cable box to the G-LINK jack so you can use the TV Guide On Screen™ device control and one-touch recording features. See page 25.
 - AFTER connecting all cables and devices, plug in the power cords** for your TV and other devices.
 - Install the batteries in the remote control** (page 27).
 - See “Learning about the remote control” for an overview of the buttons on the remote control** (page 26).
 - Program the remote control to operate your other device(s)** (pages 27–33).
 - Turn on the TV and other device(s).**
 - Follow the on-screen Quick Connect Guide** for assistance in configuring the TV's settings and **setting up the TV Guide On Screen™ program guide**. (The Quick Connect Guide starts automatically the first time you turn on the TV.) See page 36 for details.
 - Program channels into the TV's channel memory** (page 42), if you did not already do so during the Quick Connect Guide setup.
 - See “Menu layout and navigation” for a quick overview of the TV's menu structure and navigation** (pages 34–35).
 - See Chapter 7 for details on using the TV Guide On Screen™ program guide** (if available in your area) (page 53).
 - Set up the TheaterNet™ on-screen device control feature** (if applicable to your particular home theater system components) (page 45).
 - See page 80 for details on using the SmartMedia™/SD JPEG picture viewer.**
 - See Chapter 8 for details on using the TV's features** (page 61).
 - For technical specifications, see page 93.**
 - For help, refer to the Troubleshooting Guide on pages 88–92.**
 - For warranty information, see page 94–95.**
 - Enjoy your new TV!**

2 Connecting your TV

TV front panel controls and connections

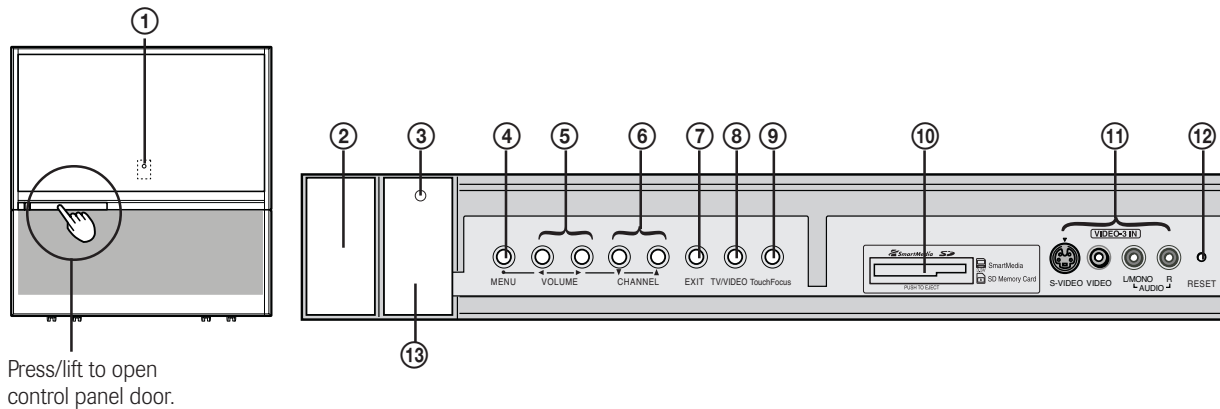

- Press/lift to open control panel door.
- ① **Remote control sensor** (*behind the screen*) — Point the remote control toward this area of the TV screen.
 - ② **POWER** — Press to turn the TV on and off.
 - ③ **Power indicator light** — When illuminated, this light indicates that the TV is on.
 - ④ **MENU** — Press to access the menu system (see page 35). When the TV Guide On Screen program guide is open, this button functions as the ENTER button.
 - ⑤ **VOLUME** ◀▶ — When no menu is on-screen, these buttons adjust the volume level. When a menu is on-screen, these buttons function as left/right menu navigation buttons.
 - ⑥ **CHANNEL** ▲▼ — When no menu is on-screen, these buttons change the channel (programmed channels only). When a menu is on-screen, these buttons function as up/down menu navigation buttons.
 - ⑦ **EXIT** — Press to close an on-screen menu instantly.
 - ⑧ **TV/VIDEO** — Repeatedly press to change the source you are viewing (ANT 1, ANT 2, VIDEO 1, VIDEO 2, VIDEO 3, DVI/HDCP, ColorStream HD1, ColorStream HD2).
 - ⑨ **TouchFocus™** — Press to automatically adjust the color convergence (see page 50).
 - ⑩ **SD SmartMedia™ slot** — Insert a memory card to view JPEG files from a digital camera (see page 80).
 - ⑪ **VIDEO-3** — The front panel A/V connections are referred to as “VIDEO 3” and include standard A/V connections plus optional S-video. (The VIDEO 1 and VIDEO 2 A/V connections are on the TV’s back panel. See page 10.)
 - ⑫ **RESET** — If the TV stops responding to the controls on the remote control or TV front panel and you cannot turn off the TV, press this button to reset the TV.
Note: The RESET button is recessed, so you will need to use the end of a paper clip or similar object to press the button.
 - ⑬ **Ambient light sensor (ALS)** — The ALS detects the room’s ambient light and automatically adjusts the contrast. If you use the ALS feature (page 73), make sure you do not block the ALS on the front panel or it will not work properly.

TV back panel connections

For an explanation of cable types, see page 11.

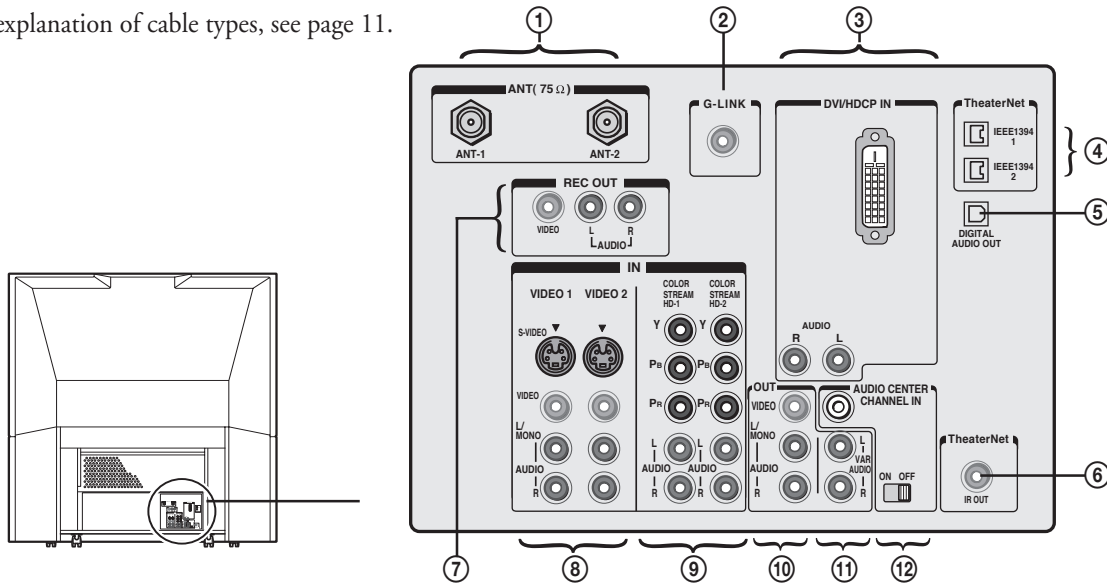

- ① **ANT-1 IN and ANT-2 IN** — Two inputs that support analog (NTSC) and digital (ATSC) off-air antenna signals and analog and digital (QAM) Cable TV signals.
Note: If you have an antenna only, connect it to ANT-1. If you have both Cable TV and an antenna, connect the Cable TV to ANT-1 and the antenna to ANT-2.
- ② **G-LINK™** — For use with one of the enclosed IR blaster/G-LINK cables to enable the TV Guide On Screen™ device control and one-touch recording features. See page 25.
- ③ **DVI/HDCP IN** — Digital DVI/HDCP single-link video plus standard audio inputs for connecting high-definition devices with single-link DVI/HDCP output. See page 18.
Note: DVI-D cable carries only video information; separate audio cables are required for a complete connection.
- ④ **IEEE-1394** — Two bi-directional digital IEEE-1394 (also known as FireWire™) ports for connecting multiple devices with compressed digital video. Because these ports are bi-directional, they can be used for playback and recording. You can control your IEEE-1394 devices using the TV's TheaterNet on-screen control icons. See page 45.
Note: IEEE-1394 cable carries both audio and video information; no separate audio cables are required for a complete connection.
- ⑤ **Digital Audio OUT** — Optical audio output in Dolby Digital or PCM (pulse-code modulation) format for connecting an external Dolby Digital decoder, amplifier, AV receiver, or home theater system with optical audio input. See page 19.
- ⑥ **IR OUT** — For controlling infrared remote-controlled devices through the TV. You can connect up to two devices with either one of the enclosed IR blaster cables, and then control the devices using the TV's IR pass-through or TheaterNet™ (on-screen device control) features. See pages 21 and 45.
- ⑦ **REC (record) OUT** — Composite video and audio outputs for recording down-converted digital off-air antenna (ATSC), digital Cable TV (QAM), or IEEE-1394 programs to an analog VCR. See page 17.
Note: The REC OUT jacks will not output a DVI signal and cannot be used for timed recordings.
- ⑧ **VIDEO 1 IN and VIDEO 2 IN** — Two sets of standard (composite) video and standard audio inputs plus optional S-video inputs for connecting devices with composite video or S-video output.
Note: Standard (composite) video and S-video cables carry only video information; separate audio cables are required for a complete connection.
- ⑨ **ColorStream HD-1 and ColorStream HD-2** — Two sets of ColorStream® high-definition component video and standard stereo audio inputs for connecting devices with component video output, such as a Toshiba DVD player with ColorStream®. See pages 14 and 16.
Note: Component video cables carry only video information; separate audio cables are required for a complete connection.
- ⑩ **A/V OUT** — Standard (composite) video and standard audio outputs for connecting a VCR for editing and dubbing. See page 17 for details.
- ⑪ **Variable Audio OUT** — Standard audio outputs for connecting an analog amplifier with external speakers. See page 19.
- ⑫ **Audio Center Channel IN plus ON/OFF switch** — For use with an external A/V receiver to enhance your TV's audio. When the switch is set to OFF, the TV's audio is output through the TV's internal speakers. When the switch is set to ON, the TV's audio is output through the A/V receiver and the TV's speakers are used as a center channel. See page 20.

Overview of cable types

Note: Two dual-wand IR blaster/G-LINK cables are included with your TV. All other required cables, if not provided with your other devices, can be purchased at many electronics accessory suppliers.

- **Coaxial (F-type) cable** is used for connecting your antenna, cable TV service, and/or cable converter box to the ANT-1 and/or ANT-2 RF inputs on your TV.
- **Standard A/V cables (composite video)** usually come in sets of three, and are for use with video devices with standard audio and standard (composite) video output. These cables (and the related inputs on your TV) are typically color-coded according to use: yellow for video, red for stereo right audio, and white for stereo left (or mono) audio.
- **S-video cable** is for use with video devices with S-video output. Separate audio cables are required for a complete connection.

Note: An S-video cable provides better picture performance than a composite video cable. If you connect an S-video cable, be sure to disconnect the standard (composite) video cable or the picture performance will be unacceptable.

- **Component video cables** come in sets of three and are for use with video devices with component video output. These cables are typically color-coded red, green, and blue. (ColorStream® is Toshiba's brand of component video.) Separate audio cables are required for a complete connection.

Note: Component video cables provide better picture performance than a standard (composite) video or S-video cable.

- **DVI-D digital single-link cable** is for use with video devices with uncompressed DVI-D digital single-link output. DVI-D cable delivers digital video in its native format (see page 18). Separate audio cables are required for a complete connection.

Note: DVI-D digital single-link cable provides better picture performance than a standard (composite) video or S-video cable.

- **IEEE-1394 cable** is for use with video devices with compressed digital video output that meets CEA specifications for IEEE-1394 (also known as Firewire™). IEEE-1394 cables carry both video and audio information; therefore, no separate audio cables are needed for a complete connection. See pages 22 and 24.

Note: IEEE-1394 cable provides better picture performance than a standard (composite) video or S-video cable.

- **Dual-wand IR blaster/G-LINK cable** is for use with video devices with IR (infrared) remote control. Two of these cables are included with your TV. One is for connection to the G-LINK jack (page 25) to enable TV Guide On Screen™ device control and one-touch recording (page 53). The other can be used with the TV's IR pass-through feature (page 21) and TheaterNet on-screen device control feature (page 45).

Important note: The two IR blaster/G-LINK cables included with your TV have specific characteristics that allow them to work properly with this TV's IR OUT and G-LINK ports.

Never use other aftermarket IR blaster or G-LINK cables with this TV. Other cables may not function properly and could cause damage. **THIS TYPE OF DAMAGE IS NOT COVERED BY YOUR TOSHIBA WARRANTY** because it is a result of misuse.

- **Optical audio cable** is for connecting receivers with Dolby Digital or PCM (pulse-code modulation) optical audio input to the TV's DIGITAL AUDIO OUT jack. See pages 10 and 19.

Note regarding picture quality

- **For GOOD picture quality:** Use standard (composite) video cables.
- **For BETTER picture quality:** If your equipment has S-video, use an S-video cable instead of a standard (composite) video cable.
- **For BEST picture quality:** If your equipment has component video (ColorStream), DVI, or IEEE-1394 (Firewire) output, use component video cables, a DVI-D cable, or an IEEE-1394 cable, respectively.

For a complete connection, be sure to connect the audio cables, where necessary.

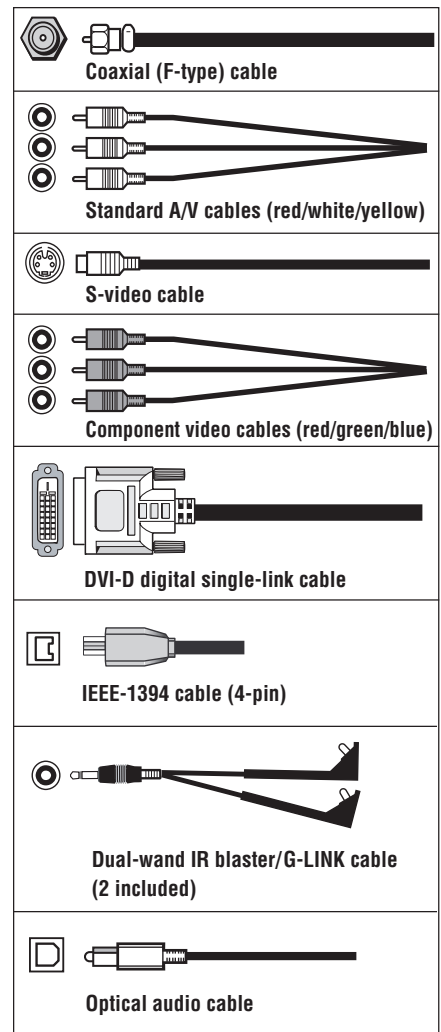

CAUTION: Do not plug in any power cords until you have finished connecting all equipment.

Note: Although your TV includes both DVI/HDCP and IEEE-1394 connections, it may not operate with another device you have that includes such a connection. For example, the IEEE-1394 ports are not intended to operate with current model Mini DV camcorders, and the DVI/HDCP input is not intended for connection to a computer. Copyright protection requirements may also prohibit or limit connectivity. See page 18 for details about the DVI/HDCP input. See pages 22–24 for details about the IEEE-1394 ports. You should confirm that the devices you want to use with the TV will operate with the appropriate connections.

About the connection illustrations

You can connect different types and brands of devices to your TV in several different configurations. The suggested connection illustrations in this manual are representative of typical device connections only. The input/output jacks on your devices may differ from those illustrated herein. For details about connecting and using your specific devices, refer to each device's owner's manual.

Connecting a VCR and antenna or Cable TV (no Cable box)

You will need:

- ▶ two coaxial cables
- ▶ one set of standard A/V cables
 - For better picture performance, if your VCR has S-video, use an S-video cable (plus the audio cables) instead of the standard video cable. However, do not connect both types of video cables to VIDEO 1 (or VIDEO 2) at the same time or the picture performance will be unacceptable.
 - If you have a mono VCR, connect L/MONO on the TV to your VCR's audio out jack using the white audio cable only.

To view the antenna or Cable signal:

Turn off the VCR.

Select the ANT 1 video input source.*

- If you have both an off-air antenna and Cable TV, connect the antenna to ANT-2 and the Cable TV to ANT-1 (because ANT-1 is the only source for the TV Guide On Screen program guide).

To view the VCR:

Turn ON the VCR. Select the VIDEO 1 video input source on the TV.*

or... Turn ON the VCR. Select the ANT 1 video input source.*
Tune the TV to channel 3 or 4 (whichever channel is vacant in your area).

* To select the video input source, press INPUT on the remote control (see page 61). To program the TV remote control to operate other devices, see pages 30-33.

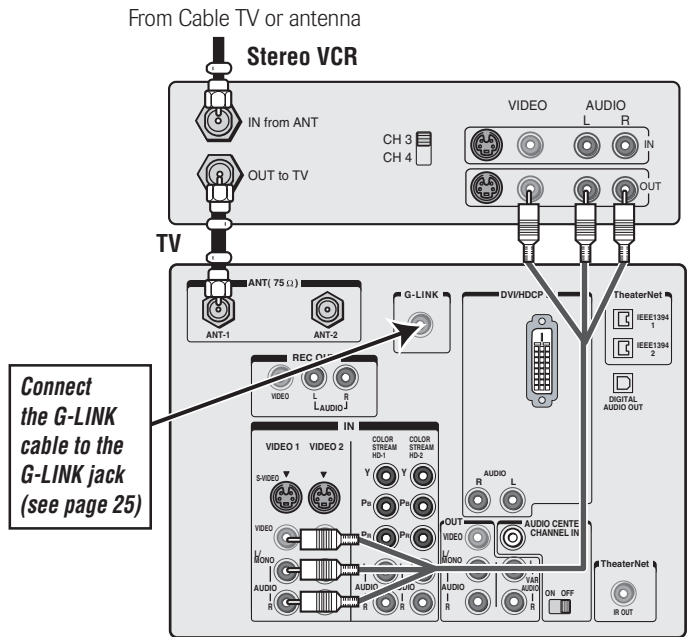

Connecting a VCR and Cable box

You will need:

- ▶ one Cable signal splitter
- ▶ five coaxial cables
- ▶ one set of standard A/V cables
 - For better picture performance from your VCR: If your VCR has S-video, connect an S-video cable (plus the audio cables) instead of the standard video cable. Do not connect an S-video cable and a standard video cable to VIDEO 1 (or VIDEO 2) at the same time or the picture performance will be unacceptable.
 - If you have a mono VCR, connect L/MONO on the TV to your VCR's audio out jack using the white audio cable only.
 - For better picture performance from your Cable box: If your Cable box has component video, you can connect component video cables (plus the audio cables) instead of the standard video cable from the Cable box to the ColorStream HD-1 inputs on the TV. You would then select ColorStream HD-1 as the video input source.*
 - When you use a Cable box, you may not be able to use the remote control to program or access certain features on the TV.

To view basic Cable channels and use the TV's features:

Select the ANT 2 video input source.* Use the TV front panel controls or remote control to change channels and access the TV's features.

To view basic and premium Cable channels:

Turn OFF the VCR. Select the ANT 1 video input source.* Tune the TV to channel 3 or 4 (whichever channel is vacant in your area). Use the Cable box controls to change channels.

or... Turn ON the VCR. Tune the VCR to channel 3 or 4 (whichever channel is vacant in your area). Select the VIDEO 1 video input source.* Use the Cable box controls to change channels.

To view the VCR:

Select the VIDEO 1 video input source.*

Note: This will provide better picture performance if you connected an S-video cable as mentioned in the first bulleted item on this page.

or... Turn ON the VCR. Select the ANT 1 video input source.* Tune the TV to channel 3 or 4 (whichever channel is vacant in your area).

* To select the video input source, press INPUT on the remote control (see page 61). To program the TV remote control to operate other devices, see pages 30–33.

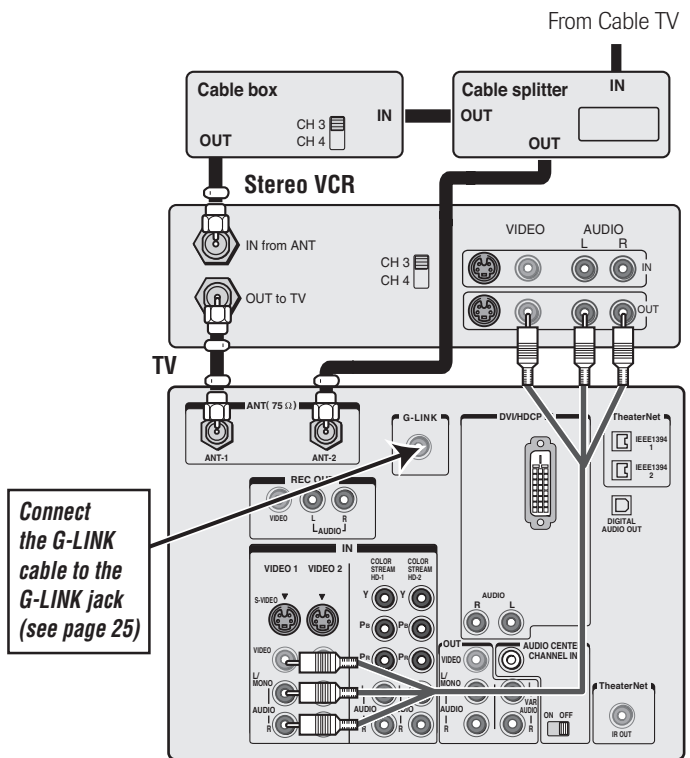

Connecting a VCR and satellite receiver

You will need:

- ▶ three coaxial cables
- ▶ one set of component video cables (if your satellite receiver does not have component video, connect the standard A/V cables only)
- ▶ two sets of standard A/V cables
 - For better picture performance, if your satellite receiver and VCR have S-video, connect S-video cables (plus the audio cables) instead of the standard video cables from the satellite receiver to the VCR and then from the VCR to VIDEO 1 on the TV. Do not connect both types of video cable to VIDEO 1 (or VIDEO 2) at the same time or the picture performance will be unacceptable.
 - If you have a mono VCR, connect L/MONO on the TV (VIDEO 1) to your VCR's AUDIO OUT jack using the white audio cable only.

To view satellite programs using the component video connections:

Select the ColorStream HD-1 video input source on the TV.*

To view satellite programs using the standard video connections or to record satellite programs:

Turn on all three devices. Select "LINE IN" on the VCR. Select the VIDEO 1 video input source on the TV.*

To view the VCR or view and record antenna channels:

Select the ANT-1 video input source on the TV.*
Tune the TV to channel 3 or 4 (whichever channel is vacant in your area).

or... Tune the VCR to the channel you want to watch.
Select the VIDEO 1 video input source on the TV.*

* To select the video input source, press INPUT on the remote control (see page 61). To program the TV remote control to operate other devices, see pages 30-33.

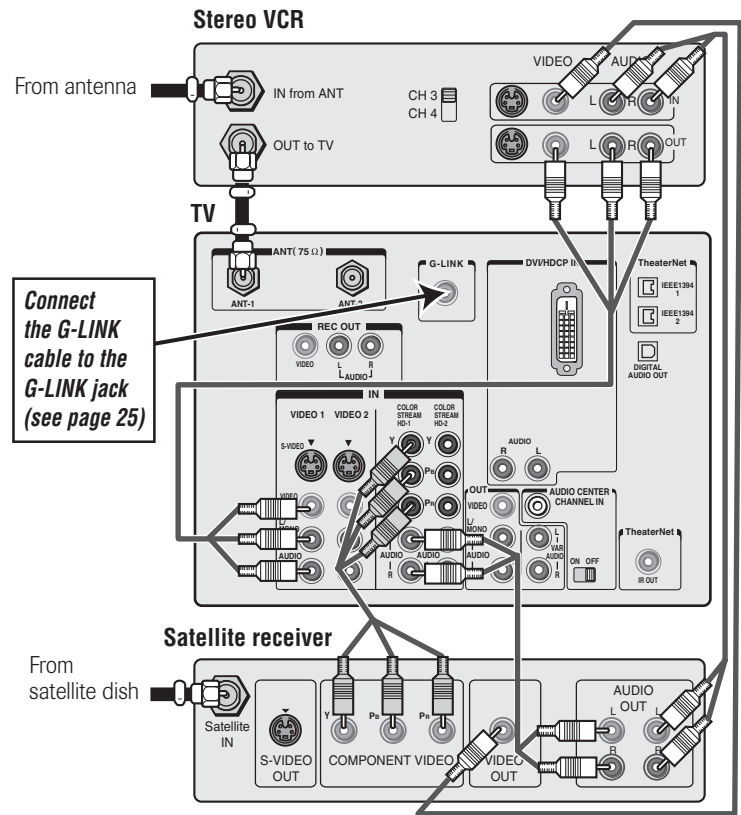

Connecting a DVD player with S-video and a VCR

You will need:

- ▶ five coaxial cables
- ▶ one set of standard A/V cables
- ▶ one S-video cable
- ▶ one pair of standard audio cables

Note: If you have a mono VCR, connect L/MONO on the TV (VIDEO 1) to your VCR's audio out jack using the white audio cable only.

Note:

- If your DVD player does not have S-video, use a standard video cable instead. Do not connect an S-video cable and a standard video cable to VIDEO 1 (or VIDEO 2) at the same time or the picture performance will be unacceptable.
- If your DVD player has component video, see page 16.
- Do not connect the DVD player and VCR to the same set of A/V inputs on the TV. (See the illustration, which shows the VCR connected to VIDEO 1 on the TV, and the DVD player connected to VIDEO 2.)

To view basic channels and access the TV's features:

Select the ANT 2 video input source.* Use the TV controls to change channels and access the TV's features.

To view premium Cable channels:

Turn OFF the VCR. Select the ANT 1 video input source.* Tune the TV to channel 3 or 4 (whichever channel is vacant in your area). Use the Cable box controls to change channels.

or... Turn ON the VCR. Tune the VCR to channel 3 or 4 (whichever channel is vacant in your area). Select the VIDEO 1 video input source.* Use the Cable box controls to change channels.

Note: When you use a Cable box, you may not be able to use the remote control to program or access certain features on the TV.

To view the DVD player:

Select the VIDEO 2 video input source.*

To view the VCR:

Select the VIDEO 1 video input source on the TV.*

or... Turn ON the VCR. Select the ANT 1 video input source.* Tune the TV to channel 3 or 4 (whichever channel is vacant in your area).

* To select the video input source, press INPUT on the remote control (see page 61). To program the TV remote control to operate other devices, see pages 30-33.

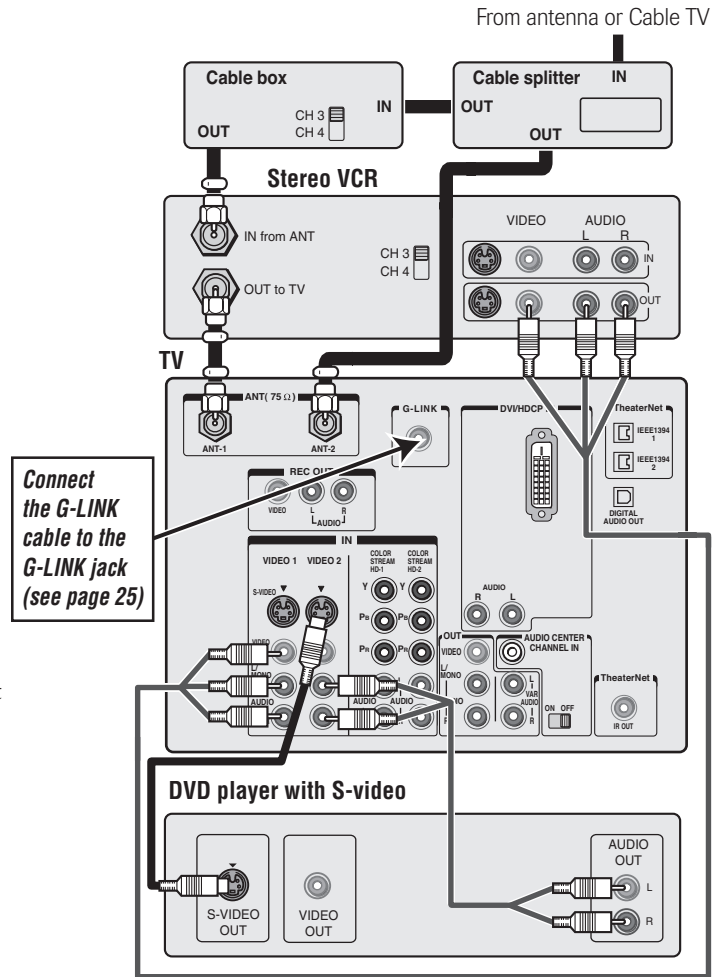

Connect the G-LINK cable to the G-LINK jack (see page 25)

The unauthorized recording, use, distribution, or revision of television programs, videotapes, DVDs, and other materials is prohibited under the Copyright Laws of the United States and other countries, and may subject you to civil and criminal liability.

Connecting a DVD player with component video and a VCR

Your TV has ColorStream® (component video) inputs. Connecting a DVD player with component video output (such as a Toshiba DVD player with ColorStream®) can greatly enhance picture quality.

You will need:

- ▶ two coaxial cables
- ▶ two sets of standard A/V cables
 - For better picture performance, if your VCR has S-video, use an S-video cable (plus the audio cables) instead of the standard video cable. However, do not connect both types of video cable to VIDEO 1 (or VIDEO 2) at the same time or the picture performance will be unacceptable.
 - If you have a mono VCR, connect L/MONO on the TV (VIDEO 1) to your VCR's audio out jack using the white audio cable only.
- ▶ one pair of standard audio cables
- ▶ one set of component video cables
 - You can connect the component video cables (plus audio cables) from the DVD player to either set of ColorStream jacks on the TV (HD-1 or HD-2). The ColorStream HD-1 and HD-2 jacks can be used with Progressive (480p, 720p) and Interlaced (480i, 1080i) scan systems. A 1080i signal will provide the best picture performance.
 - If your DVD player does not have component video, see page 15. If your DVD player has DVI/HDCP video, see page 18.

To view antenna or Cable channels:

Turn OFF the VCR. Select the ANT 1 video input source on the TV.*

To view the DVD player:

Select the ColorStream HD-1 video input source on the TV.*

To view the VCR:

Select the VIDEO 1 video input source on the TV.*

or... Turn ON the VCR. Select the ANT 1 video input source.*
Tune the TV to channel 3 or 4 (whichever channel is vacant in your area).

To record a TV program while watching a DVD:

Tune the VCR to the channel to record. Select the ColorStream HD-1 video input source on the TV* to view the DVD.

* To select the video input source, press INPUT on the remote control (see page 61). To program the TV remote control to operate other devices, see pages 30-33.

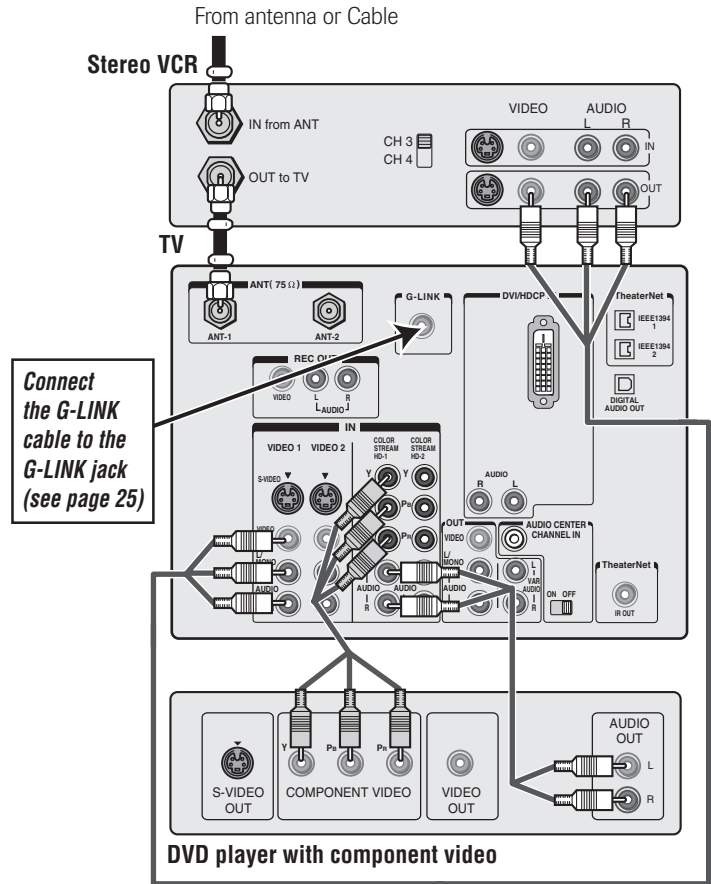

The unauthorized recording, use, distribution, or revision of television programs, videotapes, DVDs, and other materials is prohibited under the Copyright Laws of the United States and other countries, and may subject you to civil and criminal liability.

Connecting two VCRs

You will need:

- ▶ two coaxial cables
- ▶ two sets of standard A/V cables
 - For better picture performance, if VCR 1 has S-video, use an S-video cable (plus the audio cables) instead of the standard video cable. However, do not connect both types of video cable to VIDEO 1 (or VIDEO 2) at the same time or the picture performance will be unacceptable.
 - If VCR 1 has mono audio, connect L/MONO on the TV (VIDEO 1) to the audio out jack on VCR 1 using the white audio cable only.
 - Do not connect the same VCR to the output and input jacks on the TV at the same time.

☐ To view the antenna or Cable signal:

Turn OFF the VCR. Select the ANT-1 video input source.*

- If you have both an off-air antenna and Cable TV, connect the antenna to ANT-2 and the Cable TV to ANT-1 (ANT-1 and VIDEO 1 are the only sources for the TV Guide On Screen program guide).

☐ To view VCR 1:

Select the VIDEO 1 video input source.*

☐ To dub or edit from VCR 1 to VCR 2:

VCR 2 must select “line IN.”

Select the VIDEO 1 video input source.*

Note: If you have a Cable box, connect the Cable box and splitter to VCR1 as shown on page 13.

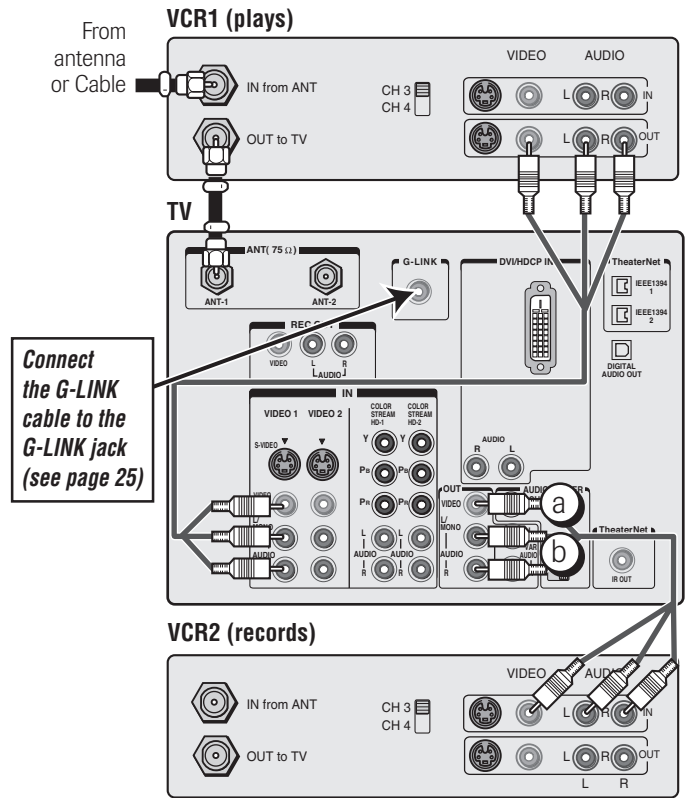

(a) The Video OUT jack does not output the POP picture.

(b) The AUDIO OUT jacks can output the sound of either the Main or POP picture (see “Selecting the AUDIO OUT sound” on page 79).

Connecting a VCR to the REC OUT jacks

If you connect an ATSC antenna or digital Cable service to ANT 1 or ANT 2, or a digital device to one of the IEEE-1394 ports, you can use the REC OUT jacks to record down-converted programs to an analog VCR.

Note:

- The REC OUT jacks output only down-converted signals from an ATSC, digital Cable, or IEEE-1394 source in an analog signal format. The REC OUT jacks will not output a DVI video signal.
- For the best possible audio/video performance, when using an ATSC, digital Cable, or IEEE-1394 source, it is recommended that you use the REC OUT jacks (instead of A/V OUT or VAR AUDIO OUT) to connect to an external A/V system.
- This connection cannot be used for timed recordings.
- Because of copy protection requirements, the REC OUT jacks may be blocked during playback of some IEEE-1394 content.
- See “Using the digital tuner hold” on page 61.

You will need:

- ▶ one set of standard A/V cables
- ▶ one coaxial cable

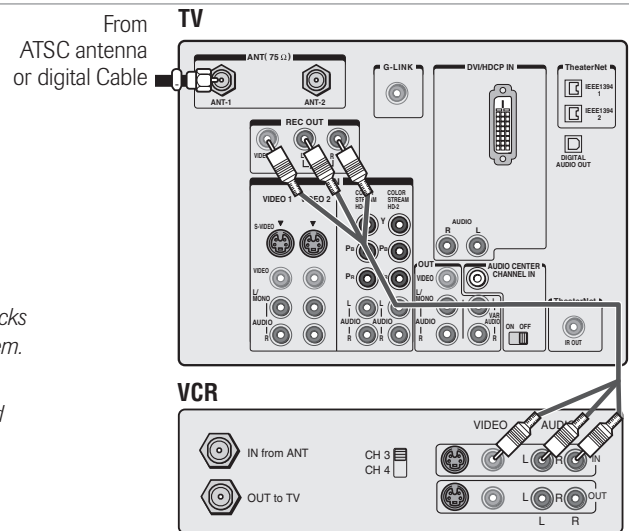

The unauthorized recording, use, distribution, or revision of television programs, videotapes, DVDs, and other materials is prohibited under the Copyright Laws of the United States and other countries, and may subject you to civil and criminal liability.

* To select the video input source, press INPUT on the remote control (see page 61). To program the TV remote control to operate other devices, see pages 30–33.

Connecting a DVI/HDCP device

The DVI/HDCP¹ input on your TV is designed to accept HDCP program material in digital form from EIA/CEA-861-compliant² consumer electronic devices, such as a set-top box or DVD player with a DVI-D digital single-link output connection.³

The DVI/HDCP input is designed for best performance with 1080i high-definition video signals. The DVI/HDCP input also will accept and display 480p, 480i, and 720p signals.

Note: The DVI/HDCP input on this TV is not intended for connection to and should not be used with a PC (personal computer).

You will need:

- ▶ one pair of standard audio cables
- ▶ one DVI-D digital single-link cable
 - For proper operation, the DVI-D cable length should not exceed 3m (9.8 ft). The recommended length is 2m (6.6 ft).

To view the DVI/HDCP device:

Select the DVI video input source.*

To ensure that the DVI/HDCP device is reset properly, it is recommended that you follow these procedures:

- When turning on your electronic components, **turn on the TV first**, and then the DVI/HDCP device.
- When turning off your electronic components, **turn off the DVI/HDCP device first**, and then the TV.

* To select the video input source, press INPUT on the remote control (see page 61). To program the TV remote control to operate other devices, see pages 30–33.

¹ DVI/HDCP = Digital Visual Interface/ High-bandwidth Digital Content Protection.

² EIA/CEA-861 compliance covers the transmission of uncompressed digital video with high-bandwidth digital content protection, which is being standardized for reception of high-definition video signals. Because this is an evolving technology, it is possible that some source devices may not operate properly with the TV. You should confirm that the devices you want to use with the DVI/HDCP input will operate with that input

³ Consult your consumer electronics dealer for availability.

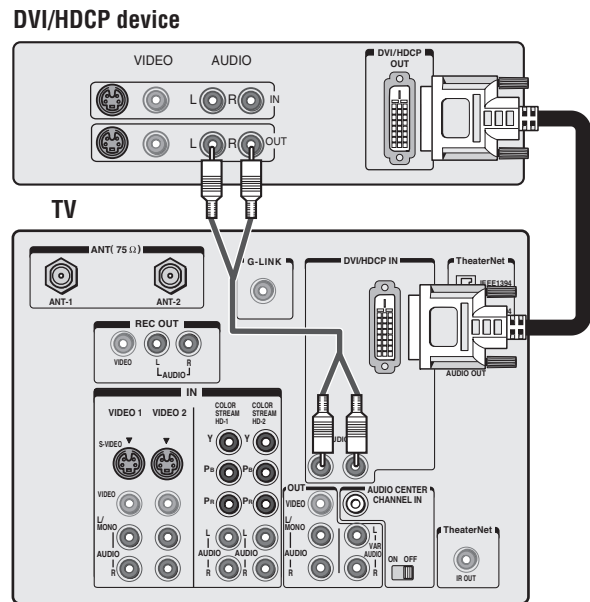

Connecting a camcorder

You will need:

- ▶ one set of standard A/V cables
 - For better picture performance, if your camcorder has S-video, use an S-video cable (plus the audio cables) instead of the standard video cable. Do not connect both an S-video cable and a standard video cable to VIDEO 3 at the same time or the picture performance will be unacceptable.

To view the camcorder video:

Select the VIDEO 3 video input source.*

* To select the video input source, press INPUT on the remote control (see page 61). To program the TV remote control to operate other devices, see pages 30–33.

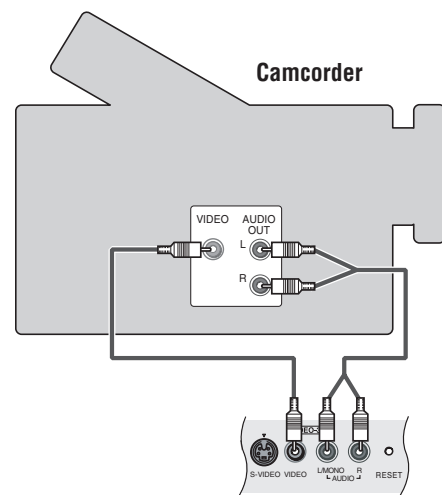

VIDEO 3 inputs on TV front panel

Connecting a digital audio system

The TV's DIGITAL AUDIO OUT jack outputs a  or 2-channel down-mixed PCM (pulse-code modulation) signal for use with an external Dolby Digital decoder or other external audio system with optical audio input.

You will need:

- ▶ one optical audio cable

To control the audio:

Turn on the TV and the digital audio device. Press MENU on the TV's remote control and open the AUDIO menu. Highlight AUDIO SETUP and press ENTER. In the OPTICAL OUTPUT FORMAT field, select either DOLBY DIGITAL or PCM, depending on your device (see "Selecting the optical audio output format" on page 79).

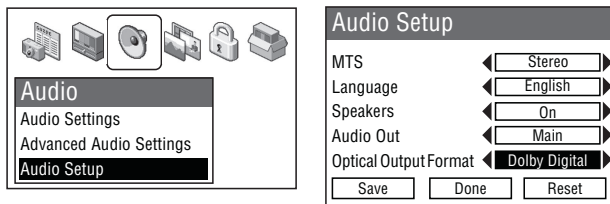

Turn off the TV's built-in speakers (in the same AUDIO SETUP menu, above; also see "Turning off the built-in speakers" on page 79). Or you can use the TV's built-in speakers as center channel speakers by following the connection instructions on page 20.

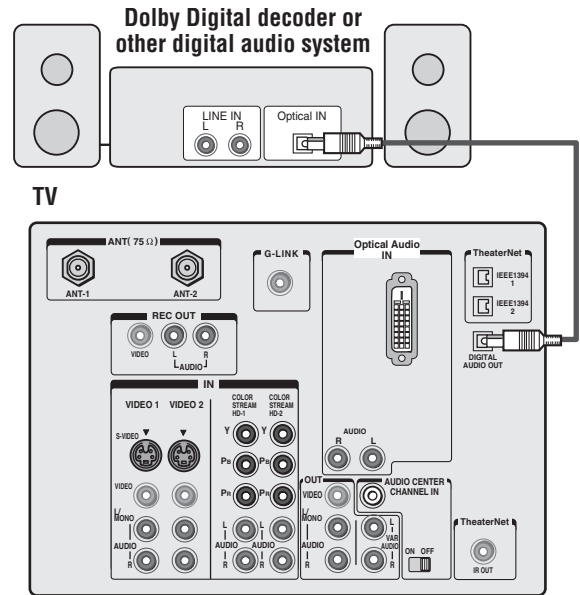

Note:

- Some audio systems may not be compatible with Dolby Digital bitstream signals. Older audio systems that are not compatible with standard optical out signals may not work properly, creating a high noise level, which may damage speakers or headphones.
- The DIGITAL AUDIO OUT jack may not output some digital audio sources because of copy restrictions.

Connecting an analog audio system

This connection allows you to use external speakers with an external audio amplifier to adjust the sound level.

You will need:

- ▶ one pair of standard audio cables

To control the audio:

Turn on the TV and the stereo amplifier. Turn off the TV's built-in speakers (see "Turning off the built-in speakers" on page 79).

Note: To hear sound when using an external audio amplifier, the volume of both the TV and the amplifier must be set to a reasonable listening level.

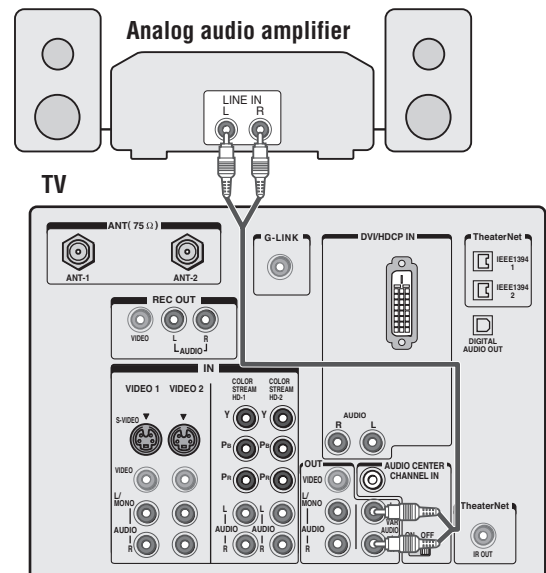

Connecting an A/V receiver

This connection allows you to use an A/V (audio/video) receiver to enhance your TV's sound. If your sound system has Dolby Pro Logic surround sound, you can add to the realism of the sound by using the TV's internal speakers as center channel speakers.

You will need:

- ▶ one set of standard A/V cables
- ▶ one single audio cable for the audio center channel

Note:

- When the Audio Center Channel ON/OFF switch is in the ON position, the TV speakers will function as center channel speakers only.
- To use the TV speakers as normal speakers, set the Audio Center Channel ON/OFF switch to the OFF position.
- Adjust the volume for the center channel speakers using the center level control on your A/V receiver.
- Refer to your A/V receiver's user manual for details about your surround sound system.

A/V receiver

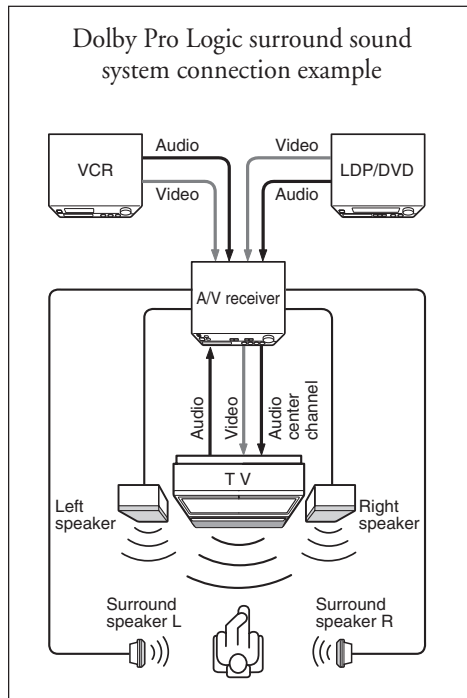
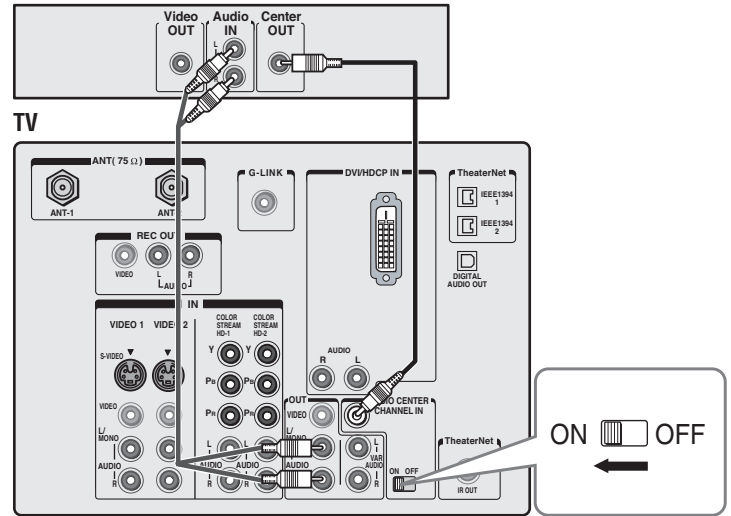

CAUTION—To avoid damaging the TV's speakers:

- Turn off the TV before connecting or disconnecting the Audio Center Channel cable.
- Do not connect from the A/V receiver's amplified center OUT jack to the TV's Audio Center Channel IN jack.

Controlling infrared remote-controlled devices through the TV (IR pass-through)

You can use the TV's IR OUT jack (infrared pass-through) to remotely operate (through the TV) many infrared remote-controlled devices (such as a Toshiba infrared remote-controlled VCR or DVD player) enclosed within an entertainment center or similar cabinet. Without the IR OUT connection, the device typically would need to be visible to operate it remotely.

You will need:

- ▶ one dual-wand IR blaster cable (included with your TV)
- ▶ other audio/video cables as required to connect the device(s) to the TV (see pages 12–20)

To connect the IR blaster cable:

1. Locate the infrared sensor on the front of your device. This sensor is marked on some devices.*
2. Align one of the IR blaster cable's wands about 1 inch away from the infrared sensor on the front of the device and attach it using the enclosed mounting tape. If you have a second device, attach the second wand in a similar manner. (See illustration at right.)

Note: If you do not have a second device, coil the second wand with a rubber band and leave it behind the TV.

3. Plug the IR blaster cable's plug into the TV's IR OUT jack.

To control the device(s):

Point the TV remote control (programmed to operate the device; see pages 47–49) or the device's remote control at the front of the TV and press the button for the desired function. The signal passes from the remote control through the TV to the device via the IR blaster cable.

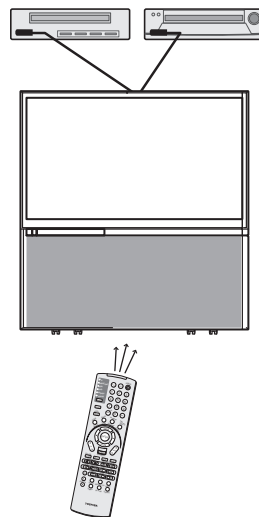

Note:

- If you use the device's remote control to operate the device, you also will need to use the TV's remote control to operate the TV.
- For additional control options, see "TheaterNet on-screen device control" at right.

*If you cannot locate the device's infrared sensor:

1. Turn OFF the device.
2. Starting at the lower left corner of the device, place the end of the device's remote control (with the infrared emitter) so it touches the front of the device and press POWER. (Do not use the TV's remote control for this step.)
3. If the device turns on, the place the remote control touched the device is the location of the sensor.
4. If the device does not turn on, move the remote control slightly to the right and press POWER again.
5. Repeat step 4 until you locate the device's infrared sensor.

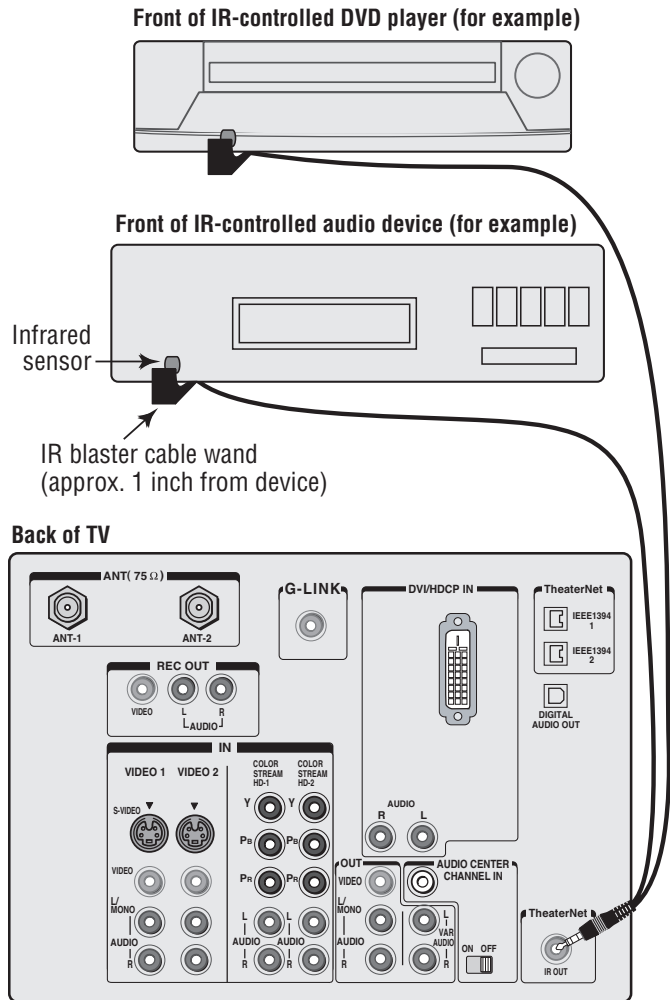

TheaterNet™ on-screen device control

For additional control options for your home theater system, set up the TheaterNet on-screen device control feature. You can use this feature to control many IR remote-controlled devices (and IEEE-1394 devices) using the on-screen control icons.

See pages 45–49 for details on setting up and using TheaterNet.

See pages 22–24 for details on connecting IEEE-1394 devices.

Note: The TheaterNet icon controls are the only device functions available when the icons are on-screen. To access other device functions, close the TheaterNet icon window.

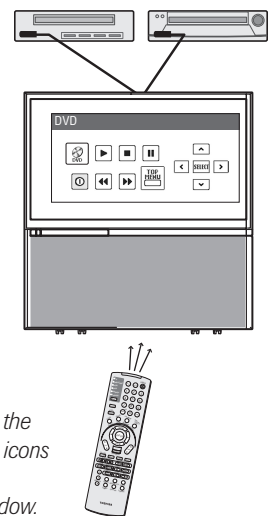

Connecting IEEE-1394 (Firewire™) video devices

You can use the two bi-directional IEEE-1394 ports on the back of your TV to connect digital video devices that meet CEA specifications for IEEE-1394 (also known as Firewire).

Because these ports are bi-directional, they can be used for both playback and recording.

- **This TV is not intended for connection to and should not be used with a PC (personal computer).**
- Because IEEE-1394 is an evolving technology, it is possible that some or all of the connectivity features of a device you connect to the TV through the IEEE-1394 ports may not operate. You should confirm that the devices you desire to use with the IEEE-1394 ports will operate with those ports.
- This TV does not support all possible IEEE-1394 signal types. For information on signals supported by the IEEE-1394 ports, see “Supported signals” at right.
- IEEE-1394 cable carries both audio and video information; no separate audio cables are required for a complete connection.
- See “Using the digital tuner hold” on page 61.

You will need:

- ▶ one (or two) IEEE-1394 cables
- ▶ additional A/V cables if your device is analog-compatible (see “Using analog-compatible IEEE-1394 devices” below).

TV back panel

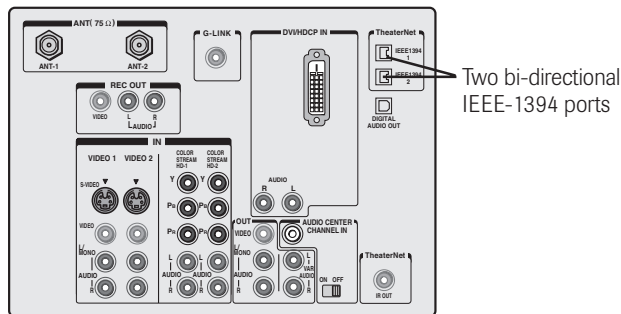

Using analog-compatible IEEE-1394 devices

Some digital IEEE-1394 devices are compatible with analog signals. For example, some D-VHS VCRs can record and play VHS or S-VHS format videos. Such devices allow you to play analog tapes that you rented or recorded, or record analog programs from antenna or Cable TV systems. To use the IEEE-1394 device's analog features, you need to connect the device to the TV using standard A/V cables (or S-video plus audio cables) in addition to connecting the IEEE-1394 cable.

Note: If you have an IEEE-1394 device connected to both digital and analog inputs on the TV, the TV automatically switches between analog and digital modes as needed, when the initial device access is initiated using the TheaterNet button. See page 45 for details on using the TheaterNet feature.

Supported signals

The IEEE-1394 ports support the signals listed below only.

Although incompatible video, audio, and digital control signals cannot be decoded by the TV, these signals may be passed through the IEEE-1394 cable to other compatible devices.

Incompatible devices may not appear in the TheaterNet menu.

• MPEG-2 digital video signals

Other digital video signals—such as DV video—are incompatible and must be decoded by the source device and sent to the TV as analog video (composite or S-video).

• Dolby Digital and MPEG digital audio signals

Other digital audio signals—such as DPM, MP3, and DTS—are incompatible and cannot be decoded by the TV.

• EIA-775 and D-VHS A/V C digital control

Your TV can serve as the control center for many devices that are compatible with EIA-775 or A/V C IEEE-1394 control standards (described below).

The TV cannot control IEEE-1394 devices that use any other control standards.

– **EIA-775 digital control** allows tuning devices (such as Cable boxes) to send simple graphics; however, this standard does not allow the TV to control the Cable box through IEEE-1394.

– **D-VHS A/V C** (audio/video control) provides basic control (such as power, play, stop, rewind, fast-forward, pause, and record), as applicable to the specific device.

Using TheaterNet™ on-screen device control

You can use the TheaterNet feature to control some IEEE-1394 devices using on-screen control icons. See page 45 for details on setting up and using the TheaterNet feature.

Note: If the TheaterNet feature does not control your IEEE-1394, you can try using IR pass-through with the TV's remote control (page 21) or use the device's remote control.

Connecting IEEE-1394 (Firewire™) video devices (continued)

IEEE-1394 device initialization

When you connect a new IEEE-1394 device to the TV and turn it on, the device immediately announces its presence to the TV (and other networked IEEE-1394 devices, if any), and the following device initialization screen automatically appears.

Note: With some devices, it may take up to one minute for this screen to appear.

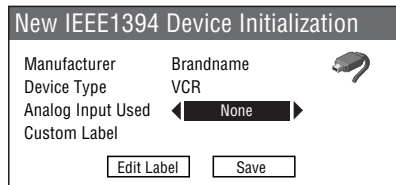

1. If you connected your IEEE-1394 device to an analog input also, use the ▲▼◀▶ buttons to select the input in the ANALOG INPUT USED field; otherwise, leave it set to “None.” (See “Using analog-compatible IEEE-1394 devices” on page 22.)
2. If you want to label the device, highlight EDIT LABEL, press ENTER, and then use the ▲▼◀▶ buttons to input the label.
3. Highlight SAVE and press ENTER to save the information.

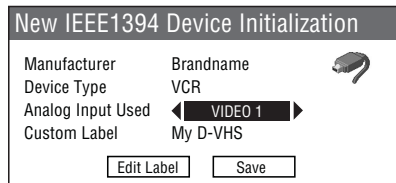

Note:

- The TV may not recognize non-A/V or non-compatible IEEE-1394 devices; however, these devices may still be available to other compatible IEEE-1394 devices on the network.
- You may be able to use the TV's remote control to operate some compatible IEEE-1394 devices. You must first program the remote control to recognize the device (see pages 30–33). If you have an IEEE-1394 Cable box or satellite receiver, you may need to use the remote control that came with the device.

IEEE-1394 device management

The IEEE-1394 device information is saved permanently in the TV's memory. You can edit this device information (for example, to edit the device name, change the analog input information, or delete the device information from the TV's memory if you no longer use that device).

To edit the IEEE-1394 device information:

1. Press MENU and open the SETUP menu.
2. Highlight INSTALLATION and press ENTER. (A new set of INSTALLATION menu icons will appear on-screen, as shown in step 3 below).

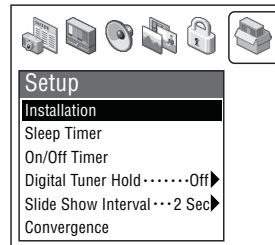

3. Open the DEVICES menu, highlight IEEE-1394 DEVICES, and press ENTER.

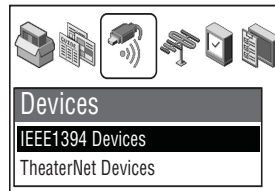

4. Highlight the device you want to edit, and follow the on-screen prompts.

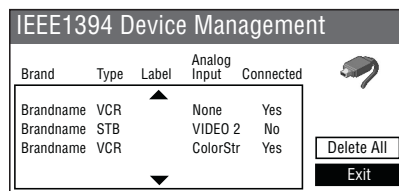

Connecting IEEE-1394 (Firewire™) video devices (continued)

IEEE-1394 device interconnection

IEEE-1394 devices can be interconnected (instead of each device having to be connected to a separate input on the TV) in either of two ways: (1) a device-to-device chain connection or (2) a hub connection.

Chain connection

Connect the first IEEE-1394 device to one of the TV's IEEE-1394 inputs, and then connect each subsequent device to the preceding device in the chain.

- Read the "Important information" at right.
- Devices in the middle of the chain will need two IEEE-1394 ports for this connection to work as illustrated.

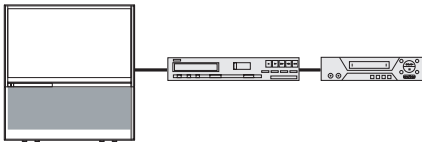

Hub connection

You can connect a chain of IEEE-1394 devices to each of the TV's two IEEE-1394 jacks. The TV will then serve as a hub in your A/V system. Each device can send audio and video information to any other device in the system.

- Read the "Important information" at right.
- Devices in the middle of the chain will need two IEEE-1394 ports for this connection to work as illustrated.

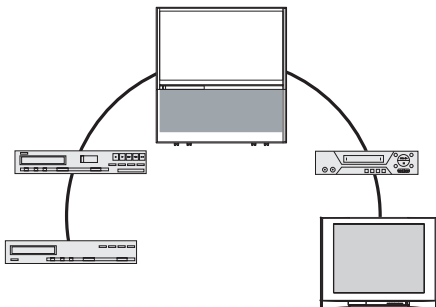

Important information regarding IEEE-1394 device interconnection

- **Do not loop the last device in the chain back to the TV.** If the device chain is looped, the TV may not work properly with the other devices in the chain.
- **Place devices with the slowest communication speed at the end of each chain.** If a device with a slower communication speed is placed ahead of a faster device in the chain, the signal from the slower device will interfere with the signal from the faster device. To determine the communication speed of an IEEE-1394 device, look for an "S" number near the device's IEEE-1394 connector. The higher the "S" number, the faster the device. If your device is not marked with an "S" number, look in the device's user manual or call the device manufacturer's technical support number.
- **If your IEEE-1394 device has a two-position power switch, place the device at the end of the chain or leave the power switch ON at all times.** If the power switch is OFF, it will interfere with signals from devices behind it in the chain.
- **The maximum length for an IEEE-1394 cable between each device is 15 feet.**
- This TV is an IEEE-1394A device. The IEEE-1394B protocol is faster and intended to allow for longer distances between devices and multi-room systems. IEEE-1394A-to-IEEE-1394B converters (available at some electronics suppliers) may allow compatibility of IEEE-1394B devices with your existing IEEE-1394A devices.

G-LINK connection

This connection is necessary to enable the TV Guide On Screen™ system's device control and one-touch recording features.

After you connect your devices to the TV (pages 12–24), you will need to connect the G-LINK cable (either of the dual-wand IR blaster cables included with your TV) from your VCR and Cable box (if applicable) to the G-LINK jack on the TV. This connection is necessary to enable the following features of your TV Guide On Screen™ system:

- If you have a Cable box, you need to connect the G-LINK cable from the Cable box to the G-LINK jack to receive the TV Guide On Screen system's program listings for your Cable service.
- If you have a VCR, you need to connect the G-LINK cable from the VCR to the G-LINK jack to use the TV Guide On Screen system's one-touch recording feature.

To connect to the G-LINK jack:

1. Locate the infrared sensor on the front of your VCR or Cable box. The sensor is marked on some devices.*
2. Align one of the G-LINK (IR blaster) cable's wands about 1 inch away from the infrared sensor on the front of the VCR and attach it using the included mounting tape.

If you have a Cable box, attach the other wand in a similar manner. (See illustration at right.)

Note: If you do not have a Cable box, coil the second wand with a rubber band and leave it behind the TV.

3. Plug the G-LINK (IR blaster) cable's plug into the TV's G-LINK jack.

For details on setting up the TV Guide On Screen system:

See page 36.

For details on using the TV Guide On Screen interactive program guide:

See page 53.

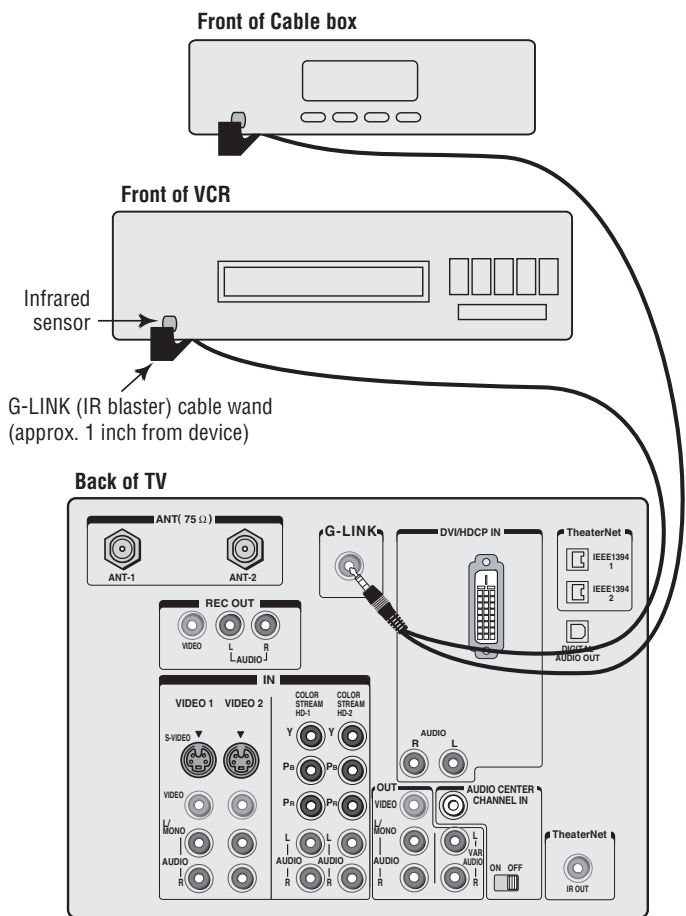

***If you cannot locate the device's infrared sensor:**

1. Turn OFF the device.
2. Starting at the lower left corner of the device, place the end of the device's remote control (with the infrared emitter) so it touches the front of the device and press POWER. (Do not use the TV's remote control for this step.)
3. If the device turns on, the place the remote control touched the device is the location of the sensor.
4. If the device does not turn on, move the remote control slightly to the right and press POWER again.
5. Repeat step 4 until you locate the device's infrared sensor.

3 Using the remote control

Learning about the remote control

The buttons used for operating the TV only are described here. For a complete list of the remote control's functions, see the remote control functional key chart on pages 28–29.

POWER turns the TV on and off

SLEEP accesses the sleep timer (page 82)

LIGHT The first press of the LIGHT button lights the keypad and turns on the Illumination mode. With the Illumination mode on, pressing any other key lights the keypad for 5 seconds (10 seconds if you're in programming mode). Subsequent presses of the LIGHT button toggle between turning the Illumination mode on and off.

Channel Numbers (0–9, 100) directly access channels (page 42)

MODE cycles through the six device modes: TV, CABLE/SAT, VCR, DVD, AUDIO1, and AUDIO2. The mode indicator light will remain lit for a few seconds (page 27).

PIC SIZE cycles through the five pictures sizes: Natural, Theater Wide 1/2/3, and Full (page 64)

THEATER NET accesses the on-screen IR device control icons (page 46)

MENU accesses the menu system (page 35)

GUIDE opens the TV Guide On Screen system (page 53)

INFO provides detailed information on highlighted items in the TV Guide On Screen system (page 56)

BLUE and GREEN buttons select menu-specific functions in the TV Guide On Screen system (page 55)

ENTER activates highlighted items in the main menu system and the TV Guide On Screen system

▲▼◀▶ select or adjust programming menus

FAV accesses the favorite channel search function (page 44)

CH ▲▼ cycles through programmed channels when no menu is on-screen (page 42); functions as page up/down when a menu is on-screen or when the TV Guide On Screen system is open (page 53)

VOL ▲▼ adjusts the volume level

EXIT closes on-screen menus and the TV Guide On Screen system

CH RTN returns to the last viewed channel (page 63)

INPUT selects the video input source (page 61)

RECALL displays TV setting information on-screen (page 83)

MUTE reduces or turns off the sound (page 76)

TV/VCR press to select TV mode to view one program while recording another

SPLIT turns the POP feature on and off (page 68)

POP CH ▲▼ selects the POP (picture-out-picture) channel (page 68)

POP DIRECT CH allows direct access to POP channels (page 68)

FREEZE freezes the main picture in the double-window (page 69)

SWAP switches the main and POP pictures (page 69)

CH SCAN allows access to the programmed channel search function (page 70)

SOURCE selects the POP picture source (page 68)

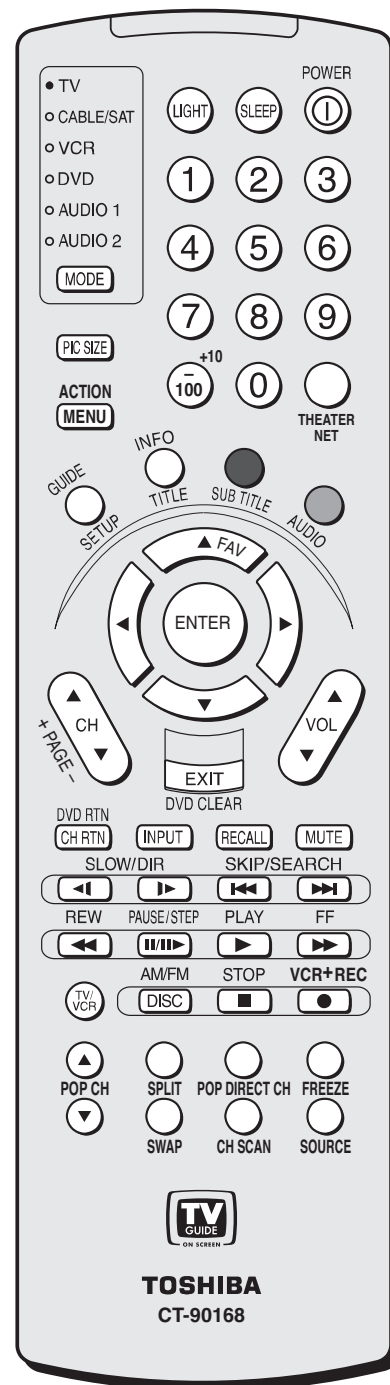

Note:

The error message "Not Available" will appear if you press a key for a function that is not available.

Installing the remote control batteries

To install the remote control batteries:

1. Slide the battery cover off the back of the remote control.

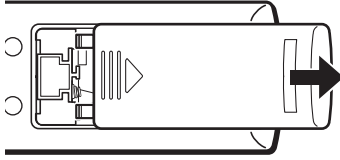

2. Install two “AA” size alkaline batteries. Match the + and – symbols on the batteries to the symbols on the battery compartment.

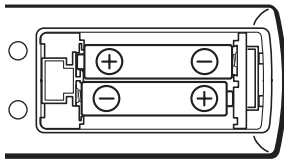

3. Slide the battery cover on to the remote control until the lock snaps.

Caution:

- Dispose of batteries in a designated disposal area. Do not throw batteries into a fire.
- Do not mix battery types or combine used batteries with new ones.
- If the remote control does not operate correctly, or if the operating range becomes reduced, replace both batteries with new ones.
- If the batteries are dead or if you will not use the remote control for a long time, remove the batteries to prevent battery acid from leaking into the battery compartment.

Using the remote control MODE button to control other devices

Your TV remote control has one dedicated TV mode and five programmable multi-brand modes: CABLE/SAT, VCR, DVD, AUDIO 1, and AUDIO 2. The default device modes and programmable device modes are listed below.

Note: The TV remote control is preprogrammed to operate most Toshiba devices. If you own a non-Toshiba device or a Toshiba device that the remote control is not preprogrammed to operate, you will need to program the remote control. See “Programming the remote control to operate your other devices” on page 30.

MODE	Default device mode control (before programming)
TV	Toshiba TV
CABLE/SAT	Toshiba Satellite receiver
VCR	Toshiba VCR
DVD	Toshiba DVD
AUDIO 1	Pioneer Audio receiver
AUDIO 2	Pioneer LD

MODE	Device mode control after programming
TV	Toshiba TV
CABLE/SAT	Multi-brand Cable, Satellite
VCR	Multi-brand VCR, DVD, LD, Cassette
DVD	Multi-brand DVD, VCR, LD, Cassette
AUDIO 1	Multi-brand Audio: Amp., Tuner, Misc.Audio, CD/MD
AUDIO 2	Multi-brand Audio: CD/MD, Amp., Tuner, Misc. Audio

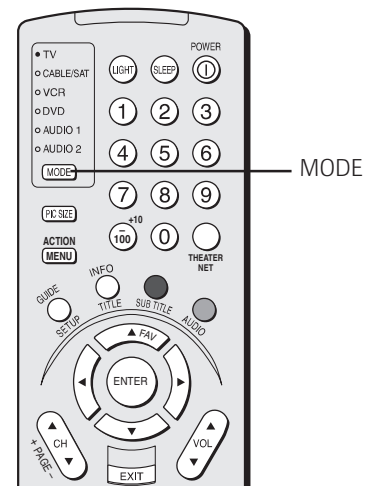

Note:

Although your new TV's remote control includes codes for many devices, it may not include codes for some or all of the features on certain devices you wish to control. If you are unable to program the TV's remote control to operate your device or some of the features on that device, use the device's remote control or the controls on the device.

Remote Control functional key chart

Key Label	Toshiba TV (TV)	Cable (CBL/SAT)	Satellite (CBL/SAT)	VCR	DVD/LD	Receiver (AUDIO)	CD/MD (AUDIO)	Cassette (VCR)
LIGHT	Lights the remote key, and toggles between enabled and disabled Illumination mode.							
SLEEP	Sleep timer	---	---	---	---	---	---	---
POWER	Power	Power	Power	Power	Power	Power	Power	Power
1	Digit 1	Digit 1	Digit 1	Digit 1	Digit 1	AV input 1	Digit 1	Digit 1
2	Digit 2	Digit 2	Digit 2	Digit 2	Digit 2	AV input 2	Digit 2	Digit 2
3	Digit 3	Digit 3	Digit 3	Digit 3	Digit 3	AV input 3	Digit 3	Digit 3
4	Digit 4	Digit 4	Digit 4	Digit 4	Digit 4	AV input 4	Digit 4	Digit 4
5	Digit 5	Digit 5	Digit 5	Digit 5	Digit 5	CD	Digit 5	Digit 5
6	Digit 6	Digit 6	Digit 6	Digit 6	Digit 6	Tuner	Digit 6	Digit 6
MODE	Remote control device mode selection							
PIC SIZE	Selects the image shape.	← TV	← TV	← TV	← TV	← TV	← TV	← TV
7	Digit 7	Digit 7	Digit 7	Digit 7	Digit 7	Phono	Digit 7	Digit 7
8	Digit 8	Digit 8	Digit 8	Digit 8	Digit 8	Cassette	Digit 8	Digit 8
9	Digit 9	Digit 9	Digit 9	Digit 9	Digit 9	Aux	Digit 9	Digit 9
100/-	- (Digital separator)	---	- (Sub CH)	100	+10	---	---	---
0	Digit 0	Digit 0	Digit 0	Digit 0	Digit 0	---	Digit 0, 10	---
GUIDE/SETUP	Guide	---	Guide	---	DVD setup	---	---	---
INFO/TITLE	Guide Info	---	INFO	---	TITLE= Top menu	---	---	---
(BLUE) / SUBTITLE	Blue Guide Key	---	---	---	Subtitle	---	---	---
(GREEN) / AUDIO	Green Guide Key	---	---	---	Audio	---	---	---
THEATERNET	TheaterNet	---	---	---	---	---	---	---
MENU/ ACTION	Menu/ Guide Menu	---	Action, Menu	---	Menu	---	---	---
▲ (FAV)	Menu select up (FAV)	---	Menu select up	---	Menu select up	---	---	---
▼	Menu select down	---	Menu select down	---	Menu select down	---	---	---
◀▶	Menu select left/right	---	Menu select left/right	---	Menu select left/right	---	---	---
ENTER	Enter	---	Select	---	Enter	---	---	---
VOL ▲▼	Volume up/down*	Volume up/down*	Volume up/down*	Volume up/down*	Volume up/down*	Volume up/down*	Volume up/down*	Volume up/down*
EXIT/ DVD CLEAR	Exit	---	Exit	---	DVD clear	---	---	---
CH ▲▼ PAGE +/-	Channel up/down	Channel up/down	Channel up/down	Channel up/down	---	Channel up/down	---	---
INPUT	TV/Video select	← TV	← TV	VCR input	← TV	---	← TV	← TV
MUTE	Sound mute*	Sound mute*	Sound mute*	Sound mute*	Sound mute*	Sound mute*	Sound mute*	Sound mute*
RECALL	On-screen display	---	---	On-screen display	On-screen display	---	---	---

Remote Control functional key chart (continued)

Key Label	Toshiba TV (TV)	Cable (CBL/SAT)	Satellite (CBL/SAT)	VCR	DVD/LD	Receiver (AUDIO)	CD/MD (AUDIO)	Cassette (VCR)
CH RTN/ DVD RTN	Previous channel	Previous channel	Previous channel	---	DVD return	---	---	---
SLOW/ DIR	▶ ◀	---	---	Slow FWD ---	Slow FWD Slow REV	---	---	---
SKIP/ SEARCH	▶ ◀	---	---	---	Skip FWD Skip REV	---	Skip FWD Skip REV	---
REW	VCR →	VCR →	VCR →	Rewind	Rewind	---	Rewind	Rewind
PAUSE/STEP	VCR →	VCR →	VCR →	Pause	Pause	---	Pause	Pause
PLAY	VCR →	VCR →	VCR →	Play	Play	---	Play	Play
FF	VCR →	VCR →	VCR →	Fast FWD	Fast FWD	---	Fast FWD	Fast FWD
TV/VCR	VCR →	---	TV/SAT	TV/VCR	---	---	---	Reverse
AM/FM DISC	---	---	---	---	Disc shift	AM/FM	Disc shift	Deck side A/B switch
STOP	VCR →	VCR →	VCR →	Stop	Stop	---	Stop	Stop
REC/VCR+	VCR+/REC	---	---	Record	---	---	---	Record
POP CH ▲▼	POP channel up/down	← TV	← TV	← TV	← TV	← TV	← TV	← TV
SPLIT	POP Split	← TV	← TV	← TV	← TV	← TV	← TV	← TV
POP DIRECT CH	POP Direct ch	← TV	← TV	← TV	← TV	← TV	← TV	← TV
FREEZE	POP Freeze	← TV	← TV	← TV	← TV	← TV	← TV	← TV
SWAP	POP Swap	← TV	← TV	← TV	← TV	← TV	← TV	← TV
CH SCAN	POP Ch scan	← TV	← TV	← TV	← TV	← TV	← TV	← TV
SOURCE	POP Source	← TV	← TV	← TV	← TV	← TV	← TV	← TV

Notes:

- “---” will send nothing.
- “← TV” will jump to TV.
- “→VCR” will jump to last active VCR or DVD. Active VCR/DVD is defined as the mode that remains for a minimum of 5 seconds, or if a key is pressed in that mode.

1) Backlight key is toggle. Does not send IR.

2) Volume will punch thru to TV by default. When the volume is unlocked, all the devices will have their own volume if their ID has volume data. The AUD (Receiver, CD) Modes will have its own volume if Volume lock is done to TV, CBL/SAT, VCR, or DVD. See “Using the volume lock feature” on page 31.

3) Will punch thru to last active VCR or DVD. Active VCR/DVD is defined as the Mode that remains for a minimum of 5 Seconds, or if a key is pressed in that Mode.

Programming the remote control to operate your other devices

Device code setup

1. Refer to the multi-brand remote control device code table on pages 32–33 to find the code for the brand of your device.
If more than one code is listed, try each one separately until you find the one that works.
2. Press MODE until the Mode indicator for the device (CABLE/SAT, VCR, DVD, AUDIO 1, AUDIO 2) lights up.
3. While holding down the RECALL button, press the Channel Number buttons to enter the four-digit code for your brand of device. If a valid code is entered, the mode indicator will blink twice. If an invalid code is entered, the mode indicator will blink one long blink.
4. Point the remote control at the device and press POWER to test the code.

If the device responds to the remote control:

You have entered the correct code.

If the device does not respond to the remote control:

You may have entered the wrong code. Repeat steps 3 and 4 using another code.

Note: In addition to POWER, confirm that all necessary keys on the TV remote control operate your device. If some keys are not operational, repeat the device code setup using another code (if other codes are listed for your device). If, after trying all listed codes, the necessary keys do not operate your device, use the device's original remote control.

5. Press MODE to select the TV mode to control the TV.

Note:

- Although the TV remote control includes codes for many devices, it may not include codes for some or all of the features on certain devices you wish to control. If you are unable to program the TV remote control to operate your device or some of the features on that device, use the device's remote control or the controls on the device.
- Each time you change the batteries you will need to reprogram the remote control.
- Some newer VCRs respond to either of two codes. These VCRs have a switch labeled "VCR1/VCR2." If your VCR has this kind of switch and does not respond to the codes for your VCR brand, set the switch to the other position ("VCR1" or "VCR2") and reprogram the remote control.

Searching and sampling the code of a device (8500)

If you do not know the device code for a particular device, you can cycle the remote control through the available codes for that device mode and sample the functions to find the code that operates the target device. The keys available to be sampled, provided they are applicable to that mode, are POWER, 1, VOL ▲, CH ▲, and PLAY. Invalid keys will be ignored while in program mode.

To cycle through each available device code and sample its functions:

1. Press MODE to select the mode you want to set up.
2. While holding down RECALL, press 8 – 5 – 0 – 0. The remote control will enter program mode.
3. Point the remote control at the target device and press POWER (or other function buttons that are available to be sampled).

4. *If the device responds to the remote control:*

Press RECALL to store the device code. The mode indicator will blink twice and the remote control will exit the program mode.

If the device does not respond to the remote control:

Press ▲, and then press POWER.

Repeat this step until the device responds to the remote control, and then press RECALL.

Note: When a search cycle is completed, the mode indicator will blink three times. The remote control will begin to cycle through the available codes again. If no key is pressed within 10 seconds while programming, the remote control will exit the program mode and return to the previous code.

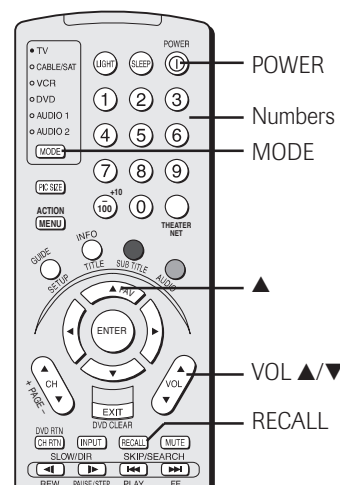

Programming the remote control to operate your other devices (continued)

Using the volume lock feature (8000)

For the TV, CABLE/SAT, VCR, and DVD modes, the volume controls (VOL ▲/▼ and MUTE) can be locked to the selected device mode. This feature does not apply to the AUDIO 1 and AUDIO 2 modes.

To lock the volume controls to always control the CABLE/SAT device volume (for example):

1. Repeatedly press MODE to select CABLE/SAT mode.
2. While holding down the RECALL button, press 8 – 0 – 0 – 0.
3. Press VOL ▲.

The CABLE/SAT mode light will blink two times (locked).

To reset the volume controls to the original device mode:

1. While holding down RECALL, press 8 – 0 – 0 – 0.
2. Press VOL ▼.

The mode light will blink four times (unlocked).

Operational feature reset (8900)

This feature clears all setup features not related to “Device code set up” and resets the Volume Lock to “TV.”

To reset the features:

While holding down the RECALL button, press 8 – 9 – 0 – 0. The Mode indicator will blink two times, and then pause and blink two more times.

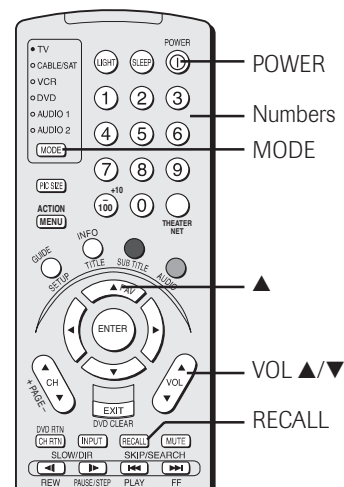

Multi-brand remote control device codes

VCRs		VCRs (cont.)		Cable boxes	
Brand	Code	Brand	Code	Brand	Code
ADMIRAL	0135	PENTAX	0100, 0111, 0145	ABC	1124
AIWA	0127, 0132, 0181, 0129, 0114, 0115, 0116	PHILCO	0131, 0124, 0127, 0123, 0126, 0120, 0143	ARCHER	1132, 1125
AKAI	0139, 0111	PHILIPS	0131, 0123, 0124, 0173	CABLEVIEW	1105, 1132
AUDIO DYNAMIC	0105, 0113	PIONEER	0123	CITIZEN	1122, 1105
BELL&HOWELL	0120, 0126, 0180	PROSCAN	0145, 0100, 0123, 0124, 0131, 0146, 0101, 0102, 0133, 0174	CURTIS	1112, 1113
BROKSONIC	0123, 0125	QUASAR	0121, 0122, 0123, 0124	DIAMOND	1124, 1132, 1125
CANON	0143	RADIO SHACK	0133, 0124, 0105, 0136, 0109, 0140, 0127	EAGLE	1129
CCE	0106	RCA	0133, 0145, 0100, 0123, 0124, 0131, 0146, 0101, 0102, 0170, 0172, 0174, 0176, 0183	EASTERN	1134
CITIZEN	0105, 0129, 0106	REALISTIC	0124, 0105, 0136, 0109, 0140, 0127	GCBRAND	1132, 1105
CRAIG	0145, 0124, 0127	SAMSUNG	0137, 0102, 0104, 0133	GEMINI	1122, 1143
CURTIS MATHES	0143, 0101, 0124, 0175	SAMTRON	0163	G.I./JERROLD	1119, 1124, 1125, 1126, 1127, 1120, 1121, 1122, 1111, 1123, 1152
DAEWOO	0139, 0110, 0111	SANSUI	0139, 0126, 0120, 0152	HAMLIN	1140, 1141, 1142,
DBX	0145	SANYO	0105, 0109, 0113	HITACHI	1145, 1118, 1112
DIMENSIA	0143, 0126, 0119, 0103, 0125, 0142, 0120, 0118	SCOTT	0101, 0102, 0104, 0109, 0138, 0140, 0147, 0148, 0126, 0120	MACOM	1103, 1124
EMERSON	0105, 0108, 0109, 0107, 0113, 0165	SEARS	0105, 0106, 0107, 0108, 0100	MAGNAVOX	1103, 1104, 1105, 1108
FISHER	0127, 0126, 0120, 0134	SHARP	0135, 0136, 0167, 0162	MEMOREX	1133
FUNAI	0133, 0145, 0124	SHINTOM	0117	MOVIE TIME	1130
GE	0137, 0151, 0163, 0149, 0150, 0182	SIGNATURE 2000	0127, 0135	OAK	1132, 1105
GO VIDEO	0106	SINGER	0117	PANASONIC	1139, 1137, 1102
GOLDSTAR	0170, 0171, 0168, 0134, 0156	SONY	0128, 0129, 0130, 0153, 0154, 0155	PHILIPS	1109, 1110, 1114, 1151, 1153
GRADIENTE	0123, 0145, 0100, 0127, 00168	SV2000	0127	PIONEER	1128, 1129, 1130, 1106, 1107, 1150, 1131
HITACHI	0123, 0145, 0100, 0127, 00168	SYLVANIA	0131, 0123, 0124, 0127, 0178	PULSAR	1101, 1116
INSTANT REPLAY	0124, 0123	SYMPHONIC	0127, 0168, 0177	PUSER	1105, 1132
JENSEN	0139	TASHIRO	0106	RCA	1132
JVC	0139, 0110, 0111, 0134, 0157, 0158, 0184, 0185	TATUNG	0139, 0110, 0111	REALISTIC	1115
KENWOOD	0139, 0110, 0106, 0111	TEAC	0139, 0110, 0127, 0111	REGAL	1132
LG	0159	TECHNICS	0121, 0122, 0123, 0124	REGENCY	1112, 1118, 1140, 1141, 1142, 1145, 1149
LXI	0127, 0106, 0100, 0107, 0108, 0105, 0109	TEKNICA	0124, 0127, 0112	REMBRANT	1134
MAGNAVOX	0131, 0123, 0124, 0173	THOMSON	0179, 0183	SAMSUNG	1137, 1132, 1105, 1138
MARANTZ	0139, 0110, 0111	TOSHIBA	0101, 0146, 0166, 0160	S.A.	1105
MARTA	0106	VECTOR RESEARCH	0111	SLMARK	1111, 1112, 1113
MEMOREX	0124, 0109	WARDS	0135, 0136, 0109, 0144, 0106	SPRUCER	1105, 1101
MGA	0138, 0140, 0147, 0148, 0141, 0142	YAMAHA	0105, 0139, 0110, 0111	STARGATE	1105, 1110
MINOLTA	0100, 0145	ZENITH	0144, 0106, 0169, 0180	TELECAPTION	1132, 1105
MITSUBISHI	0138, 0140, 0147, 0148, 0141, 0142, 0161, 0164			TELEVIEW	1148
MULTITECH	0147, 0127, 0104			TEXSCAN	1101, 1105
NEC	0139, 0110, 0111, 0134			TOCOM	1144
OLYMPIC	0124, 0123			TOSHIBA	1135, 1136, 1147
OPTIMUS	0128, 0121, 0135, 0106			UNIKA	1104, 1146
ORION	0126, 0120, 0132			UNIVERSAL	1132, 1125
PANASONIC	0123, 0124, 0121, 0122			VIDEOWAY	1122, 1132
PENNEY	0124, 0100, 0145, 0105, 0139, 0110, 0111			VIEWSSTAR	1106
				ZENITH	1129, 1130
				ZENITH/DRAKE	1117, 1100
				SATELLITE	1100

Multi-brand remote control device codes (continued)

CD players

Brand	Code
ADMIRAL	6126
AIWA	6133, 6135
CARVER	6129
DENON	6142, 6151
EMERSON	6139
FISHER	6105, 6106
GARRARD	6117
HARMAN KARDON	6120, 6121, 6123, 6119
HITACHI	6107
JENSEN	6134
JVC	6140, 6141, 6145, 6148, 6151
KARDON	6123
KENWOOD	6100, 6101, 6111, 6145
LXI	6136
MAGNAVOX	6129, 6132
MARANTZ	6129
MCNTOSH	6121
NAKAMICHI	6110
ONKYO	6114, 6115
OPTIMUS	6108, 6118, 6120, 6122
PANASONIC	6124, 6125, 6127, 6150
PHILIPS	6129, 6130, 6149
PIONEER	6108
QUASAR	6125, 6127, 6124
RCA	6147, 6137, 6138, 6131, 6152
SANSUI	6110, 6146, 6113
SANYO	6105
SCOTT	6110, 6146
SHARP	6142, 6143
SHERWOOD	6120
SONY	6128
SOUNDE-SIGH	6144
TEAC	6112, 6116, 6118
TECHNICS	6127, 6124, 6125
VICTOR	6140, 6141, 6145
YAMAHA	6102, 6103, 6104

Receivers

Brand	Code
ADMIRAL	4120
AIWA	4125, 4126, 4146
DENON	4134, 4135, 4136, 4143
FISHER	4104
GARRARD	4113
HARMAN KARDON	4115, 4123, 4145
JENSEN	4129
JVC	4132, 4133, 4140, 4144
KENWOOD	4100, 4108, 4141, 4142, 4147
MAGNAVOX	4127, 4128
MARANTZ	4124
MCNTOSH	4116
MITSUBISHI	4148
NAKAMICHI	4106, 4117
ONKYO	4109, 4114
OPTIMUS	4103, 4127, 4131, 4130

Receivers (cont.)

Brand	Code
PANASONIC	4119, 4118, 4121
PHILIPS	4123
PIONEER	4105, 4107, 4150
QUASAR	4119, 4118, 4121
RCA	4103, 4105, 4127, 4131, 4130, 4149
SANSUI	4103, 4111, 4139
SHARP	4134, 4137
SONY	4122
SOUNDE-SIGH	4138
TEAC	4112, 4113, 4111, 4110
TECHNICS	4121, 4118, 4119
VICTOR	4132, 4133
YAMAHA	4101, 4102

Cassette players

Brand	Code
AIWA	7123, 7124, 7125
DENON	7131
FISHER	7103
JENSEN	7114
JVC	7129, 7130, 7132, 7133
KENWOOD	7100, 7107
MARANTZ	7102
NAKAMICHI	7105
ONKYO	7108, 7109, 7113
PANASONIC	7116, 7118
PHILIPS	7122, 7121
PIONEER	7104, 7106
RCA	7126, 7127, 7128, 7134, 7135
SANSUI	7105, 7110, 7112
SHARP	7131
SONY	7119, 7120
TEAC	7110, 7111, 7115
TECHNICS	7116, 7118, 7117
YAMAHA	7101, 7102

Laser disks

Brand	Code
DENON	5114
HITACHI	5100
KENWOOD	5102, 5103
MAGNAVOX	5101
MARANTZ	5114
MITSUBISHI	5114, 5118, 5119
NEC	5114
PANASONIC	5104, 5105, 5106, 5115
PHILIPS	5111
PIONEER	5114
PROSCAN	5114
QUASAR	5104, 5105, 5106, 5115
RCA	5114
SAMSUNG	5112
SANYO	5114, 5117
SHARP	5113, 5116
SONY	5107, 5108, 5109, 5110
TEAC	5114
TOSHIBA	5114
YAMAHA	5101

DVD players

Brand	Code
AIWA	3123
APEX	3120
DENON	3100, 3117
FERGUSON	3101
HITACHI	3111
JVC	3109
KENWOOD	3115, 3129
KONKA	3119
MITSUBISHI	3105
NORDMENDE	3101
ONKYO	3121
ORITRON	3124
PANASONIC	3100
PHILIPS	3103, 3116
PIONEER	3102
RAITE	3113
RCA	3101, 3106
SABA	3101
SAMPO	3114
SAMSUNG	3110
SHARP	3108
SILVANIA	3132, 3118
SMC	3125
SONY	3104, 3126, 3127, 3128
TECHNICS	3100
THOMSON	3101
TOSHIBA	3103
WAVE	3122
YAMAHA	3100, 3130
ZENITH	3107, 3112
VIALTA	3131
FUNAI	3132, 3118

Satellite receivers

Brand	Code
DISH	2105, 2115, 2116,
NETWORK(Echostar)	2117
ECHOSTAR	2105
EXPRESS VU	2105, 2115
G.E.	2106
G.I.(GENERAL INSTRUMENT)	2108
GRADIENTE	2114
HITACHI	2103, 2111, 2112
HNS(Hughes)	2103
MAGNAVOX	2101, 2102
PANASONIC	2104
PHILIPS	2101, 2102, 2118
PRIMESTAR	2108
PROSCAN	2106, 2109, 2110, 2113
RCA	2106, 2109, 2110, 2113
SONY	2107
STAR CHOICE	2103, 2108
TOSHIBA	2100, 2103, 2119, 2120, 2121, 2122, 2123, 2124, 2125
UNIDEN	2101, 2102

4 Menu layout and navigation

The illustrations below and on the next page provide a quick overview of your TV's menu system.

Main menu layout

To open the main menus (illustrated below), press MENU on the remote control or TV front panel.

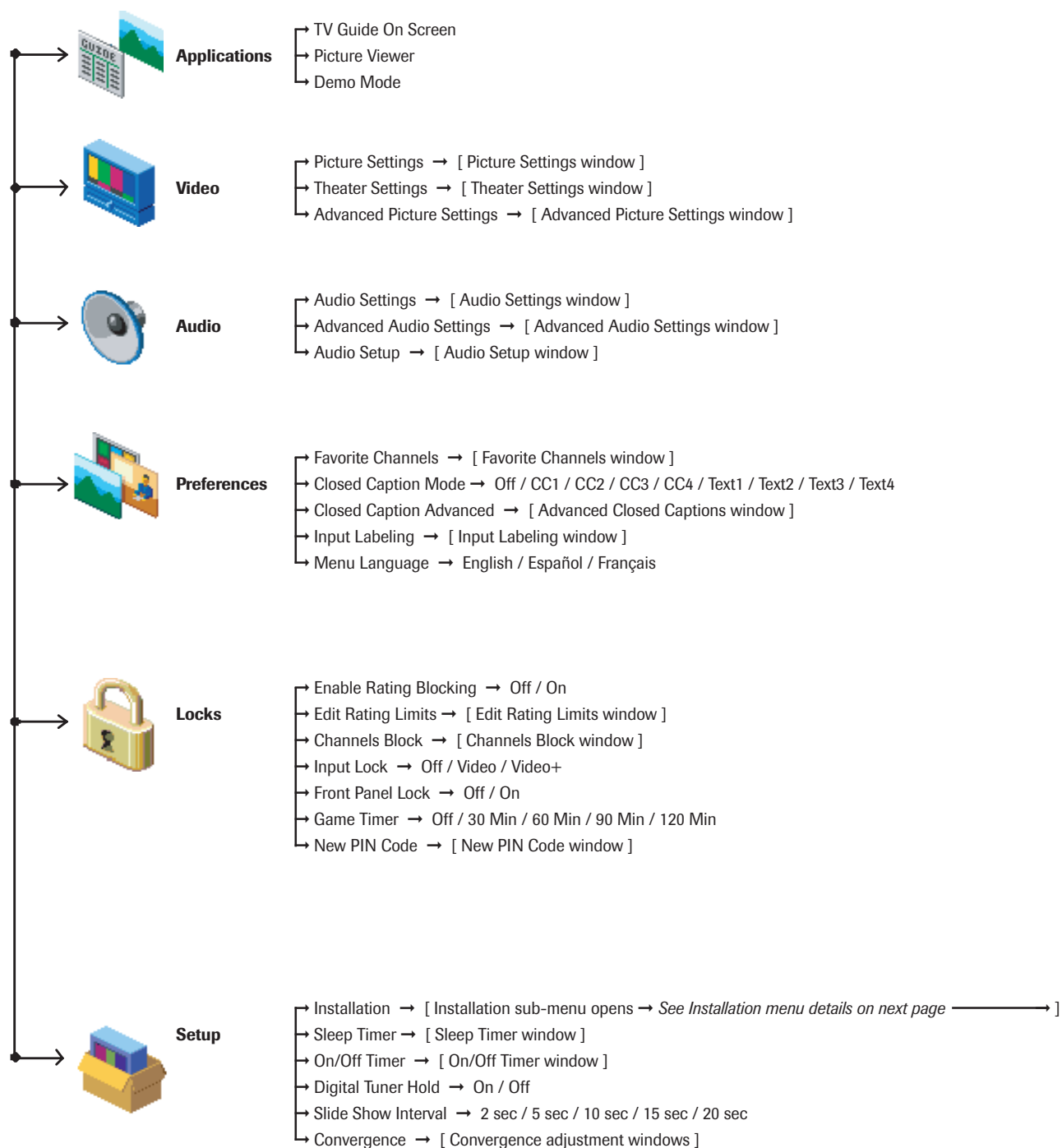

Setup / Installation menu layout (continued)

To open the INSTALLATION menu (illustrated below): press MENU on the remote control or TV front panel, open the SETUP menu, select INSTALLATION, and press ENTER.

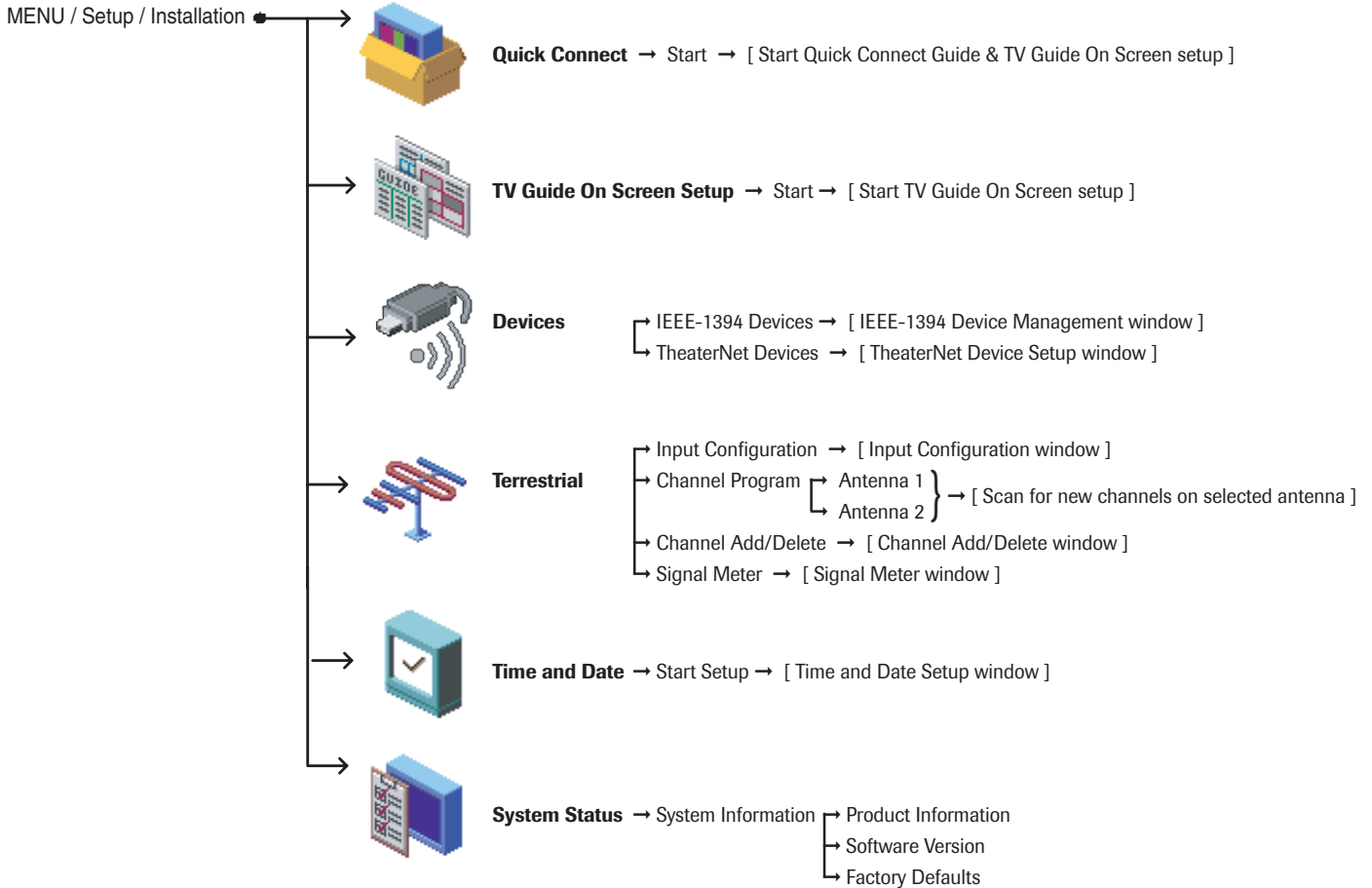

Navigating the menu system

You can use the buttons on the remote control or TV front panel to access and navigate your TV's on-screen menu system.

- Press MENU to open the menu system.
- Use the up/down/left/right arrow buttons (▲▼◀▶) on the remote control or TV front panel to move in the corresponding direction in a menu.
- Press ENTER to save your menu settings or select a highlighted item. (A highlighted menu item appears in a different color in the menu.)
- All menus close automatically if you do not make a selection within 60 seconds. The exceptions to this are the Quick Connect guide menus, which close automatically after 15 minutes, and the signal meter menu, which closes automatically after 30 minutes.
- To close a menu instantly, press EXIT.

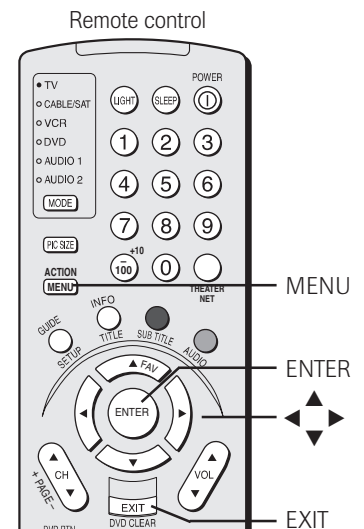
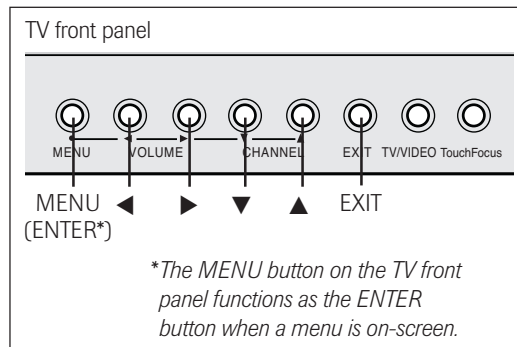

5 Quick Connect Guide & TV Guide On Screen™ setup

This section includes instructions on using the Quick Connect Guide to assist you in configuring the following basic settings for your TV:

- Choosing your preferred language (English, French, or Spanish) for on-screen menus. (See page 41 for details on this feature.)
- Setting up the TV Guide On Screen™ interactive program guide. (See Chapter 7 for details on this feature.)

- Configuring the antenna input sources. (See page 41 for details on this feature.)
- Automatically programming channels into the TV's channel memory (See page 42 for details on this feature.)
- Choosing your preferred picture mode (See page 72 for details on this feature.)

Note: Review "Navigating the menu system" on the previous page.

Starting the Quick Connect Guide assisted setup

The Quick Connect Guide automatically starts the first time the TV is turned on.

Note: If you have not already connected your devices and cables to your TV, turn off your TV, unplug the power cord, and connect your devices according to the applicable connection diagram in Section 2. If you turned on the TV before connecting your devices and the Quick Connect Guide assisted setup already began, you will have to manually restart the Quick Connect Guide (see below) after you connect your devices.

If this is the first time you have turned on your TV and the Quick Connect Guide is already on-screen, start at "Selecting the menu language" at right.

If you change your TV's input source or connections, you also can manually start the Quick Connect Guide to assist you in updating your TV's settings. To do this, start at "Manually starting the Quick Connect Guide assisted setup" below.

Note: To stop the Quick Connect Guide, press EXIT or turn off the TV.

Manually starting the Quick Connect Guide assisted setup

1. Press MENU and open the SETUP menu.
2. Highlight INSTALLATION and press ENTER. (A new set of INSTALLATION menu icons will appear on-screen, as shown in step 3.)

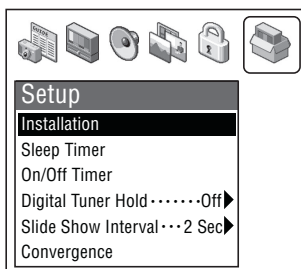

3. Open the QUICK CONNECT menu, highlight START, and then press ENTER.

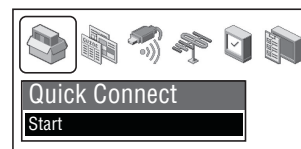

If you already set up the TV Guide On Screen system, go to page 40.

Selecting the menu language

1. Press ▲▼◀▶ to highlight the language you want to use for on-screen menus and messages (English, Español, or Français), and then press ENTER.

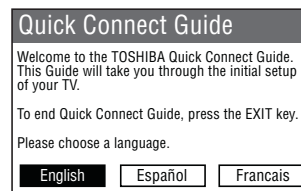

2. Press ENTER to continue.

The TV Guide On Screen setup begins.

(Continued on next page)

Setting up the TV Guide On Screen system

Note: This is a continuation of the Quick Connect Guide assisted setup from the previous page.

If you are not using the Quick Connect Guide assisted setup and want to manually start the TV Guide On Screen system setup process:

- a) Press **MENU** and open the **SETUP** menu.
- b) Highlight **INSTALLATION** and press **ENTER**. (A new set of **INSTALLATION** menu icons will appear on-screen.)
- c) Open the **TV GUIDE ON SCREEN SETUP** menu, highlight **START**, and press **ENTER**.
- d) Follow the steps below.

1. The following screen opens. Press **ENTER** to continue.

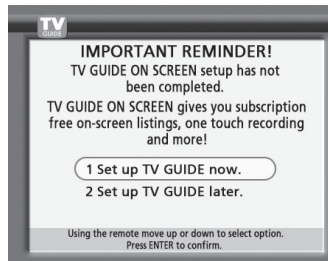

2. The following screen opens. Press **ENTER** to continue.

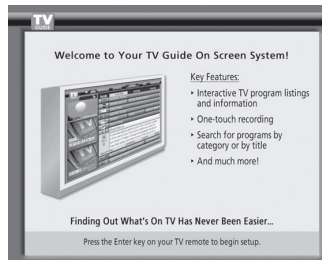

3. The following screen opens. Press **ENTER** to continue.

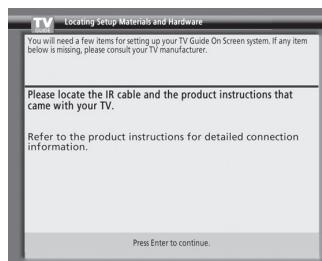

Configuring the location of your TV

1. Select the TV location (USA or Canada).

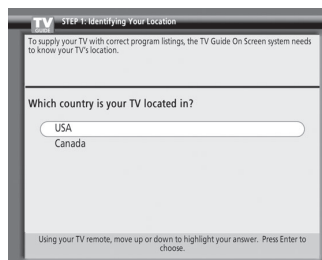

2. Enter the ZIP code (U.S.A.) or postal code (Canada) for your location (use the Number buttons on the remote control for numbers and the **▲▼** buttons for letters), and then press **ENTER**.

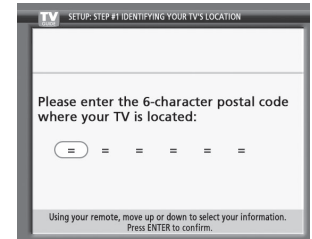
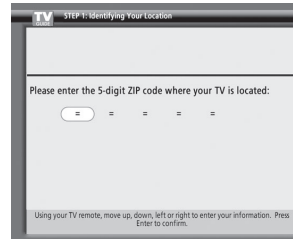

Configuring your Cable setup

1. Do you have Cable service? Select **YES** or **NO**, and then press **ENTER**.

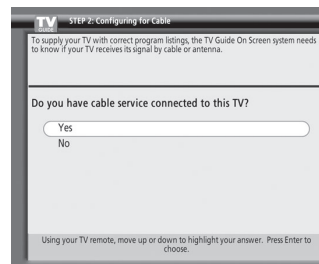

2. Do you have a Cable box connected? Select **YES** or **NO**, and then press **ENTER**. (If you select **NO**, skip to "Configuring your VCR setup" on the next page.)

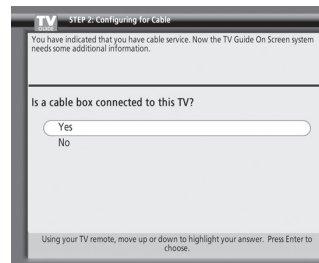

3. Select the channel your TV is tuned to when using your cable box, and then press **ENTER**.

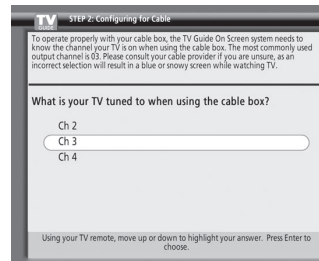

Setting up the TV Guide On Screen system (continued)

4. Read the on-screen information about the Cable box to G-LINK connection, and then press ENTER.

For G-LINK connection details, see page 25.

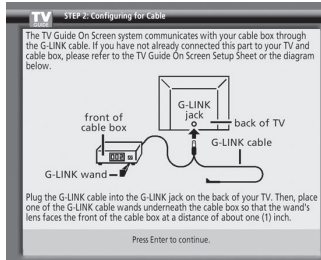

5. Highlight your Cable box brand, and then press ENTER.

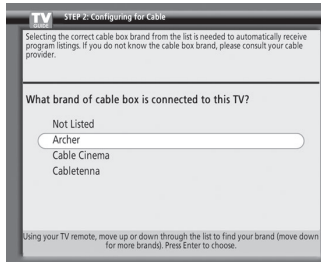

Cable box code testing

1. To allow the TV Guide On Screen system to find the correct code for your brand of Cable box, tune your Cable box to channel 02, leave the Cable box and TV ON, and then press ENTER.

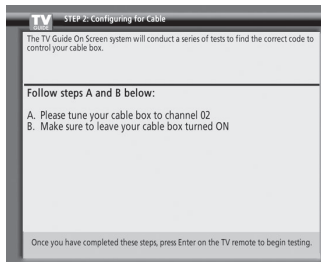

The TV Guide On Screen system will test the code for the brand of Cable box you selected. Do not press any keys on the TV, remote control, or Cable box until the testing process is done.

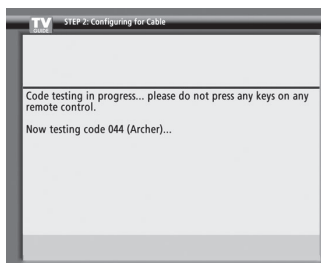

2. When testing is done, if your Cable box tuned itself to channel 09, select YES and press ENTER. Go to "Configuring your VCR setup" below.

If your Cable box did not tune itself to channel 09 and you want to test the same code again, select TEST THIS CODE AGAIN and press ENTER.

If your Cable box did not tune itself to channel 09 and you want the Guide to search for the correct code, select NO and press ENTER. Go to step 3.

3. If the correct code is not found, the following screens appear, with helpful hints for finding the code.

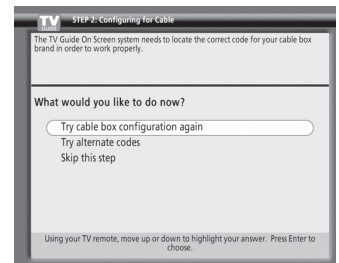
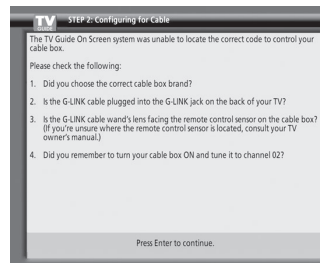

Configuring your VCR setup

1. Do you have a VCR? Select YES or NO, and then press ENTER.

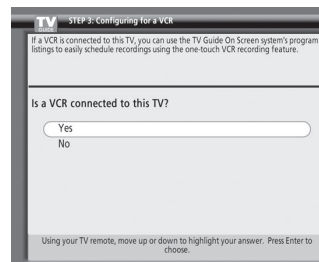

2. Read the on-screen information about the VCR to G-LINK connection, and then press ENTER to continue.

For G-LINK connection details, see page 25.

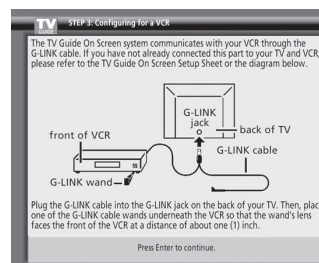

(Continued on next page)

Setting up the TV Guide On Screen system (continued)

3. Select your VCR brand, and then press ENTER. Code testing begins.

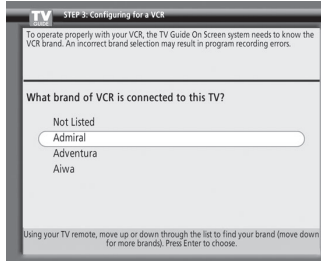

VCR code testing

1. To allow the TV Guide On Screen system to find the correct code for your brand of VCR, tune your VCR to channel 02, turn the VCR OFF, leave the TV ON, and then press ENTER.

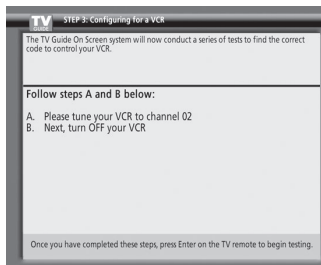

The TV Guide On Screen system will test the code for the brand of VCR you selected. Do not press any keys on the TV, remote control, or VCR until testing is done.

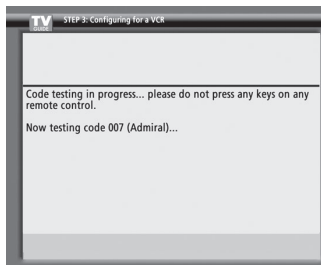

2. When code testing is done, if your VCR tuned itself to channel 09, select YES and press ENTER. Go to "Confirming your settings" (next column on this page).

If your VCR did not tune itself to channel 09 and you want to test the same code again, select TEST THIS CODE AGAIN and press ENTER.

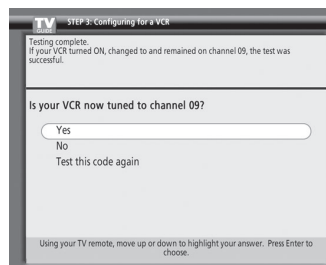

If your VCR did not tune itself to channel 09 and you want the TV Guide On Screen system to search for the correct code, select NO and press ENTER. Go to step 3.

3. If the correct code is not found, the following screens appear, with helpful hints for finding the code.

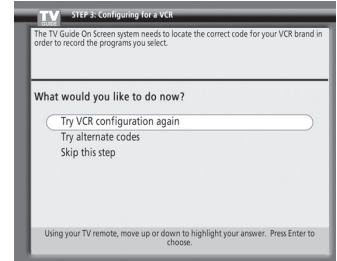
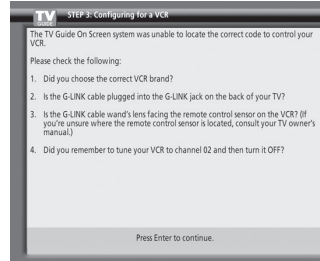

Confirming your settings

1. Review the setup information displayed on your TV screen (an example is shown below).

If the information on your TV screen is correct for your setup, select YES, END THE SETUP PROCESS and press ENTER.

If the information is incorrect, select NO, REPEAT THE SETUP PROCESS and press ENTER to repeat the TV Guide On Screen program guide setup process.

Note: If you skipped either the Cable box or VCR setup, the setup confirmation screen (below) will list INCOMPLETE for any information it has not received.

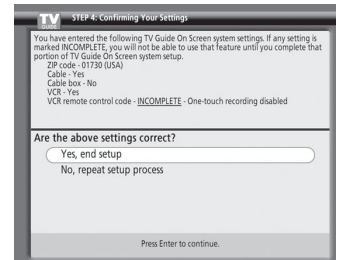
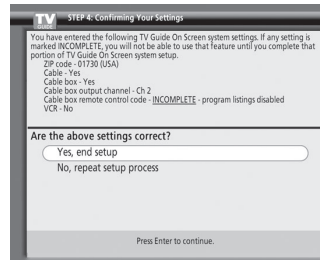

2. If you selected YES in step 1, the following screens appear.

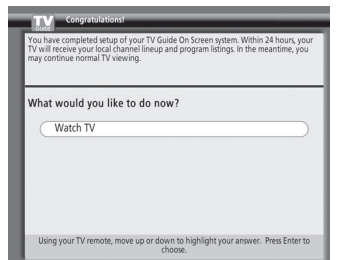
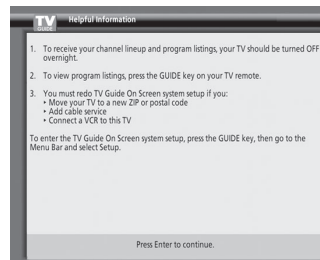

Press ENTER to exit the TV Guide On Screen setup.

See "Important final setup steps," next page.

If you are using the Quick Connect Guide, go to the next page to complete the assisted setup.

Completing the Quick Connect Guide assisted setup

The following screen appears. Highlight NEXT and press ENTER.

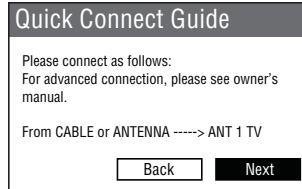

Note: The text on this screen may vary, depending on your specific device connection.

Configuring the ANT 1 input source

Highlight your ANT 1 input source—antenna or Cable—and press ENTER.

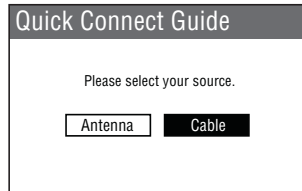

Programming channels into the channel memory

Press ENTER to start automatically programming all active channels (for the current input source) into the TV's channel memory. This will enable you to use the CH ▲▼ buttons on the remote control or TV front panel to change channels.

- For details on channel programming, see page 44.

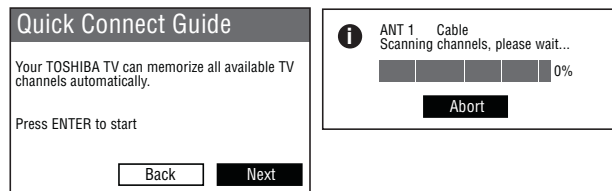

Selecting the picture mode

Highlight the picture mode you prefer, and then press ENTER.

- For details on the picture modes, see page 72.

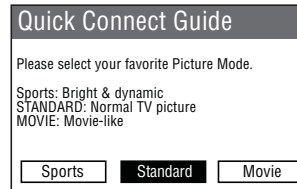

Adjusting the color convergence

Press the TOUCH FOCUS button on the TV front panel to start automatic color convergence

- For details on adjusting the color convergence, see page 50.

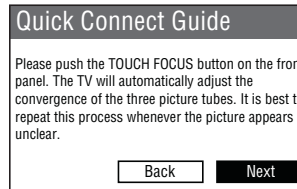

Completing the Quick Connect Guide setup

Highlight END and press ENTER to exit the Quick Connect Guide.



Important final setup steps

When you have completed the Quick Connect Guide setup process, follow these steps so your TV can receive TV Guide On Screen program data as quickly as possible (otherwise, it may take up to 24 hours for the TV to receive program data).

1. Turn OFF your TV overnight. (Do not unplug the power cord.)
2. If you have a Cable box connected, leave it ON.
3. If you have a VCR connected, turn it OFF. (Do not unplug the power cord.)
4. If you have more than one Cable system in your area, you may be prompted to select which Cable system's program data to download. If so prompted, follow the on-screen instructions.

6 Setting up your TV

For menu navigation instructions, see Chapter 4.

Selecting the menu language

Note: If you already selected the menu language during the Quick Connect Guide assisted setup, you can skip this step.

You can choose from three different languages (English, French and Spanish) for the on-screen display of adjustment menus and messages. (The TV Guide On Screen menus are in English, regardless of the language selected in this menu.)

To select the menu language:

1. Press MENU and open the PREFERENCES menu.
2. Highlight MENU LANGUAGE and press ENTER.
3. Highlight your preferred menu language in the menu sidebar and press ENTER.

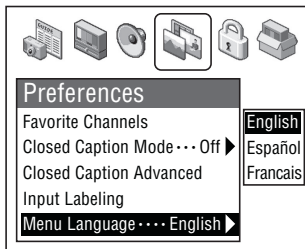

4. Press EXIT to close the PREFERENCES menu.

Configuring the antenna input sources

Note: If you already configured the antenna input sources during the Quick Connect Guide assisted setup, you can skip this step.

To configure the ANT 1 and ANT 2 input sources:

1. Press MENU and open the SETUP menu.
2. Highlight INSTALLATION and press ENTER. (A new set of INSTALLATION menu icons will appear on-screen, as shown in step 3 below.)

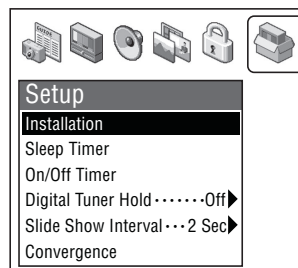

3. Open the TERRESTRIAL menu, highlight INPUT CONFIGURATION, and press ENTER.

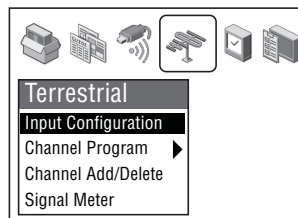

4. Press ► to select the input source (Cable or antenna) for the ANT 1 input on the TV.
5. Press ▼ and then ► to select the input source (Cable or antenna) for the ANT 2 input on the TV, if applicable. If you have not connected anything to ANT 2, skip this step.

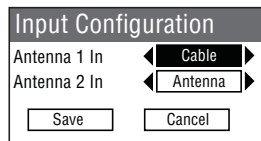

6. **To save your new settings:** Highlight SAVE and press ENTER.

To revert to your original settings: Highlight CANCEL and press ENTER before saving.

Programming channels into the TV's channel memory

When you press CHANNEL ▲ or ▼ on the remote control or TV front panel, your TV will stop only on the channels stored in the TV's channel memory.

Follow the steps below to program channels into the TV's channel memory.

Programming channels automatically

Your TV can automatically detect all active channels in your area and store them in its memory. After the channels are programmed automatically, you can manually add or erase individual channels.

Note:

- If you already programmed channels automatically during the Quick Connect Guide assisted setup, you can skip to "Manually adding and deleting channels in the channel memory" on the next page.
- You must configure the antenna input sources before programming channels (see page 41).
- The automatic channel programming process does NOT erase channels that were previously programmed into the TV's memory, but adds newly found channels to the existing set of programmed channels. To remove a channel from the memory, you must manually delete it (see next page).
- To tune the TV to a channel not programmed in the channel memory, you must use the Channel Number buttons on the remote control.
- Programming channels for an antenna input configured for CABLE will take substantially longer than for an antenna input configured for ANTENNA. This is normal; however, once channel programming is completed, you should not have to repeat the programming process again unless your Cable TV service lineup changes significantly.

To program channels automatically:

1. Make sure you have configured the antenna input sources. See page 41 for details.
2. Press MENU and open the SETUP menu.
3. Highlight INSTALLATION and press ENTER. (A new set of INSTALLATION menu icons will appear on-screen, as shown in step 4).

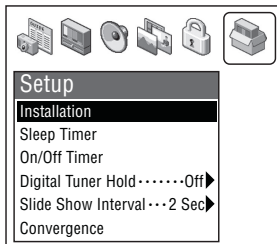

4. Open the TERRESTRIAL menu, highlight CHANNEL PROGRAM, and press ENTER.

5. Highlight ANT 1 or ANT 2, depending on which antenna input you want to program channels for, and then press ENTER to start automatic channel programming.

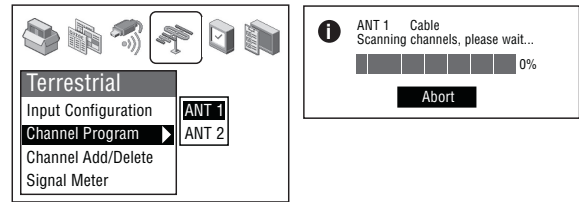

The TV will automatically cycle through all the channels for the antenna input you selected, and store all active channels in the channel memory. While the TV is cycling through the channels, the message "Scanning channels, please wait" appears (as shown above right).

To cancel channel programming, highlight ABORT and press ENTER.

6. When channel programming is done, press CHANNEL ▲ or ▼ to view the programmed channels.

(Continued on next page)

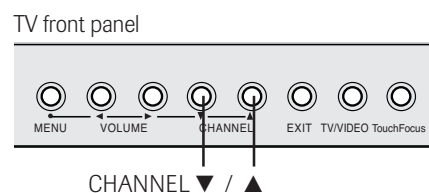
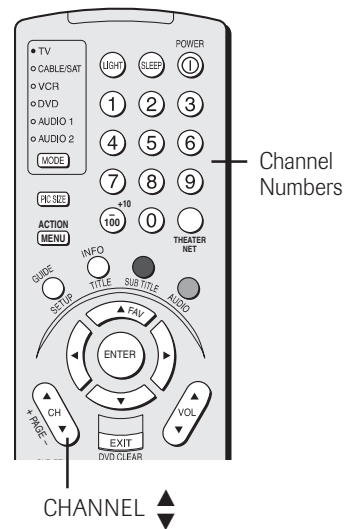

Programming channels into the TV's channel memory (continued)

Manually adding and deleting channels in the channel memory

After you have programmed the channels automatically, you can manually add or delete individual channels in the channel memory.

To add or delete channels in the channel memory:

1. Press MENU and open the SETUP menu.
2. Highlight INSTALLATION and press ENTER. (A new set of INSTALLATION menu icons will appear on-screen, as shown in step 3).

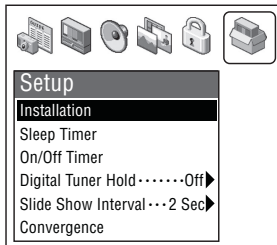

3. Open the TERRESTRIAL menu, highlight CHANNEL ADD/DELETE, and then press ENTER.

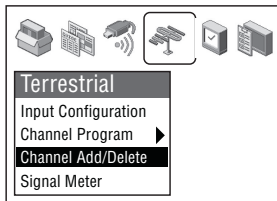

4. The illustration below shows channels programmed for the ANT 1 antenna input. To view the list of channels programmed for the ANT 2 antenna input, highlight CHANGE ANTENNA and press ENTER.

Channel	Signal	Antenna
2	Analog	1
3	Analog	1
4	Analog	1
5	Analog	1
5-1	Analog	1
5-2	Digital	1
5-3	Digital	1
5-4	Digital	1

To add a channel to the channel memory:

Highlight the unchecked box next to the channel number you want to add, and then press ENTER to check the box.

To remove a channel from the channel memory:

Highlight the checked box next to the channel number you want to remove, and then press ENTER to uncheck the box.

To save your new settings:

Highlight SAVE and press ENTER.

To revert to your original settings:

Highlight CANCEL and press ENTER before saving.

To remove all channels from the channel memory:

Highlight CLEAR ALL and press ENTER, and then highlight SAVE and press ENTER.

Note: This action cannot be cancelled unless you highlight CANCEL and press ENTER before saving your changes.

Channel	Signal	Antenna
2	Analog	2
3	Analog	2
4	Analog	2
5	Analog	2
6	Analog	2
6-1	Digital	2
6-2	Digital	2
7	Analog	2

Programming your favorite channels

You can program a maximum of 14 of your favorite channels from the ANT 1 and/or ANT 2 inputs into the Favorite Channels sets (two sets of seven favorite channels). You can then scan through your favorite channels only, skipping other channels you do not normally watch.

To add and delete channels in the Favorite Channels lists:

1. Press MENU and open the PREFERENCES menu.
2. Highlight FAVORITE CHANNELS and press ENTER.

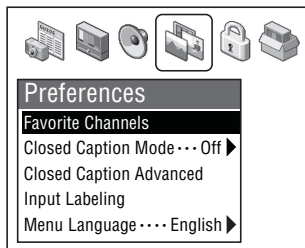

3. Highlight EDIT and press ENTER.

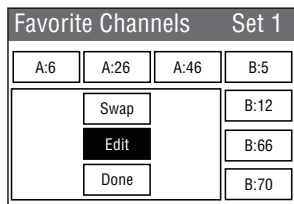

4. **To add the channel to the Favorite Channels set:**
Use the ▲▼◀▶ buttons to highlight an unchecked box next to a channel you want to set as a favorite, and then press ENTER to check the box.

To delete the channel from the Favorite Channels set:
Highlight a checked box and press ENTER to uncheck it.

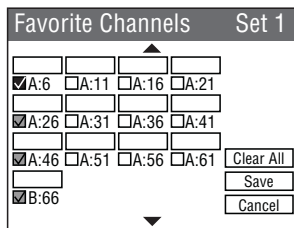

5. If you select more than seven favorite channels in step 4, the channels will be in two sets—Set 1 and Set 2.
To view and edit the second set of favorite channels, highlight SWAP and press ENTER. Set 2 appears. Highlight EDIT and press ENTER.

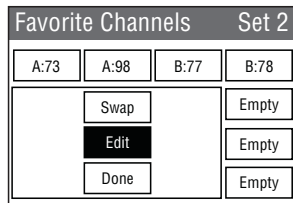
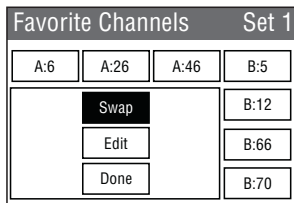

If you try to add more than 14 favorite channels, the error message appears. You will need to deselect a channel before you can add another.

6. When done, highlight SAVE and press ENTER.

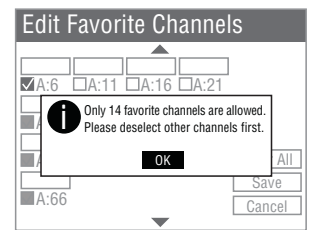

To clear your favorite channel lists:

1. Press MENU and open the PREFERENCES menu.
2. Highlight FAVORITE CHANNELS and press ENTER.
3. Highlight EDIT and press ENTER.
4. Highlight CLEAR ALL and press ENTER.
5. Highlight SAVE and press ENTER.

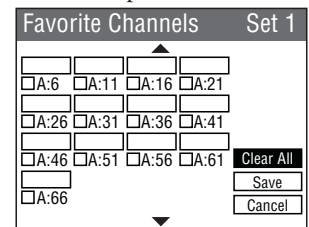

To tune your favorite channels:

1. Press the FAV button on the remote control. A POP multi-window scan of the favorite channels in Set 1 appears. Press SWAP to view the favorite channels in Set 2.
2. Press ▲▼◀▶ to highlight the channel you want to watch. When highlighted, the channel number displays in purple and the picture becomes a moving picture. Press ENTER to view the highlighted channel in the main window and close the POP multi-window.

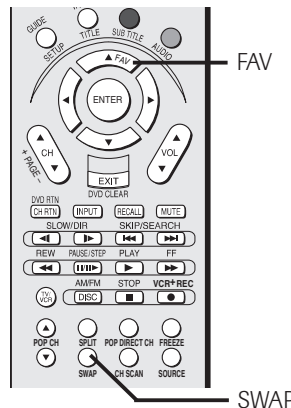
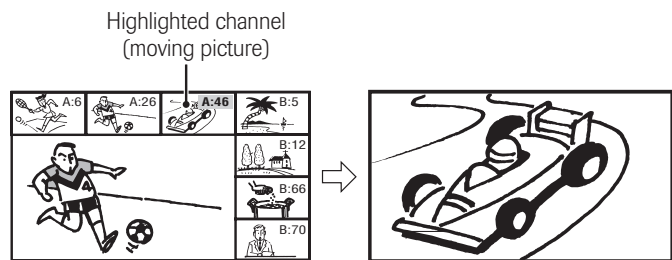

Note:

- The FAV button functions as the ▲ button when a menu is on-screen.
- See page 71 for more details on the favorite channel search feature.

Setting up and using TheaterNet™ on-screen device control

The TheaterNet feature allows you to control many brands of IEEE-1394 and/or infrared remote-controlled A/V devices through your TV using on-screen control icons and the TV's remote control.

Note:

- Although the TheaterNet on-screen device control feature includes codes for many devices, it may not include codes for some or all of the features on certain devices you wish to control. If you are unable to program the TheaterNet feature to operate your device or some of the features on that device, use the device's remote control or the controls on the device.
- For IR pass-through device control information, see "Connecting infrared remote-controlled devices to the IR OUT jack" on page 21.

Setting up TheaterNet

All device types except IEEE-1394 require the following setup process before you can control them using the TheaterNet on-screen icons.

All Compatible IEEE-1394 devices are automatically recognized by the TheaterNet feature and do not require setup.

Note: See page 23 for details about the IEEE-1394 ports. If your IEEE-1394 device is not recognized through the IEEE-1394 port or through the TheaterNet feature, it may be possible to set it up for IR pass-through control as an infrared device (see page 21).

To set up TheaterNet device control:

1. Make sure you have properly connected your infrared remote-controlled device(s). See page 21 for details.
2. Press MENU and open the SETUP menu.
3. Highlight INSTALLATION and press ENTER. (A new set of INSTALLATION menu icons will appear on-screen, as shown in step 4).

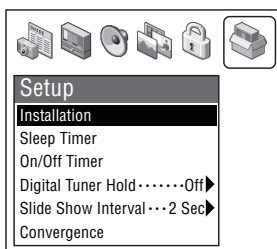

4. Open the DEVICES menu, highlight THEATER NET DEVICES, and then press ENTER.

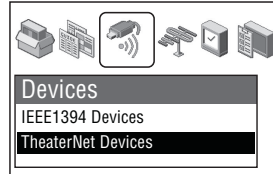

The TheaterNet Setup menu opens.

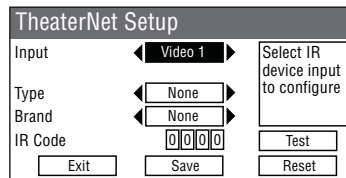

5. Using the ◀▶ buttons, select the INPUT the device is connected to.

Note: When the input is changed, all unsaved settings will be lost.
6. Press ▼ and then ◀▶ to select the device TYPE.
7. Press ▼ and then ◀▶ to select the device BRAND.
8. Press ▼ and then the Channel Number buttons to enter the device IR CODE.

Note: Refer to the TheaterNet device code table on pages 47–49 to find the IR code for your device.

9. Highlight TEST and press ENTER to test whether the device responds to the code.

If the device does not respond to the code, repeat steps 7 and 8 using another code for the same device.
10. When done, highlight SAVE and press ENTER.

To remove a device from TheaterNet:

1. Follow steps 1–5 above.
2. Highlight RESET and press ENTER.
3. Highlight SAVE and press ENTER.

Setting up and using TheaterNet™ on-screen device control (continued)

Using the TheaterNet control icons

- Set up your infrared devices in TheaterNet, if you have not already done so (see page 45).

Note: IEEE-1394 devices do not need to be set up in TheaterNet because they appear automatically in the TheaterNet menu (as shown in step 3 below).

- Press THEATER NET on the remote control to display the device control selection screen. You may need to press the TheaterNet button two times to display the selection screen.

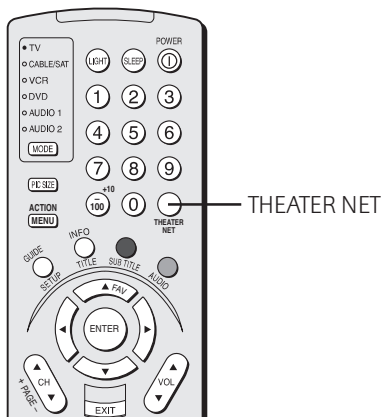

- Using the ▲▼◀▶ buttons, highlight the device you want to control and press ENTER.

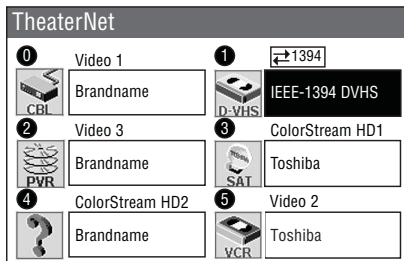

- The input automatically changes to the input for the selected device and the device's control icons display.

Highlight the icon for the function you want to control and press ENTER.

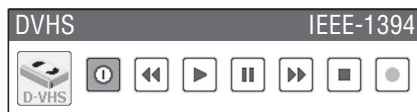

To close the on-screen control icons:

Press EXIT.

To view another source:

Press INPUT and select the input source you want to view.

The following are examples of the TheaterNet on-screen control icons for other types of devices.

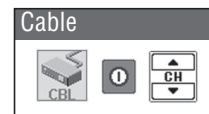
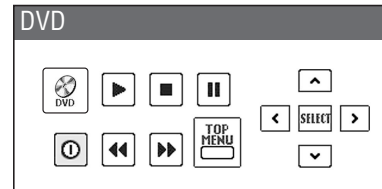

TheaterNet IR device codes

Amplifiers

Brand	Code
Aiwa	0406
Bose	0674
Carver	0269
Curtis Mathes	0300
Denon	0160
GE	0078
Harman/Kardon	0892
JVC	0331
Left Coast	0892
Linn	0269
Luxman	0165
Magnavox	0269
Marantz	0892, 0321, 0269
NEC	0264
Nakamichi	0321
Optimus	0395, 0300
Panasonic	0308, 0521
Parasound	0246
Philips	0892, 0269
Pioneer	0013, 0300
Polk Audio	0892, 0269
RCA	0300
Realistic	0395
Sansui	0321
Shure	0264
Sony	0689, 0220
Soundesign	0078, 0211
Technics	0308, 0521
Victor	0331
Wards	0078, 0013, 0211
Yamaha	0354, 0133

Cable boxes

Brand	Code
ABC	0003, 0008, 0014, 0007, 0011, 0017
Americast	0899
Bell & Howell	0014
Bell South	0899
Contec	0019
Director	0476
Everquest	0015
Gemini	0015
General Instrument	0476, 0003, 0276, 0011, 0810
GoldStar	0144
Hamlin	0009, 0020, 0273
Hitachi	0011
Hytex	0007
Jasco	0015
Jerrold	0476, 0003, 0276, 0012, 0014, 0015, 0011, 0810
Memorex	0000
Motorola	0476, 1106, 0276, 0810
Oak	0019, 0007
Pace	0237
Panasonic	0000, 0107
Paragon	0000
Philips	0305, 0317
Pioneer	0877, 0144, 0533, 1877
Pulsar	0000
Quasar	0000

Cable boxes (cont.)

Brand	Code
RadioShack	0015
Regal	0020, 0273, 0279
Rembrandt	0011
Runco	0000
Samsung	0144
Scientific Atlanta	0877, 0008, 0017, 0477, 1877
Signal	0015
Signature	0011
sony	1006
Starcom	0003, 0015
Stargate	0015
Starquest	0015
Supercable	0276
Tocom	0012
Torx	0003
Toshiba	0000
Tusa	0015
United Artists	0007
Zenith	0000, 0525, 0899

CD players

Brand	Code
Aiwa	0157, 0124
Burmester	0420
California Audio Labs	0029, 0303
Carver	0157, 0179, 0437
Classic	1297
DKK	0000
DMX Electronics	0157
Denon	0873, 0003
Emerson	0305
Fisher	0174, 0179, 1325
GPX	1296
Garrard	0393, 0420
Genexxa	0032, 0305
Harman/Kardon	0157, 0173
Hitachi	0032
JVC	0072, 1294
KLH	1318, 1372, 1373
Kenwood	0681, 0826, 0626, 0028, 0037, 0190
Koss	1317
Krell	0157
LXI	0305
Linn	0157
MCS	0029
MTC	0420
Magnavox	0157, 0305
Marantz	0626, 0029, 0157, 0180
Miro	0000
Mission	0157
NSM	0157
Nikko	0174
Onkyo	0868, 0101
Optimus	1063, 0000, 0032, 0037, 0145, 0179, 0305, 0420, 0437, 0468
Panasonic	0029, 0303
Parasound	0420
Philips	0626, 0157
Pioneer	1063, 1062, 0032, 0305, 0468
Polk Audio	0157

CD players (cont.)

Brand	Code
Proton	0157
QED	0157
Quasar	0029
RCA	1062, 0032, 0053, 0179, 0305, 0468, 0764
Realistic	0179, 0180, 0420
Rotel	0157, 0420
SAE	0157
Sansui	0157, 0305
Sanyo	0179
Scott	0305
Sears	0305
Sharp	0861, 0037, 0180
Sherwood	1067, 0180
Sonic Frontiers	0157
Sony	0490, 0000, 0100, 0185, 0604, 1364
Soundesign	0145
TDK	1208
Tascam	0420
Teac	0174, 0180, 0393, 0420
Technics	0029, 0303
Victor	0072
Wards	0157, 0053
Yamaha	0888, 0036, 0187, 1292
Yorx	0461

Laser disk players

Brand	Code
Aiwa	0203
Carver	0064, 0194, 0323
Denon	0059, 0172
Disco Vision	0023
Funai	0203
Harman/Kardon	0194
Hitachi	0023
Magnavox	0194, 0217
Marantz	0064, 0194
Mitsubishi	0059
NAD	0059
Optimus	0059
Panasonic	0204
Philips	0064, 0194
Pioneer	0059, 0023
Polk Audio	0194
Quasar	0204
Realistic	0203
Samsung	0323
Sega	0023
Sony	0193, 0201
Technics	0204
Theta Digital	0194
Yamaha	0217

Miscellaneous audio devices

Brand	Code
Aiwa	0010, 0159, 0404
Fisher	0052
JVC	0073
Jerrold	0520, 0459
Scientific Atlanta	0460
Sony	0010, 0159, 0576
Starcom	0459

TheaterNet IR device codes (continued)

Video accessory (HDTV decoder)

Brand	Code
Panasonic	1120
Pioneer	1010
Princeton	0113, 0295
Samsung	1190
Sensory Science	1126
Sharp	1010

Receivers

Brand	Code
ADC	0531
Aiwa	1089, 1405, 0121, 0158, 0189, 0405, 1388, 1641
Alco	1390
Anam	1609
Apex Digital	1257
Arcam	1120
Audiotronic	1189
Audiovox	1390
Bose	1229
Cambridge Soundworks	1370
Capetronic	0531
Carver	1089, 1189, 0042, 0189
Casio	0195
Clarinet	0195
Compaq	1136
Curtis Mathes	0080
Daewoo	1250
Denon	1104, 1160, 0004, 1360
Fisher	0042, 1801
Garrard	0463
Harman/Kardon	0110, 0189, 0891
Hewlett Packard	1181
JBL	0110, 1306
JVC	0074, 1374
KLH	1390
Kenwood	1313, 1027, 1570, 1569, 0027, 0042, 0186
Koss	1366
LXI	0181
Lasonic	1798
Linn	0189
Lloyd's	0195
MCS	0039
Magnavox	1089, 1189, 0189, 0195, 0391, 0531
Marantz	1089, 1189, 0039, 0189
Modulaire	0195
Musicmagic	1089
Nakamichi	0097
Onkyo	0135, 0842, 1298
Optimus	1023, 0042, 0080, 0181, 0186, 0531, 0670, 0738, 0801
Panasonic	1518, 0039, 0309, 0367
Penney	0195
Philips	1089, 1189, 1269, 0189, 0391, 1120
Pioneer	1023, 0014, 0080, 0150, 0244, 0531, 0630, 1384
Polk Audio	0189

Receivers (cont.)

Brand	Code
Proscan	1254
Quasar	0039
RCA	1023, 1254, 0080, 0531, 1390, 1609
Realistic	0181, 0195
Samsung	1295
Sansui	1089, 0189
Sanyo	0801, 1251
Sharp	0186, 1286
Sherwood	0491, 0502, 1653
Sony	1058, 1258, 1158, 0158, 0474, 1367, 1558, 1658, 1758
Soundesign	0670
Stereophonics	1023
Sunfire	1313
Teac	0463
Technics	1308, 1309, 1518, 0039, 0309
Thorens	1189
Venturer	1390
Victor	0074
Wards	0014, 0080, 0158, 0189
Yamaha	0176, 0186, 1176
Yorx	0195
Zenith	0857

Satellite receivers

Brand	Code
AlphaStar	0772
Chaparral	0216
Crossdigital	1109
DishPro	1005, 0775
Echostar	1005, 0775
Expressvu	0775
GE	0566
GOI	0775
General Instrument	0869
HTS	0775
Hitachi	0819
Hughes Network Systems	1142, 0749, 1749
JVC	0775
Magnavox	0724, 0722
Memorex	0724
Mitsubishi	0749
Motorola	0869
Next Level	0869
Panasonic	0247, 0701
Paysat	0724
Philips	1142, 0749, 0724, 1076, 0722, 1749
Proscan	0392
RCA	0392, 0566, 0855, 0143
RadioShack	0869
SKY	0856
Samsung	1109
Sony	0639
Star Choice	0869
Toshiba	0749, 0790, 1052, 1053, 1054, 1285, 1286, 1287, 1289, 1749
Uniden	0724, 0722
Zenith	0856, 1856

VCRs

Brand	Code
Admiral	0048, 0209
Adventura	0000
Aiko	0278
Aiwa	0037, 0000
Akai	0041
America Action	0278
American High	0035
Asha	0240
Audiovox	0037, 0278
Beaumarck	0240
Bell & Howell	0104
Broksonic	0184, 0121, 0209, 0002, 0479, 1479 0072, 0278
CCE	0037
Calix	0035
Canon	0081
Carver	0278
Cineral	0037, 0278, 1278
Citizen	0072
Colt	0037, 0047, 0240, 0072
Craig	0060, 0035, 0162, 0041, 0760, 1035
Curtis Mathes	0240
Cybernex	0045, 0278, 1278
Daewoo	0042
Denon	0000
Dynatech	0037
Electrohome	0037
Electroponic	0032
Emerex	0037, 0184, 0000, 0121, 0043, 0209, 0002, 0278, 0479, 1278, 1479
Emerson	0047, 0104
Fisher	0035, 0033
Fuji	0000
Funai	0060, 0035, 0240, 0760, 0807, 1035, 1060
GE	0000
Garrard	0432
Go Video	0037, 0038, 1237
GoldStar	0000
Gradiente	0047
HI-Q	0000
Harley Davidson	0081, 0038
Harman/Kardon	0072
Harwood	0046
Headquarter	0000, 0042, 0041
Hitachi	0042
Hughes Network Systems	0067, 0041
JVC	0041
Jensen	0037, 0278
KEC	0072
KLH	0693
Keen	0067, 0041, 0038
Kenwood	0035, 0037
Kodak	0037
LXI	0000
Lloyd's	0072
Logik	0035
MEI	0240, 0043
MGA	0240
MGN Technology	0240, 0000
MTC	1278
Magnasonic	

TheaterNet IR device codes (continued)

VCRs (cont.)

Brand	Code
Magnavox	0035, 0039, 0081, 0000, 0149, 0563, 1781
Magnin	0240
Marantz	0035, 0081
Marta	0037
Matsushita	0035, 0162, 0454
Memorex	0035, 0162, 0037, 0048, 0039, 0047, 0240, 0000, 0104, 0209, 0046, 0454, 0479, 1037, 1162, 1237, 1262
Minolta	0042
Mitsubishi	0067, 0043, 0807
Motorola	0035, 0048
Multitech	0000, 0072
NEC	0104, 0067, 0041, 0038
Nikko	0037
Noblex	0240
Olympus	0035
Optimus	1062, 0162, 0037, 0048, 0104, 0432, 0454, 1048, 1162, 1262
Orion	0184, 0209, 0002, 0479, 1479
Panasonic	1062, 0035, 0162, 0225, 0454, 0616, 1035, 1162, 1262
Penney	0035, 0037, 0240, 0042, 0038, 1035, 1237
Pentax	0042
Philco	0035, 0209, 0479
Philips	0035, 0081, 0618, 1081, 1181
Pilot	0037
Pioneer	0067
Polk Audio	0081
Profitronic	0240
Proscan	0060, 0760, 1060
Protec	0072
Pulsar	0039
Quarter	0046
Quartz	0046
Quasar	0035, 0162, 0454, 1035, 1162
RCA	0060, 0240, 0042, 0149, 0760, 0807, 1035, 1060
RadioShack	0000, 1037
Radix	0037
Randex	0037
Realistic	0035, 0037, 0048, 0047, 0000, 0104, 0046
ReplayTV	0614, 0616
Runco	0039
STS	0042
Samsung	0240, 0045
Sanky	0048, 0039
Sansui	0000, 0067, 0209, 0041, 0479, 1479
Sanyo	0047, 0240, 0104, 0046

VCRs (cont.)

Brand	Code
Scott	0184, 0045, 0121, 0043
Sears	0035, 0037, 0047, 0000, 0042, 0104, 0046, 1237
Semp	0045
Sharp	0048, 0807, 0848
Shintom	0072
Shogun	0240
Singer	0072
Sonic Blue	0614, 0616
Sony	0035, 0032, 0000, 0033, 0636, 1032, 1232
Sylvania	0035, 0081, 0000, 0043, 1781
Symphonic	0000
TMK	0240
Tatung	0041
Teac	0000, 0041
Technics	0035, 0162
Teknika	0035, 0037, 0000
Thomas	0000
Tivo	0618, 0636
Toshiba	0045, 0043, 0845
Totevision	0037, 0240
Unitech	0240
Vector	0045
Vector Research	0038
Video Concepts	0045
Videomagic	0037
Videosonic	0240
Villain	0000
Wards	0060, 0035, 0048, 0047, 0081, 0240, 0000, 0042, 0072, 0149, 0760
White Westinghouse	0209, 0072, 1278
XR-1000	0035, 0000, 0072
Yamaha	0038
Zenith	0039, 0000, 0209, 0033, 0479, 1479

DVD players

Brand	Code
Aiwa	0641
Apex Digital	0672, 0717, 0755, 0794, 0796, 0797, 0830, 0856, 1100
Audiologic	0736
B & K	0655, 0662
Blue Parade	0571
Broksonic	0695
DVD2000	0521
Daewoo	0784
Denon	0490, 0634
Emerson	0591
Enterprise	0591
Fisher	0670
GE	0522, 0717
GPX	0699, 0769
Go Video	0715
Gradiente	0651
Greenhill	0717
Harman/Kardon	0582, 0702

DVD players (cont.)

Brand	Code
Hitachi	0573, 0664
Hiteker	0672
JBL	0702
JVC	0558, 0623, 0867
KLH	0717
Kenwood	0490, 0534, 0682, 0737
Konka	0711, 0719, 0720, 0721
Koss	0651
Lasonic	0798
Magnavox	0503, 0675
Malata	0782
Marantz	0539
Microsoft	0522
Mintek	0717
Mitsubishi	0521
Nesa	0717
Next Base	0826
Norcent	0872
Onkyo	0503, 0627
Oritron	0651
Panasonic	0490, 0632, 1362, 1462, 1490
Philips	0503, 0539, 0646, 0854
Pioneer	0525, 0571, 0632
Polk Audio	0539
Princeton	0674
Proscan	0522
RCA	0522, 0571, 0717, 0822
Rotel	0623
Rowa	0823
Sampo	0698
Samsung	0573, 0820
Sansui	0695
Sanyo	0670
Sharp	0630
Sherwood	0633
Shinsonic	0533
Sony	0533, 0864, 1533
Sylvania	0675, 0821
Technics	0490
Techwood	0692
Theta Digital	0571
Toshiba	0503, 0695, 1045
Tredex	0800
Urban Concepts	0503
XBox	0522

Adjusting the color convergence

This projection TV uses three separate image tubes: red, green, and blue. The red, green, and blue images are projected onto the screen where they converge to form a full-color picture. You can see a clear picture only when the three images converge correctly. Convergence may drift over time or if you move the TV. If you can see clear images on your TV screen, skip this procedure.

This adjustment should be made only after the TV has been on for at least 30 minutes.

Automatically adjusting the color convergence using TouchFocus™

To automatically adjust the color convergence:

Press TouchFocus on the TV front panel one time.

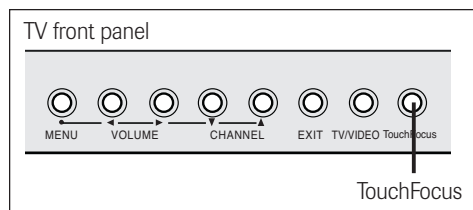

The TV will enter the auto convergence mode.

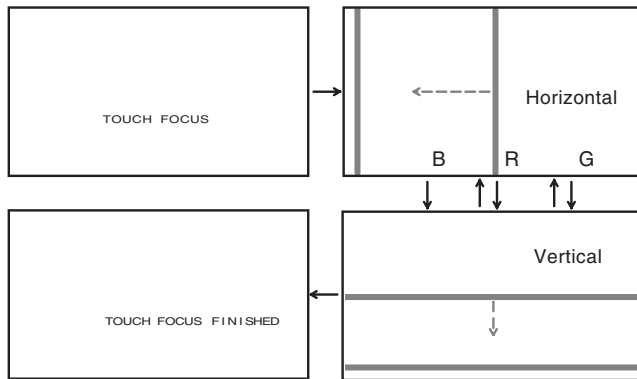

When adjustment is complete, the normal picture will reappear.

If the error message “Touch Focus Error” appears, retry the TouchFocus adjustment or adjust the convergence manually, as described at right.

Manually adjusting the color convergence

To check and adjust the color convergence manually:

1. Press MENU and open the SETUP menu.
2. Highlight CONVERGENCE and press ENTER.

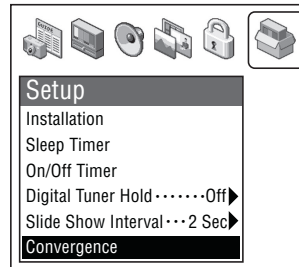

3. The center convergence adjustment window (below) opens. If you see separate red, blue, or green crossed lines (or red or blue shadows next to white lines), you need to adjust the convergence.

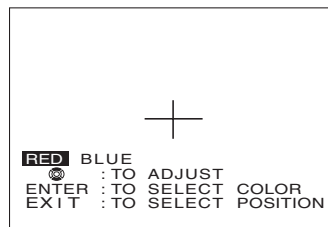

4. Press ENTER to highlight RED or BLUE, depending on which color needs adjusting. If both red and blue need adjusting, you will need to perform steps 4 and 5 twice.
5. Press ▲ (up), ▼ (down), ◀ (left), or ▶ (right) on the remote control to converge the red or blue lines into the white line. When color convergence is correctly adjusted, you will see two single crossed white lines.
6. Press EXIT to display the Circumference Convergence menu.
7. Press the corresponding Number button (1–4 and 6–9) to select the area you want to adjust.

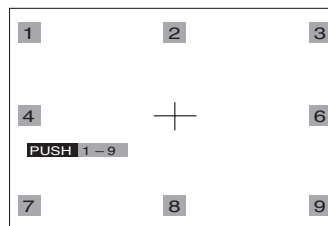

8. Press ENTER to highlight RED or BLUE, depending on which color needs adjusting. If both red and blue need adjusting, you will need to perform steps 8 and 9 twice for the selected area.

Adjusting the color convergence

(continued)

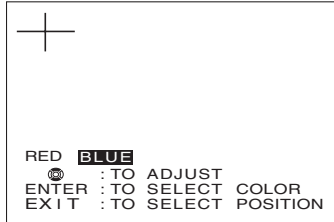

9. Press ▲▼◀▶ to converge the red or blue line into the white line. Repeat steps 8 and 9 until you see two single crossed white lines.
10. Press EXIT once to select another area to adjust, and then repeat steps 7–9.
11. Press EXIT a second time to close the Convergence menu.

Setting the time and date

Note: If you already set up the TV Guide On Screen system, the time and date were set automatically and you can skip this step.

To set the time and date:

1. Press MENU and open the SETUP menu.
2. Highlight INSTALLATION and press ENTER. (A new set of INSTALLATION menu icons will appear on-screen, as shown in step 3 below.)
3. Open the TIME AND DATE menu, highlight START SETUP, and press ENTER.

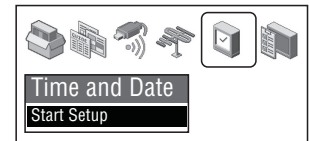
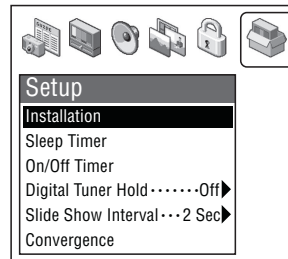

If you have not set up the TV Guide On Screen system, the following screen will appear. To set the time, highlight TV GUIDE and press ENTER. The TV Guide On Screen setup sequence will start, and the time and date will be set automatically.

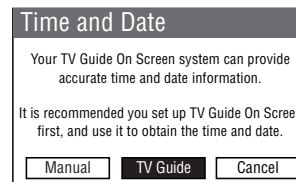

Note: If you do not set up the TV Guide On Screen system and you manually set the time and date (by highlighting MANUAL instead of TV GUIDE, above), you will lose the time and date information if a power outage occurs. If you set the time and date through the TV Guide On Screen system and a power outage occurs, the time and date will be updated automatically when the power is restored.

Viewing the digital signal meter

You can view the digital signal meter for ANT 1 and ANT 2 digital TV input sources only.

To view the digital signal meter:

1. Press MENU and open the SETUP menu.
2. Highlight INSTALLATION and press ENTER. (A new set of INSTALLATION menu icons will appear on-screen, as shown in step 3 below.)

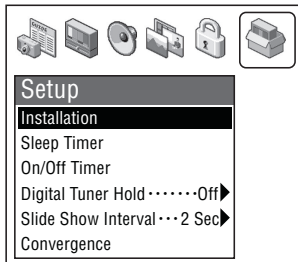

3. Open the TERRESTRIAL menu, highlight SIGNAL METER, and press ENTER.

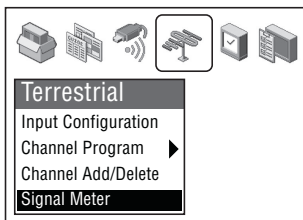

4. Use the ▲▼◀▶ buttons to select the antenna input and digital channel whose signal you want to check.

Note: The digital channel number listed in the Signal Meter screen does not correspond to an actual TV channel number. Contact your local broadcasters to obtain the RF channel numbers for your local digital stations.

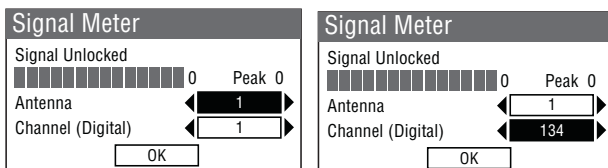

To close the screen and return to the TERRESTRIAL menu:

Highlight OK and press ENTER.

To return to normal viewing:

Press EXIT.

Checking system status

To check the system status:

1. Press MENU and open the SETUP menu.
2. Highlight INSTALLATION and press ENTER. (A new set of INSTALLATION menu icons will appear on-screen, as shown in step 3).
3. Open the SYSTEM STATUS menu, highlight SYSTEM INFORMATION, and then press ENTER.

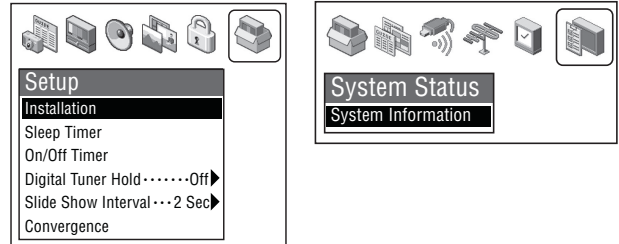

4. Use the ◀▶ buttons to scroll through the menu bar to check the Product Information and Software Version.

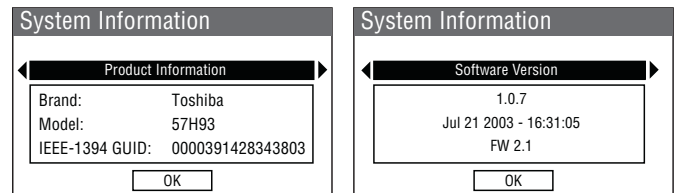

To close the screen and return to the TERRESTRIAL menu: Highlight OK and press ENTER.

To return to normal viewing: Press EXIT.

Restore Factory Defaults

To restore all settings and channels to their factory default values:

1. Follow steps 1–3 above.
2. Use the ◀▶ buttons to scroll through the menu bar to select FACTORY DEFAULTS.
3. The screen below left appears. Enter your PIN code (or 0000 if no PIN code has been set). The screen below right appears.

To cancel the reset: Highlight NO and press ENTER.

To continue the reset process: Highlight YES and press ENTER. The TV will turn off automatically after a few seconds. After the TV turns off, unplug the TV power cord and then plug it in again to complete the restore.

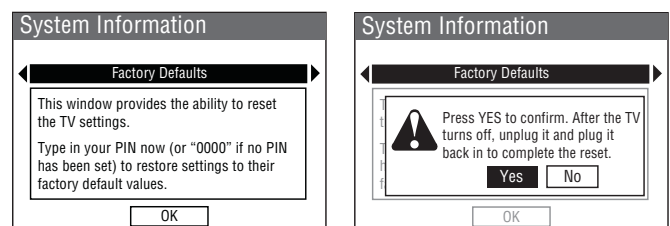

7 Using the TV Guide On Screen™ interactive program guide

The TV Guide On Screen system is a free, interactive, on-screen program guide built in to your Toshiba TV that lists schedules and information for TV programs in your area.

Note: Over-the-air or cable access to stations carrying TV Guide On Screen data is required for the TV Guide On Screen system to operate. TV Guide On Screen data is not provided by Toshiba America Consumer Products, Inc. The data provider may elect to discontinue the service or it may cease to be (or never be) available in your area. In any of these circumstances, the TV Guide On Screen feature will not function.

The TV Guide On Screen system includes the following features:

- **On-screen assisted setup**—Quickly and easily set up your TV Guide On Screen system using the on-screen prompts (see “Setting up the TV Guide On Screen system” below).
- **Program listings and INFO windows**—Scroll through eight days of TV listings and view program information.
- **Schedule**—View a list of programs you set as favorites or scheduled to record.
- **Direct tuning**—Directly tune the TV to a current program you want to watch by selecting it in the program guide.

- **One-touch recording**—Use the RECORD feature to easily schedule recording of one or more programs without having to use your VCR’s menus.

Note: A VCR is required for one-touch recording. It is recommended that you connect your VCR according to the connection instructions on pages 12–13.

- **VCR Plus+® recording**—Use PlusCode® numbers (from your local TV listing publications or from the TV Guide On Screen INFO windows) to schedule recordings.
- **Sort**—Browse through only the programs you’re interested in by sorting them alphabetically or by program type.
- **Favorites**—Create a list of your favorite programs for easy browsing and tuning.
- **Messages**—View messages sent to you from the TV Guide On Screen service.
- **On-screen help**—The TV Guide On Screen system contains on-screen feature definitions and navigation instructions.
- **Promotions**—View a list of available promotions and TV Guide On Screen features and tips.

Setting up the TV Guide On Screen system

Follow these instructions to set up the TV Guide On Screen system so it can receive current program data for your area.

Note: Any time you move to a different ZIP/postal code, you will need to perform the GUIDE SETUP process to reconfigure your TV Guide On Screen system.

If you already connected your devices and set up the TV Guide On Screen system during the Quick Connect Guide setup:

Skip these steps and go to the next page.

If you have not already connected your devices or set up the TV Guide On Screen system, or if you have moved to another ZIP/postal code:

1. Connect your antenna, Cable box, and/or VCR to the G-LINK jack on your TV. See pages 12, 13, and 25 for connection instructions.

Note: You will need to connect a VCR if you want to use the TV Guide On Screen system’s one-touch recording feature. It is recommended that you connect your VCR and antenna or Cable box according to the connection instructions on pages 12, 13, and 25.

2. Press MENU and open the SETUP menu.

3. Highlight INSTALLATION and then press ENTER to open the INSTALLATION menu system. (A new set of INSTALLATION menu icons will appear on-screen, as shown in step 4 below.)

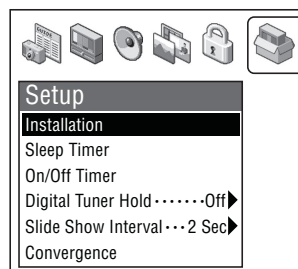

4. Open the TV GUIDE ON SCREEN SETUP menu, highlight START, and then press ENTER.

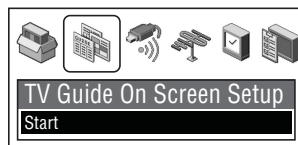

5. Go to page 37 for instructions on completing the setup. Read pages 54–60 for details on using the TV Guide On Screen interactive program guide.

About the TV Guide On Screen menus

The menus in the TV Guide On Screen system contain some or all of the following elements, depending on which menu is active:

- Menu Bar (LISTINGS, SORT, PROMOTIONS, SETUP, MESSAGES, and SCHEDULE)
- Video Window with lock icon
- Program and/or channel listings
- Panel ads
- Blue and Green ACTION buttons
- INFO button

Note:

- The TV Guide On Screen menus shown in this manual are for illustration purposes only. The channels, programs, and TV Guide On Screen information as illustrated may not be available in your area. The options and features as illustrated are subject to change when updates are downloaded from the TV Guide On Screen service to your TV.
- The TV Guide On Screen system displays program listings for the TV's ANT 1 and VIDEO 1 input sources only. (See Chapter 2: Connecting your TV for connection details.)
- The TV Guide On Screen system does not display program listings for satellite TV systems.

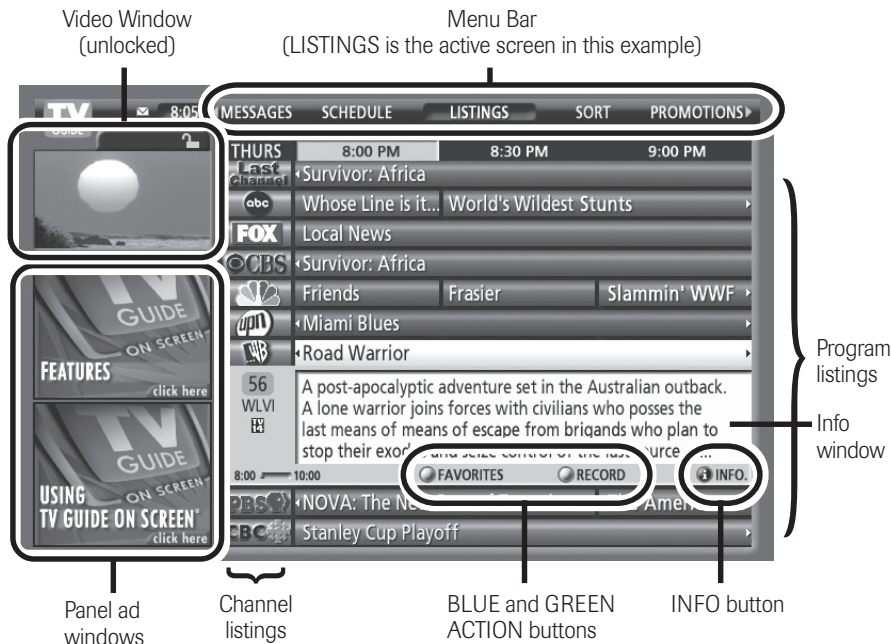

Navigating the TV Guide On Screen system

To open the TV Guide On Screen system:

Using the remote control: Press GUIDE.

Using the menus: Press MENU, open the APPLICATIONS menu, highlight TV GUIDE ON SCREEN, and then press ENTER.

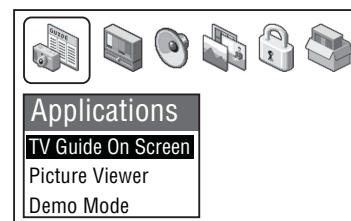

To select a menu in the Menu Bar:

Press MENU or use the up/down arrow buttons (▲▼) to select the Menu Bar, and then use the left/right arrow buttons (◀▶) to select a menu.

To view a listed program:

Use the up/down/left/right arrow buttons (▲▼◀▶) to highlight the program or channel you want to view, and then press ENTER.

To select a BLUE or GREEN on-screen action button:

Press the BLUE or GREEN button on the remote control to select the corresponding action.

Note: The corresponding actions for the BLUE and GREEN buttons will vary depending on the current menu or selection. The on-screen descriptions will explain what action will occur when you press either button.

To select the on-screen INFO button and open the INFO window:

Press INFO on the remote control. Continue to press INFO to change the size of the INFO window.

To exit the TV Guide On Screen system:

Highlight a program listing and press ENTER to tune the TV to the selected program.

or... Press GUIDE or EXIT to tune the TV to the program displayed in the Video Window.

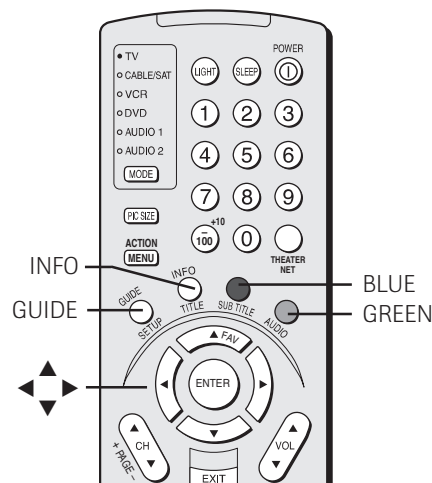

Note

The TV Guide On Screen program guide automatically opens each time you turn on the TV. To disable this feature:

1. Press GUIDE to open the TV Guide On Screen system.
2. Press MENU to select the TV Guide On Screen Menu Bar.
3. Use the ◀▶ buttons to select the SETUP menu.
4. Use the ▲▼ buttons to select REVIEW OPTIONS, and then press ENTER.
5. Set TV GUIDE ON SCREEN AUTO DISPLAY to OFF and press ENTER.

LISTINGS menu

The LISTINGS menu appears when you open the TV Guide On Screen program guide. In the LISTINGS menu you can:

- scroll through eight days of program listings;
- view detailed program descriptions;
- directly tune to a selected program or channel;
- lock and unlock the Video Window;
- set up programs as favorites;
- set up programs to record using one-touch recording;
- view panel ads and channel ads; and
- use the Menu Bar to access the other menus (SORT, PROMOTIONS, SETUP, MESSAGES, and SCHEDULE)

To open the LISTINGS menu:

Using the remote control: Press GUIDE.

Using the menus: Press MENU, open the APPLICATIONS menu, highlight TV GUIDE ON SCREEN, and then press ENTER.

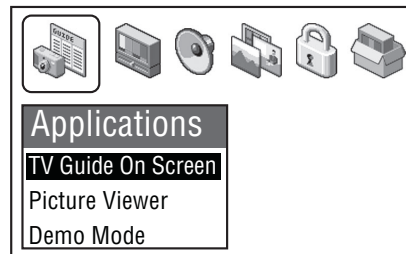

Viewing program listings and descriptions

The LISTINGS menu lists programs for the current time slot through 11:30 p.m. of the same day next week.

The listings are color-coded according to program type: purple for movies, green for sports, blue for children's shows, and teal for all others.

The top entry in the list will always be “Last Channel” so you can easily choose to return to the last channel you were watching by highlighting “Last Channel” and pressing ENTER.

Channel surfing

- Directly access a listing using the Channel Number buttons on the remote control.
- Use the ▲▼ arrow buttons to browse up and down through the listings one program at a time.
- Use the CH ▲▼ button to browse up and down through the listings one page at a time.
- Use the ►◀ arrow buttons to browse right and left through the listings one half-hour at a time.
- With LISTINGS highlighted in the Menu Bar, use the BLUE button to browse right and the GREEN button to browse left through the listings 24 hours at a time.

INFO windows

When the **INFO** icon is displayed, you can press the INFO button on the remote control to display detailed information specific to the item you have selected.

- When the LISTINGS menu is open and a listing is selected, repeatedly press INFO on the remote control to toggle through three sizes of INFO windows (illustrated at right).
- The detail and expanded detail INFO windows display information about the selected program and/or channel, including the channel number and station call letters, program start time, elapsed time bar, and various feature icons (for example, a headphones icon if the program is in stereo, or “CC” if the program is closed-captioned).

LISTINGS menu – INFO action bar



LISTINGS menu – Detail INFO window



LISTINGS menu – Expanded detail INFO window

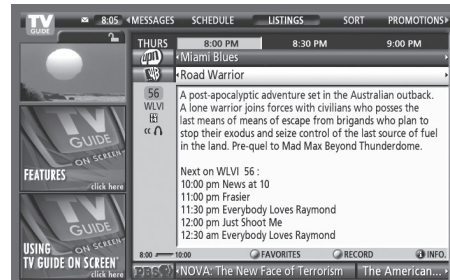

LISTINGS menu (continued)

Direct tuning

To directly tune the TV to a program:

In the LISTINGS menu, select a program or a broadcast-related panel ad or channel ad, and press ENTER. The TV tunes itself to the selected program and the TV Guide On Screen system closes.

- If you highlight a program in a future time slot, or a panel ad or channel ad for a future program, the TV will tune to the current program on the related channel.
- You can directly tune programs from other menus as well, including the SORT and SCHEDULE menus.

Video Window

The Video Window displays the current program for the ANT 1 or VIDEO 1 input source. As you surf through the listings, the Video Window will change to display the selected program.

You can lock the Video Window to keep the current program displayed, regardless of the program that is selected in the listings. When you unlock the Video Window, the currently selected program will then be displayed.

To lock the Video Window:

Press the SPLIT button on the remote control.

or... Highlight the station call letters in the “Last Channel” column of the LISTINGS menu and press the BLUE button on the remote control.

To unlock the Video Window:

Press the SPLIT or BLUE button again.

Setting programs as favorites

When you set programs as favorites, they are then listed in the SCHEDULE menu for quick browsing and tuning. After you set a program as a favorite, a “heart” icon will appear next to the listing for that program.

To set a program as a favorite:

1. In the LISTINGS menu, select the program you want to set as a favorite.
2. Press the BLUE button.
3. Repeatedly press the GREEN button to select one of the following:
 - ONCE—sets the selected program as a favorite only on that day.
 - WEEKLY—sets the program as a favorite every week on the same day and at the same time, even if the program titles are different each week.
 - REGULARLY—sets the selected program as a favorite every day it appears at the same time on the same channel.

To view a list of programs you set as favorites, to cancel a favorite, or to change the frequency of a favorite:

1. With the TV Guide On Screen system open, press MENU and select the SCHEDULE menu.
2. Select FAVORITES in the sub-menu bar. A list of the programs you set as favorites will display. You can then either cancel a favorite or change its frequency.

Note: You also can cancel favorites in the LISTINGS menu.

One-touch and VCR Plus+ recording

You can set programs to record from the TV Guide On Screen system using either one-touch or VCR Plus+ recording.

After you set a program to be recorded, an “R” icon will appear next to the listing for that program.

Note: Do not change channels on the TV or VCR during recording. If you have a Cable box, do not change channels on the TV during recording or the Cable box channel will change.

To use one-touch recording:

1. In the LISTINGS menu, select the program you want to record.
2. Press the GREEN button.
3. Select one of the following:
 - ONCE—records the selected program only on that day.
 - WEEKLY—records every week on the same day and at the same time, even if the program titles are different.
 - REGULARLY—records the selected program every day it appears at the same time on the same channel.
4. Before the recording start time, put a tape in the VCR and turn OFF the VCR.

Note: Digital broadcast channels cannot be scheduled for recording using the TV Guide On Screen feature.

To use VCR Plus+ recording:

Press the VCR+ button on the remote control to schedule a recording using PlusCode numbers from your local TV listing publications. You also can view PlusCode numbers by selecting a program in the TV Guide On Screen system and pressing the INFO button.

To view a list of all programs you scheduled to record, to cancel a recording, or to change the frequency of a recording:

1. With the TV Guide On Screen system open, press MENU and select the SCHEDULE menu.
2. Select RECORD. The programs you scheduled to record will be listed. You can then either cancel any of the recordings or change their frequency.

Note: You also can cancel recordings in the LISTINGS menu.

LISTINGS menu (continued)

Viewing panel ads and channel ads

Panel ads and channel ads provide promotional information for programs or products. Before your TV has received its first program listing download from the TV Guide On Screen system, the panel ad windows will display TV Guide On Screen features and operating tips.

- Select a panel ad or channel ad and press INFO to display detailed information. (Channel ads typically appear on the second or third line of the LISTINGS menu.)
- When you select an ad for a program, you can set the program as a favorite or to record. These programs also will appear in the SCHEDULE menu.

Using the Menu Bar to access other menus

Press MENU and then use the ◀▶ buttons to access the other menus in the TV Guide On Screen system. These menus include SORT, SCHEDULE, PROMOTIONS, MESSAGES, and SETUP, as described below.



Panel ad windows

SORT menu

You can use the SORT menu to browse eight days of program listings sorted by one of the following categories:

- Movies
- Sports
- Children's programs
- Educational programs
- News
- Variety
- Series
- Alphabetically

Note: These categories may change from time to time as new data is received from the TV Guide On Screen service.

To open the SORT menu:

1. Press GUIDE to open the TV Guide On Screen system.
2. Press MENU to select the Menu Bar.
3. Use the ◀▶ buttons to select the SORT menu.
4. Use the ▲▼ buttons to highlight an item, and then press ENTER to open the item.

You can select a subcategory for each theme, and scroll through the listings for all stations in the subcategory.

- Use the ▲▼ buttons to browse up/down through the sorted listings.
- Use the ▶ button to move forward 24 hours and the ◀ button to move backward 24 hours.

From the SORT menu, you can schedule programs as favorites or to record, or open INFO windows for a selected listing. (For details on the FAVORITE, RECORD, and INFO buttons, see pages 56–57).

Sort menu – Alphabetical sort

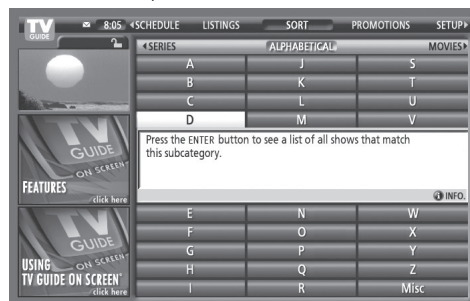

Sort menu – Children / All sort



Sort menu – Movies sort



SCHEDULE menu

The SCHEDULE menu displays a list of the programs you set as favorites or to record.

FAVORITES SCHEDULE

The FAVORITES SCHEDULE displays a list of the programs you set as favorites. (These programs are listed with a heart icon in the LISTINGS menu; see page 57.)

You can use this list to remove favorites or change their frequency (see below).

To remove a favorite program or change its frequency:

1. Select the program in the FAVORITES sub-menu of the SCHEDULE menu.
2. Press the BLUE button to remove the program; press the GREEN button to change its frequency.

RECORD SCHEDULE

The RECORD SCHEDULE displays a list of the programs you set to record. (These programs are listed with an “R” icon in the LISTINGS menu.)

You can use this list to remove programs or change their frequency (see below).

To remove a recording or change its frequency:

1. Select the program in the RECORD sub-menu of the SCHEDULE menu.
2. Press the BLUE button to remove the program; press the GREEN button to change its frequency.

SCHEDULE menu with RECORD sub-menu selected

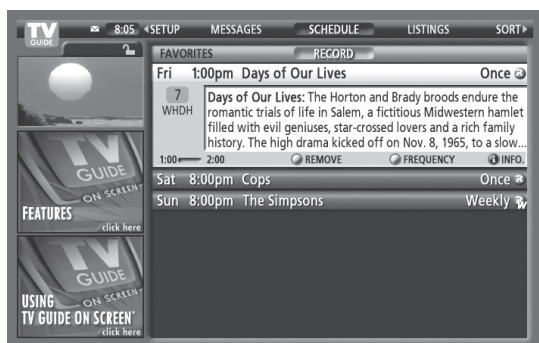

SETUP menu



SETUP menu

The SETUP menu allows you to change your TV Guide On Screen system settings, change the channel display, and turn the auto display feature on and off.

To open the SETUP menu:

1. Press GUIDE to open the TV Guide On Screen system.
2. Press MENU to select the Menu Bar.
3. Use the ◀▶ buttons to select the SETUP menu.
4. Use the ▲▼ buttons to highlight an item, as described below.

Note: The picture in the Video Window will change as you scroll through the listings in the SETUP menu, even if the Video Window is locked.

Change system settings

To change your TV Guide On Screen system settings:

1. In the SETUP menu, highlight CHANGE SYSTEM SETTINGS, and then press ENTER.
2. Follow the on-screen prompts.

Change channel display

You can customize the channel list as follows:

- Choose which channels are displayed in the LISTINGS menu by turning them ON or OFF.
- Change the order in which the channels are listed in the LISTINGS menu.
- Reassign channel numbers (if the number displayed in the Listings does not match the actual channel number you use to tune the channel).

To customize the channel list:

1. In the SETUP menu, highlight CHANGE CHANNEL DISPLAY, and then press ENTER.
2. Follow the on-screen prompts.

To change the channel order: Highlight the station call letters, and then press the BLUE button to move the channel up, the GREEN button to move the channel down, or the Channel Number buttons to assign the position by number.

To reassign a channel number: Highlight the channel number and then press the Channel Number buttons on the remote control to key the new number.

Review options (change the auto display setting)

The TV Guide On Screen program guide automatically opens each time you turn on the TV.

To disable or enable the auto display setting feature:

1. In the SETUP menu, highlight REVIEW OPTIONS, and then press ENTER.
2. Select NO to disable the feature; select YES to enable it.

PROMOTIONS menu

The PROMOTIONS menu displays a list of the promotions that appear in the panel ad window, along with TV Guide On Screen features and tips.

To open the PROMOTIONS menu:

1. Press **GUIDE** to open the TV Guide On Screen system.
2. Press **MENU** to select the Menu Bar.
3. Use the **◀▶** buttons to select the PROMOTIONS menu.
4. Use the **▲▼** buttons to highlight an item, and then press **INFO** to display the item.

To closed an expanded promotion INFO window:

Press the **▶** button.

PROMOTIONS menu



Panel ad window

MESSAGES menu

The MESSAGES menu displays a list of messages containing consumer information sent to you by the TV Guide On Screen service.

To open the MESSAGES menu:

1. Press **GUIDE** to open the TV Guide On Screen system.
2. Press **MENU** to select the Menu Bar.
3. Use the **◀▶** buttons to select the MESSAGES menu.
4. Use the **▲▼** buttons to highlight a message, and then press **ENTER** to open the message.

MESSAGES menu

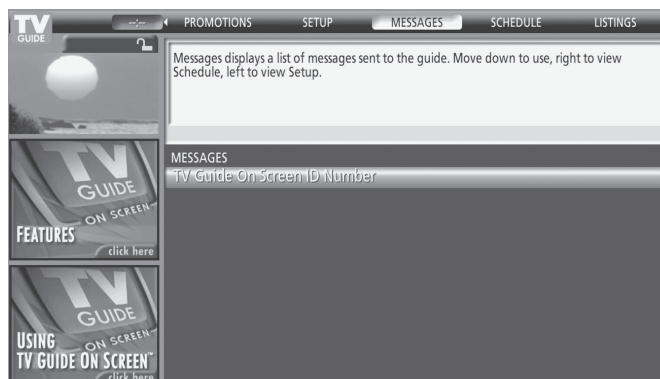

Troubleshooting

See Chapter 10: Troubleshooting for a list of frequently asked questions about setup and operation of the TV Guide On Screen system and for general TV troubleshooting tips.

8 Using the TV's features

Selecting the video input source to view

To select the video input source to view:

1. Press INPUT on the remote control or TV/VIDEO on the TV front panel.
2. Press 0–7 to select the input source you want to view, depending on which input jacks you used for connecting your devices (see “Connecting your TV” on pages 9–25).

The current signal source displays at the top of the INPUT SELECTION screen.

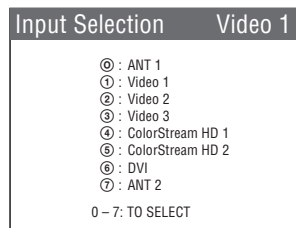

Note:

- You also can repeatedly press the INPUT or TV/VIDEO button to select the source.
- You can label the video input sources according to the specific devices you have connected to the TV (see next page).
- To select an IEEE-1394 input source, press the TheaterNet button on the remote control (see page 45).

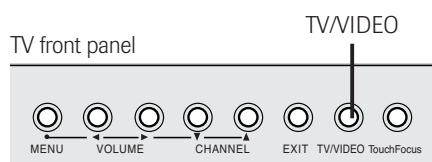
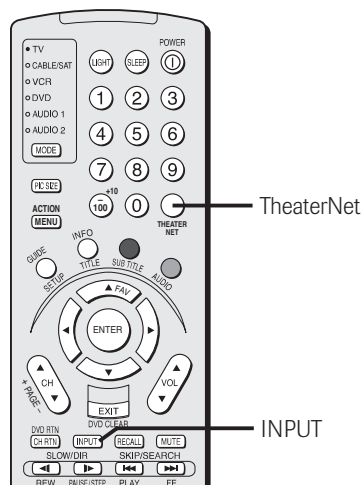

Using the digital tuner hold

The digital tuner hold helps to protect the digital tuner's signal when you record a digital signal. If you are recording to a D-VHS device, the digital tuner hold is automatically activated. If you are recording to an analog VCR using the REC OUT jacks, you need to manually turn on the digital tuner hold.

To manually turn on the digital tuner hold:

1. Press MENU and open the SETUP menu.
2. Highlight DIGITAL TUNER HOLD and press ENTER.
3. Highlight ON and press ENTER.

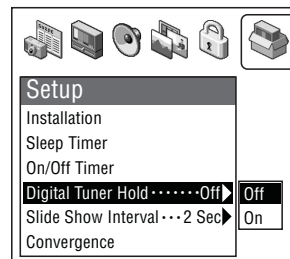

To turn off the digital tuner hold:

Highlight OFF in step 3 above.

Note:

- If you turn ON the digital tuner hold when ANT 1 is the selected input source, you cannot change to the ANT 2 input source, and vice versa.
- When ANT 2 is the selected input source, if you manually turn on the digital tuner hold and then open the TV Guide On Screen system, the Video Window may not display a picture. If this happens and you want to use the TV Guide On Screen system, turn off the digital tuner hold and select ANT 1 or VIDEO 1 as the input source.

Labeling the video input sources

You can label each video input source according to the type of device you connected to each source, from the following preset list of labels:

- (default label)
- Audio Receiver
- VCR
- Video Recorder
- Laser Disk
- Compact Disc
- DVD
- DTV
- SAT (Satellite box)
- CBL (Cable box)
- HD (High-definition device)

Note:

- If you set up devices in TheaterNet, the associated inputs are automatically labeled and cannot be relabeled until you remove the device from TheaterNet (see page 45).
- You cannot select IEEE-1394 devices through the INPUT SELECTION window; however, you can select and control IEEE-1394 devices through TheaterNet (see page 45).

To label the video input sources:

1. Press MENU and open the PREFERENCES menu.
2. Highlight INPUT LABELING and press ENTER.

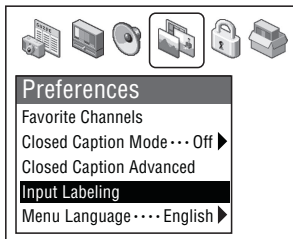

3. Press ▼ or ▲ to highlight the video source you want to label.
4. Press ◀ or ▶ to select the desired label for that input source.

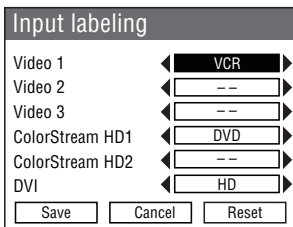

5. To save the labels, highlight SAVE and press ENTER.

Input labeling example:

If you connect a VCR to VIDEO 1, a DVD player to ColorStream HD-1, and a high-definition device to DVI/HDCP, and then label the video input sources accordingly (as shown in step 4 at left), when you press INPUT or TV/VIDEO, the INPUT SELECTION screen would then look like the screen below right:

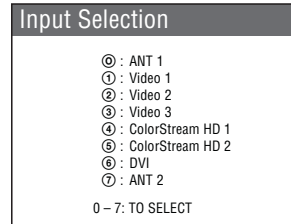

Input Selection screen with no inputs labeled

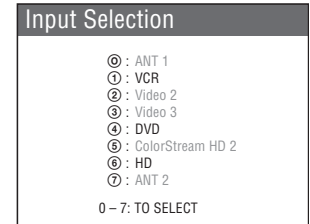

Input Selection screen with inputs 1, 4, and 6 labeled

To clear the video labels:

1. Press MENU and open the PREFERENCES menu.
2. Highlight INPUT LABELING and press ENTER.
3. Highlight RESET and press ENTER.
4. Highlight SAVE and press ENTER.

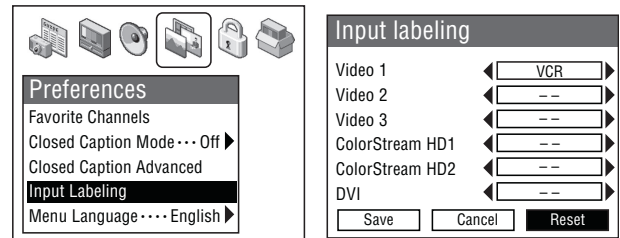

Note: Labels for devices you set up in TheaterNet will not be cleared until you remove the device from TheaterNet (see page 45). The screen above right illustrates an example of the Input Labeling screen after it was reset that still shows the VCR label for VIDEO 1 because the VCR was set up in TheaterNet.

Tuning channels

Tuning to the next programmed channel

Note: This feature will not work unless you program channels into the TV's channel memory (see page 42).

To tune to the next programmed channel:

Press CHANNEL ▲ or ▼ on the remote control or TV front panel.

Using SpeedSurf to change to a specific programmed channel

Note: This feature will not work unless you program channels into the TV's channel memory (see page 42).

1. Press and hold CHANNEL ▲ or ▼ for a few seconds. The TV will enter SpeedSurf mode.

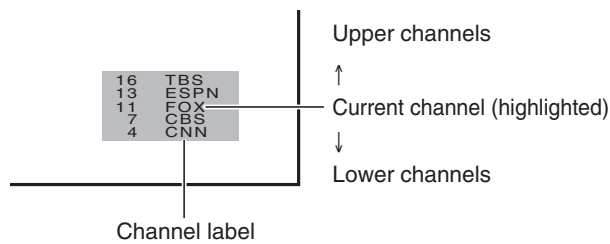

2. Repeatedly press or hold CHANNEL ▲ or ▼ while the SpeedSurf mode is on-screen to scroll through the channel list. Release the button to display the highlighted channel.

Tuning to a specific channel (programmed or unprogrammed)

Tuning analog channels:

Press the Channel Number buttons (0–9) on the remote control. For example, to select channel 125, press 1, 2, 5.

Tuning digital channels:

Press the Channel Number buttons (0–9) on the remote control, followed by the – (dash) button and then the sub-channel number.

For example, to select digital channel 125-1, press 1, 2, 5, –, 1.

Switching between two channels using Channel Return

The Channel Return feature allows you to switch between two channels without entering an actual channel number each time.

1. Select the first channel you want to view.
2. Select a second channel using the Channel Number buttons (and the dash (–) button if selecting a digital channel).
3. Press CH RTN on the remote control. The previous channel will display.

Each time you press CH RTN, the TV will switch back and forth between the last two channels that were selected.

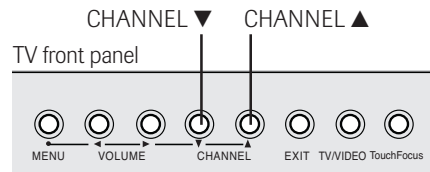
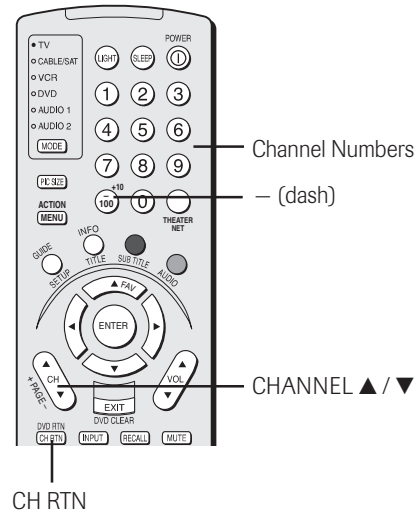

Selecting the picture size

You can view many program formats in a variety of picture sizes—Natural, Theater Wide 1, Theater Wide 2, Theater Wide 3, and Full—as described below and on the next page.

The way the image displays in any of the picture sizes will vary depending on the format of the program you are viewing. Select the picture size that displays the current program the way that looks best to you. *See “Notice of possible adverse effects on TV picture tube,” below right.*

To select the picture size:

1. Press PIC SIZE on the remote control.
2. While the Picture Size menu is on-screen, press the corresponding number button (0–4) to select the desired picture size.

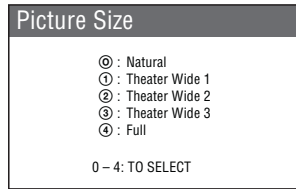

Note: You also can repeatedly press PIC SIZE to select the desired picture size.

Natural picture size

In Natural picture size, the program will be displayed close to its originally formatted proportion. Some program formats will display with side bars and/or bars at the top and bottom (see examples below).

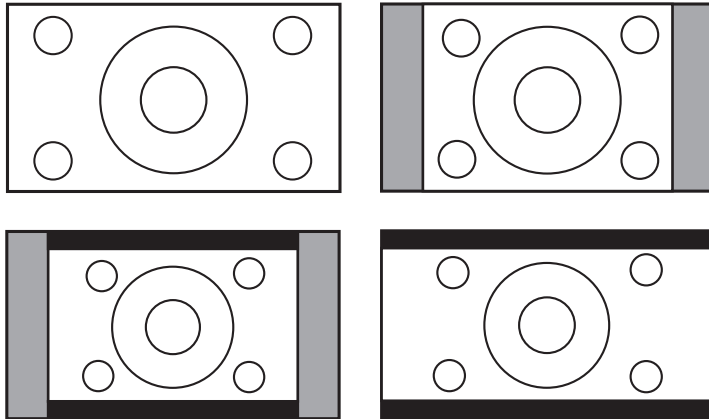

Natural picture size examples: The way the image displays will vary depending on the format of the program you are currently watching. See “Notice of possible adverse effects on TV picture tube” at right.

Note:

The PICTURE SIZE feature is not available for some program formats or signals, including a ColorStream or DVI input with a 720p or 1080i signal. If you are viewing one of these formats and press PIC SIZE on the remote control, the words “Not Available” will appear on-screen.

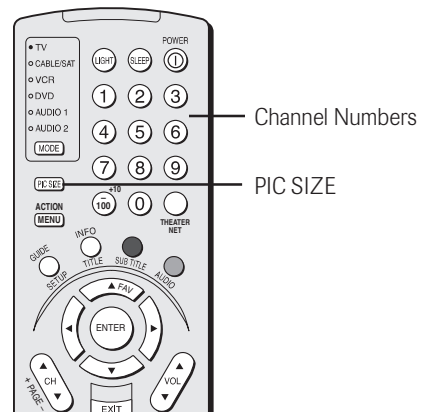

NOTICE OF POSSIBLE ADVERSE EFFECTS ON TV PICTURE TUBE

Avoid displaying stationary images on your TV screen for extended periods of time. Fixed (non-moving) images (such as still PIP/POP windows or black/gray bars in wide-screen picture or PIP/POP formats) can become permanently engrained in the picture tube. **This type of damage is NOT COVERED BY YOUR WARRANTY** because it is the result of misuse. See item 33 on page 4.

Selecting the picture size (continued)

Theater Wide 1 picture size

- The picture is non-uniformly enlarged—the center of the picture remains close to its original proportion, but the left and right edges are stretched wider to fill the screen.
- A small part of the picture (at the top and bottom) is hidden; however, this mode cannot be scrolled.

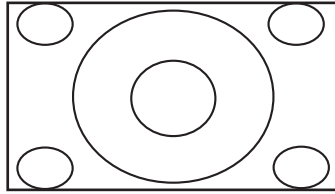

Theater Wide 1 picture size example

Theater Wide 2 picture size

- The entire picture is uniformly enlarged—it is stretched the same amount both wider and taller (retains its original proportion).
- Part of the picture at the top and bottom is hidden. To view the hidden areas, see “Scrolling the Theater Wide picture” on page 66.

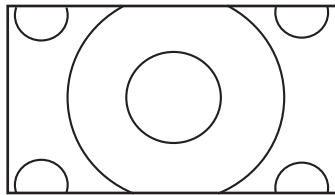

Theater Wide 2 picture size example

Theater Wide 3 picture size

- The picture is non-uniformly enlarged—it is stretched wider to fill the width of the screen, but only slightly stretched taller.
- A small part of the picture at the top and bottom is hidden. To view the hidden areas (such as subtitles or captions), see “Scrolling the Theater Wide picture” on page 66.

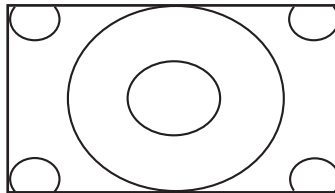

Theater Wide 3 picture size example

Full picture size

- The picture is non-uniformly enlarged—it is stretched wider to fill the width of the screen, but not stretched taller.
- None of the picture is hidden.

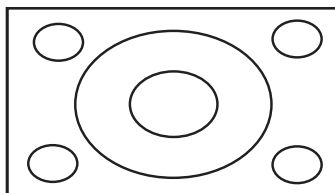

Full picture size example

To select the picture size, press PIC SIZE on the remote control.

You also can select the picture size using the menu system. Select PICTURE SIZE in the VIDEO / THEATER SETTINGS menu.

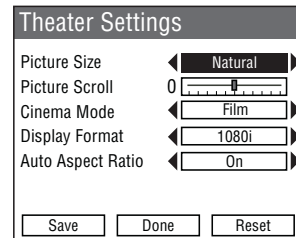

Note:

- If you select one of the Theater Wide picture sizes, the top and bottom edges of the picture (including subtitles or captions) may be hidden. To view the hidden edges, either scroll the picture (Theater Wide 2 and 3 only) or try viewing the program in Full or Natural picture size.
- When selecting the picture size, the way the image displays will vary depending on the format of the program you are currently watching. See “Notice of possible adverse effects on TV picture tube” below.

NOTICE OF POSSIBLE ADVERSE EFFECTS ON TV PICTURE TUBE

Avoid displaying stationary images on your TV screen for extended periods of time. Fixed (non-moving) images (such as still PIP/POP windows or black/gray bars in wide-screen picture or PIP/POP formats) can become permanently engrained in the picture tube. **This type of damage is NOT COVERED BY YOUR WARRANTY** because it is the result of misuse. See item 33 on page 4.

Using the special functions to change the size of the displayed image (i.e. changing the height/width ratio) for the purpose of public display or commercial gain may infringe on copyright laws.

Scrolling the Theater Wide picture (Theater Wide 2 and 3 only)

You can set separate scroll settings for Theater Wide 2 and Theater Wide 3 modes.

To set the scroll settings:

1. Press MENU and open the VIDEO menu.
2. Highlight THEATER SETTINGS and press ENTER.

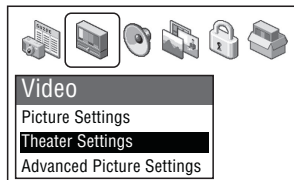

3. In the PICTURE SIZE field, select either Theater Wide 2 or Theater Wide 3 (you cannot scroll in any other mode).
4. Press ▼ to highlight the PICTURE SCROLL field.
5. Press ◀ or ▶ to scroll the picture as needed, from -10 to +20.

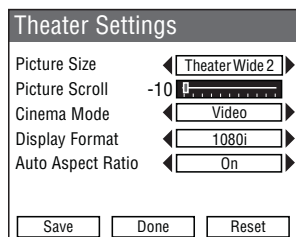
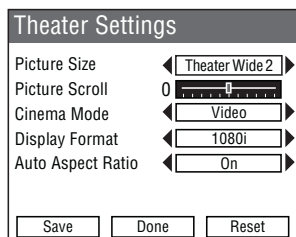

6. To save your scroll settings temporarily, highlight DONE and press ENTER.
To save your scroll settings permanently, highlight SAVE and press ENTER.

Using the auto aspect ratio feature (480i signals only)

When the AUTO ASPECT feature is set to ON and the TV receives a 480i signal, the picture size is automatically selected, as described in the following table.

Aspect ratio of signal source	Automatic aspect size (automatically selected when AUTO ASPECT is ON)
4:3	Theater Wide 2
16:9	Full
Not defined (no ID-1 data)	User-selected picture size (see pages 64–65)

Note:

- The AUTO ASPECT feature applies to 480i signals received from the VIDEO 1, VIDEO 2, VIDEO 3, or ColorStream HD1/HD2 input sources only, and is not applicable to antenna, Cable, or DVI input sources.
- The AUTO ASPECT feature is not available when the POP double-window is open.

To turn on the AUTO ASPECT feature:

1. Press MENU and open the VIDEO menu.
2. Highlight THEATER SETTINGS and press ENTER.

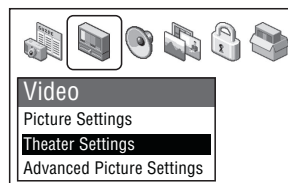

3. In the AUTO ASPECT RATIO field, select ON.
4. To save your settings temporarily, highlight DONE and press ENTER.

To save your settings permanently, highlight SAVE and press ENTER.

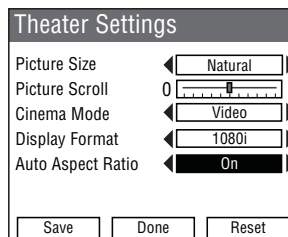

To turn off the AUTO ASPECT feature:

Select OFF in step 3 above.

Selecting the cinema mode

When you view a DVD (3:2 pulldown processed) from a DVD player connected to the ColorStream (component video) or DVI/HDCP inputs on the TV, smoother motion can be obtained by setting the CINEMA MODE to FILM.

To set the CINEMA MODE to FILM:

1. Press MENU and open the VIDEO menu.
2. Highlight THEATER SETTINGS and press ENTER.

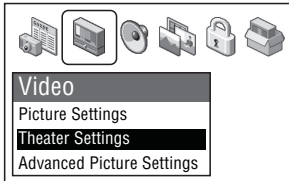

3. In the CINEMA MODE field, select FILM.

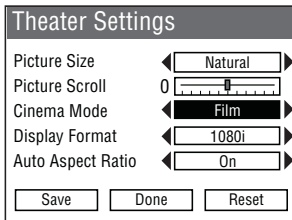

4. To save your settings temporarily, highlight DONE and press ENTER.
To save your settings permanently, highlight SAVE and press ENTER.

To set the CINEMA MODE to VIDEO:

Select VIDEO in step 3 above.

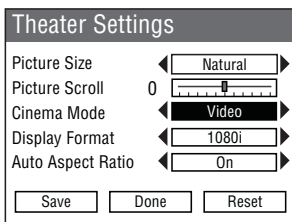

Selecting the display format (480p signals only)

You can use this feature to convert a 480p input signal to 540p or 1080i.

To select the display format:

1. Press MENU and open the VIDEO menu.
2. Highlight THEATER SETTINGS and press ENTER.

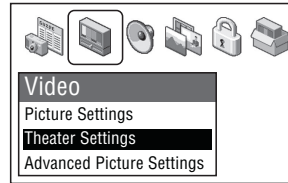

3. In the DISPLAY FORMAT field, select either 540p or 1080i.

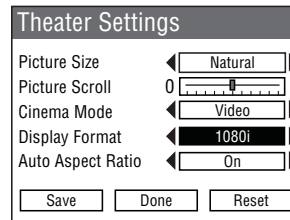

4. To save your settings temporarily, highlight DONE and press ENTER.
To save your settings permanently, highlight SAVE and press ENTER.

Note:

- Input signals other than 480p are automatically converted to 1080i.
- If you notice flicker in a 480p image, try setting the DISPLAY FORMAT to 540p.

Using the POP features

Using the POP double-window feature

The POP (picture-out-picture) double-window feature splits the screen into two windows so you can watch two programs at the same time. The program displayed in the POP window can come from a TV broadcast or an external device.

To display a program in the POP window:

1. Select the program you want to watch in the main window.
2. Press SPLIT to open the POP window.

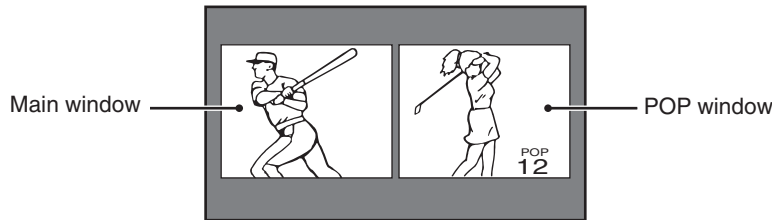

3. Press SOURCE to open the POP INPUT SELECTION window. Select the input source for the POP window by pressing the corresponding Number button (0–7). The current source displays in purple.

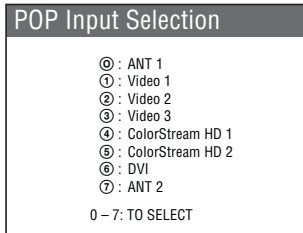

4. If you select the ANT 1 or ANT 2 input source for the POP window, you can change the POP TV channel in the following two ways:

- To change to a specific channel, press POP DIRECT CH. While the word “POP” is on-screen, press the Channel Number buttons for the channel you want to watch in the POP window.
- To change to the next programmed channel, press POP CH ▲ or ▼.

If you try to watch a TV program that exceeds your set rating limits, the program will be blocked (see “Using the Locks menu” on pages 84–87).

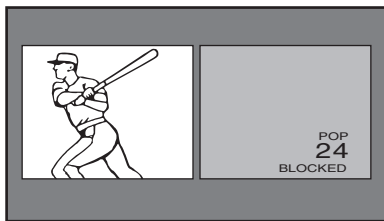

To close the POP window:

Press SPLIT or EXIT.

Note:

- You cannot view digital programs in the POP window.
- You can choose to output the sound of either the main or POP program from the AUDIO OUT jacks (see “Connecting two VCRs” on page 17 and “Selecting the AUDIO OUT sound” on page 79).

NOTICE OF POSSIBLE ADVERSE EFFECTS ON TV PICTURE TUBE

Avoid displaying stationary images on your TV screen for extended periods of time. Fixed (non-moving) images (such as still PIP/POP windows or black/gray bars in wide-screen picture or PIP/POP formats) can become permanently engrained in the picture tube. **This type of damage is NOT COVERED BY YOUR WARRANTY** because it is the result of misuse. See item 33 on page 4.

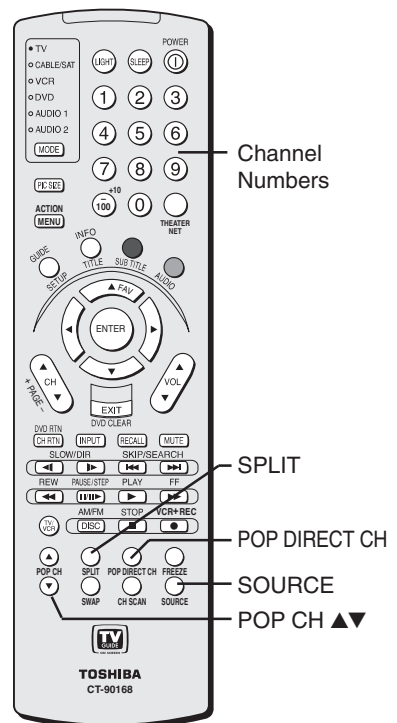

Using the POP features (continued)

Switching the main and POP pictures

Press SWAP while the POP double-window is open to switch the main and POP pictures. **Note:** This feature is not available when viewing a digital source in the main window.

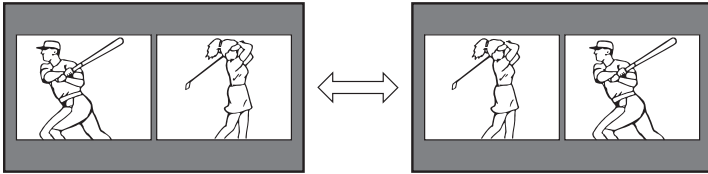

Freezing the main picture in the POP double-window

1. While the POP double-window is **not** open, press FREEZE. The POP window will open, displaying the main picture as a still picture.
2. Continue to press FREEZE repeatedly to refresh the still picture in the POP window, which acts as a slow “strobe” of the program in the main window.

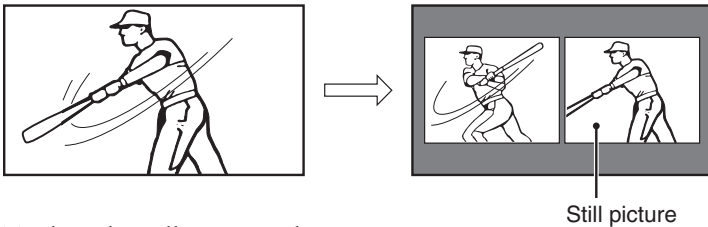

To close the still POP window:

Press EXIT.

Adjusting the size of the main and POP pictures

You can adjust the size of the main and POP pictures in the double-window. Repeatedly press ◀ or ▶ to change the size. See notes at right.

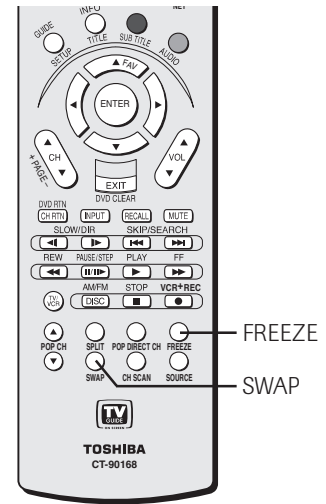
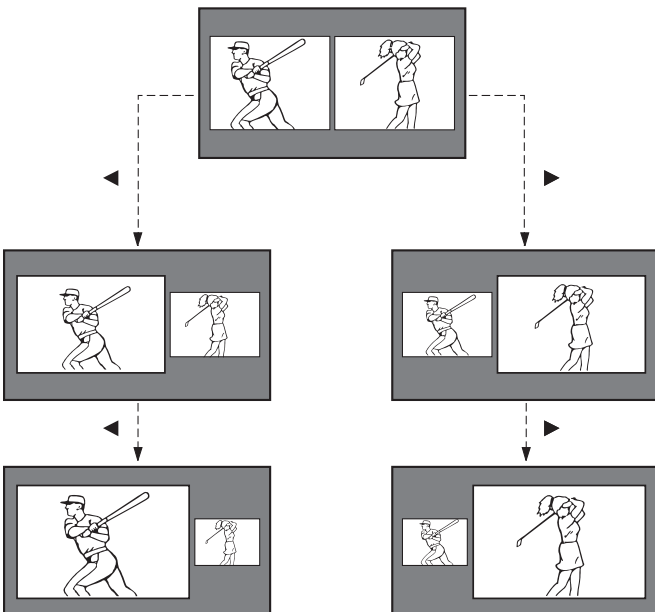

Note: The FREEZE feature is not available when the POP window is already open. If you press FREEZE when the POP window is open, the message “Not available” will appear.

Note:

- The size of the POP double-window pictures cannot be adjusted for some signal formats.
- The ◀ button enlarges the main picture and reduces the POP picture.
- The ▶ button reduces the main picture and enlarges the POP picture.

NOTICE OF POSSIBLE ADVERSE EFFECTS ON TV PICTURE TUBE

Avoid displaying stationary images on your TV screen for extended periods of time. Fixed (non-moving) images (such as still PIP/POP windows or black/gray bars in wide-screen or PIP/POP formats) can become permanently engrained in the picture tube. **This type of damage is NOT COVERED BY YOUR WARRANTY** because it is the result of misuse. See item 33 on page 4.

Using the POP features (continued)

POP double-window aspect ratio

The POP double-window feature displays each picture according to its input signal aspect ratio, as illustrated below.



Using the programmed channel scan feature

You can use this feature to quickly scan and tune the channels you programmed into the TV's channel memory.

Note: This feature will not work until you program channels into the TV's memory (see page 42).

To scan the programmed channels:

1. Press CH SCAN. The TV automatically enters POP multi-window mode, and begins a seven-picture scan of your programmed channels. The channels displayed in the seven POP multi-windows will continue to change, to allow you to scan all programmed channels.

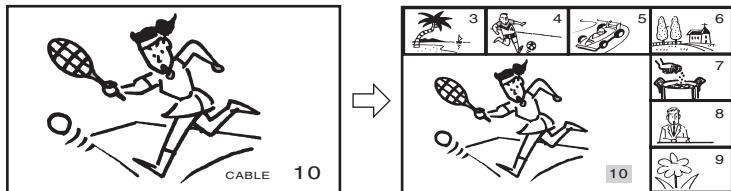

2. Press ▲▼◀▶ to select one of the seven pictures, which becomes a moving picture. (The main picture is always moving.)
3. Press ENTER to display the channel you selected in step 2 as the main picture.

To cancel the channel scan without changing the channel:

Press EXIT.

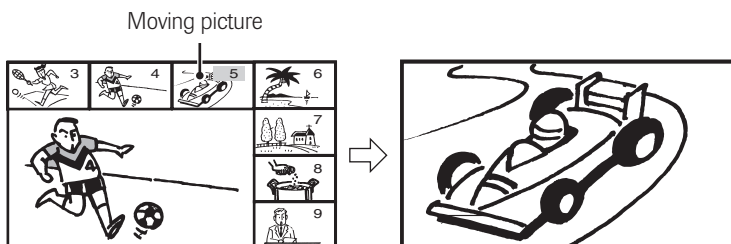

Note:

The AUTO ASPECT RATIO feature (page 66) does not operate in POP double-window mode.

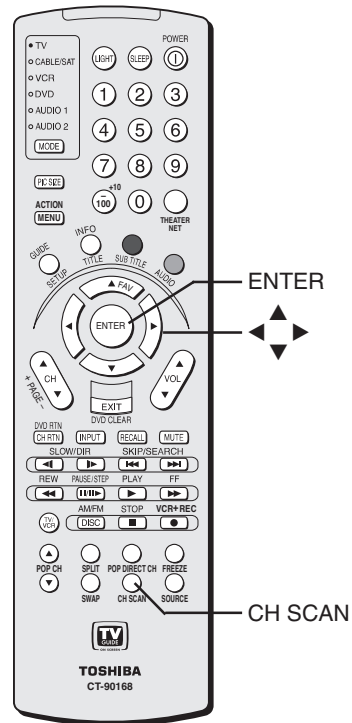

Note:

- During the programmed channel scan, the main and POP windows display in 16:9 aspect ratio, regardless of the signal format.
- Digital channels will not display in the POP multi-windows.

NOTICE OF POSSIBLE ADVERSE EFFECTS ON TV PICTURE TUBE

Avoid displaying stationary images on your TV screen for extended periods of time. Fixed (non-moving) images (such as still PIP/POP windows or black/gray bars in wide-screen picture or PIP/POP formats) can become permanently engrained in the picture tube. **This type of damage is NOT COVERED BY YOUR WARRANTY** because it is the result of misuse. See item 33 on page 4.

Using the POP features (continued)

Using the favorite channel search feature

You can use the favorite channel search feature to quickly scan the channels you programmed as favorite channels in a seven-picture POP multi-window.

Note: The favorite channel search feature will not work unless you program channels into the favorite channel memory (see "Programming your favorite channels" on page 44).

To scan and tune your favorite channels:

1. Press FAV. The TV automatically enters POP multi-window mode, and begins a seven-picture scan of your favorite channels.
- The favorite channels in Set 1 appear first. To view the favorite channels in Set 2, press SWAP.

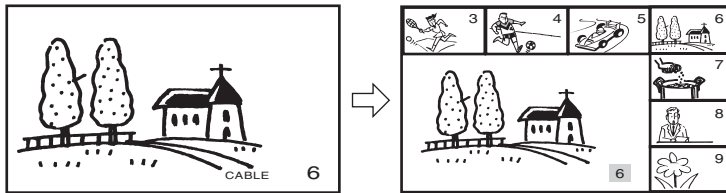

2. Press ▲▼◀▶ to select one of the seven pictures, which becomes a moving picture. (The main picture is always moving.)
3. Press ENTER to display the channel you selected in step 2 as the main picture.

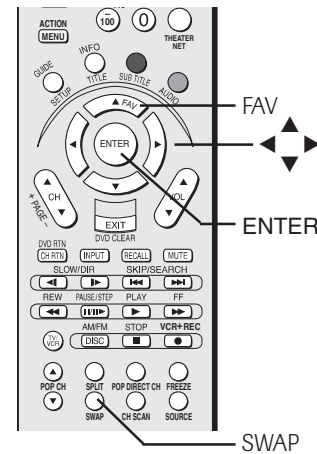
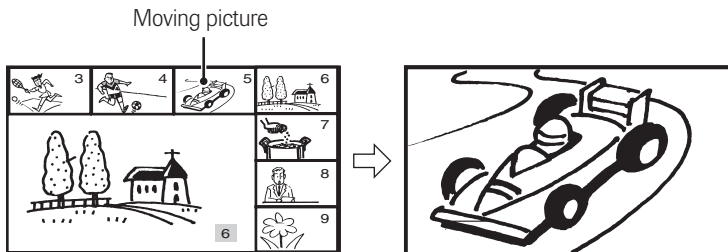

Note:

- Digital channels will not display in the POP multi-windows.
- The FAV button functions as the ▲ (up) button when a menu is on-screen.

NOTICE OF POSSIBLE ADVERSE EFFECTS ON TV PICTURE TUBE

Avoid displaying stationary images on your TV screen for extended periods of time. Fixed (non-moving) images (such as still PIP/POP windows or black/gray bars in wide-screen picture or PIP/POP formats) can become permanently engrained in the picture tube. **This type of damage is NOT COVERED BY YOUR WARRANTY** because it is the result of misuse. See item 33 on page 4.

Adjusting the picture

Selecting the picture mode

You can select your desired picture settings from four picture modes, as described below.

Mode	Picture Quality
Sports	Bright and dynamic picture (factory setting)
Standard	Standard picture settings (factory setting)
Movie	Lower contrast for darkened room (factory setting)
Preference	Your personal preferences

To select the picture mode:

1. Press MENU and open the VIDEO menu.
2. Highlight PICTURE SETTINGS and press ENTER.

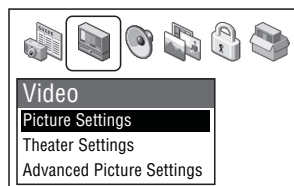

3. Press ▼ to highlight the MODE field, and then ◀▶ to select the mode you prefer.

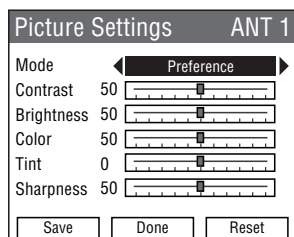

4. To temporarily save the mode you selected, highlight DONE and press ENTER.

To permanently save the mode you selected, highlight SAVE and press ENTER.

Note:

- The picture mode you selected is for the current input selection only (ANT 1 in the example above). You can select a different picture mode for each input selection.
- If you select one of the factory-set picture modes (SPORTS, STANDARD, or MOVIE) and then change a picture quality setting (for example, increase the contrast), the picture mode automatically changes to PREFERENCE in the Picture Settings menu.
- Temporarily saved settings will apply until the TV is turned off or the input source is changed.

Adjusting the picture quality

You can adjust the picture quality (contrast, brightness, color, tint, and sharpness) to your personal preferences.

To adjust the picture quality:

1. Press MENU and open the VIDEO menu.
2. Highlight PICTURE SETTINGS and press ENTER.
3. Press ▼ or ▲ to select the picture quality you want to adjust (CONTRAST, BRIGHTNESS, COLOR, TINT, or SHARPNESS), and then ◀ and ▶ to adjust the setting, as described in the table below.

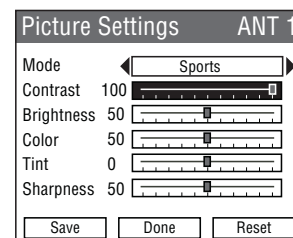
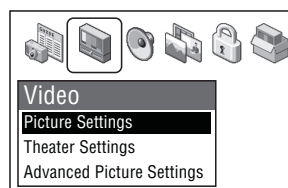

Selection	◀ Pressing ▶	
contrast	lower	higher
brightness	darker	lighter
color	paler	deeper
tint	reddish	greenish
sharpness	softer	sharper

4. To temporarily save the new settings, highlight DONE and press ENTER. To permanently save the new settings, highlight SAVE and press ENTER.

Note: The settings you selected are for the current input selection only (ANT 1 in the example above). You can select different settings for each input selection.

The picture qualities you adjusted are automatically saved in the PREFERENCE mode (see “Selecting the picture mode” above).

Resetting the picture settings

To reset the picture settings to their factory values:

1. Highlight RESET in the Picture Settings menu and press ENTER.
2. Highlight SAVE and press ENTER.

Note: This resets the pictures settings for the current input source only (ANT 1 in this example).

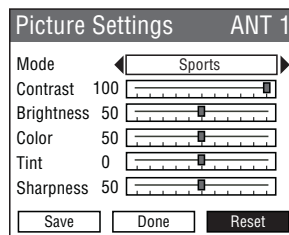

Adjusting the picture (continued)

Using the ALS (ambient light sensor)

The ALS feature automatically adjusts the picture contrast based on the room's current lighting conditions. For example, when the room is dark, the ALS will automatically reduce the contrast, which reduces eye strain. The ALS is activated when the ALS is set to ON.

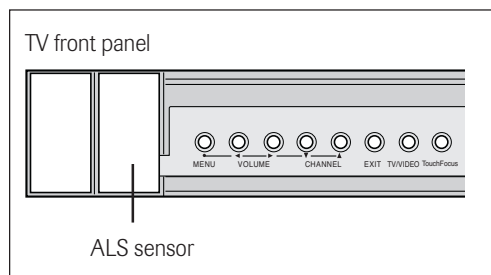

To activate the ALS:

1. Press MENU and open the VIDEO menu.
2. Highlight ADVANCED PICTURE SETTINGS and press ENTER.
3. Press ▼ to highlight the ALS field, and then press ► to select ON.

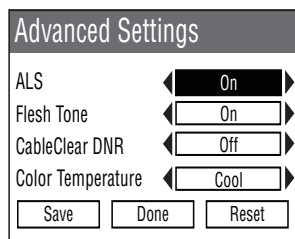
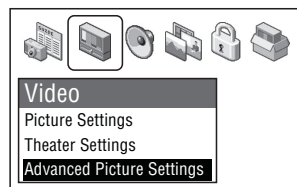

4. To temporarily save the new settings, highlight DONE and press ENTER.

To permanently save the new settings, highlight SAVE and press ENTER.

Note:

- When the ALS feature is on, the CONTRAST setting (page 72) changes to AUTO and is not adjustable.
- Do not cover the ALS sensor on the TV front panel or the ALS will not work properly.

To deactivate the ALS:

Select OFF in step 3 above.

Using the flesh tone feature

This feature automatically adjusts the tint to display more natural flesh tones.

To turn on the flesh tone feature:

1. Press MENU and open the VIDEO menu.
2. Highlight ADVANCED PICTURE SETTINGS and press ENTER.
3. Press ▼ to highlight the FLESH TONE field, and then press ► to select ON.

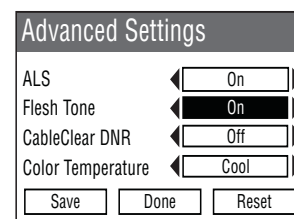
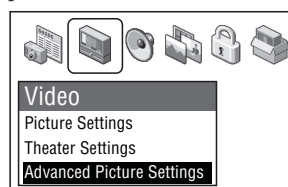

4. To temporarily save the new settings, highlight DONE and press ENTER.

To permanently save the new settings, highlight SAVE and press ENTER.

To turn off the flesh tone feature:

Select OFF in step 3 above.

Adjusting the picture (continued)

Using CableClear™ DNR (digital noise reduction)

The CableClear digital noise reduction feature allows you to reduce visible interference in your TV picture. This is useful when receiving a broadcast with a weak signal (especially a Cable channel) or playing back a video cassette or disc damaged by repeated use.

Note: The CableClear DNR feature does not function in DVI, ATSC, digital Cable, VIDEO, and ColorStream modes.

To turn on CableClear DNR:

1. Press MENU and open the VIDEO menu.
2. Highlight ADVANCED PICTURE SETTINGS and press ENTER.
3. Press ▼ to highlight the CABLECLEAR DNR field, and then press ► to select AUTO.

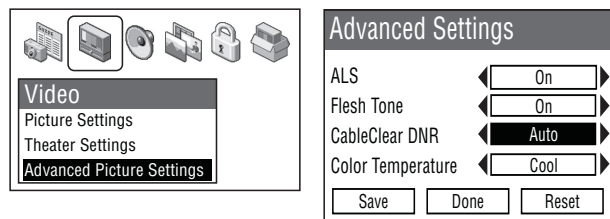

4. To temporarily save the new settings, highlight DONE and press ENTER.

To permanently save the new settings, highlight SAVE and press ENTER.

To turn off CableClear DNR:

Select OFF in step 3 above.

Selecting the color temperature

You can change the quality of the picture by selecting from three preset color temperatures: cool, medium, and warm, as described below.

Mode	Picture Quality
cool	blueish
medium	neutral
warm	reddish

To select the color temperature:

1. Press MENU and open the VIDEO menu.
2. Highlight ADVANCED PICTURE SETTINGS and press ENTER.
3. Press ▼ to highlight the COLOR TEMPERATURE field, and then press ► to select the mode you prefer (COOL, MEDIUM, or WARM).

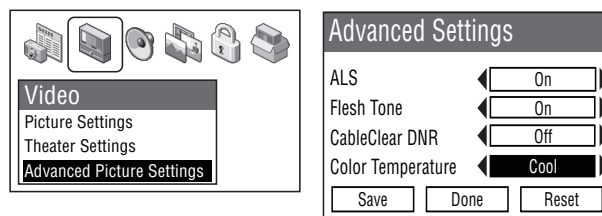

4. To temporarily save the new settings, highlight DONE and press ENTER.

To permanently save the new settings, highlight SAVE and press ENTER.

Resetting the advanced picture settings

To reset the advanced picture settings to their factory values:

1. Press MENU and open the VIDEO menu.
2. Highlight ADVANCED PICTURE SETTINGS and press ENTER.
3. Highlight RESET and press ENTER.

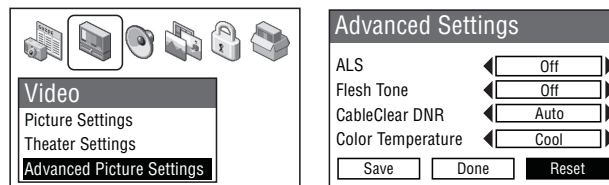

4. Highlight SAVE and press ENTER.

Using the closed caption mode

The closed caption mode has two options:

- **Captions**—An on-screen display of the dialogue, narration, and sound effects of TV programs and videos that are closed captioned (usually marked “CC” in program guides).
- **Text**—An on-screen display of information not related to the current program, such as weather or stock data (when provided by individual stations).

To view captions or text:

1. Press MENU and open the PREFERENCES menu.
2. Highlight CLOSED CAPTION MODE and then press ► to open the menu sidebar.
3. Press ▼ to highlight the desired closed caption mode and then press ENTER.

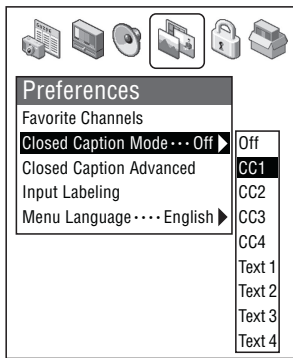

- **To view captions:**
Highlight CC1, CC2, CC3, or CC4. (CC1 displays translation of the primary language in your area.)

Note: If the program or video you selected is not closed captioned, no captions will display on-screen.



- **To view text:**
Highlight Text 1, Text 2, Text 3, or Text 4.

Note: If text is not available in your area, a black rectangle may appear on your screen. If this happens, turn the Closed Caption Mode OFF.

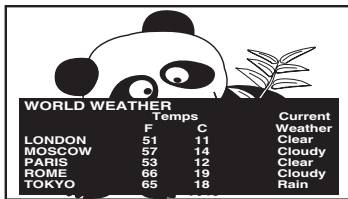

- **To turn off the Closed Caption feature:**
Highlight OFF.

Note: A closed caption signal may not display in the following situations:

- When a videotape has been dubbed
- When the signal reception is weak
- When the signal reception is non-standard

Advanced closed captions

You can customize the closed caption display characteristics by changing the background color and the text size, type, edge, and color.

Note: This feature is available for digital channels only.

To customize the closed captions:

1. Press MENU and open the PREFERENCES menu.
2. Highlight CLOSED CAPTION ADVANCED and press ENTER.

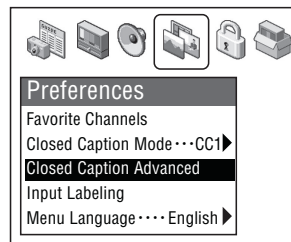

3. Press ▼ or ▲ to highlight the characteristic you want to change, and then press ► to select the format for that characteristic.

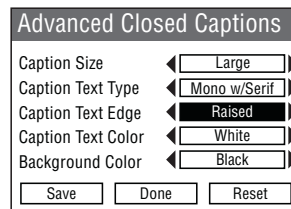

4. To temporarily save the new settings, highlight DONE and press ENTER.

To permanently save the new settings, highlight SAVE and press ENTER.

Note: If you set Caption Text Color to BLACK, do not set Background Color to AUTO or you will not be able to read the captions.

To reset the closed caption characteristics:

1. Highlight RESET in step 4 above, and press ENTER.
2. Highlight SAVE and press ENTER. All characteristics are set to “AUTO.”

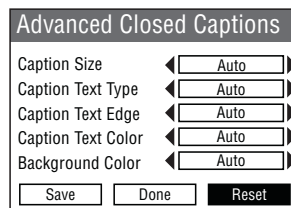

Adjusting the audio

Muting the sound

Press MUTE to temporarily reduce (1/2 MUTE) or turn off (MUTE) the sound. Each time you press MUTE, the mute mode will change in the following order.

→ Normal → 1/2 MUTE → MUTE →

If the closed caption mode is set to OFF when you select "MUTE" mode, the closed caption feature is automatically activated. To mute the audio without automatically activating the closed caption feature, use the VOL ▼ button to set the volume to 0. See "Using the closed caption mode" on page 75 for more information on closed caption modes.

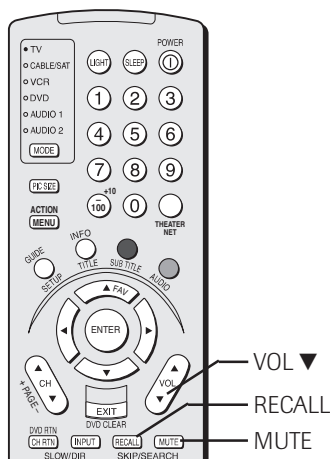

Selecting stereo/SAP broadcasts

The multi-channel TV sound (MTS) feature allows you to output high-fidelity stereo sound from your TV's speakers. MTS also can transmit a second audio program (SAP) containing a second language, music, or other audio information (when provided by individual stations).

The MTS feature is not available when the TV is in VIDEO mode.

When the TV receives a stereo or SAP broadcast, the word "STEREO" or "SAP" appears on-screen when the TV is turned on, the channel is changed, or RECALL is pressed.

To listen to stereo sound:

1. Press MENU and open the AUDIO menu.
2. Highlight AUDIO SETUP and press ENTER.
3. Press ▼ to highlight the MTS field, and then press ► to select STEREO.

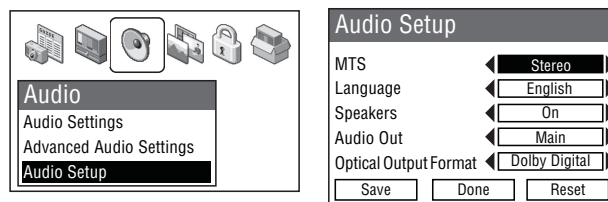

4. To temporarily save the new settings, highlight DONE and press ENTER. To permanently save the new settings, highlight SAVE and press ENTER.

Note:

- You can leave the TV in STEREO mode because it automatically outputs the type of sound being broadcast (stereo or monaural).
- If the stereo sound is noisy, select MONO to reduce the noise.

To listen to an alternate language on an ATSC digital station (if available):

Highlight the LANGUAGE field in step 3 above, and then press ► to select the language you prefer.

To listen to a second audio program on an analog station (if available):

Select SAP in step 3 above.

Note:

- A second audio program (SAP) can be heard only on those TV stations that offer it. For example, a station might broadcast another language as a second audio program. If you have SAP on, you will see the current program on the screen but hear the other language instead of the program's normal audio.
- If you have SAP on and the station you are watching is not broadcasting a second audio program, the station's normal audio will be output. However, occasionally there is no sound at all in SAP mode. If this happens, set the MTS feature to STEREO mode.

Adjusting the audio (continued)

Adjusting the audio quality

You can adjust the audio quality by adjusting the bass, treble, and balance.

To adjust the audio quality:

1. Press MENU and open the AUDIO menu.
2. Highlight AUDIO SETTINGS and press ENTER.

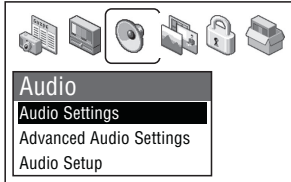

3. Press ▼ to highlight the item you want to adjust (BASS, TREBLE, or BALANCE).

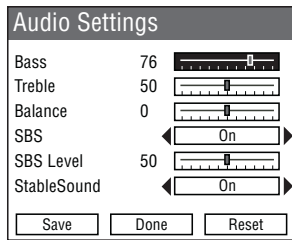

4. Press ◀ or ▶ to adjust the level.
 - ◀ makes the bass or treble weaker or increases the balance in the left channel (depending on the item selected).
 - ▶ makes the bass or treble stronger or increases the balance in the right channel (depending on the item selected).
5. To temporarily save the new settings, highlight DONE and press ENTER. To permanently save the new settings, highlight SAVE and press ENTER.

To reset the audio quality to the factory settings:

Highlight RESET in step 5 above, and press ENTER. The bass and treble are reset to 50 and the balance is reset to 0.

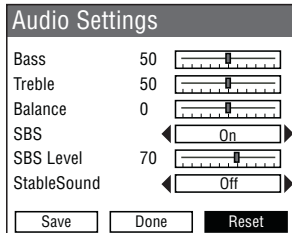

Using the sub-bass system (SBS)

The sub-bass system enhances bass performance, even when the volume is low.

To turn on the SBS and adjust the SBS level:

1. Press MENU and open the AUDIO menu.
2. Highlight AUDIO SETTINGS and press ENTER.

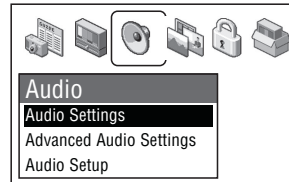

3. Press ▼ to highlight SBS, and then press ▶ to select ON.
4. Press ▼ to highlight SBS LEVEL, and then press ▶ or ◀ to adjust the level.

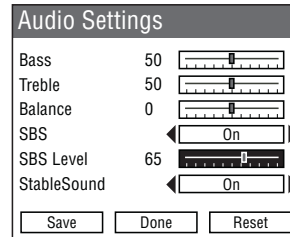

5. To temporarily save the new settings, highlight DONE and press ENTER. To permanently save the new settings, highlight SAVE and press ENTER.

To turn off the SBS feature:

Select OFF in step 3 above.

Note:

When SBS is set to OFF, if the SBS level is adjusted, the SBS is automatically set to ON.

Adjusting the audio (continued)

Using the StableSound® feature

The StableSound® feature limits the highest volume level to prevent extreme changes in volume when the signal source changes (for example, to prevent the sudden increase in volume that often happens when a TV program switches to a commercial).

To turn on the StableSound® feature:

1. Press MENU and open the AUDIO menu.
2. Highlight AUDIO SETTINGS and press ENTER.
3. Press ▼ to highlight STABLE SOUND, and then press ► to select ON.

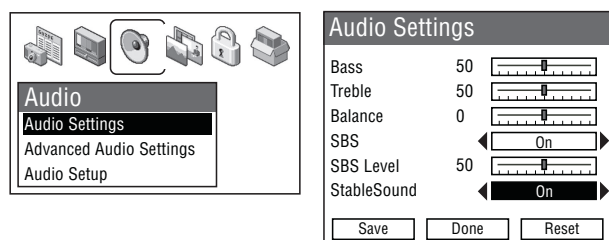

4. To temporarily save the new settings, highlight DONE and press ENTER. To permanently save the new settings, highlight SAVE and press ENTER.

To turn off the StableSound feature:

Select OFF in step 3 above.

Resetting your audio adjustments

The RESET function returns your audio adjustments to the following factory settings:

Bass	center (50)	SBS	ON
Treble	center (50)	SBS Level	70
Balance	center (0)	StableSound...	OFF

To reset your audio adjustments:

1. Press MENU and open the AUDIO menu.
2. Highlight AUDIO SETTINGS and press ENTER.
3. Press ▼ to highlight RESET and press ENTER.

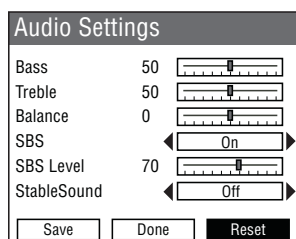

4. To temporarily save the new settings, highlight DONE and press ENTER. To permanently save the new settings, highlight SAVE and press ENTER.

Using the SRS WOW™ surround sound feature

WOW is a special combination of SRS Labs audio technologies (SRS 3D, FOCUS, and TruBass) that creates a thrilling surround sound experience with deep, rich bass from stereo sound sources. Your TV's audio will sound fuller, richer, and wider.

To adjust the WOW settings:

1. Put the TV in STEREO mode (see "Selecting stereo/SAP broadcasts" on page 76).
2. Press MENU and open the AUDIO menu.
3. Highlight ADVANCED AUDIO SETTINGS and press ENTER.

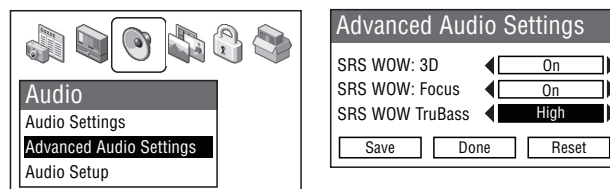

4. Press ▼ or ▲ to highlight the WOW feature you want to adjust, and then press ◀ or ▶ to adjust the item.
 - 3D — To turn the surround sound effect on or off.

Note: If the broadcast is monaural, the 3D effect does not work.
 - Focus — To turn the vocal emphasis effect on or off.
 - TruBass — To select the desired bass expansion level (HIGH, LOW, or OFF).
5. To temporarily save the new settings, highlight DONE and press ENTER. To permanently save the new settings, highlight SAVE and press ENTER.

To reset the WOW settings:

Highlight RESET in the Advanced Audio Settings menu and press ENTER.

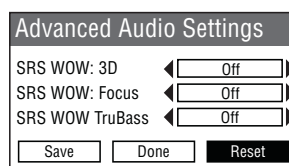

SRS, WOW and the (●) symbol are trademarks of SRS Labs, Inc.
SRS WOW technology is incorporated under license from SRS Labs, Inc.

Adjusting the audio (continued)

Turning off the built-in speakers

Use this feature to turn off the TV speakers when you connect an audio system to your TV (see “Connecting a digital audio system” and “Connecting an analog audio system” on page 19).

To turn off the built-in speakers:

1. Press MENU and open the AUDIO menu.
2. Highlight AUDIO SETUP and press ENTER.

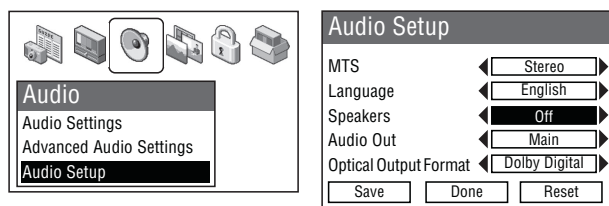

3. Press ▼ to highlight the SPEAKERS field, and then press ► to select OFF.
4. To temporarily save the new settings, highlight DONE and press ENTER. To permanently save the new settings, highlight SAVE and press ENTER.

To turn on the built-in speakers:

Select ON in step 3 above.

Selecting the optical audio output format

Use this feature to select the optical audio output format when you connect a Dolby Digital decoder or other digital audio system to the OPTICAL AUDIO OUT jack on the TV (see “Connecting a digital audio system” on page 19).

To select the optical audio output format:

1. Press MENU and open the AUDIO menu.
2. Highlight AUDIO SETUP and press ENTER.
3. Press ▼ to highlight the OPTICAL OUTPUT FORMAT field, and then press ► to select either DOLBY DIGITAL or PCM, depending on your device.

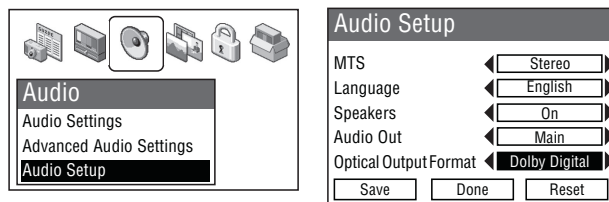

4. To temporarily save the new settings, highlight DONE and press ENTER. To permanently save the new settings, highlight SAVE and press ENTER.

Selecting the AUDIO OUT sound

This feature allows you to select the audio source (MAIN or POP) that is output from the AUDIO OUT jacks.

This is useful when amplifying or recording the POP sound with external equipment while hearing the sound of the main picture through the TV's built-in speakers.

To select the Audio OUT sound:

1. Press MENU and open the AUDIO menu.
2. Press ▼ to highlight AUDIO SETUP and press ENTER.

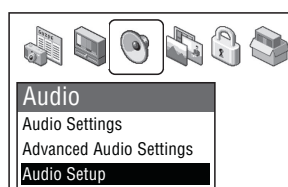

3. Press ▼ to highlight the AUDIO OUT field, and then press ◀ or ▶ to select MAIN or POP.
 - MAIN: Outputs the sound of the main program through the AUDIO OUT jacks.
 - POP: Outputs the sound of the POP program through the AUDIO OUT jacks.

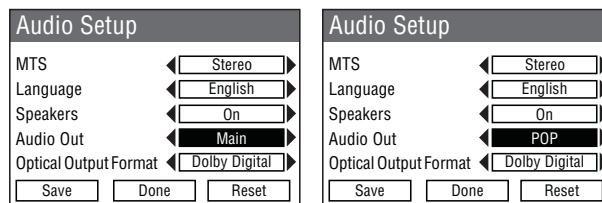

4. To temporarily save the new settings, highlight DONE and press ENTER. To permanently save the new settings, highlight SAVE and press ENTER.

Note:

- When the POP window is not open, the sound of the main program is output through the AUDIO OUT jacks, even if POP is selected in the AUDIO OUT menu.
- The sound of the main program is always output through the TV speakers, regardless of the AUDIO OUT setting.

Using the **SmartMedia™** memory card picture viewer

You can use the SmartMedia™ picture viewer to view photos on your TV screen that you took with a digital camera and saved in a compatible JPEG format on a SmartMedia or SD (Secure Digital™) memory card.

You can display your photos in thumbnail mode or view them as a slide show.

Note:

- The files on your SmartMedia or SD memory card must be in a file and directory format that are compatible with the TV or they will not display on the TV. See "Memory card specifications" below.
- For instructions on using your digital camera, refer to the owner's manual for your camera.
- For instructions on using a SmartMedia or SD memory card, refer to the owner's manual for your memory card.
- See "Memory card care and handling" on the next page.
- Failure to take proper care of a SmartMedia or SD memory card may prevent display of pictures from the card or result in damage to the card or the TV. **SUCH DAMAGE IS NOT COVERED BY YOUR TOSHIBA WARRANTY** because it is a result of misuse.

Memory card specifications

Following are the specifications for image files this TV can display.

Memory card types: • Smart Media™ (3.3V) memory card
 • SD memory card (ver. 1.0)

Memory card capacity: 2/4/8/16/32/64/128 MB

Compression method: JPEG compliant

- Images processed and/or edited on a personal computer (PC) may not display properly or may not display at all. Some digital cameras may store photos in a format that is not compatible with the TV; however, you may be able to change settings on your camera or use a computer to change the format or directory structure of your memory card so that the photos will display.
- The TV will not display pictures from directories on a memory card that are more than 10 levels down from the top level directory.

NOTICE OF POSSIBLE ADVERSE EFFECTS ON TV PICTURE TUBE

Avoid displaying stationary images on your TV screen for extended periods of time. Fixed (non-moving) images can become permanently engrained in the picture tube. **This type of damage is NOT COVERED BY YOUR WARRANTY** because it is the result of misuse. See item 33 on page 4.

SmartMedia is a trademark of Toshiba Corporation.
 SD is a trademark of SD Card Association.

Viewing digital photos on your TV

1. Insert a Smart Media™ or SD memory card into the SmartMedia slot on the front of your TV. (Insert one or the other; you cannot insert both at the same time.) Be sure to insert the card correctly—label side up and the end with the notched corner inserted into the memory card slot.

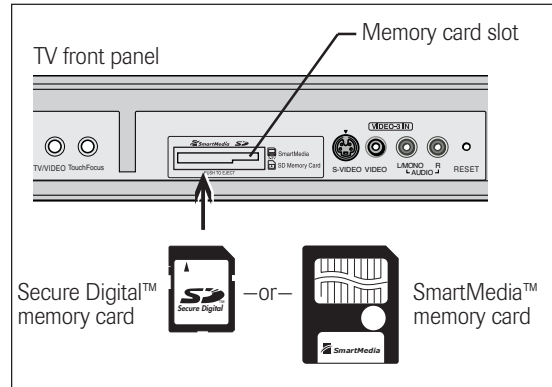

2. In a few seconds, the images automatically display on-screen, with one as a large picture and the next five in thumbnail format.

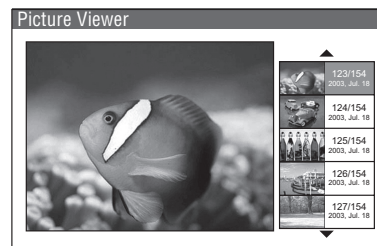

3. Press **▶** to rotate the large picture 90° clockwise.

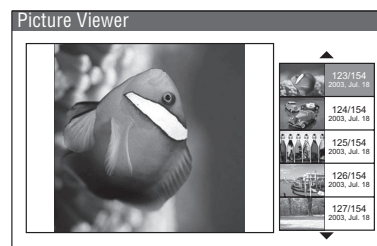

4. Press **◀** to rotate the large picture 90° counterclockwise.

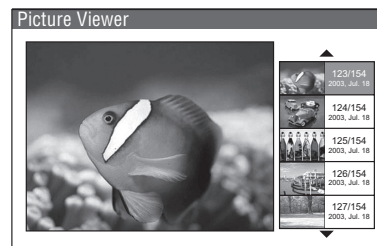

Using the SmartMedia™ memory card picture viewer (continued)

5. Press ▲ or ▼ to select another picture as the large picture.
6. Press ENTER to view your pictures in a slide show.

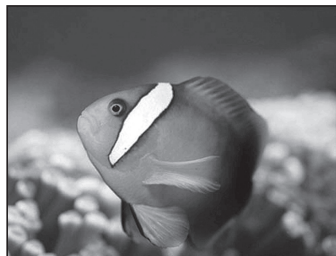

During the slide show:

- Press ► or ◀ to rotate the picture.
- Press ▲ or ▼ to select another image.
- Press CH RTN to stop the slide show and return to the picture viewer.
- Press EXIT to stop the slide show and return to the regular TV screen.

To set the slide show interval:

Note: The picture viewer must be closed before you can set the slide show interval.

1. Press MENU and open the SETUP menu.
2. Highlight SLIDE SHOW INTERVAL and press ENTER. Select the interval from the menu sidebar (2, 5, 10, 15, or 20 seconds).

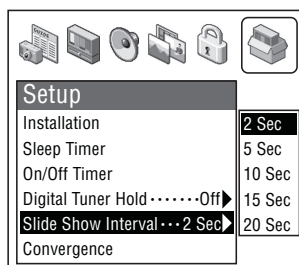

To close the picture viewer:

Press EXIT to close the picture viewer and return to the regular TV screen.

To restart the picture viewer while the memory card is still inserted:

1. Press MENU and open the APPLICATIONS menu.
2. Highlight PICTURE VIEWER and press ENTER.

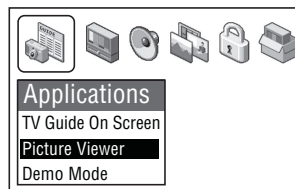

3. Follow the steps under “Viewing digital photos on your TV” on the previous page.
4. Press EXIT to close the picture viewer and return to the regular TV screen.

Memory card care and handling

- Use index labels made exclusively for Smart Media or SD memory cards. Do not use commercially sold labels, which can cause a malfunction when the card is inserted or ejected.
- If the image does not appear correctly, clean the metallic area of the memory card using a soft, dry, lint-free cloth, and reinsert the card.
- Prevent contact of the metallic area on the memory card with dust, dirt, or other foreign particles. Do not touch the metallic area of the memory card.

Setting the ON/OFF timer

You can use the ON/OFF timer to turn the TV on and off at a preset time on a recurring basis.

Note: You must first set the time (see page 51).

To set the ON/OFF timer:

1. Press MENU and open the SETUP menu.
2. Highlight ON/OFF TIMER and press ENTER.

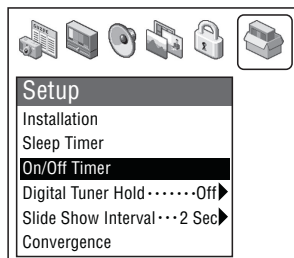

3. Press ▼ to highlight the DAY field, and then press ► to select the recurrence (weekends, weekdays, every day, etc).

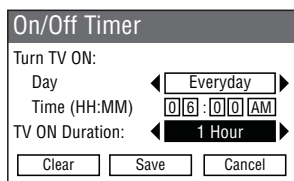

4. Press ▼ to highlight the TIME field, and then use the Number buttons to enter the time you want the TV to turn on.
5. When the AM/PM field is highlighted, press ► to select AM or PM.
6. Press ▼ to highlight the TV ON DURATION field, and then press ► to select the length of time until the TV turns off.
7. Highlight SAVE and press ENTER.
8. Turn off the TV. The TV will turn on automatically on the day(s) and at the time you set. The TV will then turn off automatically after the length of time you set in the TV ON DURATION field.

Note:

- When a power failure occurs, the ON/OFF timer settings may be cleared.
- To display the on time setting, press RECALL.

To turn off the ON/OFF timer:

Select NOT SET in step 3 above.

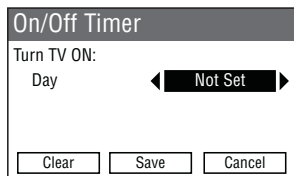

Setting the sleep timer

You can set the sleep timer to turn off the TV at a set length of time, to a maximum of 3 hours.

The sleep timer turns off the TV one time only, as opposed to the ON/OFF timer, which turns off the TV on a recurring basis.

To set the sleep timer:

Press SLEEP on the remote control to set the length of time until the TV turns off. Each time you press SLEEP, the time will increase in 10-minute increments, to a maximum of 180 minutes.

To cancel the sleep timer:

Press SLEEP until it is set to 0.



To set the sleep timer using the on-screen menus:

1. Press MENU and open the SETUP menu.
2. Press ▼ to highlight SLEEP TIMER and press ENTER.

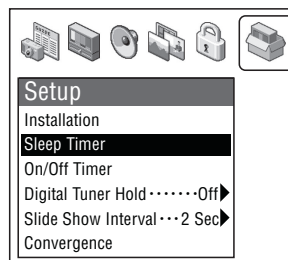

3. Press the Number buttons to enter the length of time until the TV turns off automatically.

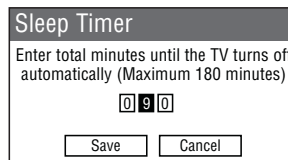

4. Highlight SAVE and press ENTER.

Note:

- When a power failure occurs, the sleep timer setting may be cleared.
- To display the amount of time left on the sleep timer, press RECALL.

Displaying TV setting information on-screen

Press RECALL to display the following information on-screen:

- Antenna mode (when in TV mode)
- Channel number or video input source selected
- Time (if set)
- ON timer setting (if set)
- Remaining time on sleep timer (if set)
- Remaining time on game timer (if set)
- Stereo or SAP audio status
- V-CHIP rating status
- Picture size
- MUTE status (if full MUTE mode is in effect)

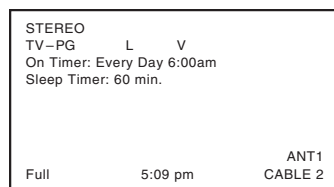

Viewing the demo mode

The demo mode automatically demonstrates several features of your TV.

To start the demo mode:

Press and hold MENU on the TV front panel for 4 seconds.

To start the demo mode using the menu system:

1. Press MENU and open the APPLICATIONS menu.
2. Highlight DEMO MODE and press ENTER.

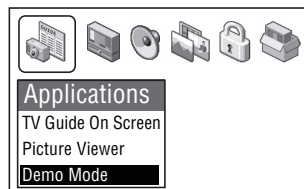

To stop the demo mode:

Press EXIT, RECALL, or POWER.

Understanding the auto power off feature

The TV will automatically turn itself off after approximately 15 minutes if it is tuned to a vacant channel or a station that completes its broadcast for the day. This feature does not work in VIDEO mode.

Understanding the last mode memory feature

If the power is cut off while you are viewing the TV, the Last Mode Memory feature automatically turns on the TV when the power is resupplied.

If the power is going to be off for a long time and you are going to be away from your TV, unplug the power cord to prevent the TV from turning on in your absence.

Important note: Because the Last Mode Memory feature will cause the TV to turn on after a power failure (if it was on when the power failed), if you are viewing fixed images or special formats when the power fails, such images or formats could be displayed when the power returns. To prevent possible damage to the TV's picture tube, you should unplug the TV's power cord if it is possible that you will be away from the TV for an extended period of time after the power is restored. If you are away, the TV could turn on, displaying fixed images or special formats that can become permanently engrained in the picture tube. **THIS TYPE OF DAMAGE IS NOT COVERED BY YOUR WARRANTY** because it is a result of misuse. See item 33 on page 4.

9 Using the Locks menu

The LOCKS menu includes the RATING BLOCKING, CHANNELS BLOCK, INPUT LOCK, FRONT PANEL LOCK, GAME TIMER, and NEW PIN CODE features. You can use these features after entering the correct PIN code.

Entering the PIN code

1. Press MENU and highlight the LOCKS menu icon.

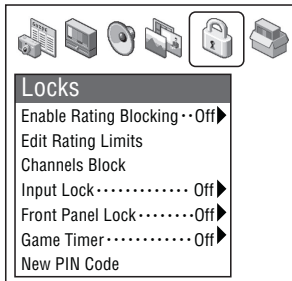

2. Press ▼, which displays the PIN code entering screen.
 - The LOCK SYSTEM screen (below) appears if a PIN code has not been stored. Press the Channel Number buttons to enter a new four-digit code, enter the code a second time to confirm, and press ENTER.

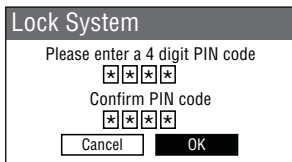

- The LOCKS ACTIVE screen (below) appears if the PIN code is already stored. Press the Channel Number buttons to enter your four-digit code and press ENTER.

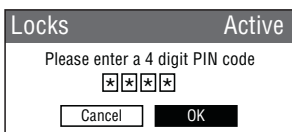

If the wrong PIN code is entered, the message “Incorrect PIN code” appears. Highlight RETRY and press ENTER. Enter the code again and press ENTER.

When the correct PIN code is entered, the LOCKS menu (below) opens.

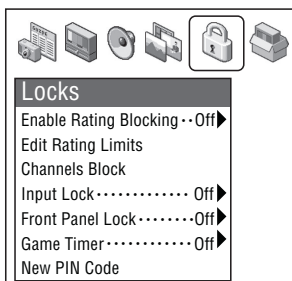

If you cannot remember your PIN code

While the PIN code entering screen is displayed, press RECALL four times within five seconds. The PIN code will be reset and you can enter a new PIN code.

Changing your PIN code

1. Press MENU and highlight the LOCKS menu icon.
2. Press ▼ to display the PIN code entering screen.
3. Enter your four-digit PIN code and press ENTER.
4. Press ▼ to highlight NEW PIN CODE and press ENTER.
5. Press the Number buttons to enter a new four-digit code. Retype the numbers to confirm the PIN code you entered.
6. Press ENTER. The new PIN code is now active.

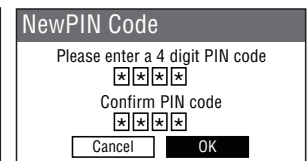
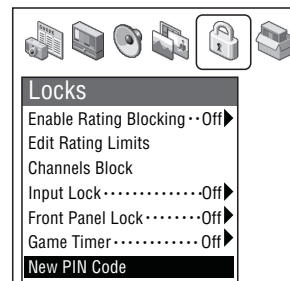

Blocking TV programs and movies by rating (V-Chip)

Some TV programs and movies include signals that classify the content of the program (violence, sex, dialog, language). The V-Chip feature in this TV detects the signals and blocks the programs according to the ratings you select. (See the tables at right for rating descriptions.)

Note: Rating blocking is a function of the V-Chip feature in this TV, which supports the U.S. V-Chip system only. The Canadian V-Chip system is not supported.

To block and unblock TV programs and movies:

1. Press MENU and highlight the LOCKS menu icon.
2. Press ▼, which displays the PIN code entering screen.
3. Enter your four-digit PIN code and press ENTER.
4. Press ▼ to highlight ENABLE RATING BLOCKING.
5. Press ► and then ▼ to select ON, and then press ENTER.

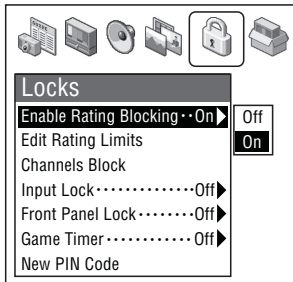

6. Press ▼ to highlight EDIT RATING LIMITS and press ENTER.

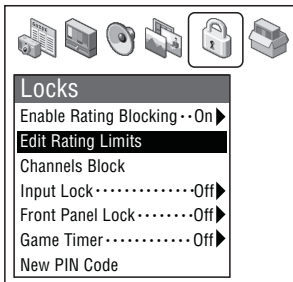

The EDIT RATING LIMITS screen (below) appears.

7. Press ▲▼◀▶ and then press ENTER to select the level of blocking you prefer. A box with an "X" is a rating that will be blocked. As you highlight a rating, a definition for the rating appears at the bottom of the screen. See notes at right.

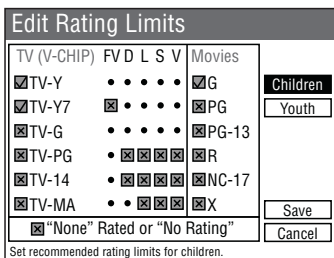

8. When done selecting the ratings you want to block, highlight SAVE and press ENTER.

Independent rating system for broadcasters	
Ratings	Description and Content themes
TV-MA	Mature Audience Only (This program is specifically designed to be viewed by adults and therefore may be unsuitable for children under 17.) L) Crude or indecent language S) Explicit sexual activity V) Graphic violence
TV-14	Parents Strongly Cautioned (This program contains some material that many parents would find unsuitable for children under 14 years of age.) D) Intensely suggestive dialog L) Strong, coarse language S) Intense sexual situations V) Intense violence
TV-PG	Parental Guidance Suggested (This program contains material parents may find unsuitable for younger children.) D) Some suggestive dialog L) Infrequent coarse language S) Some sexual situations V) Moderate violence
TV-G	General Audience (Most parents would find this program suitable for all ages.)
TV-Y7, TV-Y7FV	Directed to Older Children (This program is designed for children age 7 and above. Note: Programs in which fantasy violence may be more intense or more combative than other programs in this category are designated Y7FV.)
TV-Y	All Children (This program is designed to be appropriate for all children.)

Independent rating system for movies	
Rating	Description and content themes
X	X-rated (For adults only)
NC-17	Not intended for anyone 17 and under
R	Restricted (Under 17 requires accompanying parent or adult)
PG-13	Parents Strongly Cautioned (Some material may be inappropriate for children under 13)
PG	Parental Guidance Suggested (Some material may not be suitable for children)
G	General Audience (Appropriate for all ages)

Note:

- If you place an X in the box next to "None Rated or No Rating," programs that are not rated or that are rated "None" will be blocked.
- To display the rating of the program you are watching, press RECALL on the remote control. If it is not rated, the word "NONE" appears.

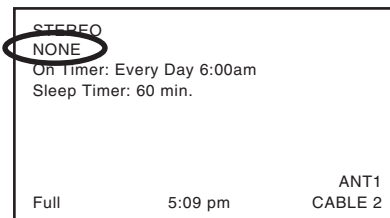

Blocking channels

With the CHANNELS BLOCK feature, you can block specific channels. You will not be able to tune locked channels unless you clear the setting.

To block channels:

1. Press MENU and highlight the LOCKS menu icon.
2. Press ▼, which displays the PIN code entering screen.
3. Enter your four-digit PIN code (see page 84 for details).
4. Press ▼ to highlight CHANNELS BLOCK and then press ENTER.

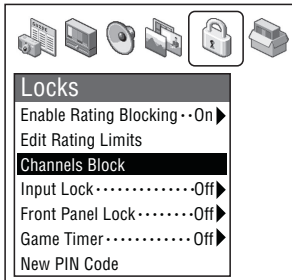

5. Press ▲▼◀▶ to highlight the channel you want to block, then press ENTER, which puts an X in the box next to that channel.

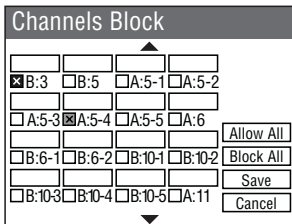

6. Repeat step 5 for other channels you want to block.
7. Highlight SAVE and press ENTER.

To unlock individual channels:

In step 5 above, press ▲▼◀▶ to highlight the channel you want to unblock, and then press ENTER to remove the X from the box.

To block all channels at once:

Highlight BLOCK ALL in step 5 above.

To unlock all locked channels at once:

Highlight ALLOW ALL in step 5 above.

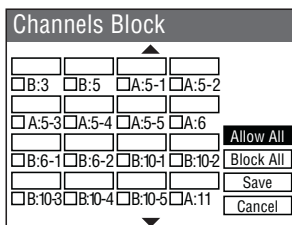

Unlocking programs temporarily

If you try to watch a TV program that exceeds the rating limits you set, the TV enters program lock mode.

You can either unlock the program temporarily or select a non-locked program to watch.

This program exceeds the rating limit you set.
Push 'mute' to enter PIN.

To temporarily unlock the program:

1. Press MUTE.
2. Enter your four-digit PIN code and press ENTER.
If the correct code is entered, the program lock mode is released and the normal picture appears. All locking is disabled until the TV is turned off, and will be enabled when the TV is turned on.

Locking video inputs

You can use the INPUT LOCK feature to lock the video input sources (VIDEO 1, VIDEO 2, VIDEO 3, ColorStream HD-1, ColorStream HD-2, DVI/HDCP) and channels 3 and 4.

You will not be able to view the input sources or channels until you turn off the input lock.

To lock the video inputs:

1. Press MENU and highlight the LOCKS menu icon.
2. Press ▼ to display the PIN code entering screen.
3. Enter your four-digit PIN code and press ENTER.
4. Press ▼ to highlight INPUT LOCK and press ENTER.
5. Press ▼ to select the level of video input locking you prefer, as described below:

VIDEO: Locks VIDEO 1, VIDEO 2, VIDEO 3, ColorStream HD1/HD2, and DVI/HDCP.

VIDEO+: Locks VIDEO 1, VIDEO 2, VIDEO 3, ColorStream HD-1/HD-2, DVI/HDCP, and channels 3 and 4. Select VIDEO+ if you use the antenna terminal to play a video tape.

Note: Make sure the POP is not on channel 3 or 4.

OFF: Unlocks all video input sources.

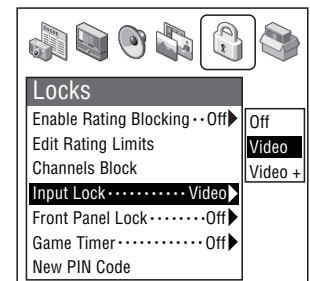

Using the game timer

You can use the game timer to set a time limit for playing a video game (30–120 minutes). When the game timer is activated, the TV enters VIDEO LOCK mode and locks out the input source for the video game device.

To set the game timer:

1. Press MENU and highlight the LOCKS menu icon.
2. Press ▼ to display the PIN code entering screen.
3. Enter your four-digit PIN code and press ENTER.
4. Press ▼ to highlight GAME TIMER and press ENTER.
5. Press ▼ to select the length of time until the VIDEO LOCK is activated (30, 60, 90 or 120 minutes) and press ENTER.

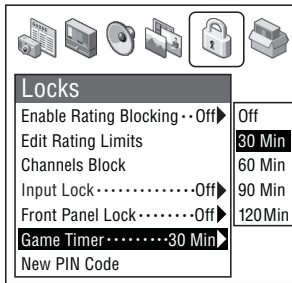

To cancel the game timer:

Select OFF in step 2 above.

To deactivate the video lock once the game timer has activated it:

Set the VIDEO LOCK to OFF (see “Locking video inputs” on page 86).

Note:

- When one minute is left on the game timer, the message “1 minute remaining” will appear on-screen.
- If the TV loses power with time remaining on the game timer, when power is restored the TV will enter VIDEO LOCK mode, as if the game timer has expired, and you will have to deactivate the video lock (as described above).

NOTICE OF POSSIBLE ADVERSE EFFECTS ON TV PICTURE TUBE

Avoid displaying stationary images on your TV screen for extended periods of time. Fixed (non-moving) images (such as still PIP/POP windows, black/gray bars in wide-screen picture or PIP/POP formats, or some video games) can become permanently engrained in the picture tube. **This type of damage is NOT COVERED BY YOUR WARRANTY** because it is the result of misuse. See item 33 on page 4.

Using the front panel lock feature

You can lock the front panel buttons to prevent your settings from being changed accidentally (by children, for example). When the front panel lock is ON, no control buttons on the TV front panel will operate except POWER and TouchFocus.

To lock the front panel:

1. Press MENU and highlight the LOCKS menu icon.
2. Press ▼ to display the PIN code entering screen.
3. Enter your four-digit PIN code and press ENTER.
4. Press ▼ to highlight FRONT PANEL LOCK.
5. Press ▼ to highlight ON and press ENTER.

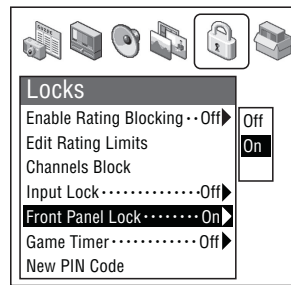

If a button on the front panel is pressed, the message “Not Available” appears.

To unlock the front panel:

Highlight OFF in step 2 above, or press and hold the VOLUME ◀ button on the TV front panel for about 10 seconds until the volume icon appears on-screen.

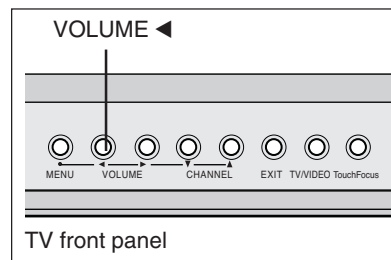

TV front panel

10 Troubleshooting

Before calling a service technician, please check the following table for a possible cause of the problem and some solutions.

Problem	Solution
TV will not turn on	<ul style="list-style-type: none">• Make sure the power cord is plugged in, and then press POWER.• The remote control batteries may be dead. Replace the batteries or try the front panel buttons.• Press the RESET button on the TV front panel (page 9).
Picture problems	<ul style="list-style-type: none">• Check the antenna/cable connections (pages 12–25).• Press INPUT on the remote control or TV/VIDEO on the TV front panel and select a valid video input source (page 61). If no device is connected to any of the inputs on the TV, no picture will display when you select that particular input source. For device connection details, see Chapter 2.• Antenna reception may be poor. Use a highly directional outdoor antenna (if applicable).• The station may have broadcast difficulties. Try another channel.• Adjust the picture qualities in the VIDEO menu (pages 72–74).• If you are using a VCR, make sure the TV/VCR button on the remote control is set correctly (page 26).• If you have two VCRs connected to your TV, do not connect the same VCR to the TV's output and input connections at the same time (page 17).• Do not connect a standard video cable and an S-video cable to VIDEO-1 or VIDEO-2 on the TV back (or VIDEO-3 on the TV front) at the same time (page 10).
<i>Noisy picture</i>	<ul style="list-style-type: none">• If you are watching a tuned analog channel (off-air broadcast or Cable TV), set the CableClear DNR feature to ON to reduce visible interference in the TV picture (page 74).
<i>Video Input Selection problems</i>	<ul style="list-style-type: none">• If the Input Selection window does not appear when you press INPUT on the remote control or TV/VIDEO on the TV front panel, press INPUT or TV/VIDEO a second time, which will change to the next video input source and display the Input Selection window.
<i>Cannot view external signals or channel 3 or 4</i>	<ul style="list-style-type: none">• If you cannot view signals from external devices connected to VIDEO 1, VIDEO 2, VIDEO 3, or ColorStream, or from channels 3 or 4, make sure the INPUT LOCK is set to OFF (page 86).
<i>Black box on screen</i>	<ul style="list-style-type: none">• Set the CLOSED CAPTION feature to OFF (page 75).
<i>Poor color or no color</i>	<ul style="list-style-type: none">• The station may have broadcast difficulties. Try another channel.• Adjust the TINT and/or COLOR in the PICTURE SETTING menu (page 72).• If the red, green, and blue color guns become misaligned, the picture may appear out of focus. Press the TouchFocus button on the TV front panel to automatically adjust the color convergence, or manually adjust the color convergence (page 50).• When the ColorStream signal source is active, the VIDEO OUT terminal outputs a black and white signal only. To receive a color VIDEO OUT signal, a standard video or S-video IN jack must be used instead of the ColorStream connections.
<i>POP problems</i>	<ul style="list-style-type: none">• Digital channels will not display in the POP double-window, the CH SCAN POP multi-windows, or the FAV POP multi-windows (pages 68–71)• The VIDEO OUT jack will not output the POP picture (page 17).
Memory card/picture viewer problems	<ul style="list-style-type: none">• Make sure you are using a supported or valid memory card format (page 80).• Make sure you have saved the picture files in the correct file format (page 80).• The card may be inserted improperly. Remove the card and reinsert it (page 80).• The memory card may be empty.• The memory card may be damaged.

Chapter 10: Troubleshooting

Problem	Solution
Sound problems	<ul style="list-style-type: none">• Check the antenna/cable connections (see Chapter 2).• If the POP window is not open, the FIXED AUDIO OUT terminals will output the main audio signal, even if AUDIO OUT is set to POP in the AUDIO SETUP menu (page 79).• The station may have broadcast difficulties. Try another channel.• The sound may be muted. Press VOLUME.• If you hear no sound, try setting set the MTS feature to STEREO mode (page 76).• Make sure the SPEAKERS function in the AUDIO SETUP menu is set correctly (page 79).• If you are not receiving a second audio program from a known SAP source, make sure the MTS feature is set to SAP mode (page 76).• If you hear audio that seems “incorrect” for the program you are watching (such as music or a foreign language), the SAP mode may be on. Set the MTS feature to STEREO mode (page 76).• When using an external audio amplifier, if you connect the amplifier to the VAR. AUDIO OUT jacks, the volume of the TV and amplifier must be set above 0 or you will not hear any sound (page 19).• When recording to a second VCR, set AUDIO OUT to MAIN (pages 17 and 79).• The TV’s volume buttons will not control CENTER CHANNEL input (page 20).• If you are using an A/V receiver, use the center level control on the A/V receiver to adjust the volume of the center channel speakers (page 20).
Remote control problems	<ul style="list-style-type: none">• Make sure the remote control is set to the correct device mode (page 27).• Remove all obstructions between the remote control and the TV.• The remote control batteries may be dead. Replace the batteries (page 27).• Your TV remote control may not operate certain features on your external device. Refer to the owner’s manual for your other device to determine its available features. If your TV remote control does not operate a specific feature on another device, use the remote control that came with the device (page 27).• If the TV stops responding to the controls on the remote control or TV front panel and you cannot turn off the TV, press the RESET button on the front panel (see page 8 for details). If the TV still does not act as expected, use the Restore Factory Defaults procedure as described on page 52.
Channel tuning problems	<ul style="list-style-type: none">• Make sure the remote control is set to the correct device mode (page 27).• The channel may have been erased from the channel memory by the CHANNEL ADD/DELETE feature. Add the channel to the channel memory (page 43).• The channel may be blocked by the CHANNELS BLOCK feature. Unblock the channel (page 86).• If you are unable to tune digital channels, check the antenna configuration (page 41). If you are still unable to tune digital channels, clear all channels from the channel list (page 43) and reprogram channels into the channel memory (page 42). If you are still unable to tune digital channels, use the Restore Factory Defaults procedure as described on page 52.
Closed caption problems	<ul style="list-style-type: none">• If the program or video you selected is not closed-captioned, no captions will display on-screen (page 75).• If you set the Caption Text Color to Black, do not set the Background Color to Auto or you will not be able to read the captions (page 75).• If text is not available, a black rectangle may appear on-screen. If this happens, turn off the closed caption feature (page 75).• A closed caption signal may not display correctly in the following situations: a) when a videotape has been dubbed; b) when the signal reception is weak; or c) when the signal reception is nonstandard (page 75).
Rating Blocking (V-Chip) problems	<ul style="list-style-type: none">• If you forget your PIN code: While the PIN code entering screen is displayed, press RECALL four times within 5 seconds. The PIN code you stored will be reset (page 84).• The V-Chip feature is only available for the U.S. V-Chip system. The Canadian V-Chip system (“Puce-V”) is not supported (page 85).
Other problems	<ul style="list-style-type: none">• If your TV’s problem has not been addressed in this Troubleshooting section or the recommended solution has not worked, use the Restore Factory Defaults procedure as described on page 52.

TV Guide On Screen FAQs

The following are frequently asked questions about the TV Guide On Screen system. The answers represent the most likely solutions to the problem.

Setup Questions

1. **Q: What if I move and my ZIP code or postal code changes?**

A: Open the TV Guide On Screen SETUP menu and follow the on-screen prompts to enter new information (see page 37 for details). It can take up to 24 hours to receive new data.

2. **Q: What if I change my cable hook-up to antenna or vice versa?**

A: Open the TV Guide On Screen SETUP menu and follow the on-screen prompts to enter new input information and rescan channels for the new input (see page 37 for details).

3. **Q: What if I change cable boxes?**

A: Open the TV Guide On Screen SETUP menu and follow the on-screen prompts to enter new input information and rescan channels for the new input (see page 37 for details).

4. **Q: I used to have a cable box, but now I get direct cable. What do I do?**

A: Open the TV Guide On Screen SETUP menu and follow the on-screen prompts to enter new input information and rescan channels for the new input (see page 37 for details).

5. **Q: Why does it take 24 hours for the TV Guide On Screen system to be ready for use?**

A: TV Guide On Screen data may be ready earlier. It depends on when the feature is set up and if the device is in use. Often it just takes overnight.

6. **Q: I completed the initial setup for my TV Guide On Screen hours ago, but when I try to turn it on, a screen message tells me to input the correct setup information. What's wrong?**

A: There are several possibilities:

- a) Initial setup was done incorrectly. (i.e., you entered wrong country, ZIP/postal code, or cable box information.)
- b) The cable box was turned OFF. The television must be OFF and the cable box ON.
- c) The VCR, DVD, or Satellite box was left ON.
- d) A/V cables: The VCR was turned OFF. If the connection includes stereo cables with cable box to VCR, stereo connection from VCR to the television, the VCR must be tuned to the output channel and powered ON.

7. **Q: I had a power outage. Do I need to go through initial setup of the TV Guide On Screen system again?**

A: No. The information you entered is in a protected part of the TV Guide On Screen system memory.

Note: For Cable box users, the TV must be OFF and the Cable box must be left ON for the TV Guide On Screen system to receive channel line-up information.

8. **Q: How do I access the TV Guide On Screen system setup screen?**

A: For initial setup, press the GUIDE key on the remote control, and then follow the on-screen prompts.

After initial setup, there are two ways:

- a) Press GUIDE, then use the UP and RIGHT arrow keys to highlight SETUP on the Menu Bar, and then use the DOWN arrow key to highlight "Change system settings." Follow the on-screen prompts.
- b) Press MENU, open the SETUP menu, highlight INSTALLATION and press ENTER to open the INSTALLATION menu. Open the TV GUIDE ON SCREEN SETUP menu, highlight START, and press ENTER. Follow the on-screen prompts.

9. **Q: How do I connect the G-LINK (IR blaster) cable to the G-LINK input on the TV?**

A: See Chapter 2: Connecting your TV in this manual. You also can refer to the TV Guide On Screen prompts during VCR or Cable box setup.

10. **Q: When will I be able to view my TV program listings and use other TV Guide On Screen system features?**

A: The TV Guide On Screen system will be ready for use within 24 hours of initial setup.

11. **Q: What should I do if I cannot complete initial setup?**

A: If you are unable to complete initial setup using the owner's manual and the on-screen prompts, please call Toshiba's National Service Division at 1-800-631-3811.

12. **Q: If I make a mistake during setup, how do I go back to the previous step?**

A: Complete the remaining setup steps. When "Confirming Your Settings" appears, select "No, repeat setup process." Follow the on-screen prompts and input the correct information.

13. **Q: What if the channel number is not visible on my cable box?**

A: Your cable box may be defaulting to a clock or time display once the channel changes. Watch the box carefully when testing the cable box brand code to see if the channel changes to 09.

TV Guide On Screen FAQs (continued)

14. Q: Why won't my VCR turn on?

- A: There are several possibilities:
- The wired remote VCR is incompatible.
 - The VCR does not have remote power capability. The user must leave the VCR ON for recording.
 - The VCR remote mode was set to "B" or "2." The remote should be set to "A" or "1."
 - An incorrect or "no VCR" code was entered during the TV Guide On Screen initial setup. Press the GUIDE button on the remote control, and then press ► to highlight SETUP. Press ▼ to highlight "Change system settings," and then press ENTER. Follow the on-screen prompts to select the correct VCR information.
 - The VCR record timer is on. Turn off the timer.
 - Make sure the G-LINK (IR blaster) cable is connected correctly (see page 25).

Operational Questions

CHANNEL LINE-UPS & LISTINGS

1. Q: Why aren't all my channels initially displayed?

A: After initial setup, approximately 120 channels are automatically displayed. The user may use the "Change channel display" feature to turn ON or OFF additional channels.

Note: Even though you have the option of enabling many more channels, the system may not have the memory capacity to hold detailed program descriptions for all of them.

2. Q: Why do all my channels display "No Listing?"

A: The TV Guide On Screen system has not yet received its data download. The phrase "No Listings" will be replaced with program information during the next download cycle, which will occur within the next 24-hour period.

3. Q: Why do some of my channels display "No Listing?"

- A: There are several possibilities:
- The channels in question were recently turned ON (in Change channel display) and TV Guide On Screen has yet to receive its next data download.
 - After completing the initial setup, the first data download of the day was interrupted by a VCR recording.
 - The TV power cord was left unplugged for an extended period of time and the TV Guide On Screen system was unable to receive program listings during the scheduled download cycle.
 - Poor reception caused some of the data to be missed.
 - The cable box was turned OFF. The TV power cord must be plugged in and the cable box must be ON.
 - A/V Cable: The VCR was turned OFF. If the connection includes stereo cables with cable box to VCR and stereo connection from VCR to television, the VCR must be ON.

4. Q: How do I add, delete, or change the assigned number of channels on the TV Guide On Screen system?

A: See the "Change channel display" section in the TV Guide On Screen owner's manual.

5. Q: If a channel is displayed on my TV Guide On Screen listing, does that mean I should be able to watch it?

A: Not necessarily, because TV Guide On Screen only displays listings for the local channel line-up. If the user has cable, their cable company determines the channels received.

6. Q: Why are some of my channels listed on the wrong number?

A: There are several possibilities:

- Initial setup was done incorrectly. (i.e., the wrong ZIP/postal code was entered.) Redo the initial setup.
- Incorrect channel lineup was selected. Access "Change system settings" and choose "Yes, but my channel lineup is incorrect," and then reselect the correct lineup.
- Channel line-up changes have not yet been processed. (Use the "Change channel display" feature to make adjustments.)

7. Q: Why doesn't the program highlighted match up with the video window on my TV screen?

A: There are several possibilities:

- The station in question made a late change to its scheduled program listing and the TV Guide On Screen system has not yet been updated.
- The TV is receiving broadcasts through a modified or boosted antenna system or a satellite dish (not supported by the TV Guide On Screen system).
- Initial setup was done incorrectly. (i.e., the wrong ZIP/postal code was entered.) Redo the initial setup.
- Incorrect channel lineup was selected. Access "Change system settings" and choose "Yes, but my channel lineup is incorrect," and then reselect the correct lineup.
- The video window may be locked. Press SPLIT to unlock.

8. Q: Why is there no picture in the video window?

A: If you turn ON the digital tuner hold when ANT 2 is the selected input source and then open the TV Guide On Screen system, the Video Window may not display a picture. If this happens and you want to use the TV Guide On Screen system, turn OFF the digital tuner hold and select ANT 1 or VIDEO 1 as the input source.

TV Guide On Screen FAQs (continued)

9. Q: **Can I move my favorite stations to the top of the TV Guide On Screen display screen?**

A: Yes. Use the "Change channel display" feature to make adjustments. Highlight the station call letters to be moved, then use the BLUE, GREEN, and/or Number buttons to reassign the position of the station.

OPERATIONS

10. Q: **My cable box will not change channels with the TV Guide On Screen system. What's wrong?**

A: There are several possibilities:

- The cable box has no remote capability and is incompatible.
- The cable box sensor has not been activated. Contact your local Cable TV company.
- The incorrect cable box code was entered during TV Guide On Screen initial setup. Redo initial setup.
- The G-LINK (IR blaster) cable may not be connected properly (see page 25).

11. Q: **How do I resize or close the INFO window?**

A: Repeatedly press the INFO button on the remote control, which works like a toggle switch.

12. Q: **Is there a way to go directly to the next day's listings without scrolling through each time slot?**

A: Yes. Highlight the "Listings" panel then use the BLUE and GREEN buttons on the remote control to move forward or backward 24 hours at a time.

13. Q: **Why can't I record a show? All I get is snow or a blue screen.**

A: There are several possibilities (without a cable box):

- The TV/CATV mode was set incorrectly. Refer user to VCR owner's manual.
- The VCR channels were not programmed into the VCR's memory. Refer to your VCR owner's manual.
- The VCR was not hooked up correctly for recording. Refer to your VCR owner's manual.
- The incorrect channel lineup was selected. Press GUIDE and then ► to highlight SETUP. Press ▼ to highlight "Change system settings," and then press ENTER. Follow the on-screen prompts to select the correct channel lineup.
- Dirty or defective tape heads. Refer to your VCR owner's manual for maintenance tips.

14. Q: **Why won't my VCR change channels and why does it change to the wrong channel?**

A: There are several possibilities (without a cable box):

- The cable box code was entered when no cable box is used. Redo initial setup.
- The manual preset VCR must be left on the channel to be recorded.
- The electronic preset VCR is incompatible unless used in conjunction with a cable box.
- The VCR channels are not programmed into VCR memory. Refer to your VCR owner's manual.
- The VCR's "CATV" mode was set incorrectly (For problems with channels 14 and above, refer to your VCR owner's manual).

A: There are several possibilities (with a cable box):

- The VCR is not set on the correct output channel. Set the VCR to 03, 04, or whichever output channel is set by your cable system.
- The VCR and/or cable box are hooked up incorrectly. Refer to your VCR owner's manual or contact your Cable TV company for proper wiring procedures.
- The cable box was left OFF. Leave the cable box ON and the VCR OFF.

15. Q: **Can I record one channel while watching another?**

A: (*without a cable box*): Yes. If the TV picture becomes "fuzzy" when the VCR turns on to record, simply press the TV/VCR button on your VCR remote.

A: (*with a cable box*): No. You cannot watch one program and record another unless you connect a splitter or a special type of "watch-and-record" device. Contact your Cable TV company or an electronics dealer for more information.

RECORDING

16. Q: **How many programs can be scheduled for FAVORITE/RECORD in the GUIDE?**

A: There is no limit to the number of shows that can be programmed into the schedule memory.

17. Q: **If a program is scheduled to RECORD on a Regular basis, does it count as five?**

A: No, whether a program is scheduled ONCE, REGULARLY, or WEEKLY, it only counts as one show in the RECORD stack memory.

18. Q: **If I have a power failure, will I need to reset the recorded shows I have already programmed?**

A: The start times and channel numbers of shows that have been programmed will be retained in the memory of the TV Guide On Screen system. Titles will appear once listings are restored.

11 Appendix

Specifications

Design and specifications are subject to change without notice.

Television System

NTSC standard
ATSC standard (8VSB)
Digital Cable (64 QAM, 256 QAM; in-the-clear, un-encrypted)

Channel Coverage

VHF: 2 through 13
UHF: 14 through 69
Cable TV: Mid band (A-8 through A-1, A through I)
Super band (J through W)
Hyper band (AA through ZZ, AAA, BBB)
Ultra band (65 through 94, 100 through 125)

Power Source

120 V AC, 60 Hz

Power Consumption

210 W

Audio Power

20 W + 20 W

Speaker Type

Two 6-5/16 inches (16 cm) round

Video/Audio Terminals

S-VIDEO INPUT

Y : 1 V(p-p), 75 ohm, negative sync.
C : 0.286 V(p-p) (burst signal), 75 ohm

VIDEO/AUDIO INPUT

VIDEO: 1 V(p-p), 75 ohm, negative sync.
AUDIO: 150 mV(rms) (30% modulation equivalent, 47 k ohm)

ColorStream® (component video) INPUT

Y : 1V(p-p), 75 ohm
PR: 0.7 V(p-p), 75 ohm
PB: 0.7 V(p-p), 75 ohm
AUDIO: 150 mV(rms), 47 k ohm
Suggested scan rates: 1080i, 480p, 480i, 720p

VIDEO/AUDIO OUTPUT

VIDEO: 1 V(p-p), 75 ohm, negative sync.
AUDIO: 150 mV(rms) (30% modulation equivalent, 4.7 k ohm)

VARIABLE AUDIO OUTPUT

0–300 mV(rms) (30% modulation equivalent, 4.7 k ohm)

REC (RECORD) OUT

VIDEO: 1 V(p-p), 75 ohm, negative sync.
AUDIO: 200 mV(rms) (–20 dBFS, 4.7 k ohm)
(For ATSC, Digital Cable, IEEE-1394 sources only)

Video/Audio Terminals (cont.)

AUDIO CENTER CHANNEL INPUT

300 mV(rms) (30% modulation equivalent, 10 k ohm)

DVI/HDCP INPUT

HDCP compliant
E-EDID* 1.3 compliant
DVI-D uncompressed, high-speed, digital single-link connection
Suggested scan rates: 1080i, 480p, 480i, 720p

G-LINK and IR OUT: 3 V(p-p), 3.5mm mono socket
(IR blaster cables supplied)

IEEE-1394 IN/OUT: IEEE-1394 compliant

Dimensions

51H93:	Width	47-9/16 inches (1208 mm)
	Height	50-1/2 inches (1283 mm)
	Depth	22 inches (559 mm)
57H93:	Width	52-3/4 inches (1340 mm)
	Height	55-3/4 inches (1416 mm)
	Depth	23-9/16 inches (598 mm)
65H93:	Width	59-7/8 inches (1521 mm)
	Height	59-7/8 inches (1521 mm)
	Depth	26 inches (660 mm)

Mass

51H93: 169 lbs (76.6 kg)
57H93: 204 lbs (92.5 kg)
65H93: 240 lbs (109 kg)

Supplied Accessories

Two dual-wand IR blaster cables
Remote control with two size “AA” alkaline batteries

* E-EDID = Enhanced-Extended Display Identification

Limited United States Warranty for 27" FST PURE® and All Larger Television Models

Toshiba America Consumer Products, Inc. ("TACP") and Toshiba Hawaii, Inc. ("THI") make the following limited warranties to original consumers in the United States. **THESE LIMITED WARRANTIES EXTEND TO THE ORIGINAL CONSUMER PURCHASER OR ANY PERSON RECEIVING THIS TELEVISION AS A GIFT FROM THE ORIGINAL CONSUMER PURCHASER AND TO NO OTHER PURCHASER OR TRANSFEREE.**

PRODUCTS PURCHASED IN THE U.S.A. AND USED IN CANADA ARE NOT COVERED BY THESE WARRANTIES.

PRODUCTS PURCHASED IN CANADA AND USED IN THE U.S.A. ARE NOT COVERED BY THESE WARRANTIES.

Limited One (1) Year Warranty on Parts and Labor*

TACP/THI warrant this television and its parts against defects in materials or workmanship for a period of one (1) year after the date of original retail purchase. **DURING THIS PERIOD, TACP/THI WILL, AT TACP/THI'S OPTION, REPAIR OR REPLACE A DEFECTIVE PART WITH A NEW OR REFURBISHED PART WITHOUT CHARGE TO YOU FOR PARTS OR LABOR.** TACP/THI Authorized Service Station personnel will come to your home when warranty service is required. Depending on the type of repair required, either the service will be performed in your home or the set will be taken to the TACP/THI Authorized Service Station for repair and returned to your home at no cost to you.

Limited Two (2) Year Warranty on Picture Tube*

TACP/THI further warrant the picture tube in this television against defects in materials or workmanship for a period of two (2) years after the date of original retail purchase. **DURING THIS PERIOD, TACP/THI WILL, AT TACP/THI'S OPTION, REPAIR OR REPLACE A DEFECTIVE PICTURE TUBE WITH A NEW OR REFURBISHED PICTURE TUBE WITHOUT CHARGE TO YOU, EXCEPT THAT, IF A DEFECTIVE PICTURE TUBE IS REPAIRED OR REPLACED AFTER ONE (1) YEAR FROM THE DATE OF THE ORIGINAL RETAIL PURCHASE, YOU PAY LABOR CHARGES INVOLVED IN THE REPAIR OR REPLACEMENT.**

Rental Units

The warranty for rental units begins with the date of first rental or thirty (30) days from the date of shipment to the rental firm, whichever comes first.

*Commercial Units

Televisions sold and used for commercial purposes have a limited ninety (90) day warranty for all parts, labor, and picture tubes.

Owner's Manual and Product Registration Card

Read this owner's manual thoroughly before operating this television. Complete and mail the enclosed product registration card within ten days after you, or the person who has given you this product as a gift, purchased this television. Returning the product registration card will enable TACP/THI to provide you with better customer service and improved product support. Failure to return the product registration card will not affect your rights under this warranty.

Your Responsibility

THE ABOVE WARRANTIES ARE SUBJECT TO THE FOLLOWING CONDITIONS:

- (1) You must provide your bill of sale or other proof of purchase.
- (2) All warranty servicing of this television must be made by an Authorized TACP/THI Service Station.
- (3) The warranties from TACP and THI are effective only if the television is purchased and operated in the U.S.A. or Puerto Rico.

- (4) Labor service charges for set installation, setup, adjustment of customer controls, and installation or repair of antenna systems are not covered by these warranties. Reception problems caused by inadequate antenna systems are your responsibility.
- (5) Warranties extend only to defects in materials or workmanship as limited above and do not extend to any television or parts that have been lost or discarded by you or to damage to television or parts caused by misuse, accident, Acts of God (such as lightning or fluctuations in electric power), improper installation, improper maintenance, or use in violation of instructions furnished by TACP/THI; or to units that have been modified or had the serial number removed, altered, defaced, or rendered illegible.

How to Obtain Warranty Services

If, after following all of the operating instructions in this manual and checking the "Troubleshooting" section, you find that service is needed:

- (1) To find the nearest TACP/THI Authorized Service Station:
 - For televisions purchased in the United States, except Hawaii, visit TACP's web site at www.toshiba.com/tacp, or call toll free 1-800-631-3811.
 - For televisions purchased in Hawaii, contact Toshiba Hawaii, Inc., 327 Kamakee Street, Honolulu, HI 96814, (808) 591-9281.
- (2) Present your bill of sale or other proof of purchase to the Authorized Service Station. Authorized TACP/THI Service Station personnel will come to your home when warranty service is required. Depending on the type of repair required, either the service will be performed in your home or the set will be taken to the Authorized Service Station for repair and returned to your home at no cost to you.

**For additional information, visit TACP's web site:
www.toshiba.com/tacp.**

ALL WARRANTIES IMPLIED BY THE LAW OF ANY STATE OF THE U.S.A., INCLUDING THE IMPLIED WARRANTIES OF MERCHANTABILITY AND FITNESS FOR A PARTICULAR PURPOSE, ARE EXPRESSLY LIMITED TO THE DURATION OF THE LIMITED WARRANTIES SET FORTH ABOVE. WITH THE EXCEPTION OF ANY WARRANTIES IMPLIED BY THE LAW OF ANY STATE OF THE U.S.A. AS HEREBY LIMITED, THE FOREGOING WARRANTY IS EXCLUSIVE AND IN LIEU OF ALL OTHER WARRANTIES, GUARANTEES, AGREEMENTS, AND SIMILAR OBLIGATIONS OF TACP OR THI WITH RESPECT TO THE REPAIR OR REPLACEMENT OF ANY PARTS. IN NO EVENT SHALL TACP OR THI BE LIABLE FOR CONSEQUENTIAL OR INCIDENTAL DAMAGES.

No person, agent, distributor, dealer, or company is authorized to change, modify, or extend the terms of these warranties in any manner whatsoever. The time within which action must be commenced to enforce any obligation of TACP or THI arising under this warranty or under any law of the United States or of any state thereof is hereby limited to 90 days from the date you discover, or should have discovered, the defect. This limitation does not apply to implied warranties arising under the law of any state of the U.S.A.

THIS WARRANTY GIVES YOU SPECIFIC LEGAL RIGHTS, AND YOU MAY ALSO HAVE OTHER RIGHTS, WHICH MAY VARY FROM STATE TO STATE IN THE U.S.A. SOME STATES OF THE U.S.A. DO NOT ALLOW LIMITATIONS ON THE DURATION OF AN IMPLIED WARRANTY, LIMITATIONS ON THE TIME WITHIN WHICH AN ACTION MAY BE BROUGHT, OR THE EXCLUSION OR LIMITATION OF INCIDENTAL OR CONSEQUENTIAL DAMAGES; THEREFORE, THE ABOVE LIMITATIONS OR EXCLUSIONS MAY NOT APPLY TO YOU UNDER SUCH CIRCUMSTANCES.

FST PURE® is a registered trademark of Toshiba America Consumer Products, Inc.
REV. MAR02

Limited Canada Warranty for 27" FST PURE® and All Larger Television Models

If you purchased your TV in Canada, register it online at www.toshiba.ca

Toshiba of Canada Limited ("TCL") makes the following limited warranties to original consumers in Canada.

THESE LIMITED WARRANTIES EXTEND TO THE ORIGINAL CONSUMER PURCHASER OR ANY PERSON RECEIVING THIS TELEVISION AS A GIFT FROM THE ORIGINAL CONSUMER PURCHASER AND TO NO OTHER PURCHASER OR TRANSFEREE.

PRODUCTS PURCHASED IN THE U.S.A. AND USED IN CANADA ARE NOT COVERED BY THESE WARRANTIES.

PRODUCTS PURCHASED IN CANADA AND USED IN THE U.S.A. ARE NOT COVERED BY THESE WARRANTIES.

Limited One (1) Year Warranty on Parts and Labor*

TCL warrants this television and its parts against defects in materials or workmanship for a period of one (1) year after the date of original retail purchase. DURING THIS PERIOD, TCL WILL, AT TCL'S OPTION, REPAIR OR REPLACE A DEFECTIVE PART WITH A NEW OR REFURBISHED PART WITHOUT CHARGE TO YOU FOR PARTS OR LABOR. TCL Authorized Service Depot personnel will come to your home when warranty service is required. Depending on the type of repair required, either the service will be performed in your home or the set will be taken to the TCL Authorized Service Depot for repair and returned to your home at no cost to you. IN-HOME SERVICE ONLY APPLIES WITHIN 100 KILOMETERS OF AN AUTHORIZED TCL SERVICE DEPOT.

Limited Two (2) Year Warranty on Picture Tube*

TCL further warrants the picture tube in this television against defects in materials or workmanship for a period of two (2) years after the date of original retail purchase. DURING THIS PERIOD, TCL WILL, AT TCL'S OPTION, REPAIR OR REPLACE A DEFECTIVE PICTURE TUBE WITH A NEW OR REFURBISHED PICTURE TUBE WITHOUT CHARGE TO YOU, EXCEPT THAT, IF A DEFECTIVE PICTURE TUBE IS REPAIRED OR REPLACED AFTER ONE (1) YEAR FROM THE DATE OF THE ORIGINAL RETAIL PURCHASE, YOU PAY LABOR CHARGES INVOLVED IN THE REPAIR OR REPLACEMENT.

Rental Units

The warranty for rental units begins with the date of first rental or thirty (30) days from the date of shipment to the rental firm, whichever comes first.

*Commercial Units

Televisions sold and used for commercial purposes have a limited ninety (90) day warranty for all parts, labor, and picture tubes.

Owner's Manual

Read this owner's manual thoroughly before operating this television.

Your Responsibility

THE ABOVE WARRANTIES ARE SUBJECT TO THE FOLLOWING CONDITIONS:

- (1) You must provide your bill of sale or other proof of purchase.
- (2) All warranty servicing of this television must be made by an Authorized TCL Service Depot.
- (3) The warranties from TCL are effective only if the television is purchased in Canada from an authorized TCL dealer and operated in Canada.

- (4) Labor service charges for set installation, setup, adjustment of customer controls, and installation or repair of antenna systems are not covered by these warranties. Reception problems caused by inadequate antenna systems are your responsibility.
- (5) Warranties extend only to defects in materials or workmanship as limited above and do not extend to any television or parts that have been lost or discarded by you or to damage to television or parts caused by misuse, accident, Acts of God (such as lightning or fluctuations in electric power), improper installation, improper maintenance, or use in violation of instructions furnished by TCL; or to units that have been modified or had the serial number removed, altered, defaced, or rendered illegible.

How to Obtain Warranty Services

If, after following all of the operating instructions in this manual and checking the "Troubleshooting" section, you find that service is needed:

- (1) To find the nearest TCL Authorized Service Depot, visit TCL's web site: www.toshiba.ca.
- (2) Present your bill of sale or other proof of purchase to the Authorized Service Depot. Authorized TCL Service Depot personnel will come to your home when warranty service is required. Depending on the type of repair required, either the service will be performed in your home or the set will be taken to the Authorized Service Depot for repair and returned to your home at no cost to you. IN-HOME SERVICE ONLY APPLIES WITHIN 100 KILOMETERS OF AN AUTHORIZED TCL SERVICE DEPOT.

For additional information, visit TCL's web site:
www.toshiba.ca

ALL WARRANTIES IMPLIED BY THE LAW OF ANY PROVINCE OF CANADA, INCLUDING THE IMPLIED WARRANTIES OF MERCHANTABILITY AND FITNESS FOR A PARTICULAR PURPOSE, ARE EXPRESSLY LIMITED TO THE DURATION OF THE LIMITED WARRANTIES SET FORTH ABOVE. WITH THE EXCEPTION OF ANY WARRANTIES IMPLIED BY THE LAW OF ANY PROVINCE OF CANADA AS HEREBY LIMITED, THE FOREGOING WARRANTY IS EXCLUSIVE AND IN LIEU OF ALL OTHER WARRANTIES, GUARANTEES, AGREEMENTS, AND SIMILAR OBLIGATIONS OF TCL WITH RESPECT TO THE REPAIR OR REPLACEMENT OF ANY PARTS. IN NO EVENT SHALL TCL BE LIABLE FOR CONSEQUENTIAL OR INCIDENTAL DAMAGES.

No person, agent, distributor, dealer, or company is authorized to change, modify, or extend the terms of these warranties in any manner whatsoever. The time within which action must be commenced to enforce any obligation of TCL arising under this warranty or under any law of Canada or of any province thereof, is hereby limited to 90 days from the date you discover, or should have discovered, the defect. This limitation does not apply to implied warranties arising under the law of any province of Canada.

THIS WARRANTY GIVES YOU SPECIFIC LEGAL RIGHTS, AND YOU MAY ALSO HAVE OTHER RIGHTS, WHICH MAY VARY FROM PROVINCE TO PROVINCE IN CANADA. SOME PROVINCES OF CANADA DO NOT ALLOW LIMITATIONS ON THE DURATION OF AN IMPLIED WARRANTY, LIMITATIONS ON THE TIME WITHIN WHICH AN ACTION MAY BE BROUGHT, OR THE EXCLUSION OR LIMITATION OF INCIDENTAL OR CONSEQUENTIAL DAMAGES; THEREFORE, THE ABOVE LIMITATIONS OR EXCLUSIONS MAY NOT APPLY TO YOU UNDER SUCH CIRCUMSTANCES.

FST PURE® is a registered trademark of Toshiba America Consumer Products, Inc.
REV. MAR02

Index

A

ALS (Ambient Light Sensor)	73
A/V receiver connection	20
ANT 1/2	41
Antenna cables	11
AUDIO OUT sound, selecting	79
Audio system connection	19
Auto aspect	66
Auto convergence	50
Auto power off	82

B

Back of the TV	10
Blocking channels	86

C

CableClear™ DNR	74
Cable box connection	13
Camcorder connection	18
CH ▲▼ buttons	42
CH LABELING	62
CH LOCK	84
CH RTN button	63
CH SCAN button	70
Channel Number buttons	42
Channel programming	
ADD/DELETE	43
Automatic programming	42
Cinema mode	67
Clock, setting	51
Closed caption	75
Color temperature	74
Component video cables	11
Convergence adjustment	50
CrystalScan HDSC	7

D

Demonstration mode	83
Digital Audio Out	19
Display format	67
DNR (Digital Noise Reduction)	74
Double-Window ("POP") feature	68
Double-Window, size adjustment	69
DTV receiver connection	14
DVD connection	15
DVHS A/VC	22
DVI/HDCP connection	18

E F G I

EIA-775	22
FAV ▲▼ buttons	44
Favorite channels	44
Focus, SRS WOW	78
Front of the TV	9
Front panel lock	87
Game timer	87
IEEE 1394 (Firewire™)	22
INPUT button	61
Input lock	86
Integrated digital Tuning	7
IR blaster	25

L M

Labeling video inputs	62
Language selection	41
Last mode memory	83
Locking video inputs	86
LOCKS menu	84
Channels, blocking	86
Enable rating blocking	86
Game timer	86
MPAA rating	85
New PIN code	84
TV rating	85
Unlocking programs temporarily	86
Video inputs, locking	86
Menu system	35
MPEG-2 digital video signals	22
MTS feature	76
MUTE button	76

O P

On/off timer	82
Optical audio cable	11
Picture adjustments	
COLOR TEMPERATURE	74
FLESH TONE	73
Picture mode	72
Picture quality	72
Picture-out-picture (POP)	
FREEZE button	69
POP CH ▲▼ buttons	68
POP DIRECT CH button	68
SOURCE button	68
SPLIT button	68
SWAP button	69
Picture scroll	66
Picture size selection	65

Index *(continued)*

R

RECALL button	83
Remote control:	
Battery installation	27
Device code table	32
Functional key chart	28
Learning about the buttons	26
Operational feature reset	26
Programming	30
Searching and sampling the code	30
Volume Lock feature	31
RESET	9

S

SAP sound	76
Satellite receiver connection	14
Scrolling the Theater Wide picture	66
Secure Digital™ (SD) memory cards	80
Sleep timer	82
SmartMedia™ memory cards	80
Sound quality adjustments	77
SPEAKERS on/off	79
Specifications	93
SpeedSurf	63
SRS WOW	78
StableSound®	78
Stereo sound	76
Sub-bass system (SBS)	77
S-video cables	11

T

TheaterNet, button	46
Theaternet, connection	45
TheaterNet setup	45
Theater wide picture	64
TouchFocus™	50
Troubleshooting	88
TruBass, SRS WOW	78
TV Guide On Screen	37, 53
TV/VIDEO button	61

V

V-Chip blocking (Locks menu)	84
VCR connection	12
Video cables	11
Video input labels	62
Video input lock	86

W

Warranty	94
WOW feature	78

TOSHIBA AMERICA CONSUMER PRODUCTS, INC.

HEAD OFFICE: 82 TOTOWA ROAD, WAYNE, NJ 07470, U.S.A.
NATIONAL SERVICE DIVISION: 1420-B TOSHIBA DRIVE, LEBANON, TN 37087, U.S.A.

TOSHIBA HAWAII, INC.

HEAD OFFICE: 327 KAMAKEE STREET, HONOLULU, HI 96814, U.S.A. – TEL: (808) 591-9281

TOSHIBA OF CANADA LTD.

HEAD OFFICE: 191 McNABB STREET, MARKHAM, ONTARIO, L3R 8H2, CANADA – TEL: (905) 470-5400

SERVICE CENTERS:

TORONTO: 191 McNABB STREET, MARKHAM, ONTARIO L3R 8H2, CANADA – TEL: (905) 470-5400
MONTREAL: 1643 NORTH SERVICE RD., TRANS-CANADA HIGHWAY, DORVAL QUEBEC, H9P 1J1, CANADA – TEL: (514) 856-4100
VANCOUVER: 22171 FRASERWOOD WAY, RICHMOND, B.C., V6W 1J5, CANADA – TEL: (604) 303-2500

MANUFACTURED BY

TOSHIBA AMERICA CONSUMER PRODUCTS, INC.

ColorStream and StableSound are registered trademarks of Toshiba America Consumer Products, Inc.
CableClear, TouchFocus, SurfLock, Theaterlink, and TheaterNet are trademarks of Toshiba America Consumer Products, Inc.

Free Manuals Download Website

<http://myh66.com>

<http://usermanuals.us>

<http://www.somanuals.com>

<http://www.4manuals.cc>

<http://www.manual-lib.com>

<http://www.404manual.com>

<http://www.luxmanual.com>

<http://aubethermostatmanual.com>

Golf course search by state

<http://golfingnear.com>

Email search by domain

<http://emailbydomain.com>

Auto manuals search

<http://auto.somanuals.com>

TV manuals search

<http://tv.somanuals.com>