

TOSHIBA



Operating Guide

Integrated High Definition DLP™ Projection Television



50HMX96 56HMX96

IMPORTANT NOTE

Before connecting, operating, or adjusting this product, carefully read the Important Safety, Installation, Care, and Service information in the separate *Installation Guide*.

For an overview of steps for setting up your new TV, see page 7.

Note: To display a High Definition picture, the TV must be receiving a High Definition signal (such as an over-the-air High Definition TV broadcast, a High Definition digital cable program, or a High Definition digital satellite program). For details, please contact your TV antenna installer, cable provider, or satellite provider.

Note: If the TV is powered off and then quickly on again when the lamp unit is hot, it may take several minutes for the picture to appear on-screen. This is a property of DLP™ TV lamp technology and is NOT a sign of malfunction. For details, see "IMPORTANT NOTICE ABOUT HOT LAMP RESTART" on page 3.



Owner's Record

The model number and serial number are on the back of your TV. Record these numbers in the spaces below. Refer to these numbers whenever you communicate with your Toshiba dealer about this TV.

Model number:

Serial number:



CAUTION: This television is for use only with the Toshiba stand indicated below. Use with other carts or stands is capable of resulting in instability, causing possible injury.

Television	Stand Model
50HMX96	ST 5076
56HMX96	ST 5676

FCR Declaration of Conformity Compliance Statement (Part 15):

The **Toshiba 50HMX96 and 56HMX96 Televisions** comply with Part 15 of the FCC rules.

Operation is subject to the following two conditions: (1) this device may not cause harmful interference, and (2) this device must accept any interference received, including interference that may cause undesired operation.

The party responsible for compliance to these rules is:
Toshiba America Consumer Products, L.L.C.
82 Totowa Rd. Wayne, NJ 07470.
Ph: 1-800-631-3811

Note: This equipment has been tested and found to comply with the limits for a Class B digital device, pursuant to Part 15 of the FCC rules. These limits are designed to provide reasonable protection against harmful interference in a residential installation. This equipment generates, uses, and can radiate radio frequency energy and, if not installed and used in accordance with the instructions, may cause harmful interference to radio communications. However, there is no guarantee that interference will not occur in a particular installation. If this equipment does cause harmful interference to radio or television reception, which can be determined by removing and applying power to the equipment, the user is encouraged to try to correct the interference by one or more of the following measures:

- Reorient or relocate the receiving antenna.
- Increase the separation between the equipment and the receiver.
- Connect the equipment into an outlet on a circuit different from that to which the receiver is connected.
- Consult the dealer or an experienced radio/TV technician for help.

Caution: Changes or modifications to this equipment not expressly approved by Toshiba could void the user's authority to operate this equipment.

Important notes about your DLP™ projection TV

- 1) The light source for this TV is a projection lamp unit with a limited service life. When the lamp wears out, the picture may become dark or black or the lamp may fail, at which time you must replace the lamp unit (see "Lamp unit replacement and care" on pages 81–83).
- 2) When the lamp mode is set to **Low Power**, every time the TV is powered on, the lamp will initially be in **High Bright** mode but will switch to **Low Power** mode after a short period of time. You may notice a change in screen brightness when this happens. This is normal and is not a sign of malfunction (see page 55 for details).
- 3) Every time the TV is powered on, it may take several minutes for the picture to obtain full brightness (see IMPORTANT NOTICE ABOUT "HOT LAMP RESTART," on the next page).
- 4) The TV's display is manufactured using an extremely high level of precision technology; however, an occasional pixel (dot of light) may show constantly on the screen. This is a structural property of DLP™ (Digital Light Processing™) technology and is not a sign of malfunction. Such pixels are not visible when the picture is viewed from a normal viewing distance.
- 5) Always sit approximately 10–25 feet away from the TV and as directly in front of it as possible. The picture quality may be affected by your viewing position and length of viewing time. If you sit too closely to the TV for too long, you may suffer from eye fatigue. See item 29 under "Care" on page 4 of the separate *Installation Guide*.
- 6) Depending on the media you are viewing, it is possible, although unlikely, that a limited number of viewers may see a "rainbow effect" on the screen, which can, in rare instances, result in eye fatigue. This is a rare occurrence related to DLP technology and is not a sign of TV malfunction.
- 7)  This TV contains several cooling fans to moderate the internal temperature. You may be able to hear the fans for several minutes after the TV is turned off. This is a function of the Quick Restart™ feature and is not a sign of TV malfunction. You can set the Quick Restart™ feature to stop the fans as soon as the TV is powered off. See "Setting the Quick Restart™ feature" (see page 30).
- 8) The yellow and blue LED lights at the bottom center of the TV front indicate your TV's current status. If either light flashes, see "LED indications" (see page 80).
- 9) Every time the TV power cord is plugged in, the yellow LED will blink until the TV enters standby mode (plugged in but not powered on). This is normal and is not a sign of malfunction.

IMPORTANT NOTICE ABOUT “HOT LAMP RESTART”

When the TV has been powered on long enough for the lamp unit to get hot, it may take several minutes for the picture to appear on-screen in the following situations:

- When the Quick Restart™ feature is set to **OFF** and you turn the TV off and then on again within a few minutes; or
- If the TV is on when a short-term power failure, power surge, or other similar power failure occurs, such that the TV loses and regains power within a few minutes.

This is a property of DLP™ TV lamp technology and is NOT a sign of malfunction.

If this occurs, the yellow LED on the TV front panel will blink (and the blue LED will be lit solid) until the TV is finished restarting the lamp and the normal picture appears. If both LEDs are blinking, you will need to turn the TV off and then on again to restart the lamp.

Trademark Information

- This product incorporates copyright protection technology that is protected by U.S. patents and other intellectual property rights. Use of this copyright protection technology must be authorized by Macrovision, and is intended for home and other limited viewing uses only unless otherwise authorized by Macrovision. Reverse engineering or disassembly is prohibited.
- WOW, TruSurround, SRS and ● symbol are trademarks of SRS Labs, Inc. WOW and TruSurround technologies are incorporated under license from SRS Labs, Inc.
- *Manufactured under license from Dolby Laboratories. Dolby, Pro Logic, and the double-D symbol are registered trademarks of Dolby Laboratories.
- CableCARD™ is a trademark of Cable Television Laboratories, Inc.
- HDMI, the HDMI logo and High-Definition Multimedia Interface are trademarks or registered trademarks of HDMI Licensing LLC.
- Digital Light Processing™, DLP™ and the DLP™ medallion are trademarks of Texas Instruments.
- In the United States, TV GUIDE and other related marks are registered marks of Gemstar-TV Guide International, Inc. and/or one of its affiliates. In Canada, TV GUIDE is a registered mark of Transcontinental Inc., and is used under license by Gemstar-TV Guide International, Inc. The TV Guide On Screen™ system is manufactured under license from Gemstar-TV Guide International, Inc. and/or one of its affiliates. The TV Guide On Screen™ system is protected by one or more of the following United States patents 4,908,713; 6,498,895; 6,850,693; 6,396,546; 5,940,073; 6,239,794 to Gemstar-TV Guide International, Inc. and/or its subsidiaries.
- GEMSTAR-TV GUIDE INTERNATIONAL INC. AND/OR ITS RELATED AFFILIATES ARE NOT IN ANY WAY LIABLE FOR THE ACCURACY OR AVAILABILITY OF THE PROGRAM SCHEDULE INFORMATION OR OTHER DATA IN THE TV GUIDE ON SCREEN SYSTEM AND CANNOT GUARANTEE SERVICE AVAILABILITY IN YOUR AREA. IN NO EVENT SHALL GEMSTAR-TV GUIDE INTERNATIONAL, INC. AND/OR ITS RELATED AFFILIATES BE LIABLE FOR ANY DAMAGES IN CONNECTION WITH THE ACCURACY OR AVAILABILITY OF THE PROGRAM SCHEDULE INFORMATION OR OTHER DATA IN THE TV GUIDE ON SCREEN SYSTEM.

Contents

Chapter 1: Introduction	6	Adjusting the picture quality	42
Welcome to Toshiba	6	Using the closed caption mode	43
Features of your new TV	6	Closed Caption Advanced	43
Overview of steps for installing, setting up, and		Digital closed captions	44
using your new TV	7	Using the Closed Caption button on the	
TV front and side panel controls and connections	8	remote control	44
TV back panel connections	9	Adjusting the audio	44
Chapter 2: Using the remote control	11	Muting the sound	44
Installing the remote control batteries	11	Using the digital audio selector	44
Remote control effective range	11	Selecting stereo/SAP broadcasts	45
Learning about the remote control	12	Adjusting the audio quality	45
Remote Control functional key chart	14	Using the StableSound® feature	46
Using the remote control to operate your other devices	16	Turning off the built-in speakers	46
Programming the remote control to operate		Selecting the optical audio output format	46
your other devices	16	Using the Locks menu	47
Device code setup	16	Entering the PIN code	47
Searching and sampling the code of a device (8500)	17	If you cannot remember your PIN code	47
Using the volume lock feature (8000)	17	Changing your PIN code	47
Operational feature reset (8900)	17	Blocking TV programs and movies	
Multi-brand remote control device codes	18	by rating (V-Chip)	48
Chapter 3: Menu layout and navigation	22	Blocking TV programs and movies	
Main menu layout	22	by additional ratings	48
Setup/Installation menu layout	23	Blocking channels	49
THINC menu layout	24	Unlocking programs temporarily	50
Navigating the menu system	24	Using the input lock feature	50
Chapter 4: Setting up your TV	25	Using the GameTimer™	50
Selecting the menu language	25	Using the control panel lock feature	51
Configuring the antenna input sources for the		Setting the sleep timer	51
ANT 1 and ANT 2 terminals	25	Setting the On/Off Timer	52
Programming channels into the TV's channel memory	26	Using the PC setting feature	52
Programming channels automatically	26	Displaying TV setting information on-screen	
Manually adding and deleting channels in the channel		using RECALL	53
memory	27	Understanding the auto power off feature	53
Setting the time and date	28	Understanding the last mode memory feature	53
Setting the ColorStream® HD audio mode	28	Chapter 6: Using the TV's advanced features	54
Setting the HDMI™ audio mode	29	Using the advanced picture settings features	54
Viewing the CableCARD™ menu	29	Using dynamic contrast	54
Setting the Quick Restart™ feature	30	Using CableClear® digital noise reduction	54
Viewing the digital signal meter	30	Using MPEG noise reduction	55
Viewing the system status	31	Selecting the color temperature	55
Chapter 5: Using the TV's features	32	Selecting the lamp mode	55
Selecting the video input source to view	32	Using the Vertical Edge Enhancer feature	56
Labeling the video input sources	32	Using the Color Management feature	56
Tuning channels	33	Using the Game Mode feature	57
Tuning channels using the Channel Browser™	33	Using the advanced audio settings features	58
Tuning to the next programmed channel	35	Using the SRS WOW™ surround sound feature	58
Tuning to a specific channel (programmed or		Using the virtual surround sound feature	
unprogrammed)	35	(Dolby® Virtual/SRS TruSurround™)	58
Switching between two channels			
using Channel Return	36		
Switching between two channels using SurfLock™	36		
Selecting the picture size	37		
Scrolling the TheaterWide® picture			
(TheaterWide 2 and 3 only)	38		
Using the auto aspect ratio feature	39		
Selecting the cinema mode (480i signals only)	39		
Using the POP features	40		
Using the POP double-window feature	40		
Switching the speaker audio (left or right)	41		
POP double-window aspect ratio	41		
Using the FREEZE feature	41		
Adjusting the picture	42		
Selecting the picture mode	42		

Chapter 7: Using the THINC™ home network feature	59
A. Connecting the TV to your home network	59
B. Setting up the network address	59
Automatically setting up the network address	59
Manually setting up the network address	60
Resetting the network address	61
C. Setting up file sharing on your PC	61
Compatible operating systems	61
Setting up file sharing on a PC with Microsoft®	
Windows® XP Service Pack 1 or Service Pack 2	61
Setting up file sharing on a PC with	
Microsoft® Windows® 2000	62
D. Setting up file sharing on the TV	63
About the Software Upgrade feature	64
E. Viewing/playing shared files on the TV	64
Media specifications	64
Using the Picture Viewer	65
Using the Audio Player	67
F. Setting up e-mail scheduling	68
Required information and services	68
Setting up e-mail scheduling	68
Description of fields in the “E-mail Scheduling Setup”	
window	71
G. Using e-mail scheduling	73
E-mail parameters	73
Sending a request e-mail to the TV	73
Formatting a request e-mail	73
Sample request e-mails	74
Receiving an e-mail from the TV	75
Modifying an existing recording or reminder	75
Chapter 8: Troubleshooting	76
General troubleshooting	76
Home network troubleshooting	78
LED indications	80
Chapter 9: Appendix	81
Lamp unit replacement and care	81
Replacing the lamp unit	
(User-replaceable component)	81
When to replace the lamp unit	81
How to replace the lamp unit	82
Disposing of the used lamp unit	83
Specifications	84
Limited United States Warranty	
for DLP™ Television Models	85
Limited Canada Warranty	
for DLP™ Television Models	86
Index	88

Chapter 1: Introduction



**NOTICE OF POSSIBLE TV STAND INSTABILITY
DANGER: RISK OF SERIOUS PERSONAL
INJURY OR DEATH!** Use this TV only with
the TOSHIBA TV stand listed in the
“Specifications” section of this manual. Use with other
stands may result in instability, causing possible injury or
death.

Welcome to Toshiba

Thank you for purchasing this Toshiba TV, one of the most innovative DLP™ projection TVs on the market.

This digital television is capable of receiving analog basic, digital basic, and digital premium cable television programming by direct connection to a cable system providing such programming. A security card provided by your cable operator is required to view encrypted digital programming. Certain advanced and interactive digital cable services (such as video-on-demand, a cable operator's enhanced program guide, or data-enhanced television services) may require the use of a set-top box. For more information, call your local cable operator.

We have provided three separate Guides to facilitate the installation and operation of your TV.

Please use the Guides in the order shown below to get the most enjoyment from your new TV.

- 1) The “Installation Guide” explains how to connect your TV to your antenna and equipment.
- 2) The “Operating Guide” provides step-by-step instructions for using your TV's many features.
- 3) The “TV Guide On Screen™ Interactive Program Guide” explains how to set up and navigate the TV Guide On Screen™ system in your TV.

Note: The TV screen graphics in the Guides are for illustration purposes only and may be different from the screens displayed on your TV.

Features of your new TV

The following are just a few of the many exciting features of your new Toshiba widescreen, integrated HD, DLP™ projection TV:

- **Integrated digital tuning (8VSB ATSC and QAM)** eliminates the need for a separate digital converter set-top box (in most cases).
- **TV Guide On Screen™** no-fee interactive program guide (see *TV Guide On Screen™ Interactive Program Guide*).
- **Digital CableCARD™ slot** for viewing encrypted digital Cable TV programs (see *Installation Guide*).
- **Two HDMI™** digital, high-definition multimedia interfaces (see *Installation Guide*).
- **Two sets of ColorStream® HD** high-resolution component video inputs (see *Installation Guide*).
- **Dolby Digital** (see *Installation Guide*), **SRS WOW™** (see page 58), and **Dolby Virtual/SRS TruSurround™** audio technologies (see page 58).
- **Digital Audio Out** optical audio connection with Dolby® Digital optical output format (see page 46; also see *Installation Guide*).
- **CableClear®** digital picture noise reduction (see page 54).
- **Double-window POP** feature (see page 40).
- **PC IN (Analog RGB)** for using the TV screen as the display for a PC (see *Installation Guide*).
- **Ethernet (RJ-45) (THINC™) port** for connecting the TV to a home network to enable file sharing (JPEG, MP3) and e-mail scheduling of recordings and reminders (see Chapter 7 and *Installation Guide*).

Chapter 1: Introduction

Overview of steps for installing, setting up, and using your new TV

Follow these steps to set up your TV and begin using its many exciting features.

- 1** Carefully read the important safety, installation, care, and service information in the separate *Installation Guide*. Keep this manual for future reference.
- 2** Observe the following when choosing a location for the TV:
 - Read the separate *Installation Guide*.
 - Read the separate *TV Guide On Screen™ Interactive Program Guide*.
 - Read “Important notes about your DLP™ projection TV” (☞ page 2).
 - Place the TV on the applicable optional TV stand listed in the “Specifications” section (if available for this TV model) or on a sturdy, level, stable surface that can safely support the size and weight of the unit.
 - Place the TV in a location where light does not reflect on the screen.
 - Place the TV far enough from walls and other objects to allow proper ventilation. Inadequate ventilation may cause overheating, which will damage the TV. **THIS TYPE OF DAMAGE IS NOT COVERED UNDER THE TOSHIBA WARRANTY.**
- 3** Do not plug in any power cords until AFTER you have connected all cables and devices to your TV.
- 4** BEFORE connecting cables or devices to the TV, learn the functions of the TV’s connections and controls (☞ pages 8–9).
- 5** Connect your other electronic device(s) to the TV (☞ *Installation Guide*).
- 6** Connect the supplied G-LINK™/IR blaster cable from your VCR and/or Cable box (if applicable) to the G-LINK™ terminal so you can use the TV Guide On Screen™ features (applies to VCRs and cable boxes only) (☞ *Installation Guide*).
- 7** Install the batteries in the remote control (☞ page 11).
- 8** See “Learning about the remote control” (☞ page 12) for an overview of the buttons on the remote control.
- 9** Program the remote control to operate your other device(s) (☞ pages 16–21).
- 10** AFTER connecting all cables and devices, plug in the power cords for your TV and other devices.
- 11** After you plug in the TV power cord, the yellow LED (on the TV front) will blink 3 times. Wait several seconds until the yellow LED stops blinking and then press **POWER** on the TV or remote control.
See “LED indications” (☞ page 80).
- 12** See “Menu layout and navigation” for a quick overview of the TV’s menu system (☞ page 22).
- 13** See the separate *TV Guide On Screen™ Interactive Program Guide* for details on setting up and using the TV Guide On Screen™ system (if available in your area).
- 14** Program channels into the TV’s channel memory (☞ page 26).
- 15** For details on using the TV’s features, see Chapters 5 and 6.
- 16** For details on connecting the TV to a home network to enable file sharing and e-mail scheduling of recordings, see Chapter 7.
- 17** For help, refer to the Troubleshooting Guide, Chapter 8.
- 18** For lamp unit replacement instructions, see Chapter 9.
- 19** For technical specifications and warranty information, see Chapter 9.
- 20** Enjoy your new TV!

Chapter 1: Introduction

TV front and side panel controls and connections

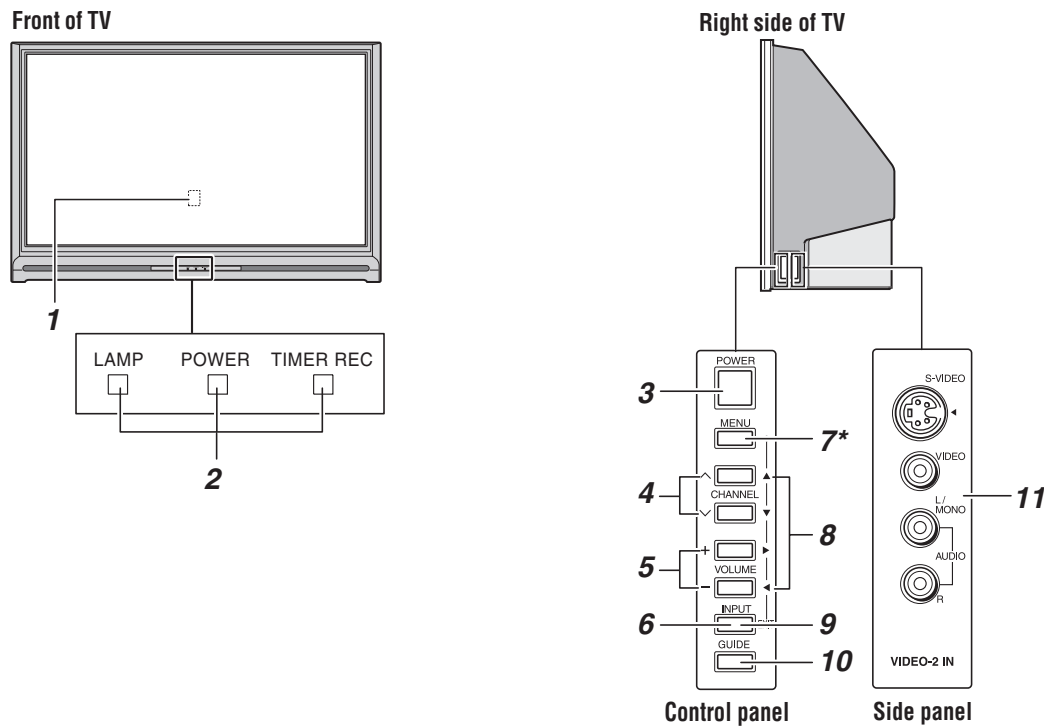

- 1 Remote sensor** (behind the screen) — Point the remote control toward this area of the TV screen (☞ “Remote control effective range” on page 11).
- 2 Blue, Yellow and Green/Red LEDs**
See “LED indications” on page 80 for additional information.
- 3 POWER** — Press to turn the TV on and off.
If the TV stops responding to the controls on the remote control or TV control panel and you cannot turn off the TV, press and hold the **POWER** button on the TV control panel for 5 or more seconds to reset the TV.
- 4 CHANNEL** $\wedge \vee$ — When no menu is on-screen, these buttons change the channel (programmed channels only; ☞ page 26). When a menu is on-screen, these buttons function as up/down menu navigation buttons.
- 5 VOLUME** $+ -$ — When no menu is on-screen, these buttons adjust the volume level. When a menu is on-screen, these buttons function as left/right menu navigation buttons.
- 6 INPUT** — Repeatedly press to change the source you are viewing (**ANT 1, VIDEO 1, VIDEO 2, ColorStream HD-1, ColorStream HD-2, HDMI 1, HDMI 2, PC, ANT 2**).
- 7 *MENU (ENTER)** — Press to access the menu system (☞ pages 22–23). When a menu is on-screen, the **MENU** button on the TV’s side control panel functions as the **ENTER** button.
- 8 ARROWS** $\blacktriangle \blacktriangledown \blacktriangleleft \blacktriangleright$ — When a menu is on-screen, these buttons function as up/down/left/right menu navigation buttons.
- 9 EXIT** — Press to instantly close an on-screen menu.
- 10 GUIDE** — Press to access the TV Guide On Screen™ program guide (☞ *TV Guide On Screen™ Interactive Program Guide*).
- 11 VIDEO-2 IN** — The side panel A/V connections are referred to as “**VIDEO 2**” and include standard A/V inputs plus an optional S-video input.

Chapter 1: Introduction

TV back panel connections

For an explanation of cable types and connections, see the *Installation Guide*.

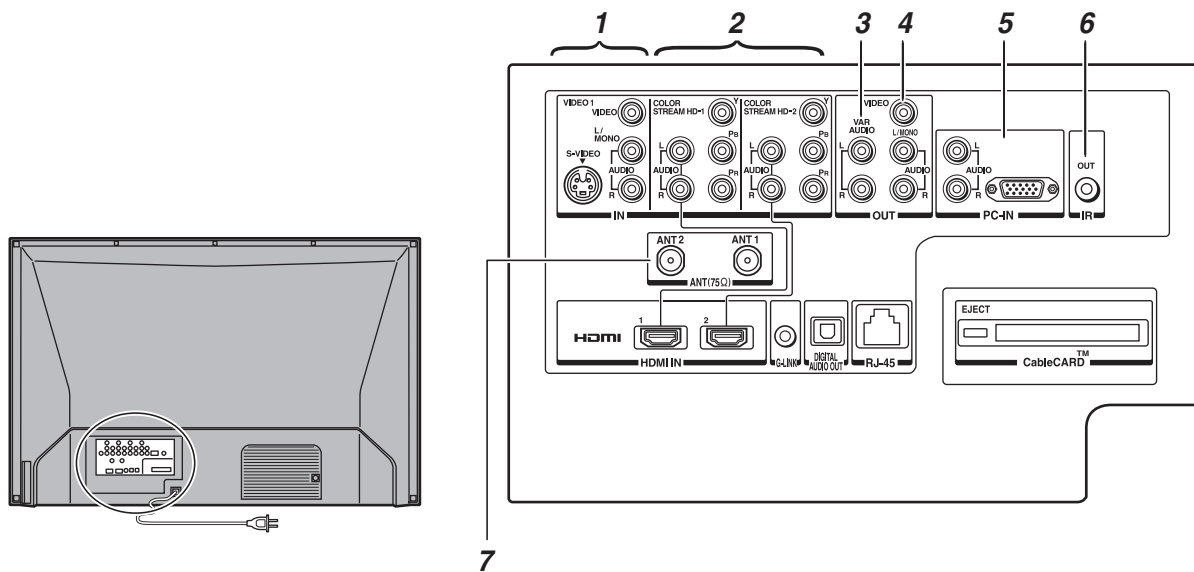

1 VIDEO 1 IN — Composite video and analog audio inputs plus optional S-video inputs for connecting devices with composite video or S-video output.

Note: Composite video and S-video cables carry only video information; separate audio cables are required for a complete connection.

2 ColorStream® HD-1 IN and ColorStream® HD-2 IN — Two sets of ColorStream® high-definition component video inputs (with analog stereo audio inputs) for connecting devices with component video output, such as a Toshiba DVD player with ColorStream®.

Note:

- Component video cables carry only video information; separate audio cables are required for a complete connection.
- HDMI 1 (and 2) share analog audio inputs with ColorStream HD-1 (and HD-2). To specify the use of the audio inputs for a connected ColorStream (component video) device, see "Setting the ColorStream HD audio mode" on page 28.

3 Variable Audio OUT — Standard analog audio outputs for connecting an analog amplifier with external speakers.

4 A/V OUT — Standard composite video and analog audio outputs for connecting a VCR for editing and dubbing.

Note: The A/V OUT terminals will output AUDIO ONLY (no video) in the following instances:

- When the TV's INPUT mode is HDMI, ColorStream, or PC (☞ "Selecting the video input source to view," page 32).
- When the POP window is open (☞ page 40).
- When the MP3 Audio Player is active (☞ page 67).

5 PC IN — For use when connecting audio and video from a personal computer to use the TV screen as the display for the PC (☞ *Installation Guide*).

6 IR OUT — For controlling infrared remote-controlled devices through the TV. You can connect up to two devices with an IR blaster cable, and then control the devices using the TV's IR pass-through features.

7 ANT 1 and ANT 2 — Two inputs that support analog (NTSC) and digital (ATSC) off-air antenna signals and analog and digital Cable TV (QAM) signals.

Note: If you have an antenna only, connect it to **ANT 1**. If you have both cable TV and an antenna, connect the cable TV to **ANT 1** and the antenna to **ANT 2**.

(continued)

Chapter 1: Introduction

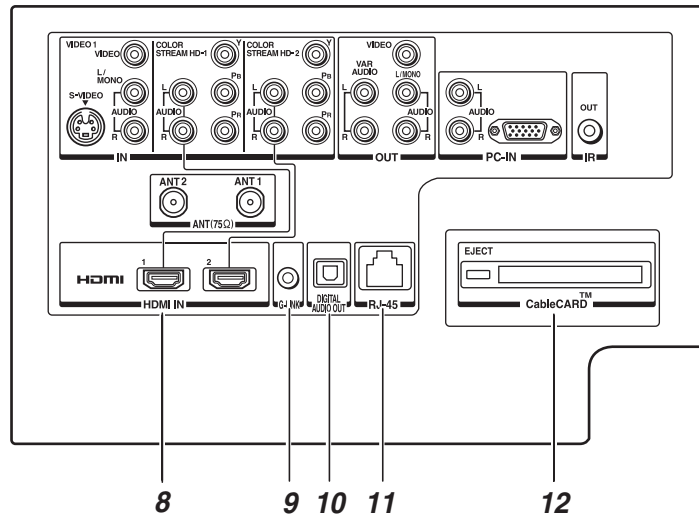

8 HDMI™ 1 IN and HDMI™ 2 IN — Two High-Definition Multimedia Interface inputs receive digital audio and uncompressed digital video from an HDMI device or uncompressed digital video from a DVI device. Also see item 2.

Note: HDMI 1 (and 2) IN share analog audio inputs with ColorStream HD-1 (and HD-2) IN. To specify the use of the audio inputs for a connected HDMI (or DVI) device, see “Setting the HDMI audio mode” on page 29.

9 G-LINK™ — For use with the enclosed IR blaster/ G-LINK™ cable to enable the TV Guide On Screen™ recording features (see *Installation Guide*).

10 Digital Audio OUT — Optical audio output in Dolby* Digital or PCM (pulse-code modulation) format for connecting an external Dolby Digital decoder, amplifier, A/V receiver, or home theater system with optical audio input.

11 RJ-45 (Ethernet) (THINC™ system)** — Allows you to connect the TV to your home network. See boxed note below.

****THINC™ system**

(Toshiba Home Interactive Network Connection)

The RJ-45 (Ethernet) port allows your Toshiba TV to connect to your home network. This revolutionary home entertainment networking system lets you access MP3 audio files and JPEG picture files that are stored on a networked PC (as shared files) and play/display them on your TV. You also can play your shared MP3 audio files through a connected audio system. See *Installation Guide* and Chapter 7 for details.

12 CableCARD™ slot — For use with a digital security card and digital cable TV service (provided by your local cable operator) to view encrypted digital programming (see page 29).

HDMI, the HDMI logo and High-Definition Multimedia Interface are trademarks or registered trademarks of HDMI Licensing LLC. CableCARD is a trademark of Cable Television Laboratories, Inc.

* Manufactured under license from Dolby Laboratories. Dolby, Pro Logic, and the double-D symbol are registered trademarks of Dolby Laboratories.

Chapter 2: Using the remote control

Installing the remote control batteries

To install the remote control batteries:

- 1 Slide the battery cover off the back of the remote control.

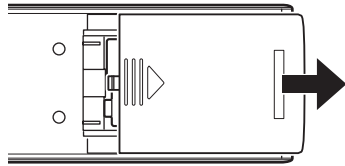

- 2 Install two "AA" size alkaline batteries. Match the + and – symbols on the batteries to the symbols on the battery compartment.

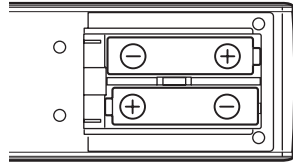

- 3 Slide the battery cover on to the remote control until the lock snaps.

Caution: Always dispose of batteries in a designated disposal location. Never throw batteries into a fire.

Note:

- Be sure to use AA size alkaline batteries.
- Dispose of batteries in a designated disposal area.
- Batteries should always be disposed of with the environment in mind. Always dispose of batteries in accordance with applicable laws and regulations.
- If the remote control does not operate correctly, or if the operating range becomes reduced, replace batteries with new ones.
- When necessary to replace batteries in the remote control, always replace both batteries with new ones. Never mix battery types or use new and used batteries in combination.
- Always remove the batteries from remote control if they are dead or if the remote control is not to be used for an extended period of time. This will prevent battery acid from leaking into the battery compartment.

Remote control effective range

For optimum performance, aim the remote control directly at the TV and obstructions between the remote control and the TV.

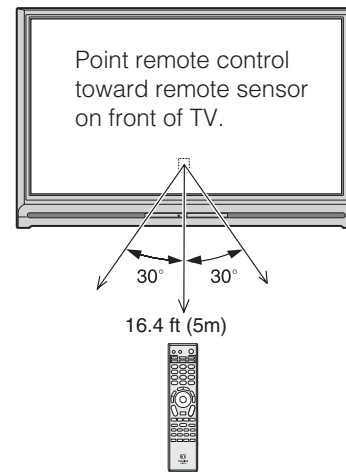

Chapter 2: Using the remote control

Learning about the remote control

The buttons used for operating the TV only are described here. For a complete list of the remote control's functions, see the remote control functional key chart (pages 14–15).

For a list of the buttons that operate the TV Guide On Screen™ system, see the separate *TV Guide On Screen™ Interactive Program Guide*.

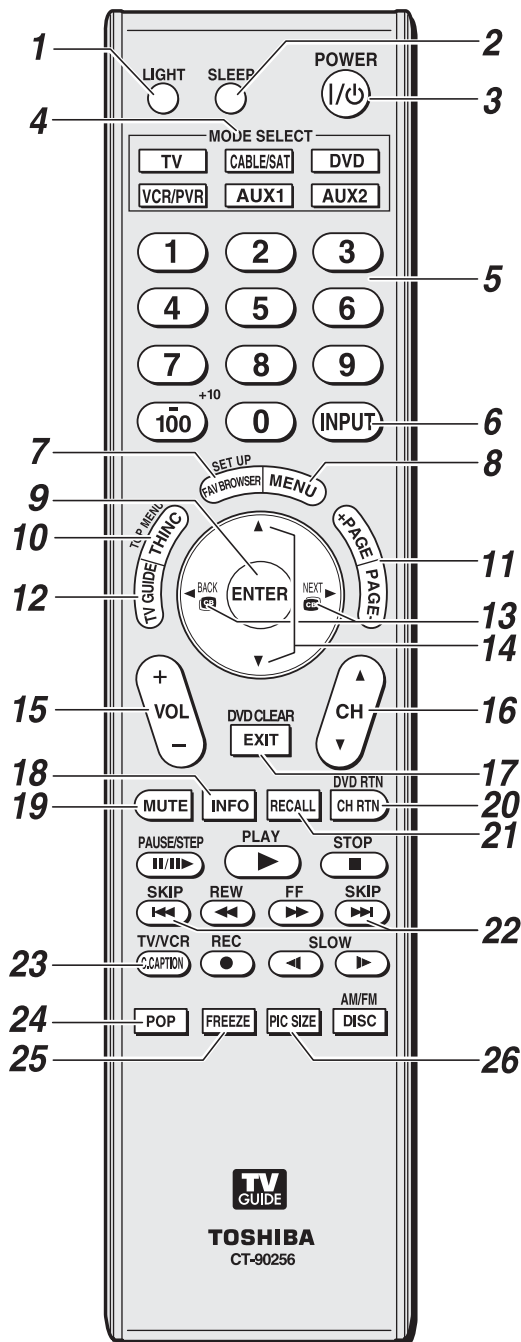

Note: The error message "Not Available" may appear if you press a key for a function that is not available.

- 1 **LIGHT** illuminates the keypad for five seconds. The MODE SELECT key that is being selected blinks three times.
- 2 **SLEEP** accesses the sleep timer (page 51).
- 3 **POWER** turns the TV on and off. When the TV is on, the blue LED indicator on the TV front will be illuminated.
Note: The Quick Restart™ setting will affect the amount of time it takes for the picture to appear when you turn on the TV (page 30).
- 4 **MODE SELECT** sets the six remote control device modes: **TV**, **CABLE/SAT**, **DVD**, **VCR/PVR**, **AUX 1**, and **AUX 2**. Press **TV** until the keypad blinks 3 times to control the TV. The selected MODE key blinks each time any key is pressed. (page 16).
- 5 **Channel Numbers (0–9, –/100)** directly tune channels. The **100** button is used to tune digital channels (page 35) or to edit the Favorite List (page 33).
- 6 **INPUT** selects the video input source (page 32).
- 7 **FAV BROWSER** accesses the Favorites List in the Channel Browser™ (page 33).
- 8 **MENU** accesses the main TV menu system (pages 22 and 23) or opens a menu in the TV Guide On Screen™ system (TV Guide On Screen™ Interactive Program Guide).
- 9 **ENTER** activates highlighted items in the main menu system and the TV Guide On Screen™ system.
- 10 **THINC** accesses the THINC menu (page 24).
- 11 **PAGE + -** When the TV Guide On Screen™ system is open, moves from one set of screen information to the next, when applicable.
- 12 **TV GUIDE** opens the TV Guide On Screen™ system (TV Guide On Screen™ Interactive Program Guide).
- 13 **BACK / NEXT** While watching TV, these buttons open the Channel Browser banner and tune to the previous/next channel in the channel history (page 34). (Also see "Arrow buttons.")
- 14 **Arrow buttons (▲▼◀▶)** When a menu is on-screen, these buttons select or adjust programming menus. (Also see **BACK / NEXT**.)
- 15 **VOL + -** adjusts the volume level.
- 16 **CH ▲▼** cycles through programmed channels when no menu is on-screen (page 26), and functions as page up/down when a menu is on-screen or when the TV Guide On Screen™ system is open (TV Guide On Screen™ Interactive Program Guide).

Chapter 2: Using the remote control

- 17 EXIT** closes on-screen menus and the TV Guide On Screen™ system.
- 18 INFO** provides detailed information on highlighted items in the TV Guide On Screen™ system (☞ *TV Guide On Screen™ Interactive Program Guide*).
- 19 MUTE** reduces or turns off the sound (☞ page 44).
- 20 CH RTN** returns to the last viewed channel (☞ page 36), or stops the picture viewer slide show (☞ page 66). Also can be used to go between the song select and file select view in the Audio Player (☞ page 67).
- 21 RECALL** displays TV setting information on-screen (☞ page 53).
- 22 SKIP** ◀◀ and ▶▶ jump backward and forward one day at a time in the TV Guide On Screen™ listings (☞ *TV Guide On Screen™ Interactive Program Guide*).
- 23 C.CAPTION (TV/VCR)** opens the closed caption/audio selector screen. (For analog channels, the audio selector is not available.) (☞ pages 43–44.)
Also can be used to select TV mode to view one program while recording another.
- 24 POP** opens the POP double-window (☞ page 40) or locks/unlocks the TV Guide On Screen™ video window (☞ *TV Guide On Screen™ Interactive Program Guide*).
- 25 FREEZE** freezes the picture. Press again to restore the moving picture.
- 26 PIC SIZE** cycles through the five pictures sizes: **Natural**, **TheaterWide 1/2/3**, and **Full** (☞ page 37).

Chapter 2: Using the remote control

Remote Control functional key chart

REMOTE CONTROL KEY	Toshiba TV (TV)	CABLE	SAT (satellite)	VCR	•DVD/VCR combo • DVD/DVD-R	Receiver/AMP	CD (AUDIO)	PVR
MODE SELECT	Remote control device mode selection							
LIGHT	Lights the remote key.*1							
SLEEP	Sleep timer	---	---	---	---	---	---	---
POWER	Power	Power	Power	Power	Power	Power	Power	Power
1	Digit 1	Digit 1	Digit 1	Digit 1	Digit 1	AV input 1	Digit 1	Digit 1
2	Digit 2	Digit 2	Digit 2	Digit 2	Digit 2	AV input 2	Digit 2	Digit 2
3	Digit 3	Digit 3	Digit 3	Digit 3	Digit 3	AV input 3	Digit 3	Digit 3
4	Digit 4	Digit 4	Digit 4	Digit 4	Digit 4	AV input 4	Digit 4	Digit 4
5	Digit 5	Digit 5	Digit 5	Digit 5	Digit 5	CD	Digit 5	Digit 5
6	Digit 6	Digit 6	Digit 6	Digit 6	Digit 6	Tuner	Digit 6	Digit 6
7	Digit 7	Digit 7	Digit 7	Digit 7	Digit 7	Phono	Digit 7	Digit 7
8	Digit 8	Digit 8	Digit 8	Digit 8	Digit 8	Cassette	Digit 8	Digit 8
9	Digit 9	Digit 9	Digit 9	Digit 9	Digit 9	Aux	Digit 9	Digit 9
0	Digit 0	Digit 0	Digit 0	Digit 0	Digit 0	---	Digit 0, 10	Digit 0
100/-/+10	- (digital separator)	---	-/--, +10, +100	+100	-/--, +10, +100	---	---	---
INPUT	TV/Video select	← TV	← TV	← TV	← TV	Input	← TV	← TV
PIC SIZE	Selects the image shape	← TV	← TV	← TV	← TV	← TV	← TV	← TV
MENU	Menu/ Guide Menu	Menu	Menu	---	Disc menu	Menu	Menu	Menu
FAV BROWSER/ SET UP	FAV BROWSER	---	---	---	Setup menu	---	---	---
THINC/ TOP MENU	THINC	← TV	← TV	← TV	Title	← TV	← TV	← TV
TV GUIDE	TV Guide	Guide	Guide	---	Guide	---	---	Guide
INFO	Guide Info	Info	Info	---	Info	---	---	Info
ENTER	Enter	Select	Select	---	Select	---	---	Select
▲	Menu select up	Cursor up	Cursor up	---	Cursor up	---	---	Cursor up
▼	Menu select down	Cursor down	Cursor down	---	Cursor down	---	---	Cursor down
◀ BACK NEXT ▶	Menu select left/right Back Next	Cursor left/ right	Cursor left/ right	---	Cursor left/ right	---	---	Cursor left/ right
EXIT/ DVD CLEAR	Exit	Exit	Exit	---	Exit	---	---	Exit
PAGE +/-	Page up/ down	Page up/ down	Page up/ down	---	Page up/ down	---	---	---
VOL +/-	Volume up/ down*2	Volume up/ down*2	Volume up/ down*2	Volume up/ down*2	Volume up/ down*2	Volume up/ down*2	Volume up/down*2	Volume up/ down*2

Chapter 2: Using the remote control

REMOTE CONTROL KEY	Toshiba TV (TV)	CABLE	SAT (satellite)	VCR	• DVD/VCR combo • DVD/ DVD-R	Receiver/ AMP	CD (AUDIO)	PVR
CH RTN/ DVD RTN	Previous channel	Previous channel	Previous channel	---	Cancel	---	---	---
RECALL	On-screen display	← TV	← TV	← TV	← TV	← TV	← TV	← TV
MUTE	Sound mute	Sound mute*2	Sound mute*2	Sound mute*2	Sound mute*2	Sound mute*2	Sound mute*2	Sound mute*2
SLOW	---	---	---	Slow FWD Slow REW	Slow FWD Slow REW	---	---	Slow FWD Slow REW
SKIP ►► SKIP ◄◄	Skip FWD Skip REW	---	---	---	Skip FWD Skip REW	---	Skip FWD Skip REW	---
REW	Rewind	Rewind	Rewind	Rewind	Rewind	---	Rewind	Rewind
PAUSE/STEP	Pause	Pause	Pause	Pause	Pause	---	Pause	Pause
PLAY	Play	Play	Play	Play	Play	---	Play	Play
FF	Fast FWD	Fast FWD	Fast FWD	Fast FWD	Fast FWD	---	Fast FWD	Fast FWD
C.CAPTION TV/VCR	C.Caption	---	TV/SAT	TV/VCR	---*4	---	---	---
DISC/AM/FM	---	---	---	---	---*5	AM/FM	Disk SKIP Disc select	Instant replay
STOP	Stop	Stop	Stop	Stop	Stop	---	Stop	Stop
REC	REC Menu (Single Click)	Record (Double click)	Record (Double click)	Record (Double Click)	Record (Double click)*3	---	---	Record (Double Click)
CH ▲ ▼	Channel up/ down	Channel up/ down	Channel up/ down	Channel up/ down	Channel up/ down	Channel up/ down	---	Channel up/ down
POP	Split	← TV	← TV	← TV	← TV	← TV	← TV	← TV
FREEZE	Freeze	← TV	← TV	← TV	← TV	← TV	← TV	← TV

Note:

- “---” = key does not send a signal in that remote control mode.
- “← TV” = key will affect the TV, even though the remote control is not in TV mode.

*1 Does not send IR signal.

*2 Volume will affect the TV by default. When the volume is unlocked, all the devices will have their own volume if their ID has volume data. The **AUDIO** modes (receiver, CD) will have their own volume if volume lock is set on **TV, CABLE/SAT, VCR/PVR, or DVD** mode. See “Using the volume lock feature” (page 17).

*3 DVD/DVD-R : RECORD is only for DVD-R, no function is picked for DVD.

*4 DVD/VCR combo : TV/VCR

*5 DVD/VCR combo : DVD/VCR

Chapter 2: Using the remote control

Using the remote control to operate your other devices

Your TV remote control has one dedicated TV mode and five programmable multi-brand modes: **CABLE/SAT**, **DVD**, **VCR/PVR**, **AUX 1**, and **AUX 2**. The default device modes and programmable device modes are listed below.

Note: The TV remote control is preprogrammed to operate most Toshiba devices. To operate a non-Toshiba device or a Toshiba device that the remote control is not preprogrammed to operate, you will need to program the remote control. See "Programming the remote control to operate your other devices" (at right).

MODE SELECT	Default device mode control (before programming)
TV	Toshiba TV
CABLE/SAT	Toshiba DST 3100 Satellite receiver
DVD	Orion DVD
VCR/PVR	Toshiba VCR
AUX 1	Yamaha Audio receiver
AUX 2	Onkyo Audio receiver

MODE SELECT	Device mode control after programming
TV	Toshiba TV
CABLE/SAT	
DVD	
VCR/PVR	Multi-brand video/audio devices
AUX 1	
AUX 2	

Note: Although your new TV's remote control includes codes for many devices, it may not include codes for some or all of the features on certain devices you wish to control. If you are unable to program the TV's remote control to operate your device or some of the features on that device, use the device's remote control or the controls on the device.

Programming the remote control to operate your other devices

Device code setup

- 1 Find the code for your device brand in the remote control device code table on pages 18–21. If more than one code is listed, try each one separately until you find one that works.
- 2 Press the applicable mode select button (**CABLE/SAT**, **DVD**, **VCR/PVR**, **AUX 1**, or **AUX 2**), until the device button LED blinks 3 times.
- 3 While holding down **RECALL**, press the Number buttons to enter the device category code "0–5" shown below plus four-digit code for your device.

Category	Device code
TV (Toshiba)	0
Cable box Satellite receiver Cable/PVR combo DBS/PVR combo (1)	1
DVDs	2
VCRs PVRs DBS/PVR combo (2)	3
Audio Amp Audio Amp/Tuners	4
CD Players	5

- If a valid code is entered, the device button LED will blink twice.
 - If an invalid code is entered, the device button LED will blink one long blink.
- 4 Point the remote control at the device and press **POWER** to test the code.
 - If the device responds to the remote control, you have entered the correct code.
 - If the device does not respond to the remote control, repeat steps 3 and 4 using another code.

Note: After programming the remote control, make sure all necessary keys on the TV remote control (in addition to **POWER**) operate your device. If some keys are not operational, repeat the device code setup using another code (if other codes are listed for your device). If, after trying all listed codes, the necessary keys do not operate your device, use the device's original remote control.

Chapter 2: Using the remote control

5 To control the TV, press the “TV mode select button.”

Note:

- Although the TV remote control includes codes for many devices, it may not include codes for some or all of the features on certain devices you want to control. If you are unable to program the TV remote control to operate your device or some of the features on that device, use the device's original remote control (or the control buttons on the device).
- Every time you change the batteries you will need to reprogram the remote control.
- Some newer VCRs respond to either of two codes. These VCRs have a switch labeled “VCR1/VCR2.” If your VCR has this kind of switch and does not respond to the codes for your VCR brand, set the switch to the other position (“VCR1” or “VCR2”) and reprogram the remote control.

Searching and sampling the code of a device (8500)

If you do not know the device code for a particular device, you can cycle the remote control through the available codes for that device mode and sample the functions to find the code that operates the target device. The keys available to be sampled, provided they are applicable to that mode, are **POWER**, 1, **VOL**, **CH**, and **PLAY**. Invalid keys will be ignored while in program mode.

To cycle through each available device code and sample its functions:

- 1 Press device button to select the mode you want to set up.
- 2 While holding down **RECALL**, press 8, 5, 0, 0. The remote control will enter program mode.
- 3 Point the remote control at the target device and press **POWER** (or other function buttons that are available to be sampled).
- 4 If the device responds to the remote control:
 - Press **RECALL** to store the device code. The device button LED will blink two times and the remote control will exit the program mode.

If the device does not respond to the remote control:

Press **▲**, and then press **POWER**. Repeat this step until the device responds to the remote control, and then press **RECALL**.

Note: When a search cycle is completed, the device button LED will blink three times. The remote control will begin to cycle through the available codes again. If no key is pressed within 10 seconds during programming, the remote control will exit the program mode and return to the previous code.

Using the volume lock feature (8000)

By default (factory setting), the remote control's volume keys (**VOL** and **MUTE**) are locked to the “TV” device mode.

The remote control will operate the TV's volume, even when “TV” is not the current device mode. (This includes all remote control device modes except AUX 1 and AUX 2).

If you unlock the remote control's volume keys, each device mode will have its own volume (if the device ID has volume data). The remote control will operate the volume of the device associated with the current device mode. (This includes all remote control device modes.)

If you lock the remote control's volume keys to a specific device mode, the remote control will operate the volume of the device associated with the locked mode, even when the locked mode is not the current device mode. (This includes all device modes except AUX 1 and AUX 2).

When the remote control is in AUX1 (or AUX 2) mode, the remote control will operate the volume of the device associated with the AUX 1 (or AUX 2) mode, even when the volume is locked to another mode.

See “Using the remote control to operate your other devices” on page 16.

To lock the remote control's volume keys to a specific mode (CABLE/SAT in this example):

- 1 Press CABLE/SAT.
- 2 While holding down the **RECALL** button, press 8, 0, 0, 0.
- 3 Press **VOL**. The CABLE/SAT button LED will blink two times (locked).
 - The remote control's volume keys will now operate the volume of the device associated with the CABLE/SAT mode, even when CABLE/SAT is not the current device mode (for all device modes except AUX 1 and AUX 2).

To unlock the remote control's volume keys:

- 1 While holding down **RECALL**, press 8, 0, 0, 0.
- 2 Press **VOL**. The CABLE/SAT button LED will blink four times (unlocked).

Operational feature reset (8900)

This feature clears all programmed remote control features not related to “Device code setup” and resets the volume lock to the “TV” device mode.

To reset the remote control:

While holding down **RECALL**, press 8, 9, 0, 0. The Device button LED will respond with four blinks.

Chapter 2: Using the remote control

Multi-brand remote control device codes

TVs

Brand	Code
Toshiba	1524

Cable boxes

Brand	Code
ABC	0003, 0008
Americast	0899
Bell South	0899
Clearmaster	0883
ClearMax	0883
Coolmax	0883
Digeo	1187
Director	0476
GoldStar	0144
Hamlin	0009, 0273
Memorex	0000
Motorola/ General Instrument/ Jerrold	0276, 0476, 0810
Motorola General Instrument/ Jerrold	1187, 1376
0003	0003
Multitech	0883
Pace	0008, 0237, 1877
Panasonic	0000, 0107
Paragon	0000
Philips	0317, 1305
Pioneer	0144, 0533, 0877, 1877
Pulsar	0000
Quasar	0000
RadioShack	0883
Regal	0273, 0279
Runco	0000
Samsung	0144
Scientific Atlanta	0008, 0477, 0877, 1877
Sony	1006
Starcom	0003
Supercable	0276
Supermax	0883
Torx	0003
Toshiba	0000
Tristar	0883
V2	0883
Viewmaster	0883
Vision	0883
Vortex View	0883
Zenith	0000, 0525, 0899

Satellite receivers

Brand	Code
AlphaStar	0772
Chaparral	0216
Crossdigital	1109

DirecTV	0099, 0247, 0392, 0566, 0639, 0724, 0749, 0819, 1076, 1108, 1109, 1142, 1377, 1392, 1414, 1442, 1443, 1444, 1609, 1639, 1640, 1749, 1856
Dish Network System	0775, 1005, 1170, 1505, 1775
Dishpro	0775, 1005, 1505, 1775
Echostar	0775, 1005, 1170, 1505, 1775
Expressvu	0775, 1775
GE	0392, 0566
GOI	0775, 1775
Goodmans	1246
Hisense	1535
Hitachi	0819, 1250
HTS	0775, 1775
Hughes	0749, 1442, 1749
Hughes Network Systems	0749, 1142, 1442, 1443, 1444, 1749
iLo	1535
Janeil	0152
JVC	0775, 1170, 1775
LG	1226, 1414
Magnavox	0722, 0724
Memorex	0724
Mitsubishi	0749
Motorola/ General Instrument/ Jerrold	0869
Motorola	0856
NEC	0102, 0178, 1270
Next Level	0869
Panasonic	0152, 0247, 0701
Paysat	0724
Philips	0099, 0722, 0724, 0749, 0819, 1076, 1142, 1442, 1749
Pioneer	1442
Proscan	0392, 0566
Proton	1535
RadioShack	0869
RCA	0143, 0392, 0566, 0855, 1392
Samsung	1108, 1109, 1142, 1276, 1377, 1442, 1609
Sanyo	1219
Sony	0639, 1639, 1640
Star Choice	0869
Tivo	1142, 1442, 1443, 1444
Toshiba	0082, 0749, 0790, 0819, 1285, 1286, 1287, 1289, 1749, 1857, 1858
UltimateTV	1392, 1640
Uniden	0722, 0724
US Digital	1535
USDTV	1535
Voom	0869

Zenith	1856
--------	------

DVDs

Brand	Code
Aiwa	0641
Akai	0695, 0770, 1089
Alco	0790
Allegro	0869
Amphion Media Works	0872
AMW	0872
Apex Digital	0672, 0717, 0755, 0794, 0796, 0797, 1004, 1020, 1056, 1061, 1100
Aspire Digital	1168, 1407
Audiovox	0790, 1041, 1072
Axion	1072
B & K	0655, 0662
Blaupunkt	0717
Blue Parade	0571
Broksonic	0695
California Audio Labs	0490
Cinea	0831
CineVision	0833, 0869, 0876
Citizen	1277
Coby	0778, 0852, 1086, 1107, 1177, 1351
Craig	0831
Curtis Mathes	1087
CyberHome	0816, 0874, 1023, 1024, 1117, 1129
Daewoo	0705, 0784, 0833, 0869, 1169, 1172, 1234, 1242
Daytek	0872
Denon	0490, 0634
Desay	1407
Disney	0675, 1270
Dual	1068, 1085
Durabrand	1127
DVD2000	0521
Emerson	0591, 0675, 0821
Enterprise	0591
Fisher	0670
Funai	0675, 1334
Gateway	1073, 1077, 1158
GE	0522, 0717, 0815
Go Video	0715, 0741, 0744, 0783, 0833, 0869, 1044, 1075, 1099, 1158, 1304, 1730
GoVision	1072
GoldStar	0741
GPX	0699, 0769
Gradiente	0490
Greenhill	0717
Grundig	0539
Harman/Kardon	0582, 0702
Hitachi	0573, 0664
Hiteker	0672
iLo	1348
Initial	0717
Integra	0571, 0627

Chapter 2: Using the remote control

Jaton	1078
JBL	0702
JSI	1423
JVC	0558, 0623, 0867, 1164
jWin	1049, 1051
Kawasaki	0790
Kenwood	0490, 0534
KLH	0717, 0790, 1020, 1149
Konka	0711
Koss	0651, 1423
Landel	0826
Lasonic	0798, 1173
Lecson	1533
Lenoxx	1127
LG	0591, 0741, 0801, 0869
LiteOn	1058, 1158, 1416, 1440
Loewe	0511
Magnavox	0503, 0539, 0646, 0675, 0821
Malata	0782, 1159
Marantz	0539
McIntosh	1533
Memorex	0695, 0831, 1270
Microsoft	0522
Mintek	0717, 0839
Mitsubishi	0521, 1521
Momitsu	1082
NAD	0591, 0692, 0741
NEC	0785
Nesa	0717
Next Base	0826
NexxTech	1402
Norcent	0872, 1003, 1107, 1265
Onkyo	0503, 0627, 0792
Oritron	0651
Panasonic	0490, 0503, 0703, 1362, 1462, 1490, 1762
Philips	0503, 0539, 0646, 0675, 1267, 1354
PianoDisc	1024
Pioneer	0525, 0571, 0631
Polaroid	1020, 1061, 1086
Polk Audio	0539
Portland	0770
Presidian	0675
Proceed	0672
Proscan	0522
ProVision	0778
Qwestar	0651
RCA	0522, 0571, 0717, 0790, 0822
Rio	0869
RJTech	1360
Rotel	0623
Rowa	0823
Sampo	0698, 0752
Samsung	0490, 0573, 0744, 0820, 1044, 1075
Sansui	0695
Sanyo	0670, 0695, 0873
Sensory Science	1158

Sharp	0630, 0675, 0752, 1256
Sharper Image	1117
Sherwood	0633, 0770, 1043, 1077
Shinsonic	0533, 0839
Sonic Blue	0869, 1099
Sony	0533, 0864, 1033, 1431, 1533
Sungale	1074
Superscan	0821
SVA	0860, 1105
Sylvania	0675, 0821
Symphonic	0675
Teac	0790, 0809
Technics	0490, 0703
Technosonic	0730
Techwood	0692
Theta Digita	0571
Toshiba	0503, 0695, 1154, 1854
Tredex	0800, 0803, 0804
Urban Concepts	0503
US Logic	0839
Venturer	0790
Vizio	1064, 1226
Xbox	0522
Yamaha	0490, 0539, 0545
Yamakawa	0872
Zenith	0503, 0591, 0741, 0869
Zoece	1265

VCRs

Brand	Code
ABS	1972
Admiral	0048, 0209, 0479
Adventura	0000
Aiko	0278
Aiwa	0000, 0037, 0124
Akai	0041, 0061, 0175
Alienware	1972
America Action	0278
American High	0035
Asha	0240
Audiovox	0037, 0278
Beaumarck	0240
Bell & Howell	0104
Broksonic	0002, 0121, 0184, 0209, 0479
Calix	0037
Canon	0035
Carver	0081
CCE	0072, 0278
Citizen	0037, 0278
Colt	0072
Craig	0037, 0047, 0072, 0240
Curtis Mathes	0035, 0041, 0060, 0162
Cybernex	0240
CyberPower	1972
Daewoo	0045, 0278
Dell	1972
Denon	0042

DirecTV	0739
Durabrand	0038, 0039
Dynatech	0000
Electrohome	0037, 0043
Electroponic	0037
Emerex	0032
Emerson	0000, 0002, 0037, 0043, 0061, 0121, 0184, 0209, 0212, 0278, 0479, 0593, 1593
Fisher	0047, 0104
Fuji	0033, 0035
Funai	0000, 0593, 1593
Garrard	0000
Gateway	1972
GE	0035, 0060, 0065, 0240, 0807
Go Video	0240, 0432, 0526
GoldStar	0037, 0038
Gradiente	0000
Harley Davidson	0000
Harman/Kardon	0038, 0075, 0081
Harwood	0072
Headquarter	0046
Hewlett Packard	1972
HI-Q	0047
Hitachi	0000, 0041, 0042, 0065, 0089, 0105
Howard Computers	1972
HP	1972
Hughes Network Systems	0042, 0739
Humax	0739
Hush	1972
iBUYPOWER	1972
Jensen	0041
JVC	0008, 0041, 0067
KEC	0037, 0278
Kenwood	0038, 0041, 0067
KLH	0072
Kodak	0035, 0037
Linksys	1972
Lloyd's	0000
Logik	0072
LXI	0037
Magnasonic	0593
Magnavox	0000, 0035, 0039, 0081, 0149, 0563, 0593
Magnin	0240
Marantz	0035, 0081
Marta	0037
Matsushita	0035, 0162
Media Center PC	1972
MEI	0035
Memorex	0000, 0035, 0037, 0039, 0046, 0047, 0048, 0104, 0162, 0209, 0240, 0479
MGA	0043, 0061, 0240
MGN Technology	0240
Microsoft	1972
Mind	1972
Minolta	0042, 0105

(continued)

Chapter 2: Using the remote control

Mitsubishi	0043,0061,0067, 0075,0173,0807
Motorola	0035,0048
MTC	0000,0240
Multitech	0000,0072
NEC	0038,0040,0041, 0067,0104
Nikko	0037
Nikon	0034
Niveus Media	1972
Noblex	0240
Northgate	1972
Olympus	0035,0226
Onkyo	0222
Optimus	0037,0048,0104, 0162,0432,0593, 1062
Orion	0002,0184,0209, 0479
Panasonic	0035,0077,0162, 0225,0226,0616, 1062
Penney	0035,0037,0038, 0040,0042,0240
Pentax	0042,0065,0105
Philco	0035
Philips	0035,0081,0618, 0739,1081,1181
Pilot	0037
Pioneer	0067
Polk Audio	0081
Profitronic	0240
Proscan	0060
Protec	0072
Pulsar	0039
Quarter	0046
Quartz	0046
Quasar	0035,0077,0162
RadioShack	0000
Radix	0037
Randex	0037
RCA	0042,0060,0065, 0077,0105,0149, 0240,0807, 0880
Realistic	0000,0035,0037, 0046,0047,0048, 0104
ReplayTV	0614,0616
Ricavision	1972
Ricoh	0034
Runco	0039
Salora	0075
Samsung	0045,0240,0739
Sanky	0039,0048
Sansui	0000,0041,0067, 0209,0479
Sanyo	0046,0047,0104, 0159,0240
Scott	0043,0045,0121, 0184,0210,0212
Sears	0000,0035,0037, 0042,0046,0047, 0104,0105
Sharp	0048,0807,0848
Shintom	0072
Shogun	0240

Singer	0072
Sonic Blue	0614,0616
Sony	0000,0032,0033, 0034,0035,0636, 1032,1972
Stack 9	1972
STS	0042
Sylvania	0000,0035,0043, 0081,0593,1593
Symphonic	0000,0593,1593
Systemax	1972
Tagar Systems	1972
Tatung	0041
Teac	0000,0041
Technics	0035,0162
Teknika	0000,0035,0037
Thomas	0000
Tivo	0618,0636,0739, 1996
TMK	0240
Toshiba	0043,0045,0209, 0210,0212,0366, 0845,1008, 1145,1972,1996
Totevision	0037,0240
Touch	1972
Unitech	0240
Vector	0045
Vector Research	0038,0040
Video Concepts	0040,0045,0061
Videomagic	0037
Videosonic	0240
Viewsonic	1972
Villain	0000
Voodoo	1972
Wards	0000,0035,0042, 0047,0048,0060, 0072,0081, 0149,0212,0240
White Westinghouse	0072,0209
XR-1000	0000,0035,0072
Yamaha	0038
Zenith	0000,0033,0034, 0039,0209,0479, 1139
ZT Group	1972

PVRs

Brand	Code
ABS	1972
Alienware	1972
CyberPower	1972
Dell	1972
Direc TV	0739
Gateway	1972
Hewlett Packard	1972
Howard Computers	1972
HP	1972
Hughes Network Systems	0739
Humax	0739
Hush	1972
iBUYPOWER	1972
Linksys	1972
Media Center PC	1972

Microsoft	1972
Mind	1972
Niveus Media	1972
Northgate	1972
Panasonic	0616
Philips	0618,0739
RCA	0880
ReplayTV	0614,0616
Sonic Blue	0614,0616
Sony	0636,1972
Stack 9	1972
Systemax	1972
Tagar Systems	1972
Tivo	0618,0636,0739
Toshiba	1008,1972
Touch	1972
Viewsonic	1972
Voodoo	1972
ZT Group	1972

Cable/PVR Combo

Brand	Code
Americast	0899
Digeo	1187
Motorola/ General Instrument/ Jerrold	0476,0810
Motorola	1187,1376
Pace	0237,1877
Pioneer	0877,1877
Scientific Atlanta	0877,1877
Sony	1006
Supercable	0276
Zenith	0899

DBS/PVR Combo (1)

Brand	Code
DirecTV	0099,0392,0639, 1076,1142,1377, 1392,1442, 1443,1444,1640
Dish Network System	0775,1505
Dishpro	0775,1505
Echostar	0775,1170,1505
Expressvu	0775
Hughes Network Systems	1142,1442,1443, 1444
JVC	1170
Motorola	0869
Philips	1142,1442
Proscan	0392
RCA	1392
Samsung	1442
Sony	0639,1640
Star Choice	0869

DBS/PVR Combo (2)

Brand	Code
Hughes Network Systems	0739
Philips	0739
Samsung	0739

Chapter 2: Using the remote control

Audio Amp

Brand	Code
Adcom	0577, 1100
Bose	0674
Carver	0892
Durabrand	1561
Elan	0647
GE	0078
Harman/Kardon	0892
JVC	0331
LeftCoast	0892
Lenoxx	1561
Luxman	0165
Marantz	0321, 0892
McIntosh	0251
Nakamichi	0321
NEC	0264
Optimus	0395, 0823
Parasound	0246
Philips	0892
Pioneer	0823
PolkAudio	0892
RCA	0823
Realistic	0395
Sansui	0321
Shure	0264
Sony	0689, 0815, 1126
Soundesign	0078, 0211
Victor	0331
Wards	0078, 0211
Yamaha	0133, 0143, 0354, 0504

CD players

Brand	Code
Adcom	0234
Aiwa	0124, 0157
Akai	0156
Arcam	0157
Audio-Technica	0170
Burmester	0420
California Audio Labs	0029, 0303
Carver	0157, 0299
Denon	0003, 0034
DKK	0000
DMX Electronics	0157
Garrard	0393, 0420
Genexxa	0032
Harman/Kardon	0083, 0157, 0173
Hitachi	0032, 0139
Integra	0101
JVC	0072, 0655, 1294
Kenwood	0028, 0037, 0190, 0626
Krell	0157
Linn	0157
Magnavox	0038, 0157
Marantz	0029, 0038, 0157, 0180, 0435, 0626
MCS	0029
MGA	0083
Miro	0000
Mission	0157
Mitsubishi	0083

MTC	0420
NAD	0019, 0299
NEC	0234
Nikko	0170
NSM	0157
Onkyo	0101, 0102, 0138, 0381, 1327
Optimus	0000, 0032, 0037, 0087, 0420, 0468
Panasonic	0029, 0303, 0388, 0752
Parasound	0420
Philips	0157, 0274, 0626
Pioneer	0032, 0468, 0551, 1062, 1087
Polk Audio	0157
Proceed	0420
Proton	0157
QED	0157
Quad	0157
Quasar	0029
RCA	0032, 0053, 0420, 0468, 1062
Realistic	0180, 0420
Rotel	0157, 0420
SAE	0157
Sansui	0157
Sanyo	0087
Sharp	0037, 0180
Sherwood	0180
Sonic Frontiers	0157
Sony	0000, 0100, 0185, 0490, 0604, 0605, 0673, 1364
Sugden	0157
TAG McLaren	0157
Tascam	0420
Teac	0180, 0378, 0393, 0420
Technics	0029, 0303
Toshiba	0019, 0299
Victor	0072
Wards	0053, 0157
Yamaha	0036, 0170, 0187, 0490, 1292

Audio Amp/Tuners

Brand	Code
ADC	0531
Aiwa	0121, 0189, 1243, 1388, 1405, 1641
Akai	1255, 1512
Alco	1390
AMC	1077
Anam	1074, 1609
Apex Digital	1774
Arcam	1189
Audiotronic	1189
Audiovox	1390
Bose	0639, 1229, 1253, 1933
Capetronic	0531
Carver	0121, 0189, 1189, 1289
Delphi	1414
Denon	0121, 1142, 1360

Fisher	1801
Harman/Kardon	0110, 0189, 0891, 1289, 1304, 1306
Hitachi	1273, 1801
Integra	0135, 1298, 1320
JBL	0110, 1306
JVC	1058, 1374, 1495, 1811
Kenwood	0186, 1313, 1569, 1570
KLH	1390, 1428
Linn	0189
Magnavox	0189, 0531, 1189, 1269, 1514
Marantz	0189, 1189, 1269, 1289
McIntosh	1289
Micromega	1189
Mitsubishi	1393
Myryad	1189
Nakamichi	1313
Onkyo	0135, 0380, 0842, 1298, 1320, 1531
Optimus	0186, 0531, 1023, 1074
Panasonic	0309, 1288, 1308, 1316, 1350, 1363, 1518, 1548, 1633, 1763, 1764
Philips	0189, 1189, 1266, 1269
Pioneer	0014, 0150, 0531, 0630, 1023, 1384
Polk Audio	0189, 1289, 1414
Proscan	1254
RCA	0531, 1023, 1074, 1254, 1390, 1511, 1609
Samsung	1295, 1304, 1500
Sansui	0189, 1189
Sanyo	1469, 1801
Sharp	0186
Sherwood	1077
Sirius	1811
Sony	0168, 1058, 1258, 1406, 1441, 1558, 1622, 1658, 1758, 1759, 1858
Stereophonics	1023
Sunfire	1313
Teac	1074, 1267, 1390, 1528
Technics	0309, 1308, 1518, 1633
Thorens	1189
Toshiba	0135
Venturer	1390
Wards	0014, 0189
XM	1406, 1414
Yamaha	0176, 0186, 1176, 1276, 1331, 1375

Chapter 3: Menu layout and navigation

Main menu layout





The tables below and on the next page provide a quick overview of your TV's menu system. To open the main menus (illustrated below), press **MENU** on the remote control or TV control panel.

Icon	Item	Option
	Picture Viewer	→ [Launches the JPEG Picture Viewer]
	Audio Player	→ [Launches the MP3 Audio Player]
	Channel Browser	→ [Launches the Channel Browser™]
	TV Guide On Screen™	→ [Opens the TV Guide On Screen™ option]
	Digital CC/Audio Selector	→ [Launches the ATSC Digital CC Selector] (This option is not available if you are not on a digital channel).
	CableCARD™	→ Dynamic list of items provided by Cable company. (This option is not available if a CableCARD™ is not inserted.)
	Picture Settings	→ [Opens the Picture Settings menu]
	Advanced Picture Settings	→ [Opens the Advanced Picture Settings menu]
	Theater Settings	→ [Opens the Theater Settings menu]
	Audio Settings	→ [Opens the Audio Settings menu]
	Advanced Audio Settings	→ [Opens the advanced Audio Settings menu]
	Audio Setup	→ [Opens the Audio Setup menu]
	Closed Caption Mode	→ OFF/CC1/CC2/CC3/CC4/T1/T2/T3/T4
	Closed Caption Advanced	→ [Opens the Closed Caption Advanced menu]
	Input Labeling	→ [Opens the Input Labeling menu]
	Menu Language	→ English/French/Spanish
	Channel Browser Setup	→ [Opens the Channel Browser Setup menu]
	Enable Rating Blocking	→ Off/On
	Edit Rating Limits	→ [Opens the Edit Rating Limits menu]
	Channels Block	→ [Opens the Channels block menu]
	Input Lock	→ Off/Video/Video+
	Front Panel Lock	→ Off/On
	GameTimer™	→ Off/30 Min/60 Min/90 Min/120 Min
	New PIN Code	→ [Opens the New PIN Code entry screen]
	Installation	→ [Opens the Installation menu (see page 23)]
	Sleep Timer	→ [Opens the Sleep Timer menu]
	On/Off Timer	→ [Opens the On/Off Timer menu]
	PC Settings	→ [Opens the PC Setting menu]
	ColorStream HD1 Audio	→ No/Yes
	HDMI 1 Audio	→ Auto / Digital / Analog
	ColorStream HD2 Audio	→ No/Yes
	HDMI 2 Audio	→ Auto / Digital / Analog
	Slide Show Interval	→ 2 Sec/5 Sec/10 Sec/15 Sec/20 Sec
	Quick Restart	→ Off/On

Chapter 3: Menu layout and navigation

Setup/Installation menu layout

The Installation menu contains the Terrestrial, Network, TV Guide On Screen™ Setup, Time and Date, and System Status menus. To open the **Installation** menu (illustrated below), press **MENU** on the remote control or TV control panel, open the **Setup** menu, select **Installation**, and press **ENTER**.

Icon	Item	Option
Press MENU , open the Setup menu, and then open the Installation sub-menu.	Terrestrial 	Input Configuration → [Opens the Input Configuration menu]
		Channel Program → ANT1 → [Scans for new channels on ANT1] → ANT2 → [Scans for new channels on ANT2]
		Channel Add/Delete → [Opens the Channel Add/Delete menu]
		Signal Meter → [Opens the Signal Meter menu]
		Network 
	Basic Network Setup → [Opens the Basic Network Setup menu]	
	E-mail Scheduling Setup → [Opens the E-mail Scheduling Setup menu]	
	Home File Server Setup → [Opens the Home File Server Setup menu]	
	Software Upgrade → [Opens the Software Upgrade menu]	
TV Guide On Screen™ Setup 	Start → [Opens the TV Guide On Screen™ Setup menu]	
Time and Date 	Start Setup → [Opens the Time and Date Setup menu]	
System Status 	System Information → [Opens the System Information screen]	

Chapter 3: Menu layout and navigation

THINC menu layout

The **THINC** menu will not be part of the main menu, but will be viewable by pressing **THINC** on the remote control. It will contain a list of special features offered by the TV; **Picture Viewer**, **Audio Player**, **Channel Browser**, **Favorites Browser**, and **TV Guide On Screen**.

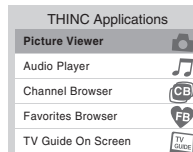

Navigating the menu system

You can use the buttons on the remote control or TV control panel to access and navigate your TV's on-screen menu system.

- Press **MENU** to open the menu system.
- When a menu is open, use the up/down/left/right arrow buttons (**▲▼◀▶**) on the remote control or TV control panel to move in the corresponding direction in the menu.
- Press **ENTER** to save your menu settings or select a highlighted item. (A highlighted menu item appears in a different color in the menu.)
- All menus close automatically if you do not make a selection within 60 seconds, except the signal meter menu, which closes automatically after about 5 minutes.
- To close a menu instantly, press **EXIT**.

Note: The menu backgrounds may sometimes appear black, depending on the signal the TV is receiving. This is not a sign of malfunction.

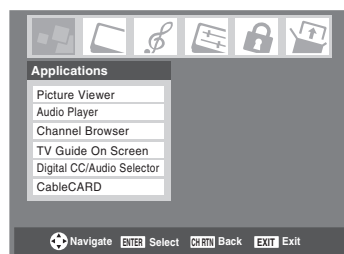

Chapter 4: Setting up your TV

Selecting the menu language

You can choose from three different languages (English, French, and Spanish) for the on-screen display of menus and messages.

Note: The TV Guide On Screen™ menus are in English, regardless of the language selected in this menu.

To select the menu language:

- 1 Press **MENU** and open the **Preferences** menu.
- 2 Highlight **Menu Language** and press **▶**.
- 3 Press **▲** or **▼** to select your preferred menu language and press **ENTER**.

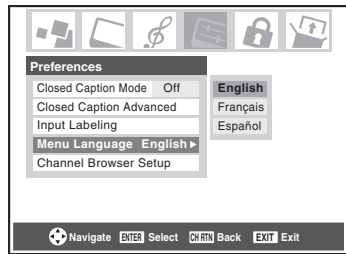

- 4 Press **EXIT** to close the **Preferences** menu.

Configuring the antenna input sources for the ANT 1 and ANT 2 terminals

To configure the ANT 1 and ANT 2 input sources:

- 1 Press **MENU** and open the **Setup** menu.
- 2 Highlight **Installation** and press **ENTER**.

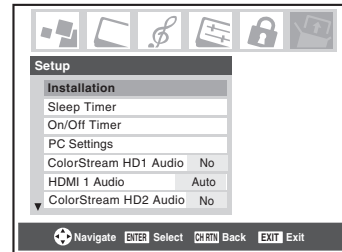

- 3 (A new set of **Installation** menu icons will appear on-screen, as shown below.) Open the **Terrestrial** menu, highlight **Input Configuration**, and press **ENTER**.

Note: The Terrestrial menu may not be accessible (items will be "grayed out") in some instances (for example, if a cable box is connected to the ANT 1 input or if one of the VIDEO modes is the current input during TV Guide On Screen™ setup).

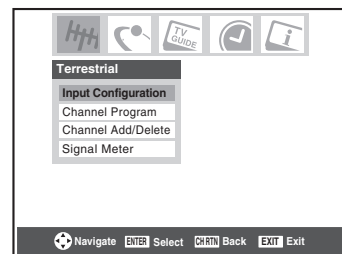

- 4 Press **▲** or **▼** to highlight **Antenna 1 In**, and press **◀** or **▶** to select the input source (**Cable** or **Antenna**) for the **ANT 1** input on the TV.

Note: If a cable box is connected to the ANT 1 input during TV Guide On Screen™ setup, the entire Terrestrial menu will not be accessible, including the input source for ANT 1, which will automatically display "Cable Box."

- 5 Press **▼** to highlight **Antenna 2 In** and then **◀** or **▶** to select the input source (**Cable** or **Antenna**) for the **ANT 2** input on the TV, if applicable. If you have not connected anything to the **ANT 2** input, skip this step.

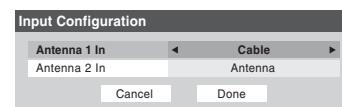

- 6 To save your new settings, highlight **Done** and press **ENTER**. To revert to your original settings, highlight **Cancel** and press **ENTER**.

Chapter 4: Setting up your TV

Programming channels into the TV's channel memory

When you press **CH** or **CH** on the remote control or TV control panel, your TV will stop only on the channels you programmed into the TV's channel memory.

Follow the steps below to program channels into the TV's channel memory.

Programming channels automatically

Your TV can automatically detect all active channels in your area and store them in its memory. After the channels are programmed automatically, you can manually add or erase individual channels in the channel memory.

Note:

- You must configure the antenna input source before programming channels (see page 25).
- If the Antenna 1 input signal type is set to **Cable**, the automatic channel programming process erases channels that were previously programmed into the TV's memory.
- If the Antenna 1 input signal type is set to **Antenna**, the automatic channel programming process adds newly found channels to the existing set of programmed channels. (and does NOT erase channels that were previously programmed into the TV's memory.) To remove an antenna source channel from the memory, you must manually delete it.
- To tune the TV to a channel not programmed in the channel memory, you must use the Channel Number buttons on the remote control.
- Programming channels when the antenna input is configured for **Cable** will take substantially longer than when the antenna input is configured for **Antenna**. This is normal; however, once channel programming is finished, you should not have to repeat the programming process again unless your Cable TV service lineup changes significantly.
- If you have a CableCARD™ inserted, channel programming for **ANT 1** is disabled because the CableCARD™ automatically loads the Cable channel list into the TV's channel memory. See the Installation Guide for details on CableCARD™.

To program channels automatically:

- 1 Configure the antenna input sources, if you have not already done so. (see page 25).
- 2 Press **MENU** and open the **Setup** menu.

- 3 Highlight **Installation** and press **ENTER**.

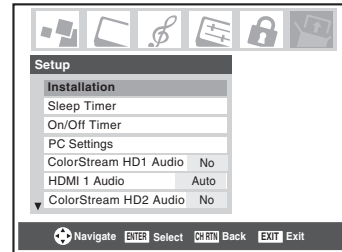

- 4 (A new set of **Installation** menu icons will appear on-screen, as shown below.) Open the **Terrestrial** menu, highlight **Channel Program**, and press **ENTER**.

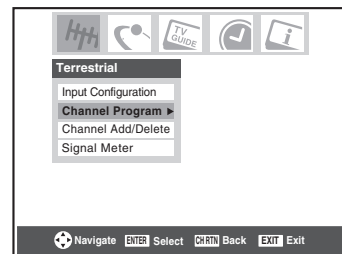

- 5 Highlight **ANT 1** or **ANT 2**, depending on which antenna input you want to program channels for, and then press **ENTER** to start automatic channel programming.



The TV will automatically cycle through all the antenna channels, and store all active channels in the channel memory. While the TV is cycling through the channels, the message "Scanning channels, please wait" appears (as shown above).

- 6 To cancel channel programming, either press **EXIT** or highlight **Abort** in the on-screen display and press **ENTER**. When channel programming is finished, press **CH** or **CH** to view the programmed channels.

Chapter 4: Setting up your TV

Manually adding and deleting channels in the channel memory

After automatically programming channels into the channel memory, you can manually add or delete individual channels.

To add or delete channels in the channel memory:

- 1 Press **MENU** and open the **Setup** menu.
- 2 Highlight **Installation** and press **ENTER**.
- 3 (A new set of **Installation** menu icons will appear on-screen, as shown below.) Open the **Terrestrial** menu, highlight **Channel Add/Delete**, and then press **ENTER**.

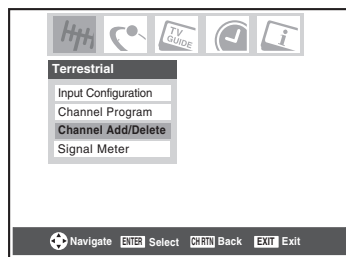

- 4 The illustration below left shows channels programmed for the ANT 1 antenna input. To view the list of channels programmed for the ANT 2 or Cable box antenna input, press **▲▼** to highlight **ANT 2** and press **ENTER**.

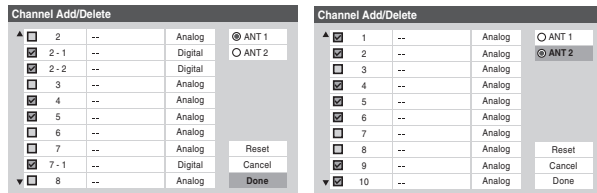

To add a channel to the channel memory:

Highlight the unchecked box next to the channel number you want to add, and then press **ENTER** to check the box.

To manually add digital subchannels on a physical channel:

Use the Channel Numbers and the Dash (**100**) on the remote control to enter the channel number (for example, 56-1).
 If the channel is found, the number will be added to the list and the box will be checked.
 If the channel is not found, a message will appear.

To remove a channel from the channel memory:

Highlight the checked box next to the channel number you want to remove, and then press **ENTER** to uncheck the box.

To save your new settings:

Highlight **Done** and press **ENTER**.

To revert to your original settings:

Highlight **Cancel** and press **ENTER** before saving.

To remove all channels from the channel memory:

Highlight **Reset** and press **ENTER**, and then highlight **Done** and press **ENTER**.

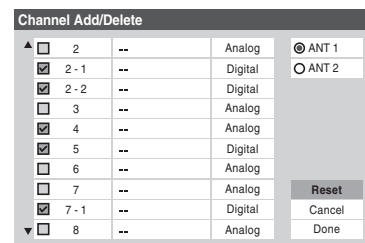

Note: This action applies to the current antenna input only. To delete/add channels on the other input, highlight the input you want (**ANT1**, or **ANT 2**) and press **ENTER**.

Chapter 4: Setting up your TV

Setting the time and date

Note: If you already set up the TV Guide On Screen™ system, the time and date were set automatically and you can skip this step.

To set the time and date:

- 1 Press **MENU** and open the **Setup** menu.
- 2 Highlight **Installation** and press **ENTER**.
- 3 (A new set of **Installation** menu icons will appear on-screen, as shown below.) Open the **Time And Date** menu, highlight **Start Setup**, and press **ENTER**.

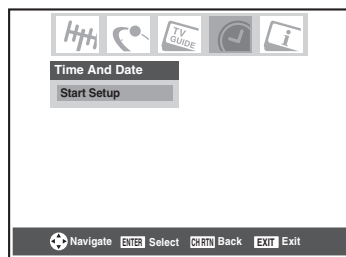

If you have not set up the TV Guide On Screen™ system, the following screen will appear. To set the time, highlight **TV Guide On Screen™** and press **ENTER**. The TV Guide On Screen™ setup sequence will start, and the time and date will be set automatically.

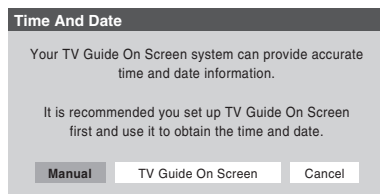

If you have already set up the TV Guide On Screen™ system, or if you have not set up the time, the Time and Date setting screen will appear and you will need to manually set the time and date.

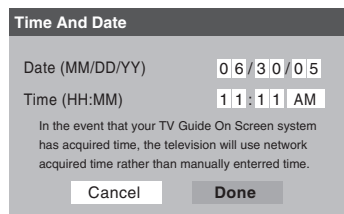

Note:

- If you highlight **TV Guide On Screen™** (above) to set the time and date through the TV Guide On Screen™ system and a power outage occurs, the time and date will be updated automatically when the power is restored.
- If you highlight **Manual** (above) to set the time and date manually and a power outage occurs, you will lose the time and date settings when the power is restored.
- If you manually set the time and date and then perform TV Guide On Screen™ setup, the manual time and date settings will be overridden by the TV Guide On Screen™ settings.

Setting the ColorStream® HD audio mode

To set the ColorStream HD audio mode:

- 1 Press **MENU** and open the **Setup** menu.
- 2 Highlight **ColorStream HD1 Audio** (or **ColorStream HD 2 Audio**) and press **▶**.
- 3 Press **▲** or **▼** to select **Yes** or **No** and press **ENTER** to display the information.

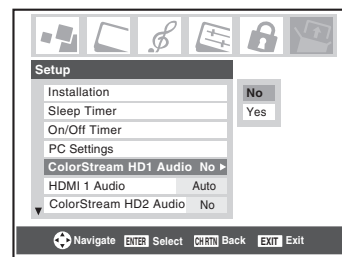

Note: The analog audio terminals for the ColorStream HD and HDMI inputs are used in common. When the ColorStream HD 1 (or 2) audio mode is set to **Yes**, the HDMI 1 (or 2) audio mode is set to **Digital** and will be greyed out. When the ColorStream HD 1 (or 2) audio mode is set to **No**, the HDMI 1 (or 2) Audio changes to **Auto**.

Chapter 4: Setting up your TV

Setting the HDMI™ audio mode

To set the HDMI audio mode:

- 1 Press **MENU** and open the **Setup** menu.
- 2 Highlight **HDMI 1 Audio** (or **HDMI 2 Audio**) and press **▶**.
- 3 Press **▼** or **▲** to select the HDMI audio mode (**Auto**, **Digital**, or **Analog**) and press **ENTER**. (**Auto** is the recommended mode.) See “Connecting an HDMI or DVI device to the HDMI input” (see *Installation Guide*).

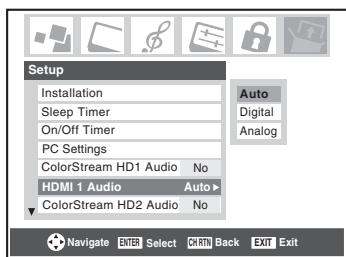

Note: The ColorStream HD1/HD2 Audio settings influence the HDMI Audio settings. If ColorStream HD1 (or 2) Audio is set to **No**, the HDMI 1 (or 2) Audio setting changes to **Auto**. If either ColorStream HD1 (or 2) Audio is set to **Yes**, the HDMI 1 (or 2) Audio setting is set to **Digital** and will be greyed out.

Viewing the CableCARD™ menu

A CableCARD™ enables you to view encrypted digital channels. See “Connecting a digital CableCARD™” (see *Installation Guide*) for connection and subscription information.

Note: Connecting your TV directly to the Audio/Video output of your set-top-box may provide a more vivid picture.

After the CableCARD™ is inserted, a CableCARD™ option appears in the **Applications** menu, with informational screens provided by your digital CableCARD™ service (see illustrations below).

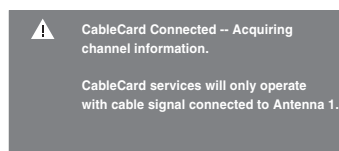

To view the CableCARD™ menu:

- 1 Press **MENU** and open the **Applications** menu.
- 2 Highlight **CableCARD™** and press **▶**.
- 3 Press **▲** or **▼** to select one of the side menu items and then press **ENTER** to display the information.

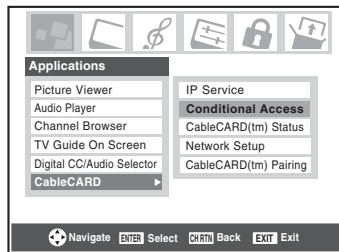

Note: The CableCARD™ menu is for informational purposes only and has no user-adjustable options.

Chapter 4: Setting up your TV

Setting the Quick Restart™ feature

With the Quick Restart™ feature set to **On**, the TV will stay in Standby mode for several minutes after the TV is turned off (see Note below).

If the TV is turned on from Standby mode, the full picture appears immediately.

To set the Quick Restart™ feature:

- 1 Press **MENU** and open the **Setup** menu.
- 2 Highlight **Quick Restart** and press **▶**.
- 3 Press **▼** or **▲** to select either **On** or **Off** and Press **ENTER**.

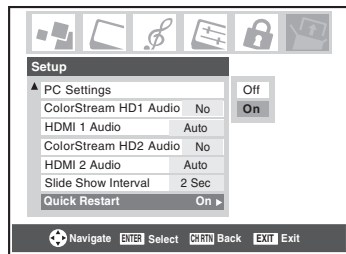

Note: If **Quick Restart** is set to **Off** and you turn off the TV, it can take several seconds for the picture to appear when you turn on the TV again. See "Important Notice about Hot Lamp Restart," below.

If **Quick Restart** is set to **On** and you turn off the TV, the following will occur for a few minutes:

- The screen (lamp) lights dimly; and
- The fans continue to run.

This is a function of the Quick Restart Shutdown mode and is not a TV malfunction. If you do not prefer this, set the **Quick Restart** feature to **Off**.

When the **Quick Restart** feature is set to **Off**, if you repeatedly turn the TV on and off in a short period of time, the useful service life of the lamp may be shorter than the average useful service life (see page 81).

IMPORTANT NOTICE ABOUT "HOT LAMP RESTART"

When the TV has been powered on long enough for the lamp unit to get hot, it may take several minutes for the picture to appear on-screen in the following situations:

- When the Quick Restart™ feature is set to Off and you turn the TV off and then on again within a few minutes; or
- If the TV is on when a short-term power failure, power surge, or other similar power failure occurs, such that the TV loses and regains power within a few minutes.

This is a property of DLP™ TV lamp technology and is NOT a sign of malfunction.

If this occurs, the yellow LED on the TV front panel will blink (and the blue LED will be lit solid) until the TV is finished restarting the lamp and the normal picture appears. If both LEDs are blinking, you will need to turn the TV off and then on again to restart the lamp.

Viewing the digital signal meter

You can view the digital signal meter for the ANT 1 and ANT 2 digital TV input sources only.

To view the digital signal meter:

- 1 Press **MENU** and open the **Setup** menu.
- 2 Highlight **Installation** and press **ENTER**.
- 3 A new set of Installation menu icons will appear on-screen, as shown below.
Open the **Terrestrial** menu, highlight **Signal Meter**, and press **ENTER**.

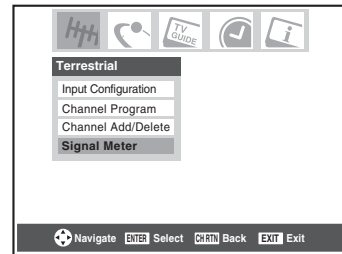

- 4 Press **▲▼◀▶** to select the antenna input and digital channel whose signal you want to check.

Note: The physical digital channel number listed in the Signal Meter screen may not correspond to a virtual TV channel number. Contact your local broadcasters to obtain the RF channel numbers for your local digital stations.

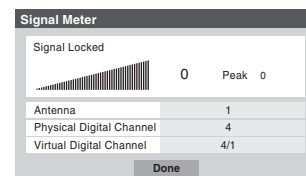

To close the screen and return to the Terrestrial menu:

Highlight **Done** and press **ENTER**.

To return to normal viewing:

Press **EXIT**.

Chapter 4: Setting up your TV

Viewing the system status

To view the system status:

- 1 Press **MENU** and open the **Setup** menu.
- 2 Highlight **Installation** and press **ENTER**. A new set of Installation menu icons will appear on-screen, as shown below right.
- 3 Open the **System Status** menu, highlight **System Information**, and press **ENTER**.

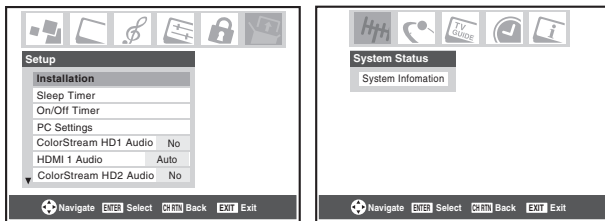

- 4 Press **◀▶** to scroll through the menu bar to select either **Product Information** or **Software Version** and view the related information.

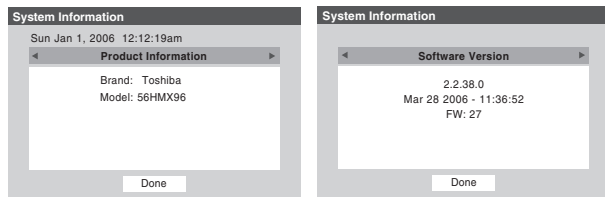

To close the screen and return to the Installation menu:

Highlight **Done** and press **ENTER**.

To return to normal viewing:

Press **EXIT**.

Reset Factory Defaults

To reset all settings and channels to their factory default values:

- 1 Press **MENU** and open the **Setup** menu.
- 2 Highlight **Installation** and press **ENTER**. A new set of Installation menu icons will appear on-screen, as shown below right.
- 3 Open the **System Status** menu, highlight **System Information**, and press **ENTER**.
- 4 Press **◀▶** to scroll through the menu bar to select **Factory Defaults**.
- 5 Enter your PIN code (or 0000 if no PIN code has been set).
- 6 Highlight **Yes** and press **ENTER**. The TV will turn off automatically after a few seconds. After the TV turns off, unplug the TV power cord and then plug it in again to complete the reset process.

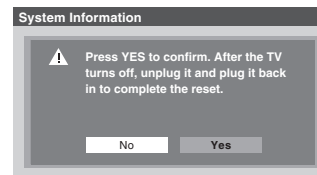

To cancel the reset:

Highlight **No** and press **ENTER**.

Note: If you previously set the TV to **High Bright** mode and restored **Factory Defaults**, the TV will default to **Low Power** mode. To set the TV back to **High Bright** mode, see page 55.

Chapter 5: Using the TV's features

Selecting the video input source to view

To select the video input source to view:

- 1 Press **INPUT** on the remote control or **INPUT** on the TV control panel.
- 2 To select the input: Press 0–8 to select the input source you want to view:
 - a) You can select the video input which will depend on the input terminals you used to connect your devices (see *Installation Guide*).

The current signal source displays in the top right corner of the **Input Selection** screen.

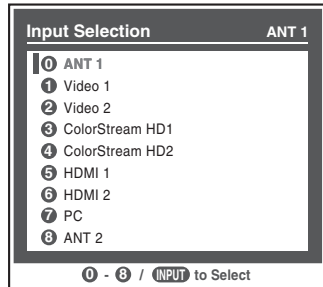

- b) Repeatedly press **▲▼** on the remote control (or **CHANNEL ▲▼** on the control panel) to change the input; or
- c) Repeatedly press **INPUT** on the remote control or the **INPUT** on the TV control panel to change the input.

Note:

- You can label the video input sources according to the specific devices you have connected to the TV (see “Labeling the video input sources” at right).
- The source can be “hidden” (see “Labeling the video input sources” at right).

Labeling the video input sources

You can label each video input source according to the type of device you connected to each source, from the following preset list of labels:

- “--” (default label)
- Cable
- DTV
- Satellite/DSS
- VCR
- Laser Disk
- DVD
- HD DVD
- Audio Receiver
- Compact Disc
- Video Recorder
- Game Console
- Hide (to hide an unused input in the **Input Selection** screen)

Note: If you select **ANT 2** in the **Input selection** screen, you can choose only “--” or “Hide” as the label.

To label the video input sources:

- 1 Press **MENU** and open the **Preferences** menu.
- 2 Highlight **Input Labeling** and press **ENTER**.
- 3 Press **▲** or **▼** to highlight the video source you want to label.

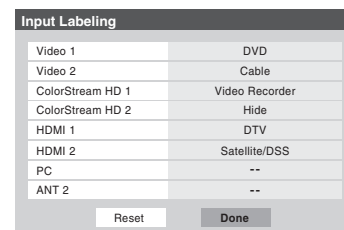
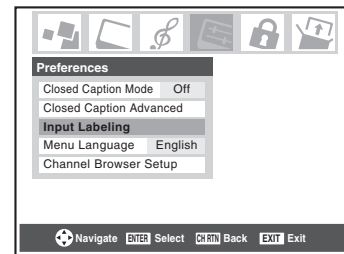

- 4 Press **◀** or **▶** to select the desired label for that input source. If a particular input is not used, you can select **Hide** as the label, which will cause that input to be “grayed out” in the **Input Selection** Screen and skipped over when you press **INPUT** on the remote control.
- 5 To save the new input labels, highlight **Done** and press **ENTER**. To revert to the factory default labels, highlight **Reset** and press **ENTER**.

Chapter 5: Using the TV's features

Input labeling example:

The screen below left shows the default **Input Selection** screen (with none of the inputs labeled as a specific device). The screen below right is an example of how you could label the inputs if you connected a DVD player to VIDEO 1, Cable TV to VIDEO 2, a video recorder to ColorStream HD1, a DTV set-top box to HDMI 1, and a satellite/DSS set-top box to HDMI 2. Also note that the ColorStream HD2 input is labeled "Hidden," which means that input will be skipped over when **INPUT** is pressed.

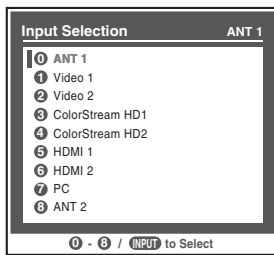

Input Selection screen with no inputs labeled.

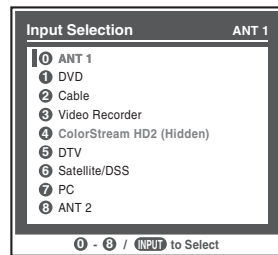

Input Selection screen with all inputs labeled except input 4, which has been hidden.

To clear the input labels:

- 1 Press **MENU** and open the **Preferences** menu.
- 2 Highlight **Input Labeling** and press **ENTER**.
- 3 Highlight **Reset** and press **ENTER**.

Tuning channels

Tuning channels using the Channel Browser™

The Channel Browser™ provides an easy navigation interface for all your channels and inputs. This feature allows you to:

- Navigate the contents of all of your inputs.
- Keep a Favorites list of all the favorite channels (see Favorite Browser below).
- Provide Cable Box and Satellite Box lists.
- Keep a history of the last 32 channels or inputs viewed.
- Quickly surf and tune your recently viewed channels/inputs from the Channel Browser™ banner History list (illustrated on the next page).
- Surf via Browse mode (to immediately tune channels as you highlight them in the Channel Browser™ banner) or Select mode (to surf over channels in the Browser banner before you select one to tune).
- Quickly change inputs from the Inputs List.

Favorite Browser

The Favorite Browser allows you to quickly set up a favorite channels/inputs list that is integrated into the Channel Browser™.

To add a favorite channel/input:

- 1 Tune to the channel or input.
- 2 Press and hold **CHANNEL BROWSER** for 3 seconds.

Note: Additions are added to the beginning of the Favorite list on the left side of the banner.

To delete a favorite channel/input:

- 1 Open Favorite browser list by pressing **CHANNEL BROWSER**.
- 2 Select the channel or input to delete by pressing **◀** or **▶** and press **ENTER**.
- 3 Press and hold **100** for 3 seconds. The channel/input will be removed from the Favorite list.

(continued)

Chapter 5: Using the TV's features

To set up the Channel Browser™:

- 1 Press **MENU** and open the **Preferences** menu.
- 2 Highlight **Channel Browser Setup** and press **ENTER**.
- 3 Press **▲** to highlight **Navigation**, and then press **◀** or **▶** to select either **Browse Mode** or **Select Mode**.

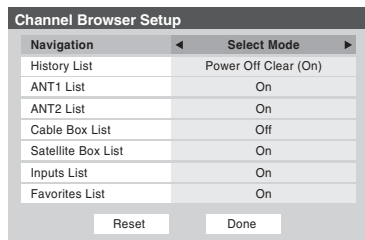

- 4 Press **▼** to highlight **History List**, and then press **◀** or **▶** to select the setting you prefer: either **Power Off Clear (On)**, **On**, or **Off**.

Note: When *History List* is set to **On**, the channels and inputs stored in the list will be saved every power on/off cycle. When *History List* is set to **Power Off Clear (On)**, the channels and inputs stored in the list will be cleared with every power on/off cycle of the TV.

- 5 Press **▼** to highlight **ANT1 List**, and then press **◀** or **▶** to select **On** or **Off**.
- 6 Press **▼** to highlight **ANT2 List**, and then press **◀** or **▶** to select **On** or **Off**.
- 7 Press **▼** to highlight **Cable Box List**, and then press **◀** or **▶** to select **On** or **Off**.
- 8 Press **▼** to highlight **Satellite Box List**, and then press **◀** or **▶** to select **On** or **Off**.
- 9 Press **▼** to highlight **Inputs List**, and then press **◀** or **▶** to select **On** or **Off**.
- 10 Press **▼** to highlight **Favorites List**, then press **◀** or **▶** to select **On** or **Off**.
- 11 To save your entries, highlight **Done** and press **ENTER**.
To return to factory defaults, highlight **Reset** and press **ENTER**.

Note: *Cable Box List* and *Satellite Box List* will be grayed out and set to **Off** by default. They will remain this way until a *Cable Box* and/or *Satellite Box* is configured from the *TV Guide* setup.

To open the Channel Browser™ banner:

- Press **BACK** **CH** **◀**, **NEXT** **CH** **▶**, or **CH BROWSER** on the remote control.
- Press **BACK** **CH** **◀** to surf backward through the currently selected list.
- Press **NEXT** **CH** **▶** to surf forward through the currently selected list.

Elements of the Channel Browser™ banner

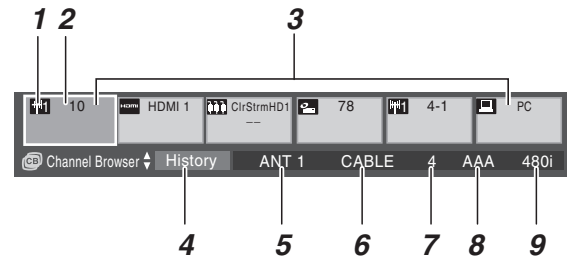

- 1 Input type
- 2 Highlighted item (channel or input)
- 3 Channels stored in the channel history
- 4 Current list (**History**, **ANT 1**, **ANT 2**, **Cable Box**, **Satellite Box**, **Inputs**, or **Favorites**)
- 5 Current input
- 6 Current antenna type (cable or TV)
- 7 Active channel number
- 8 Channel call letters (if available)
- 9 Resolution

To toggle among the available lists:

After opening the Channel Browser™ banner, press **▲** or **▼** to toggle among **History**, **ANT 1**, **ANT 2**, **Cable Box**, **Satellite Box**, **Inputs** and **Favorites**.

Note:

- The Channel Browser™ banner opens in **History List** by default. Once another list has been selected, the Channel Browser™ will open in the last selected list.
- If all lists are turned to off, pressing **◀** and **▶** will not display the Channel Browser™, and pressing **CH BROWSER** will tune to the last selected favorite channel or input, but the Channel Browser™ will not display. If no favorite channel/input is previously selected, pressing **CH BROWSER** will have no affect.
- Pressing **CH BROWSER** will bring up the Channel Browser™ on the Favorite list regardless of the last selected list in the Channel Browser™.

To tune to a channel or input in Browse mode:

- 1 While watching TV, press **BACK** **CH** **◀** or **NEXT** **CH** **▶** to open the Channel Browser™ banner and surf back to a previous item or surf forward to the next item in the list.
In **Browse** mode, when you stop on an item in the Browser banner, it will be highlighted and the TV will automatically tune to the channel or input.
- 2 Press **EXIT** to close the Channel Browser™ banner.

Note: The Channel Browser™ banner will close automatically if you do not make a selection within 30 seconds.

Chapter 5: Using the TV's features

To tune to a channel or input in Select mode:

- 1 While watching TV, press **BACK** or **NEXT** to open the Channel Browser™ banner and surf back to a previous item or surf forward to the next item in the list.
In **Select** mode, when you stop on an item in the browser banner, it will be highlighted but you must press **ENTER** to tune the TV to the highlighted item.
- 2 Press **EXIT** to close the Channel Browser™ banner.

Adding and clearing channels and inputs in the channel history



Adding channels and inputs to the channel history:

As a channel or input is tuned, the Channel Browser™ adds it to the History and displays it on the “right side” of the Browser banner. Previously tuned channels/inputs are “shifted” to the left, eventually moving off the left side of the Browser banner. Press **BACK** to surf backward through the previously tuned channels/inputs. Any channel or input that is tuned repeatedly will not be repeated in the History, but instead is moved to the end of the list on the right side of the Browser banner.

The Channel Browser™ will store the following channels:

- All channels that are tuned for at least 5 seconds using the numeric buttons on the remote control.
- All channels that are tuned using **CH** or **CH** on the remote control for at last 5 second.
- All inputs that are tuned for at least 5 seconds.

Note: Whenever an item is selected that cannot be tuned (for various reasons), the TV will automatically tune to the previously viewed channel or input.

Clearing channels from the channel history

- Reconfiguring the **ANT 1** or **ANT 2** input will clear the channel history.
Note: See page 25 for details on configuring the antenna inputs.
- Removing the CableCARD™ will clear the channel history.
- Once 32 channels or inputs are stored in the history list, the oldest item will be removed from the list when a new channel or input is tuned.
- If **History List** in the **Channel Browser Setup** is set to “**Power Off Clear (On)**”, turning off the TV will clear the channel History.

Tuning to the next programmed channel

To tune to the next programmed channel:

Press **CH** or **CH** on the remote control or TV control panel.

Note: This feature will not work unless you program channels into the TV's channel memory (see page 26).

Tuning to a specific channel (programmed or unprogrammed)

Tuning analog channels:

Press the Channel Number buttons (0–9) on the remote control. For example, to select channel 125, press 1, 2, 5.

Tuning digital channels:

Press the Channel Number (0–9) on the remote control, followed by the dash (**100**) and then the sub-channel number. For example, to select digital channel 125-1, press 1, 2, 5, -, 1.

Note: If a digital channel is not programmed—either through the automatic channel scan (see page 26) or the channel add/delete function (see page 27)—you will have to tune the RF channel using the Channel Numbers and dash (**100**) on the remote control.

Chapter 5: Using the TV's features

Switching between two channels using Channel Return

The Channel Return feature allows you to switch between two channels without entering an actual channel number each time.

- 1 Select the first channel you want to view.
- 2 Select a second channel using the Channel Number buttons (and the dash (000) button if selecting a digital channel).
- 3 Press **CH RTN** on the remote control. The previous channel will display. Each time you press **CH RTN**, the TV will switch back and forth between the last two channels that were tuned.

Note: If you press **CH RTN** from a non-antenna input, the TV will return to the last-viewed ANT input and channel.

Switching between two channels using SurfLock™

The SurfLock™ feature temporarily “memorizes” one channel in the **CH RTN** button, so you can return to that channel quickly from any other channel by pressing **CH RTN**.

To memorize a channel in the **CH RTN** button:

- 1 Tune the TV to the channel you want to program into the **CH RTN** button.
- 2 Press and hold **CH RTN** for about 2 seconds until the message “Channel Memorized” appears on-screen. The channel has been programmed into the **CH RTN** button.
- 3 You can then change channels repeatedly, and when you press **CH RTN**, the memorized channel will be tuned.

The TV will return to the memorized channel one time only. Once you press **CH RTN** and then change channels again, the CH RTN memory will be cleared and the button will function as Channel Return, by switching back and forth between the last two channels that are tuned.

Chapter 5: Using the TV's features

Selecting the picture size

You can view many program formats in a variety of picture sizes—**Natural**, **TheaterWide 1**, **TheaterWide 2**, **TheaterWide 3**, and **Full**.

Note: The “picture size” illustrations are examples only. The format of the image (in any of the picture sizes) will vary depending on the format of the signal you are currently watching. Select the picture size that displays the current program the way that looks best to you.

Your picture size preferences can be saved for each input on your TV.

To select the picture size:

- 1** Press **PIC SIZE** on the remote control.
- 2** While the **Picture Size** screen is open, press the corresponding number button (0–4) to select the desired picture size.

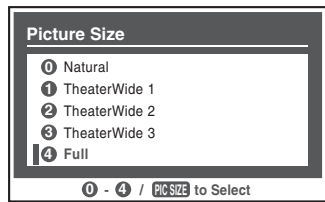

Note:

- You also can repeatedly press **PIC SIZE** to select the desired picture size (or press **▲▼** on the remote control while the **Picture Size** screen is open).
- **Full** may not be available for some program formats (it will be “grayed out” in the **Picture Size** screen).
- You also can select the picture size using the menu system. Select **Picture Size** in the **Theater Settings** menu. Select the input for which you want to save your picture settings. To save your settings, highlight **Done** and press **ENTER**.

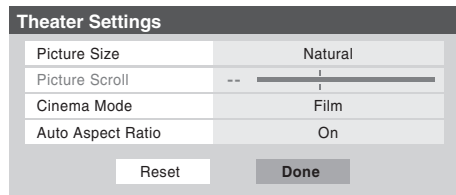

Using these functions to change the picture size (i.e., changing the height/ width ratio) for any purpose other than your private viewing may be prohibited under the Copyright Laws of the United States and other countries, and may subject you to civil and criminal liability.

Natural picture size

- The image is displayed close to its originally formatted proportion. Some program formats will display with sidebars and/or bars at the top and bottom.

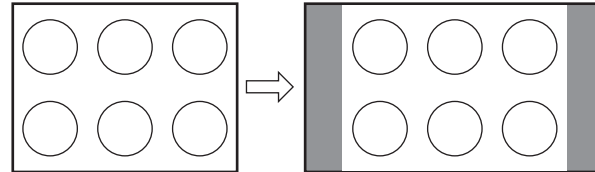

Natural picture size example

TheaterWide 1 picture size (for 4:3 format programs)

- The center of the picture remains close to its original proportion, but the left and right edges are stretched wider to fill the screen.

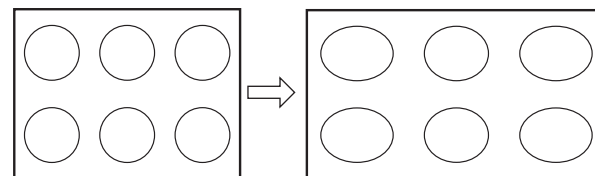

TheaterWide 1 picture size example

TheaterWide 2 picture size (for letter box programs)

- The picture is stretched wider to fill the width of the screen, but only slightly stretched taller.
- The top and bottom edges of the picture are hidden. To view the hidden areas, see “Scrolling the TheaterWide® picture” on the next page.

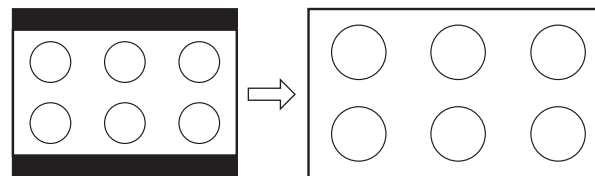

TheaterWide 2 picture size example

(continued)

Chapter 5: Using the TV's features

TheaterWide 3 picture size (for letter box programs with subtitles)

- The picture is stretched wider to fill the width of the screen, but only slightly stretched taller.
- The top and bottom edges are hidden. To view the hidden areas (such as subtitles or captions), see “Scrolling the TheaterWide® picture” at right.

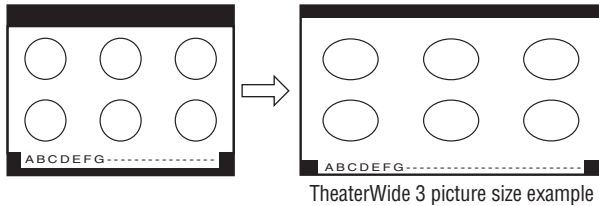

Full picture size (for 16:9 [480i, 480p] source programs only)

- If receiving a squeezed 4:3 format program, the picture is stretched wider to fill the width of the screen, but not stretched taller.
- None of the picture is hidden.

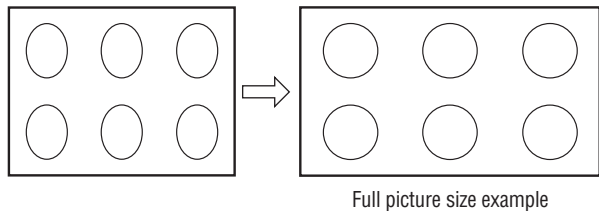

Note:

- If you select one of the TheaterWide® picture sizes, the top and bottom edges of the picture (including subtitles or captions) may be hidden. To view the hidden edges, either scroll the picture (**TheaterWide 2 and 3** only) or try viewing the program in **Full** or **Natural** picture size.
- The “picture size” illustrations are examples only. The format of the image (in any of the pictures sizes) will vary depending on the format of the signal you are currently watching.

Scrolling the TheaterWide® picture (TheaterWide 2 and 3 only)

You can set separate scroll settings for the TheaterWide 2 and TheaterWide 3 modes for each input.

To set the scroll settings:

- 1 Press **MENU** and open the **Video** menu.
- 2 Highlight **Theater Settings** and press **ENTER**.

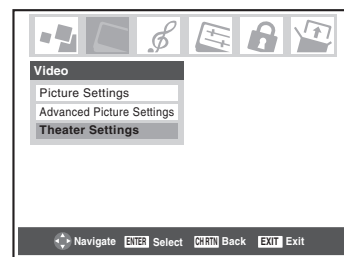

- 3 In the **Picture Size** field, select either **TheaterWide 2** or **TheaterWide 3** (you cannot scroll in any other mode).
- 4 Press **▼** to highlight the **Picture Scroll** field.
- 5 Press **◀** or **▶** to scroll the picture up and down as needed, from -10 to +20.

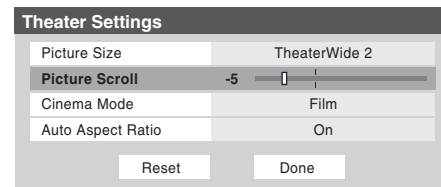

- 6 To save the new settings, highlight **Done** and press **ENTER**. To revert to the factory defaults, highlight **Reset** and press **ENTER**.

Chapter 5: Using the TV's features

Using the auto aspect ratio feature

When the auto aspect ratio feature is set to **On**, the TV will automatically select the picture size when one of the following input sources is received:

- A 480i signal from the **VIDEO 1**, **VIDEO 2**, **ColorStream HD-1**, or **ColorStream HD-2** input.
- A 1080i, 480i, 480p, or 720p signal from the **HDMI** input.

Aspect ratio of signal source	Automatic aspect size (automatically selected when Auto Aspect is On)
4:3 normal	Natural (with sidebars)
4:3 letter box	TheaterWide 2
16:9 full	Full
Not defined (no ID-1 data or HDMI aspect data)	The current picture size you set under "Selecting the picture size" on page 37.

Note: The auto aspect ratio feature is not applicable to antenna or cable input sources.

To turn on the auto aspect ratio feature:

- 1 Press **MENU** and open the **Video** menu.
- 2 Highlight **Theater Settings** and press **ENTER**.
- 3 In the **Auto Aspect Ratio** field, select **On**.

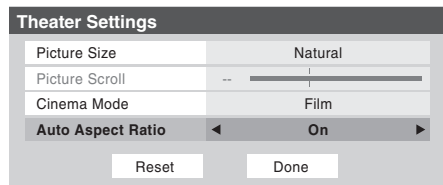

- 4 To save the new settings, highlight **Done** and press **ENTER**. To revert to the factory defaults, highlight **Reset** and press **ENTER**.

To turn off the auto aspect ratio feature:

Select **Off** in step 3 above.

Selecting the cinema mode (480i signals only)

When you view a DVD (480i signal; 3:2 pulldown processed) from a DVD player connected to the **VIDEO 1**, **VIDEO 2**, **ColorStream HD-1/ColorStream HD-2** (component video), or **HDMI** inputs on the TV, smoother motion can be obtained by setting the **Cinema Mode** to **Film**.

To set the Cinema Mode to Film:

- 1 Press **MENU** and open the **Video** menu.
- 2 Highlight **Theater Settings** and press **ENTER**.
- 3 In the **Cinema Mode** field, select **Film**.

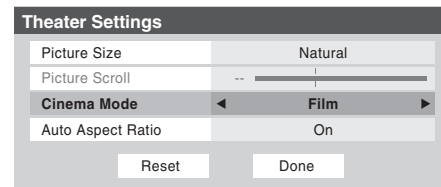

- 4 To save the new settings, highlight **Done** and press **ENTER**. To revert to the factory defaults, highlight **Reset** and press **ENTER**.

To set the Cinema Mode to Video:

Select **Video** in step 3 above.

Chapter 5: Using the TV's features

Using the POP features

Using the POP double-window feature

The POP (picture-out-picture) double-window feature splits the screen into two windows so you can watch two programs at the same time.

To display a program in the POP window:

- 1 Press **[POP]** to open the POP double-window.

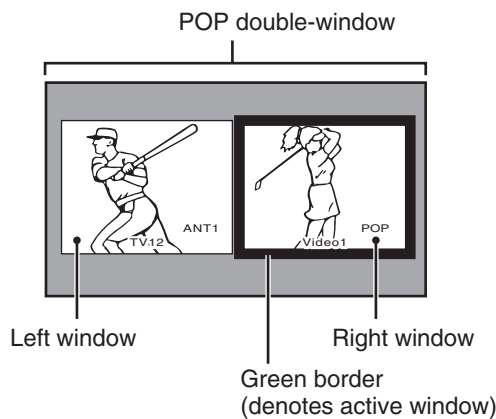

- 2 Press **◀** or **▶** to highlight the desired window. When highlighted, the window will have a green border.
- 3 Press **[INPUT]** to open the **Input Selection** window. Select the input source for the POP window by pressing the corresponding Number button (0–8). The current source displays in red.

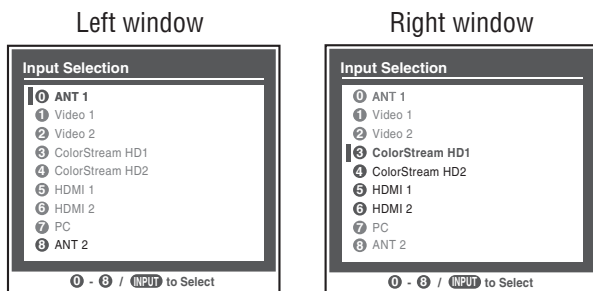

Left window — **ANT 1** and **ANT 2** inputs are selectable.
 Right window — **ColorStream HD1/HD2** (only for 480p, 1080i and 720p) and **HDMI 1/2** are selectable.

Note:

- The error message "Not Available from Current Video Mode" will appear if you press **[POP]** in the **ColorStream HD1/HD2** mode and 480i format.
- The **FREEZE** feature is not available when the POP double-window is open. If you press **[FREEZE]** when the POP double-window is open, the message "Not Available" will appear.

- If you labeled all of the inputs as **HIDE** (see page 32), the POP feature will be disabled and the message "Not Available" will appear on-screen if you try to open the POP double-window.
- When the Input Lock feature is in **Video** or **Video+** mode, If you try to open the POP double-window, the message "Not Available" will appear.

To tune to the highlighted window (and close the POP double-window):

Press **[ENTER]** after highlighting the window you want to view as a normal picture.

To close the POP double-window:

Press **[ENTER]** or **[EXIT]**.

At this time, the active window will remain as a normal picture on the screen.

Notes about recording:

- If the POP window is open and you attempt to start recording, the POP window will close before recording starts.
- If you use the TV's remote control to start recording, you will not be able to open the POP window and the message "Not Available" will appear on-screen if you try to do so.
- It is recommended that you use the TV's remote control to start recording. If you use a device other than the TV's remote control to start recording, you may accidentally open the POP window during the recording process. If this happens, the recorded audio will reflect the audio of the active window (left or right), which may not be the audio you intended to record.

Chapter 5: Using the TV's features

Switching the speaker audio (left or right)

While the POP window is open, press ◀ or ▶ to switch the audio (left or right) that is output from the TV speakers (and also from the **VARIABLE AUDIO OUT** terminals).

The window with the active sound is outlined with a green border.

Example: Press ◀

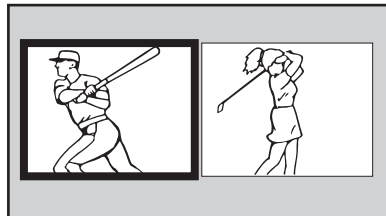

Example: Press ▶

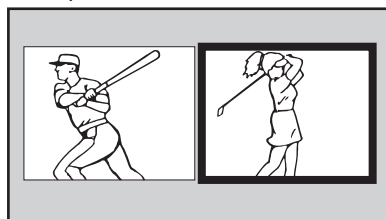

POP double-window aspect ratio

The POP double-window feature displays each picture according to its input signal aspect ratio, as illustrated in the examples below.

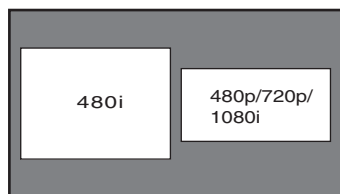
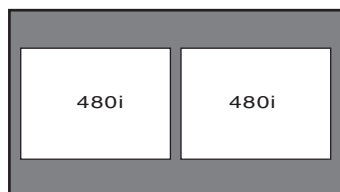

Note:

- The auto aspect ratio feature (page 39) does not operate in POP double-window mode.
- Aspect ratio is the ratio of width to height of the picture.

Using the FREEZE feature

To use the FREEZE feature:

- 1 When viewing the TV, press **FREEZE** to make the picture a still picture.
- 2 To return to the moving picture, either press **FREEZE** again, press **EXIT**, or press any other button.

Note:

- The FREEZE feature is not available when the POP double-window is open. If you press **FREEZE**, the message "Not Available" will appear.
- If the TV is left in FREEZE mode for more than 15 minutes, the FREEZE mode will automatically be released and the TV will return to the moving picture.

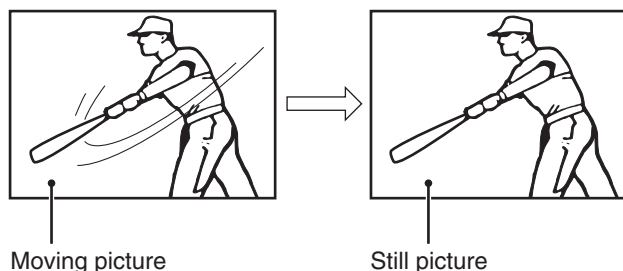

Using the FREEZE function for any purpose other than your private viewing may be prohibited under the Copyright Laws of the United States and other countries, and may subject you to civil and criminal liability.

Chapter 5: Using the TV's features

Adjusting the picture

Selecting the picture mode

You can select your desired picture settings from four different modes, as described below.

Mode	Picture Quality
Sports	Bright and dynamic picture (factory setting)
Standard	Standard picture settings (factory setting)
Movie	Lower contrast for darkened room (factory setting)
Preference	Your personal preferences

To select the picture mode:

- 1 Press **MENU** and open the **Video** menu.
- 2 Highlight **Picture Settings** and press **ENTER**.
- 3 In the **Mode** field, select the picture mode you prefer.

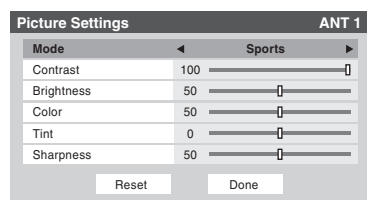

- 4 To save the new settings, highlight **Done** and press **ENTER**. To revert to the factory defaults, highlight **Reset** and press **ENTER**.

Note:

- The picture mode you select affects the current input only (ANT 1 in the example above). You can select a different picture mode for each input.
- If you select one of the factory-set picture modes (**Sports**, **Standard**, or **Movie**) and then change a picture quality setting (for example, increase the contrast or change the color temperature), the picture mode automatically changes to **Preference** in the **Picture Settings** menu.
- If you have previously set the TV to **High Bright** mode, and have chosen **Reset** in item 4 above, the TV will default to **Low Power** mode. To set the TV back to **High Bright** mode, see page 55.

Adjusting the picture quality

You can adjust the picture quality (contrast, brightness, color, tint, and sharpness) to your personal preferences.

Selection	Pressing ◀	Pressing ▶
contrast	lower	higher
brightness	darker	lighter
color	paler	deeper
tint	reddish	greenish
sharpness	softer	sharper

To adjust the picture quality:

- 1 Press **MENU** and open the **Video** menu.
- 2 Highlight **Picture Settings** and press **ENTER**.
- 3 Press **▲** or **▼** to select the picture quality you want to adjust (**Contrast**, **Brightness**, **Color**, **Tint**, or **Sharpness**), and then press **◀** and **▶** to adjust the setting, as described in the table above.

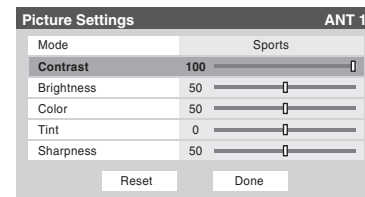

- 4 To save the new settings, highlight **Done** and press **ENTER**. To revert to the factory defaults, highlight **Reset** and press **ENTER**.

The picture qualities you adjusted are automatically saved in the **Preference** mode (see “Selecting the picture mode,” above left).

Chapter 5: Using the TV's features

Using the closed caption mode

The closed caption mode has two options:

- **Captions**—An on-screen display of the dialogue, narration, and sound effects of TV programs and videos that are closed captioned (usually marked “CC” in program guides).
- **Text**—An on-screen display of information not related to the current program, such as weather or stock data (when provided by individual stations).

To view captions or text:

- 1 Press **MENU** and open the **Preferences** menu.
- 2 Highlight **Closed Caption Mode** and press **▶**.
- 3 Press **▲** or **▼** to select the desired closed caption mode and press **ENTER**.

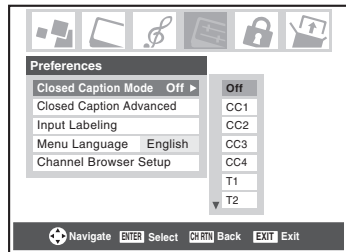

- **To view captions:**
Highlight **CC1**, **CC2**, **CC3**, or **CC4**. (**CC1** displays translation of the primary language in your area.)



Note: If the program or video you selected is not closed captioned, no captions will display on-screen.

- **To view text:**
Highlight **T1**, **T2**, **T3**, or **T4**.

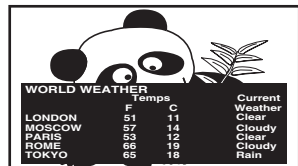

Note: If text is not available in your area, a black rectangle may appear on screen. If this happens, set the Closed Caption Mode to Off.

- **To turn off the Closed Caption mode:**
Select **Off** in step 3 above.

Note: A closed caption signal may not display in the following situations:

- When a videotape has been dubbed
- When the signal reception is weak
- When the signal reception is non-standard

Closed Caption Advanced

You can customize the closed caption display characteristics by changing the background color, text size, type, edge and color.

Note:

- This feature is available for digital channels only.
- You cannot set the Caption Text and Background as the same color.

To customize the closed captions:

- 1 Press **MENU** and open the **Preferences** menu.
- 2 Highlight **Closed Caption Advanced** and press **ENTER**.

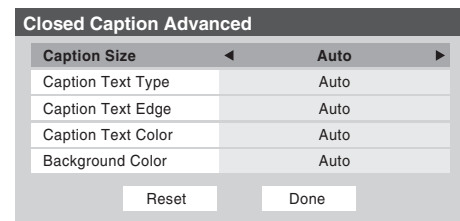

- 3 Press **▲** or **▼** to highlight the characteristic you want to change, and then press **◀** or **▶** to select the format for that characteristic (see table below).
- 4 To save the new settings, highlight **Done** and press **ENTER**. To revert to the factory defaults, highlight **Reset** and press **ENTER**.

Caption Size	Auto, Small, Standard, Large
Caption Text Type	Auto, Default, Mono w. Serif, Prop. w. Serif, Mono w/o Serif, Prop. w/o Serif, Casual, Cursive, Small Capitals
Caption Text Edge	Auto, None, Raised, Depressed, Uniform, Left Drop Shadow, Right Drop shadow
Caption Text Color	Auto, Black, White, Red, Green, Blue, Yellow, Magenta, Cyan
Background Color	Auto, Black, White, Red, Green, Blue, Yellow, Magenta, Cyan

Chapter 5: Using the TV's features

Digital closed captions

You can use the **Digital CC/Audio Selector** to select digital closed caption services (if available), which will temporarily override closed captions for digital channels only.

When such services are not available, the **Digital CC/Audio Selector** presents a default list of services. If the selected service is not available, the next best service will be used instead.

To select digital closed captions:

- 1 Press **MENU** and open the **Applications** menu.
- 2 Highlight **Digital CC/Audio Selector** and press **ENTER**.

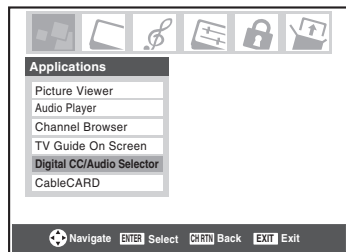

- 3 Press **▲** or **▼** to select **Closed Caption**, and then press **◀** or **▶** to select the desired service.

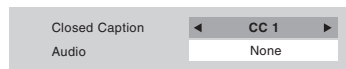

- 4 Press **EXIT**.

Using the Closed Caption button on the remote control

Pressing **CCAPTION** (Closed Caption) when an analog channel is tuned:

- The CC selector will be active and will display CC1-4 and T1-4 as the options.
- The audio selector will be disabled.

Pressing **CCAPTION** (Closed Caption) when a digital channel is tuned:

- The CC selector will be active and will display the possible caption options (available languages) for that channel or services. For example, a program might have “English,” “Spanish,” and “French” as the caption languages available.
- The audio selector will be active and will give the choices for the audio for the digital channel. This might be Dolby or AC3 or whatever the stream includes.

Adjusting the audio

Muting the sound

Press **MUTE** to partially reduce (1/2 MUTE) or turn off (MUTE) the sound. Each time you press **MUTE**, the mute mode will change in the following order:



If the closed caption mode is set to **Off** when you select “MUTE” mode, the closed caption feature is automatically activated. To mute the audio without automatically activating the closed caption feature, use **VOL** to set the volume to 0. See “Using the closed caption mode” (page 43) for more information on closed caption modes.

Using the digital audio selector

You can use the Digital Audio Selector to conveniently switch between audio tracks on a digital channel (for those channels that have multiple audio tracks). This temporarily overrides the audio track chosen by the language option under **Audio Setup** (“Selecting stereo/SAP broadcasts” on page 45).

To use the digital audio selector:

- 1 Press **MENU** and open the **Applications** menu.
- 2 Highlight **Digital CC/Audio Selector** and press **ENTER**.

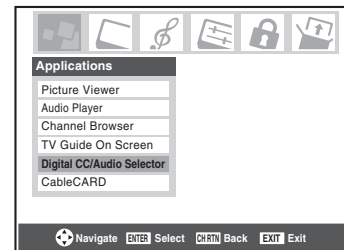

- 3 Press **▲** or **▼** to select **Audio**, and then press **◀** or **▶** to select the desired service.

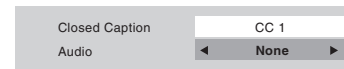

- 4 Press **EXIT**.

Chapter 5: Using the TV's features

Selecting stereo/SAP broadcasts

The multi-channel TV sound (MTS) feature allows you to output high-fidelity stereo sound. MTS also can transmit a second audio program (SAP) containing a second language, music, or other audio information (when provided by individual stations).

When the TV receives a stereo or SAP broadcast, the word "STEREO" or "SAP" appears on-screen when **RECALL** is pressed. The MTS feature is not available when the TV is in VIDEO mode.

To listen to stereo sound:

- 1 Press **MENU** and open the **Audio** menu.
- 2 Highlight **Audio Setup** and press **ENTER**.

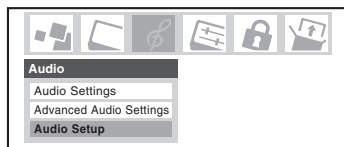

- 3 In the **MTS** field, select **Stereo**.

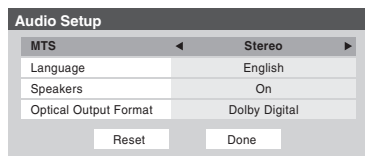

- 4 To save the new settings, highlight **Done** and press **ENTER**. To reset the settings to the factory defaults, highlight **Reset** and press **ENTER**.

Note:

- You can typically leave the TV in **Stereo** mode, because it will automatically output the type of sound being broadcast (stereo or monaural).
- If the stereo sound is noisy, select **Mono** to reduce the noise.

To listen to a second audio program on an analog station (if available):

Select **SAP** in step 3 above.

Note:

- A second audio program (SAP) can be heard only on those TV stations that offer it. For example, a station might broadcast another language as a second audio program. If you have SAP on, you will see the current program on the screen but hear the other language instead of the program's normal audio.
- If you have SAP on and the station you are watching is not broadcasting a second audio program, the station's normal audio will be output. However, occasionally there is no sound at all in **SAP** mode. If this happens, set the **MTS** feature to **Stereo** mode.

To listen to an alternate language on an ATSC digital station (if available):

Highlight the **Language** field in step 3 above, and then press **◀** or **▶** to select the language you prefer.

Adjusting the audio quality

You can adjust the audio quality by adjusting the bass, treble, and balance.

To adjust the audio quality:

- 1 Press **MENU** and open the **Audio** menu.
- 2 Highlight **Audio Settings** and press **ENTER**.
- 3 Press **▼** or **▲** to highlight the item you want to adjust (**Bass**, **Treble**, or **Balance**).

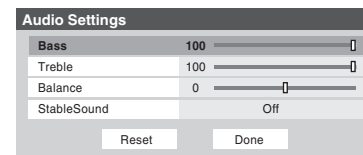

- 4 Press **◀** or **▶** to adjust the level.
 - **◀** makes the bass or treble weaker or increases the balance in the left channel (depending on the item selected).
 - **▶** makes the bass or treble stronger or increases the balance in the right channel (depending on the item selected).
- 5 To save the new settings, highlight **Done** and press **ENTER**. To reset the settings to the factory defaults, highlight **Reset** and press **ENTER**.

Chapter 5: Using the TV's features

Using the StableSound® feature

The StableSound® feature limits the highest volume level to prevent extreme changes in volume when the signal source changes (for example, to prevent the sudden increase in volume that often happens when a TV program switches to a commercial).

To turn on the StableSound® feature:

- 1 Press **MENU** and open the **Audio** menu.
- 2 Highlight **Audio Settings** and press **ENTER**.
- 3 In the **StableSound** field, select **On**.

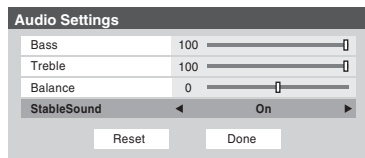

- 4 To save the new settings, highlight **Done** and press **ENTER**. To revert to the factory defaults, highlight **Reset** and press **ENTER**.

Note: The **RESET** function returns your audio adjustments to the following factory settings:

- Bass center (50)
- Treble. center (50)
- Balance center (0)
- StableSound. . . Off

To turn off the StableSound feature:

Select **Off** in step 3 above.

Turning off the built-in speakers

You can use this feature to turn off the TV speakers when you connect an audio system to your TV (see “Connecting a digital audio system” and “Connecting an analog audio system” in the *Installation Guide*).

To turn off the built-in speakers:

- 1 Press **MENU** and open the **Audio** menu.
- 2 Highlight **Audio Setup** and press **ENTER**.
- 3 In the **Speakers** field, select **Off**.

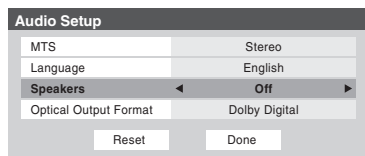

- 4 To save the new settings, highlight **Done** and press **ENTER**. To revert to the factory defaults, highlight **Reset** and press **ENTER**.

To turn on the built-in speakers:

Select **On** in step 3 above.

Selecting the optical audio output format

You can use this feature to select the optical audio output format when you connect a Dolby Digital decoder or other digital audio system to the **Optical Audio Out** terminal on the TV (see “Connecting a digital audio system” in the *Installation Guide*).

To select the optical audio output format:

- 1 Press **MENU** and open the **Audio** menu.
- 2 Highlight **Audio Setup** and press **ENTER**.
- 3 In the **Optical Output Format** field, select either **Dolby Digital** or **PCM**, depending on your device.

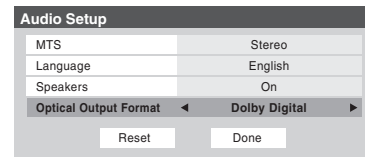

- 4 To save the new settings, highlight **Done** and press **ENTER**. To revert to the factory defaults, highlight **Reset** and press **ENTER**.

Chapter 5: Using the TV's features

Using the Locks menu

The Locks menu includes the Enable Rating Blocking, Edit Rating Limits, Channels Block, Input Lock, Front (control) Panel Lock, and New PIN Code features. You can use these features after entering the correct PIN code.

Entering the PIN code

- 1 Press **MENU** and highlight the **Locks** menu icon.

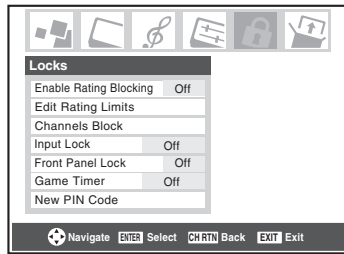

- 2 Press **▼**, which displays the PIN code entry screen.
 - The **Lock System** screen (below) appears if a PIN code has not been stored. Press the Channel Number buttons to enter a new four-digit code, enter the code a second time to confirm, and press **ENTER**.

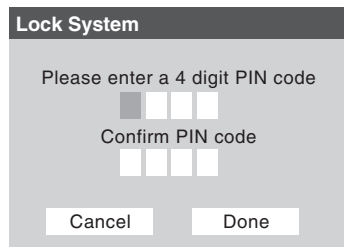

- The **Locks/Active** screen (below) appears if the PIN code is already stored. Use the Number buttons to enter your four-digit code and press **ENTER**.

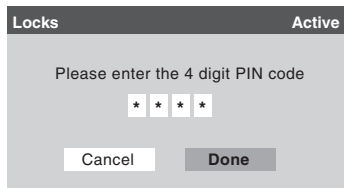

If the wrong PIN code is entered, the message "Incorrect PIN code, please try again!" appears. Highlight **Retry** and press **ENTER**. Enter the code again and press **ENTER**.

When the correct PIN code is entered, the **Locks** menu opens.

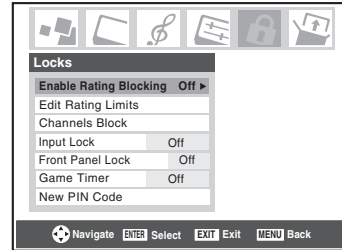

If you cannot remember your PIN code

While the PIN code entering screen is displayed, press **RECALL** four times within five seconds. The PIN code will be cleared and you can enter a new PIN code.

Changing your PIN code

- 1 Press **MENU** and highlight the **Locks** menu icon.
- 2 Press **▼** to display the PIN code entering screen.
- 3 Enter your four-digit PIN code and press **ENTER**.
- 4 Press **▼** to highlight **New PIN Code** and press **ENTER**.

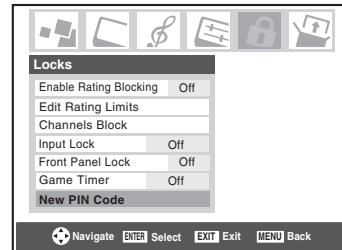

- 5 Press the Number buttons to enter a new four-digit code. Reenter the PIN code to confirm it.
- 6 Press **ENTER**. The new PIN code is now active.

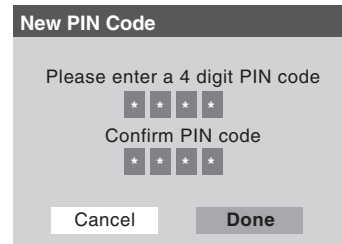

Chapter 5: Using the TV's features

Blocking TV programs and movies by rating (V-Chip)

Some TV programs and movies include signals that classify the content of the program (violence, sex, dialog, language). The V-Chip feature in this TV detects the signals and blocks the programs according to the ratings you select. (For rating descriptions, see the tables on the next page.)

Note: Rating blocking is a function of the V-Chip feature in this TV, which supports the U.S. V-Chip system only.

To block and unblock TV programs and movies:

- 1 Press **MENU** and highlight the **Locks** menu icon.
- 2 Press **▼** to display the PIN code entering screen.
- 3 Enter your four-digit PIN code and press **ENTER**.
- 4 Press **▼** to highlight **Enable Rating Blocking**.
- 5 Press **▶** and **▼** to select **On**, and press **ENTER**.

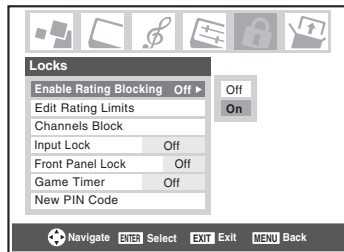

- 6 Press **▼** to highlight **Edit Rating Limits** and press **ENTER**. The **Edit Rating Limits** screen (below) appears.
- 7 Press **▲▼◀▶** and then press **ENTER** to select the level of blocking you prefer. A box with an "X" is a rating that will be blocked. As you highlight a rating, a definition for the rating appears at the bottom of the screen.
- 8 When you are finished selecting the ratings you want to block, highlight **Done** and press **ENTER**.

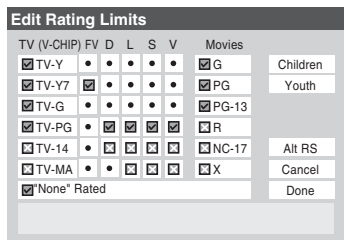

Blocking TV programs and movies by additional ratings

In the future, an additional rating system may become available for use in selectively blocking programs.

To download the additional rating system (if available):

- 1 Press **MENU** and highlight the **Locks** menu icon.
- 2 Press **▼** to display the PIN code entering screen.
- 3 Enter your four-digit PIN code and press **ENTER**.
- 4 Press **▼** to highlight **Enable Rating Blocking**.
- 5 Press **▶** and **▼** to select **On**, and press **ENTER**.
- 6 Press **▼** to highlight **Edit Rating Limits** and press **ENTER**. The **Edit Rating Limits** screen appears.

Note: The currently tuned station must be receiving a digital signal before an additional rating system can be downloaded.

- 7 Highlight **Alt RS** and press **ENTER**. The **Edit Alternate Ratings** screen will appear.

Note:

- The **Alt RS** button will only be available if an additional rating system is currently available.
- Some period of time may be required to download the additional rating system.
- The information displayed in the **Alternate Ratings** screen will depend on the configuration of the additional rating system available at the time of download.

- 8 Press **▲▼◀▶** and then press **ENTER** to select the level of blocking you prefer. A box with an "X" is a rating that will be blocked.
- 9 When you are finished selecting the ratings you want to block, highlight **Done** and press **ENTER**.
- 10 In the **Edit Rating Limits** screen, highlight **Done** and press **ENTER**.

Note:

- The additional rating system can only be downloaded one time. You will not be able to download any updates to the rating system should such updates become available.
- The additional rating system is not designed, transmitted, or controlled by the TV or Toshiba, nor is the availability of an additional rating system determined or controlled by Toshiba. Similarly, the rating of programs in an additional rating system is not determined, transmitted, or controlled by the TV or Toshiba.
- The additional rating system is an evolving technology; therefore, availability, content, and format may vary.

Chapter 5: Using the TV's features

Independent rating system for broadcasters	
Ratings	Description and Content themes
TV-MA	Mature Audience Only (This program is specifically designed to be viewed by adults and therefore may be unsuitable for children under 17.) L) Crude or indecent language S) Explicit sexual activity V) Graphic violence
TV-14	Parents Strongly Cautioned (This program contains some material that many parents would find unsuitable for children under 14 years of age.) D) Intensely suggestive dialog L) Strong, coarse language S) Intense sexual situations V) Intense violence
TV-PG	Parental Guidance Suggested (This program contains material parents may find unsuitable for younger children.) D) Some suggestive dialog L) Infrequent coarse language S) Some sexual situations V) Moderate violence
TV-G	General Audience (Most parents would find this program suitable for all ages.)
TV-Y7, TV-Y7FV	Directed to Older Children (This program is designed for children age 7 and above. Note: Programs in which fantasy violence may be more intense or more combative than other programs in this category are designated TV-Y7FV.)
TV-Y	All Children (This program is designed to be appropriate for all children.)

Independent rating system for movies	
Ratings	Description and Content themes
X	X-rated (For adults only)
NC-17	Not intended for anyone 17 and under
R	Restricted (Under 17 requires accompanying parent or adult)
PG-13	Parents Strongly Cautioned (Some material may be inappropriate for children under 13)
PG	Parental Guidance Suggested (Some material may not be suitable for children)
G	General Audience (Appropriate for all ages)

Note:

- If you place an "X" in the box next to "None Rated," programs rated "None" will be blocked; however, programs that do not provide any rating information will not be blocked.
- To display the rating of the program you are watching, press **RECALL** on the remote control. If it is rated "None," the word "NONE" appears in the **RECALL** screen (as shown below right). If rating information is not provided, no rating will appear in the **RECALL** screen.

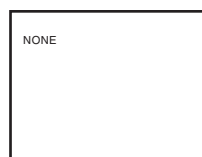
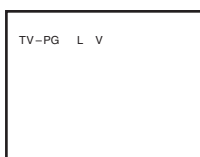

Blocking channels

With the Channels Block feature, you can block specific channels. You will not be able to tune blocked channels unless you unblock them.

To block channels:

- Press **MENU** and highlight the **Locks** menu icon.
- Press **▼** to display the PIN code entering screen.
- Enter your four-digit PIN code and press **ENTER** (see page 47).
- Press **▼** to highlight **Channels Block** and then press **ENTER**.

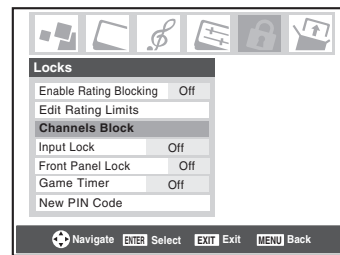

- Press **▲▼◀▶** to select the input for which you want to change the rating limits (**ANT1**, or **ANT2**) and press **ENTER**. A list of the channels available for that input will be displayed along with the call letters for each channel, if available.
- Press **▲▼** to highlight the channel you want to block and press **ENTER**, which puts an "X" in the box next to that channel.

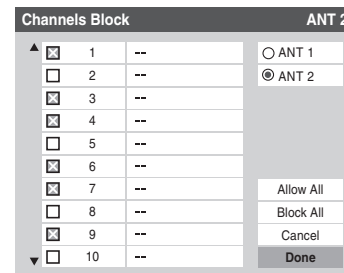

- Repeat step 6 for other channels you want to block.
- Highlight **Done** and press **ENTER**.

To unblock individual channels:

In step 6 above, press **▲▼** to highlight the channel you want to unblock, press **ENTER** to remove the "X" from the box, highlight **Done** and press **ENTER**.

To block all channels at once:

Highlight **Block All** in step 6 above, and then highlight **Done** and press **ENTER**.

Chapter 5: Using the TV's features

To unblock all locked channels at once:

Highlight **Allow All** in step 6 above, and then highlight **Done** and press **ENTER**.

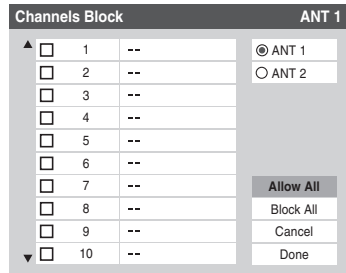

Unlocking programs temporarily

If you try to tune the TV to a program that exceeds the rating limits you set, the TV will enter program lock mode and the following message will appear on-screen:

This program exceeds the rating limit you set.
Push 'mute' to enter PIN.

You can either temporarily unlock the program or select an unlocked program to watch.

To temporarily unlock the program:

- 1 Press **MUTE**.
- 2 Enter your four-digit PIN code and press **ENTER**. If the correct code is entered, the program lock mode is released and the normal picture appears. All locking is disabled until the TV is turned off, and will be enabled when the TV is turned on again.

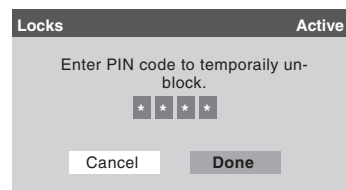

Using the input lock feature

You can use the Input Lock feature to lock the video inputs (**VIDEO 1**, **VIDEO 2**, **ColorStream HD-1**, **ColorStream HD-2**, **HDMI 1**, **HDMI 2**, and **PC**) and channels 3 and 4. You will not be able to view the input sources or channels until you unlock the inputs.

To lock/unlock the video inputs:

- 1 Press **MENU** and highlight the **Locks** menu icon.
- 2 Press **▼** to display the PIN code entering screen.
- 3 Enter your four-digit PIN code and press **ENTER**.
- 4 Press **▼** to highlight **Input Lock** and press **▶**.
- 5 Press **▲** or **▼** to select the level of video input locking you prefer, as described below.

Video: Locks VIDEO 1, VIDEO 2, ColorStream HD1/HD2, HDMI 1/HDMI 2, PC.

Video+: Locks VIDEO 1, VIDEO 2, ColorStream HD1/HD2, HDMI 1/HDMI 2, PC and channels 3 and 4.

- Select Video+ if you play video tapes via an ANT input.
- When a CableCARD™ is inserted, Video+ will not lock channels 3 and 4.

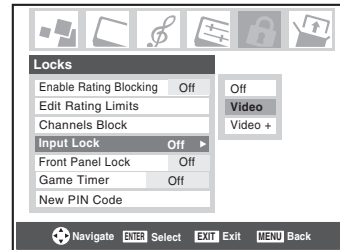

Off: Unlocks all video inputs and channels 3 and 4.

- 6 Press **ENTER**.

Using the GameTimer™

You can use the GameTimer to set a time limit for playing a video game (30–120 minutes). When the GameTimer is activated, the TV enters Input Lock mode and locks out the input source for the video game device.

To set the GameTimer™:

- 1 Press **MENU** and highlight the **Locks** menu icon.
- 2 Press **▼** to display the PIN code entering screen.
- 3 Enter your four-digit PIN code and press **ENTER**.
- 4 Press **▼** to highlight **Game Timer** and press **▶**.
- 5 Press **▲** or **▼** to select the length of time until the Input Lock is activated (30, 60, 90, or 120 minutes) and press **ENTER**.

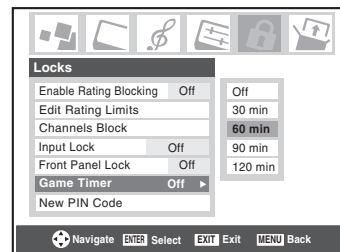

To cancel the GameTimer™:

Select **Off** in step 5 above.

Chapter 5: Using the TV's features

To deactivate the Input Lock once the GameTimer has activated it:

Set the **Input Lock** to **Off** (☞ “Using the input lock feature” on the previous page).

Note:

- A message will appear on-screen when 10 minutes, 3 minutes, and 1 minute remain on the GameTimer.
- If the TV loses power with time remaining on the GameTimer, when power is restored the TV will enter Input Lock mode (as if the GameTimer had expired) and you will have to deactivate the Input Lock (as described above).

Using the control panel lock feature

You can lock the control panel to prevent your settings from being changed accidentally (by children, for example). When the control panel lock is **On**, none of the controls on the TV control panel will operate except **POWER**.

To lock the control panel:

- 1 Press **MENU** and highlight the **Locks** menu icon.
- 2 Press **▼** to display the PIN code entering screen.
- 3 Enter your four-digit PIN code and press **ENTER**.
- 4 Press **▼** to highlight **Front Panel Lock**.
- 5 Press **▶** and **▲** or **▼** to highlight **On** and press **ENTER**. When the control panel is locked and any button on the control panel (except **POWER**) button is pressed, the message “**Not Available**” appears.

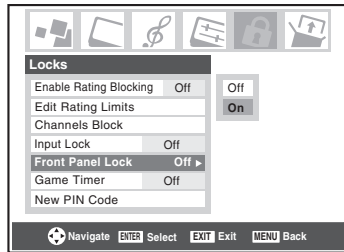

To unlock the control panel:

Highlight **Off** in step 5 above, or press and hold the **VOLUME –** button on the TV control panel for about 10 seconds until the volume icon appears on-screen.

Setting the sleep timer

You can set the sleep timer to turn off the TV after a set length of time (maximum of 180 minutes).

To set the sleep timer:

Press **SLEEP** on the remote control to set the length of time until the TV turns off. Repeatedly press **SLEEP** to increase the time in 10-minute increments, or press **▲** or **▼** to increase or decrease the time in 10-minute increments, to a maximum of 180 minutes.

To cancel the sleep timer:

Press **SLEEP** until it is set to 0 minutes.

To set the sleep timer using the on-screen menus:

- 1 Press **MENU** and open the **Setup** menu.
- 2 Highlight **Sleep Timer** and press **ENTER**.

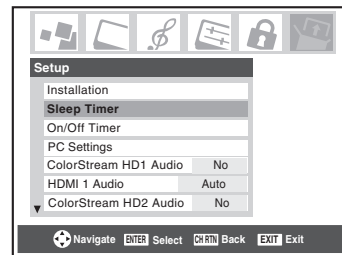

- 3 Press the Number buttons to enter the length of time in 10-minute increments.

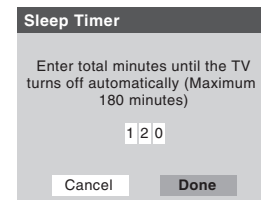

- 4 Highlight **Done** and press **ENTER**.

Note:

- When a power failure occurs, the sleep timer setting may be cleared.
- To display the amount of time left on the sleep timer, press **RECALL**.

To display the remaining sleep time:

Press **SLEEP**.

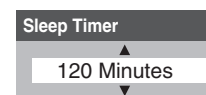

Note: A message will display on-screen when there is one minute remaining on the sleep timer.

Chapter 5: Using the TV's features

Setting the On/Off Timer

You can use the **On/Off Timer** to turn the TV on and off at a preset time on a recurring basis.

Note: You must first set the time (see page 28).

To set the On/Off Timer:

- 1 Press **MENU** and open the **Setup** menu.
- 2 Highlight **On/Off Timer** and press **ENTER**.
- 3 In the **DAY** field, press **◀** or **▶** to select the recurrence (weekends, weekdays, every day, etc).

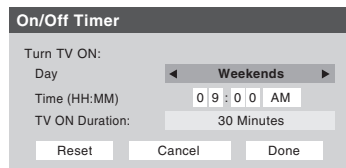

- 4 Press **▼** to highlight the **Time** field, and then use the Number buttons to enter the time you want the TV to turn on.
- 5 When the **AM/PM** field is highlighted, press **▶** to select **AM** or **PM**.
- 6 Press **▼** to highlight the **TV ON Duration** field, and then press **◀** or **▶** to select the length of time until the TV turns off (**30 Minutes, 1 Hour, 2 Hours, 4 Hours, 8 Hours, 12 Hours**).
- 7 Highlight **Done** and press **ENTER**.
- 8 Turn off the TV. The TV will turn on automatically on the day(s) and at the time you set. The TV will then turn off automatically after the length of time you set in the **TV ON Duration** field.

Note:

- When a power failure occurs, the **On/Off Timer** settings may be cleared.
- To display the **On/Off Timer** setting, press **RECALL**.

To turn off the On/Off Timer:

Select **Not Set** in step 3 above.

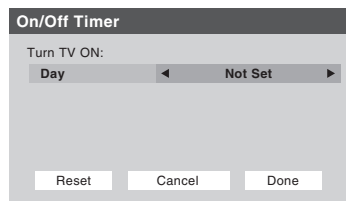

Using the PC setting feature

You can view the image from a PC on the TV screen. The PC must be connected to the TV's PC IN terminals (see *Installation Guide*).

You can use the PC Settings feature to adjust the picture's horizontal position/width, vertical position/height, clock phase, and sampling clock.

If the edges of the picture are cut off, readjust the **Horizontal Position/Width** and **Vertical Position/Height**. If the picture is affected by interference, readjust the **Clock Phase** and **Sampling Clock**.

To adjust the PC settings:

- 1 Repeatedly press **INPUT** to select PC input mode (see "Selecting the video input source to view" page 32).
- 2 Press **MENU** and open the **Setup** menu.
- 3 Highlight **PC Settings** and press **ENTER**.

Note: If a PC is not connected, this feature will be grayed out in the **Setup** menu.

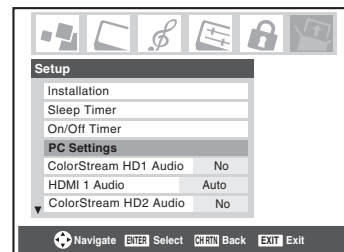

- 4 Press **▲** or **▼** to highlight the item you want to adjust.
- 5 Press **◀** or **▶** to make the appropriate adjustments.

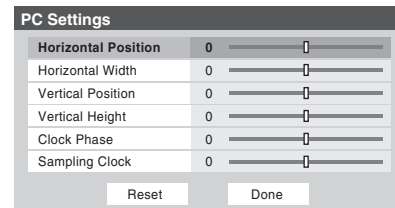

Note: The screen is disrupted momentarily when adjusting the PC settings. This is not a sign of malfunction.

• **Horizontal Position:**

Moves the picture left/right.

The adjustment range is within ± 5 from center.*

• **Vertical Position:**

Moves the picture up/down.

The adjustment range is within ± 5 from center.*

• **Horizontal Width:**

Adjusts the width of the picture.

The adjustment range is within ± 5 from center.*

• **Vertical Height:**

Adjusts the height of the picture.

The adjustment range is within ± 5 from center.*

Chapter 5: Using the TV's features

- **Clock Phase:**
Helps to reduce noise and sharpen the picture.
The adjustment range is within ± 2 from center.*
- **Sampling Clock:**
Helps to reduce noise and minimize periodic vertical stripes on the screen.
The adjustment range is within ± 15 from center.*

* The range of adjustment may vary slightly.

Displaying TV setting information on-screen using RECALL

To display TV setting information on-screen:

Press **RECALL** on the remote control.

The following information will display on-screen (if applicable):

- Current input (**ANT 1**, **ANT 2**, **VIDEO 1**, etc.)
 - If **ANT 1** or **ANT 2** is the current input, either "**CABLE**" (for cable TV) or "**TV**" (for over-the-air broadcasts).
 - Channel number (if in **ANT 1** or **ANT 2** mode)
 - Digital signal strength indicator (bar graph in lower right corner of screen; for ATSC signal only)
- Note:** The signal strength indicator will react to fading and increasing signals.
- Remaining time on sleep timer (if set)
 - Stereo or SAP audio status
 - V-Chip rating status
 - Picture size
 - Video resolution
 - Lamp mode (appears only if the TV is in High Bright mode)

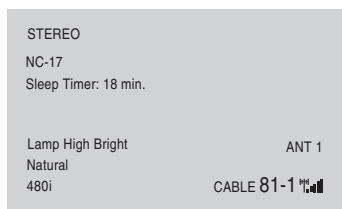

Sample RECALL screen

To close the RECALL screen:

Press **RECALL** again.

Understanding the auto power off feature

The TV will automatically turn itself off after approximately 15 minutes if it is tuned to a vacant channel or a station that completes its broadcast for the day. This feature functions in **ANT 1** and **ANT 2** modes only.

Understanding the last mode memory feature

If the power is cut off while you are viewing the TV, the Last Mode Memory feature automatically turns on the TV when the power is resupplied.

Note: You should unplug the TV's power cord if it is possible that you will be away from the TV for an extended period of time after the power is restored.

Chapter 6: Using the TV's advanced features

Using the advanced picture settings features

Using dynamic contrast

When dynamic contrast is set to **Low**, **Middle** or **High**, the TV will detect changes in the picture quality that affect the appearance of your contrast settings and then automatically adjust the video to the degree at which the Dynamic Contrast is set.

To select dynamic contrast preferences:

- 1 Press **MENU** and open the **Video** menu.
- 2 Highlight **Advanced Picture Settings** and press **ENTER**.

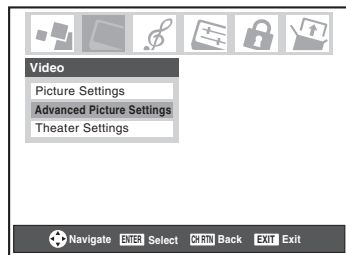

- 3 In the **Dynamic Contrast** field, select either **Off**, **Low**, **Middle** or **High**.

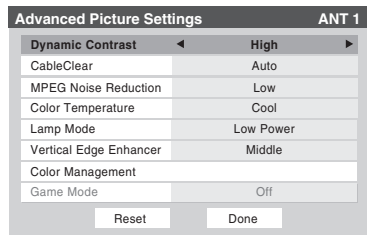

- 4 To save the new settings, highlight **Done** and press **ENTER**. To revert to the factory defaults, highlight **Reset** and press **ENTER**.

Note: If you select the **Movie** picture mode and then set the dynamic contrast to **Low**, **Middle** or **High**, the picture mode will automatically change to **Preference** in the **Picture Settings** menu (see page 42).

Using CableClear® digital noise reduction

The CableClear® digital noise reduction feature allows you to reduce visible interference in your TV picture. This may be useful when receiving a broadcast with a weak signal (especially a Cable channel) or playing a noisy video cassette or disc.

To change the CableClear settings:

- 1 Press **MENU** and open the **Video** menu.
- 2 Highlight **Advanced Picture Settings** and press **ENTER**.
- 3 In the **CableClear** field, select your desired setting.

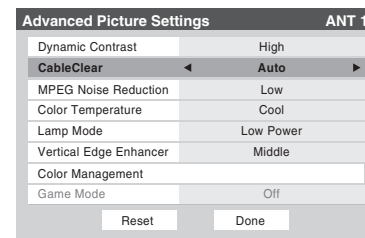

Note:

- If the current input is **ANT 1**, **ANT 2**, **VIDEO 1**, or **VIDEO 2**, the menu will display the text "CableClear." The available selections are **Off**, **Low**, **Middle**, **High**, and **Auto**.
 - If the current input is **ColorStream HD1**, **ColorStream HD2**, or **HDMI**, the menu will display the text "DNR." The available selections are **Off**, **Low**, **Middle**, **High**, and **Auto**. **Auto** will react proportionally to the strength of the noise. **Low**, **Middle**, and **High** will reduce the noise in varying degrees, from lowest to highest, respectively.
- 4 To save the new settings, highlight **Done** and press **ENTER**. To revert to the factory defaults, highlight **Reset** and press **ENTER**.

Chapter 6: Using the TV's advanced features

Using MPEG noise reduction

The MPEG noise reduction feature allows you to reduce visible interference caused by MPEG compression. Choices for MPEG noise reduction are **Off**, **Low**, **Middle**, and **High**. **Off** is automatically selected when this feature is disabled (“grayed out”).

To select the MPEG noise reduction level:

- 1 Press **MENU** and open the **Video** menu.
- 2 Highlight **Advanced Picture Settings** and press **ENTER**.
- 3 Press **▲** or **▼** to highlight the **MPEG Noise Reduction** field, and then press **◀** or **▶** to select either **Off**, **Low**, **Middle** or **High**.

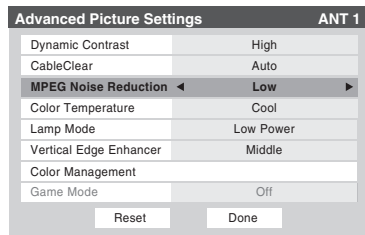

- 4 To save the new settings, highlight **Done** and press **ENTER**. To revert to the factory defaults, highlight **Reset** and press **ENTER**.

Selecting the color temperature

You can change the quality of the picture by selecting from three preset color temperatures (cool, medium, and warm), as described below.

Mode	Picture Quality
cool	blueish
medium	neutral
warm	reddish

To select the color temperature:

- 1 Press **MENU** and open the **Video** menu.
- 2 Highlight **Advanced Picture Settings** and press **ENTER**.
- 3 In the **Color Temperature** field, select the mode you prefer (**Cool**, **Medium**, or **Warm**).

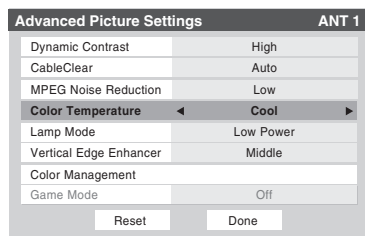

- 4 To save the new settings, highlight **Done** and press **ENTER**. To revert to the factory defaults, highlight **Reset** and press **ENTER**.

Note: If you select one of the factory-set picture modes (**Sports**, **Standard**, or **Movie**) and then change the color temperature mode, the picture mode automatically changes to **Preference** in the **Picture Settings** menu.

Selecting the lamp mode

You can select either the **High Bright** or **Low Power** lamp mode.

- The **High Bright** mode is useful when additional picture brightness is desired (such as in a bright room).

To select the lamp mode:

- 1 Press **MENU** and open the **Video** menu.
- 2 Highlight **Advanced Picture Settings** and press **ENTER**.
- 3 In the **Lamp Mode** field, select **High Bright** or **Low Power**, whichever you prefer.

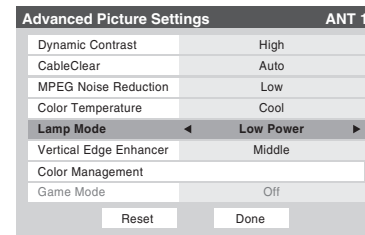

- 4 To save the new settings, highlight **Done** and press **ENTER**. To revert to the factory defaults, highlight **Reset** and press **ENTER**.

Note: If you set the lamp mode to **Low Power**, each time you turn on the TV, the lamp will start out in **High Bright** mode but will switch to **Low Power** mode after a short period of time. You may notice a change in screen brightness when this happens. This is normal and is not a sign of malfunction.

Chapter 6: Using the TV's advanced features

Using the Vertical Edge Enhancer feature

This function strengthens video contour by correcting the edges of horizontal bars.

To turn on the Vertical Edge Enhancer feature:

- 1 Press **MENU** and open the **Video** menu.
- 2 Highlight **Advanced Picture Settings** and press **ENTER**.
- 3 Highlight **Vertical Edge Enhancer** and press **ENTER**.

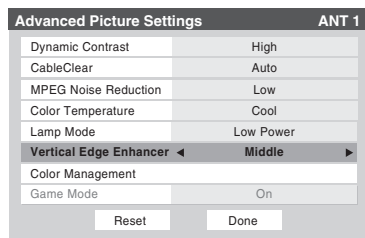

- 4 In the **Vertical Edge Enhancer** field, select the mode you prefer (**off**, **Low**, **Middle**, and **High**).
- 5 To save the new settings, highlight **Done** and press **ENTER**. To revert to the factory defaults, highlight **Reset** and press **ENTER**.

Note:

- Changing the setting of this item will cause the "Mode" to automatically change to "Preference."
- Grayed out and set to "High" when input changed to PC.

Using the Color Management feature

The Color management feature allows you to adjust the hue, saturation, and brightness of six colors: **red**, **green**, **blue**, **yellow**, **magenta**, and **cyan**.

To change the Color Management settings:

- 1 Press **MENU** and open the **Video** menu.
- 2 Highlight **Advanced Picture Settings** and press **ENTER**.
- 3 Highlight **Color Management** and press **ENTER**.

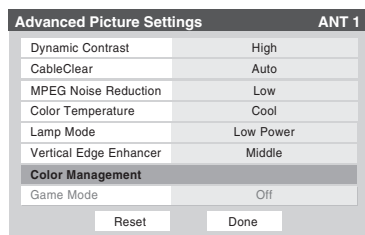

- 4 In the **Color Management** field, select **On**.

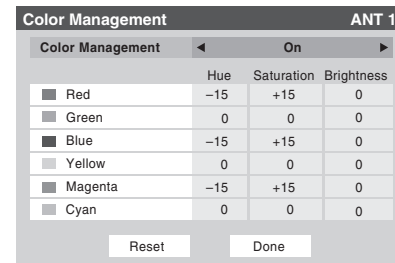

- 5 Press **▲** or **▼** to highlight the color you want to adjust, and then press **ENTER**.
- 6 Press **▲** or **▼** to select either **Hue**, **Saturation**, or **Brightness**, and then press **◀** and **▶** to adjust the setting.

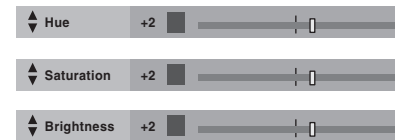

- 7 Press **ENTER** to return to the **Color Management** window.
- 8 To save the new settings, highlight **Done** and press **ENTER**. To revert to the factory defaults, highlight **Reset** and press **ENTER**.

Note: If you select one of the factory-set picture modes (Sports, Standard, or Movie) and then change the **Color Management** to **On**, the picture mode automatically changes to **Preference** in the **Picture Settings** menu.

Chapter 6: Using the TV's advanced features

Using the Game Mode feature

You can use the Game Mode feature for shorter frame delays when playing a video game requiring split-second timing between the on-screen display and input from the controller (such as music creation and high-action games).

Note: To use the Game Mode feature, the current video input must be **Video 1**, **Video 2**, **ColorStream HD1**, **ColorStream HD2**, **HDMI 1** or **HDMI 2**. The Game Mode cannot be turned on when any other video input is selected.

To turn on Game Mode:

- 1 Press **MENU** and open the **Video** menu.
- 2 Highlight **Advanced picture settings** and press **ENTER**.
- 3 Press **▲** or **▼** to highlight the **Game Mode** field, and then press **◀** or **▶** to select **On**.

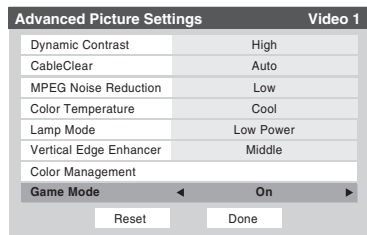

To turn off Game Mode:

Select **Off** in step 3 above, change the video input, or turn the TV off and then on again.

You can change the video input in any of the following ways:

- Pressing **INPUT** on the remote control (see page 32).
- Changing the channel using the Numbers or **CH** / **CH** / **CH RTN**, **BACK** / **NEXT** / **CH** / **CH**.

Chapter 6: Using the TV's advanced features

Using the advanced audio settings features

Using the SRS WOW™ surround sound feature

SRS WOW™ is a special combination of SRS Labs audio technologies (SRS 3D, SRS FOCUS, and SRS TruBass) that creates a thrilling surround sound experience with deep, rich bass from stereo sound sources. Your TV's audio will sound fuller, richer, and wider.

To adjust the WOW™ settings:

- 1 Put the TV in **STEREO** mode (⏏ “Selecting stereo/SAP broadcasts” on page 45).
- 2 Press **MENU** and open the **Audio** menu.
- 3 Highlight **Advanced Audio Settings** and press **ENTER**.
- 4 Press **▼** or **▲** to highlight the WOW feature you want to adjust, and then press **◀** or **▶** to adjust the item.

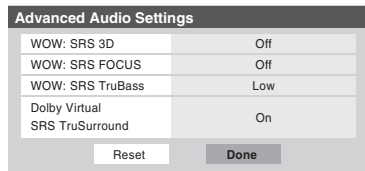

- **WOW: SRS 3D** — To turn the surround sound effect **On** or **Off**.

Note: If the broadcast is monaural, the SRS 3D effect will not work.

- **WOW: SRS Focus** — To turn the vocal emphasis effect **On** or **Off**.
- **WOW: SRS TruBass** — To select the desired bass expansion level (**Off**, **Low**, or **High**).

- 5 To save the new settings, highlight **Done** and press **ENTER**. To revert to the factory defaults, highlight **Reset** and press **ENTER**.

WOW, TruSurround, SRS and  are trademarks of SRS Labs, Inc. WOW and TruSurround technologies are incorporated under license from SRS Labs, Inc.

Using the virtual surround sound feature (Dolby® Virtual/SRS TruSurround™)

The Dolby Virtual/SRS TruSurround feature allows you to enjoy virtual surround sound from the TV's speakers. This feature is enabled only when the TV is receiving digital broadcasts.

To turn on the Dolby Virtual surround sound feature:

- 1 Press **MENU** and open the **Audio** menu.
- 2 Highlight **Advanced Audio Settings** and press **ENTER**.
- 3 In the **Dolby Virtual SRS TruSurround** field, select **On**.

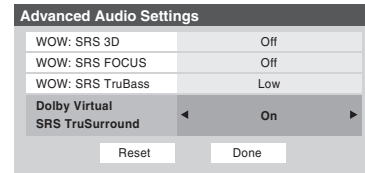

- 4 To save the new settings, highlight **Done** and press **ENTER**. To revert to the factory defaults, highlight **Reset** and press **ENTER**.

To turn off the Dolby Virtual/SRS TruSurround feature:

Select **Off** in step 3 above.

Note: The **Dolby Virtual/SRS TruSurround** and **WOW SRS 3D** features cannot be on at the same time. If you set one to **On**, the other will automatically be set to **Off**.

Chapter 7: Using the THINC™ home network feature

The **Toshiba Home Interactive Network Connection (THINC™)** feature allows you to connect the TV to your home network, which will enable access to file sharing and e-mail scheduling features.

- **File sharing**

You can access JPEG and MP3 files that are stored on your networked home PC and view/play them on the TV.

Note: Requires a home network* (☞ *Installation Guide*). Does NOT require Internet/e-mail service.

- **E-mail scheduling of recordings and reminders**

You can schedule recordings and reminders by sending an e-mail to the TV from any PC.

Note:

- Requires a compatible recording device (☞ *Installation Guide*); a home network* (☞ *Installation Guide*); and home Internet service with a dedicated POP3 e-mail address for the TV (different from your personal e-mail address).
- **Contact your Internet Service Provider (ISP) to obtain and set up Internet/e-mail service.**
- **You will NOT be able to access or browse the Internet through the TV.**

Follow the steps in sections A through D (☞ pages 59–63) to set up and use the TV's home network features.

* The THINC™ home network feature is compatible only with **Microsoft® Windows® 2000** and the **Home and Professional versions of Microsoft® Windows® XP Service Pack 1 and Service Pack 2**.

Microsoft and Windows are either registered trademarks or trademarks of Microsoft Corporation in the United States and/or other countries.

A. Connecting the TV to your home network

- 1 **Connect the TV to your home network** via the TV's RJ-45 (Ethernet) port. See *Installation Guide* for connection instructions.
- 2 **If you want to use file sharing only and do not have Internet service in your home:**

Go to section B, "Setting up the network address," at right.

Note: If you do not have Internet service, you will not be able to use the e-mail scheduling feature.

If you want to use file sharing and e-mail scheduling:

- a) You must have Internet service in your home and a dedicated e-mail address for the TV (different from your personal e-mail address). Contact your ISP to obtain and set up Internet/e-mail service in your home.
- b) After you have obtained Internet/e-mail service in your home (from your ISP), go to section B, "Setting up the network address" at right.

For home network troubleshooting tips, see Chapter 8.

The unauthorized recording, use, distribution, or revision of television programs, videotapes, DVDs, and other materials is prohibited under the Copyright Laws of the United States and other countries, and may subject you to civil and criminal liability.

B. Setting up the network address

To set up the network address:

- 1 **First, try automatically setting up the network address** (below).
- 2 If the automatic setup is not successful, you can **either** retry the automatic setup (below) **or** try manually setting up the network address (☞ page 60).

Note:

- If you used an Ethernet crossover cable to connect your PC directly to the TV, you will not be able to use the automatic setup, and must manually set up the network address.
- If you used a hub or switch to connect the TV to your home network, you will not be able to use the automatic setup, and must manually set up the network address.
- If you used a router with built-in DHCP functionality, use the automatic setup. Manual setup may not work.

Router technology, like all new and emerging technology, may from time to time cause compatibility issues because of the differences in router systems implemented by the various router manufacturers; however, most issues can be easily resolved. If you think your Toshiba TV and router might have compatibility problems, please contact Toshiba Consumer Solutions by calling **1-800-631-3811** or by visiting <http://www.tacp.com/customersupport/contact.asp>.

Automatically setting up the network address

- 1 Press **MENU** and open the **Setup** menu.
- 2 Highlight **Installation** and press **ENTER**. The **Installation** menu appears.
- 3 Open the **Network** menu.

(continued)

Chapter 7: Using the THINC™ home network feature

- 4 Highlight **Basic Network Setup** and press **ENTER**.

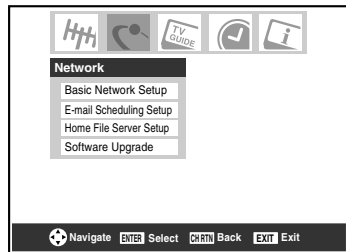

- 5 The message “Obtain network address automatically?” will display. Highlight **Yes** and press **ENTER**.

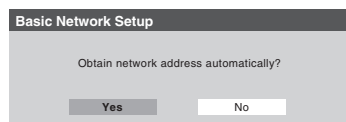

- 6 The message “Please wait...” will display while the TV is attempting to load the network address information from the DHCP server.

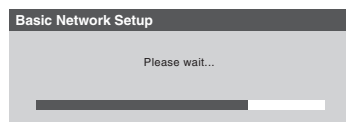

If the automatic network address setup is successful, go to step 7.

If the automatic network address setup is not successful, go to step 8.

- 7 If the automatic network address setup is successful, the following screen will appear:

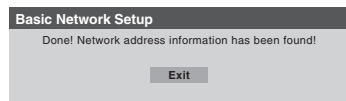

- Press **ENTER** to close the screen and return to the **Network** menu.
 - Skip to section C, “Setting up file sharing on your PC” (see page 61).
- 8 If the automatic network address setup is **not** successful, the following screen will appear:

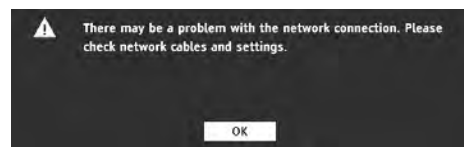

- Make sure all cables for your home network are securely connected.
- Make sure your home network is set up properly. **See Installation Guide for TV connection information. Also consult the owner’s manuals for your other components.**
- Make sure the DHCP and security settings on your home router are correct. **Consult the owner’s manual for your router.**
- Retry the automatic network address setup by following these steps:

- Highlight **OK** and press **ENTER**.
- Repeat steps 1–6. (If you have already repeated this setup process, go to step 9.)

- 9 If, after repeating steps 1–6, you receive the error message shown in step 8:

Either...

- Highlight “**OK**” and press **ENTER**.
- Go to “**Manually setting up the network address**”. Or...
 - Highlight “**OK**” and press **ENTER**.
 - Continue to sections C, D, and E** (see pages 61–64) (to set up and use file sharing) **and/or to sections F and G** (see pages 68–75) (to set up and use e-mail scheduling).

If the file sharing and/or e-mail scheduling features work correctly, then the automatic network address setup was successful (even though the TV displayed the error message).

Manually setting up the network address

This setup requires the data listed below. You can get this data from either your ISP or the configuration utility for your DSL/cable modem or router.

IP address:

Subnet mask:

Gateway (Router) address:

DNS (Domain Name Server) address:

- Press **MENU** and open the **Setup** menu.
- Highlight **Installation** and press **ENTER**. The **Installation** menu appears.
- Open the **Network** menu.
- Highlight **Basic Network Setup** and press **ENTER**.
- The message “Obtain network address automatically?” appears. Highlight **No** and press **ENTER**.

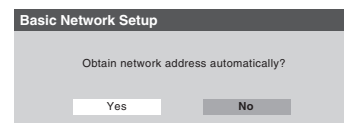

Chapter 7: Using the THINC™ home network feature

- 6** The **Basic Network Setup** menu appears.
Press **▲** or **▼** to highlight the **IP Address** field, and then use the Number buttons on the remote control to input the IP address.

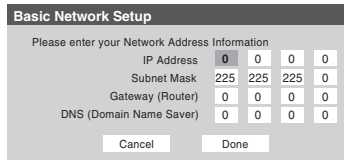

- 7** Press **▼** to highlight the **Subnet Mask** field, and then use the Number buttons to input the Subnet Mask.
- 8** Press **▼** to highlight the **Gateway (Router)** field, and then use the Number buttons to input the Gateway (Router) address.
- 9** Press **▼** to highlight the **DNS (Domain Name Server)** field, and then use the Number buttons to input the DNS address.
- 10** When finished, highlight **Done** and press **ENTER**.
The **Basic Network Setup** menu closes and the **Network** menu appears.
- 11** Go to section C, “Setting up file sharing on your PC.”

Resetting the network address

- Press **MENU** and open the **Setup** menu.
- Highlight **Installation** and press **ENTER**. The **Installation** menu appears.
- Open the **Network** menu.
- Highlight **Basic Network Setup** and press **ENTER**.
- The message “Your Basic Network Setup is complete. Would you like to start over?” will appear.
To continue, highlight **Yes** and press **ENTER**.
To return to the **Network** menu, highlight **No** and press **ENTER**.

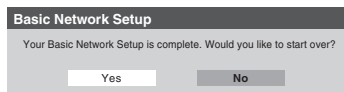

- 6** If you selected **Yes** in step 5, the message “Obtain network address automatically?” will appear.

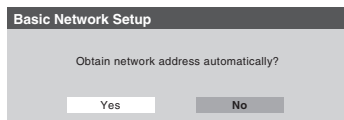

To obtain the network address automatically, go to step 5 under “Automatically setting up the network address” (page 59).
To manually enter the network address, go to “Manually setting up the network address”.

For home network troubleshooting tips, see Chapter 8.

C. Setting up file sharing on your PC

Compatible operating systems

The following operating systems are compatible for file sharing with the TV:

- Microsoft® Windows® XP Service Pack 2 (Home Edition and Professional) [See setup details below]
 - Microsoft® Windows® XP Service Pack 1 (Home Edition and Professional) [See setup details below]
 - Microsoft® Windows® 2000 [See setup details on page 62]
- No other operating systems are compatible with the TV.

Note:

- The name of any directory/folder on your PC that you are setting up for file sharing with the TV can have a maximum of 12 characters and cannot contain any special characters.
- See “Media specifications” (page 64) for details on compatible JPEG and MP3 files.
- The network (NETBIOS) name of your PC that you are setting up for file sharing must be 15 characters or less.

To determine which operating system and service pack (if applicable) are on your PC:

- On your PC, click the “Start” button.
- Click “Settings | Control Panel”.
- In the Control Panel, double-click “System”.
- Select the “General” tab, which will display your PC’s current operating system and service pack.

Setting up file sharing on a PC with Microsoft® Windows® XP Service Pack 1 or Service Pack 2

- 1** On your PC:

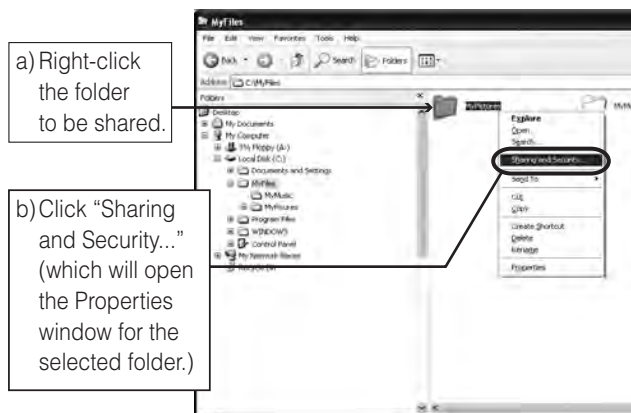

* Microsoft product screen shot(s) reprinted with permission from Microsoft Corporation.

(continued)

Chapter 7: Using the THINC™ home network feature

2 In the Properties window for the selected folder:

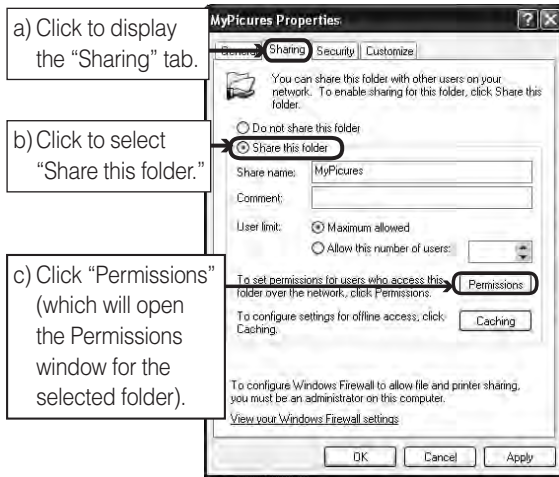

Note: If the "Sharing" tab on your specific PC looks like the one illustrated below (with no "Permissions" button), follow the steps below. When you click "OK", you are finished setting up file sharing on your PC and can proceed to section D.

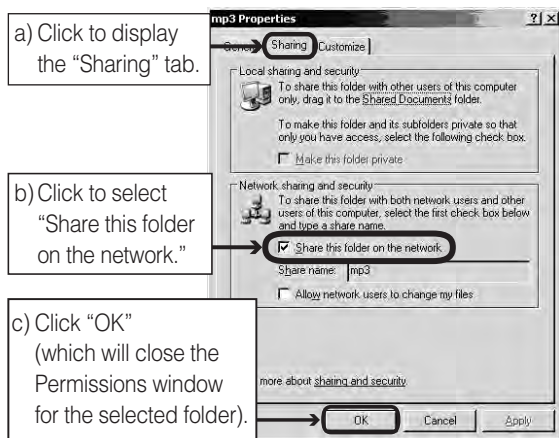

3 In the Permissions window for the selected folder:

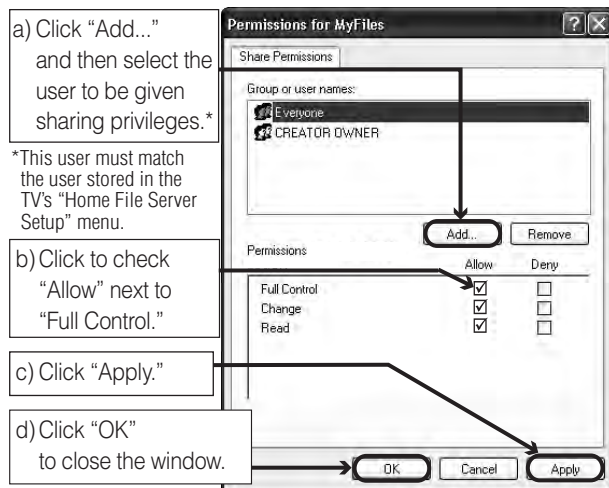

4 Go to section D, "Set up file sharing on the TV".

Setting up file sharing on a PC with Microsoft® Windows® 2000

1 On your PC:

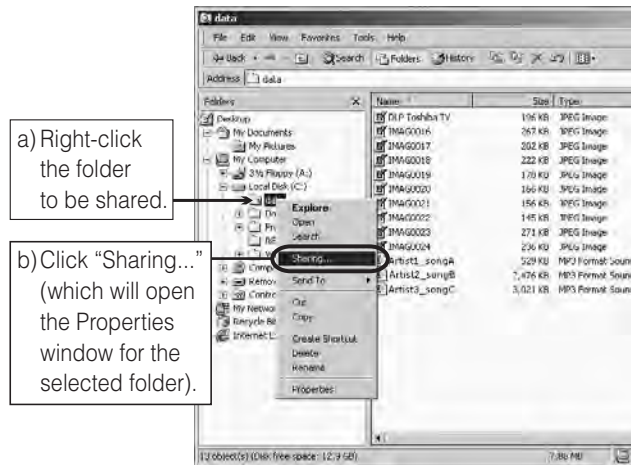

2 In the Properties window for the selected folder:

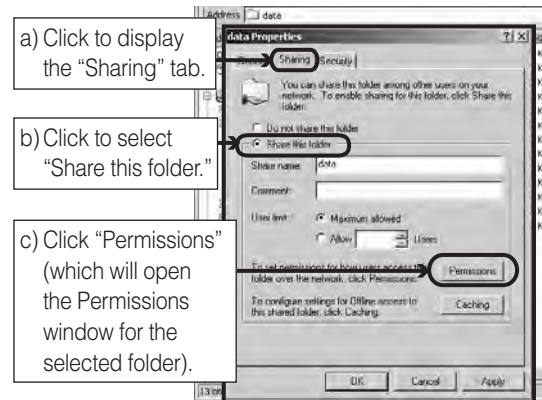

3 In the Permissions window for the selected folder:

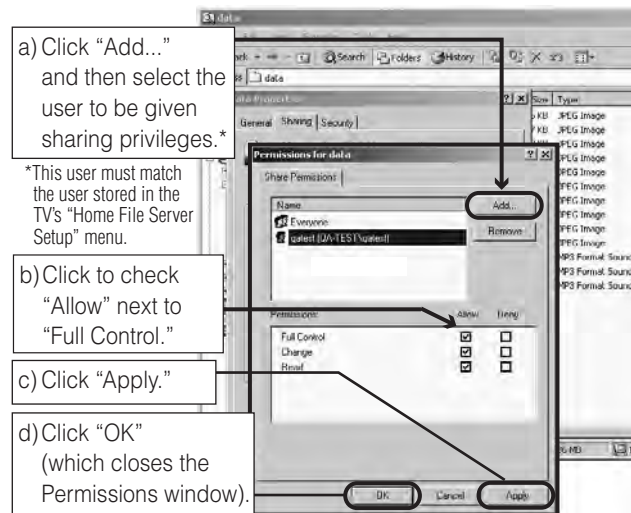

Chapter 7: Using the THINC™ home network feature

4 In the Properties window:

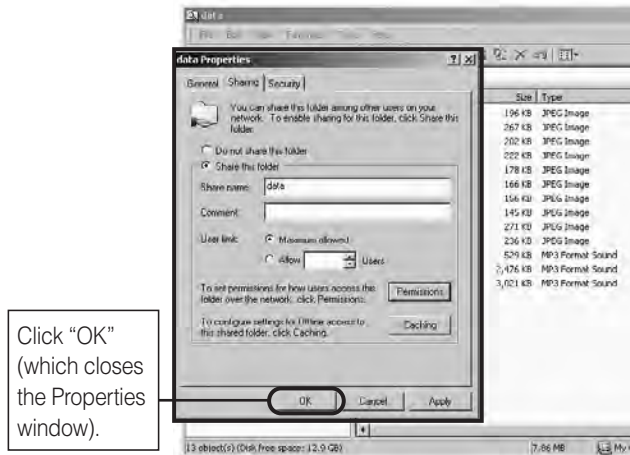

5 The shared folder will display with a “shared folder” icon (a hand holding a folder).

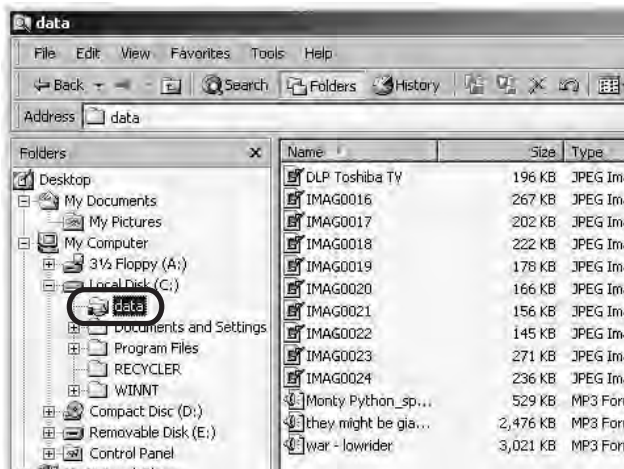

6 Go to section D, “Setting up file sharing on the TV” at right.

For home network troubleshooting tips, see Chapter 8.

D. Setting up file sharing on the TV

- 1** Press **MENU** and open the **Setup** menu.
- 2** Highlight **Installation** and press **ENTER**. The **Installation** menu will appear. Open the **Network** menu.

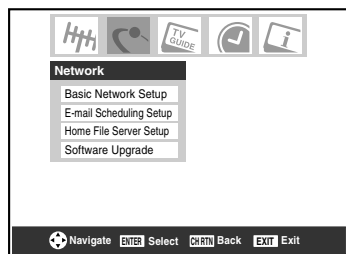

3 Highlight **Home File Server Setup** and press **ENTER**. The **Home File Server Setup** window will appear.

After a few moments, the message “Please Wait...” will appear until the network finds your networked PC. The networked PC will act as the “Home Server” for file sharing with the TV.

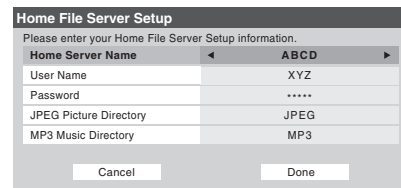

4 Press **▲▼** to highlight **Home Server Name**, and then press **◀▶** to select the name of the PC you set up for file sharing.

If you have multiple PCs on your home network that have shared folders, press **◀▶** to select the PC (home server) from which you want to access files.

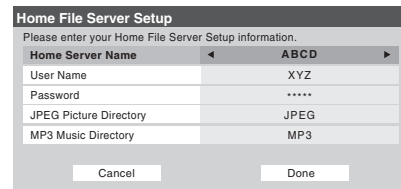

5 a. Press **▲▼** to highlight **User Name** and then press **ENTER** to open the on-screen keyboard for that field.

b. Enter the User Name for your PC using the on-screen keyboard. See “Using the on-screen keyboard”.

Note: The **User Name** is case sensitive.

c. When finished entering all characters, highlight **Done** and press **ENTER**.

6 Repeat step 5 for the **Password** field.

Note: The **Password** is case sensitive.

7 Press **▲▼** to highlight either **JPEG Picture Directory** or **MP3 Music Directory**.

Note: The first time you highlight either of these fields, the message “Please Wait...” will appear on-screen until the field is populated with the files in your PC’s shared folder(s).

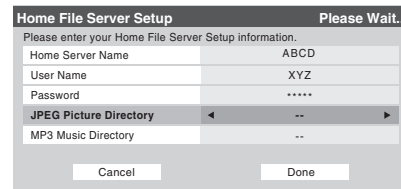

8 Press **◀▶** to select the shared folder (on your PC) that contains the JPEG and/or MP3 files you want to view/play on the TV.

Note: Make sure you select the correct folder in this step.

(continued)

Chapter 7: Using the THINC™ home network feature

- 9 To exit the window and save your settings, highlight **Done** and press **ENTER**.
To exit the window without saving your settings, highlight **Cancel** and press **ENTER**.

USING THE ON-SCREEN KEYBOARD

- a) Press **▲▼◀▶** to highlight the desired letter, number, or character, and then press **ENTER**.

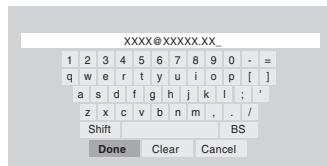

- b) Repeat step “a” until you have finished entering all characters for the selected field.

Notes:

- To toggle between uppercase and lowercase letters and between numbers and symbols, highlight **Shift** and press **ENTER**.
 - To erase the last entered character, highlight **BS** (backspace) and press **ENTER**.
 - To clear your entered characters, highlight **Clear** and press **ENTER**.
- c) When you are finished entering all characters for the selected field, highlight **Done** and press **ENTER**.
You will return to the previous **Setup** window.

About the Software Upgrade feature

This feature allows you to download updated software to your television from a shared folder on your home network. If you experience any difficulties that can only be resolved by a software update, your TACP customer service representative will provide you with the appropriate upgrade files, and assist you in the proper use of this feature.

E. Viewing/playing shared files on the TV

You can use the **Picture Viewer** to view compatible JPEG-format photos on your TV’s screen.

You can use the **Audio Player** to play compatible MP3 files on the TV.

The TV can access JPEG and/or MP3 files that are stored on a networked PC (as described on pages 65–67, and *Installation Guide*).

Note:

- If you are viewing/playing files stored on a networked PC, IT IS RECOMMENDED THAT YOU BACK UP YOUR DATA. Toshiba is not liable for any damage caused by the use of any networked PC, or shared files with this TV. Toshiba will not compensate for any lost data or recording(s) caused by the use of such PCs, or data.
- The technical criteria set out in this Guide are meant as a guide only.
- You must obtain any required permission from copyright owners to download or use copyrighted content. Toshiba cannot and does not grant such permission.

Media specifications

File/folder name specifications

- **Maximum file name length:** 255 characters.
- **Maximum shared folder* name length:** 12 characters.
- **File names must contain US-ASCII characters only.**
- **File and folder names cannot contain any special characters, such as \ / : ? “ ” < > | .**

* The words “folder” and “directory” are used interchangeably.

Picture Viewer/JPEG file specifications

- **Maximum JPEG file size:** 8 MB
 - JPEG files larger than 8 MB will not display.
- **Maximum JPEG image resolution:** 6000 × 4000 pixels
 - Images with a resolution higher than 6000 × 4000 pixels will not display.
- **The Picture Viewer is designed to display only pictures stored in compatible JPEG formats with a file extension of “.jpg.”**
- **JPEG images processed and/or edited on a personal computer (PC) may not display properly or at all.**
- Some digital cameras may store images in a format that is not compatible with the TV.
- **JPEG files stored on a networked PC that are not in a file and folder format compatible with the TV will not display on the TV.**

Chapter 7: Using the THINC™ home network feature

Audio Player/MP3 file specifications

- **Maximum MP3 file size:** 50 MB
 - MP3 files larger than 50 MB will not play.
- **The Audio Player is designed to play** only music files stored in compatible MP3 formats with a file extension of “.mp3”.
- **MP3 files processed and/or edited on a PC** may not play properly or at all. Some MP3 files may be in a format that is not compatible with the TV.
- **MP3 files must be in the following format:**
 - MPEG1 (ISO/IEC 11172-3) Layer3.
 - Sampling frequency—MPEG1: 32 kHz, 44.1 kHz, 48 kHz.
 - Bitrate—MPEG1: 32–320 kbps.
 - Channels—Stereo, Joint stereo, Dual channel, Single channel.
 - ID3 Ver. 1, Ver. 2.
- **The meta-data for MP3 files** (e.g, artist name, album name, song title, etc.) must be in the following format:
 - ISO-8859-1 (US-ASCII/ Western European) character sets
- **MP3 files stored on a networked PC that are not in a file and folder format compatible with the TV will not play on the TV.**

Networked PC specifications

Maximum number of files per shared folder:

- JPEG = 1,000
 - All JPEG files over the 1,000th in a shared folder will not display.
- MP3 = 200
 - All MP3 files over the 200th in a shared folder will not play.

Maximum number of nested folder levels: 10 levels

- Files in folders more than 10 levels down from the top level folder will not display/play.
- See pages 59–63, for details on networking your TV and PC for file sharing.

Using the Picture Viewer

You can use the TV's **Picture Viewer** to display your digital photos (JPEG files) on your TV's screen in thumbnail mode or as a slide show.

Note:

- You cannot use the **Picture Viewer** and **Audio Player** at the same time.
- You must obtain any required permission from copyright owners to download or use copyrighted content. Toshiba cannot and does not grant such permission.

Accessing JPEG files stored on a networked PC

- 1 Make sure you have correctly set up your home network and file sharing (see *Installation Guide* and pages 59–64).
- 2 Press **MENU** and open the **Applications** menu.
- 3 Highlight **Picture Viewer** and press **ENTER**.

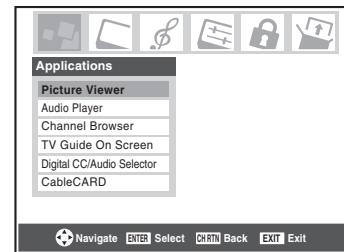

If the network is available, it will retrieve its JPEG picture list via the network.

- 4 Press **▲** or **▼** to access the folder or directory which contains the JPEG pictures you want to view.



To expand a particular folder to view a list of images, press **▶** on the folder.

To close the folder or directory, press **◀** on the folder or directory.

Pressing **◀** on a file will move the focus up to the folder which contains the file.

Pressing **▶** on a file will move the focus down to the next folder.

Press **ENTER** on a particular folder, then the thumbnail view with the first image in the folder will be displayed. If you press **ENTER** on a particular file, the thumbnail view with that file as the first file in the thumbnail list will be displayed.

Note: You can use **CHRTN** to switch back and forth between the thumbnail and folder views. The item last selected will be highlighted upon return to the application.

- 5 Go to “Viewing JPEG files on the TV” (see page 66).

Chapter 7: Using the THINC™ home network feature

Viewing JPEG files on the TV

- 1 After accessing your JPEG files from your networked PC (page 65), the images automatically display on-screen, with one as a large picture and six in thumbnail format.



- 2 Press ◀ to rotate the large picture 90° counterclockwise.



- 3 Press ▶ to rotate the large picture 90° clockwise.



- 4 Press ▲ or ▼ to select another picture as the large picture.
- 5 Press ENTER to view your pictures in a slide show.



During the slide show:

- To stop on an image during the slide show, press ENTER.
- To resume the slide show, press ENTER again.
- To rotate the picture, press ◀ or ▶.
- To select another image, press ▲ or ▼.
- To stop the slide show and return to the picture viewer, press CH RTN.
- To stop the slide show and return to the regular TV screen, press EXIT.

To set the slide show interval:

- 1 Press EXIT to close the **Picture Viewer** (if it is open).
- 2 Press MENU and open the **Setup** menu.
- 3 Highlight **Slide Show Interval** and press ENTER.
- 4 Select the interval from the menu sidebar (2, 5, 10, 15, or 20 seconds).

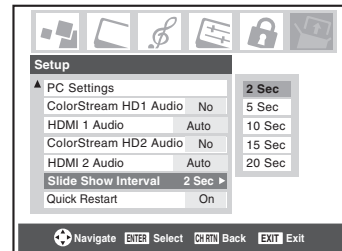

To view your JPEG files in Native Resolution mode:

To enter Native Resolution mode, press CH or CH during the slideshow. This will expand the image to its non-compressed format. A help bar for this mode can be displayed by pressing RECALL. This help bar will indicate that the user can scroll to the edges of the image by using the ▲ ▼ ◀ ▶. In order to exit Native Resolution and return to the normal slideshow, press ENTER. To return to the thumbnail view, press either EXIT or CH RTN. If an image is too large to display in Native Resolution mode (6MB), a warning message will be shown.

To close the Picture Viewer:

Press EXIT to close the **Picture Viewer** and return to the regular TV screen.

Chapter 7: Using the THINC™ home network feature

Using the Audio Player

You can use the TV's **Audio Player** to listen to MP3 files on the TV.

Note:

- Make all desired adjustments to the TV's audio features (e.g., surround, bass, treble, balance) before starting the **Audio Player**.
- You cannot use the **Picture Viewer** and **Audio Player** at the same time.
- You must obtain any required permission from copyright owners to download or use copyrighted content. Toshiba cannot and does not grant such permission.

Accessing MP3 files stored on a networked PC

- 1 Make sure you have correctly set up your home network and file sharing (see *Installation Guide* and pages 59–64).
- 2 Press **MENU** and open the **Applications** menu.
- 3 Highlight **Audio Player** and press **ENTER**.

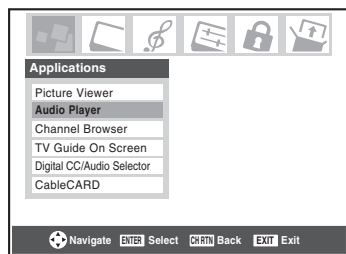

If the network is available, it will retrieve its MP3 files list via the network.

- 4 Press **▲** or **▼** to access the folder or directory which contains the MP3 files you want to play.

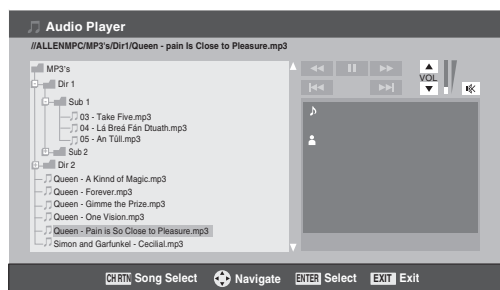

To expand a particular folder to view a list of images, press **▶** on the folder. To close the folder or directory, press **◀** on the folder or directory. Pressing **◀** on a file will move the focus up to the folder which contains the file. Pressing **c** on a file will move the focus down to the next folder.

Press **ENTER** on a particular folder, then the song select view with the first image in the folder will be displayed. If you press **ENTER** on a particular file, the song select view will display with that file as the first file in the list.

Note: You can use **CHRN** to switch back and forth between the thumbnail and folder views with last memory applied to the location of the focus in the folder tree or playlist.

- 5 Go to “Playing MP3 audio files on the TV”.

Playing MP3 audio files on the TV

- 1 After accessing your MP3 files from your networked PC, the **Audio Player** will begin playing the first MP3 file in the list.

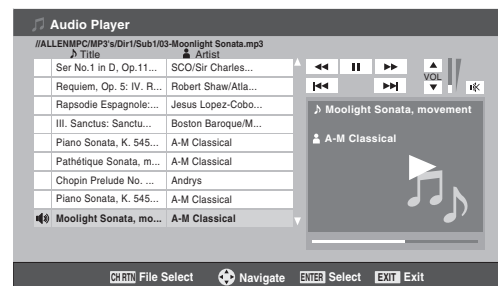

- 2 Press **▲▼◀▶** to navigate to the rewind, pause, fast forward, skip backward, skip forward, volume, and mute buttons—or to select another MP3 file—and then press **ENTER**.

To use the mute function:

To change or mute the playback volume, use **VOL** / **MUTE** on your remote (see page 44 for details on muting the sound) or navigate to the **VOL** and **MUTE** buttons on screen using **▲▼◀▶** on your remote and press **ENTER**.

To close the Audio Player:

Press **EXIT** to close the **Audio Player** and return to the regular TV screen.

Chapter 7: Using the THINC™ home network feature

F. Setting up e-mail scheduling

You can remotely schedule and delete recordings and reminders via e-mail to the TV from any PC.

Note:

- If you have not already done so, follow the instructions in sections A and B (page 59), before proceeding.
- Before you can schedule recordings, the time and date in the TV Guide On Screen feature must be set (“Setting the time and date” on page 28).

Required information and services

Before you can set up the e-mail scheduling feature, you must have the following information and related services:

- A valid POP3 e-mail address dedicated for use by the TV only.

Note: The e-mail address assigned to the TV must be a dedicated POP3 address, different from your personal e-mail address. Assigning your personal e-mail address to the TV will eventually lead to the deletion of all of your personal e-mails (including attachments). This is NOT covered under the Toshiba warranty.

- A personal e-mail address (different from the TV’s dedicated e-mail address) from which you can send e-mails to the TV.
- Login and password settings for the TV’s POP3 e-mail account.
- Name or IP address of the incoming (POP3) mail server.
- Name or IP address of the outgoing (SMTP) mail server.

To obtain the required e-mail services listed above, contact your ISP.

To obtain the required addresses and settings listed above, either contact your ISP or use the configuration utility for your DSL/cable modem or router.

Notes:

- Toshiba is not responsible for any damage or loss caused directly or indirectly by the failure of the e-mail scheduling feature to record content intended to be recorded.
- Toshiba is not responsible for, nor has any control over, any content recorded and/or viewed using the e-mail scheduling feature. Further, the e-mail scheduling feature is not meant to be used for unauthorized recording and/or viewing of copyrighted works.
- The unauthorized recording, use, distribution, or revision of television programs, videotapes, DVDs, and other materials is prohibited under the Copyright Laws of the United States and other countries, and may subject you to civil and criminal liability.

For home network troubleshooting tips, see Chapter 8.

Setting up e-mail scheduling

- Press **MENU** and open the **Setup** menu.
- Highlight **Installation** and press **ENTER**. The **Installation** menu appears.
- Open the **Network** menu.
- Highlight **E-mail Scheduling Setup** and press **ENTER**. The **E-mail Scheduling Setup** window opens.

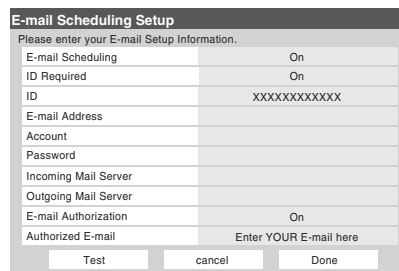

- Enter the required data in the fields. See “Description of fields in the E-mail Scheduling Setup window” (page 71) for details on the settings for these fields.

- For the fields listed below, press **▲** or **▼** to highlight the field, and then press **◀** or **▶** to select **On** or **Off**:
 - **E-mail Scheduling**
 - **ID Required**
 - **E-mail Authorization**
- For the fields listed below, press **▲** or **▼** to highlight the field, press **ENTER** to open the keyboard window for the selected field, and then enter the required information using the on-screen keyboard:
 - **ID**
 - **E-mail Address**
 - **Account**
 - **Password**
 - **Incoming Mail Server**
 - **Outgoing Mail Server**
 - **Authorized E-mail**

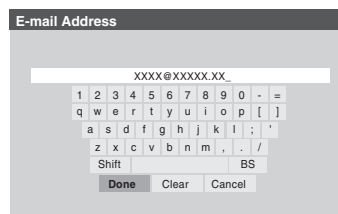

See “USING THE ON-SCREEN KEYBOARD” (page 64) for instructions on entering data in the fields using the on-screen keyboard.

Chapter 7: Using the THINC™ home network feature

- 6 When you are finished entering all characters for the selected field, highlight **Done** and press **ENTER**.

- 7 Highlight **Test** and press **ENTER** to test the e-mail setup. During testing, the TV will display the message “Testing E-mail”.

Note: Depending on your configuration, the e-mail test can take several minutes. Do not press **EXIT** during this time.

- 8 When testing is finished, a message will appear indicating whether the e-mail test passed or not.

If the e-mail test passes:

- a) The “Test Passes” message (shown below) will appear.

- b) Go to step 9.

If the e-mail test does not pass:

- a) An error message and code will appear on-screen (similar to the example below).

Note: The first number in the error code denotes an error that occurs when the TV is receiving an e-mail; the second number denotes an error that occurs when the TV is sending an e-mail.

- b) Locate the error code in the “TESTING E-MAIL” ERROR CODES table (on the next page) and try the solutions.
c) Repeat steps 1–8.

- 9 To exit the **E-mail Scheduling Setup** window and save your settings, highlight **Done** and press **ENTER**.
To exit the **E-mail Scheduling Setup** window without saving your settings, highlight **Cancel** and press **ENTER**.

IMPORTANT NOTE

To use e-mail scheduling, you must first set up the TV Guide On Screen™ system. E-mail scheduling will not be available unless the TV Guide On Screen™ system is fully operational. **See the separate TV Guide On Screen™ Interactive Program Guide for details on setting up the TV Guide On Screen™ system.**

If you experience any issues with e-mail scheduling, please contact Toshiba Consumer Solutions by calling **1-800-631-3811** or by visiting <http://www.tacp.com/customer-support/contact.asp>.

For home network troubleshooting tips, see Chapter 8.

Chapter 7: Using the THINC™ home network feature

“TESTING E-MAIL” ERROR CODES

Code	Description	Solutions
-1	The TV was able to connect to the e-mail server(s) but not log on.	<ul style="list-style-type: none"> • If you receive the message “Error Sending Mail (-1)”, the TV may not have received the test e-mail. Send another test e-mail to the TV using the “HELP request e-mail” format (see page 74). • Make sure the TV Guide On Screen™ system was set up properly. See “IMPORTANT NOTE” on the previous page. • Make sure you entered the correct information for the following fields in the TV’s “E-mail Scheduling Setup” window (confirm this information with your ISP): <ul style="list-style-type: none"> –“Incoming Mail Server” and “Outgoing Mail Server” names (or IP addresses). –“Account” (user name) and “Password” for the TV’s e-mail account. –“E-mail Address” for the TV. • Check with your ISP to make sure your TV’s e-mail account has been activated. • Check with your ISP to make sure their servers support POP3 and SMTP protocols without secure password authentication or secure connections.
28	The TV could not resolve the e-mail server name(s)/address(es).	<ul style="list-style-type: none"> • Make sure you entered the correct information for the following fields in the TV’s “E-mail Scheduling Setup” window (confirm this information with your ISP): <ul style="list-style-type: none"> –“Incoming Mail Server” and “Outgoing Mail Server” names (or IP addresses). –“IP”, “Netmask”, “Gateway”, and “DNS” settings (applicable if you manually set up the network address). • Make sure all cables are connected properly and securely. • Check your router hardware/settings to make sure your Internet service is currently available (especially if the e-mail test takes several minutes to complete).
35	The e-mail server name(s)/address(es) were resolved correctly, but TV could not log on to the servers.	<ul style="list-style-type: none"> • Make sure you entered the correct information for the following fields in the TV’s “E-mail Scheduling Setup”: <ul style="list-style-type: none"> —Username and password. –“Incoming Mail Server” and “Outgoing Mail Server” names (or IP addresses). –“IP”, “Netmask”, “Gateway”, and “DNS” settings (applicable if you manually set up the network address). • Make sure all cables are connected properly and securely. • Check your router hardware/settings to make sure your Internet service is currently available.

Chapter 7: Using the THINC™ home network feature

Description of fields in the “E-mail Scheduling Setup” window

For instructions on entering data in these fields, see step 5 under “Setting up e-mail scheduling” (page 68).

E-mail Scheduling Setup	
Please enter your E-mail Setup Information.	
E-mail Scheduling	On
ID Required	On
ID	XXXXXXXXXXXX
E-mail Address	
Account	
Password	
Incoming Mail Server	
Outgoing Mail Server	
E-mail Authorization	On
Authorized E-mail	Enter YOUR E-mail here
<input type="button" value="Test"/> <input type="button" value="cancel"/> <input type="button" value="Done"/>	

“E-mail Scheduling” field

You can select **On** or **Off** for the **E-mail Scheduling** field.

- **When this field is set to On**, it will be possible for the TV to receive e-mails from any PC to remotely schedule and modify recordings and reminders.
- **When this field is set to Off**, it will not be possible for the TV to receive any e-mail, the other fields in this window will be disabled (“grayed out”), and it will not be possible to remotely schedule recordings or reminders via e-mail.

Also see the “Security settings” table on the next page.

“ID Required” field

You can select **On** or **Off** for the **ID Required** field.

- **When this field is set to On (recommended)**, you must include the ID that you enter in the “ID” field in all e-mails you send to the TV. This is a security feature to protect your TV from unauthorized e-mail access.
- **When this field is set to Off**, you do not need to include the ID in e-mails you send to the TV.

Also see the “Security settings” table on the next page.

“ID” field

Use the on-screen keyboard to enter six to 16 numbers and/or letters to create your ID (spaces and punctuation are **not** allowed).

Also see the “Security settings” table on the next page.

Note:

- To help protect your privacy, you may want to choose an ID that is different from any of your usual passwords or security PINs (e.g., different from your personal e-mail password, banking login code, social security number, etc.).
- The ID is case sensitive.

“E-mail Address” field

Use the on-screen keyboard to enter the TV’s dedicated e-mail address (different from your personal e-mail address). You will send e-mails to this address to add, modify, or delete schedules and reminders.

“Account” field

Use the on-screen keyboard to enter the TV’s e-mail account login. Depending on your ISP, this may be the entire e-mail address or just the characters in the e-mail address before the “@” sign.

“Password” field

Use the on-screen keyboard to enter the password for the TV’s e-mail account.

Note: To help protect your other personal Internet or e-mail accounts, create a password that is significantly different from any of your usual passwords and security PINs (e.g., different from your e-mail password, banking log-ons, social security code etc.).

“Incoming Mail Server” field

Use the on-screen keyboard to enter the incoming (POP3) mail server that hosts the TV’s e-mail account.

Note: The TV does not support encrypted e-mail.

“Outgoing Mail Server” field

Use the on-screen keyboard to enter the outgoing (SMTP) mail server associated with the TV’s e-mail account. (The TV will use this server for sending reply e-mails to your personal e-mail account.)

“E-mail Authorization” field

You can select **On** or **Off** for the “E-mail Authorization” field.

- **When this field is set to On (recommended)**, the TV will only accept e-mails from the e-mail address you specify in the “Authorized E-mail” field (e.g., your personal e-mail address). The TV will delete any e-mails not sent from this authorized e-mail address.

This is a security feature to protect the TV from unauthorized e-mail access and from replying to unwanted e-mail, such as spam.

- **When this field is set to Off**, it will be possible for the TV to accept e-mails from any e-mail address (depending on the other settings in the “E-mail Scheduling Setup” window).

Also see the “Security settings” table on the next page.

“Authorized E-mail” field

Enter the single e-mail address that is authorized to send e-mails to the TV (e.g., your personal e-mail address).

- To enable this field, you must set the “E-mail Authorization” field to **On**.
- This field can be left blank if you have the “E-mail Authorization” field set to **Off**.

Also see the “Security settings” table on the next page.

For home network troubleshooting tips, see Chapter 8.

Chapter 7: Using the THINC™ home network feature

Security settings

(Results of various setting combinations when the “E-mail Scheduling” field is set to ON in the “E-mail Scheduling Setup” window)

Level of security	“E-mail Scheduling” field	“E-mail Authorization” field	“Authorized E-mail” field	“ID Required” field	“ID” field	Result
High* [default settings] (Recommended)	ON	ON	Enter single E-mail address	ON	Enter ID	The TV will only accept e-mails from the one e-mail address specified in the “Authorized E-mail” field that also include the “ID” in the body of the e-mail. All other e-mails received by the TV (except GET and HELP commands) will be deleted.
Medium	ON	ON	Enter single E-mail address	OFF	—	The TV will only accept e-mails from the one e-mail address specified in the “Authorized E-mail” field. All other e-mails received by the TV will be deleted.
Low	ON	OFF	—	ON	Enter ID	The TV will accept e-mails from any e-mail address that includes the “ID” in the body of the e-mail. All other e-mails received by the TV will be deleted.
None (Not recommended)	ON	OFF	—	OFF	—	The TV will accept e-mails from any e-mail address (including unwanted e-mails, such as spam) and will reply to those e-mails with a failure acknowledgment.

* The “High” settings are the default settings. To help prevent the TV from receiving or sending unwanted e-mails (including e-mails that contain information about the programs the TV is set to record), **it is recommended that you not change these settings unless you need to diagnose a problem or deal with a unique user situation.**

Chapter 7: Using the THINC™ home network feature

G. Using e-mail scheduling

You can use the e-mail scheduling feature to schedule and delete recordings and reminders by sending a “request e-mail” to the TV’s e-mail address from any PC.

The four commands the TV will accept are **ADD**, **DELETE**, **GET**, and **HELP**, as described in this section.

If you have not already done so, follow the instructions in sections A and B (☞ page 59), and in section F (☞ page 68), before proceeding.

When a recording is scheduled via e-mail, the recording device used will be the VCR connected to the TV's analog A/V OUT terminals (see item 4 on page 9 for the location of the A/V OUT terminals; see the separate *Installation Guide* for various VCR connection examples).

E-mail parameters

Note: Some e-mail clients automatically insert e-mail signatures, which the TV will try to process. These may generate unwanted error messages.

- The maximum allowable e-mail size is 16 KB. E-mails over 16 KB will be automatically deleted.
- E-mails sent to the TV cannot contain any attachments. The TV will automatically delete any e-mail with an attached file.
- E-mails can be formatted either Plain Text or Rich Text Format (HTML style).
- E-mails sent to the TV that are not properly formatted, are from the wrong e-mail address, or have the wrong ID (if specified) will be deleted.
- All e-mails sent to the TV will be deleted eventually.

Note:

- **Toshiba is not responsible for any damage or loss caused directly or indirectly by the failure of the e-mail scheduling feature to record content intended to be recorded.**
- **Toshiba is not responsible for, nor has any control over, any content recorded and/or viewed using the e-mail scheduling feature. Further, the e-mail scheduling feature is not meant to be used for unauthorized recording and/or viewing of copyrighted works.**
- **The unauthorized recording, use, distribution, or revision of television programs, videotapes, DVDs, and other materials is prohibited under the Copyright Laws of the United States and other countries, and may subject you to civil and criminal liability.**

Sending a request e-mail to the TV

To send a request e-mail to the TV:

- 1** Format the e-mail following according to the instructions under “Formatting a request e-mail” below.
- 2** Send the e-mail to the TV.

- 3** After the TV receives and processes the e-mail, the TV will send a reply e-mail indicating whether the e-mailed request succeeded or failed. See “Receiving an e-mail from the TV” (☞ page 75).

Formatting a request e-mail

Recognized tags

When you send an **ADD**, **DELETE**, **GET**, or **HELP** request e-mail to the TV, the TV will recognize only the tags listed below. These tags (and their accompanying data) must be listed in the body of the request e-mail **in the following order**:

- **ID*** Your ID (required only if you set the “ID Required” field to **On***)
- **COMMAND** **ADD** — or — **DELETE** — or — **GET** — or — **HELP**
- **INPUT** **ANT-1** — or — **ANT-2** — or — **CABLE BOX**
- **CHANNEL** Channel number of the recording or reminder
- **DATE** Date of the recording or reminder
- **START TIME** Start time of the recording or reminder
- **DURATION** Length of time of the recording or reminder
- **TYPE** **RECORD** — or — **REMIND**

* The ID is case sensitive. The ID tag is required only if you created an ID in the “ID” field and set the “ID Required” field to On. If you set the “ID Required” field to Off, you do not need to include the ID tag line in your request e-mail. See “Description of fields in the E-mail Scheduling Setup window” (☞ page 71).

Tag and data formats

The data for each tag can be formatted in various ways, as described in the following table:

Tag formats	Data formats
ID*	[6- to 16-character alphanumeric code] MyID1234 ... MYID1234 ... myid1234
COMMAND CMD	ADD DELETE ... DEL GET HELP
INPUT INP	ANT1 ... ANT-1 ... Antenna-1 ANT2 ... ANT-2 ... Antenna-2 CABLE BOX ... cablebox ... CB SET-TOP BOX ... settopbox ... STB
CHANNEL CH	For cable channels: 4 ... 38 ... 100 For digital channels, use a hyphen: 5-1 ... 102-2
DATE	[If the year is not specified, the current year is assumed.] 7-4 ... 7/23 ... 7-16-05 ... 12/4/05 ... 12/19/2005
STARTTIME START	8am ... 4:45pm ... 8:30AM ... 9PM Noon: 12:00pm ... Midnight: 12:00am

(continued)

Chapter 7: Using the THINC™ home network feature

Tag formats	Data formats
DURATION DUR	15m ... 15min ... 15minutes ... 2h ... 2hr ... 2h15m ... 2hr15min ... 2:15
TYPE	RECORD ... REC ... Rec ... recording REMIND ... REM ... Rem ... reminder

Sample request e-mails

- The examples shown below are for illustration purposes only.
- Styles applied to the sample e-mail text (such as bold, italic, and underline) are for illustration purposes only. The text you use in your request e-mails does not need to be styled.
- The only text in a request e-mail that is case sensitive is the ID. All other text is not case sensitive.

ADD request e-mail

The **ADD** request allows you to schedule a new recording or reminder.

The required tags for an **ADD** request e-mail are (**in this order**):

- ID [This tag is not required if the “ID Required” field is set to **Off**]
- COMMAND ADD
- INPUT
- CHANNEL
- DATE
- START TIME
- DURATION
- TYPE

Sample ADD request e-mail to schedule a new recording:

To: [TV's email address]
Subject: [this can be left blank]

ID MYID1234*
COMMAND ADD
INPUT ANT-1
CHANNEL 102-1
DATE 06/10/2005
START TIME 7 PM
DURATION 2H15M
TYPE RECORD

Sample ADD request e-mail to schedule a new reminder:

To: [TV's email address]
Subject: [this can be left blank]

ID MYID1234*
cmd add
input cb
ch 4
date 7-4
start 8:30pm
dur 1hr
type remind

GET request e-mail

When you send a **GET** request e-mail to the TV, you will receive a reply e-mail that lists all currently scheduled recordings and/or reminders.

The only required tag and data for a **GET** request e-mail is **GET**.

Sample GET request e-mail:

To: [TV's email address]
Subject: [this can be left blank]
GET

DELETE request e-mail

The **DELETE** request allows you to cancel an existing scheduled recording or reminder.

The required tags for a **DELETE** request e-mail are (**in this order**):

- ID [This tag is not required if the “ID Required” field is set to **Off**]
- COMMAND DELETE
- INPUT
- CHANNEL
- DATE
- START TIME
- DURATION
- TYPE

Sample DELETE request e-mail to delete an existing recording:

To: [TV's email address]
Subject: [this can be left blank]

ID MYID1234*
COMMAND DELETE
INPUT ANT-1
CHANNEL 102-1
DATE 06/10/2005
START TIME 7 PM
DURATION 2H15M
TYPE REC

Sample DELETE request e-mail to delete an existing reminder:

To: [TV's email address]
Subject: [this can be left blank]

ID MYID1234*
cmd del
input cb
ch 4
date 7-4
start 8:30pm
dur 1hr
type rem

HELP request e-mail

When you send a **HELP** request e-mail to the TV, you will receive a reply e-mail that contains helpful information about formatting a request e-mail (syntax, definition of the various commands, etc.).

The only required tag for a **HELP** request e-mail is **HELP**.

Sample HELP request e-mail:

To: [TV's email address]
Subject: [this can be left blank]

HELP

* The ID is case sensitive. The ID tag is required only if you created an ID in the “ID” field and set the “ID Required” field to **On**. If you set the “ID Required” field to **Off**, you do not need to include the ID tag line in your request e-mail. See “Description of fields in the E-mail Scheduling Setup window” (page 71).

Chapter 7: Using the THINC™ home network feature

Receiving an e-mail from the TV

If the e-mailed request was successful, the reply e-mail from the TV to your PC will contain one of the following (or similar) messages, depending on the command you sent to the TV:

- ADD SUCCESS
- DELETE SUCCESS
- GET SUCCESS
- HELP SUCCESS

If the e-mailed request was not successful, the reply e-mail from the TV to your PC will contain one of the following (or similar) messages, depending on the command you sent to the TV:

- FAILED – SCHEDULE CONFLICT
The new recording or reminder you attempted to schedule conflicts with an existing one that was previously scheduled. If you want to schedule the new recording or reminder, you will have to **DELETE** the existing one first, and then **ADD** the new one.
- FAILED – COULD NOT UNDERSTAND “Line x”
The e-mailed request has an error in the line of text referenced in the error message. Correct the text and resend the e-mail.
- FAILED – NO DEVICE AVAILABLE
Make sure you have a recording device connected to the TV and that all cables are properly connected.
- FAILED – MISC ERROR
Make sure all devices and cables are properly connected and that the text in the body of your e-mail is correct, and then send the corrected e-mail to the TV.

Modifying an existing recording or reminder

If you want to modify an existing scheduled recording or reminder.

- 1 Send a **DELETE** request e-mail to cancel the existing recording or reminder.
- 2 Send an **ADD** request e-mail to schedule the modified recording or reminder.

For home network troubleshooting tips, see Chapter 8.

Chapter 8: Troubleshooting

General troubleshooting

Before calling a service technician, please check this chapter for a possible cause of the problem and some solutions you can try.

Black box on screen

- The Closed Caption feature is set to one of the Text modes (**T1**, **T2**, **T3**, or **T4**). Set the **Closed Caption** feature to **Off** (see page 43).

TV plays a recorded announcement when LEDs are blinking

- When certain non-standard conditions occur, the LEDs on the TV will blink and the TV will play a recorded “voice announcement” describing the condition (see “LED indications” on page 80 for details).

TV stops responding to controls

- If the TV stops responding to the controls on the remote control or TV control panel and you cannot turn off the TV, press and hold the **POWER** button on the TV control panel for 5 or more seconds to reset the TV.

Other problems

- If your TV’s problem is not addressed in this Troubleshooting section or the recommended solution has not worked, use the Reset Factory Defaults procedure (see page 31).

TV will not turn on

- Make sure the power cord is plugged in, and then press **POWER**.
- The remote control batteries may be dead. Replace the batteries or try the control panel buttons.
- If you have recently replaced the lamp unit, make sure the lamp unit and lamp unit door are installed properly (see pages 81–83).
- The lamp unit may need to be replaced (see pages 81–83). Also see “LED indications” (see page 80).
- If the TV is powered off and then quickly on again when the lamp unit is hot, it may take several minutes for the picture to appear on-screen. This is a property of DLP TV lamp technology and is NOT a sign of malfunction. For details, see IMPORTANT NOTICE ABOUT “HOT LAMP RESTART” (see page 3).

Picture problems

General picture problems

- Check the antenna/cable connections (see *Installation Guide*).
- Press **INPUT** on the remote control or TV and select a valid video input source (see page 32). If no device is connected to a particular input on the TV, no picture will display when you select that particular input source. For device connection details, see the *Installation Guide*.
- Antenna reception may be poor. Use a highly directional outdoor antenna (if applicable).
- The station may have broadcast difficulties. Try another channel.
- Adjust the picture qualities (see page 42).
- If you are using a VCR, make sure **TV/VCR** on the remote control is set correctly (see page 13).
- If you have two VCRs connected to your TV, make sure you have not connected the same VCR to the TV’s output and input connections at the same time (see *Installation Guide*).
- Do not connect both a standard video cable and an S-video cable to the same set of VIDEO inputs (**VIDEO 1**, or **VIDEO 2**) at the same time (see *Installation Guide*).

Noisy picture

- If you are watching an tuned analog channel (off-air broadcast or Cable TV), you can set the **CableClear**® feature to **AUTO** to reduce visible interference in the TV picture (see page 54).

Video Input Selection problems

- If the **Input Selection** window does not appear when you press **INPUT** on the remote control or TV, press **INPUT** a second time, which will change to the next video input source and display the **Input Selection** window.

Cannot view external signals or channel 3 or 4

- If you cannot view signals from external devices connected to **VIDEO 1**, **VIDEO 2**, or **ColorStream**®, or from channels 3 or 4, make sure the **Input Lock** is set to **Off** (see page 50).

Poor color or no color

- The station may have broadcast difficulties. Try another channel.
- Adjust the **Tint** and/or **Color** (see page 42).
- When the **ColorStream**® signal source is active, the **VIDEO OUT** terminal does not output video. To receive video from the **VIDEO OUT** terminal, a standard video or **S-video IN** connection must be used instead of the **ColorStream**® connections.

POP problems

- If you label all of the inputs as “**Hide**,” the POP feature will be disabled. If you then attempt to access the POP feature, the message “Not Available” will appear on-screen (see page 40).

Chapter 8: Troubleshooting

Picture brightness changes soon after turning on TV

- If you set the lamp mode to **Low Power**, each time you turn on the TV, the lamp will start out in **High Bright** mode but will switch to **Low Power** mode after a short period of time. You may notice a change in screen brightness when this happens. This is normal and is not a sign of malfunction (☞ page 55).

Poor composite or S-video picture

- If the TV is connected to an external A/V device (e.g., DVD player, video game system, set-top box, etc.) try using a **ColorStream** or **HDMI** video connection instead.

Picture and sound are out of sync

- As with all products that contain a digital display, in rare instances, when viewing certain content (e.g., television broadcasts, video games, DVDs), you may notice that the sound and picture are slightly out of sync. This phenomenon can be caused by various factors including, without limitation, video processing within the TV, video processing in an attached gaming system, and video processing or different compression rates used by broadcasters in their programming. You may want to try one or more of the following suggestions, which may help to reduce the effect of this phenomenon:
 - If the TV is connected to an A/V receiver that has a programmable audio delay feature, use this feature to help synchronize the sound to the picture.
 - If you notice this phenomenon only on certain TV channels, please contact your local broadcast, cable, or satellite provider to inform them of this issue.

Sound problems

- Check the antenna/cable connections (☞ *Installation Guide*).
- The station may have broadcast difficulties. Try another channel.
- The sound may be muted. Press .
- If you hear no sound, try setting the **MTS** feature to **Stereo** mode (☞ page 45).
- Make sure the Speakers function in the **Audio Setup** menu is set correctly (☞ page 46).
- If you are not receiving a second audio program from a known SAP source, make sure the **MTS** feature is set to **SAP** mode (☞ page 45).
- If you hear audio that seems “incorrect” for the program you are watching (such as music or a foreign language), the SAP mode may be on. Set the **MTS** feature to **Stereo** mode (☞ page 45).
- When using an external audio amplifier, if you connect the amplifier to the **VAR. AUDIO OUT** terminals, the volume of the TV and amplifier must be set above 0 or you will not hear any sound (☞ *Installation Guide*).

Remote control problems

- Make sure the remote control is set to the correct device mode (☞ page 16).
- Remove all obstructions between the remote control and the TV.
- The remote control batteries may be dead. Replace the batteries (☞ page 11).
- Your TV remote control may not operate certain features on your external device. Refer to the owner’s manual for your other device to determine its available features. If your TV remote control does not operate a specific feature on another device, use the remote control that came with the device (☞ page 16).
- If the TV still does not act as expected, use the Reset Factory Defaults procedure (☞ page 31).

Channel tuning problems

- Make sure the remote control is set to the correct device mode (☞ page 16).
- The channel may have been erased from the channel memory by the **Channel Add/Delete** feature. Add the channel to the channel memory (☞ page 27).
- The channel may be blocked by the **Channels Block** feature. Unblock the channel (☞ page 49).
- If you are unable to tune digital channels, check the antenna configuration (☞ page 25). If you are still unable to tune digital channels, clear all channels from the channel list (☞ page 27) and reprogram channels into the channel memory (☞ page 26). If you are still unable to tune digital channels, use the Reset Factory Defaults procedure (☞ page 31). Also see “TV stops responding to controls” and “Other problems” (☞ page 76).

Closed caption problems

- If the program or video you selected is not closed-captioned, no captions will display on-screen (☞ page 43).
- If text is not available, a black rectangle may appear on-screen. If this happens, turn off the closed caption feature (☞ page 43).
- A closed caption signal may not display correctly in the following situations: a) when a videotape has been dubbed; b) when the signal reception is weak; or c) when the signal reception is nonstandard (☞ page 43).

Rating blocking (V-Chip) problems

- If you forget your PIN code: While the PIN code entering screen is displayed, press  four times within 5 seconds. The PIN code you previously stored will be cleared (☞ page 47).
- The V-Chip feature is available for the U.S. V-Chip system only (☞ page 48).

Chapter 8: Troubleshooting

Recording problems

- If you use the TV's remote control to start recording, you will not be able to change inputs (☞ page 32), open the POP window (☞ page 40). If you attempt to do so, the message "Not Available While Recording" will appear on-screen.
- If you are recording a digital channel, you can only change analog channels while recording is in progress. If you are recording an analog channel, you can only change digital channels while the recording is in progress. This is because the TV tuner that is being recorded (digital or analog) will be locked on the channel that is currently recording.
- It is recommended that you use the TV's remote control to start recording. If you use a device other than the TV's remote control to start recording and then attempt to access a feature that is normally denied during recording (POP mode, changing inputs,) the recorded audio and/or video may not be what you intended to record.

Audio Player problems

The Audio Player stutters and/or stops when playing files over the network

- The networked PC is not available, was removed from the network, or is in "hibernation." The Ethernet cables are not connected properly. Check all cables for proper connection.
- Sufficient network band-width is not available. Turn off any other file sharing programs, network-based games, or other network-intensive operations while the **Audio Player** is playing.

"No media found" message is displayed

- Sharing is not correctly set up on the networked PC. Make sure you connected your home network correctly (☞ *Installation Guide*) and set up the network address properly (☞ Chapter 7).
- The MP3 files exceed the specified limits (☞ "Media specifications" in Chapter 7).

Title or artist name is not displayed

- The MP3 file does not contain valid meta-data or does not meet supported specifications (☞ "Media specifications" in Chapter 7).

The Audio Player takes almost a minute to start

- Sufficient network band-width is not available. Turn off any other file sharing programs, network-based games, or other network-intensive operations while the **Audio Player** is playing.
- The shared folder has too many files or sub-folders. If the shared folder on the networked PC contains a large number of files or nested directories, it may take over a minute for the **Audio Player** to locate all playable files.

The File is displayed but is always skipped

- The file is not a valid or supported MP3 file.

Some files in the shared folder are not played

- Only the first 200 MP3 files found will be played. Folders nested 10 or more levels below the shared folder are not searched.

The Audio Player plays (progress bar and animation change) but audio is not heard

- The volume level is not high enough or TV is muted.

Picture Viewer problems

"No pictures found" message is displayed.

- Sharing is not correctly set up on the networked PC. Make sure you connected your home network correctly (☞ *Installation Guide*) and set up the network address properly (☞ Chapter 7).
- The JPEG files exceed the specified limits (☞ "Media specifications" in Chapter 7).

Picture viewer option in menu is disabled.

- There are no picture files in the networked PC's shared folder(s).
- Basic network setup and Home server setup were not successfully performed.

Picture is not displayed. Rectangle containing "X" is displayed instead.

- The picture file does not meet the specifications for the **Picture Viewer** (☞ "Media specifications" in Chapter 7).

Picture is not listed at all.

- There are no picture files in the networked PC's shared folder(s).
- The number of pictures files found is more than the TV can display.
- The picture file does not have a valid ".jpg" extension.
- The file is too large or is otherwise not compatible with the TV for display. See "Media specifications" in Chapter 7 for Picture Viewer and JPEG file specifications.

Home network troubleshooting

Basic network setup problems

Cannot connect to network

- Check the modem and splitter connections.
- Make sure the splitter is connected to the modem or TEL correctly (☞ page 59).
- Confirm your modem's operation with this manual.
- Make sure your network address and e-mail account are set up correctly (☞ Chapter 7).

No network connection

- The Ethernet cables are not connected properly or at all. Connect all cables (☞ *Install Guide*).
- Make sure the modem's power cord is plugged in.
- Make sure your network address and e-mail account are set up correctly (☞ Chapter 7).

Chapter 8: Troubleshooting

Automatic setup fails

- The Ethernet cables are not connected properly or at all. Connect all cables (☞ *Installation*).
- The DHCP service is not enabled on the router, or no router is present. Refer to your router's documentation for instructions on enabling DHCP. If you do not have a router, you must manually set up the network address (☞ page 60).
- Internet service is not available. Check your cable/DSL modem or contact your ISP for Internet service issues.

Manual setup fails

- The Ethernet cables are not connected properly or at all. Connect all cables (☞ *Installation*).
- The TV IP address is the same as the networked PC's. The TV IP address must be different from the PC's IP address.
- The TV IP address is not on the same subnet as the networked PC's. For example, if the PC has IP 192.168.0.100 with netmask 255.255.255.0, and the TV has IP 192.168.0.200 with netmask 255.255.255.0, then they are both on same subnet. Conversely, if the PC has IP 192.168.1.100 with netmask 255.255.255.0, and the TV has IP 192.168.0.200 with netmask 255.255.255.0, then they are on DIFFERENT sub-nets.

Unstable network connection

- Unplug the Ethernet cables, and then connect them again.

Home server setup problems

The PC ("Home Server") name is not displayed

- The Ethernet cables are not connected properly or at all. Connect all cables (☞ *Install Guide*).
- The network setup on the PC is incorrect. Make sure both the PC and TV are using the same network type (DHCP/manual) and have compatible network settings.
- The networked PC does not have shared folders set up correctly. See "Set up file sharing on your PC" in Chapter 7 for details.
- There are no master browsers on the network. To configure your networked PC to be the master browser of its subnet, refer to your operating system user guide or consult an IT professional.
- Too many sharing devices are connected. You cannot connect more than 16 sharing devices at one time.

The PC ("Home Server") name is displayed but the shared folder(s) are not displayed.

- The networked PC does not have shared folders set up correctly. See "Set up file sharing on your PC" in Chapter 7 for details.
- The TV's user name and password do not match the PC's. Make sure the user name and password settings in the TV exactly match the settings in the networked PC. User names and passwords are generally case sensitive.

E-mail scheduling problems

Cannot schedule a recording by e-mail

- Select "Test" to confirm the e-mail scheduling setup (☞ page 69).
- Select "Done" after setting up e-mail scheduling (☞ page 69).
- See Chapter 7 in this manual.

E-mail test fails after waiting a long time

- The Ethernet cables are not connected properly or at all. Connect all cables (☞ *Installation*).
- The DNS (domain name server) is not set up correctly. Check the network settings.
- The SMTP and POP3 server settings are incorrect.
- The "E-mail Address," "Account," or "Password" settings are incorrect. User names and passwords are generally case sensitive.

Receiving succeeds but sending fails, or vice-versa

- The SMTP and POP3 server settings are incorrect.
- The "E-mail Address," "Account," or "Password" settings are incorrect. User names and passwords are generally case sensitive.
- Your Internet service provider may not support SMTP or POP3 protocols. Check with your ISP for details on supported protocols.

The e-mail test passes, but the TV never responds to the e-mails

- Email scheduling is turned OFF. Turn e-mail scheduling ON (page 68).
- The sender's e-mail address is not the "Authorized E-mail Address." Make sure the e-mail address you are using to send e-mails to the TV is the same as the "Authorized E-mail Address" in the TV's e-mail scheduling setup. See "Set up e-mail scheduling" in Chapter 7.

Note: Responses from the TV can often be delayed a few minutes, depending on e-mail/Internet service availability when you send the request e-mail.

An ADD or DELETE request e-mail returns an "INVALID MAIL VERIFICATION ID" reply

- The e-mail authorization ID is not specified or is different from the TV settings. See "Set up e-mail scheduling" in Chapter 7.

The e-mail was successfully sent but the recording or reminder did not work.

- See "Setting the time and date" on page 28.

Chapter 8: Troubleshooting

LED indications

The yellow, blue, and red/green LED lights on the TV (at the bottom center of the TV) indicate the TV's status, as described below.

Note: If the TV loses A/C power (e.g., a power outage occurs or the power cord is unplugged), when power is restored, the yellow LED will blink while the TV is booting until the remote control is usable. This is normal and is not a sign of malfunction.

TV front

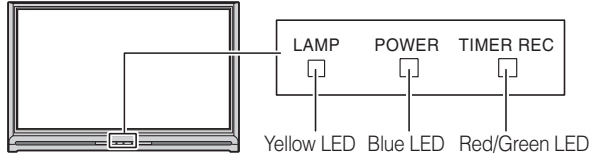

“Voice announce” feature

When certain non-standard conditions occur, the LEDs on the TV will blink and the TV will play a recorded “voice announcement” describing the condition (see the table below for the specific conditions that include a voice announcement).

To repeat the voice announcement and hear additional information, press the MENU button on the TV while the LEDs are blinking.

LED Indication	Condition	Solution	Voice Announce
1) Blue is ON (solid).	The TV is operating properly.	–	–
2) Yellow blinks.	In LPS mode (standby with Quick Restart ON).	See “Setting the Quick Restart™ feature” (page 30).	–
3) Blue is ON (solid). Yellow blinks.	The lamp is not working properly.	The TV will automatically try to restart itself eight times (see item #4). Note: If the TV is powered off and then quickly on again when the lamp unit is hot, it may take several minutes for the picture to appear on-screen. This is a property of DLP TV lamp technology and is NOT a sign of malfunction. For details, see “Setting the Quick Restart™ feature” and “IMPORTANT NOTICE ABOUT HOT LAMP RESTART” (page 30).	–
4) Yellow is ON (solid). Red blinks.	The lamp is not working properly after the eighth automatic restart (see item #3).	Turn the TV OFF and then ON again. If the problem persists, contact Consumer Solutions at 1-800-631-3811.	“Lamp not working”
5) Yellow is ON (solid).	The lamp unit door is not seated properly.	Turn OFF the TV and unplug the power cord. Review “Lamp unit replacement and care” in Chapter 8 to ensure that the lamp door is installed securely.	“Lamp door is open.”
6) Red blinks.	Fan stopped (light engine).	Turn OFF the TV and unplug the power cord. Plug the power cord in again and turn ON the TV.	“Fan stopped.”
7) Blue is ON (solid). Green blinks.	Fan stopped (POD).		“Fan stopped.”
8) Blue blinks slowly.	Abnormal operation of BUS line.		–
9) Blue blinks quickly.	Power Protect Detection.		–
10) Blue blinks quickly. Red blinks.	The color wheel has stopped.		“Color wheel stopped.”
11) Blue blinks quickly. Yellow blinks. Red blinks.	An abnormal temperature increase has occurred.	Turn OFF the TV. Check to make sure none of the slots or openings in the TV cabinet are covered, blocked, or dusty. Turn ON the TV again.	“Temperature warning.”

If, after trying the solution, the problem still exists:

- In the U.S., call TACP Consumer Solutions at 1-800-631-3811.
- In Canada, locate the nearest Toshiba authorized service depot by directing your web browser to www.toshiba.ca; click “Home Entertainment,” and then click “Support.”

Chapter 9: Appendix

Lamp unit replacement and care

Replacing the lamp unit (User-replaceable component)



WARNING: RISK OF ELECTRIC SHOCK!



TO REDUCE THE RISK OF ELECTRIC SHOCK, NEVER REMOVE TV COVERS, EXCEPT AS SPECIFIED HEREIN. REFER ALL SERVICING NOT SPECIFIED IN THIS MANUAL TO QUALIFIED SERVICE PERSONNEL. Failure to follow this WARNING may result in death or serious injury.

The light source for this TV is a mercury lamp with internal atmospheric pressure that increases during use. The lamp has a limited service life that varies depending on product use and user settings.

As is generally the case with all projection TVs that use projection lamps as a light source, the brightness of the lamp in this TV may vary somewhat over the expected service life and will generally decrease over time. Because of the many variables that can affect the useful service life of the lamp, your experience may vary from other users.

Note : *The lamp is warranted only for the periods and to the extent set forth in the Limited Warranty applicable to this set. See "Limited United States Warranty" (page 85) or "Limited Canada Warranty" (page 86), as applicable.*

If you use the lamp beyond its service life:

- you may notice a reduction in the colors and/or brightness of the picture; and
- the strength of the quartz glass in the lamp will be reduced and the lamp may rupture (often making a loud noise when this happens). If the lamp ruptures, the TV will not operate until the lamp unit is replaced.



CAUTION: Always handle the lamp unit with care.

The lamp unit in this TV was designed for safe replacement by consumers; however, if the lamp unit is subjected to intentional abuse (such as excessive mechanical abuse or handling by children or pets), the unit may break, exposing sharp edges or pinch points.

When to replace the lamp unit

You should replace the lamp unit:

- if the picture darkens and/or colors fade;
- if the screen (lamp) does not light (**LED indication #4**, page 80); or
- if you hear a loud noise and the picture goes black, which may indicate a lamp rupture (**LED indication #4**, page 80).

To obtain a replacement lamp unit:

In the U.S.

In warranty: Visit www.tacp.toshiba.com/service or call toll-free 1-800-631-3811.

Out of warranty: Visit www.ceaccessories.toshiba.com or consult your consumer electronics dealer.

In Canada

Locate a Toshiba parts distributor by visiting www.toshiba.ca. Click "Home Entertainment" and then click "Support."

Always replace the lamp unit with the model currently recommended by Toshiba.

The correct lamp replacement part number is located on the serial number label on the back of the television and on the lamp unit.

For more information, please contact us at the telephone numbers or websites listed above, as applicable.

Using any lamp other than those recommended by Toshiba may cause damage to the TV and/or lamp. SUCH DAMAGE IS NOT COVERED UNDER YOUR TOSHIBA WARRANTY.

Chapter 9: Appendix

How to replace the lamp unit



WARNING: RISK OF ELECTRIC SHOCK!



TO REDUCE THE RISK OF ELECTRIC SHOCK, NEVER REMOVE TV COVERS, EXCEPT AS SPECIFIED HEREIN. REFER ALL SERVICING NOT SPECIFIED IN THIS MANUAL TO QUALIFIED SERVICE PERSONNEL. Failure to follow this WARNING may result in death or serious injury.

Required tools:

- Manual screwdrivers (Phillips and slotted)
- Soft, lint-free gloves

- 1 Turn off the TV and unplug the power cord.



WARNING: Eye damage may result from directly viewing the light produced by this lamp.

Always turn off the TV and unplug the power cord before opening the lamp unit door.

- 2 **STOP!** Allow the lamp to cool for at least one (1) hour before replacing it.



CAUTION: HOT SURFACE!



Touching the lamp before it has cooled will result in severe burns. ALLOW THE LAMP TO COOL FOR AT LEAST ONE (1) HOUR BEFORE REPLACING IT.

- 3 On the lamp unit door on the back of the TV, loosen the screw using a manual screwdriver, and then remove the lamp unit door.

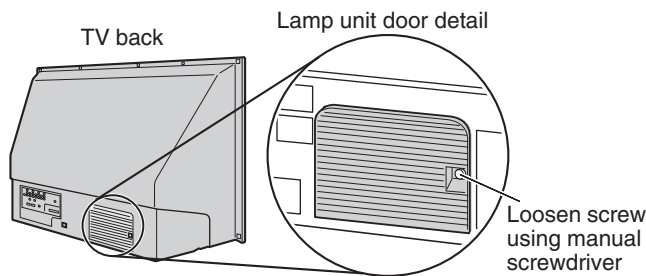

- 4 Using a manual Phillips screwdriver, loosen the two screws on the lamp unit.

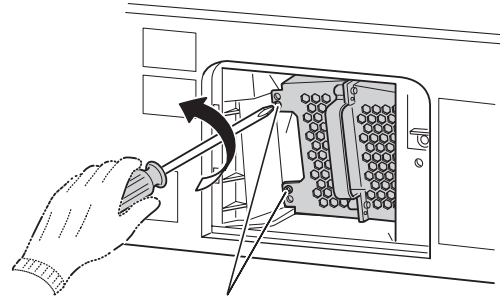

Lamp unit screws



WARNING: RISK OF ELECTRIC SHOCK!



The lamp unit door is provided with an interlock to reduce the risk of electric shock and excessive ultraviolet radiation. **Never defeat its purpose or attempt to service without removing the lamp unit door completely.** Failure to follow this WARNING may result in death or serious injury.

- 5 Grasp the lamp unit handle and gently pull the lamp unit straight out of the TV. Set the old lamp unit aside (see "Disposing of the used lamp unit" on page 83).

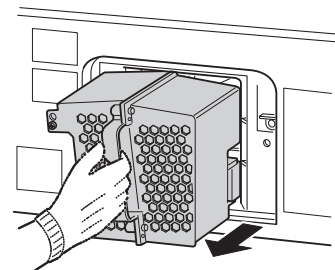

NOTE: Wear soft, lint-free gloves when replacing the lamp unit.

- 6 Carefully insert the new lamp unit straight into the TV until it is fully seated.

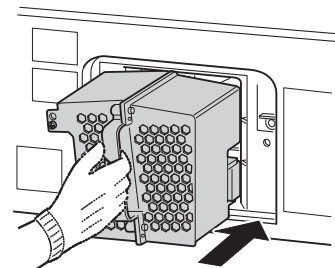

Chapter 9: Appendix

Note:

- Never subject the lamp unit to excessive shock.
- Never touch the lamp unit glass or otherwise get it dirty. Doing so may affect the image quality and reduce the service life of the lamp. See "Cleaning the lamp unit glass" below.

CLEANING THE LAMP UNIT GLASS

If you accidentally touch the lamp unit glass or otherwise get it dirty, wipe it with a lint-free lens cleaning cloth (such as a cloth for cleaning camera lenses or eyeglasses).



CAUTION: NEVER clean a hot lamp with any type of flammable liquid or aerosol cleaning agent. Many ordinary cleaning agents (such as glass cleaners) contain chemicals that may be flammable at certain temperatures. If the lamp unit is not allowed to cool for at least one (1) hour, such chemicals may ignite.

- 7** Using a manual Phillips screwdriver, tighten the two lamp unit screws.

Note: Hand-tighten only. Do not use an electric screwdriver.

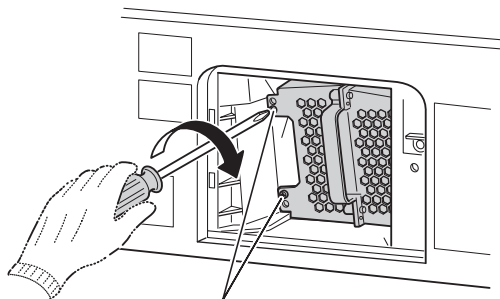

Lamp unit screws
(use manual Phillips screwdriver only)



NOTE : Make sure the lamp unit and screws are installed securely; otherwise, the TV may not turn on and the lamp life may be shortened.

- 8** Reattach the lamp unit door, making sure to insert the hooks on the left side of the lamp unit door inside the opening in the TV cabinet.

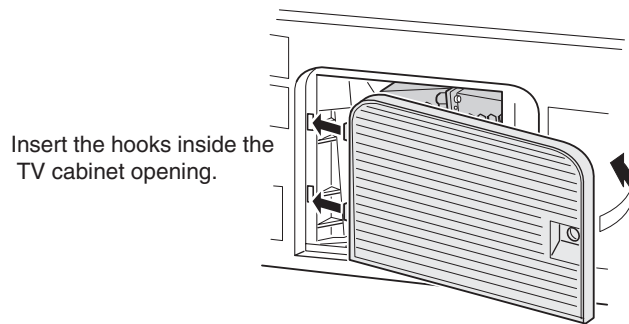

Insert the hooks inside the TV cabinet opening.

Lamp unit door

- 9** Replace the screw and tighten using a manual screwdriver.

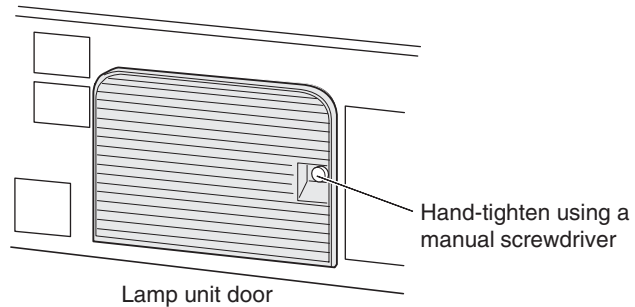

Lamp unit door



NOTE: Make sure the lamp unit door is installed securely; otherwise, the TV may not turn on.

- 10** Plug in the power cord and turn on the TV. After the initial warmup period (which may take several seconds for full picture brightness), the TV should operate normally. If any of the following conditions exist, turn off the TV, unplug the power cord, and repeat steps 1–9 to ensure that the lamp unit and lamp unit door are installed correctly:

- No picture
- Dark picture
- TV will not turn on

If, after repeating steps 1–9, the problem still exists:

- In the U.S., call TACP Consumer Solutions at 1-800-631-3811.
- In Canada, locate the nearest Toshiba authorized service depot by directing your web browser to www.toshiba.ca; click "Home Entertainment," and then click "Support."

Disposing of the used lamp unit

- Place the used lamp unit in the empty box from the new unit.
- Keep the lamp unit out of reach of children and pets.



CAUTION: Always handle the lamp unit with care.

The lamp unit in this TV was designed for safe replacement by consumers; however, if the lamp unit is subjected to intentional or accidental abuse (such as excessive mechanical abuse or handling by children or pets), the unit may break, exposing sharp edges or pinch points.

- Dispose of the used lamp unit by the approved method for your area.



NOTE: The lamp unit contains mercury. Disposal of mercury may be regulated due to environmental considerations. For disposal or recycling information, contact your local authorities or the Electronic Industries Alliance (www.eiae.org).

Chapter 9: Appendix

Specifications

Note:

- **This model complies with the specifications listed below.**
- **Designs and specifications are subject to change without notice.**
- **This model may not be compatible with features and/or specifications that may be added in the future.**

Television System

NTSC standard
 ATSC standard (8VSB)
 Digital Cable (64 QAM, 256 QAM; in-the-clear, unencrypted*)

Channel Coverage

VHF: 2 through 13
 UHF: 14 through 69
 Cable TV: Mid band (A-8 through A-1, A through I)
 Super band (J through W)
 Hyper band (AA through ZZ, AAA, BBB)
 Ultra band (65 through 94, 100 through 135)

Power Source

120 V AC, 60 Hz

Power Consumption

215 W (average)
 28 W in standby mode (using a CableCARD™)
 24 W in standby mode (without a CableCARD™)

Audio Power

10 W + 10 W

Speaker Type

Main: Two 2-3/8 × 4-3/4 inches (6×12 cm) round
 Tweeter: Two 1-5/16 inches (33 mm) round

Video/Audio Terminals

S-VIDEO INPUT:

Y: 1 V(p-p), 75 ohm, negative sync.
 C: 0.286 V(p-p) (burst signal), 75 ohm

VIDEO/AUDIO INPUT:

VIDEO: 1 V(p-p), 75 ohm, negative sync.
 AUDIO: 150 mV(rms) (30% modulation equivalent, 22 k ohm or greater)

ColorStream® (component video) HD INPUT:

VIDEO: Y: 1V(p-p), 75 ohm
 PR: 0.7 V(p-p), 75 ohm
 PB: 0.7 V(p-p), 75 ohm
 Suggested formats: 1080i, 480p, 480i, 720p
 AUDIO: 150 mV(rms), 22 k ohm or greater

HDMI™ INPUT:

HDMI compliant (type A connector)
 HDCP compliant
 E-EDID** compliant
 Suggested formats: 1080i, 480p, 480i, 720p
 HDMI Audio: 2-channel L-PCM; 32/44.1/48 kHz sampling frequency; 16/20/24 bits per sample and Dolby Digital

VIDEO/AUDIO OUTPUT (also for recording):

VIDEO: 1 V(p-p), 75 ohm, negative sync.
 AUDIO: 150 mV(rms) (30% modulation equivalent, 2.2 k ohm or less)

VARIABLE AUDIO OUTPUT:

0–300 mV(rms) (30% modulation equivalent, 2.2 k ohm or less)

DIGITAL AUDIO OUTPUT:

Optical type

G-LINK™:

3 V(p-p), 3.5 mm mono socket (IR blaster cables supplied)

PC IN:

Mini D-sub 15 pin Analog RGB

PC AUDIO IN:

150 mV(rms), 22 k ohm or greater

RJ-45 port:

Standard Ethernet (RJ-45)

Dimensions

50HMX96: Width: 47-3/16 inches (1,199 mm)
 Height: 30-11/16 inches (780 mm)
 Depth: 16-5/8 inches (422 mm)
 56HMX96: Width: 52-3/8 inches (1,330 mm)
 Height: 33-3/4 inches (857 mm)
 Depth: 18-3/8 inches (467 mm)

Weight

50HMX96: 63.9 lbs (29.0 kg)
 56HMX96: 72.1 lbs (32.7 kg)

Operating conditions

Temperature: 41°F–95°F (5°C–35°C)
 Humidity: 20–80% (no moisture condition)

Supplied Accessories

- Remote control with two size “AA” alkaline batteries
- Dual-wand IR blaster cable
- Installation Guide
- Operating Guide (this book)
- TV Guide On Screen™ Interactive Program Guide

Optional Stands

50HMX96: ST 5076
 56HMX96: ST 5676

* Encrypted channels can be viewed on this TV using a CableCARD.™ (see *Installation Guide*).

** E-EDID = Enhanced-Extended Display Identification

Chapter 9: Appendix

Limited United States Warranty

for DLP™ Television Models

Toshiba America Consumer Products, L.L.C. ("TACP") makes the following limited warranties to original consumers in the United States.

THESE LIMITED WARRANTIES EXTEND TO THE ORIGINAL CONSUMER PURCHASER OR ANY PERSON RECEIVING THIS DLP™ TELEVISION AS A GIFT FROM THE ORIGINAL CONSUMER PURCHASER AND TO NO OTHER PURCHASER OR TRANSFEREE.

DLP™ TELEVISIONS PURCHASED IN THE U.S.A. AND USED ANYWHERE OUTSIDE OF THE U.S.A., INCLUDING, WITHOUT LIMITATION, CANADA AND MEXICO, ARE NOT COVERED BY THESE WARRANTIES.

DLP™ TELEVISIONS PURCHASED ANYWHERE OUTSIDE OF THE U.S.A., INCLUDING, WITHOUT LIMITATION, CANADA AND MEXICO, AND USED IN THE U.S.A., ARE NOT COVERED BY THESE WARRANTIES.

Limited One (1) Year Warranty on Parts and Labor

TACP warrants this DLP™ Television and its parts against defects in materials or workmanship for a period of one (1) year after the date of original retail purchase. **DURING THIS PERIOD, TACP WILL, AT TACP'S OPTION, REPAIR OR REPLACE A DEFECTIVE PART WITH A NEW OR REFURBISHED PART WITHOUT CHARGE TO YOU FOR PARTS OR LABOR.** During this period, TACP Authorized Service Station personnel will come to your home when warranty service is required. Depending on the type of repair required, the service will either be performed in your home or the DLP™ Television will be taken to a TACP Authorized Service Station for repair and returned to your home at no cost to you.

Limited One (1) Year Warranty on Lamp Unit

TACP warrants the original lamp unit contained in this DLP™ Television against defects in materials or workmanship for a period of one (1) year after the date of original retail purchase. **DURING THIS PERIOD, TACP WILL, AT TACP'S OPTION, EXCHANGE A DEFECTIVE LAMP UNIT WITH A NEW OR REFURBISHED LAMP UNIT WITHOUT CHARGE TO YOU. LABOR CHARGES FOR LAMP UNIT REPLACEMENT ARE YOUR RESPONSIBILITY AND ARE NOT COVERED UNDER THIS WARRANTY.** The lamp unit is a user-replaceable component.

Rental Units

The warranty for DLP™ Television rental units begins on the date of the first rental or thirty (30) days after the date of shipment to the rental firm, whichever comes first.

Limited Warranty for Commercial Units

TACP warrants DLP™ Televisions, including the lamp units contained therein, that are sold and used for commercial purposes as follows: all parts are warranted against defects in materials or workmanship for a period of ninety (90) days after the date of original retail purchase. **DURING THIS PERIOD, TACP WILL, AT TACP'S OPTION, REPAIR OR REPLACE A DEFECTIVE PART WITH A NEW OR REFURBISHED PART WITHOUT CHARGE TO YOU.**

Owner's Manual and Product Registration

Read this owner's manual thoroughly before operating this DLP™ television.

Complete and mail the enclosed product registration card or register your DLP™ Television online at www.tacp.toshiba.com/service as soon as possible. By registering your DLP™ Television you will enable TACP to bring you new products specifically designed to meet your needs and help us to contact you in the unlikely event a safety notification is required under the Consumer Product Safety Act. Failure to register your product does not diminish your warranty rights.

Your Responsibility

THE ABOVE WARRANTIES ARE SUBJECT TO THE FOLLOWING CONDITIONS:

- (1) You must retain your original bill of sale or provide other proof of purchase.
- (2) All warranty servicing of this DLP™ Television must be performed by an Authorized TACP Service Station.
- (3) The warranties from TACP are effective only if this DLP™ Television is purchased and operated in the Continental U.S.A. or Puerto Rico.
- (4) Labor service charges for set installation, setup, adjustment of customer controls, and installation or repair of antenna systems are not covered by this warranty. Reception problems caused by inadequate antenna systems, misaligned satellite dishes, cable television distribution, VCRs, DVD players/recorders, personal computer level IEEE1394 devices, and any other connected signal source device are your responsibility.
- (5) Warranties extend only to defects in materials or workmanship as limited above, and do not extend to any DLP™ Television or parts that have been lost or discarded by you or to damage to the DLP™ Television or parts caused by fires, misuse, accident, Acts of God (such as lightning or fluctuations in electric power), improper installation, improper maintenance, or use in violation of instructions furnished by TACP; use or malfunction through simultaneous use of this DLP™ Television and connected equipment; or to units that have been modified or had the serial number removed, altered, defaced, or rendered illegible.

How to Obtain Warranty Service

If, after following all of the operating instructions in this manual and reviewing the section titled "Troubleshooting," you find that service is needed:

- (1) To find the nearest TACP Authorized Service Station, visit TACP's website at www.tacp.toshiba.com/service or contact TACP's Consumer Solution Center toll free at 1-800-631-3811.
- (2) You must present your original bill of sale or other proof of purchase to the TACP Authorized Service Station.

**For additional information, visit TACP's web site:
www.tacp.toshiba.com.**

ALL WARRANTIES IMPLIED BY THE LAW OF ANY STATE OF THE U.S.A., INCLUDING THE IMPLIED WARRANTIES OF MERCHANTABILITY AND FITNESS FOR A PARTICULAR PURPOSE, ARE EXPRESSLY LIMITED TO THE DURATION OF THE LIMITED WARRANTIES SET FORTH ABOVE. WITH THE EXCEPTION OF ANY WARRANTIES IMPLIED BY THE LAW OF ANY STATE OF THE U.S.A. AS HEREBY LIMITED, THE FOREGOING WARRANTY IS EXCLUSIVE AND IN LIEU OF ALL OTHER WARRANTIES, GUARANTEES, AGREEMENTS, AND SIMILAR OBLIGATIONS OF TACP WITH RESPECT TO THE REPAIR OR REPLACEMENT OF ANY PARTS. IN NO EVENT SHALL TACP BE LIABLE FOR CONSEQUENTIAL OR INCIDENTAL DAMAGES (INCLUDING, BUT NOT LIMITED TO, LOST PROFITS, BUSINESS INTERRUPTION, OR MODIFICATION OR ERASURE OF RECORDED DATA CAUSED BY USE, MISUSE OR INABILITY TO USE THIS DLP™ TELEVISION).

No person, agent, distributor, dealer, or company is authorized to change, modify, or extend the terms of these warranties in any manner whatsoever. The time within which an action must be commenced to enforce any obligation of TACP arising under the warranty or under any statute or law of the United States or any state thereof is hereby limited to ninety (90) days from the date you discover, or should have discovered, the defect. This limitation does not apply to implied warranties arising under the law of any state of the U.S.A.

THIS WARRANTY GIVES YOU SPECIFIC LEGAL RIGHTS AND YOU MAY ALSO HAVE OTHER RIGHTS WHICH MAY VARY FROM STATE TO STATE IN THE U.S.A. SOME STATES OF THE U.S.A. DO NOT ALLOW LIMITATIONS ON THE DURATION OF AN IMPLIED WARRANTY, WHEN AN ACTION MAY BE BROUGHT, OR THE EXCLUSION OR LIMITATION OF INCIDENTAL OR CONSEQUENTIAL DAMAGES. THEREFORE, THE ABOVE PROVISIONS MAY NOT APPLY TO YOU UNDER SUCH CIRCUMSTANCES.

05

Chapter 9: Appendix

Limited Canada Warranty

for DLP™ Television Models

Toshiba of Canada Limited ("TCL") makes the following limited warranties to original consumers in Canada.

THESE LIMITED WARRANTIES EXTEND TO THE ORIGINAL CONSUMER PURCHASER OR ANY PERSON RECEIVING THIS DLP™ TELEVISION AS A GIFT FROM THE ORIGINAL CONSUMER PURCHASER AND TO NO OTHER PURCHASER OR TRANSFEREE. PRODUCTS PURCHASED IN THE U.S.A. AND USED IN CANADA ARE NOT COVERED BY THESE WARRANTIES. PRODUCTS PURCHASED IN CANADA AND USED IN THE U.S.A. ARE NOT COVERED BY THESE WARRANTIES.

Limited One (1) Year Warranty on Parts and Labor*

TCL warrants this DLP™ television and its parts against defects in materials or workmanship for a period of one (1) year after the date of original retail purchase. DURING THIS PERIOD, TCL WILL, AT TCL'S OPTION, REPAIR OR REPLACE A DEFECTIVE PART WITH A NEW OR REFURBISHED PART WITHOUT CHARGE TO YOU FOR PARTS OR LABOR. TCL Authorized Service Depot personnel will come to your home when warranty service is required. Depending on the type of repair required, either the service will be performed in your home or the set will be taken to the TCL Authorized Service Depot for repair and returned to your home at no cost to you. IN-HOME SERVICE ONLY APPLIES WITHIN 100 KILOMETERS OF AN AUTHORIZED TCL SERVICE DEPOT.

Limited One (1) Year Warranty on Lamp Unit*

TCL warrants the lamp unit in this DLP™ television against defects in materials or workmanship for a period of one (1) year after the date of original retail purchase. DURING THIS PERIOD, TCL WILL, AT TCL'S OPTION, EXCHANGE A DEFECTIVE LAMP UNIT WITH A NEW OR REFURBISHED LAMP UNIT WITHOUT CHARGE TO YOU. LABOR CHARGES FOR LAMP UNIT REPLACEMENT ARE NOT COVERED UNDER WARRANTY. The lamp unit is a user-replaceable component.

Rental Units

The warranty for rental units, including the lamp units contained therein, begins with the date of first rental or thirty (30) days from the date of shipment to the rental firm, whichever comes first.

*Limited Warranty for Commercial Units

TCL warrants DLP™ televisions, including the lamp units contained therein, sold and used for commercial purposes as follows: all parts are warranted against defects in materials or workmanship for a period of ninety (90) days after the date of original purchase. DURING THIS PERIOD, TCL WILL, AT TCL'S OPTION, REPAIR OR REPLACE A DEFECTIVE PART WITH A NEW OR REFURBISHED PART WITHOUT CHARGE TO YOU. ON-SITE SERVICE ONLY APPLIES WITHIN 100 KILOMETERS OF AN AUTHORIZED TCL SERVICE DEPOT.

Owner's Manual and Product Registration

Read this owner's manual thoroughly before operating this DLP™ television.

Register your product online at www.toshiba.ca as soon as possible. By registering your product you will enable TCL bring you new products specifically designed to meet your needs and help us to contact you in the unlikely event a safety notification is required under the Consumer Product Safety Act. Failure to register your product does not diminish your warranty rights.

Your Responsibility

THE ABOVE WARRANTIES ARE SUBJECT TO THE FOLLOWING CONDITIONS:

- (1) You must provide your bill of sale or other proof of purchase.
- (2) All warranty servicing of this DLP™ television must be performed by an Authorized TCL Service Depot.
- (3) These warranties from TCL are effective only if the DLP™ television is purchased in Canada from an authorized TCL dealer and operated in Canada.
- (4) Labor charges for installation, setup, adjustment of customer controls, and installation or repair of antenna systems are not covered by these warranties. Reception problems caused by inadequate antenna systems are your responsibility.
- (5) Warranties extend only to defects in materials or workmanship as limited above, and do not extend to any DLP™ television or parts that have been lost or discarded by you or to damage to the television or parts caused by fires, misuse, accident, Acts of God (such as lightning or fluctuations in electric power), improper installation, improper maintenance, or use in violation of instructions furnished by TCL; use or malfunction through simultaneous use of this product and connected equipment; or to units that have been modified or had the serial number removed, altered, defaced, or rendered illegible.

How to Obtain Warranty Services

If, after following all of the operating instructions in this manual and checking the "Troubleshooting" section, you find that service is needed:

- (1) To find the nearest TCL Authorized Service Depot, visit TCL's web site at www.toshiba.ca.
- (2) Present your bill of sale or other proof of purchase to the Authorized Service Depot.

**For additional information, visit TCL's web site:
www.toshiba.ca**

ALL WARRANTIES IMPLIED BY THE LAW OF ANY PROVINCE OF CANADA, INCLUDING THE IMPLIED WARRANTIES OF MERCHANTABILITY AND FITNESS FOR A PARTICULAR PURPOSE, ARE EXPRESSLY LIMITED TO THE DURATION OF THE LIMITED WARRANTIES SET FORTH ABOVE. WITH THE EXCEPTION OF ANY WARRANTIES IMPLIED BY THE LAW OF ANY PROVINCE OF CANADA AS HEREBY LIMITED, THE FOREGOING WARRANTY IS EXCLUSIVE AND IN LIEU OF ALL OTHER WARRANTIES, GUARANTEES, AGREEMENTS, AND SIMILAR OBLIGATIONS OF TCL WITH RESPECT TO THE REPAIR OR REPLACEMENT OF ANY PARTS. IN NO EVENT SHALL TCL BE LIABLE FOR CONSEQUENTIAL OR INCIDENTAL DAMAGES (INCLUDING, BUT NOT LIMITED TO, LOST PROFITS, BUSINESS INTERRUPTION, OR MODIFICATION OR ERASURE OF RECORDED DATA CAUSED BY USE, MISUSE, OR INABILITY TO USE THIS PRODUCT).

No person, agent, distributor, dealer, or company is authorized to change, modify, or extend the terms of these warranties in any manner whatsoever. The time within which action must be commenced to enforce any obligation of TCL arising under this warranty or under any law of Canada or of any province thereof is hereby limited to 90 days from the date you discover, or should have discovered, the defect. This limitation does not apply to implied warranties arising under the law of any province of Canada.

THIS WARRANTY GIVES YOU SPECIFIC LEGAL RIGHTS, AND YOU MAY ALSO HAVE OTHER RIGHTS, WHICH MAY VARY FROM PROVINCE TO PROVINCE IN CANADA. SOME PROVINCES OF CANADA DO NOT ALLOW LIMITATIONS ON THE DURATION OF AN IMPLIED WARRANTY, LIMITATIONS ON THE TIME WITHIN WHICH AN ACTION MAY BE BROUGHT, OR THE EXCLUSION OR LIMITATION OF INCIDENTAL OR CONSEQUENTIAL DAMAGES; THEREFORE, THE ABOVE LIMITATIONS OR EXCLUSIONS MAY NOT APPLY TO YOU UNDER SUCH CIRCUMSTANCES.

Chapter 9: Appendix

A copy of the GPL source code in this product may be obtained by contacting Toshiba Consumer Solutions at (800)631-3811. There will be a charge to cover the costs of providing the source code.

A copy of the LGPL source code in this product may be obtained by contacting Toshiba Consumer Solutions at (800)631-3811. There will be a charge to cover the costs of providing the source code.

USB Protocol Copyright © 2005 The NetBSD Foundation, Inc. All rights reserved.

Redistribution and use in source and binary forms, with or without modification, are permitted provided that the following conditions are met:

- (1) Redistributions of source code must retain the above copyright notice, this list of conditions and the following disclaimer.
- (2) Redistributions in binary form must reproduce the above copyright notice, this list of conditions and the following disclaimer in the documentation and/or other materials provided with the distribution.
- (3) Neither the name of The NetBSD Foundation nor the names of its contributors may be used to endorse or promote products derived from this software without specified prior written permission.

THIS SOFTWARE IS PROVIDED BY THE NETBSD FOUNDATION, INC. AND CONTRIBUTORS "AS IS" AND ANY EXPRESS OR IMPLIED WARRANTIES, INCLUDING, BUT NOT LIMITED TO, THE IMPLIED WARRANTIES OF MERCHANTABILITY AND FITNESS FOR A PARTICULAR PURPOSE ARE DISCLAIMED. IN NO EVENT SHALL THE FOUNDATION OR CONTRIBUTORS BE LIABLE FOR ANY DIRECT, INDIRECT, INCIDENTAL, SPECIAL, EXEMPLARY, OR CONSEQUENTIAL DAMAGES (INCLUDING, BUT NOT LIMITED TO, PROCUREMENT OF SUBSTITUTE GOODS OR SERVICES; LOSS OF USE, DATA, OR PROFITS; OR BUSINESS INTERRUPTION) HOWEVER CAUSED AND ON ANY THEORY OF LIABILITY, WHETHER IN CONTRACT, STRICT LIABILITY, OR TORT (INCLUDING NEGLIGENCE OR OTHERWISE) ARISING IN ANY WAY OUT OF THE USE OF THIS SOFTWARE, EVEN IF ADVISED OF THE POSSIBILITY OF SUCH DAMAGE.

This product includes software developed by the OpenSSL Project for use in the OpenSSL Toolkit (<http://www.openssl.org>).

This product includes cryptographic software written by Eric Young (ey@cryptsoft.com).

OpenSSL 0.9.7d Copyright © 1998-2000 the OpenSSL Project. All Rights reserved. Redistribution and use in source and binary forms, with or without modification, are permitted provided that the following conditions are met:

- (1) Redistributions of source code must retain the above copyright notice, this list of conditions and the following disclaimer.
- (2) Redistributions in binary form must reproduce the above copyright notice, this list of conditions and the following disclaimer in the documentation and/or other materials provided with the distribution.
- (3) All advertising materials mentioning features or use of this software must display the following acknowledgement: This product includes software developed by the OpenSSL Project for use in the OpenSSL Toolkit (<http://openssl.org>).
- (4) The names "OpenSSL Toolkit" and "Open SSL Project" must not be used to endorse or promote products derived from this software without prior written permission. For written permission, please contact openssl-core@openssl.org.
- (5) Products derived from this software may not be called "OpenSSL" nor may "Open SSL" appear in their names without prior written permission of the OpenSSL Project.
- (6) Redistributions of any form whatsoever must retain the following acknowledgement: "This product includes software developed by the OpenSSL Project for use in the OpenSSL Toolkit (<http://www.openssl.org>)."

THIS SOFTWARE IS PROVIDED BY THE OpenSSL PROJECT "AS IS" AND ANY EXPRESSED OR IMPLIED WARRANTIES, INCLUDING, BUT NOT LIMITED TO, THE IMPLIED WARRANTIES OF MERCHANTABILITY AND FITNESS FOR A PARTICULAR PURPOSE ARE DISCLAIMED. IN NO EVENT SHALL THE OpenSSL PROJECT OR CONTRIBUTORS BE LIABLE FOR ANY DIRECT, INDIRECT, INCIDENTAL, SPECIAL, EXEMPLARY, OR CONSEQUENTIAL DAMAGES (INCLUDING, BUT NOT LIMITED TO, PROCUREMENT OF SUBSTITUTE GOODS OR SERVICES; LOSS OF USE, DATA, OR PROFITS; OR BUSINESS INTERRUPTION) HOWEVER CAUSED AND ON ANY THEORY OF LIABILITY, WHETHER IN CONTRACT, STRICT LIABILITY, OR TORT (INCLUDING NEGLIGENCE OR OTHERWISE) ARISING IN ANY WAY OUT OF THE USE OF THIS SOFTWARE, EVEN IF ADVISED OF THE POSSIBILITY OF SUCH DAMAGE. This product includes cryptographic software written by Eric Young (ey@cryptsoft.com). This product includes software written by Tim Hudson (tjh@cryptsoft.com).

Copyright © 1995-1998 Eric Young (ey@cryptsoft.com). All Rights reserved. This package is an SSL implementation written by Eric Young (ey@cryptsoft.com). The implementation was written so as to conform with Netscapes SSL. This library is free for commercial and non-commercial use so long as the following conditions are adhered to. The following conditions apply to all code found in this distribution, be it the RC4, RSA, lhash, DES, etc., code; not just the SSL code. The SSL documentation included with this distribution is covered by the same copyright terms except that the holder is Tim Hudson (tjh@cryptsoft.com). Copyright remains Eric Young's, and as such any Copyright notices in the code are not to be removed. If this package is used in a product, Eric Young should be given attribution as the author of the parts of the library used. This can be in the form of a textual message at program startup or in documentation (online or textual) provided with the package.

Redistribution and use in source and binary forms, with or without modification, are permitted provided that the following conditions are met:

- (1) Redistributions of source code must retain the copyright notice, this list of conditions and the following disclaimer.
- (2) Redistributions in binary form must reproduce the above copyright notice, this list of conditions and the following disclaimer in the documentation and/or other materials provided with the distribution.
- (3) All advertising materials mentioning features or use of this software must display the following acknowledgement: "This product includes cryptographic software written by Eric Young (ey@cryptsoft.com)." The word 'cryptographic' can be left out if the routines from the library being used are not cryptographic related.
- (4) If you include any Windows specific code (or derivative thereof) from the apps directory (application code) you must include an acknowledgement: "This product includes software written by Tim Hudson (tjh@cryptsoft.com)."

THIS SOFTWARE IS PROVIDED BY ERIC YOUNG "AS IS" AND ANY EXPRESS OR IMPLIED WARRANTIES, INCLUDING, BUT NOT LIMITED TO, THE IMPLIED WARRANTIES OF MERCHANTABILITY AND FITNESS FOR A PARTICULAR PURPOSE ARE DISCLAIMED. IN NO EVENT SHALL THE AUTHOR OR CONTRIBUTORS BE LIABLE FOR ANY DIRECT, INDIRECT, INCIDENTAL, SPECIAL, EXEMPLARY, OR CONSEQUENTIAL DAMAGES (INCLUDING, BUT NOT LIMITED TO, PROCUREMENT OF SUBSTITUTE GOODS OR SERVICES; LOSS OF USE, DATA, OR PROFITS; OR BUSINESS INTERRUPTION) HOWEVER CAUSED AND ON ANY THEORY OF LIABILITY, WHETHER IN CONTRACT, STRICT LIABILITY, OR TORT (INCLUDING NEGLIGENCE OR OTHERWISE) ARISING IN ANY WAY OUT OF THE USE OF THIS SOFTWARE, EVEN IF ADVISED OF THE POSSIBILITY OF SUCH DAMAGE. The license and distribution terms for any publicly available version or derivative of this code cannot be changed, i.e. this code cannot simply be copied and put under another distribution license (including the GNU Public License).

Index

A

Account..... 68
 Antenna input configuration 25
 Audio player 67
 Audio quality adjustments 45
 Auto aspect 39
 Auto power off 53

B

Back of the TV..... 9
 Blocking channels 49

C

C (CLOSED). CAPTION button..... 44
 CableCARD™ 29
 CableClear® 54
 CH RTN button..... 36
 CH ^ v buttons 35
 Channel Browser Setup 34
 Channel Browser™ 33
 Channel Browser™ banner..... 34
 Channel Number buttons 35
 Channel programming
 Automatic programming 26
 Manually adding and deleting... 27
 Cinema mode..... 39
 Closed captions..... 43
 Color Management..... 56
 Color temperature 55
 ColorStream HD audio..... 28

D

Defaults, reset TV factory 31
 Device button LED 16
 Device codes table 18
 Digital audio selector 44
 Digital signal meter..... 30
 Dolby Virtual/SRS TruSurround..... 58
 Double-window POP feature 40
 Dynamic contrast..... 54

E

E-mail account setup 68
 E-mail recording 59
 E-mail scheduling 68

F

Features, TV 6
 FREEZE 41
 Front of the TV 8

G

Game Mode feature..... 57
 GameTimer™ 50

H

HDMI audio mode 29
 Home file server setup 63

I

ID 71
 INPUT button..... 32
 Internet service provider..... 59

J

JPEG 64

L

Labeling video input 32
 Lamp mode 55
 Lamp unit replacement..... 81
 Language selection..... 25
 Last mode memory feature 53
 LED indications..... 80
 LOCKS menu
 Channels, blocking..... 49
 Enable rating blocking 48
 New PIN code..... 47
 Panel lock..... 51
 Unlocking programs temporarily 50
 Video inputs, locking 50
 Locks menu 47

M

Menu system 22
 MODE SELECT 12, 16
 MP3 65, 67
 MPEG noise reduction 55
 MTS feature 45
 MUTE button 44

N

Network address, setup 59

O

On/Off timer..... 52
 Optical audio output format 46

P

Password 71
 PC setting 52
 Picture adjustment 42
 Picture mode 42
 Picture quality 42
 Picture scroll..... 38
 Picture size selection 37
 Picture Viewer 64, 65
 POP button..... 40
 POWER button 8

Q

Quick Restart™ 30

R

RECALL button..... 53
 Remote control
 Battery installation 11
 Effective range 11
 Learning about the buttons 12
 Operational feature..... 17
 Volume lock feature..... 17

S

SAP sound 45
 Scroll settings 38
 Selecting Menu Language 25
 Setting up file sharing..... 61
 Side panel control 8
 Sleep timer 51
 Slide show 66
 Speaker On/Off..... 46
 Specifications 84
 StableSound® 46
 Stereo sound 45
 SurfLock™ 36
 System status 31

T

TheaterWide® picture size 37
 THINC button..... 12
 THINC™ system 10
 Time and date setting..... 28
 Troubleshooting 76
 TV GUIDE button 12

V

V-Chip blocking (Locks menu) 47
 Vertical Edge Enhancer..... 56
 Video input label 32
 Video input lock 50

W

Warranty
 Canada..... 86
 U.S. 85
 WOW:SRS 3D 58
 WOW:SRS Focus 58
 WOW:SRS TruBass 58

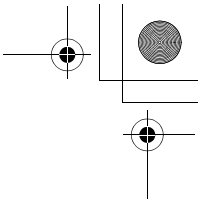
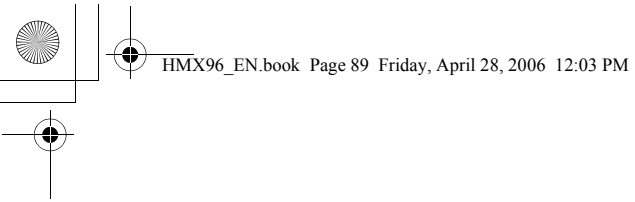

Notes

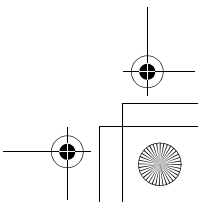
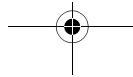
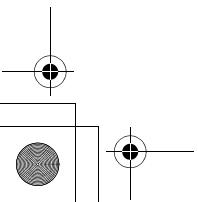
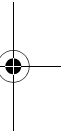
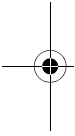

TOSHIBA AMERICA CONSUMER PRODUCTS, L.L.C.

Corporate Headquarters: 82 TOTOWA ROAD, WAYNE, NJ 07470, U.S.A.
NATIONAL SERVICE DIVISION: 1420-B TOSHIBA DRIVE, LEBANON, TN 37087, U.S.A.

TOSHIBA OF CANADA LTD.

HEAD OFFICE: 191 McNABB STREET, MARKHAM, ONTARIO, L3R 8H2, CANADA – TEL: (905) 470-5400
SERVICE CENTERS:
TORONTO: 191 McNABB STREET, MARKHAM, ONTARIO L3R 8H2, CANADA – TEL: (905) 470-5400
MONTREAL: 18050 TRANS CANADA, KIRKLAND, QUEBEC, H9J 4A1, CANADA – TEL: (514) 390-7766
VANCOUVER: 13551 COMMERCE PARKWAY, SUITE 110, RICHMOND, B.C., V6V 2L1, CANADA – TEL: (604) 303-2500

MANUFACTURED BY
TOSHIBA AMERICA CONSUMER PRODUCTS, L.L.C.

CableClear, ColorStream, StableSound, and TheaterWide are registered trademarks of Toshiba America Consumer Products, L.L.C.
Channel Browser, SurfLock, THINC, and Quick Restart are trademarks of Toshiba America Consumer Products, L.L.C.
Digital Light Processing™, DLP™ and the DLP™ medallion are trademarks of Texas Instruments.

PRINTED IN USA
(06-05)

TOSHIBA

Free Manuals Download Website

<http://myh66.com>

<http://usermanuals.us>

<http://www.somanuals.com>

<http://www.4manuals.cc>

<http://www.manual-lib.com>

<http://www.404manual.com>

<http://www.luxmanual.com>

<http://aubethermostatmanual.com>

Golf course search by state

<http://golfingnear.com>

Email search by domain

<http://emailbydomain.com>

Auto manuals search

<http://auto.somanuals.com>

TV manuals search

<http://tv.somanuals.com>